



User Manual

MIOe-DB2100

Evaluation Board for MIO-3260

ADVANTECH

Enabling an Intelligent Planet

Copyright

The documentation and the software included with this product are copyrighted 2015 by Advantech Co., Ltd. All rights are reserved. Advantech Co., Ltd. reserves the right to make improvements in the products described in this manual at any time without notice. No part of this manual may be reproduced, copied, translated or transmitted in any form or by any means without the prior written permission of Advantech Co., Ltd. Information provided in this manual is intended to be accurate and reliable. However, Advantech Co., Ltd. assumes no responsibility for its use, nor for any infringements of the rights of third parties, which may result from its use.

Acknowledgements

Intel® is a trademark of Intel® Technologies, Inc.

IBM, PC/AT, PS/2 and VGA are trademarks of International Business Machines Corporation.

Microsoft Windows® is a registered trademark of Microsoft Corp.

All other product names or trademarks are properties of their respective owners.

For more information on this and other Advantech products, please visit our websites at:

<http://www.advantech.com>

<http://www.advantech.com/eplatform>

For technical support and service, please visit our support website at:

<http://support.advantech.com/>

Product Warranty (2 years)

Advantech warrants to you, the original purchaser, that each of its products will be free from defects in materials and workmanship for two years from the date of purchase.

This warranty does not apply to any products which have been repaired or altered by persons other than repair personnel authorized by Advantech, or which have been subject to misuse, abuse, accident or improper installation. Advantech assumes no liability under the terms of this warranty as a consequence of such events.

Because of Advantech's high quality-control standards and rigorous testing, most of our customers never need to use our repair service. If an Advantech product is defective, it will be repaired or replaced at no charge during the warranty period. For out-of-warranty repairs, you will be billed according to the cost of replacement materials, service time and freight. Please consult your dealer for more details.

If you think you have a defective product, follow these steps:

1. Collect all the information about the problem encountered. (For example, CPU speed, Advantech products used, other hardware and software used, etc.) Note anything abnormal and list any onscreen messages you get when the problem occurs.
2. Call your dealer and describe the problem. Please have your manual, product, and any helpful information readily available.
3. If your product is diagnosed as defective, obtain an RMA (return merchandise authorization) number from your dealer. This allows us to process your return more quickly.
4. Carefully pack the defective product, a fully-completed Repair and Replacement Order Card and a photocopy proof of purchase date (such as your sales receipt) in a shippable container. A product returned without proof of the purchase date is not eligible for warranty service.
5. Write the RMA number visibly on the outside of the package and ship it prepaid to your dealer.

Declaration of Conformity

CE

This product has passed the CE test for environmental specifications. Test conditions for passing included the equipment being operated within an industrial enclosure. In order to protect the product from being damaged by ESD (Electrostatic Discharge) and EMI leakage, we strongly recommend the use of CE-compliant industrial enclosure products.

FCC Class A

This equipment has been tested and found to comply with the limits for a Class A digital device, pursuant to Part 15 of the FCC Rules. These limits are designed to provide reasonable protection against harmful interference when the equipment is operated in a commercial environment. This equipment generates, uses, and can radiate radio frequency energy and, if not installed and used in accordance with the instruction manual, may cause harmful interference to radio communications. Operation of this device in a residential area is likely to cause harmful interference in which case the user will be required to correct the interference at his/her own expense. The user is advised that any equipment changes or modifications not expressly approved by the party responsible for compliance would void the compliance to FCC regulations and therefore, the user's authority to operate the equipment.

Caution! *There is a danger of a new battery exploding if it is incorrectly installed. Do not attempt to recharge, force open, or heat the battery. Replace the battery only with the same or equivalent type recommended by the manufacturer. Discard used batteries according to the manufacturer's instructions.*



Technical Support and Assistance

1. Visit the Advantech website at <http://support.advantech.com> where you can find the latest information about the product.
2. Contact your distributor, sales representative, or Advantech's customer service center for technical support if you need additional assistance. Please have the following information ready before you call:
 - Product name and serial number
 - Description of your peripheral attachments
 - Description of your software (operating system, version, application software, etc.)
 - A complete description of the problem
 - The exact wording of any and all error messages

Packing List

Before you begin installing your card, please make sure that the following materials have been shipped:

- 1 MIOe-DB2100 development board

If any of these items is missing or damaged, contact your distributor or sales representative immediately.

Ordering Information

Part No.	DP/ HDMI	VGA	GbE	PCIe x1	RS- 232/ 422/ 485	Full-size Mini PCIe	SIM holder	SATA II	LPC	SMBus	I2C	USB 2.0	USB 3.0	Audio	MIOe	Power Conn.
MIOe-DB2100-00A1E	1*	1	1	1	2	1	1	1	1	1	1	4	1	Yes	Yes	2x2 pin*

* HDMI and DC jack supported by request.

Optional Accessories

Part Number	Description
MIO-3260L-S3A1E	MIO-3260 E3825/64-pin SBC
MIO-3260L-S8A1E	MIO-3260 N2930/64-pin SBC
MIO-3260C-S8A1E	MIO-3260 N2930/Box Wafer SBC

Safety Instructions

1. Read these safety instructions carefully.
2. Keep this User Manual for later reference.
3. Disconnect this equipment from any AC outlet before cleaning. Use a damp cloth. Do not use liquid or spray detergents for cleaning.
4. For plug-in equipment, the power outlet socket must be located near the equipment and must be easily accessible.
5. Keep this equipment away from humidity.
6. Put this equipment on a reliable surface during installation. Dropping it or letting it fall may cause damage.
7. The openings on the enclosure are for air convection. Protect the equipment from overheating. **DO NOT COVER THE OPENINGS.**
8. Make sure the voltage of the power source is correct before connecting the equipment to the power outlet.
9. Position the power cord so that people cannot step on it. Do not place anything over the power cord.
10. All cautions and warnings on the equipment should be noted.
11. If the equipment is not used for a long time, disconnect it from the power source to avoid damage by transient overvoltage.
12. Never pour any liquid into an opening. This may cause fire or electrical shock.
13. Never open the equipment. For safety reasons, the equipment should be opened only by qualified service personnel.
14. If one of the following situations arises, get the equipment checked by service personnel:
 - The power cord or plug is damaged.
 - Liquid has penetrated into the equipment.
 - The equipment has been exposed to moisture.
 - The equipment does not work well, or you cannot get it to work according to the user's manual.
 - The equipment has been dropped and damaged.
 - The equipment has obvious signs of breakage.
15. **DO NOT LEAVE THIS EQUIPMENT IN AN ENVIRONMENT WHERE THE STORAGE TEMPERATURE MAY GO BELOW -20° C (-4° F) OR ABOVE 60° C (140° F). THIS COULD DAMAGE THE EQUIPMENT. THE EQUIPMENT SHOULD BE IN A CONTROLLED ENVIRONMENT.**
16. **CAUTION: DANGER OF EXPLOSION IF BATTERY IS INCORRECTLY REPLACED. REPLACE ONLY WITH THE SAME OR EQUIVALENT TYPE RECOMMENDED BY THE MANUFACTURER, DISCARD USED BATTERIES ACCORDING TO THE MANUFACTURER'S INSTRUCTIONS.**

The sound pressure level at the operator's position according to IEC 704-1:1982 is no more than 70 dB (A).

DISCLAIMER: This set of instructions is given according to IEC 704-1. Advantech disclaims all responsibility for the accuracy of any statements contained herein.

Contents

Chapter 1	General Information	1
1.1	Introduction	2
1.2	Specifications	2
	Table 1.1: Specifications	2
1.3	Block Diagram	3
	Figure 1.1 Block Diagram	3
1.4	Board Layout: Dimensions	3
	Figure 1.2 MIOe-DB2100 Mechanical Drawing (Top Side)	3
	Figure 1.3 MIOe-DB2100 Mechanical Drawing (Top Side, with optional DC Jack)	4
	Figure 1.4 MIOe-DB2100 Mechanical Drawing (Bottom Side)	4
	Figure 1.5 MIOe-DB2100 Mechanical Drawing (Bottom Side, with optional DC Jack)	5
	Figure 1.6 MIOe-DB2100 Mechanical Drawing (Front I/O)	5
	Figure 1.7 MIOe-DB2100 Mechanical Drawing (Front I/O, with optional DC Jack)	5
	Figure 1.8 MIOe-DB2100 Mechanical Drawing (Rear I/O)	6
	Figure 1.9 MIO-3260 + MIOe-DB2100 Height Dimension (With standard heatsink)	6
	Figure 1.10 MIO-3260 + MIOe-DB2100 Height Dimension (With optional heatspreader)	6
Chapter 2	Installation	7
2.1	Jumpers	8
	2.1.1 Jumper Description	8
	2.1.2 Jumper Table	8
	Table 2.1: Jumper Table	8
2.2	Connector Table	9
	Table 2.2: Connector Table	9
2.3	Jumper and Connector Locations	10
	Figure 2.1 Jumper and Connector layout (Top side)	10
	Figure 2.2 Jumper and Connector layout (Bottom side)	10
2.4	Jumper and Connector Pin Definition	11
2.5	Quick Installation Guide	31

Chapter 1

General Information

This chapter gives background information on the MIOe-DB2100.

Sections include:

- Introduction
- Specifications
- Block diagram
- Board layout and dimensions

1.1 Introduction

MIOe-DB2100 is an MIOe evaluation board for MIO-3260 SBC in standard EPIC form factor. It is compatible with MIOe; all circuit designs follow MI/O Extension design guide. MIOe-DB2100 units have complete and flexible interfaces for verification and various applications, including PCIe x1, DP or HDMI, mini PCIe with SIM, LPC, SMBus, I2C, 8-bit GPIO, inverter, 12 V_{DC} in, USB3.0, 4 USB2.0, HD audio line in/line out/mic in, SATA with power, power/HDD LED, power/reset button. MIOe-DB2100 expedites carrier board development, and saves customer design time and cost.

1.2 Specifications

Table 1.1: Specifications

Form Factor	EPIC	
Compatible Models	MIO-3260	
Display	VGA	1
	DP/HDMI	1 (HDMI supported by request)
Storage	SATA with Power	1 (connect to 2.5" HDD)
Rear I/O	Ethernet	1 x RJ45
	VGA	1
	DP/HDMI	1 (HDMI supported by request)
	USB	1 x USB3.0, 4 x USB2.0
	LED	Power, HDD
	Power Button	1
	Reset Button	1
	HD Audio	Line in, Line out, Mic in
	Serial	2 x RS-232/422/485 (ESD protection for RS-232: Air gap ±15 kV, Contact ± 8kV)
	Power Input	1 (default 2x2pin power connector, DC jack supported by request)
Internal I/O	I2C	1
	SMBus	1
	Inverter	1
	GPIO	8-bit general purpose input/output
	LPC	1
Expansion	PCIe x1 slot	1
	Mini PCI Express	1 (Full-size)
	SIM card Holder	1
	MIOe connector	1
	64pin Connector	2
Power	Independent Power voltage	Single +12 V DC in
Environment	Operation	0 ~ 60° C (32 ~ 140° F) (Operational humidity: 40° C @ 95% RH Non-Condensing)
	Non-Operational	-40 ~ 85° C and 40° C @ 95% RH Non-Condensing

Table 1.1: Specifications

Mechanical	Dimensions (L x W)	115 x 165 mm (4.5" x 6.5")
	Weight	0.26 kg (0.57 lb), weight of total package

1.3 Block Diagram

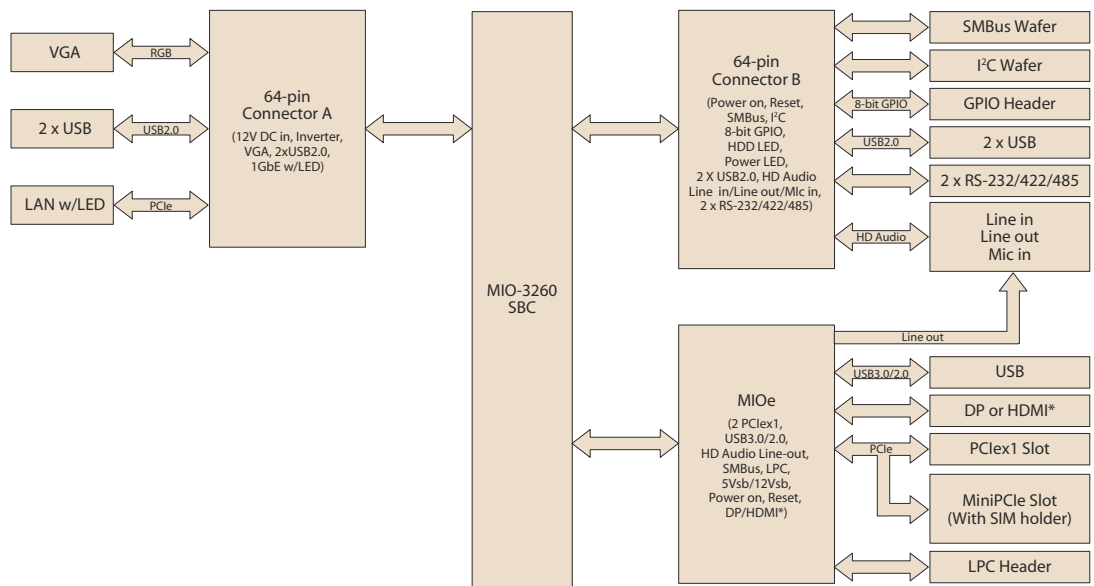

*Supported by request

Figure 1.1 Block Diagram

1.4 Board Layout: Dimensions

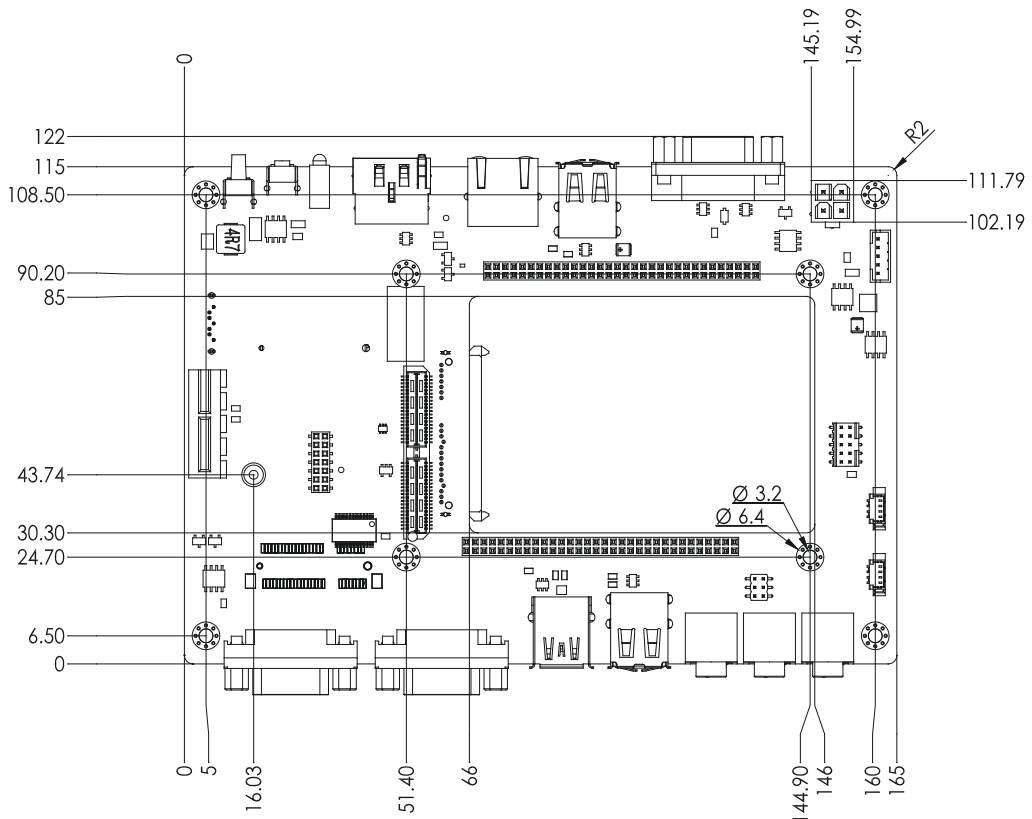

Figure 1.2 MIOe-DB2100 Mechanical Drawing (Top Side)

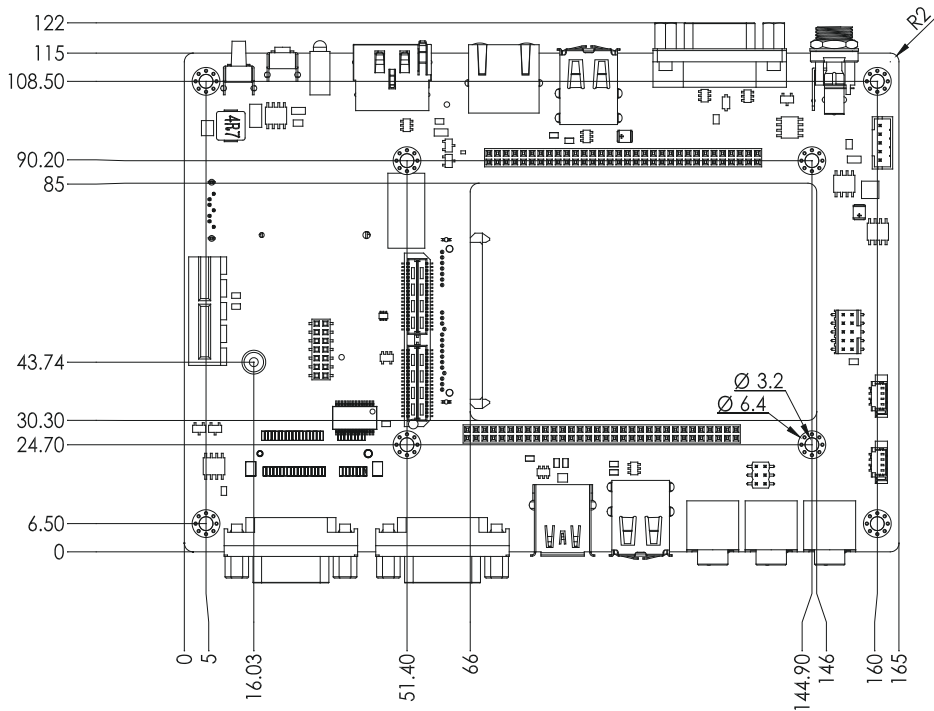

Figure 1.3 MIOe-DB2100 Mechanical Drawing (Top Side, with optional DC Jack)

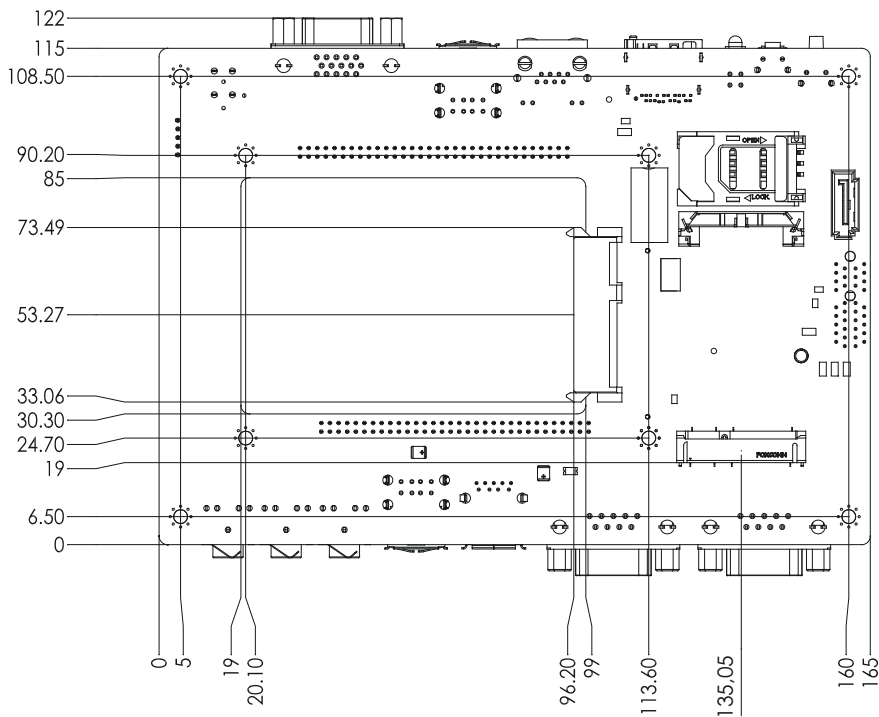

Figure 1.4 MIOe-DB2100 Mechanical Drawing (Bottom Side)

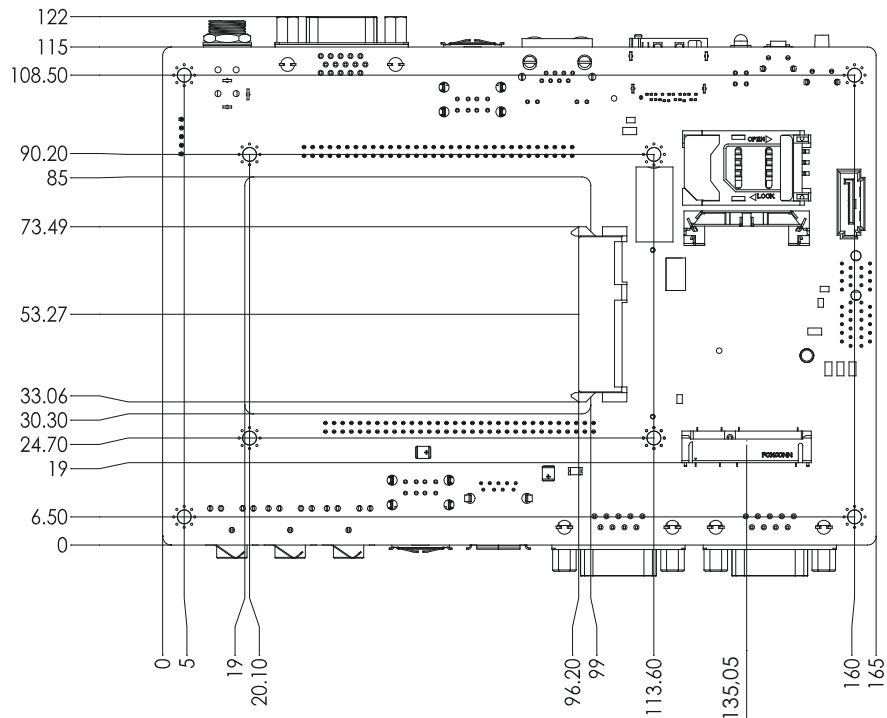

Figure 1.5 MIOe-DB2100 Mechanical Drawing (Bottom Side, with optional DC Jack)

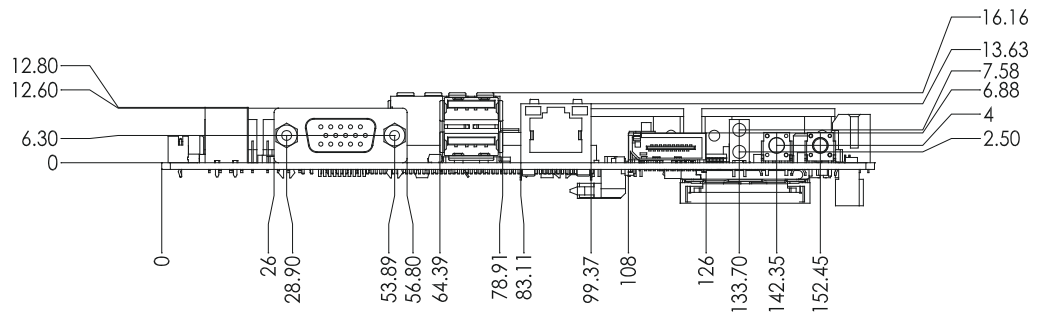

Figure 1.6 MIOe-DB2100 Mechanical Drawing (Front I/O)

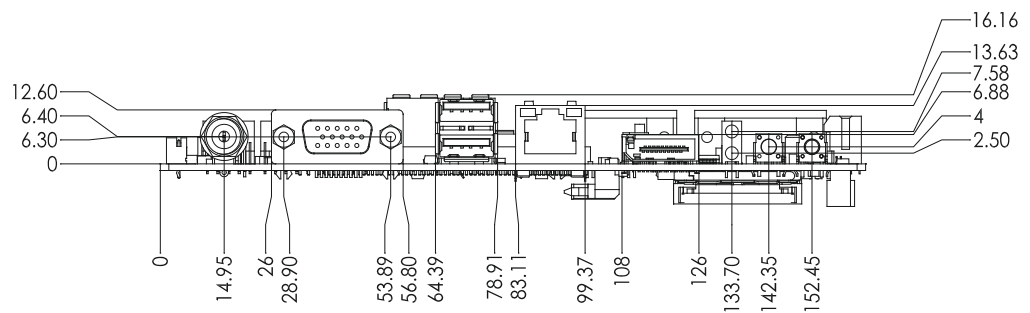

Figure 1.7 MIOe-DB2100 Mechanical Drawing (Front I/O, with optional DC Jack)

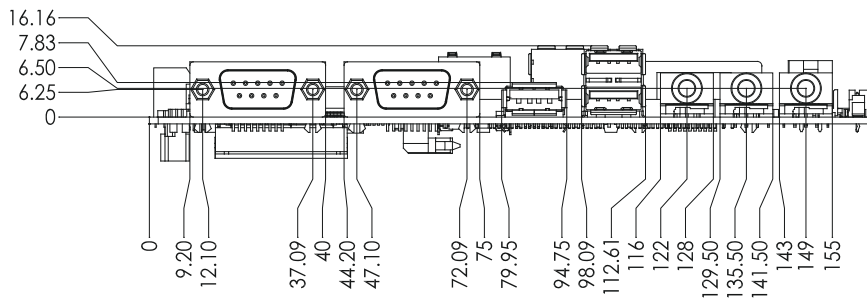

Figure 1.8 MIOe-DB2100 Mechanical Drawing (Rear I/O)

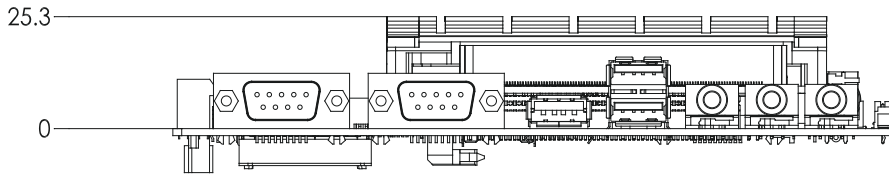

Figure 1.9 MIO-3260 + MIOe-DB2100 Height Dimension (With standard heatsink)

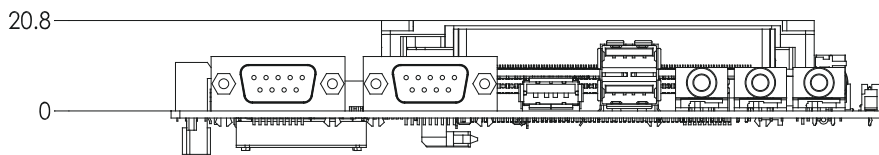

Figure 1.10 MIO-3260 + MIOe-DB2100 Height Dimension (With optional heatspreader)

Chapter 2

Installation

This chapter explains the setup procedures of the MIOe-DB2100 hardware, including instructions on setting jumpers, connecting peripherals and indicators.

Be sure to read all safety precautions before you begin the installation procedure.

2.1 Jumpers

2.1.1 Jumper Description

You may configure your card to match the needs of your application by setting jumpers. A jumper is a metal bridge used to close an electric circuit. It consists of two metal pins and a small metal clip (often protected by a plastic cover) that slides over the pins to connect them. To close a jumper, you connect the pins with the clip. To open a jumper, you remove the clip. Sometimes a jumper will have three pins, labeled 1, 2 and 3. In this case you would connect either pins 1 and 2, or 2 and 3.

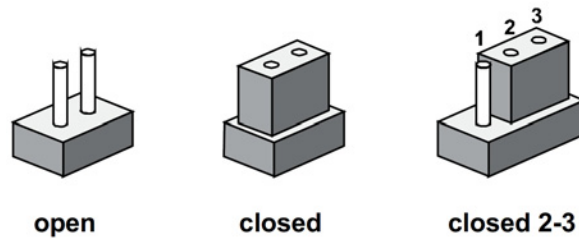

The jumper settings are schematically depicted in this manual as follows.

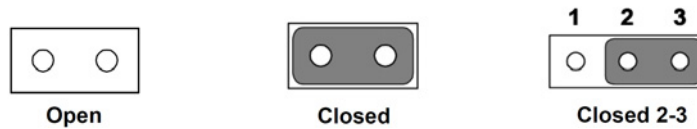

A pair of needle-nose pliers may be helpful when working with jumpers. If you have any doubts about the best hardware configuration for your application, contact your local distributor or sales representative before you make any changes.

Generally, you simply need a standard cable to make most connections.

Warning! To avoid damaging the computer, always turn off the power supply before setting jumpers.



2.1.2 Jumper Table

Table 2.1: Jumper Table

Jumper	Descriptions
J1	Audio Line Out Select

2.2 Connector Table

Table 2.2: Connector Table	
Connector	Description
CN1	MIOe
CN2	Internal 64-Pin Connector B
CN3	Internal 64-Pin Connector A
CN4	DP/HDMI (HDMI supported by request)
CN5	External USB3.0
CN6	External USB2.0
CN7	External USB2.0
CN8	Gigabit Ethernet
CN9	VGA
CN10	SATA Output
CN11	COM1
CN12	SATA Input
CN13	COM2
CN14	Mini PCIE
CN15	SIM Holder
CN16	PCIEx1 Slot
CN17	I ² C
CN18	SMBUS
CN19	HD Audio Line In
CN20	HD Audio Line Out
CN21	Inverter Power Output
CN22	LPC
CN23	GPIO
CN24	DC JACK (supported by request)
CN25	12 V Power Input (2 x 2 pin power connector)
CN26	HD Audio MIC in

2.3 Jumper and Connector Locations

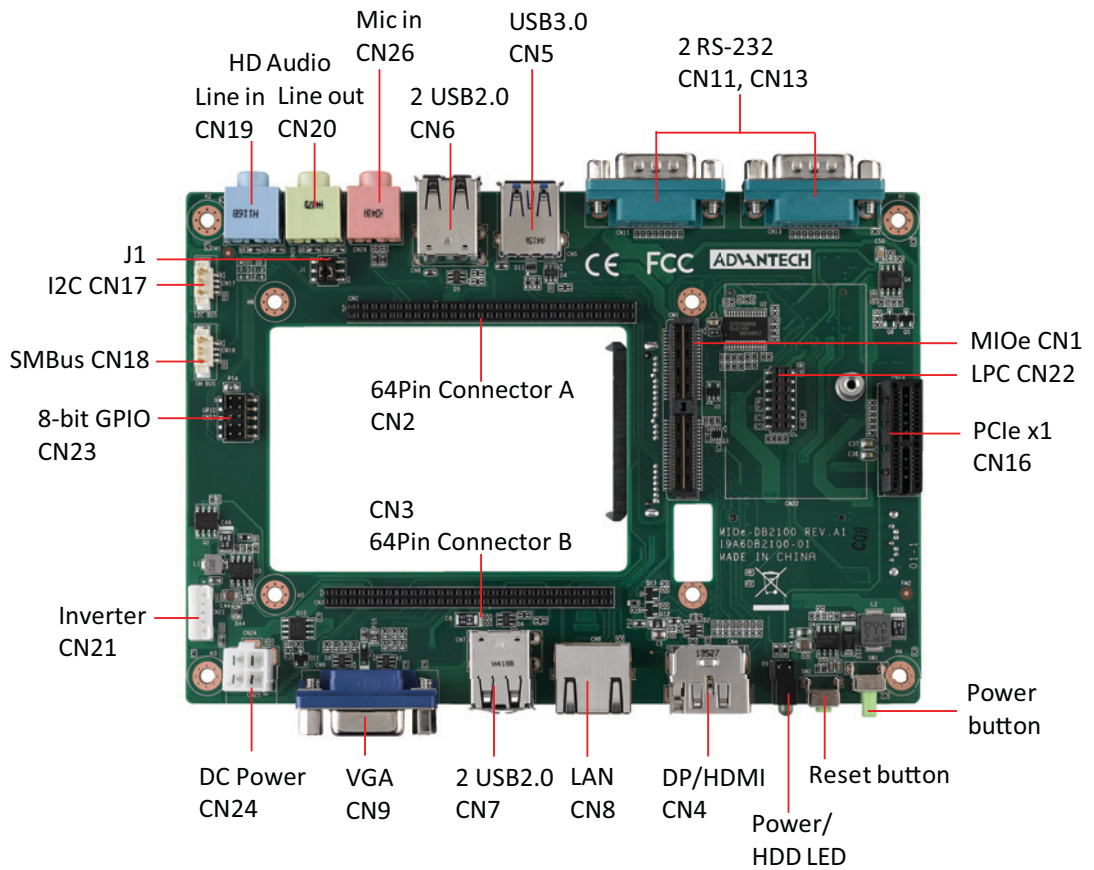

Figure 2.1 Jumper and Connector layout (Top side)

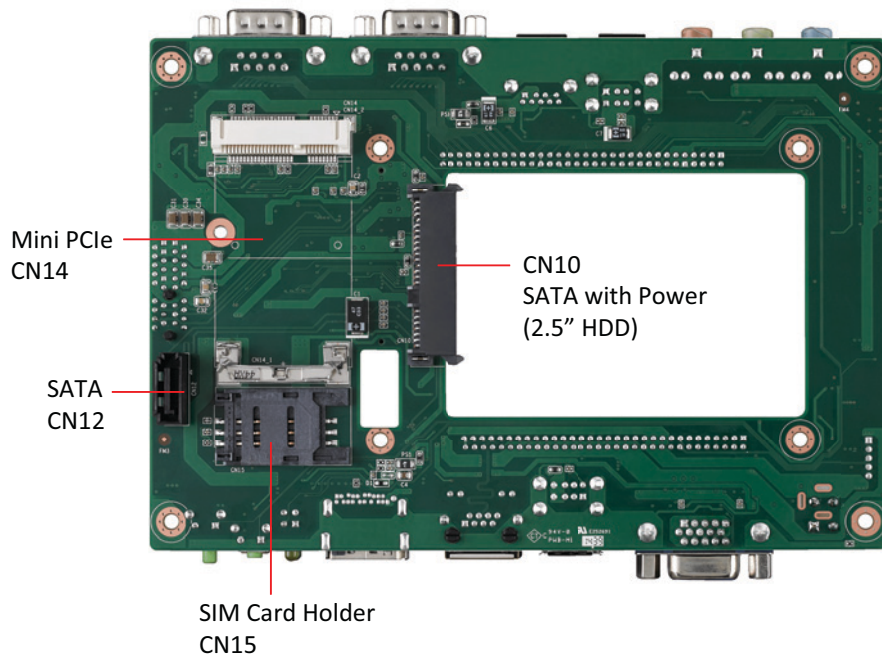
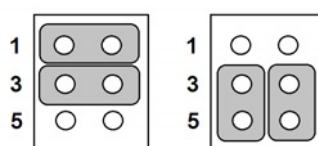

Figure 2.2 Jumper and Connector layout (Bottom side)

2.4 Jumper and Connector Pin Definition

J1	Audio Line Out select
Part Number	1653003260
Footprint	HD_3x2P_79
Description	PIN HEADER 3*2P 180D(M) 2.0mm SMD SQUARE PIN
Setting	Function
(1-2)(3-4)	Internal 64Pin connector
(3-5)(4-6)	MIOe

Default is (1-2)(3-4)-Internal 64Pin connector.



CN1	MIOe
Part Number	1654009899
Footprint	MIOE
Description	MIOE Module on I/O function Board
Pin	Pin Name
1	GND
2	GND
3	PCIE_RX0+
4	PCIE_TX0+
5	PCIE_RX0-
6	PCIE_TX0-
7	GND
8	GND
9	PCIE_RX1+
10	PCIE_TX1+
11	PCIE_RX1-
12	PCIE_TX1-
13	GND
14	GND
15	NC
16	NC
17	NC
18	NC
19	GND
20	GND
21	NC
22	NC
23	NC
24	NC

25	GND
26	GND
27	PCIE_CLK+
28	LOUTL
29	PCIE_CLK-
30	LOUTR
31	GND
32	AGND
33	SMB_CLK
34	NC
35	SMB_DAT
36	NC
37	PCIE_WAKE#
38	NC
39	RESET#
40	NC
41	SLP_S3#
42	CLK33M
43	NC
44	LPC_AD0
45	DDP_HPD
46	LPC_AD1
47	GND
48	LPC_AD2
49	DDP_AUX+
50	LPC_AD3
51	DDP_AUX-
52	LPC_DRQ#0
53	GND
54	LPC_SERIRQ
55	DDP_D0+
56	LPC_FRAME#
57	DDP_D0-
58	GND
59	GND
60	USB0_D+
61	DDP_D1+
62	USB0_D-
63	DDP_D1-
64	GND
65	GND
66	USB1_D+
67	DDP_D2+
68	USB1_D-
69	DDP_D2-
70	GND
71	GND
72	USB2_D+

73	DDP_D3+
74	USB2_D--
75	DDP_D3-
76	GND
77	GND
78	USB_OC#
79	+12 VSB
80	+12 VSB
83	GND
84	GND
85	GND
86	GND
87	+5 VSB
88	+5 VSB
89	+5 VSB
90	+5 VSB

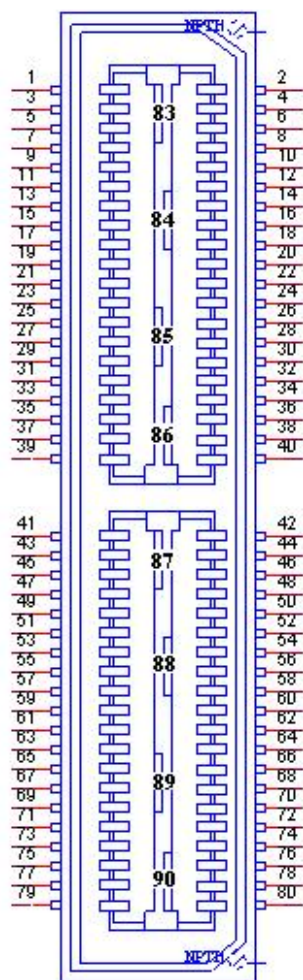

CN2	Internal 64Pin Connector B
Part Number	1653005340-01
Footprint	HD_32x2P_79_F_D
Description	PIN HEADER 32x2P 2.0mm 180D(F) DIP 22N8242-64S10
Pin	Pin Name
1	PSIN#
2	NC
3	NC
4	NC
5	Reset
6	NC
7	NC
8	HD LED
9	GND
10	+V5_SMB
11	SMB_DAT
12	SMB_CLK
13	I2C_DAT
14	I2C_CLK
15	+V5_GPIO
16	GPIO4
17	GPIO0
18	GPIO5
19	GPIO1
20	GPIO6
21	GPIO2
22	GPIO7
23	GPIO3
24	GND
25	+V5_USB34
26	+V5_USB34
27	USB4_P-
28	USB3_P-
29	USB4_P+
30	USB3_P+
31	GND
32	GND
33	NC
34	NC
35	LOUTR
36	LINR
37	GND_AUD
38	GND_AUD
39	LOUTL
40	LINL
41	GND_AUD
42	GND_AUD

43	MICR
44	MICL
45	COM0_DCD#
46	COM0_DSR#
47	COM0_RXD
48	COM0_RTS#
49	COM0_TXD
50	COM0_CTS#
51	COM0_DTR#
52	COM0_RI#
53	GND
54	GND
55	COM1_DCD#
56	COM1_DSR#
57	COM1_RXD
58	COM1_RTS#
59	COM1_TXD
60	COM1_CTS#
61	COM1_DTR#
62	COM1_RI#
63	GND
64	GND

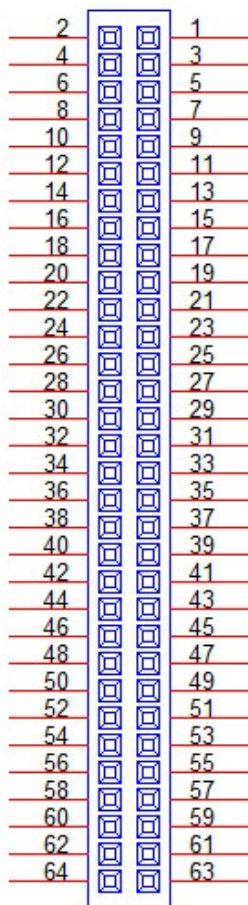

CN3	Internal 64Pin Connector A
Part Number	1653005340-01
Footprint	HD_32x2P_79_F_D
Description	PIN HEADER 32x2P 2.0mm 180D(F) DIP 22N8242-64S10
Pin	Pin Name
1	+V12_DC_IN
2	GND
3	+V12_DC_IN +
4	GND
5	+V12_DC_IN
6	GND
7	+V12_DC_IN
8	GND
9	GND
10	GND
11	GND
12	GND
13	NC
14	NC
15	LVDS0_ENABKL
16	LVDS0_VBR
17	NC
18	GND
19	GND
20	GND
21	GND
22	GND
23	VGA_DDAT
24	VGA_DCLK
25	GND
26	GND
27	VGA_R
28	VGA_G
29	VGA_B
30	GND
31	GND
32	+V5_VGA
33	VGA_HS
34	VGA_VS
35	GND
36	GND
37	GND
38	GND
39	+V5_USB01
40	+V5_USB01
41	USB0_z_P-
42	USB1_z_P-

43	USB0_z_P+
44	USB1_z_P+
45	NC
46	NC
47	NC
48	NC
49	GND
50	GND
51	LINK100#_LED
52	LINK1000#_LED
53	NC
54	ACT#_LED
55	LAN0_M0+
56	LAN0_M0-
57	LAN1_M0+
58	LAN1_M0-
59	LAN2_M0+
60	LAN2_M0-
61	LAN3_M0+
62	LAN3_M0-
63	GNDT1
64	GNDT1

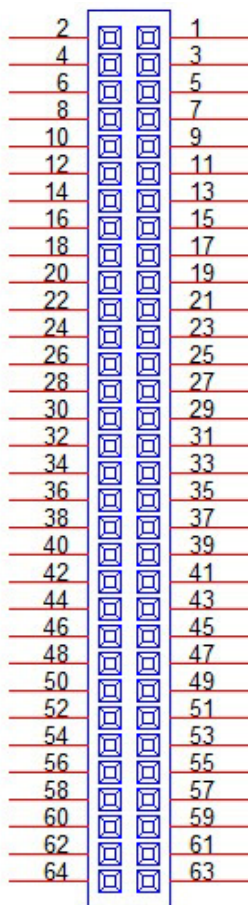

CN4	DP/HDMI (HDMI supported by request)
Part Number	1654010203
Footprint	HDMICON_21P_845-002-217CRL
Description	HDMI+DISPLAY Conn. 20P 90D(M) SMD 845-002-217CRL
Pin	Pin Name
1	ML_Lane0(p)/TMDS Data2+
2	GND/TMDS Data2 Shield
3	ML_Lane0(n)/TMDS Data2-
4	ML_Lane1(p)/TMDS Data1+
5	GND/TMDS Data1 Shield
6	ML_Lane1(n)/TMDS Data1-
7	ML_Lane2(p)/TMDS Data0+
8	GND/TMDS Data0 Shield
9	ML_Lane2(n)/TMDS Data0-
10	ML_Lane3(p)/TMDS Clock+
11	GND/TMDS Clock Shield
12	ML_Lane3(n)/TMDS Clock-
13	CONFIG1/Reserved
14	CONFIG2/Reserved
15	AUX CH(p)/SCL
16	GND/SDA
17	AUX CH(n)/DDC Ground
18	Hot Plug Detect/+5 V Power
19	GND/Hot Plug Detect
20	+3.3 V

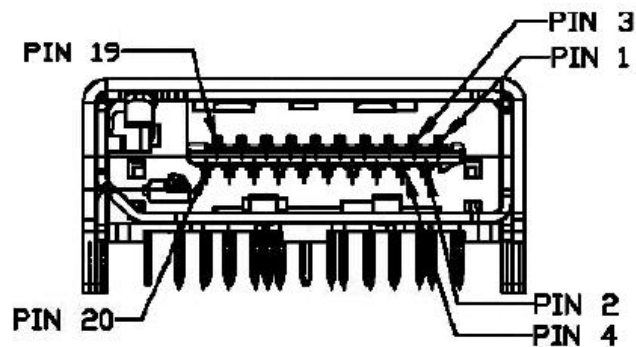

CN5	External USB3.0
Part Number	1654009746
Footprint	USB_9P_UEA1112C-4HK1-4H
Description	USB CONN. 9P 2.0mm 90D(F) DIP UEA1112C-4HK1-4H
Pin	Pin Name
1	+5V
2	D-
3	D+
4	GND
5	SSRX-
6	SSRX+
7	GND
8	SSTX-
9	SSTX+

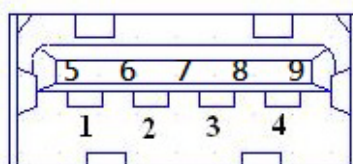

CN6	External USB2.0
Part Number	1654009513
Footprint	USB_8P_UB1112C-8FDE-4F
Description	USB CONN. 8P 2.0mm 90D DIP UB1112C-8FDE-4F
Pin	Pin Name
1	+5V
2	D-
3	D+
4	GND
5	+5V
6	D-
7	D+
8	GND

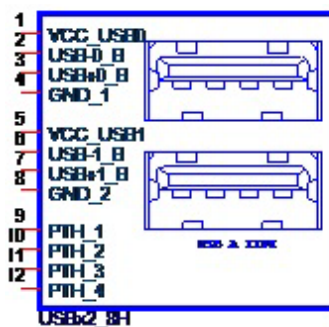

CN7	External USB2.0
Part Number	1654009513
Footprint	USB_8P_UB1112C-8FDE-4F
Description	USB CONN. 8P 2.0mm 90D DIP UB1112C-8FDE-4F
Pin	Pin Name
1	+5V
2	D-
3	D+
4	GND
5	+5V
6	D-
7	D+
8	GND

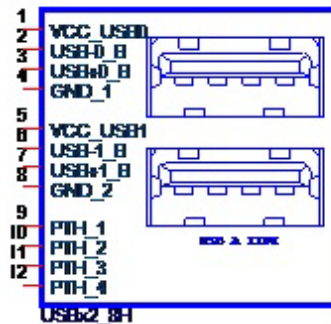

CN8	Gigabit Ethernet
Part Number	1652000279
Footprint	RJ45_12P_RJ1401
Description	PHONE JACK RJ45 14P DIP RJ1401-88UE50R500
Pin	Pin Name
1	BI_DA+(GHz)
2	BI_DA-(GHz)
3	BI_DB+(GHz)
4	BI_DC+(GHz)
5	BI_DC-(GHz)
6	BI_DB-(GHz)
7	BI_DD+(GHz)
8	BI_DD-(GHz)
H3	GND
H4	GND

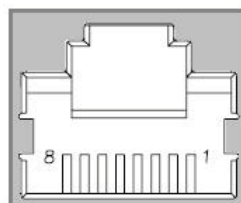

CN9		VGA	
Part Number	1654515304		
Footprint	SUYIN_070207FR015S221CA		
Description	D-SUB CONN. 15P 90D(F) DIP 5mm BLUE W/O Pb		
Pin	Pin Name		
1	RED		
2	GREEN		
3	BLUE		
4	NC		
5	GND		
6	GND		
7	GND		
8	GND		
9	+V5_VGA		
10	GND		
11	NC		
12	DDAT		
13	HSYNC		
14	VSYNC		
15	DCLK		

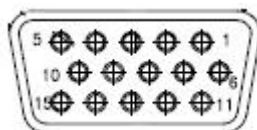

CN10		SATA Ouput	
Part Number	1654010207		
Footprint	SATA_22P_WATB-22DL1P5U		
Description	Serial ATA 22P 1.27mm 90D(F) DIP WATB-22DL1P5U		
Pin	Pin Name		
S1	GND		
S2	TX+		
S3	TX-		
S4	GND		
S5	RX-		
S6	RX+		
S7	GND		
P1	+V3.3		
P2	+V3.3		
P3	+V3.3		
P4	GND		
P5	GND		
P6	GND		
P7	+V5		
P8	+V5		

P9	+V5
P10	GND
P11	NC
P12	GND
P13	+V12
P14	+V12
P15	+V12

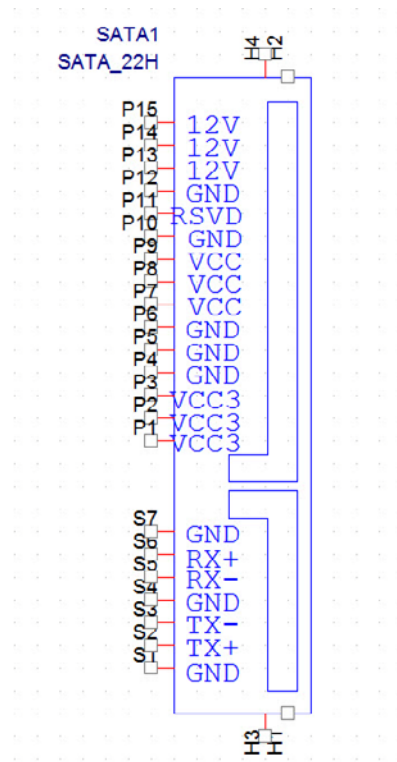

CN11	COM1
Part Number	1654011267-01
Footprint	DB_9P_DSB5-09M1-GNR0-5G
Description	D-sub 9P 2.775mm 90D(M) DIP DSB5-09M1-GNR0-4G
Pin	Pin Name
1	DCD#
2	RXD
3	TXD
4	DTR#
5	GND
6	DSR#
7	RTS#
8	CTS#
9	RI#

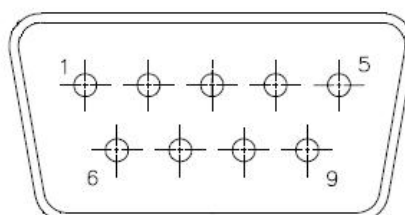

CN12	SATA input
Part Number	1654004659
Footprint	SATA_7P_WATM-07DBN4A3B8UW_D
Description	Serial ATA 7P 1.27mm 180D(M) DIP WATM-07DBN4A3B8
Pin	Pin Name
1	GND
2	TX+
3	TX-
4	GND
5	RX-
6	RX+
7	GND

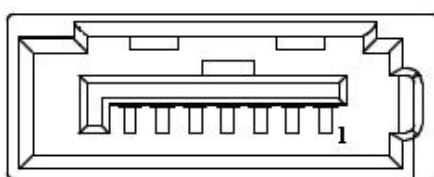

CN13	COM2
Part Number	1654011267-01
Footprint	DB_9P_DSB5-09M1-GNR0-5G
Description	D-sub 9P 2.775mm 90D(M) DIP DSB5-09M1-GNR0-4G
Pin	Pin Name
1	DCD#
2	RXD
3	TXD
4	DTR#
5	GND
6	DSR#
7	RTS#
8	CTS#
9	RI#

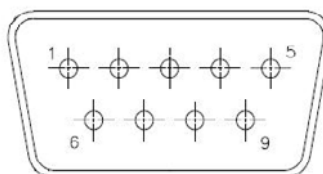

CN14	Mini PCIE
Part Number	1654002538
Footprint	FOX_AS0B226-S68K7F
Description	MINI PCI express 52P 90D SMD H=6.8mm
Pin	Pin Name
1	WAKE#
2	+3.3 VSB
3	NC

4	GND
5	NC
6	+1.5 V
7	NC
8	NC
9	GND
10	NC
11	REFCLK-
12	NC
13	REFCLK+
14	NC
15	GND
16	NC
17	NC
18	GND
19	NC
20	NC
21	GND
22	PERST#
23	PERn0
24	+3.3 VSB
25	PERp0
26	GND
27	GND
28	+1.5 V
29	GND
30	SMB_CLK
31	PETn0
32	SMB_DAT
33	PETp0
34	GND
35	GND
36	USB D-
37	GND
38	USB D+
39	+3.3 VSB
40	GND
41	+3.3 VSB
42	NC
43	GND
44	NC
45	NC
46	NC
47	NC
48	+1.5V
49	NC
50	GND
51	NC

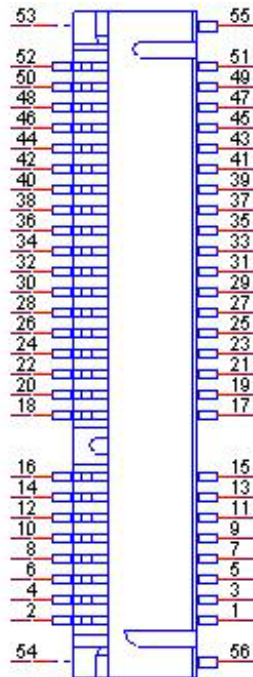

CN15	SIM Holder
Part Number	1654010809-01
Footprint	SIM_6P_5210622-SINR03
Description	SIM card conn. 6p 2.54mm 90D(F) SMD 5210622-SINR
Pin	Pin Name
1	UIM_PWR
2	UIM_RESET
3	UIM_CLK
4	GND
5	UIM_VPP
6	UIM_DATA

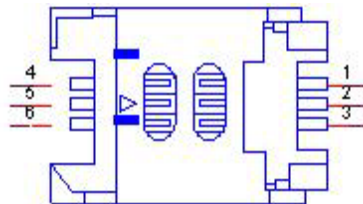

CN16	PCIEx1 Slot
Part Number	1654011366-01
Footprint	PCIE_36P_AAA-PCI-003-K02
Description	PCIEXPRESS 36P 1.0mm 180D(F) DIP 15u" AAA-PCI-15
Pin	Pin Name
A1	NC
A2	+12 V
A3	+12 V
A4	GND

A5	JTAG2
A6	JTAG3
A7	NC
A8	JTAG5
A9	+3.3 V
A10	+3.3 V
A11	PWRGD
A12	GND
A13	REFCLK+
A14	REFCLK-
A15	GND
A16	HSIP0
A17	HSIN0
A18	GND
B1	+12 V
B2	+12 V
B3	+12 V
B4	GND
B5	SMB_CLK
B6	SMB_DAT
B7	GND
B8	+3.3 V
B9	JTAG1
B10	+3.3 VSB
B11	PCIE_WAKE#
B12	NC
B13	GND
B14	HSOP0
B15	HSOP0
B16	GND
B17	NC
B18	GND

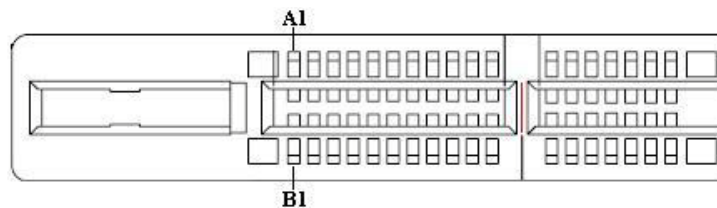

CN17	I2C BUS
Part Number	1655904020
Footprint	FPC4V-125M
Description	Wafer SMT 1.25mmS/T type 4P 180D(M) 85205-04001
Pin	Pin Name
1	GND
2	I2C DATA
3	I2C CLK
4	+5 V

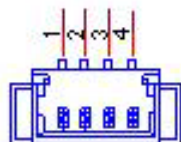

CN18	SM BUS
Part Number	1655904020
Footprint	FPC4V-125M
Description	Wafer SMT 1.25mmS/T type 4P 180D(M) 85205-04001
Pin	Pin Name
1	GND
2	SMB_DATE
3	SMB_CLK
4	+5 V

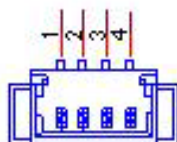

CN19	HD Audio Line In
Part Number	1652505204
Footprint	FOX_JA13331-N23B-4F
Description	PHONE JACK 3.5φ5P 90D(F) BLUE W/SHIELDED
Pin	Pin Name
1	GND_AUD
2	LINEIN_L
3	LINEIN_L
4	LINEIN_R
5	LINEIN_R

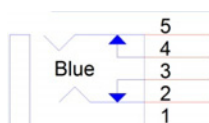

CN20	HD Audio Line Out
Part Number	1652505205
Footprint	FOX_JA13331-N24B-4F
Description	PHONE JACK 3.5φ5P 90D(F) LIME W/SHIELDED
Pin	Pin Name
1	GND_AUD
2	LINEOUT_L
3	LINEOUT_L
4	LINEOUT_R
5	LINEOUT_R

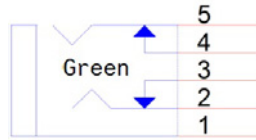

CN21	Inverter Power Output
Part Number	1655000453
Footprint	WHL5 V-2M-24W1140
Description	WAFER BOX 2.0mm 5P 180D(M) DIP WO/Pb JIH VEI
Pin	Pin Name
1	+12 V
2	GND
3	ENABKL
4	VBR
5	+5 V

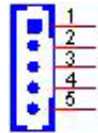

CN22	LPC
Part Number	1653007270
Footprint	LPC_BOARD_PCE-5026_SMD
Description	FEMALE HEADER 7x2P 2.0mm 180D(F) SMD 22P8242
Pin	Pin Name
1	CLK33M_LPC
2	LPC_AD1
3	RESET#
4	LPC_AD0
5	LPC_FRAME#
6	+V3.3
7	LPC_AD3
8	GND
9	LPC_AD2
10	NC
11	LPC_SERIRQ
12	NC
13	+V5SB
14	+V5

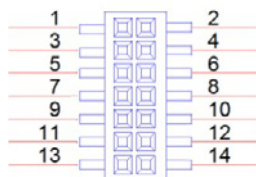

CN23	GPIO
Part Number	1653004099
Footprint	HD_5x2P_79_23N685B-10M10
Description	BOX HEADER 5x2P 2.00mm 180D(M) SMD 23N685B-10M10
Pin	Pin Name
1	+5 V
2	GPIO4
3	GPIO0
4	GPIO5
5	GPIO1
6	GPIO6
7	GPIO2
8	GPIO7
9	GPIO3
10	GND

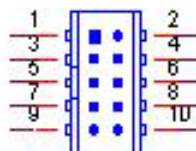

CN24	DC JACK (supported by request)
Part Number	1652005684-01
Footprint	PJ_3P_DCJ-RPBT5NW-25
Description	DC POWER JACK Screw 3P 2.5Φ 90D(M) DIP DCJ-RPB
Pin	Pin Name
1	+VIN
2	GND

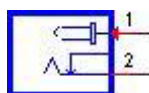

CN25	12 V Power Input
Part Number	1655004584-01
Footprint	WF_2x2P_165_BOX_D
Description	ATX PWR CONN. 2x2P 4.2mm 180D(M) DIP 24W4310-04S
Pin	Pin Name
1	GND
2	GND
3	+12 V IN
4	+12 V IN

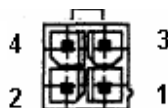

CN26	HD Audio Mic in
Part Number	1652505203
Footprint	FOX_JA13331-N24B-4F
Description	PHONE JACK 3.5PHI 5P 90D(F) DIP JA13331-N21B-4F
Pin	Pin Name
1	GND_AUD
2	MICIN_L
3	MICIN_L
4	MICIN_R
5	MICIN_R

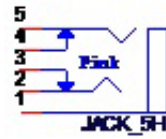

2.5 Quick Installation Guide

There are four posts and screws inside the MIO-3260 package, please install the DRAM in the SODIMM socket on MIO-3260 first, then screw the heatsink into place as per illustration below:

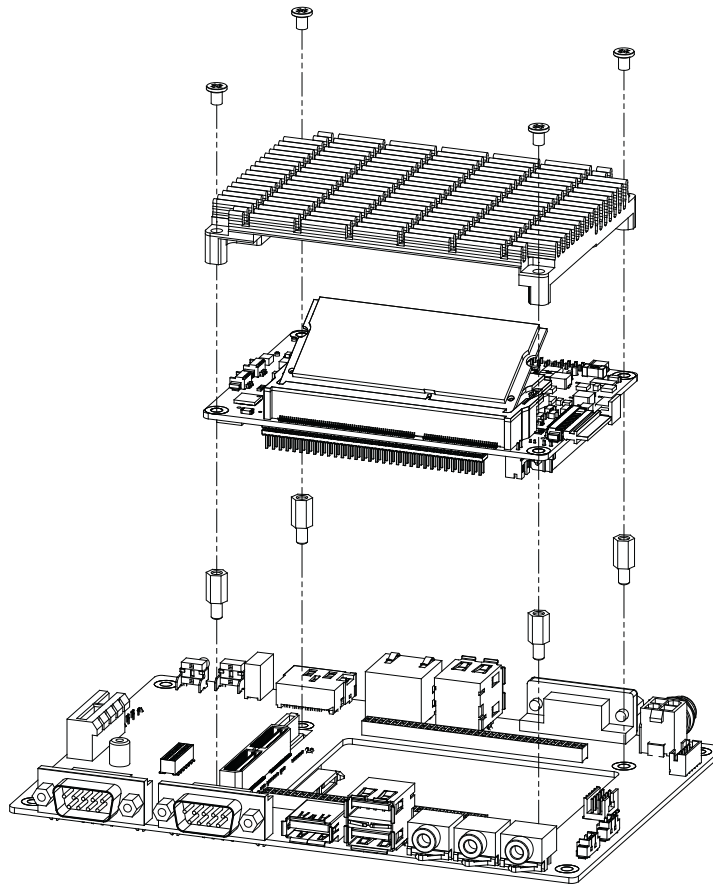

ADVANTECH

Enabling an Intelligent Planet

www.advantech.com

Please verify specifications before quoting. This guide is intended for reference purposes only.

All product specifications are subject to change without notice.

No part of this publication may be reproduced in any form or by any means, electronic, photocopying, recording or otherwise, without prior written permission of the publisher.

All brand and product names are trademarks or registered trademarks of their respective companies.

© Advantech Co., Ltd. 2015

Free Manuals Download Website

<http://myh66.com>

<http://usermanuals.us>

<http://www.somanuals.com>

<http://www.4manuals.cc>

<http://www.manual-lib.com>

<http://www.404manual.com>

<http://www.luxmanual.com>

<http://aubethermostatmanual.com>

Golf course search by state

<http://golfingnear.com>

Email search by domain

<http://emailbydomain.com>

Auto manuals search

<http://auto.somanuals.com>

TV manuals search

<http://tv.somanuals.com>