

▶ BSE774320M
BSK774320M

EN User Manual
Steam oven

USER MANUAL



AEG

CONTENTS

1. SAFETY INFORMATION.....	3
2. SAFETY INSTRUCTIONS.....	4
3. PRODUCT DESCRIPTION.....	8
4. CONTROL PANEL.....	9
5. BEFORE FIRST USE.....	11
6. DAILY USE.....	13
7. CLOCK FUNCTIONS.....	20
8. AUTOMATIC PROGRAMMES.....	21
9. USING THE ACCESSORIES.....	21
10. ADDITIONAL FUNCTIONS.....	25
11. HINTS AND TIPS.....	26
12. CARE AND CLEANING.....	43
13. TROUBLESHOOTING.....	49
14. ENERGY EFFICIENCY.....	51
15. ENVIRONMENTAL CONCERNS.....	53

FOR PERFECT RESULTS

Thank you for choosing this AEG product. We have created it to give you impeccable performance for many years, with innovative technologies that help make life simpler – features you might not find on ordinary appliances. Please spend a few minutes reading to get the very best from it.

Visit our website to:



Get usage advice, brochures, trouble shooter, service and repair information:
www.aeg.com/support



Register your product for better service:
www.registeraeg.com



Buy Accessories, Consumables and Original spare parts for your appliance:
www.aeg.com/shop

CUSTOMER CARE AND SERVICE

Always use original spare parts.

When contacting our Authorised Service Centre, ensure that you have the following data available: Model, PNC, Serial Number.

The information can be found on the rating plate.

 Warning / Caution-Safety information

 General information and tips

 Environmental information

Subject to change without notice.

1. SAFETY INFORMATION

Before the installation and use of the appliance, carefully read the supplied instructions. The manufacturer is not responsible for any injuries or damage that are the result of incorrect installation or usage. Always keep the instructions in a safe and accessible location for future reference.

1.1 Children and vulnerable people safety

- This appliance can be used by children aged from 8 years and above and persons with reduced physical, sensory or mental capabilities or lack of experience and knowledge if they have been given supervision or instruction concerning the use of the appliance in a safe way and understand the hazards involved. Children of less than 8 years of age and persons with very extensive and complex disabilities shall be kept away from the appliance unless continuously supervised.
- Children should be supervised to ensure that they do not play with the appliance.
- Keep all packaging away from children and dispose of it appropriately.
- **WARNING:** Keep children and pets away from the appliance when it operates or when it cools down. Accessible parts become hot during use.
- If the appliance has a child safety device, it should be activated.
- Children shall not carry out cleaning and user maintenance of the appliance without supervision.

1.2 General Safety

- Only a qualified person must install this appliance and replace the cable.
- Do not use the appliance before installing it in the built-in structure.

- Disconnect the appliance from the power supply before carrying out any maintenance.
- If the mains power supply cable is damaged, it must be replaced by the manufacturer, its Authorised Service Centre or similarly qualified persons to avoid an electrical hazard.
- The means for disconnection must be incorporated in the fixed wiring in accordance with the wiring rules.
- **WARNING:** Ensure that the appliance is switched off before replacing the lamp to avoid the possibility of electric shock.
- **WARNING:** The appliance and its accessible parts become hot during use. Care should be taken to avoid touching heating elements.
- Always use oven gloves to remove or put in accessories or ovenware.
- Use only the food sensor (core temperature sensor) recommended for this appliance.
- To remove the shelf supports first pull the front of the shelf support and then the rear end away from the side walls. Install the shelf supports in the opposite sequence.
- Do not use a steam cleaner to clean the appliance.
- Do not use harsh abrasive cleaners or sharp metal scrapers to clean the glass door since they can scratch the surface, which may result in shattering of the glass.
- Excessive spillage must be removed before the pyrolytic cleaning. Remove all parts from the oven.

2. SAFETY INSTRUCTIONS

2.1 Installation



WARNING!

Only a qualified person must install this appliance.

- Remove all the packaging.
- Do not install or use a damaged appliance.
- Follow the installation instructions supplied with the appliance.
- Always take care when moving the appliance as it is heavy. Always use safety gloves and enclosed footwear.
- Do not pull the appliance by the handle.
- Install the appliance in a safe and suitable place that meets installation requirements.

- Keep the minimum distance from other appliances and units.
- Before mounting the appliance, check if the oven door opens without restraint.
- The appliance is equipped with an electric cooling system. It must be operated with the electric power supply.
- The built-in unit must meet the stability requirements of DIN 68930.

Cabinet minimum height (Cabinet under the worktop minimum height)	578 (600) mm
Cabinet width	560 mm
Cabinet depth	550 (550) mm
Height of the front of the appliance	594 mm
Height of the back of the appliance	576 mm
Width of the front of the appliance	595 mm
Width of the back of the appliance	559 mm
Depth of the appliance	567 mm
Built in depth of the appliance	546 mm
Depth with open door	1027 mm
Ventilation opening minimum size. Opening placed on the bottom rear side	560x20 mm
Mounting screws	4x25 mm

2.2 Electrical connection



WARNING!

Risk of fire and electric shock.

- All electrical connections should be made by a qualified electrician.
- The appliance must be earthed.

- Make sure that the parameters on the rating plate are compatible with the electrical ratings of the mains power supply.
- Always use a correctly installed shockproof socket.
- Do not use multi-plug adapters and extension cables.
- Make sure not to cause damage to the mains plug and to the mains cable. Should the mains cable need to be replaced, this must be carried out by our Authorised Service Centre.
- Do not let mains cables touch or come near the appliance door or the niche below the appliance, especially when it operates or the door is hot.
- The shock protection of live and insulated parts must be fastened in such a way that it cannot be removed without tools.
- Connect the mains plug to the mains socket only at the end of the installation. Make sure that there is access to the mains plug after the installation.
- If the mains socket is loose, do not connect the mains plug.
- Do not pull the mains cable to disconnect the appliance. Always pull the mains plug.
- Use only correct isolation devices: line protecting cut-outs, fuses (screw type fuses removed from the holder), earth leakage trips and contactors.
- The electrical installation must have an isolation device which lets you disconnect the appliance from the mains at all poles. The isolation device must have a contact opening width of minimum 3 mm.
- Fully close the appliance door before you connect the mains plug to the mains socket.
- This appliance is supplied without a main plug and a main cable.

2.3 Use



WARNING!

Risk of injury, burns and electric shock or explosion.

- This appliance is for household (indoors) use only.

- Do not change the specification of this appliance.
- Make sure that the ventilation openings are not blocked.
- Do not let the appliance stay unattended during operation.
- Deactivate the appliance after each use.
- Be careful when you open the appliance door while the appliance is in operation. Hot air can release.
- Do not operate the appliance with wet hands or when it has contact with water.
- Do not apply pressure on the open door.
- Do not use the appliance as a work surface or as a storage surface.
- Open the appliance door carefully. The use of ingredients with alcohol can cause a mixture of alcohol and air.
- Do not let sparks or open flames to come in contact with the appliance when you open the door.
- Do not put flammable products or items that are wet with flammable products in, near or on the appliance.



WARNING!

Risk of damage to the appliance.

- To prevent damage or discoloration to the enamel:
 - do not put ovenware or other objects in the appliance directly on the bottom.
 - do not put aluminium foil directly on the bottom of cavity of the appliance.
 - do not put water directly into the hot appliance.
 - do not keep moist dishes and food in the appliance after you finish the cooking.
 - be careful when you remove or install the accessories.
- Discoloration of the enamel or stainless steel has no effect on the performance of the appliance.
- Use a deep pan for moist cakes. Fruit juices cause stains that can be permanent.
- This appliance is for cooking purposes only. It must not be used for

other purposes, for example room heating.

- Always cook with the oven door closed.
- If the appliance is installed behind a furniture panel (e.g. a door) make sure the door is never closed when the appliance operates. Heat and moisture can build up behind a closed furniture panel and cause subsequent damage to the appliance, the housing unit or the floor. Do not close the furniture panel until the appliance has cooled down completely after use.

2.4 Care and cleaning



WARNING!

Risk of injury, fire, or damage to the appliance.

- Before maintenance, deactivate the appliance and disconnect the mains plug from the mains socket.
- Make sure the appliance is cold. There is the risk that the glass panels can break.
- Replace immediately the door glass panels when they are damaged. Contact the Authorised Service Centre.
- Be careful when you remove the door from the appliance. The door is heavy!
- Clean regularly the appliance to prevent the deterioration of the surface material.
- Clean the appliance with a moist soft cloth. Use only neutral detergents. Do not use abrasive products, abrasive cleaning pads, solvents or metal objects.
- If you use an oven spray, follow the safety instructions on its packaging.

2.5 Pyrolytic cleaning



WARNING!

Risk of Injury / Fires / Chemical Emissions (Fumes) in Pyrolytic Mode.

- Before carrying out a Pyrolytic self-cleaning function or the First Use please remove from the oven cavity:

- any excess food residues, oil or grease spills / deposits.
- any removable objects (including shelves, side rails etc., provided with the product) particularly any non-stick pots, pans, trays, utensils etc.
- Read carefully all the instructions for Pyrolytic cleaning.
- Keep children away from the appliance while the Pyrolytic cleaning operates.
The appliance becomes very hot and hot air is released from the front cooling vents.
- Pyrolytic cleaning is a high temperature operation that can release fumes from cooking residues and construction materials, as such consumers are strongly advised to:
 - provide good ventilation during and after each Pyrolytic cleaning.
 - provide good ventilation during and after the first use at maximum temperature operation.
- Unlike all humans, some birds and reptiles can be extremely sensitive to potential fumes emitted during the cleaning process of all Pyrolytic Ovens.
 - Remove any pets (especially birds) from the vicinity of the appliance location during and after the Pyrolytic cleaning and first use maximum temperature operation to a well ventilated area.
- Small pets can also be highly sensitive to the localized temperature changes in the vicinity of all Pyrolytic Ovens when the Pyrolytic self cleaning program is in operation.
- Non-stick surfaces on pots, pans, trays, utensils etc., can be damaged by the high temperature Pyrolytic cleaning operation of all Pyrolytic Ovens and can be also a source for low level harmful fumes.
- Fumes released from all Pyrolytic Ovens / Cooking Residues as described are not harmful to humans, including children, or persons with medical conditions.

2.6 Steam Cooking



WARNING!

Risk of burns and damage to the appliance.

- Released Steam can cause burns:
 - Be careful when you open the appliance door when the function is activated. Steam can release.
 - Open the appliance door with care after the steam cooking operation.

2.7 Internal lighting



WARNING!

Risk of electric shock.

- Concerning the lamp(s) inside this product and spare part lamps sold separately: These lamps are intended to withstand extreme physical conditions in household appliances, such as temperature, vibration, humidity, or are intended to signal information about the operational status of the appliance. They are not intended to be used in other applications and are not suitable for household room illumination.
- This product contains a light source of energy efficiency class G.
- Use only lamps with the same specifications.

2.8 Service

- To repair the appliance contact the Authorised Service Centre.
- Use original spare parts only.

2.9 Disposal



WARNING!

Risk of injury or suffocation.

- Contact your municipal authority for information on how to dispose of the appliance.
- Disconnect the appliance from the mains supply.
- Cut off the mains electrical cable close to the appliance and dispose of it.

- Remove the door catch to prevent children or pets from becoming trapped in the appliance.

3. PRODUCT DESCRIPTION

3.1 General overview

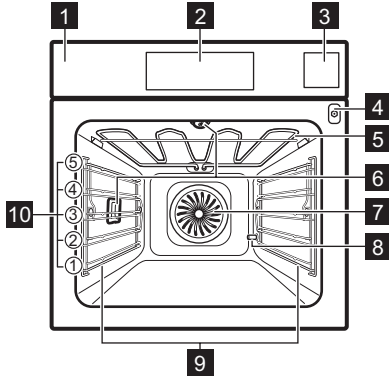

- 1** Control panel
- 2** Electronic programmer
- 3** Water drawer
- 4** Socket for the food sensor
- 5** Heating element
- 6** Lamp
- 7** Fan
- 8** Descaling pipe outlet
- 9** Shelf support, removable
- 10** Shelf positions

3.2 Accessories

Wire shelf

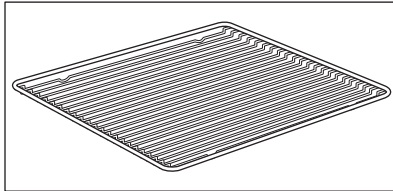

For cookware, cake tins, roasts.

Baking tray

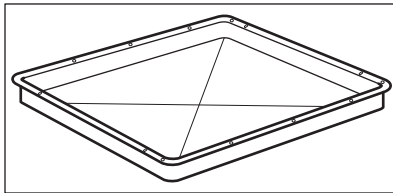

For cakes and biscuits.

Grill- / Roasting pan

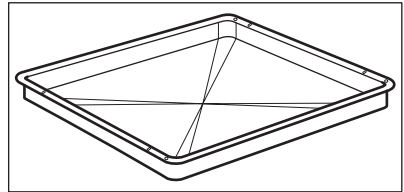

To bake and roast or as a pan to collect fat.

Trivet

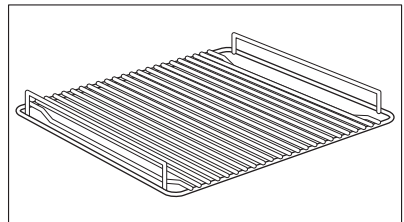

For roasting and grilling.

i Use the trivet only with the Grill- / Roasting pan.

Food Sensor

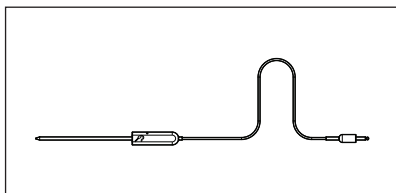

To measure the temperature inside food.

Telescopic runners

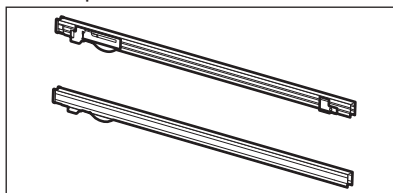

To insert and remove trays and wireshelf more easily.





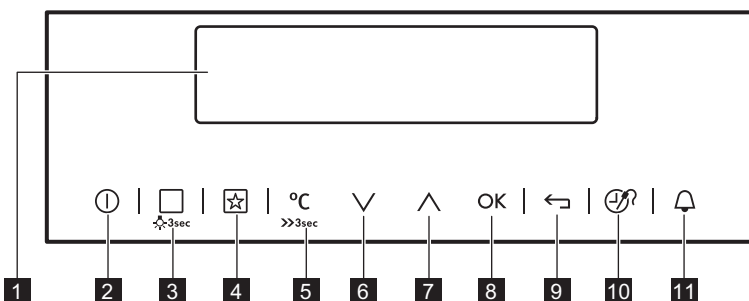

4. CONTROL PANEL

4.1 Electronic programmer



Use the sensor fields to operate the appliance.

Sensor field	Function	Comment
1	-	Display Shows the current settings of the oven.
2	ON / OFF	To turn the oven on and off.
3	Heating Functions or VarioGuide	Press the sensor field once to choose a heating function or the menu: VarioGuide. Press the sensor field again to switch between the menus: Heating Functions, VarioGuide. To turn on or turn off the light, press the field for 3 seconds. You can turn on the light also when the oven is off.
4	Favourites	To save and access your favourite programmes.
5	Temperature selection	To set the temperature or show the current temperature in the oven. Press the field for 3 seconds to turn on or turn off the function: Fast Heat Up.



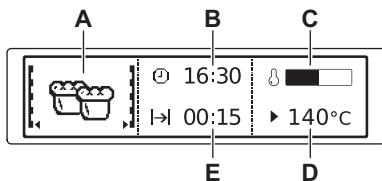

Sensor field	Function	Comment
6 	Down key	To move down in the menu.
7 	Up key	To move up in the menu.
8 	OK	To confirm the selection or setting.
9 	Back key	To go back one level in the menu. To show the main menu, press the field for 3 seconds.
10 	Time and additional functions	To set different functions. When a heating function works, press the sensor field to set the timer or the functions: Function Lock, Favourites, Heat + Hold, Set + Go. You can also change the settings of the core temperature sensor.
11 	Minute Minder	To set the function: Minute Minder.







4.2 Display



- A. Heating function
- B. Time of day
- C. Heat-up indicator
- D. Temperature
- E. Duration time or end time of a function

Other indicators of the display:

Symbol	Function	Function
	Minute Minder	The function works.
	Time of day	The display shows the current time.
	Duration	The display shows the necessary time for cooking.
	End Time	The display shows when the cooking time is complete.
	Temperature	The display shows the temperature.



Symbol		Function
	Time Indication	The display shows how long the heating function works. Press ∇ and \blacktriangle at the same time to reset the time.
	Calculation	The oven calculates the time for cooking.
	Heat-up Indicator	The display shows the temperature in the oven.
	Fast Heat Up	The function is on. It decreases the heat up time.
	Weight Automatic	The display shows that the automatic weight system is on or that weight can be changed.
	Heat + Hold	The function is on.

5. BEFORE FIRST USE

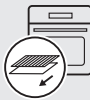

WARNING!
Refer to Safety chapters.

5.1 Initial Cleaning

		
Step 1	Step 2	Step 3
Remove all accessories and removable shelf supports from the oven.	Clean the oven and the accessories with a soft cloth, warm water and a mild detergent.	Place the accessories and the removable shelf supports in the oven.

5.2 First Connection

Before the first use you have to set:			
Language	Display contrast	Display Brightness	Time of day

5.3 Initial preheating



Preheat the empty oven before the first use.

Step 1 Remove all accessories and removable shelf supports from the oven.

Step 2 Set the maximum temperature for the function: . Let the oven operate for 1 h.

Step 3 Set the maximum temperature for the function: . Let the oven operate for 15 min.

The oven can emit an odour and smoke during preheating. Make sure that the room is ventilated.

5.4 How to set: Water hardness



Use the test paper or contact your water supplier to check the water hardness level.

When you connect the oven to the mains you have to set the water hardness level.

Step 1	Step 2	Step 3	Step 4
Put the test paper into water for about 1 sec. Do not put the test paper under running water.	Shake the test paper to remove the excess of water.	After 1 min, check water hardness with the table below.	Set the water hardness level in the menu: Basic settings.
The colours of the test paper continue to change. Do not check water hardness later than 1 min after test.			
You can change the water hardness level in the menu: Basic settings / Water hardness.			

The table shows water hardness range (dH) with the corresponding level of Calcium deposit and the water classification. Adjust the water hardness level according to the table.

Water hardness		Test paper	Calcium deposit (mmol/l)	Calcium deposit (mg/l)	Water classification
Level	dH				
1	0 - 7		0 - 1.3	0 - 50	soft

Water hardness		Test paper	Calcium de-posit (mmol/l)	Calcium de-posit (mg/l)	Water classification
Level	dH				
2	8 - 14		1.4 - 2.5	51 - 100	moderately hard
3	15 - 21		2.6 - 3.8	101 - 150	hard
4	≥22		≥ 3.9	≥151	very hard

When the tap water hardness level is 4, fill the water drawer with still bottled water.

6. DAILY USE



WARNING!
Refer to Safety chapters.

6.1 Navigating the menus

1. Turn on the oven.
2. Press ∇ or \blacktriangle to select the menu option.
3. Press **OK** to move to the submenu or accept the setting.



At each point you can go back to the main menu with \leftarrow .

6.2 Setting a heating function

1. Turn on the oven.
2. Select the menu: Heating Functions.
3. Press **OK** to confirm.
4. Select a heating function.
5. Press **OK** to confirm.
6. Set the temperature.
7. Press **OK** to confirm.

6.3 Cooking with steam heating function

The water drawer cover is in the control panel.



WARNING!
Use only cold tap water. Do not use filtered (demineralised) or distilled water. Do not use other liquids. Do not put flammable or alcoholic liquids into the water drawer.

1. Press the cover of the water drawer to open it.
2. Fill the water drawer with cold water to the maximum level (around 950 ml) until the signal sounds or the display shows the message. Do not fill the water drawer over its maximum capacity. There is a risk of water leakage, overflow and furniture damages.
3. Push the water drawer to its initial position.
4. Turn on the oven.
5. Set a steam heating function and the temperature.
6. If necessary, set the function: Duration $\left| \rightarrow \right|$ or: End Time $\rightarrow \left|$.
The steam appears after approximately 2 minutes. When the oven reaches the set temperature, the signal sounds.
When the water drawer is running out of water, the signal sounds and the water drawer needs to be refilled to continue cooking as described above.

The signal sounds at the end of the cooking time.

7. Turn off the oven.
8. Empty the water drawer after the cooking is completed.
Refer to the cleaning function: Tank Emptying.



CAUTION!

The oven is hot. There is a risk of burns.

9. After cooking steam can condensate on the bottom of the cavity. Always dry the bottom of the cavity when the oven is cool.

Let the oven dry fully with the door open. To speed up the drying you can close the door and heat up the oven with the function: True Fan Cooking at temperature 150°C for approximately 15 minutes.

6.4 Heat-up indicator

When you turn on a heating function, the bar shows that the temperature increases. When temperature is reached the signal sounds 3 times, the bar flashes and disappears.

6.5 Using: Fast Heat Up

Use this function before you put the food in the oven.

This function reduces the heat-up time. It is not available for some oven functions.

°C
»»_{30s} - press and hold.

6.6 Residual heat

When you turn off the oven, the display shows the residual heat. You can use the heat to keep the food warm.

6.7 The menus in overview









Main menu







Symbol / Menu item	Application
 Heating Functions	Contains a list of heating functions.

Symbol / Menu item	Application
 Recipes	Contains a list of automatic programmes.
 Favourites	Contains a list of favourite cooking programmes created by the user.
 Cleaning	Pyrolytic cleaning.
 Basic Settings	Used to set the appliance configuration.
 Specials	Contains a list of additional heating functions.
 VarioGuide	Contains recommended oven settings for a wide choice of dishes. Select a dish and start the cooking process. The temperature and time are only guidelines for a better result and can be adjusted. They depend on the recipes and the quality and quantity of the used ingredients.





Submenu for: Basic Settings

Symbol / Menu item	Description
 Set Time of Day	Sets the current time on the clock.
 Time Indication	When ON, the display shows the current time when you deactivate the appliance.
 Fast Heat Up	When ON, the function decreases the heat-up time.







Symbol / Menu item	Description
 Set + Go	To set a function and activate it later with a press of any symbol on the control panel.
 Heat + Hold	Keeps the prepared food warm for 30 minutes after a cooking cycle finished.
 Time Extension	Activates and deactivates the time extension function.
 Display Contrast	Adjusts the display contrast by degrees.
 Display Brightness	Adjusts the display brightness by degrees.
 Set Language	Sets the language for the display.
 Buzzer Volume	Adjusts the volume of press-tones and signals by degrees.
 Key Tones	Activates and deactivates the tone of the touch fields. It is not possible to deactivate the tone of the ON / OFF touch field.



Symbol / Menu item	Description
 Alarm / Error Tones	Activates and deactivates the alarm tones.
 Water hardness	To sets the water hardness level (1 - 4).
 Cleaning Reminder	Reminds you when to clean the appliance.
 DEMO mode	Activation / deactivation code: 2468.
 Service	Shows the software version and configuration.
 Factory Settings	Resets all settings to factory settings.

6.8 Submenu for: Cleaning

Symbol	Menu item	Description
	Tank Emptying	Procedure for removing the residual water from the water drawer after use of the steam functions.
	Cleaning	Procedure for cleaning the appliance.
	Descaling	Procedure for cleaning the steam generation circuit from residual limestone.
	Rinsing	Procedure for rinsing and cleaning the steam generation circuit after frequent use of the steam functions.





6.9 Heating Functions





Heating function	Application
 True Fan Cooking	To bake on up to three shelf positions at the same time and to dry food. Set the temperature 20 - 40 °C lower than for the function: Conventional Cooking.
 Pizza Function	To bake food on one shelf position for a more intensive browning and a crispy bottom. Set the temperature 20 - 40 °C lower than for the function: Conventional Cooking.
 Conventional Cooking	To bake and roast food on one shelf position.
 Frozen Foods	To make convenience food (e.g., french fries, potato wedges or spring rolls) crispy.
 Grill	To grill thin pieces of food and to toast bread.
 Turbo Grilling	To roast large meat joints or poultry with bones on one shelf position. To make gratins and to brown.
 Bottom Heat	To bake cakes with crispy bottom and to preserve food.

Heating function	Application
 Moist Fan Baking	This function is designed to save energy during cooking. When you use this function, the temperature in the cavity may differ from the set temperature. The residual heat is used. The heating power may be reduced. For more information refer to "Daily Use" chapter, Notes on: Moist Fan Baking.
 Humidity Low	To bake bread, roast large pieces of meat or to warm up chilled and frozen meals.

 The lamp may automatically deactivate at a temperature below 60 °C during some oven functions.

6.10 Specials

Heating function	Application
 Defrost	To defrost food (vegetables and fruit). The defrosting time depends on the amount and size of the frozen food.
 Keep Warm	To keep food warm.
 Plate Warming	To preheat plates for serving.
 Preserving	To preserve vegetables (e.g., pickles).

Heating function	Application
 Dehydrating	To dry sliced fruit, vegetables and mushrooms.
 Dough Proving	To rise the yeast dough before baking.
 Slow Cooking	To prepare tender, succulent roasts.
 Bread Baking	Use this function to prepare bread and bread rolls with professional-like result in terms of crispiness, colour and crust gloss.
 Steam Regenerating	Food reheating with steam prevents surface drying. Heat is distributed in a gentle and even way, which allows to recover taste and aroma of food as just prepared. This function can be used to reheat food directly on a plate. You can reheat more than one plate at the same time, using different shelf positions.

6.11 Notes on: Moist Fan Baking

This function was used to comply with the energy efficiency class and ecodesign requirements. Tests according to BS EN 60350-1.

The oven door should be closed during cooking so that the function is not interrupted and the oven operates with the highest energy efficiency possible.

When you use this function the lamp automatically turns off after 30 sec.

For the cooking instructions refer to "Hints and tips" chapter, Moist Fan Baking. For general energy saving recommendations refer to "Energy Efficiency" chapter, Energy Saving.

6.12 VarioGuide

Food Category: Fish / Seafood











Dish	
Fish	Fish, baked
	Fish fingers
	Fish fillet, frozen
	Whole small fish, grilled
	Whole fish, grilled
	
Whole salmon	-



Food Category: Poultry

Dish	
Boned poultry	-
Chicken	Chicken wings, fresh
	Chicken wings, frozen
	Chicken legs, fresh
	Chicken legs, frozen
	Chicken, 2 halves

Food Category: Meat

Dish	
Beef	Braised meat 
	Meatloaf

Dish	
Roast beef	Rare
	Rare 
	Medium
	Medium 
	Well done
	Well done 
Scandinavian beef	Rare 
	Medium 
	Well done 
Pork	Spare ribs
	Pork knuckle, pre-cooked
	Pork joint
	Loin of pork
	Loin of pork 
	Loin of pork, smoked
	Pork neck
	Pork shoulder
	Roast pork 
Veal	Veal knuckle
	Loin of veal
	Roast veal 
Lamb	Leg of lamb
	Roast lamb 
	Saddle of lamb
	Lamb joint, medium
	Lamb joint, medium 

Dish	
Game	Hare <ul style="list-style-type: none"> • Leg of hare • Saddle of hare • Saddle of hare 
	Venison <ul style="list-style-type: none"> • Haunch of venison • Saddle of venison
	Roast game 
	Loin of game 

Food Category: Oven Dishes

Dish	
Lasagne	-
Lasagne / Cannelloni, frozen	-
Pasta	-
Potato gratin	-
Vegetables au gratin	-
Sweet dishes	-

Food Category: Pizza / Quiche

Dish	
Pizza	Pizza, thin
	Pizza, extra topping
	Pizza, frozen
	Pizza American, frozen
	Pizza, chilled
	Pizza snacks, frozen
Baguettes au gratin	-
Tarte flambée	-

Dish	
Swiss Tarte, savou- ry	-
Quiche lorraine	-
Savory flan	-

Food Category: Cake / Pastry

Dish	
Ring cake	-
Apple cake, cov- ered	-
Sponge cake	-
Apple pie	-
Cheese cake, tin	-
Brioche	-
Madeira cake	-
Tarte	-
Swiss Tarte, sweet	-
Almond cake	-
Muffins	-
Pastry	-
Pastry strips	-
Cream puffs	-
Puff pastry	-
Eclairs	-
Macaroons	-
Short pastry biscuits	-
Christmas stollen	-
Apple strudel, fro- zen	-
Cake on tray	Sponge dough Yeast dough
Cheese cake, tray	-
Brownies	-

Dish	
Swiss roll	-
Yeast cake	-
Crumble cake	-
Sugar cake	-
Flan base	Short pastry flan base
	Sponge mixture flan base
Fruit flan	Short pastry fruit flan
	Sponge mixture fruit flan
	Yeast dough

Food Category: Bread / Rolls

Dish	
Rolls	Rolls
	Rolls, pre-baked
	Rolls, frozen
Ciabatta	-
Baguette	Baguette, pre- baked
	Baguette, frozen
Bread	Bread crown
	White bread
	Yeast plait
	Brown bread
	Rye bread
	Wholegrain bread
	Unleavened bread
Bread/Rolls, frozen	

Food Category: Side dishes



Dish	
French fries, thin	-
French fries, thick	-
French fries, frozen	-
Croquettes	-
Wedges	-

Dish	
Hash browns	-

i When it is necessary to change the weight or the core temperature of the dish, use \wedge or \vee to set the new values.

7. CLOCK FUNCTIONS

7.1 Clock functions table

Clock function	Application
 Minute Minder	To set a countdown (max. 2 h 30 min). This function has no effect on the operation of the oven.
 Duration	To set how long the oven works (max. 23 h 59 min). It is not available for: Food Sensor.
 End Time	To set the switch-off time for a heating function (max. 23 h 59 min). It is not available for: Food Sensor.

If you set the time for a clock function, the time starts to count down after 5 sec.

Duration, End Time - before you use the functions you must set a heating function and temperature. The oven turns off automatically.

Duration, End Time - you can use the functions at the same time if you want to automatically turn on and turn off the oven on a given time later.

7.2 Setting the clock functions

1. Set a heating function.
2.  - press again and again until the display shows the necessary clock function and the related symbol.

3. \wedge , \vee - press to set the time.

4. Press: **OK**.

When the time ends, a signal sounds. The oven turns off. The display shows a message.

5. Press any symbol to stop the signal.

7.3 Heat + Hold

Conditions for the function:

- The set temperature is more than 80 °C.
- The function: Duration is set.

The function: Heat + Hold keeps prepared food warm at 80 °C for 30 minutes. It turns on after the baking or roasting procedure ends.

You can turn on or turn off the function in the menu: Basic Settings.

1. Turn on the oven.
 2. Select the heating function.
 3. Set the temperature above 80 °C.
 4. Press  again and again until the display shows: Heat + Hold.
 5. Press **OK** to confirm.
- When the function ends, a signal sounds.

7.4 Time Extension

The function: Time Extension makes the heating function continue after the end of Duration.



Applicable to all heating functions with Duration or Weight Automatic.
Not applicable to heating functions with the food sensor.

1. When the cooking time ends, a signal sounds. Press any symbol.

The display shows the message.

2. Press to turn on or to cancel.
3. Set the length of the function.
4. Press **OK**.

8. AUTOMATIC PROGRAMMES



WARNING!
Refer to Safety chapters.

8.1 Recipes online

You can find the recipes for the automatic programmes on our website. To find the Recipe Book check the PNC number on the rating plate on the front frame of the oven cavity.

8.2 Recipes with Recipe Automatic

This oven has a set of recipes you can use. The recipes are fixed and you cannot change them.

1. Turn on the oven.
2. Select the menu: Recipes. Press **OK** to confirm.
3. Select the category and dish. Press **OK** to confirm.
4. Select a recipe. Press **OK** to confirm.

9. USING THE ACCESSORIES



WARNING!
Refer to Safety chapters.

9.1 Food Sensor

Food sensor measures temperature inside the food. When the food is at the set temperature, the oven turns off.

There are two temperatures to be set:

- the oven temperature (minimum 120 °C),
- the food core temperature.



CAUTION!
Use only the food sensor supplied and the original replacement parts.

For the best cooking results:

- Ingredients should be at room temperature.

- Food sensor cannot be used for liquid dishes.
- During cooking the food sensor must remain in the dish and the plug in the socket.
- Use recommended food core temperature settings. Refer to "Hints and tips" chapter.



The oven calculates an approximate end of cooking time. It depends on the quantity of food, the set heating function and temperature.

Food categories: meat, poultry and fish

1. Activate the appliance.
2. Insert the tip of the food sensor into the centre of meat or fish, in the thickest part if possible. Make sure

that at least 3/4 of the food sensor is inside of the dish.

- Put the plug of the food sensor into the socket located in the front frame of the appliance.

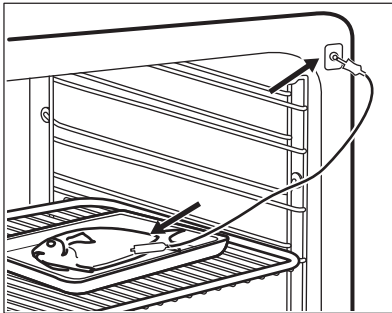
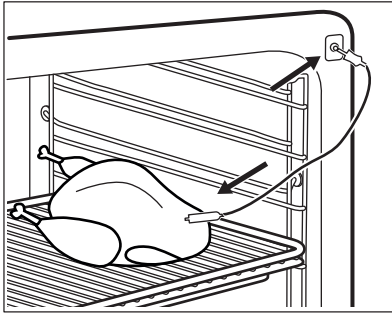

The display shows the food sensor symbol.

- Press \wedge or \vee in less than 5 seconds to set the food core temperature.
- Set a heating function and, if necessary, the oven temperature.
- To change the food core temperature, press Ⓢ .

When the dish reaches the set temperature, an acoustic signal sounds. The appliance deactivates automatically.

- Touch any symbol to stop the signal.
- Remove the food sensor plug from the socket and remove the dish from the appliance.



WARNING!

There is a risk of burns as the food sensor becomes hot. Be careful when you unplug it and remove it from the food.

Food category: casserole

- Activate the appliance.
- Place half of the ingredients in a baking dish.
- Insert the tip of the food sensor exactly in the centre of the casserole. The food sensor should be stabilized in one place during baking. Use a solid ingredient to achieve that. Use the rim of the baking dish to support the silicone handle of the food sensor. The tip of the food sensor should not touch the bottom of a baking dish.

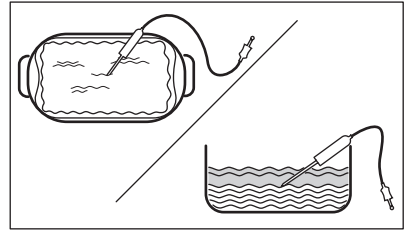

- Cover the food sensor with the remaining ingredients.
- Put the plug of the food sensor into the socket located in the front frame of the appliance.

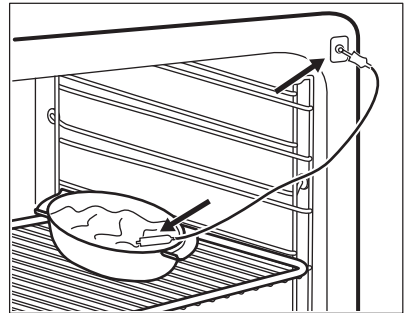

The display shows the food sensor symbol.

- Press \wedge or \vee in less than 5 seconds to set the food core temperature.
- Set a heating function and, if necessary, the oven temperature.
- To change the food core temperature, press Ⓢ .

When the dish is at the set temperature, an acoustic signal sounds. The appliance deactivates automatically.

9. Touch any symbol to stop the signal.
10. Remove the food sensor plug from the socket and remove the dish from the appliance.



WARNING!

There is a risk of burns as the food sensor becomes hot. Be careful when you unplug it and remove it from the food.

9.2 Inserting accessories

A small indentation at the top increases safety. The indentations are also anti-tip devices. The high rim around the shelf prevents cookware from slipping of the shelf.

Wireshelf:

Push the shelf between the guide bars of the shelf support.

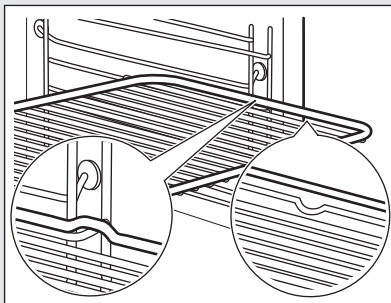

Baking tray / Deep pan:

Push the tray between the guide bars of the shelf support.

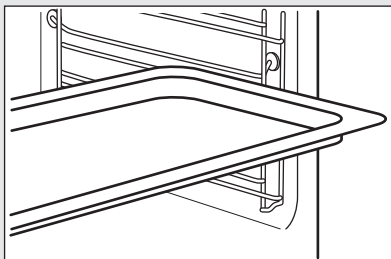

Wireshelf, Baking tray / Deep pan:

Push the tray between the guide bars of the shelf support and the wire shelf on the guide bars above.

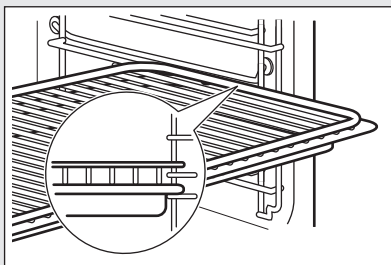

9.3 Using telescopic runners

Do not oil the telescopic runners.

Make sure you push back the telescopic runners fully in the oven before you close the oven door.

Wire shelf:

Put the wire shelf on the telescopic runners.

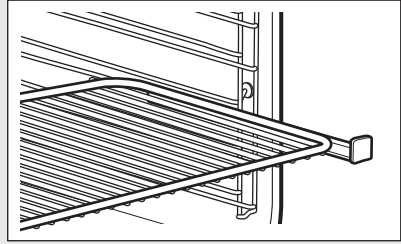

Deep pan:

Put the deep pan on the telescopic runners.

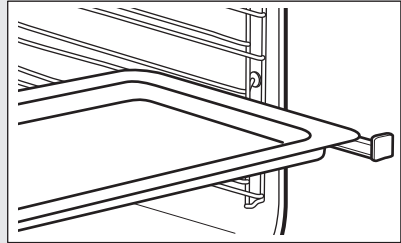

Wire shelf and deep pan together:

Place the wire shelf and the deep pan together on the telescopic runner.

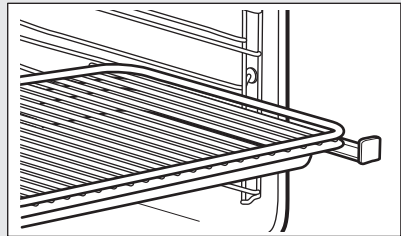

9.4 Trivet and Grill- / Roasting pan

Step 1 Put the trivet into a deep pan.

Step 2 Put the deep pan on the recommended shelf position.

Roasting larger pieces of meat or poultry on one shelf position.

Grilling and toasting thin pieces of food in large quantities.

Make sure the supports of the wire shelf point up.

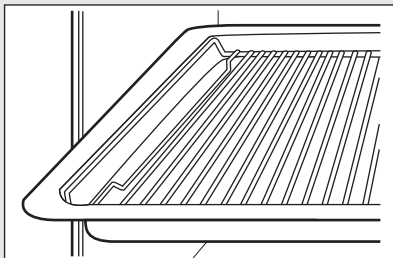

Make sure the supports of the wire shelf point down.

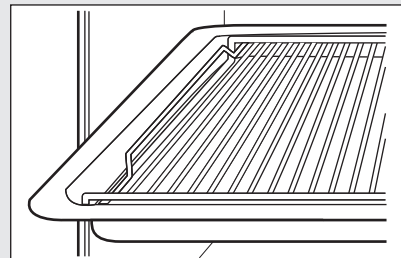





10. ADDITIONAL FUNCTIONS

10.1 Favourites

You can save your favourite settings, such as duration, temperature or heating function. They are available in the menu: Favourites. You can save 20 programmes.

Saving a programme

1. Turn on the oven.
2. Set a heating function or an automatic programme.
3. Press  again and again until the display shows: SAVE.
4. Press **OK** to confirm.
The display shows the first free memory position.
5. Press **OK** to confirm.
6. Enter the name of the programme.
The first letter flashes.
7. Press  or  to change the letter.
8. Press **OK**.
The next letter flashes.
9. Do step 7 again as necessary.
10. Press and hold **OK** to save.
You can overwrite a memory position. When the display shows the first free memory position, press  or  and press **OK** to overwrite an existing programme.

You can change the name of a programme in the menu: Edit Programme Name.

Activating the programme



1. Turn on the oven.
2. Select the menu: Favourites.
3. Press **OK** to confirm.
4. Select your favourite programme name.
5. Press **OK** to confirm.
You can press  to go directly to menu: Favourites. You can also use it when the oven is off.

10.2 Using the Child Lock

When the Child Lock is on, the oven cannot be turned on accidentally.



If the Pyrolysis function works, the door locks automatically.
A message comes on in the display when you press any symbol.

1. Press  to turn on the display.
2. Press  and  at the same time until the display shows a message .
To turn off the Child Lock function repeat step 2.



10.3 Function Lock

This function prevents an accidental change of the heating function. You can turn it on only when the oven works.

1. Turn on the oven.
2. Set a heating function or setting.
3. Press  again and again until the display shows: Function Lock.
4. Press **OK** to confirm.



If the Pyrolysis function works, the door is locked and the symbol of a key comes on in the display.

To turn off the function, press . The display shows a message. Press  again and then **OK** to confirm.





When you turn off the oven, the function also turns off.

10.4 Set + Go

The function lets you set a heating function (or a programme) and use it later with one press of any symbol.

1. Turn on the oven.
2. Set a heating function.
3. Press  again and again until the display shows: Duration.
4. Set the time.

5. Press  again and again until the display shows: Set + Go.
6. Press OK to confirm.

Press any symbol (except for ) to start the function: Set + Go. The set heating function starts.



When the heating function ends, a signal sounds.



- Function Lock is on when the heating function works.
- The menu: Basic Settings lets you turn the function: Set + Go on and off.

10.5 Automatic switch-off

For safety reasons the oven turns off after some time, if a heating function works and you do not change any settings.

 (°C)	 (h)
30 - 115	12.5
120 - 195	8.5
200 - 245	5.5
250 - maximum	3

The Automatic switch-off does not work with the functions: Light, Food Sensor, Duration, End Time.



11. HINTS AND TIPS



Refer to Safety chapters.

10.6 Brightness of the display

There are two modes of display brightness:

 Day brightness	 Night brightness
It is on when the oven is turned on.	
It is on for 10 sec when you touch any sensor field during the night brightness mode.	When the oven is turned off, the display is in night brightness mode between 10 PM and 6 AM.
It is on when the oven is turned off and you set the function: Minute Minder. When the function ends, the display goes back to the night brightness.	

10.7 Cooling fan

When the oven operates, the cooling fan turns on automatically to keep the surfaces of the oven cool. If you turn off the oven, the cooling fan can continue to operate until the oven cools down.

11.1 Cooking recommendations



The temperature and cooking times in the tables are guidelines only. They depend on the recipes and the quality and quantity of the ingredients used.

Your oven may bake or roast differently to the oven you had before. The hints below show recommended settings for temperature, cooking time and shelf position for specific types of the food.

If you cannot find the settings for a special recipe, look for the similar one.

11.2 Inner side of the door

On the inner side of the door you can find:

- the numbers of the shelf positions.
- information about the heating functions, recommended shelf positions and temperatures for dishes.

11.3 Advice for special heating functions of the oven

Keep Warm

The function allows you to keep food warm. The temperature is set automatically to 80 °C.

Plate Warming

The function allows you to warm plates and dishes before serving. The temperature is set automatically to 70 °C.

Place plates and dishes in stacks evenly on the wire shelf. Use the first shelf position. After half of the warming time switch their places.

Dough Proving



The function allows you to rise yeast dough. Put the dough into a big dish. Use the first shelf position. Set function: Dough Proving and the cooking time.



Defrost

Remove the food packaging and put the food on a plate. Do not cover the food, as it can extend the defrosting time. Use the first shelf position.

11.4 Humidity Low



Use the second shelf position unless specified otherwise.



	 (°C)	 (min)
Ready-to-bake rolls	200	15 - 20
Ready-to-bake baguettes, 40 - 50 g	200	15 - 20
Bread rolls, 40 - 60 g	180 - 200	25 - 35
Ready-to-bake baguettes, frozen, 40 - 50 g	200	25 - 35
Meatloaf, raw, 0.5 kg	180	30 - 40
Pasta bake	170 - 190	40 - 50
Lasagne	170 - 180	45 - 55
Bread, 0.5 - 1 kg	180 - 190	45 - 60
Potato gratin	160 - 170	50 - 60
Chicken, 1 kg	180 - 210	50 - 60
Pork loin, smoked, 0.6 - 1 kg, soak for 2 hours	160 - 180	60 - 70
Roast beef, 1 kg	180 - 200	60 - 90

	 (°C)	 (min)
Duck, 1.5 - 2 kg	180	70 - 90
Roast veal, 1 kg	180	80 - 90
Roast pork, 1 kg	160 - 180	90 - 100
Goose, 3 kg, use the first shelf position	170	130 - 170

11.5 Steam Regenerating

Use the second shelf position.

	 (°C)	 (min)
One-plate dishes	120 - 130	15 - 20

	 (°C)	 (min)
Pasta	120 - 130	15 - 20
Rice	120 - 130	15 - 20
Dumplings	120 - 130	15 - 20

11.6 Baking

For the first baking, use the lower temperature.

You can extend the baking time by 10 – 15 minutes if you bake cakes on more than one shelf position.

Cakes and pastries at different heights do not always brown equally. There is no need to change the temperature setting if an unequal browning occurs. The differences equalize during baking.







Trays in the oven can distort during baking. When the trays are cold again, the distortions disappear.







11.7 Tips on baking







Baking results	Possible cause	Remedy
The bottom of the cake is not baked sufficiently.	The shelf position is incorrect.	Put the cake on a lower shelf.
The cake sinks and becomes soggy or streaky.	The oven temperature is too high.	Next time set slightly lower oven temperature.
	The oven temperature is too high and the baking time is too short.	Next time set a longer baking time and lower oven temperature.
The cake is too dry.	The oven temperature is too low.	Next time set higher oven temperature.
	The baking time is too long.	Next time set shorter baking time.
The cake bakes unevenly.	The oven temperature is too high and the baking time is too short.	Next time set a longer baking time and lower oven temperature.
	The cake batter is not evenly distributed.	Next time spread the cake batter evenly on the baking tray.







Baking results	Possible cause	Remedy
The cake is not ready in the baking time specified in a recipe.	The oven temperature is too low.	Next time set a slightly higher oven temperature.







11.8 Baking on one level

 BAKING IN TINS				
		 (°C)	 (min)	
Ring cake / Brioche	True Fan Cooking	150 - 160	50 - 70	1
Madeira cake / Fruit cakes	True Fan Cooking	140 - 160	70 - 90	1
Flan base - short pastry, preheat the empty oven	True Fan Cooking	150 - 160	20 - 30	2
Flan base - sponge cake mixture	True Fan Cooking	150 - 170	20 - 25	2
Cheesecake	Conventional Cooking	170 - 190	60 - 90	1





 CAKES / PASTRIES / BREADS ON BAKING TRAYS				
 Preheat the empty oven unless specified otherwise.				
		 (°C)	 (min)	
Plaited bread / Bread crown, preheating is not needed	Conventional Cooking	170 - 190	30 - 40	3
Christstollen	Conventional Cooking	160 - 180	50 - 70	2
Rye bread:	Conventional Cooking	first: 230 then: 160 - 180	20 30 - 60	1

 CAKES / PASTRIES / BREADS ON BAKING TRAYS				
 Preheat the empty oven unless specified otherwise.				
		 (°C)	 (min)	
Cream puffs / Eclairs	Conventional Cooking	190 - 210	20 - 35	3
Swiss roll,	Conventional Cooking	180 - 200	10 - 20	3
Cake with crumble topping, preheating is not needed	True Fan Cooking	150 - 160	20 - 40	3
Buttered almond cake / Sugar cakes	Conventional Cooking	190 - 210	20 - 30	3
Fruit flans, pre-heating is not needed	Conventional Cooking	180	35 - 55	3
Yeast cakes with delicate toppings (e.g. quark, cream, custard)	Conventional Cooking	160 - 180	40 - 60	3

 BISCUITS				
 Use the third shelf position.				
		 (°C)	 (min)	
Short pastry / Sponge cake mixture	True Fan Cooking	150 - 160	15 - 25	
Meringues	True Fan Cooking	80 - 100	120 - 150	
Macaroons	True Fan Cooking	100 - 120	30 - 50	
Yeast dough biscuits	True Fan Cooking	150 - 160	20 - 40	
Puff pastries, preheat the empty oven	True Fan Cooking	170 - 180	20 - 30	

 BISCUITS			
 Use the third shelf position.			
		 (°C)	 (min)
Rolls, preheat the empty oven	Conventional Cooking	190 - 210	10 - 25





11.9 Bakes and gratins





 Use the first shelf position.			
		 (°C)	 (min)
Pasta bake	Conventional Cooking	180 - 200	45 - 60
Lasagne	Conventional Cooking	180 - 200	25 - 40
Vegetables au gratin, preheat the empty oven	Turbo Grilling	170 - 190	15 - 35
Baguettes with melted cheese	True Fan Cooking	160 - 170	15 - 30
Milk rice	Conventional Cooking	180 - 200	40 - 60
Fish bakes	Conventional Cooking	180 - 200	30 - 60
Stuffed vegetables	True Fan Cooking	160 - 170	30 - 60

11.10 Multilevel Baking

Use the function: True Fan Cooking.

For 2 trays use the first and fourth shelf position.

 CAKES / PASTRIES / BREADS ON BAKING TRAYS			
	 (°C)	 (min)	
Cream puffs / Eclairs, preheat the empty oven	160 - 180	25 - 45	
Dry streusel cake	150 - 160	30 - 45	

 BISCUITS		
	 (°C)	 (min)
Short pastry biscuits	150 - 160	20 - 40
Meringues	80 - 100	130 - 170
Macaroons	100 - 120	40 - 80
Yeast dough biscuits	160 - 170	30 - 60
Puff pastries, preheat the empty oven	170 - 180	30 - 50
Rolls	180	20 - 30

11.11 Tips on Roasting

Use heat-resistant ovenware.

Roast lean meat covered (you can use aluminium foil).

Roast large meat joints directly in the tray or on the wire shelf placed above the tray.

Put some water in the tray to prevent dripping fat from burning.







Turn the roast after 1/2 - 2/3 of the cooking time.

Roast meat and fish in large pieces (1 kg or more).

Baste meat joints with their own juice several times during roasting.





11.12 Roasting

Use the first shelf position.

 BEEF				
			 (°C)	 (min)
Pot roast	1 - 1.5 kg	Conventional Cooking	230	120 - 150
Roast beef or fillet, rare, preheat the empty oven	1 cm thick	Turbo Grilling	190 - 200	5 - 6
Roast beef or fillet, medium, preheat the empty oven	1 cm thick	Turbo Grilling	180 - 190	6 - 8
Roast beef or fillet, well done, preheat the empty oven	1 cm thick	Turbo Grilling	170 - 180	8 - 10





PORK

Use the function: Turbo Grilling.

	 (kg)	 (°C)	 (min)
Shoulder / Neck / Ham joint	1 - 1.5	150 - 170	90 - 120
Chops / Spare rib	1 - 1.5	170 - 190	30 - 60
Meatloaf	0.75 - 1	160 - 170	50 - 60
Pork knuckle, precooked	0.75 - 1	150 - 170	90 - 120





VEAL







Use the function: Turbo Grilling.







	 (kg)	 (°C)	 (min)
Roast veal	1	160 - 180	90 - 120
Veal knuckle	1.5 - 2	160 - 180	120 - 150







LAMB

Use the function: Turbo Grilling.

	 (kg)	 (°C)	 (min)
Lamb leg / Roast lamb	1 - 1.5	150 - 170	100 - 120
Lamb saddle	1 - 1.5	160 - 180	40 - 60

 GAME				
	 (kg)		 (°C)	 (min)
Saddle / Hare leg, preheat the empty oven	1	Turbo Grilling	180 - 200	35 - 55
Venison saddle	1.5 - 2	Conventional Cooking	180 - 200	60 - 90
Haunch of venison	1.5 - 2	Conventional Cooking	180 - 200	60 - 90





 POULTRY				
 Use the function: Turbo Grilling.				
	 (kg)	 (°C)	 (min)	
Poultry, portions	0.2 - 0.25	200 - 220	30 - 50	
Chicken, half	0.4 - 0.5	190 - 210	40 - 50	
Chicken, poulard	1 - 1.5	190 - 210	50 - 70	
Duck	1.5 - 2	180 - 200	80 - 100	
Goose	3.5 - 5	160 - 180	120 - 180	
Turkey	2.5 - 3.5	160 - 180	120 - 150	
Turkey	4 - 6	140 - 160	150 - 240	

 FISH				
	 (kg)		 (°C)	 (min)
Whole fish	1 - 1.5	Turbo Grilling	180 - 200	30 - 50





11.13 Bread Baking







Use the second shelf position.

Preheating is not recommended.

 BREAD		
	 (°C)	 (min)
White bread	170 - 190	40 - 60
Baguette	200 - 220	35 - 45
Brioche	180 - 200	40 - 60
Ciabatta	200 - 220	35 - 45
Rye bread	170 - 190	50 - 70
Wholemeal bread	170 - 190	50 - 70
Whole grain bread	170 - 190	40 - 60
Bread rolls	190 - 210	20 - 35

11.14 Crispy baking with Pizza Function

 PIZZA		
 Use the first shelf position.		
	 (°C)	 (min)
Tarts	180 - 200	40 - 55
Spinach flan	160 - 180	45 - 60
Quiche lorraine / Swiss flan	170 - 190	45 - 55
Apple pie, covered	150 - 170	50 - 60





 PIZZA		
 Preheat the empty oven before cooking.		
 Use the second shelf position.		
	 (°C)	 (min)
Pizza, thin crust, use the deep pan	210 - 230	15 - 25
Pizza, thick crust	180 - 200	20 - 30
Unleavened bread	210 - 230	10 - 20
Puff pastry flan	160 - 180	45 - 55
Flammkuchen	210 - 230	15 - 25
Pierogi	180 - 200	15 - 25
Vegetable pie	160 - 180	50 - 60

11.15 Grill





Put a pan into the first shelf position to collect fat.





Preheat the empty oven before cooking.

Grill only thin pieces of meat or fish.

 GRILL	 (°C)	 (min) 1st side	 (min) 2nd side	
Beef fillet	230	20 - 30	20 - 30	3
Pork loin	210 - 230	30 - 40	30 - 40	2
Lamb saddle	210 - 230	25 - 35	20 - 25	3

11.16 Frozen Foods

	 (°C)	 (min)	
Pizza, frozen	200 - 220	15 - 25	2





	 (°C)	 (min)	
Pizza American, frozen	190 - 210	20 - 25	2
Pizza, chilled	210 - 230	13 - 25	2
Pizza snacks, frozen	180 - 200	15 - 30	2
French fries, thin	190 - 210	15 - 25	3
French fries, thick	190 - 210	20 - 30	3
Wedges / Croquettes	190 - 210	20 - 40	3
Hash browns	210 - 230	20 - 30	3
Lasagne / Cannelloni, fresh	170 - 190	35 - 45	2
Lasagne / Cannelloni, frozen	160 - 180	40 - 60	2
Baked cheese	170 - 190	20 - 30	3
Chicken wings	180 - 200	40 - 50	2

11.17 Defrost

Remove the food packaging and put the food on a plate.

Use the first shelf position.

Do not cover the food, as this can extend the defrost time.

	 (kg)	 (min) Defrosting time	 (min) Further de- frosting time	
Chicken	1	100 - 140	20 - 30	Put the chicken on an upturned saucer in a big plate. Turn halfway through.
Meat	1	100 - 140	20 - 30	Turn halfway through.
Meat	0.5	90 - 120	20 - 30	Turn halfway through.
Trout	0.15	25 - 35	10 - 15	-
Strawberries	0.3	30 - 40	10 - 20	-
Butter	0.25	30 - 40	10 - 15	-
Cream	2 x 0.2	80 - 100	10 - 15	Whip the cream when still slightly frozen in places.
Gateau	1.4	60	60	-

11.18 Preserving

Use the function Bottom Heat.

Use only preserve jars of the same dimensions available on the market.

Do not use jars with twist-off and bayonet type lids or metal tins.

Use the first shelf position.

Put no more than six one-litre preserve jars on the baking tray.



Fill the jars equally and close with a clamp.



The jars cannot touch each other.



Put approximately 1/2 litre of water into the baking tray to give sufficient moisture in the oven.

When the liquid in the jars starts to simmer (after approximately 35 - 60 minutes with one-litre jars), stop the oven or decrease the temperature to 100 °C (see the table).

Set the temperature to 160 - 170 °C.

 SOFT FRUIT	
	(min) Cooking time until simmering
Strawberries / Blueberries / Raspberries / Ripe gooseberries	35 - 45

 STONE FRUIT		
	(min) Cooking time until simmering	(min) Continue to cook at 100 °C
Peaches / Quinces / Plums	35 - 45	10 - 15

 VEGETABLES		
	(min) Cooking time until simmering	(min) Continue to cook at 100 °C
Carrots	50 - 60	5 - 10
Cucumbers	50 - 60	-
Mixed pickles	50 - 60	5 - 10
Kohlrabi / Peas / Asparagus	50 - 60	15 - 20



11.19 Dehydrating - True Fan Cooking

Cover trays with grease proof paper or baking parchment.



For a better result, stop the oven halfway through the drying time, open the door and let it cool down for one night to complete the drying.

For 1 tray use the third shelf position.



For 2 trays use the first and fourth shelf position.

 VEGETABLES		
	(°C)	(h)
Beans	60 - 70	6 - 8
Peppers	60 - 70	5 - 6
Vegetables for soup	60 - 70	5 - 6
Mushrooms	50 - 60	6 - 8
Herbs	40 - 50	2 - 3



Set the temperature to 60 - 70 °C.



 FRUIT	
	(h)
Plums	8 - 10
Apricots	8 - 10



 FRUIT	 (h)
Apple slices	6 - 8



 FRUIT	 (h)
Pears	6 - 9



11.20 Food Sensor



 BEEF	 Food core temperature (°C)		
	Rare	Medium	Well done
Roast beef	45	60	70
Sirloin	45	60	70



 BEEF	 Food core temperature (°C)		
	Less	Medium	More
Meatloaf	80	83	86



 PORK	 Food core temperature (°C)		
	Less	Medium	More
Ham / Roast	80	84	88
Saddle chop / Pork loin, smoked / Pork loin, poached	75	78	82



 VEAL	 Food core temperature (°C)		
	Less	Medium	More
Roast veal	75	80	85
Veal knuckle	85	88	90



 MUTTON / LAMB	 Food core temperature (°C)		
	Less	Medium	More
Mutton leg	80	85	88
Mutton saddle	75	80	85



 MUTTON / LAMB	 Food core temperature (°C)		
	Less	Medium	More
Roast lamb / Lamb leg	65	70	75



 GAME	 Food core temperature (°C)		
	Less	Medium	More
Hare saddle / Venison saddle	65	70	75
Hare leg / Hare, whole / Venison leg	70	75	80

 POULTRY	 Food core temperature (°C)		
	Less	Medium	More
Chicken	80	83	86
Duck, whole / half / Turkey, whole / breast	75	80	85
Duck, breast	60	65	70

 FISH (SALMON, TROUT, ZANDER)	 Food core temperature (°C)		
	Less	Medium	More
Fish, whole / large / steamed / Fish, whole / large / roasted	60	64	68



 CASSEROLES - PRE-COOKED VEGETABLES	 Food core temperature (°C)		
	Less	Medium	More
Zucchini casserole / Broccoli casserole / Fennel casserole	85	88	91

 CASSEROLES - SAVOURY	 Food core temperature (°C)		
	Less	Medium	More
Cannelloni / Lasagne / Pasta bake	85	88	91

 CASSEROLES - SWEET	 Food core temperature (°C)		
	Less	Medium	More
White bread casserole with / without fruit / Rice porridge casserole with / without fruit / Sweet noodle casserole	80	85	90

11.21 Moist Fan Baking - recommended accessories

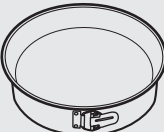

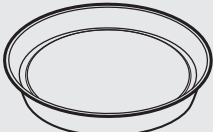
Use the dark and non-reflective tins and containers. They have better heat absorption than the light colour and reflective dishes.

			
Pizza pan	Baking dish	Ramekins	Flan base tin
Dark, non-reflective 28 cm diameter	Dark, non-reflective 26 cm diameter	Ceramic 8 cm diameter, 5 cm height	Dark, non-reflective 28 cm diameter

11.22 Moist Fan Baking







For the best results follow suggestions listed in the table below.







Use the third shelf position.







	 (°C)	 (min)
	Pasta gratin	200 - 220
Potato gratin	180 - 200	70 - 85
Moussaka	170 - 190	70 - 95
Lasagne	180 - 200	75 - 90
Cannelloni	180 - 200	70 - 85
Bread pudding	190 - 200	55 - 70
Rice pudding	170 - 190	45 - 60
Apple cake, made of sponge cake mixture (round cake tin)	160 - 170	70 - 80
White bread	190 - 200	55 - 70







11.23 Information for test institutes

Tests according to: EN 60350, IEC 60350.

 BAKING ON ONE LEVEL. Baking in tins				
		 (°C)	 (min)	
Fatless sponge cake	True Fan Cooking	140 - 150	35 - 50	2
Fatless sponge cake	Conventional Cooking	160	35 - 50	2
Apple pie, 2 tins Ø20 cm	True Fan Cooking	160	60 - 90	2
Apple pie, 2 tins Ø20 cm	Conventional Cooking	180	70 - 90	1

 BAKING ON ONE LEVEL. Biscuits				
 Use the third shelf position.				
		 (°C)	 (min)	
Short bread / Pastry strips	True Fan Cooking	140	25 - 40	
Short bread / Pastry strips, preheat the empty oven	Conventional Cooking	160	20 - 30	
Small cakes, 20 per tray, preheat the empty oven	True Fan Cooking	150	20 - 35	
Small cakes, 20 per tray, preheat the empty oven	Conventional Cooking	170	20 - 30	

 MULTILEVEL BAKING. Biscuits				
		 (°C)	 (min)	
Short bread / Pastry strips	True Fan Cooking	140	25 - 45	1 / 4
Small cakes, 20 per tray, preheat the empty oven	True Fan Cooking	150	23 - 40	1 / 4
Fatless sponge cake	True Fan Cooking	160	35 - 50	1 / 4

 GRILL				
 Preheat the empty oven for 5 minutes.				
 Grill with the maximum temperature setting.				
		 (min)		
Toast	Grill	1 - 3	5	
Beef steak, turn halfway through	Grill	24 - 30	4	

12. CARE AND CLEANING

 **WARNING!**
Refer to Safety chapters.

12.1 Notes on cleaning

	Clean the front of the oven with a soft cloth with warm water and a mild detergent.
	Use a cleaning solution to clean metal surfaces.
	Clean stains with a mild detergent.
Cleaning Agents	



Everyday Use

Clean the cavity after each use. Fat accumulation or other residue may cause fire.

Do not store the food in the oven for longer than 20 minutes. Dry the cavity with a soft cloth after each use.



Accessories

Clean all accessories after each use and let them dry. Use a soft cloth with warm water and a mild detergent. Do not clean the accessories in a dishwasher.

Do not clean the non-stick accessories using abrasive cleaner or sharp-edged objects.

12.2 How to remove: Shelf supports

Remove the shelf supports to clean the oven.

Step 1 Turn off the oven and wait until it is cold.

Step 2 Carefully pull the shelf supports up and out of the front catch.

Step 3 Pull the front end of the shelf support away from the side wall.

Step 4 Pull the supports out of the rear catch.

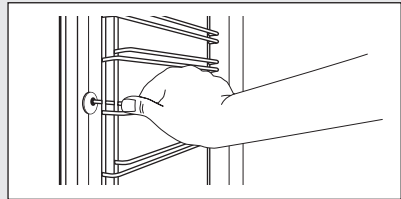

Install the shelf supports in the opposite sequence.

12.3 How to use: Pyrolytic Cleaning

Clean the oven with Pyrolytic Cleaning.



WARNING!
There is a risk of burns.



CAUTION!
If there are other appliances installed in the same cabinet, do not use them at the same time as this function. It can cause damage to the oven.

Before the Pyrolytic Cleaning:

Turn off the oven and wait until it is cold.

Remove all accessories.

Clean the oven floor and the inner door glass with warm water, a soft cloth and a mild detergent.

Do not fill the water tank during cleaning. It restarts the cleaning cycle.

Step 1	Turn on the oven.												
Step 2	Select: Menu / Cleaning / Cleaning. Press: OK.												
Step 3	Put the baking tray on the first shelf position to collect water from the water tank. OK - press to start water tank emptying.												
Step 4	When the tank emptying ends remove the baking tray and removable shelf supports. Wipe the oven cavity and the inner door glass with a soft cloth. Press: OK.												
Step 5	∧, ∨ - press to select the cleaning mode. Press: OK.												
	<table border="1"> <thead> <tr> <th>Option</th> <th>Cleaning mode</th> <th>Duration</th> </tr> </thead> <tbody> <tr> <td>Quick</td> <td>Light cleaning</td> <td>1 h</td> </tr> <tr> <td>Normal</td> <td>Normal cleaning</td> <td>1 h 30 min</td> </tr> <tr> <td>Intense</td> <td>Thorough cleaning</td> <td>3 h</td> </tr> </tbody> </table>	Option	Cleaning mode	Duration	Quick	Light cleaning	1 h	Normal	Normal cleaning	1 h 30 min	Intense	Thorough cleaning	3 h
Option	Cleaning mode	Duration											
Quick	Light cleaning	1 h											
Normal	Normal cleaning	1 h 30 min											
Intense	Thorough cleaning	3 h											
	<p>i When the cleaning starts, the oven door is locked and the lamp is off. To stop the cleaning before it is completed, turn off the oven. The oven stays locked until it is cold.</p>												

When the cleaning ends:

Turn off the oven and wait until it is cold.	Clean the cavity with a soft cloth.	Remove the residue from the bottom of the cavity.
--	-------------------------------------	---

12.4 Cleaning Reminder

When the reminder appears, cleaning is recommended.

Use the function: Pyrolysis.

You can enable and disable the reminder in the menu: Basic Settings .

12.5 How to use: Descaling

Before you start:

Turn off the oven and wait until it is cold.	Remove all accessories.	Make sure that the water drawer is empty.
--	-------------------------	---

Duration of the first part: around 100 min

Step 1 Place the deep pan on the first shelf position.

Step 2 Pour 250 ml of the descaling agent in the water drawer.

Step 3	Fill the remaining part of the water drawer with water to the maximum level until the signal sounds or the display shows the message.
Step 4	Select: Menu / Cleaning.
Step 5	Turn on the function and follow the instruction on the display. The first part of descaling starts.
Step 6	After the first part is over, empty the deep pan and put it back on the first shelf position.
Duration of the second part: around 35 min	
Step 7	Fill the remaining part of the water drawer with water to the maximum level until the signal sounds or the display shows the message.
Step 8	When the function ends, remove the deep pan.
 When this function works, the lamp is off.	

When descaling ends:

Turn off the oven.

When the oven is cold, dry the cavity with a soft cloth.

Leave the oven door open and wait until the cavity is dry.

 If some limestone residue remains in the oven after descaling, the display prompts to repeat the procedure.

12.6 Descaling reminder

There are two reminders which prompt you to descale the oven. You cannot disable the descaling reminder.

Type	Description
Soft reminder	Recommends you to descale the oven.
Hard reminder	Obligates you to descale the oven. If you do not descale the oven when the hard reminder is on, the steam functions are disabled.

 These reminders activate each time you turn off the oven.

12.7 How to use: Rinsing

Before you start:

Turn off the oven and wait until it is cold.

Remove all accessories.

Step 1 Place the deep pan on the first shelf position.

Step 2	Fill the water drawer with water to the maximum level until the signal sounds or the display shows the message.
Step 3	Select: Menu / Cleaning / Rinsing. Duration: around 30 min
Step 4	Turn on the function and follow the instruction on the display.
Step 5	When the function ends, remove the deep pan.
	When this function works, the lamp is off.

12.8 How to use: Tank Emptying

Use it after cooking with steam heating function to remove the residual water from the water drawer.

Before you start:	
Turn off the oven and wait until it is cold.	Remove all accessories.
Step 1	Place the deep pan on the first shelf position.
Step 2	Select: Menu / Cleaning / Tank Emptying. Duration: 6 min
Step 3	Turn on the function and follow the instruction on the display.
Step 4	When the function ends, remove the deep pan.
	When this function works, the lamp is off.

12.9 How to remove and install: Door

You can remove the door and the internal glass panels to clean it. The number of glass panels is different for different models.



WARNING!

The door is heavy.



CAUTION!

Carefully handle the glass, especially around the edges of the front panel. The glass can break.

Step 1	Fully open the door.	
Step 2	Lift and press the clamping levers (A) on the two door hinges.	
Step 3	Close the oven door to the first opening position (approximately 45° angle). Hold the door with one hand on each side and pull it away from the oven at an upwards angle. Put the door with the outer side down on a soft cloth on a stable surface.	
Step 4	Hold the door trim (B) on the top edge of the door at the two sides and push inwards to release the clip seal.	
Step 5	Pull the door trim to the front to remove it.	
Step 6	Hold the door glass panels on their top edge one by one and pull them up out of the guide.	
Step 7	Clean the glass panel with water and soap. Dry the glass panel carefully. Do not clean the glass panels in the dishwasher.	
Step 8	After cleaning, do the above steps in the opposite sequence.	
Step 9	Install the smaller panel first, then the larger and the door.	

12.10 How to replace: Lamp



WARNING!

Risk of electric shock.
The lamp can be hot.

Before you replace the lamp:

Step 1	Step 2	Step 3
Turn off the oven. Wait until the oven is cold.	Disconnect the oven from the mains.	Put a cloth on the bottom of the cavity.

Top lamp

Step 1 Turn the glass cover to remove it.

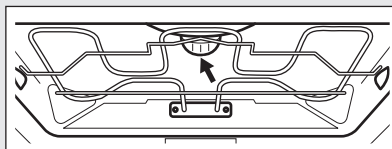

Step 2 Remove the metal ring and clean the glass cover.

Step 3 Replace the lamp with a suitable 300 °C heat-resistant lamp.

Step 4 Attach the metal ring to the glass cover and install it.

Side lamp

Step 1 Remove the left shelf support to get access to the lamp.

Step 2 Use a narrow, blunt object (e.g. a teaspoon) to remove the glass cover.

Step 3 Clean the glass cover.

Step 4 Replace the lamp with a suitable 300 °C heat-resistant lamp.

Step 5 Install the glass cover.

Step 6 Install the left shelf support.

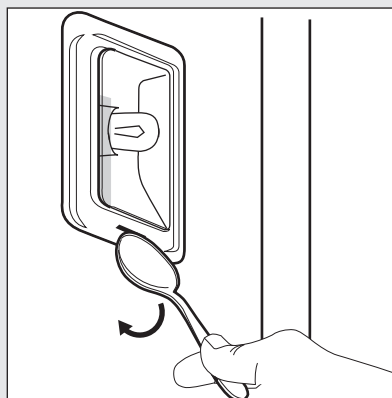
**13. TROUBLESHOOTING**

WARNING!
Refer to Safety chapters.

13.1 What to do if...

Problem	Possible cause	Remedy
You cannot activate or operate the oven.	The oven is not connected to an electrical supply or it is connected incorrectly.	Check if the oven is correctly connected to the electrical supply (refer to the connection diagram if available).
The oven does not heat up.	The oven is turned off.	Turn on the oven.
The oven does not heat up.	The clock is not set.	Set the clock.
The oven does not heat up.	The necessary settings are not set.	Make sure that the settings are correct.
The oven does not heat up.	The automatic switch-off is on.	Refer to "Automatic switch-off".
The oven does not heat up.	The Child Lock is on.	Refer to "Using the Child Lock".
The oven does not heat up.	The fuse is blown.	Make sure that the fuse is the cause of the malfunction. If the fuse is blown again and again, contact a qualified electrician.
The lamp does not operate.	The lamp is defective.	Replace the lamp.
The food sensor does not operate.	The plug of the food sensor is not correctly installed into the socket.	Put the plug of the food sensor as far as possible into the socket.
The display shows F111.	The plug of the food sensor is not correctly installed into the socket.	Put the plug of the food sensor as far as possible into the socket.
The display shows an error code that is not in this table.	There is an electrical fault.	<ul style="list-style-type: none"> • Turn off the oven with the house fuse or the safety switch in the fuse box and turn it on again. • If the display shows the error code again, contact the Customer Care Department.
Steam and condensation settle on the food and in the cavity of the oven.	You left the dish in the oven for too long.	Do not leave the dishes in the oven for longer than 15 - 20 minutes after the cooking process ends.
The appliance is activated and does not heat up. The fan does not operate. The display shows " Demo ".	The demo mode is activated.	Refer to "Daily Use chapter, Basic Settings.

Problem	Possible cause	Remedy
The descaling procedure is interrupted before it finishes.	There was a power cut.	Repeat the procedure.
The descaling procedure is interrupted before it finishes.	The function was stopped by the user.	Repeat the procedure.
There is no water inside the grill- / roasting pan after the descaling procedure.	You did not fill the water drawer to the maximum level.	Check if the a descaling agent / water is present in the water drawer body. Repeat the procedure.
There is dirty water on the bottom of the cavity after the descaling cycle.	The grill- / roasting pan is on a wrong shelf position.	Remove the residual water and the descaling agent from the bottom of the oven. Put the grill- / roasting pan on the first shelf position.
The cleaning function is interrupted before it finishes.	There was a power cut.	Repeat the procedure.
The cleaning function is interrupted before it finishes.	The function was stopped by the user.	Repeat the procedure.
There is no good performance of the cleaning procedure.	You did not remove the side grids before the start of the cleaning procedure. They can transfer heat to the walls and decrease the performance.	Remove the side grids from the appliance and repeat the function.

13.2 Service data

If you cannot find a solution to the problem yourself, contact your dealer or an Authorised Service Centre.

The necessary data for the service centre is on the rating plate. The rating plate is on the front frame of the oven cavity. Do not remove the rating plate from the oven cavity.

We recommend that you write the data here:	
Model (MOD.)
Product number (PNC)
Serial number (S.N.)

14. ENERGY EFFICIENCY

14.1 Product Information Sheet according to UK Ecodesign and Energy Labelling Regulations

Supplier's name	AEG
-----------------	-----

Model identification	BSE774320M 944187889 BSK774320M 944187875	
Energy Efficiency Index	81.2	
Energy efficiency class	A+	
Energy consumption with a standard load, conventional mode	1.09 kWh/cycle	
Energy consumption with a standard load, fan-forced mode	0.69 kWh/cycle	
Number of cavities	1	
Heat source	Electricity	
Volume	71 l	
Type of oven	Built-In Oven	
Mass	BSE774320M	40.5 kg
	BSK774320M	40.5 kg

BS EN 60350-1 - Household electric cooking appliances - Part 1: Ranges, ovens, steam ovens and grills - Methods for measuring performance.

14.2 Energy saving



The oven has features which help you save energy during everyday cooking.

Make sure that the oven door is closed when the oven operates. Do not open the oven door too often during cooking. Keep the door gasket clean and make sure it is well fixed in its position.

Use metal cookware to improve energy saving.

When possible, do not preheat the oven before cooking.

Keep breaks between baking as short as possible when you prepare a few dishes at one time.

Cooking with fan

When possible, use the cooking functions with fan to save energy.

Residual heat

If a programme with the Duration or End Time selection is activated and the cooking time is longer than 30 min, the

heating elements automatically turn off earlier in some oven functions.

The fan and lamp continue to operate. When you turn off the oven, the display shows the residual heat. You can use that heat to keep the food warm.

When the cooking duration is longer than 30 min, reduce the oven temperature to minimum 3 - 10 min before the end of cooking. The residual heat inside the oven will continue to cook.

Use the residual heat to warm up other dishes.

Keep food warm

Choose the lowest possible temperature setting to use residual heat and keep a meal warm. The residual heat indicator or temperature appears on the display.

Cooking with the lamp off

Turn off the lamp during cooking. Turn it on only when you need it.

Moist Fan Baking

Function designed to save energy during cooking.

When you use this function the lamp automatically turns off after 30 sec. You may turn on the lamp again but this

action will reduce the expected energy savings.

15. ENVIRONMENTAL CONCERNS

Recycle materials with the symbol . Put the packaging in relevant containers to recycle it. Help protect the environment and human health by recycling waste of electrical and electronic appliances. Do not dispose of

appliances marked with the symbol  with the household waste. Return the product to your local recycling facility or contact your municipal office.

www.aeg.com/shop



OK

867370606-A-342021

AEG

Free Manuals Download Website

<http://myh66.com>

<http://usermanuals.us>

<http://www.somanuals.com>

<http://www.4manuals.cc>

<http://www.manual-lib.com>

<http://www.404manual.com>

<http://www.luxmanual.com>

<http://aubethermostatmanual.com>

Golf course search by state

<http://golfingnear.com>

Email search by domain

<http://emailbydomain.com>

Auto manuals search

<http://auto.somanuals.com>

TV manuals search

<http://tv.somanuals.com>