

97-0737

Aboveground Pool Installation Manual

Aries Round Pool

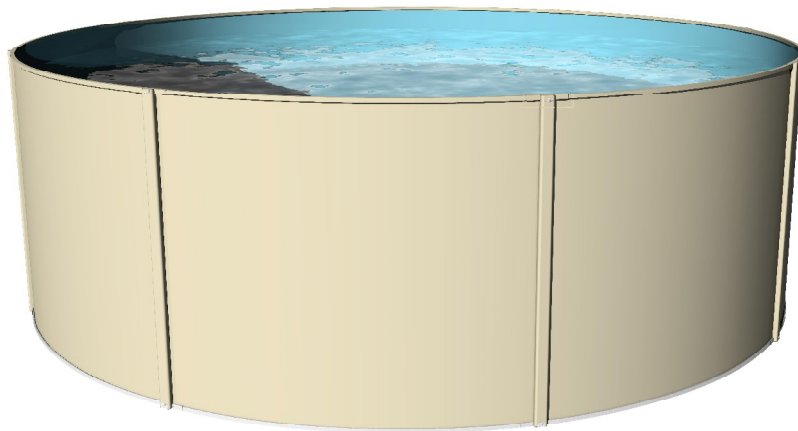

This manual must be left with the pool owner

www.wilbargroup.com

WILBAR
GROUP

Section 1

GENERAL INSTRUCTIONS – ROUND POOL GROUND PREPARATION Safety Rules for Pool Owners



Your pool contains a large quantity of water, and is deep enough to present inherent dangers to life and health unless the following safety rules are strictly observed. First-time users run the highest risk of injury. Make sure everyone understands all safety rules before entering the pool. Post no diving and no jumping signs beside the pool.

For additional safety information please consult Section 3.



1. No Jumping or Diving

The top rail of your pool is not a walkway and must not be used for jumping or diving. Do not permit jumping or diving into the pool from a deck or the top rail of the pool. Diving or jumping into the pool can result in serious injury.

2. Never use the Pool Alone

Never permit the pool to be used unless it is attended by at least one person other than the bather. Someone should always be available to lend assistance in an emergency.

3. Never Leave Children Unattended

Never leave a child alone and unsupervised in or near the pool—not even for a second. There is no substitute for constant adult supervision.

4. No “Rough-housing”

Do not permit “rough-housing” in and around your pool. Surfaces can become slippery and hazardous when wet.

5. Light the Pool at Night

If the pool is used after dusk, adequate lighting must be provided. Illumination in the pool area must be sufficient to clearly judge pool depth and all features in and around the pool. For lighting recommendations, consult your local licensed electrical contractor.

6. Restrict Access to the Pool

Do not leave chairs or other furniture beside the pool that could be used by a child to climb up into the pool. Ladders must be removed whenever the pool is unattended. A fence with a lockable gate around the pool or yard is strongly recommended and may be required by law in some jurisdictions.

7. No Alcohol or Drugs

The use of alcohol or drugs does not mix with pool activities. Persons who have been drinking alcohol or using any drugs should not be allowed in the pool, and should be carefully supervised in the surrounding area.

8. Keep Your Pool Clean and Sanitary

Your filter system will remove suspended particles from the water and the surface skimmer will remove insects, leaves and other debris from the water surface. Use the correct pool chemicals as directed to destroy harmful bacteria and prevent formation of algae. Remember, unsanitary water is a serious health hazard.



A. INTRODUCTION TO INSTALLING YOUR POOL

Read all instructions completely before you begin.

These instructions explain how to install your pool. Simply follow the step-by-step directions. Start with this part, **SECTION 1** and use the other instructions, **SECTION 2** to put together your entire pool.

SECTION 3 also has **Safety Rules** and instructions to help you keep your pool clean and in good shape, year after year. Be sure to read the **Safety Rules**, and make sure everyone who uses your pool reads and understands them.

Important Note: 

Ground preparation is one of the most important steps in the installation process.

A proper foundation will ensure the rest of the pool assembly goes smoothly and that no problems will occur when the pool is filled with water.

B. DETERMINE THE LOCATION OF YOUR POOL

1. The Terrain

Pay special attention to choosing the right location for your pool:

- Choose a large area, as flat and level as possible and well drained. (Image 1)
- Choose a spot on dry, firm earth (stabilizer or other)—**do not** install the pool on asphalt, tar paper, sand, gravel, peat moss, wood or chemically treated soil.
- Check with your pool dealer to see if Nut Grass grows in your area. This type of grass may grow up through your pool liner. Your dealer will be able to advise how best to treat the site.
- Sloped areas will need to be made level by digging away high spots, **not** by filling low spots—be prepared to hire earth-moving equipment if necessary. (Image 2)

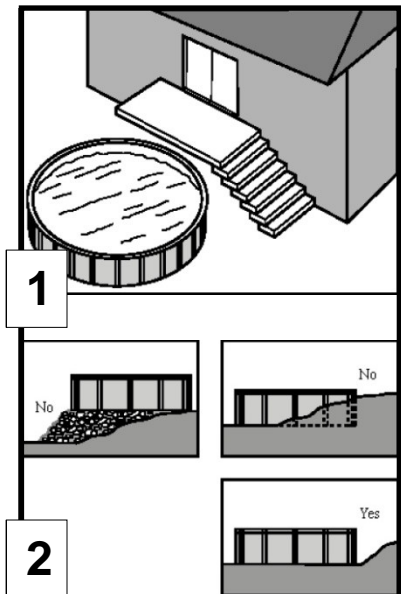

2. Things to Avoid

Do not locate your pool near or on any of the following:

- Overhanging tree branches.
- Overhead wires and clotheslines. *(Image 3)*
- Buried pipes and wires. Contact your gas, electric and telephone utilities to find buried pipes and wires **before** you dig.
- Hilly and uneven terrain.
- Areas with poor drainage.
- Grass, stones and roots. Grass will rot underneath the pool liner, and stones and roots will damage the pool liner.
- Areas recently treated with oil-based weed killers, chemicals or fertilizers.

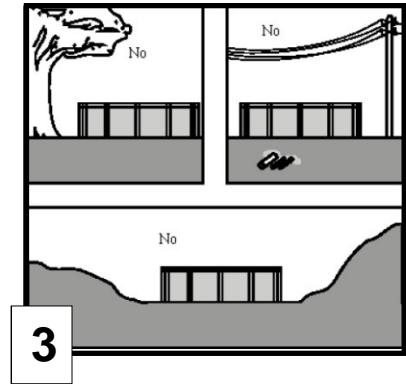

3. Plan Ahead

- Will you be adding an adjacent deck later? Be sure to leave room.
- Will you be using pool accessories or other appliances that need electricity or gas? Locate your pool near these services or plan to have them installed later by a licensed contractor.

Important

When locating the centre of the pool, be sure to take into consideration any structures (deck, patio, house) or relevant items (change rooms, gazebo, etc.) that the pool may need to line up with and ensure that the pool is in the most visual pleasing location for your property.



Tools Needed

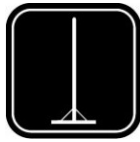

Compactor



Hammer



Water hose

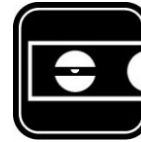

Level



File



Vacuum cleaner



Pliers

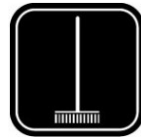

Rake



Lawn roller



Metal snips



Screwdriver



Wheelbarrow



Shovel



Spray paint



Mallet



Measuring tape



Duct tape



Trowel



Wrench

List of required materials:

- Straight wood plank
- Material that provides a permanent base (ex. Rockdust)
- Fine sand (void of debris)
- Cement blocks (20cm x 40cm x 45cm / 8"x16"x18") (optional)
- Cardboard
- Wood board (30cm x 30 cm / 1ft x 1ft)
- Vinyl covered hooks
- String and stakes
- Prefabricated cove sections (optional)
- Pool carpeting (optional)



C. PREPARE THE FOUNDATION OF YOUR POOL

1. Mark out the Area

- a. Drive a peg into the ground at the **centre** of the area where you want your pool. (Image 4)

Important Note:



Your pool must be perfectly levelled. Take the time you need to be sure your foundation is perfectly levelled.

- b. Use a length of string tied between the peg and a can of spray paint, and mark a circle on the ground (a tape measure can also be used). The circle will be 8" (20 cm) bigger all round than the pool. (Image 5)

2. Remove the sod

- a. Remove all sod and plants from the circle. (Image 6)
- b. Remove any sticks, stones and roots from the circle using a rake.
- c. To make sure your pool is stable, compact the ground well before adding the sand.

3. Make the Area Flat and Level

- a. Replace the centre peg with a flat-topped stake, at least 1" (25 mm) square and 6" (15 cm) long. Drive it down flush with the ground surface.
- b. Nail one end of a **straight** 2-by-4 (5cm x 10cm) wood plank to the top of the stake. Use a nail long enough to hold the end of the 2-by-4 (5cm x 10cm) wood plank to the stake while you rotate it in a circle. (Image 7)

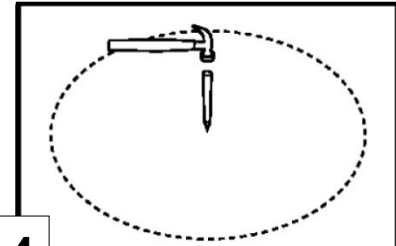

4

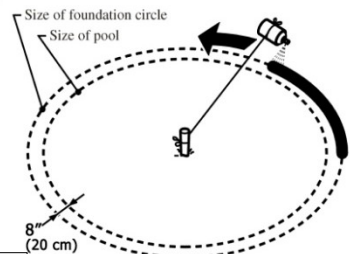

5

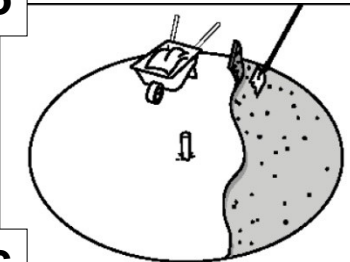

6

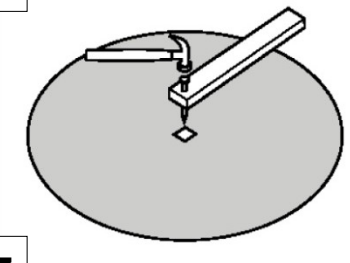

7



CONT. C. PREPARE THE FOUNDATION OF YOUR POOL

- c. Put a carpenter's level on the wood plank and swing the board in a circle to find the high and low spots. (Image 8)

- d. Remove all the high spots with a shovel, hoe or rake. Be prepared to hire earth moving equipment if you need to level a large area. Remember, your pool **must** be level within 1" (25 mm) across the diameter of the pool. (Image 9 & 10)

- e. **Do not** fill in low areas. Filling will create an unsafe foundation for your pool. Small dips and hollows may be filled in, but the soil **must** be hard-packed with a tamping tool. (Image 11)

- f. Take material such as rock dust or fine mortar that can conform a solid, permanent base and deposit this material around the rim of the basin. The material used should be spread around the perimeter of the pool to a width of 24" (60cm) and a thickness of 2" (5cm). (Image 12)

- g. Recheck the outer of the circle, where the pool wall will be. Make sure there are no high or low spots. The bottom edge of the pool wall **must** rest flat on the ground and have no gaps under it. (Image 13)

Important Note: 

The outer 24" (60cm) of the circle must be perfectly flat. The bottom edge of the pool **must** rest flat on the ground and have no gaps under it. Take the time you need to be sure this area is perfectly flat and levelled.

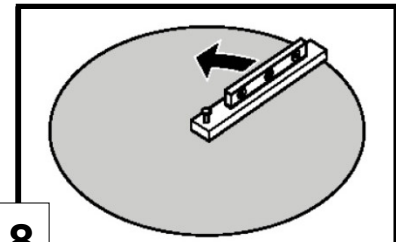

8

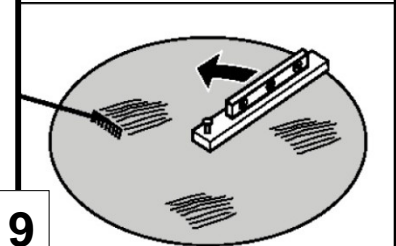

9

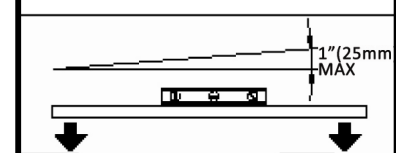

10

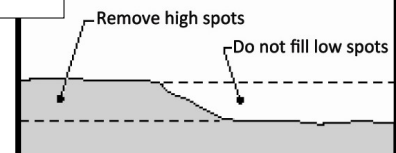

11

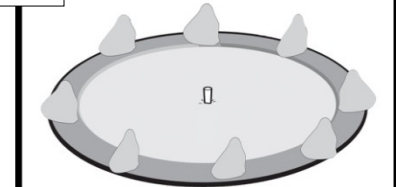

12

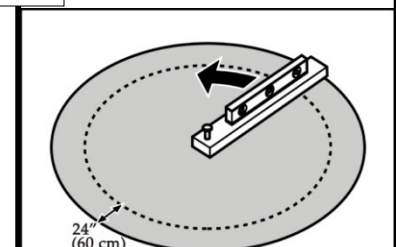

13



CONT. C. PREPARE THE FOUNDATION OF YOUR POOL

4. Patio Stones

- a. Place concrete patio stones at the base of each upright of your pool. Patio stones 12" (30 cm) or larger will do. Round patio stones will also work.
- b. Temporarily lay out the bottom rails and bottom plates around the circle. Each bottom plate will show the location for a patio stone. Make a mark in the ground at each base plate. *(Image 14)*
- c. Remove the bottom rails and base plates and lay out the patio stones around the circle where the base plates were. *(Image 15)*
- d. The patio stones **must** be sunk into the ground so the tops are flush with the soil around them. Use the carpenter's level to make sure the patio stones are perfectly level and flush with the ground. Use the carpenter's level and a 2-by-4 (5cm x 10cm) wood plank between patio stones to make sure the stones are level with each other. *(Image 16)*

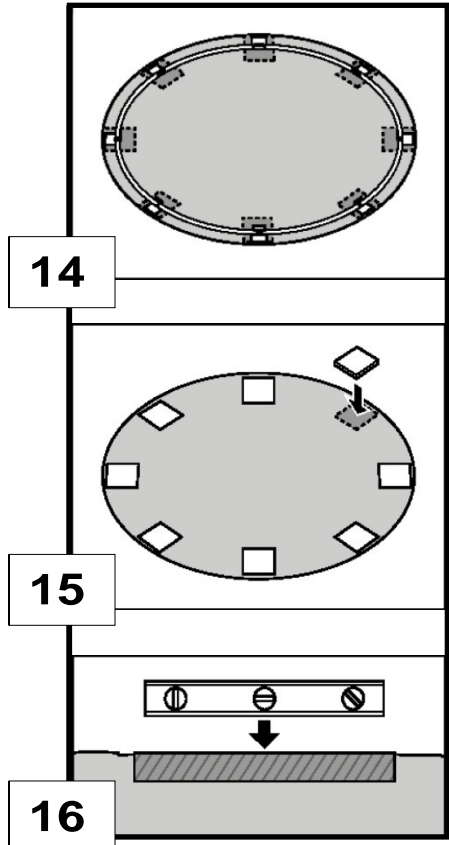

5. Proceed to Section 2



Section 2

A. ASSEMBLING THE POOL BASE

1. Lay out the bottom plates and bottom rails.

- a. Place the bottom plates equally spaced around the perimeter of your foundation. Place one base plate on each stone. *(Image 1)*
- b. The bottom rails and the bottom plates of the Aries pool are galvanized steel. This means they have a silver colour. **DO NOT use the painted connectors and rails.** These go on top of the pool.
- c. Insert the end of each bottom rail into a bottom plate. Leave a gap of 2-1/8" (55 mm) between the ends of the bottom rails. *(Image 2, 3 & 4)*
- d. Measure the diameter of your pool all around the circle and make sure it is correct. **Note:** this measurement should be taken from centre to centre of the bottom rail. When the circumference is perfectly round, hammer nails into the ground to keep the bottom rails into place. These nails are to be removed only at the last step-when filling up the pool. *(Image 5)*

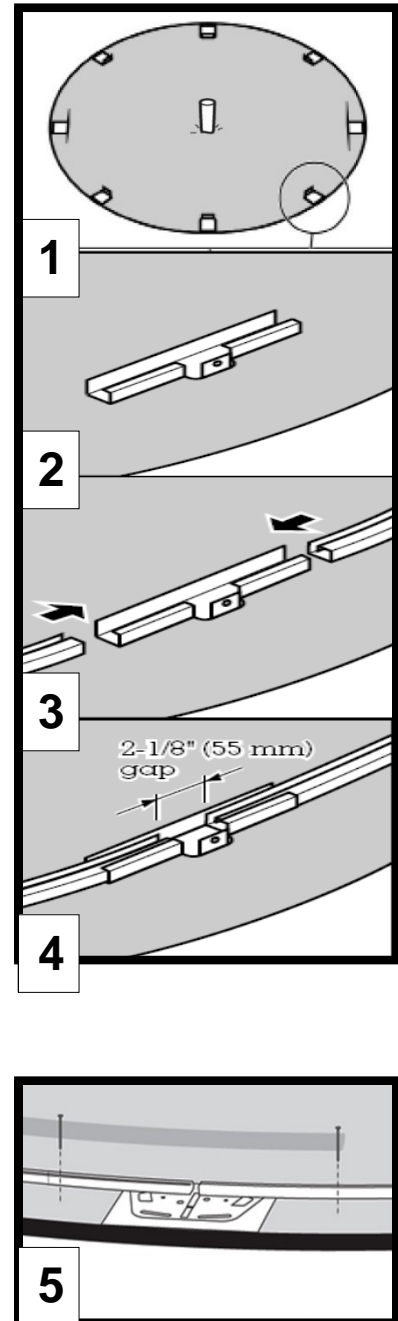

A. CONT. ASSEMBLING THE POOL BASE

Important Note: 

It is preferable to use very fine sand that is easily compacted. Be careful not to spill sand on the bottom rails.

2. Spread out brick sand.

- a. Spread a layer of fine brick sand (no pebbles) over the foundation area, 2" (5 cm) deep. Use a rake to make the brick sand flat and smooth. (*Image 6*)
- b. Wet the sand and pack it down with a lawn roller or other type of compactor. Using a trowel, smooth the surface. Remove the stake at the center, fill in the hole with sand and smooth the surface with a trowel.

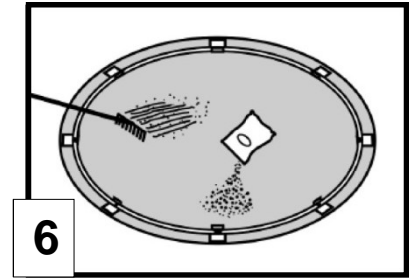

B. ASSEMBLING THE POOL WALL & LINER

Do not attempt to install the pool wall in the wind, wait for a calm day. It takes at least 3 people to install the pool wall.

Important Note:



Bring the following items onto the pool foundation **before** you start uncoiling the pool wall: cardboard or plywood, some extra sand to make the cover and a ladder to climb out after the wall is assembled.

Important Note:



Make sure the skimmer and water return holes are located where you need them to be.

1. Set the pool wall in place.

- Unpack the coiled pool wall and stand it on a piece of cardboard or plywood at the centre of the pool. The cut-outs for the through-the-wall skimmer should be towards the top of the wall. (Image 1)
- Start uncoiling the wall, guiding the bottom edge into the curved bottom rail. The starting end of the wall must be positioned in the centre of a bottom plate, and the skimmer and return holes should be positioned where the pump and filter will be. (Image 2 & 3)
- Set lengths of stabilizer onto the top edge of the wall as you uncoil it. We also suggest installing vinyl-covered hooks and rope to hold the wall steady. Ideally the help of several people should be solicited to hold the wall in place. Work around the foundation until the entire pool wall is uncoiled into the bottom rails. (Image 4)

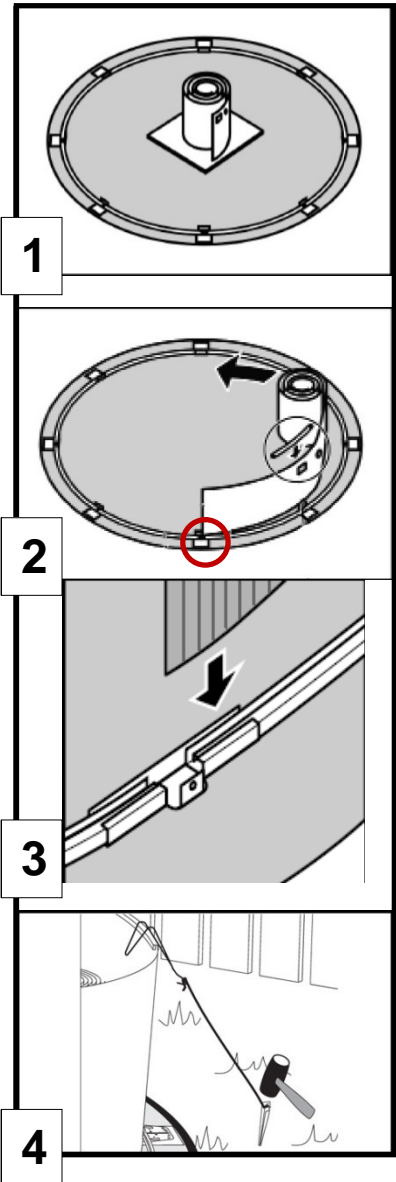

Important Hint

For **best results**, mount the skimmer on the **downwind** side of the pool (that is, directly across from the most common wind direction).



B. CONT. ASSEMBLING THE POOL WALL & LINER

2. Join the ends of the pool wall.

- a. Line up the holes in the two ends of the pool wall. (Image 5)
- b. Now that you have installed the wall you can be faced with three scenarios.

1) The wall joints align perfectly, if so, move on to the next step.

2) Your wall appears to be too short. It is not. However the space between the bottom rails must be decreased by lightly tapping the bottom plates towards the inside of the pool. You can also tap the wall lightly with both hands in the desired direction. (Image 6)

3) Your wall appears too long. It is not. However the space between the bottom rails must be increased by tapping the bottom plates lightly towards the outside of the pool or by tapping the wall with both hands in the desired direction. (Image 7)

WARNING: Bottom rails must always be held in place in the bottom plate.

- c. A wall bar must be used both inside and outside of the pool wall joint where the two ends of the wall are jointed together. (Image 8)

Important Note: 

Stick a screwdriver through two of the holes to help line up the ends of the wall.

Important Hint: 

Ensure that all bolts and all the holes are used.

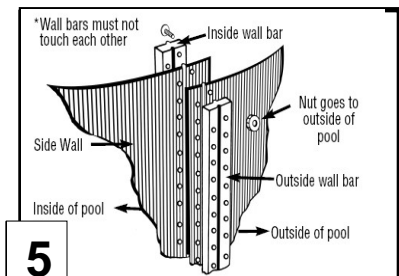

5

6

7

8

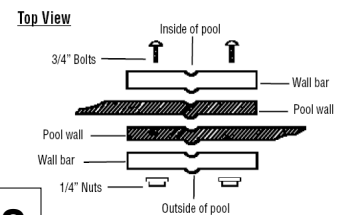

B. CONT. ASSEMBLING THE POOL WALL & LINER

- d. Cover the seam and bolt heads on the inside/interior of the pool wall completely with 2" (50mm) duct tape. (Image 9)

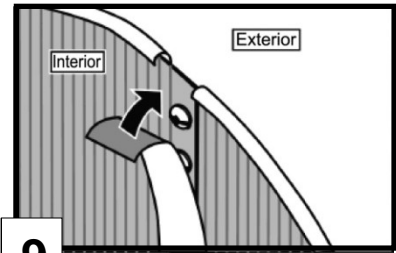

9

3. Make sure the pool wall is level.

- a. Use a length of string and a line-level to check across the top edge of the pool wall to see if it is level. Check the wall in several different directions. The wall must be level. If the level is off by more than 1" (25 mm) across the diameter of the pool, take the wall apart and level the foundation again. (Image 10 & 11)

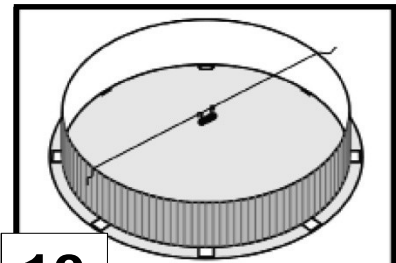

10

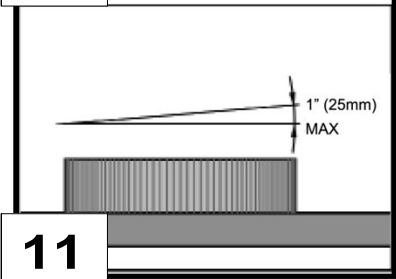

11

4. Make sure the pool wall is round

- a. Using a tape measure, measure across the circle at each bottom plate. The pool wall must be round within 1" (25 mm) (all of the measurements must be within 1" (25 mm) of each other). Adjust the circle by nudging the base plates in or out with your foot. (Image 12)
- b. Adjusting the pool to the proper shape may cause the bottom rails and bottom plates to slip out of alignment a little. Recheck all of the bottom plates to make sure each one is centred where the bottom rails meet. (Image 13)

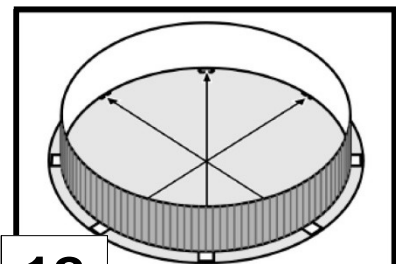

12

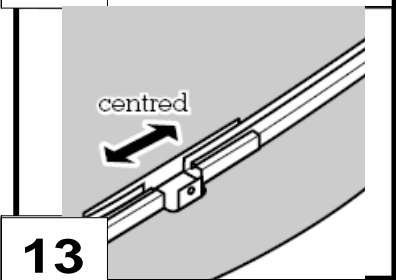

13

Important Note:



The pool **must** be levelled within 1" (25 mm) across the diameter. A pool that is not levelled is dangerous and may collapse.



B. CONT. ASSEMBLING THE POOL WALL

5. Make a cove

a. If you are using sand, bank the sand against the wall to form a cove of 6" (15.24cm) high and 6" (15.24cm) wide at ground level. Water the sand to compact it and use a trowel to spread it evenly. (Image 14)

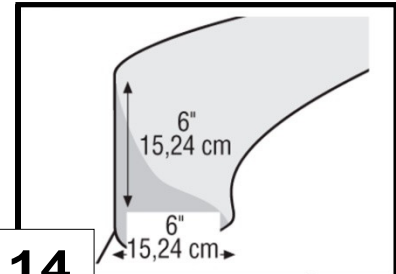

14

b. If you are using styrofoam instead of brick sand, you can now install the sheets of styrofoam in the centre of the pool and join them with duct tape along the whole length of each seam. Remember to wait until the pool wall has been installed before installing the styrofoam.

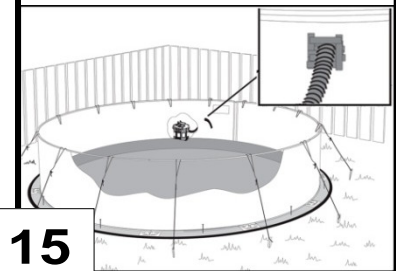

15

c. A vacuum cleaner can later be used to remove the air from between the liner and the wall. This technique enables you to remove folds in the liner. However the following precautions should be taken:

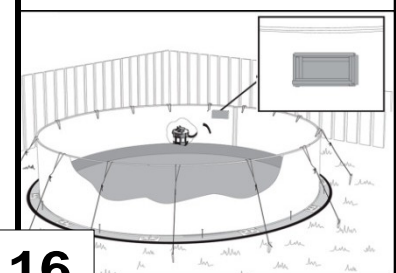

16

- Do not use an industrial vacuum cleaner which could be too powerful.
- Tape the end of the vacuum hose before inserting it into the wall so as not to damage the liner.
- Insert the nozzle until it is about 4" (10cm) above the cove (insert through the water return outlet or the skimmer depending on the diameter of your hose). Make sure you will be able to remove the hose later on.
- Tape the hose to the wall.

(Image 15)

d. Close the skimmer opening with cardboard and adhesive tape to prevent air from escaping. (Image 16)

Important Note: 

The cove is an important part of the pool structure. Take your time to make a complete, full-size cove.



C. INSTALL THE POOL LINER

Important

Note:



If possible, unfold the liner on the grass one to two hours before installation. **Be careful** not to leave the liner too long or you may damage the grass.

Important

Hint:



The liner is generally smaller than the support structure of the pool. It will stretch more easily when warm. It is important that the liner is installed on a warm sunny day.

1. Set the liner in place

- Open the carton. Do not use anything sharp to open the carton.
- Unpack and unfold the liner and spread it out in the sun to warm it up. Inspect all the seams and surfaces for holes.
- Remove your shoes to avoid damaging the base or tearing the liner.
- Spread out the liner, smooth side down. The curved seam should be centred on the cove at the base of the wall. The other seams will form straight lines across the bottom of the pool. (Image 1 & 2)
- Smooth out all the wrinkles in the bottom.

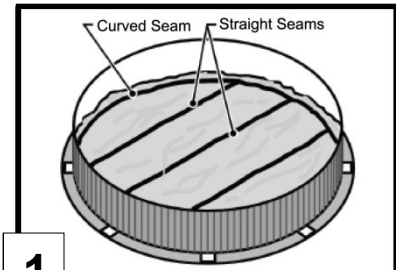

1

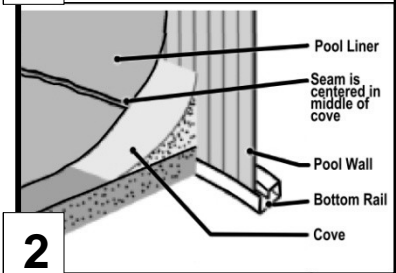

2

2. Fasten the liner in place (OVERLAP ONLY)

- Remove stabilizers gradually as you fold the liner over the top of the wall. Note: We suggest an overlap of 6" to 8" (15 to 20cm). (Image 3)
- Fasten the liner to the top of the wall with plastic coping. Let the liner hang slack for now. **Do not** pull the liner tight.

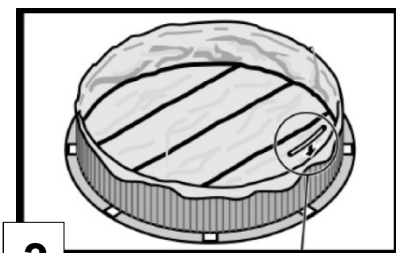

3

- Turn the vacuum cleaner on and push the liner outward with your feet to iron out any wrinkles. Once finished, turn off vacuum cleaner.
- Start filling the pool with water. As the pool fills, work out all the wrinkles and smooth the liner to the wall. Remove the plastic coping around the top edge of the wall one piece at a time and adjust the liner. Keep smoothing out the wrinkles.



CONT. C. INSTALL THE POOL LINER

Important Note: 

Do not trim off the excess liner. (If the liner ever needs to be removed, trimming the liner will make re-installation very difficult.) Instead, roll up any excess liner and tape it in place near the top of the pool wall.

- e. After all the wrinkles in the liner are removed, trim any extra length of plastic coping so there is no overlap. (Image 4)

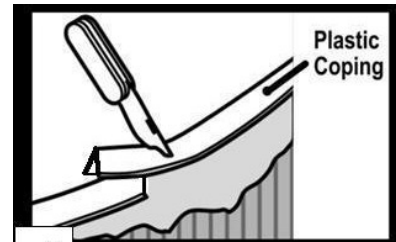

- f. Roll up any excess liner hanging below the plastic coping and tape it in place near the top of the pool wall.

Important: Do not trim off the excess liner. (Image 5)

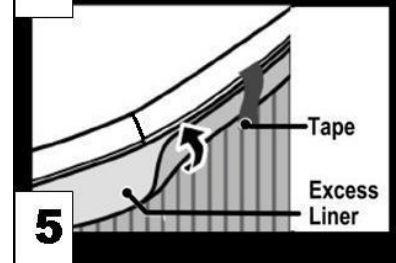

3. Fasten the liner in place (BEADLOCK LINER ONLY)

- a. Remove stabilizers gradually as you install the liner receptors (A) onto the wall. Hang the liner into the molded slot (B) of the receptors. Secure the liner in place with the locking device (C). (Optional)

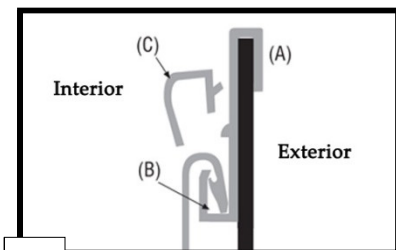

4. Fasten the liner in place (HUNG LINER ONLY)

- a. Remove the stabilizer gradually from the top edge of the pool wall.
- b. Hook the V-bead over the edge of the pool wall.
- c. Replace the stabilizer.

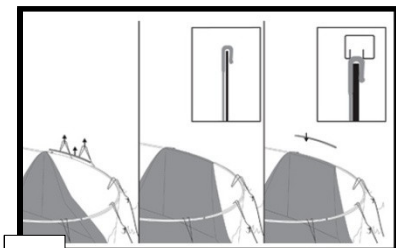

- d. Repeat steps (a) to (c) until you have gone around the entire pool and finished attaching the pool liner in place.

- e. Start filling the pool with water. As the pool fills, work out all the wrinkles and smooth the liner to the wall.



D. INSTALLING THE TOP LEDGES, UPRIGHTS & LEDGE COVERS

1. Continue filling your pool

- a. Continue filling your pool with water. Do not put in more than 12" (30cm) of water until the top ledges and uprights are all attached.
- b. Keep working on the top ledges and uprights while the pool fills.

2. Install the uprights

- a. Line up the bottom of one vertical column (key 1) with the tab on one base plate (key 2). The tab must be on the **outside** of the vertical column.

- b. Line up the screw holes and fasten with one screw (key 3).

- c. Place a top connector (key 4) over the top edge of the pool wall (key 5) with the tab on the outside of the pool. Line up the hole in the tab with the screw hole near the top of the vertical column. The tab must be on the **outside** of the vertical column. Make sure the vertical column is straight up and down.

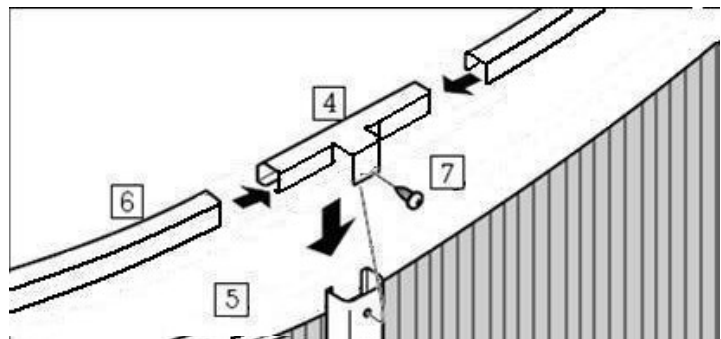
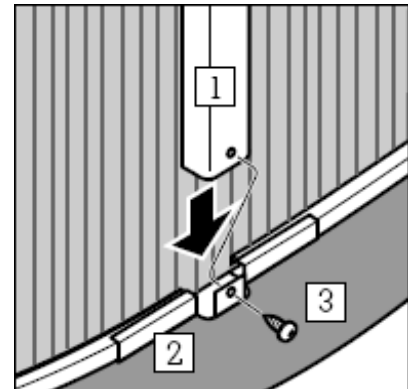

- d. Slide one end of a top rail (key 6) into the top connector.
- e. Fasten the top connector to the vertical column with one screw (key 7).
- f. Repeat the last five steps for each of the vertical columns around the pool wall.

Important Note: 

Use the ridges in the pool wall to make sure the upright column is straight up and down.



D. INSTALLING THE TOP LEDGES, UPRIGHTS & LEDGE COVERS

- g. Make the pool settle into a perfect circle by pushing the top of the pool wall **vigorously** inward at each vertical (this will help make the bottom of the pool wall shift into a perfect circle).



Parts List - ARIES

Part Number	Wilbar Description	12'	15'	18'	21'	24'
Top Tracks (PAINTED)						
36863	BTM RAIL PTD 6'0"R 53-15/16" (5/8" STL)	8				
36864	BTM RAIL PTD 7'5"R 53-15/16" (5/8" STL)		10			
36865	BTM RAIL PTD 9'0"R 53-13/16" (5/8" STL)			12		
36866	BTM RAIL PTD 10'5"R 54-3/8" (5/8" STL)				14	
36867	BTM RAIL PTD 12'0"R 54-1/16" (5/8" STL)					16
Uprights						
37557	UR 2" STL ALI PEARL SUNRAY 47-5/8"	8	10	12	14	16
37558	UR 2" STL ALI PEARL SUNRAY 51-5/8"	8	10	12	14	16
Bottom Rails						
NLR-1460061	BTM RAIL 6'0"R 53-15/16" (5/8" STL)	8				
NLR-1460062	BTM RAIL 7'5"R 53-15/16" (5/8" STL)		10			
NLR-1460063	BTM RAIL 9'0"R 53-13/16" (5/8" STL)			12		
NLR-1460066	BTM RAIL 10'5"R 54-3/8" (5/8" STL)				14	
NLR-1460064	BTM RAIL 12'0"R 54-1/16" (5/8" STL)					16

Bottom Plate						
NLR-1320103	BOTTOM PLATE 2" STL SUNRAY	8	10	12	14	16
Top Cap Connector (PAINTED)						
36868	TC 5/8" CONNECTOR ALI PEARL ARIES	8	10	12	14	16

Hardware						
99-0114	SCREW #12X5/8" PHIL PAN ZY PTD PEARL HEA	16	20	24	28	32

No Diving or Jumping. Observe all Safety Rules.



Exploded view - ARIES

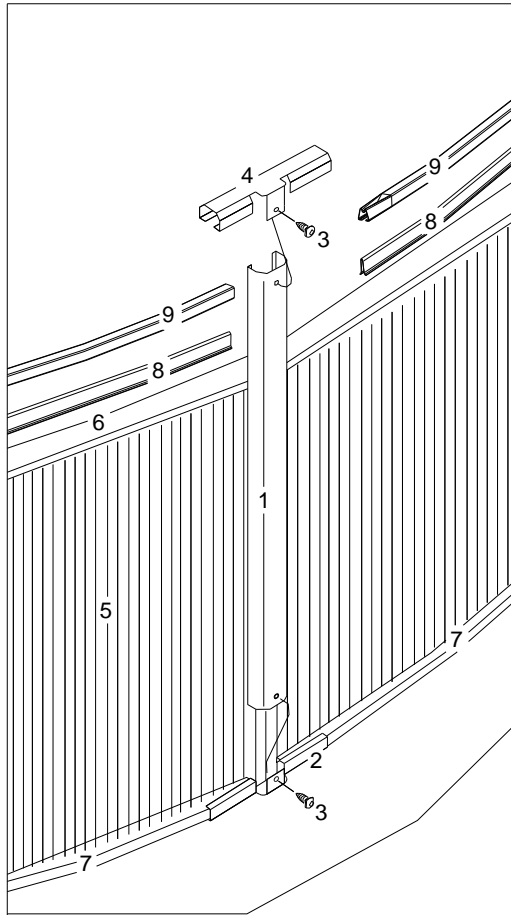

- 1 Upright
- 2 Bottom Connector - Silver
- 3 Screw
- 4 Top Connector - Painted
- 5 Pool Wall
- 6 Liner
- 7 Bottom Rail - Silver
- 8 Plastic Liner Coping
- 9 Top Rail - Painted

No Diving or Jumping. Observe all Safety Rules.



Free Manuals Download Website

<http://myh66.com>

<http://usermanuals.us>

<http://www.somanuals.com>

<http://www.4manuals.cc>

<http://www.manual-lib.com>

<http://www.404manual.com>

<http://www.luxmanual.com>

<http://aubethermostatmanual.com>

Golf course search by state

<http://golfingnear.com>

Email search by domain

<http://emailbydomain.com>

Auto manuals search

<http://auto.somanuals.com>

TV manuals search

<http://tv.somanuals.com>