

ASUS®

**VG278 Series
LCD Monitor**

User Guide

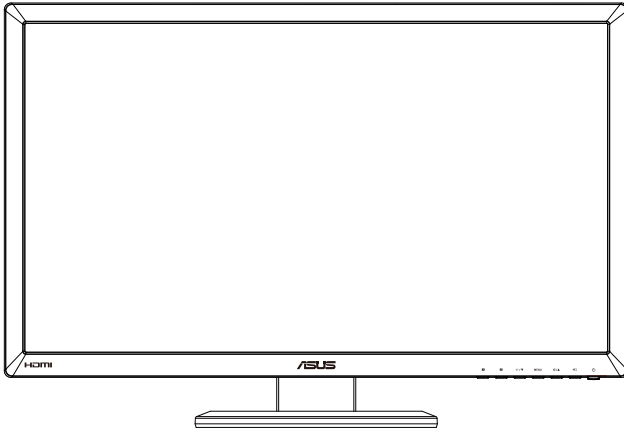

Table of contents

- Notices..... iii
- Safety information iv
- Care & Cleaning..... v
- 1.1 Welcome! 1-1
- 1.2 Package contents..... 1-1
- 1.3 Monitor introduction 1-2
 - 1.3.1 Front view 1-2
 - 1.3.2 Back view..... 1-4
- 2.1 Assembling the monitor base..... 2-1
- 2.2 Adjusting the monitor..... 2-2
- 2.3 Detaching the arm (for VESA wall mount)..... 2-3
- 3.1 OSD (On-Screen Display) menu 3-1
 - 3.1.1 How to configure 3-1
 - 3.1.2 OSD Function Introduction..... 3-2
- 3.2 Specifications..... 3-7
- 3.3 Troubleshooting (FAQ)..... 3-9
- 3.4 Supported Timing List..... 3-10

Copyright © 2012 ASUSTeK COMPUTER INC. All Rights Reserved.

No part of this manual, including the products and software described in it, may be reproduced, transmitted, transcribed, stored in a retrieval system, or translated into any language in any form or by any means, except documentation kept by the purchaser for backup purposes, without the express written permission of ASUSTeK COMPUTER INC. ("ASUS").

Product warranty or service will not be extended if: (1) the product is repaired, modified or altered, unless such repair, modification or alteration is authorized in writing by ASUS; or (2) the serial number of the product is defaced or missing.

ASUS PROVIDES THIS MANUAL "AS IS" WITHOUT WARRANTY OF ANY KIND, EITHER EXPRESS OR IMPLIED, INCLUDING BUT NOT LIMITED TO THE IMPLIED WARRANTIES OR CONDITIONS OF MERCHANTABILITY OR FITNESS FOR A PARTICULAR PURPOSE. IN NO EVENT SHALL ASUS, ITS DIRECTORS, OFFICERS, EMPLOYEES OR AGENTS BE LIABLE FOR ANY INDIRECT, SPECIAL, INCIDENTAL, OR CONSEQUENTIAL DAMAGES (INCLUDING DAMAGES FOR LOSS OF PROFITS, LOSS OF BUSINESS, LOSS OF USE OR DATA, INTERRUPTION OF BUSINESS AND THE LIKE), EVEN IF ASUS HAS BEEN ADVISED OF THE POSSIBILITY OF SUCH DAMAGES ARISING FROM ANY DEFECT OR ERROR IN THIS MANUAL OR PRODUCT.

SPECIFICATIONS AND INFORMATION CONTAINED IN THIS MANUAL ARE FURNISHED FOR INFORMATIONAL USE ONLY, AND ARE SUBJECT TO CHANGE AT ANY TIME WITHOUT NOTICE, AND SHOULD NOT BE CONSTRUED AS A COMMITMENT BY ASUS. ASUS ASSUMES NO RESPONSIBILITY OR LIABILITY FOR ANY ERRORS OR INACCURACIES THAT MAY APPEAR IN THIS MANUAL, INCLUDING THE PRODUCTS AND SOFTWARE DESCRIBED IN IT.

Products and corporate names appearing in this manual may or may not be registered trademarks or copyrights of their respective companies, and are used only for identification or explanation and to the owners' benefit, without intent to infringe.

Notices

Federal Communications Commission Statement

This device complies with Part 15 of the FCC Rules. Operation is subject to the following two conditions:

- This device may not cause harmful interference, and
- This device must accept any interference received including interference that may cause undesired operation.

This equipment has been tested and found to comply with the limits for a Class B digital device, pursuant to Part 15 of the FCC Rules. These limits are designed to provide reasonable protection against harmful interference in a residential installation. This equipment generates, uses and can radiate radio frequency energy and, if not installed and used in accordance with manufacturer's instructions, may cause harmful interference to radio communications. However, there is no guarantee that interference will not occur in a particular installation. If this equipment does cause harmful interference to radio or television reception, which can be determined by turning the equipment off and on, the user is encouraged to try to correct the interference by one or more of the following measures:

- Reorient or relocate the receiving antenna.
- Increase the separation between the equipment and receiver.
- Connect the equipment to an outlet on a circuit different from that to which the receiver is connected.
- Consult the dealer or an experienced radio/TV technician for help.



As an Energy Star® Partner, our company has determined that this product meets the Energy Star® guidelines for energy efficiency.

Canadian Department of Communications Statement

This digital apparatus does not exceed the Class B limits for radio noise emissions from digital apparatus set out in the Radio Interference Regulations of the Canadian Department of Communications.

This class B digital apparatus complies with Canadian ICES-003.

Safety information

- Before setting up the monitor, carefully read all the documentation that came with the package.
- To prevent fire or shock hazard, never expose the monitor to rain or moisture.
- Never try to open the monitor cabinet. The dangerous high voltages inside the monitor may result in serious physical injury.
- If the power supply is broken, do not try to fix it by yourself. Contact a qualified service technician or your retailer.
- Before using the product, make sure all cables are correctly connected and the power cables are not damaged. If you detect any damage, contact your dealer immediately.
- Slots and openings on the back or top of the cabinet are provided for ventilation. Do not block these slots. Never place this product near or over a radiator or heat source unless proper ventilation is provided.
- The monitor should be operated only from the type of power source indicated on the label. If you are not sure of the type of power supply to your home, consult your dealer or local power company.
- Use the appropriate power plug which complies with your local power standard.
- Do not overload power strips and extension cords. Overloading can result in fire or electric shock.
- Avoid dust, humidity, and temperature extremes. Do not place the monitor in any area where it may become wet. Place the monitor on a stable surface.
- Unplug the unit during a lightning storm or if it will not be used for a long period of time. This will protect the monitor from damage due to power surges.
- Never push objects or spill liquid of any kind into the slots on the monitor cabinet.
- To ensure satisfactory operation, in case use at a PC then it should use the monitor only with computers which have appropriate configured receptacles marked between 100-240V AC.
- If you encounter technical problems with the monitor, contact a qualified service technician or your retailer.
- The wall socket shall be installed near the equipment and shall be easily accessible.

Care & Cleaning

- Before you lift or reposition your monitor, it is better to disconnect the cables and power cord. Follow the correct lifting techniques when positioning the monitor. When lifting or carrying the monitor, grasp the edges of the monitor. Do not lift the display by the stand or the cord.
- Cleaning. Turn your monitor off and unplug the power cord. Clean the monitor surface with a lint-free, non-abrasive cloth. Stubborn stains may be removed with a cloth dampened with mild cleaner.
- Avoid using a cleaner containing alcohol or acetone. Use a cleaner intended for use with the LCD. Never spray cleaner directly on the screen, as it may drip inside the monitor and cause an electric shock.

The following symptoms are normal with the monitor:

- The screen may flicker during the initial use due to the nature of the fluorescent light. Turn off the Power Switch and turn it on again to make sure that the flicker disappears.
- You may find slightly uneven brightness on the screen depending on the desktop pattern you use.
- When the same image is displayed for hours, an afterimage of the previous screen may remain after switching the image. The screen will recover slowly or you can turn off the Power Switch for hours.
- When the screen becomes black or flashes, or cannot work anymore, contact your dealer or service center to fix it. Do not repair the screen by yourself!

Conventions used in this guide



WARNING: Information to prevent injury to yourself when trying to complete a task.



CAUTION: Information to prevent damage to the components when trying to complete a task.



IMPORTANT: Information that you **MUST** follow to complete a task.



NOTE: Tips and additional information to aid in completing a task.

Where to find more information

Refer to the following sources for additional information and for product and software updates.

1. ASUS websites

The ASUS websites worldwide provide updated information on ASUS hardware and software products. Refer to **<http://www.asus.com>**

2. Optional documentation

Your product package may include optional documentation that may have been added by your dealer. These documents are not part of the standard package.

1.1 Welcome!

Thank you for purchasing the ASUS® LCD monitor!

The latest widescreen LCD monitor from ASUS provides a crisper, broader, and brighter display, plus a host of features that enhance your viewing experience.

With these features, you can enjoy the convenience and delightful visual experience that the monitor brings you!

1.2 Package contents

Check your package for the following items:

- ✓ LCD Monitor
- ✓ Power Cord
- ✓ VGA Cable
- ✓ DVI (Dual-Link) Cable
- ✓ 3.5mm Audio Cable
- ✓ Support CD
- ✓ Quick Start Guide
- ✓ Warranty Card



If any of the above items is damaged or missing, contact your retailer immediately.

1.3 Monitor introduction

1.3.1 Front view

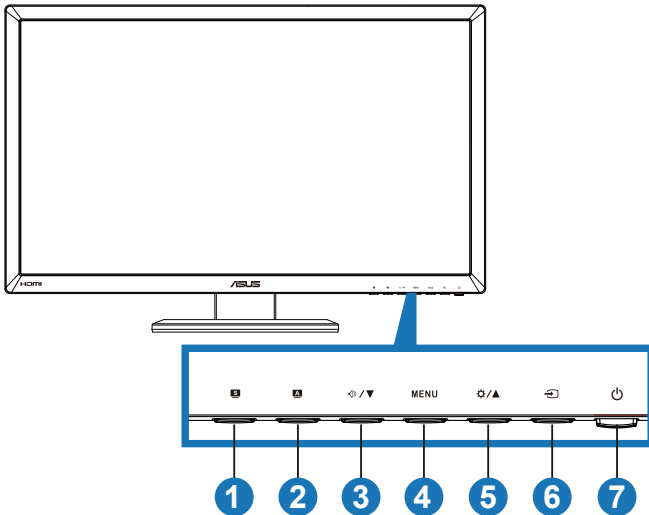

1. **S** Button:

- Press this hotkey to switch from six video preset modes (**Scenery Mode, Standard Mode, Theater Mode, Game Mode, Night View Mode, and sRGB**) with **SPLENDID™** Video Intelligence Technology.
- Exits the OSD menu or goes back to the previous menu when the OSD menu is active.



The Splendid, Contrast and Brightness adjustment functions will be temporarily disabled while 3D function is activated.

2. **A** Button:

- Press this button to automatically adjust the image to its optimized position, clock, and phase (for VGA mode only).

3. **Left Arrow / Down Arrow** Button:

- Press this button to decrease the value of the function selected or move to the next functions.
- Volume hotkey

4. **MENU** Button:

- Press this button to enter/select the icon (function) highlighted while the OSD menu is activated.
- Exits the hotkey OSD menu.

5. /▲ Button:

- Press this button to increase the value of the function selected or move to the previous function.
- Brightness hotkey

6.  Input Select Button:

- Press this button to select input source.

7.  Power Button/Power Indicator:

- Press this button to turn the monitor on/off.
- The color definition of the power indicator is shown below.

| Status | Description |
|--------|--------------|
| Blue | ON |
| Amber | Standby mode |
| OFF | OFF |

1.3.2 Back view

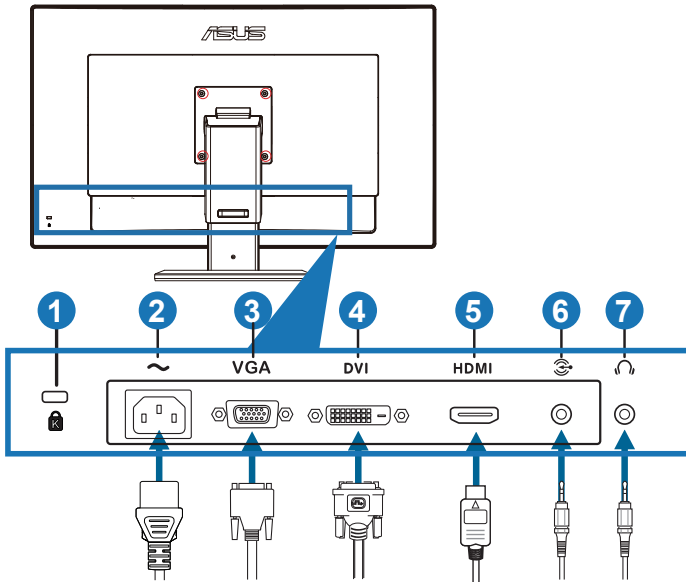

Rear connectors

1. Kensington lock slot.
2. AC-IN port: This port connects the power cord.
3. VGA port: This 15-pin port is for PC VGA connection.
4. DVI port: This 24-pin port is for PC (Personal Computer) DVI-D digital signal connection.



Only DVI port supports 3D feature given NVIDIA 3D Vision Kit is available

5. HDMI-IN port: This port is for connection with an HDMI compatible device.
6. PC Audio-In Jack: This 3.5mm stereo jack is for PC audio connection.
7. Earphone-Out Jack: This 3.5mm stereo jack is for earphone audio connection.

2.1 Assembling the monitor base

To assemble the monitor base:

1. Attach the base to the arm.
2. Fix with the screws to joint the base with the arm. You can easily tighten the screws by fingers.
3. Remove the height adjustment lock from the arm.

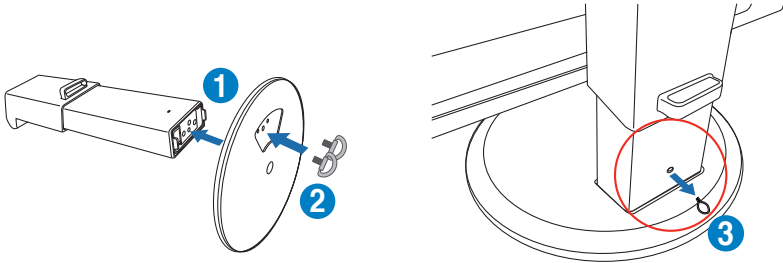

The height adjustment lock should NEVER be removed BEFORE you place the monitor VERTICALLY on a flat and clean table.

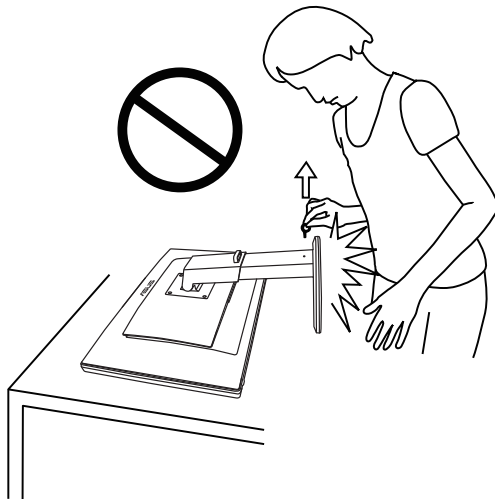

2.2 Adjusting the monitor

- For optimal viewing, we recommend that you look at the full face of the monitor, then adjust the monitor to the angle that is most comfortable for you.
- Hold the base to prevent the monitor from falling when you change its angle.
- You can tilt the monitor's from -5° to $+15^{\circ}$, swivel from left-to-right for 150° , and lift the monitor's height for about 100mm.

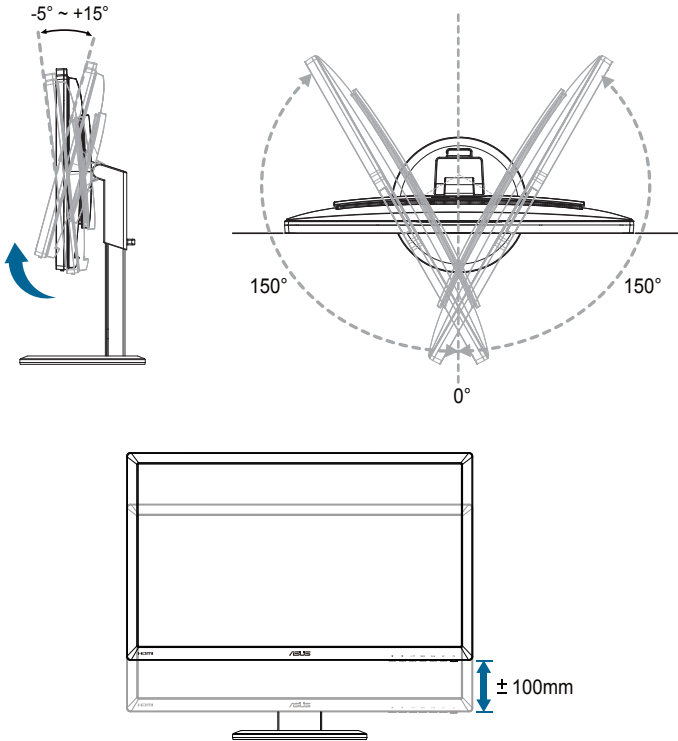

It is normal that the monitor slightly shakes while you adjust the viewing angle.

2.3 Detaching the arm (for VESA wall mount)

The detachable arm of this monitor is specially designed for VESA wall mount.

To detach the arm:

1. Disconnect power and signal cables.
2. Lower the monitor to its lowest height, and then insert the height adjustment lock.
3. Carefully put the front of the monitor face down on a flat and clean table.
4. Use a screwdriver to remove the four screwdrivers on the arm, and then detach the arm from the monitor.



- We recommend that you cover the table surface with soft cloth to prevent damage to the monitor.
 - Hold the stand while removing the screws.
-



- The VESA wall mount kit (100 x 100 mm) is purchased separately.
 - Use only the UL Listed Wall Mount Bracket with minimum weight/load 32.4kg (Screw size: M4 x 10 mm).
-

3.1 OSD (On-Screen Display) menu

3.1.1 How to configure

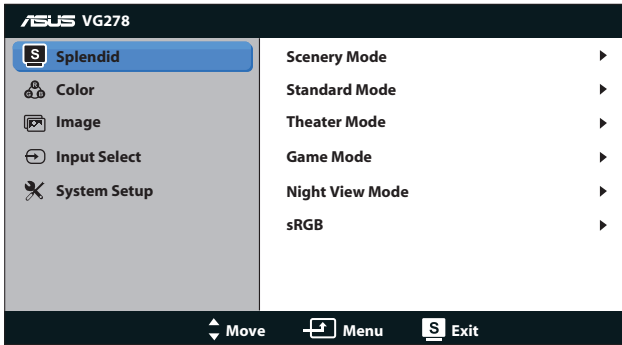

1. Press **[MENU]** button to activate the OSD menu.
2. Press **[⚙️/▲]** or **[⏪/▼]** button to navigate through the functions. Highlight and activate the desired function by pressing **[MENU]** button. If there is a sub-menu in the function selected, press **[⚙️/▲]** or **[⏪/▼]** button again to navigate through the sub-menu functions. Highlight and activate the desired sub-menu function by pressing **[MENU]** button.
3. Press **[⚙️/▲]** or **[⏪/▼]** button to change the settings of the selected function.
4. To exit the OSD menu, press **[S]** button. Repeat step 2 and step 3 to adjust any other function.

3.1.2 OSD Function Introduction

1. Splendid

This function contains six sub-functions you can select for your preference. Each mode has the Reset selection, allowing you to maintain your setting or return to the preset mode.

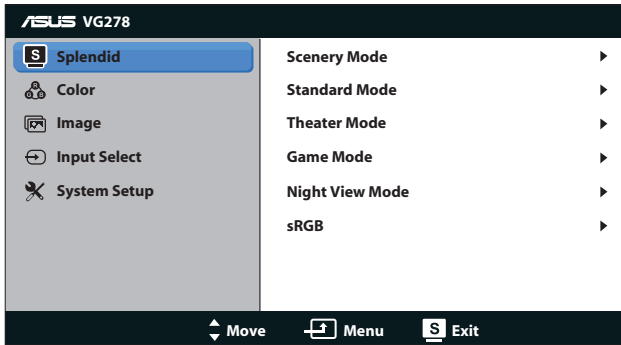

- **Scenery Mode:** The best choice for scenery photo display with SILENDID™ Video Enhancement.
- **Standard Mode:** The best choice for document editing with SILENDID™ Video Enhancement.
- **Theater Mode:** The best choice for movie with SILENDID™ Video Enhancement.
- **Game Mode:** The best choice for game playing with SILENDID™ Video Enhancement.
- **Night View Mode:** The best choice dark-scene game or movie with SILENDID™ Video Enhancement.
- **sRGB Mode:** Compatible with sRGB color space. sRGB mode is the best choice for document editing.



-
- In the Standard Mode, the Saturation and ASCR functions are not user-configurable.
 - In the other modes, the sRGB function is not user-configurable.
-

2. Color

Set a desired color setting from this menu.

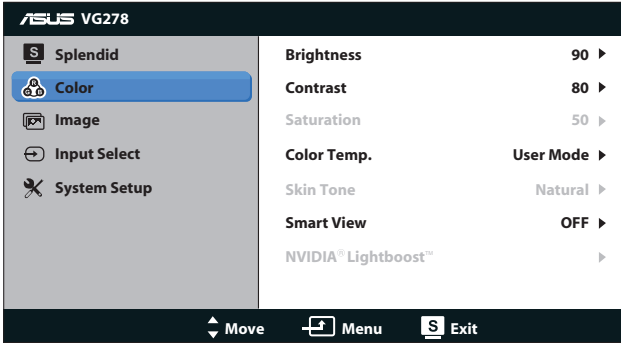

- **Brightness:** The adjusting range is from **0** to **100**. The  button is a hotkey to activate this function.
- **Contrast:** The adjusting range is from **0** to **100**.
- **Saturation:** The adjusting range is from **0** to **100**.
- **Color Temp.:** Contains four color modes: “Cool”, “Normal”, “Warm”, and “User Mode”.



In the User mode for Color Temp., the colors of R (Red), G (Green), and B (Blue) are user-configurable; the adjusting range is from 0 to 100.

- **Skin Tone:** Contains three color modes including “Reddish”, “Natural”, and “Yellowish”.
- **Smart View:** Enable a clearer visibility after tilted the screen.

3. Image

Set the image related setting from this menu.

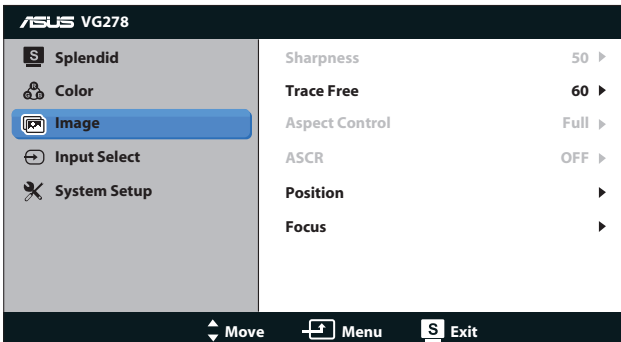

- **Sharpness:** Adjust the picture sharpness. The adjusting range is from **0** to **100**.
- **Trace Free:** Speed up the response time. The adjusting range is from **0** to **100**.
- **Aspect Control:** Adjust the aspect ratio to “**4:3**”, “**Full**”, or “**OverScan**”. (The “**OverScan**” ratio is only available for HDMI input.)
- **ASCR:** Turn on or off the ASCR (ASUS Smart Contrast Ratio) function. (Only available at **Scenery Mode**, **Theater Mode**, **Game Mode**, and **Night View Mode**.)
- **Position:** Adjust the horizontal position (H-Position) and the vertical position (V-Position) of the image. The adjusting range is from **0** to **100**. (Only available for VGA input.)
- **Focus:** Reduce Horizontal-line noise and Vertical-line noise of the image by adjusting (Phase) and (Clock) separately. The adjusting range is from **0** to **100**. (Only available for VGA input.)



- Phase adjusts the phase of the pixel clock signal. With a wrong phase adjustment, the screen shows horizontal disturbances.
- Clock (pixel frequency) controls the number of pixels scanned by one horizontal sweep. If the frequency is not correct, the screen shows vertical stripes and the image is not proportional.

4. Input Select

Select the input source from “**VGA**”, “**DVI**”, or “**HDMI**”.

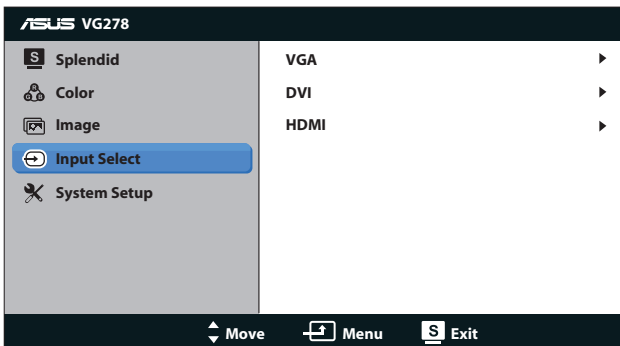

Only the VGA and DVI input supports the “Auto scan” function.

5. System Setup

Adjust the system configuration.

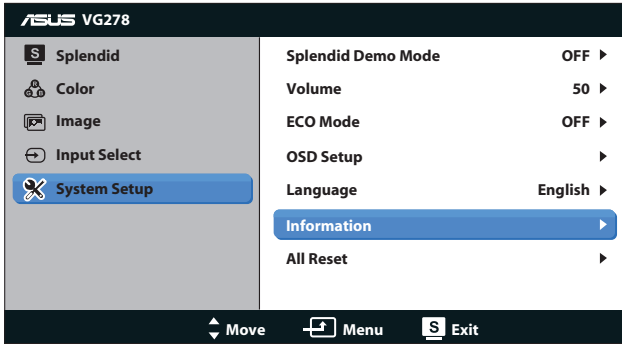

- **Splendid Demo Mode:** Splits the screen into two for Splendid modes comparison. (Only available at **Scenery Mode**, **Theater Mode**, **Game Mode**, and **Night View Mode**.)
- **Volume:** Adjusts the speaker and earphone output volume level. The adjusting range is from **0** to **100**.
- **ECO Mode:** Activate the ecology mode for power saving. (Some gray levels may not be distinguished if ECO is ON. Its brightness is lower than that when setting the Contrast Ratio to 100.)
- **OSD Setup:**
 - **H-Position / V-Position:** Adjusts the horizontal position (H-Position) or the vertical position (V-Position) of the OSD from **0** to **100**.
 - **OSD Timeout:** Adjusts the OSD timeout from **10** to **120** seconds.
 - **DDC/CI:** Enables or disables the DDC/CI function.
 - **Transparency:** Adjusts the OSD background from opaque to transparent.
- **Language:** There are 10 languages for your selection, including “**English**”, “**French**”, “**German**”, “**Spanish**”, “**Italian**”, “**Dutch**”, “**Russian**”, “**Traditional Chinese**”, “**Simplified Chinese**”, and “**Japanese**”.
- **Information:** Shows the monitor information.
- **All Reset:** Select “**Yes**” to restore the default settings.

3.2 Specifications

| | |
|----------------------------------|--|
| Panel Type | TFT LCD |
| Panel Size | 27" W (68.6 cm) |
| Color Saturation(NTSC) | 72% (sRGB) |
| True Resolution | 1920 x 1080 (up to 144Hz) |
| Full HD 1080P | Yes |
| Pixel Pitch | 0.311 mm |
| Brightness (Typ.) | 300 cd/m ² |
| Contrast Ratio (Typ.) | 1000:1 |
| ASUS Smart Contrast Ratio (ASCR) | 50,000,000:1 (with ASCR on) |
| Viewing Angle (H/V) CR \geq 10 | 170°(H) /160°(V) |
| Display Colors | 16.7 M |
| Response Time | 2 ms (Gray to gray) |
| Trace Free Technology | Yes |
| SPLENDID™ Video Enhancement | Yes |
| SPLENDID™ Selection | 6 video preset modes (by hotkey) |
| Skin-Tone Selection | 3 modes |
| Color Temperature Selection | 4 modes |
| HDCP | Yes |
| Stereo Speaker | 3W x 2 stereo, RMS |
| Auto Adjustment Hotkey | Yes |
| Brightness Adjustment Hotkey | Yes |
| Volume Adjustment Hotkey | Yes |
| Input Selection Hotkey | Yes |
| PC Input | Dual-link DVI-D(support NVIDIA 3D Vision), D-Sub |
| PC Audio Input | Yes (3.5mm Mini-jack) |
| Video Input | HDMI |
| AV Audio Input | HDMI |
| Earphone Jack | Yes (3.5mm Mini-jack) |
| Chassis Colors | Black |
| Power LED | Blue (On) / Amber (Standby) |
| Tilt | +15° ~ -5° |
| Swivel | +150° ~ -150° |
| Height Adjustment | 100 mm |

| | |
|------------------------------------|--|
| VESA Wall Mounting | 100 x 100 mm |
| Kensington Lock | Yes |
| AC Input Voltage | AC: 100 ~ 240V |
| Power Consumption | Power On: < 50 W (Max.) Energy Star: < 37.25 W Standby: < 1 W (Typ.) Power Off: < 1 W |
| Temperature (Operating) | 0°C ~ +35°C |
| Temperature (Non-operating) | -20°C ~ +60°C |
| Dimension (W x H x D) | 643 x 438 x 250 mm (machine) 711 x 227 x 540 mm (package) |
| Weight (Esti.) | 8.1kg (Net); 11.6kg (Gross) |
| Regulation approvals | Energy Star®, ErP, UL/cUL, CB, CE, FCC, CCC, Gost-R, C-Tick, VCCI, J-MOSS, PSB, RoHS, WEEE, Windows 7 WHQL |

*Specifications subject to change without notice.

3.3 Troubleshooting (FAQ)

| Problem | Possible Solution |
|--|--|
| Power LED is not ON | <ul style="list-style-type: none">• Press the  button to check if the monitor is in the ON mode.• Check if the power cord is properly connected to the monitor and the power outlet. |
| The power LED lights amber and there is no screen image | <ul style="list-style-type: none">• Check if the monitor and the computer are in the ON mode.• Make sure the signal cable is properly connected the monitor and the computer.• Inspect the signal cable and make sure none of the pins are bent.• Connect the computer with another available monitor to check if the computer is properly working. |
| Screen image is too light or dark | <ul style="list-style-type: none">• Adjust the Contrast and Brightness settings via OSD. |
| Screen image bounces or a wave pattern is present in the image | <ul style="list-style-type: none">• Make sure the signal cable is properly connected to the monitor and the computer.• Move away electrical devices that may cause electrical interference. |
| Screen image has color defects (white does not look white) | <ul style="list-style-type: none">• Inspect the signal cable and make sure that none of the pins are bent.• Perform All Reset via OSD.• Adjust the R/G/B color settings or select the Color Temperature via OSD. |
| No sound or sound is low | <ul style="list-style-type: none">• Ensure that the audio cable is properly connected to the monitor and the computer.• Adjust the volume settings of both your monitor and computer.• Ensure that the computer sound card driver is properly installed and activated. |

3.4 Supported Timing List

| Resolution | Refresh Rate | Horizontal |
|------------|--------------|------------|
| 640x480 | 60Hz | 31.469KHz |
| 640x480 | 67Hz | 35KHz |
| 640x480 | 75Hz | 37.5KHz |
| 720x400 | 70Hz | 31.469KHz |
| 720x400 | 85Hz | 37.927KHz |
| 800x600 | 56Hz | 35.156KHz |
| 800x600 | 60Hz | 37.879KHz |
| 800x600 | 72Hz | 48.077KHz |
| 800x600 | 75Hz | 46.875KHz |
| 832x624 | 75Hz | 49.725KHz |
| 848x480 | 60Hz | 31.02KHz |
| 1024x768 | 60Hz | 48.363KHz |
| 1024x768 | 70Hz | 56.476KHz |
| 1024x768 | 75Hz | 60.023KHz |
| 1152x864 | 75Hz | 67.5KHz |
| 1280x720 | 60Hz | 44.444KHz |
| 1280x720 | 60Hz | 44.772KHz |
| 1280x720 | 75Hz | 56.456KHz |
| 1280x768 | 60Hz | 47.396KHz |
| 1280x800 | 60Hz | 49.306KHz |
| 1280x800 | 60Hz | 49.702KHz |
| 1280x800 | 75Hz | 62.795KHz |
| 1280x960 | 60Hz | 60KHz |
| 1280x1024 | 60Hz | 63.981KHz |
| 1280x1024 | 75Hz | 79.976KHz |
| 1366x768 | 60Hz | 47.712KHz |
| 1440x900 | 60Hz | 55.469KHz |
| 1440x900 | 60Hz | 55.935KHz |
| 1440x900 | 75Hz | 70.635KHz |
| 1680x1050 | 60Hz | 64.674KHz |
| 1680x1050 | 60Hz | 65.29KHz |
| 1920x1080 | 60Hz | 66.587KHz |
| 1920x1080 | 60Hz | 67.5KHz |

| Resolution | Refresh Rate | Horizontal |
|-------------------|--------------|---------------------------------|
| 1920x1080* (DVI) | 144Hz | 158.11KHz (2D) |
| 1920x1080* (DVI) | 100Hz | 113.3 KHz(2D) / 113.8KHz(3D) |
| 1920x1080* (DVI) | 110Hz | 125.1KHz(2D) / 125.7KHz(3D) |
| 1920x1080* (DVI) | 120Hz | 137.2KHz(2D/3D) |
| 640x480P (HDMI) | 59.94/60Hz | 31.469KHz / 31.5KHz |
| 720x480P (HDMI) | 59.94/60Hz | 31.469KHz / 31.5KHz |
| 720x576P (HDMI) | 50Hz | 31.25KHz |
| 1280x720P (HDMI) | 50Hz | 37.5KHz |
| 1280x720P (HDMI) | 59.94/60Hz | 44.955KHz / 45KHz |
| 1440x480P (HDMI) | 59.94/60Hz | 31.469KHz / 31.5KHz |
| 1440x576P (HDMI) | 50Hz | 31.25KHz |
| 1920x1080i (HDMI) | 50Hz | 28.125KHz |
| 1920x1080i (HDMI) | 59.94/60Hz | 33.716KHz / 33.75KHz |
| 1920x1080P (HDMI) | 50Hz | 56.25KHz |
| 1920x1080P (HDMI) | 59.94/60Hz | 67.433 KHz / 67.5KHz |

Note: you must select one of the “*” timing for enabling 3D or 144Hz feature with a compatible NVIDIA-GPU graphic card via Dual-link DVI cable connection.

Free Manuals Download Website

<http://myh66.com>

<http://usermanuals.us>

<http://www.somanuals.com>

<http://www.4manuals.cc>

<http://www.manual-lib.com>

<http://www.404manual.com>

<http://www.luxmanual.com>

<http://aubethermostatmanual.com>

Golf course search by state

<http://golfingnear.com>

Email search by domain

<http://emailbydomain.com>

Auto manuals search

<http://auto.somanuals.com>

TV manuals search

<http://tv.somanuals.com>