

**ASUS®**

**VP247 Series  
LCD Monitor**

**User Guide**

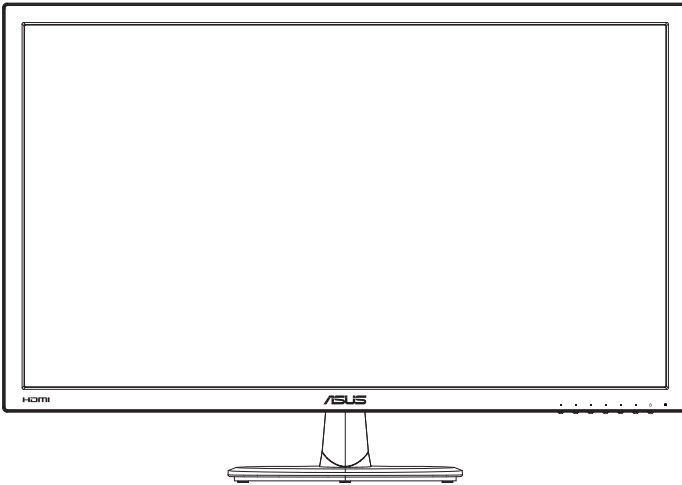

**HDMI™**  
HIGH-DEFINITION MULTIMEDIA INTERFACE

# Table of contents

- Notices ..... iii
- Care & Cleaning ..... vii
- 1.1 Welcome! ..... 1-1
- 1.2 Package contents..... 1-1
- 1.3 Assembling the monitor ..... 1-2
- 1.4 Connect cables..... 1-3
  - 1.4.1 Rear of the LCD monitor ..... 1-3
- 1.5 Monitor introduction ..... 1-5
  - 1.5.1 Using the Controls button ..... 1-5
  - 1.5.2 QuickFit Function ..... 1-7
- 2.1 Detaching the arm/stand (for VESA wall mount) ..... 2-1
- 2.2 Adjusting the monitor ..... 2-2
- 3.1 OSD (On-Screen Display) menu ..... 3-1
  - 3.1.1 How to reconfigure..... 3-1
  - 3.1.2 OSD Function Introduction..... 3-2
- 3.2 Specifications..... 3-11
- 3.3 Troubleshooting (FAQ)..... 3-14
- 3.4 Supported Timing List..... 3-14

Copyright © 2016 ASUSTeK COMPUTER INC. All Rights Reserved.

No part of this manual, including the products and software described in it, may be reproduced, transmitted, transcribed, stored in a retrieval system, or translated into any language in any form or by any means, except documentation kept by the purchaser for backup purposes, without the express written permission of ASUSTeK COMPUTER INC. ("ASUS").

Product warranty or service will not be extended if: (1) the product is repaired, modified or altered, unless such repair, modification or alteration is authorized in writing by ASUS; or (2) the serial number of the product is defaced or missing.

ASUS PROVIDES THIS MANUAL "AS IS" WITHOUT WARRANTY OF ANY KIND, EITHER EXPRESS OR IMPLIED, INCLUDING BUT NOT LIMITED TO THE IMPLIED WARRANTIES OR CONDITIONS OF MERCHANTABILITY OR FITNESS FOR A PARTICULAR PURPOSE. IN NO EVENT SHALL ASUS, ITS DIRECTORS, OFFICERS, EMPLOYEES OR AGENTS BE LIABLE FOR ANY INDIRECT, SPECIAL, INCIDENTAL, OR CONSEQUENTIAL DAMAGES (INCLUDING DAMAGES FOR LOSS OF PROFITS, LOSS OF BUSINESS, LOSS OF USE OR DATA, INTERRUPTION OF BUSINESS AND THE LIKE), EVEN IF ASUS HAS BEEN ADVISED OF THE POSSIBILITY OF SUCH DAMAGES ARISING FROM ANY DEFECT OR ERROR IN THIS MANUAL OR PRODUCT.

SPECIFICATIONS AND INFORMATION CONTAINED IN THIS MANUAL ARE FURNISHED FOR INFORMATIONAL USE ONLY, AND ARE SUBJECT TO CHANGE AT ANY TIME WITHOUT NOTICE, AND SHOULD NOT BE CONSTRUED AS A COMMITMENT BY ASUS. ASUS ASSUMES NO RESPONSIBILITY OR LIABILITY FOR ANY ERRORS OR INACCURACIES THAT MAY APPEAR IN THIS MANUAL, INCLUDING THE PRODUCTS AND SOFTWARE DESCRIBED IN IT.

Products and corporate names appearing in this manual may or may not be registered trademarks or copyrights of their respective companies, and are used only for identification or explanation and to the owners' benefit, without intent to infringe.

# Notices

## Federal Communications Commission Statement

This device complies with Part 15 of the FCC Rules. Operation is subject to the following two conditions:

- This device may not cause harmful interference, and
- This device must accept any interference received including interference that may cause undesired operation.

This equipment has been tested and found to comply with the limits for a Class B digital device, pursuant to Part 15 of the FCC Rules. These limits are designed to provide reasonable protection against harmful interference in a residential installation. This equipment generates, uses and can radiate radio frequency energy and, if not installed and used in accordance with manufacturer's instructions, may cause harmful interference to radio communications. However, there is no guarantee that interference will not occur in a particular installation. If this equipment does cause harmful interference to radio or television reception, which can be determined by turning the equipment off and on, the user is encouraged to try to correct the interference by one or more of the following measures:

- Reorient or relocate the receiving antenna.
- Increase the separation between the equipment and receiver.
- Connect the equipment to an outlet on a circuit different from that to which the receiver is connected.
- Consult the dealer or an experienced radio/TV technician for help.



As an Energy Star® Partner, our company has determined that this product meets the Energy Star® guidelines for energy efficiency.

## Canadian Department of Communications Statement

This digital apparatus does not exceed the Class B limits for radio noise emissions from digital apparatus set out in the Radio Interference Regulations of the Canadian Department of Communications.

This class B digital apparatus complies with Canadian ICES-003.

Made in China

## TCO Information

### Congratulations!

**This display is designed for both you and the planet!**



The display you have just purchased carries the TCO Certified label. This ensures that your display is designed, manufactured and tested according to some of the strictest quality and environmental requirements in the world. This makes for a high performance product, designed with the user in focus that also minimizes the impact on the climate and our natural environment.

TCO Certified is a third party verified program, where every product model is tested by an accredited impartial test laboratory. TCO Certified represents one of the toughest certifications for displays worldwide.

#### **Some of the Usability features of the TCO Certified for displays:**

- Good visual ergonomics and image quality is tested to ensure top performance and reduce sight and strain problems. Important parameters are luminance, contrast, resolution, black level, gamma curve, color and luminance uniformity, color rendition and image stability.
- Product have been tested according to rigorous safety standards at an impartial laboratory.
- Electric and magnetic fields emissions as low as normal household background levels.
- Low acoustic noise emissions.

#### **Some of the Environmental features of the TCO Certified for displays:**

- The brand owner demonstrates corporate social responsibility and has a certified environmental management system (EMAS or ISO 14001).
- Very low energy consumption both in on- and standby mode minimize climate impact.
- Restrictions on chlorinated and brominated flame retardants, plasticizers, plastics and heavy metals such as cadmium, mercury and lead (RoHS compliance).
- Both product and product packaging is prepared for recycling.
- The brand owner offers take-back options.

The requirements can be downloaded from our web site. The requirements included in this label have been developed by TCO Development in co-operation with scientists, experts, users as well as manufacturers all over the world. Since the end of the 1980s TCO has been involved in influencing the development of IT equipment in a more user-friendly direction. Our labeling system started with displays in 1992 and is now requested by users and IT manufacturers all over the world. About 50% of all displays worldwide are TCO certified.

**For displays with glossy bezels the user should consider the placement of the display as the bezel may cause disturbing reflections from surrounding light and bright surfaces**

For more information, please visit  
[www.tcodevelopment.com](http://www.tcodevelopment.com)

(except for VP247HAE)

## Safety information

- Before setting up the monitor, carefully read all the documentation that came with the package.
- To prevent fire or shock hazard, never expose the monitor to rain or moisture.
- Never try to open the monitor cabinet. The dangerous high voltages inside the monitor may result in serious physical injury.
- If the power supply is broken, do not try to fix it by yourself. Contact a qualified service technician or your retailer.
- Before using the product, make sure all cables are correctly connected and the power cables are not damaged. If you detect any damage, contact your dealer immediately.
- Slots and openings on the back or top of the cabinet are provided for ventilation. Do not block these slots. Never place this product near or over a radiator or heat source unless proper ventilation is provided.
- The monitor should be operated only from the type of power source indicated on the label. If you are not sure of the type of power supply to your home, consult your dealer or local power company.
- Use the appropriate power plug which complies with your local power standard.
- Do not overload power strips and extension cords. Overloading can result in fire or electric shock.
- Avoid dust, humidity, and temperature extremes. Do not place the monitor in any area where it may become wet. Place the monitor on a stable surface.
- Unplug the unit during a lightning storm or if it will not be used for a long period of time. This will protect the monitor from damage due to power surges.
- Never push objects or spill liquid of any kind into the slots on the monitor cabinet.
- To ensure satisfactory operation, use the monitor only with UL listed computers which have appropriate configured receptacles marked between 100 ~ 240V AC.
- The socket-outlet shall be installed near the equipment and shall be easily accessible
- If you encounter technical problems with the monitor, contact a qualified service er.
- Provide an earthing connection before the mains plug is connected to the mains. And, when disconnecting the earthing connection, be sure to disconnect after pulling out the mains plug from the mains.

**WARNING**

Usage of other than specified head- or earphones can result in hearing loss due to excessive sound pressures.

## Care & Cleaning

- Before you lift or reposition your monitor, it is better to disconnect the cables and power cord. Follow the correct lifting techniques when positioning the monitor. When lifting or carrying the monitor, grasp the edges of the monitor. Do not lift the display by the stand or the cord.
- Cleaning. Turn your monitor off and unplug the power cord. Clean the monitor surface with a lint-free, non-abrasive cloth. Stubborn stains may be removed with a cloth dampened with mild cleaner.
- Avoid using a cleaner containing alcohol or acetone. Use a cleaner intended for use with the LCD. Never spray cleaner directly on the screen, as it may drip inside the monitor and cause an electric shock.

### The following symptoms are normal with the monitor:

- The screen may flicker during the initial use due to the nature of the fluorescent light. Turn off the Power Switch and turn it on again to make sure that the flicker disappears.
- You may find slightly uneven brightness on the screen depending on the desktop pattern you use.
- When the same image is displayed for hours, an afterimage of the previous screen may remain after switching the image. The screen will recover slowly or you can turn off the Power Switch for hours.
- When the screen becomes black or flashes, or cannot work anymore, contact your dealer or service center to fix it. Do not repair the screen by yourself!

### Conventions used in this guide



**WARNING:** Information to prevent injury to yourself when trying to complete a task.



**CAUTION:** Information to prevent damage to the components when trying to complete a task.



**IMPORTANT:** Information that you **MUST** follow to complete a task.



**NOTE:** Tips and additional information to aid in completing a task.

## **Where to find more information**

Refer to the following sources for additional information and for product and software updates.

### **1. ASUS websites**

The ASUS websites worldwide provide updated information on ASUS hardware and software products. Refer to **<http://www.asus.com>**

### **2. Optional documentation**

Your product package may include optional documentation that may have been added by your dealer. These documents are not part of the standard package.



## 1.1 Welcome!

Thank you for purchasing the ASUS® LCD monitor!

The latest widescreen LCD monitor from ASUS provides a crisper, broader, and brighter display, plus a host of features that enhance your viewing experience.

With these features, you can enjoy the convenience and delightful visual experience that the monitor brings you!

## 1.2 Package contents

Check your package for the following items:

- ✓ LCD Monitor
- ✓ Monitor Base
- ✓ Quick Start Guide
- ✓ Warranty Card
- ✓ 1x Power Cord
- ✓ 1x Audio Cable (option)
- ✓ 1x HDMI Cable (option)
- ✓ 1x VGA Cable
- ✓ 1x DVI Cable (option)
- ✓ 1x DisplayPort Cable (option)



- 
- If any of the above items is damaged or missing, contact your retailer immediately.
-

## 1.3 Assembling the monitor

### To assemble the monitor:

1. Place the display flat on a cloth on the table, Then attach the base to the arm and fix with the screw to join them tightly. You can easily tighten the screw by fingers.
2. Adjust the monitor to the angle that is most comfortable for you.

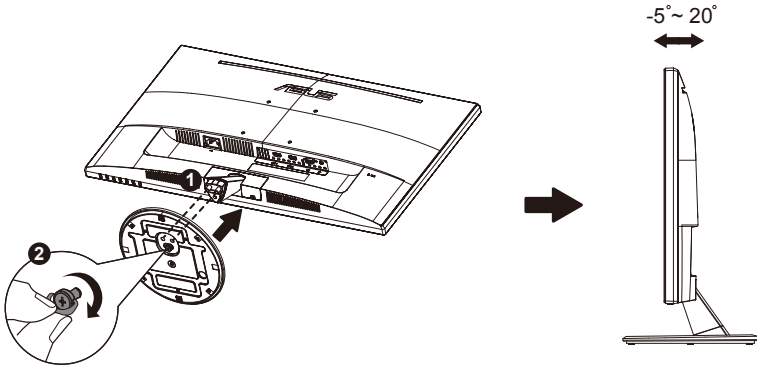

## 1.4 Connect cables

### 1.4.1 Rear of the LCD monitor

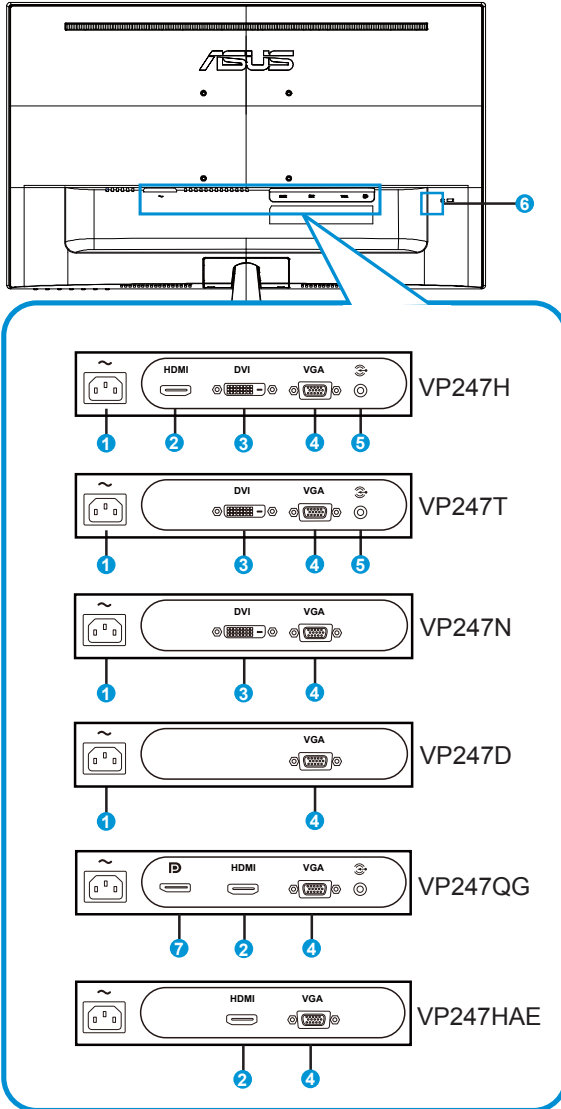

1. AC-IN Port
2. HDMI Port
3. DVI Port
4. VGA Port
5. Audio - in Port
6. Kensington Lock
7. DisplayPort

## 1.5 Monitor introduction

### 1.5.1 Using the Controls button

Use the control button on the back of the monitor to adjust the image settings.

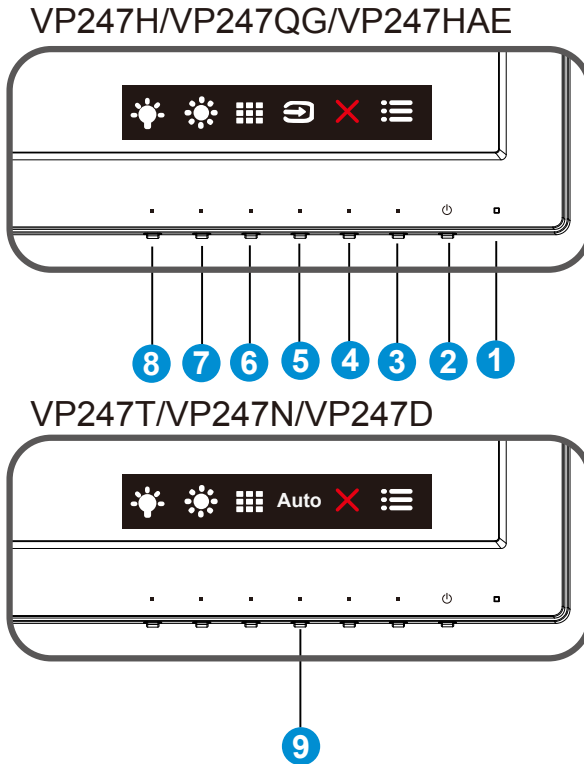







1. Power Indicator:

- The color definition of the power indicator is as the below table.

Status	Description
White	ON
Amber	Standby mode
OFF	OFF

2.  Power Button:

- Press this button to turn the monitor on/off.

3.  MENU Button:
  - Press this button to enter the OSD menu.
4.  Close Button
  - Exit the OSD menu.
5.  Input Select Button(VP247H/VP247QG/VP247HAE only):
  - Use this hotkey to switch from VGA, DVI, HDMI input signal(VP247H).
  - Use this hotkey to switch from VGA, HDMI, DisplayPort input signal(VP247QG).
  - Use this hotkey to switch from VGA, HDMI input signal(VP247HAE).
6.  QuickFit Button:
  - This is a hotkey to activate the **QuickFit** function designed for alignment.
  - The **QuickFit** function contains 5 pages of common grid patterns, paper sizes, and photo sizes. See page 1-7 for details.
7.  Shortcut key1
  - This is a Shortcut key. The default setting is Brightness.
8.  Shortcut key2
  - This is a Shortcut key. The default setting is Blue Light Filter.
9. Auto Button
  - Auto Adjust.: Automatically adjust the image to its optimized position, clock, and phase.

## 1.5.2 QuickFit Function

The QuickFit function contains three patterns: (1) Grid (2) Paper size (3) Photo size.

1. Grid pattern: Facilitates designers and users to organize content and layout on one page and achieve a consistent look and feel.



2. Paper size: Provides users to view their documents in real size on the screen.

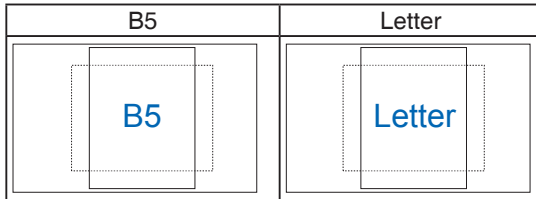

3. Photo size: Provides photographers and other users to accurately view and edit their photos in real size on the screen.

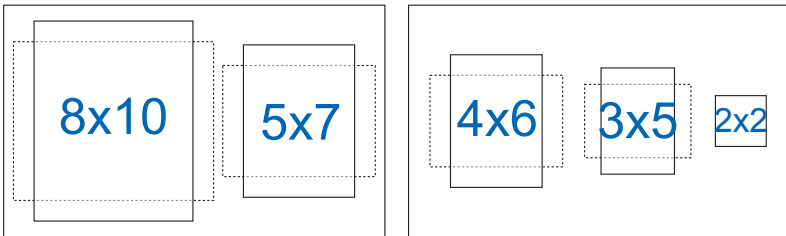

## 2.1 Detaching the arm/stand (for VESA wall mount)

The detachable stand of this monitor is specially designed for VESA wall mount.

### To detach the arm/stand

1. Disconnect power and signal cables. Carefully put the front of the monitor face down on a clean table.
2. Use your fingers to loosen the screw located at the bottom of the base, and remove the base from the stand. And then remove the hinge cover from monitor body by using your fingers.
3. Use a screwdriver to remove the two screws on the arm (Figure 1), and then detach the arm/stand from the monitor.



- We recommend that you cover the table surface with soft cloth to prevent damage to the monitor.
- Hold the stand of the monitor while removing the screws.

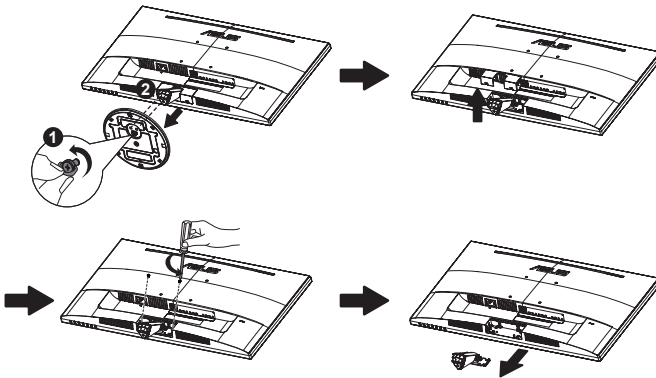

- The VESA wall mount kit ( 100 x 100 mm) is purchased separately.
- Use only the UL Listed Wall Mount Bracket with minimum weight/load 12 kg (Screw size: M4 x 10 mm).



## 2.2 Adjusting the monitor

- For optimal viewing, we recommend that you look at the full face of the monitor, then adjust the monitor to the angle that is most comfortable for you.
- Hold the stand to prevent the monitor from falling when you change its angle.
- You can adjust the monitor's angle from  $+20^{\circ}$  to  $-5^{\circ}$

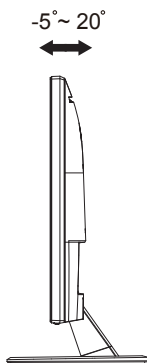

---

It is normal that the monitor slightly shakes while you adjust the viewing angle.

---

## 3.1 OSD (On-Screen Display) menu

### 3.1.1 How to reconfigure

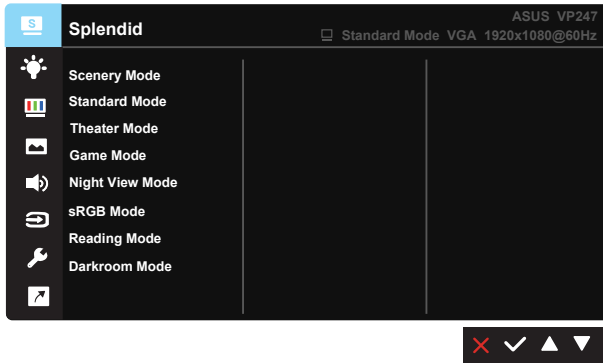

1. Press the MENU button to activate the OSD menu.
2. Press the ▼ and ▲ buttons to toggle between options in the Menu. As you move from one icon to another, the option name is highlighted.
3. To select the highlighted item on the menu press the ✓ button.
4. Press the ▼ and ▲ buttons to select the desired parameter.
5. Press the ✓ button to enter the slide bar and then use the ▼ or ▲ buttons, according to the indicators on the menu, to make your changes.
6. Select the ↶ to return to previous menu or ✓ to accept and return to previous menu.

### 3.1.2 OSD Function Introduction

#### 1. Splendid

This function contains eight sub-functions that you can select for your preference. Each mode has the Reset selection, allowing you to maintain your setting or return to the preset mode.

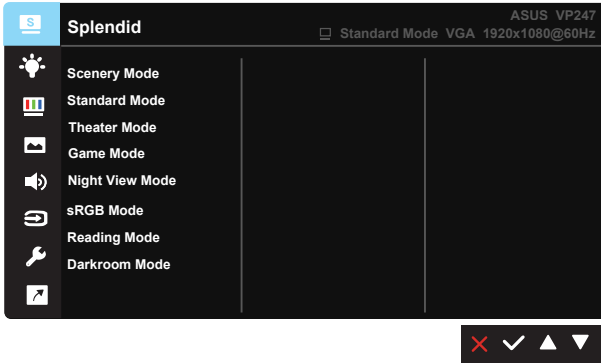

- **Scenery Mode:** This is the best choice for scenery photo displaying with SPLENDID™ Video Intelligence Technology.
- **Standard Mode:** This is the best choice for document editing with SPLENDID™ Video Intelligence Technology.
- **Theater Mode:** This is the best choice for movie watching with SPLENDID™ Video Intelligence Technology.
- **Game Mode:** This is the best choice for game playing with SPLENDID™ Video Intelligence Technology.
- **Night View Mode:** This is the best choice for playing dark-scene game or watching dark-scene movie with SPLENDID™ Video Intelligence Technology.
- **sRGB Mode:** This is the best choice for viewing photos and graphics from PCs.
- **Reading Mode :** This is the best choice for book reading.
- **Darkroom Mode :** This is the best choice for a weak ambient light environmen.



- 
- In the Standard Mode, the Saturation, SkinTone, Sharpness, and ASCR functions are not user-configurable.
  - In the sRGB, the Saturation, Color Temp., SkinTone, Sharpness, Brightness, Contrast and ASCR functions are not user-configurable.
  - In the Reading Mode, the Saturation, SkinTone, Sharpness, ASCR, contrast, and Color Temp functions are not user-configurable.
-

## 2. Blue Light Filter

Adjust the energy level of blue light emitted from LED backlight.

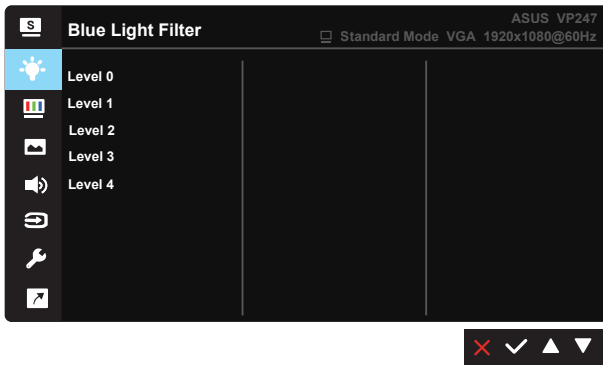

- **Level 0:** No change.
- **Level 1~4:** The higher the level, the more blue light will be reduced.



- When Blue Light Filter is activated, the default settings of Standard Mode will be automatically imported.
- Between Level 1 to Level 3, the Brightness function is user-configurable.
- Level 4 is optimized setting. It is compliance with TUV Low Blue Light Certification. The Brightness function is not user-configurable.



Please refer to the following to alleviate eye strains:

- Users should take some time away from the display if working for long hours. It is advised to take short breaks (at least 5 mins) after around 1 hour of continuous working at the computer. Taking short and frequent breaks is more effective than a single longer break.
- To minimize eye strain and dryness in your eyes, users should rest the eye periodically by focusing on objects that are far away.
- Eye exercises can help to reduce eye strain. Repeat these exercises often. If eye strain continues, please consult a physician. Eye exercises: (1) Repeating look up and down (2) Slowly roll your eyes (3) Move your eyes diagonal.
- High energy blue light may lead to eye strain and AMD (Age-Related Macular Degeneration). Blue light filter to reduce 70% (max.) harmful blue light to avoiding CVS (Computer Vision Syndrome).

### 3. Color

Select the image color you like from this function.

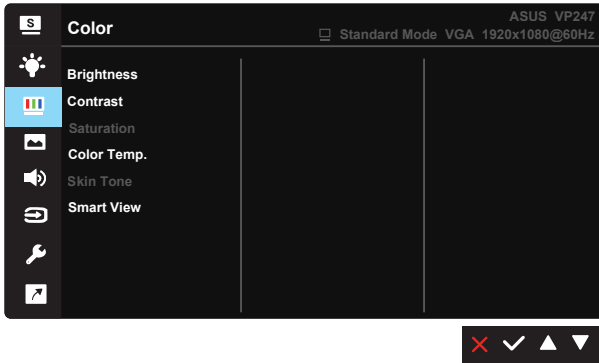

- **Brightness:** The adjusting range is from 0 to 100.
- **Contrast:** The adjusting range is from 0 to 100.
- **Saturation:** The adjusting range is from 0 to 100.
- **Color Temp.:** Contains three preset color modes (**Cool**, **Normal**, **Warm**) and **User Mode**.
- **Skin Tone:** Contains three color modes including **Reddish**, **Natural**, and **Yellowish**.
- **Smart View:** The versatile viewing positions with Smart View Technology. **(Only for VP247H/T/N/D/QG)**



- In the User Mode, colors of R (Red), G (Green), and B (Blue) are user-configurable; the adjusting range is from 0 ~ 100.

#### 4. Image

You can adjust the image Sharpness, Trace Free, Aspect Control, VividPixel, ASCR, Adaptive-Sync/FreeSync (VP247QG only), Position (VGA only), Focus (VGA only), and Auto Adjust (VGA only), from this main function.

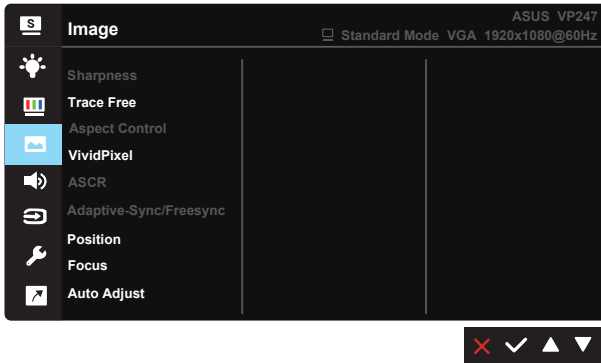

- **Sharpness:** Adjusts the picture sharpness. The adjusting range is from 0 to 100.
- **Trace Free:** Speeds up the response time by Over Drive technology. The adjusting range is from lower 0 to faster 100.
- **Aspect Control:** Adjusts the aspect ratio to “Full”, “4:3”, “Overscan(Only For HDMI)”.
- **VividPixel:** ASUS Exclusive Technology that brings lifelike visuals for crystal-clear and detail-oriented enjoyment. The adjusting range is from 0 to 100.
- **ASCR:** Select **ON** or **OFF** to enable or disable dynamic contrast ratio function.
- **Adaptive-Sync/FreeSync:** It can allow a Adaptive-Sync/FreeSync supported graphics source to dynamically adjust display refresh rate based on typical content frame rates for power efficient, virtually stutter free and low-latency display update.
- **Position:** Adjusts the horizontal position (**H-Position**) and the vertical position (**V-Position**) of the image. The adjusting range is from 0 to 100 (Only available for VGA input).
- **Focus:** Reduces Horizontal-line noise and Vertical-line noise of the image by adjusting (**Phase**) and (**Clock**) separately. The adjusting range is from 0 to 100 (Only available for VGA input).
- **Auto Adjust.:** Automatically adjust the image to its optimized position, clock, and phase. (Only available for VGA input.)



- 4:3 is only available when input source is in 4:3 format. OverScan is only available for the HDMI input source
- Phase adjusts the phase of the pixel clock signal. With a wrong phase adjustment, the screen shows horizontal disturbances.
- Clock (pixel frequency) controls the number of pixels scanned by one horizontal sweep. If the frequency is not correct, the screen shows vertical stripes and the image is not proportional.

## 5. Sound

Adjust the sound settings to your preference (only for **VP247QG**).

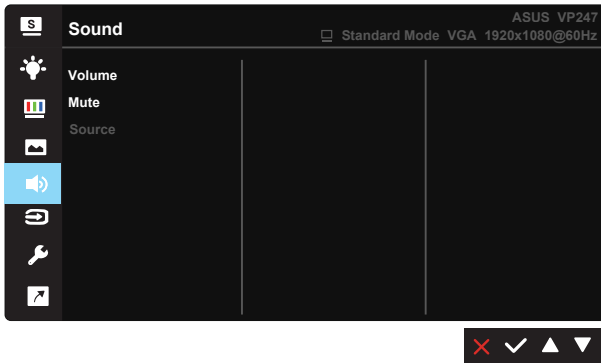

- **Volume:** Adjusts the output volume level.
- **Mute:** Mute the output volume.
- **Source:** Adjusts audio source to “Line In” or “HDMI” (only available for HDMI input); Adjusts audio source to “Line In” or “DisplayPort” (only available for DisplayPort input).

## 6. Input Select

Select the input source from **VGA**, **DVI(VP247H/T/N)**, **HDMI(Only For VP247H/QG/HAE)**, **DisplayPort(Only for VP247QG)** input signal.

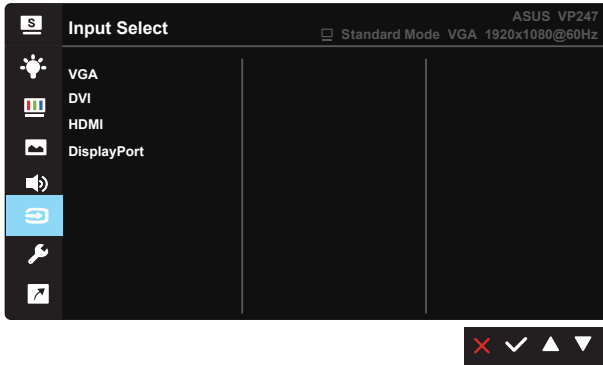

## 7. System Setup

Adjusts the system configuration.

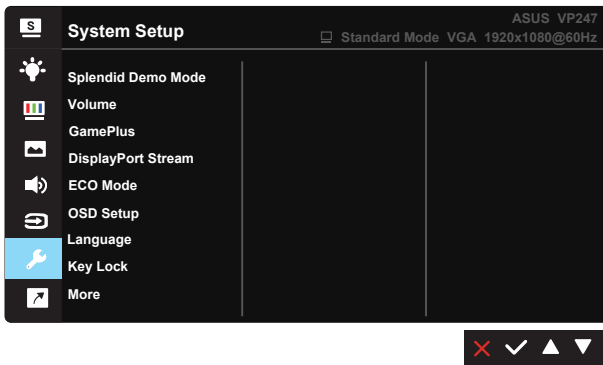



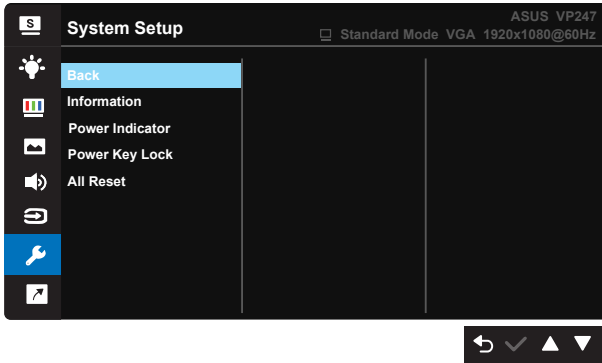

- **Splendid Demo Mode:** Activate the demo mode for the Splendid function.
- **Volume:** Adjusts the output volume level.(Only for VP247H/T)
- **GamePlus:** The GamePlus Function provides a toolkit and creates a better gaming environment for users when playing different types of games. Particularly, Aimpoint function is specially designed for new gamers or beginners interested in First Person Shooter (FPS) games.  
To active GamePlus:
  - Select **ON** to enter the GamePlus main menu.
  - Press ◀ and ▶ to select between Crosshair and Timer, FPS Counter(Only for VP247QG) and Display Alignment(Only for VP247QG) function.
  - Press ✓ to confirm the function you choose. Press ↶ to go back. Press ✖ to go off, and exit.

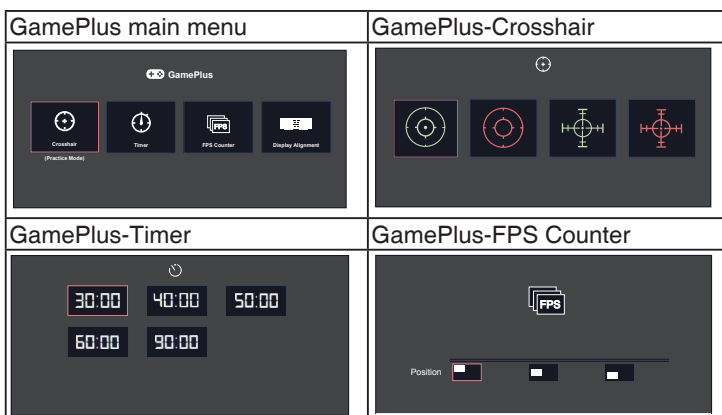

- **DisplayPort Stream:** Compatibility with graphic card. Select DP 1.1 or DP 1.2 by graphic card DP version. **(Only for VP247QG)**
- **ECO Mode:** Activate the ecology mode for power saving.
- **OSD Setup:** Adjusts the **OSD Timeout**, **DDC/CI**, and **Transparency** of the OSD screen.
- **Language:** Select OSD language. The selections are: **English, French, German, Spanish, Italian, Dutch, , Russian, Poland, Czech, Croacia, Hungary, Romania, Portugal, Turkey, Simplified Chinese, Traditional Chinese, Japanese, Korean, Persian, Thai, Indonesian.**
- **Key Lock:** Disable all key functions. Pressing the second button on the right for more than five seconds to disable key lock function.
- **More:** Return the next page of System Setting.
- **Back:** Return the previous page of System Setting.
- **Information:** Displays the monitor information.
- **Power Indicator:** Turn the power LED indicator on/off.
- **Power Key Lock:** To disable / enable power key
- **All Reset:** Selects “**Yes**” to revert all settings to the factory default mode.

## 8. Shortcut

Selecting this option allows you to set two shortcut keys.

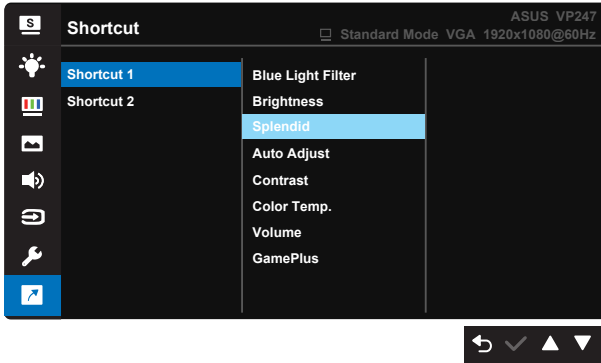

- **Shortcut 1:** User can select from “Blue Light Filter” “Splendid”, “Brightness”, “Auto Adjust(Only For VP247H/QG/HAE)”, “Contrast”, “Color Temp.”, “Volume(Only for VP247H/T/QG)”, “GamePlus”, and set as shortcut key. The default setting is Brightness.
- **Shortcut 2:** User can select from “Blue Light Filter” “Splendid”, “Brightness”, “Auto Adjust(Only For VP247H/QG/HAE)”, “Contrast”, “Color Temp.”, “Volume(Only for VP247H/T/QG)”, “GamePlus”, and set as shortcut key. The default setting is Blue Light Filter.

## 3.2 Specifications

Model	VP247H	VP247QG	VP247T	VP247N
Panel Size	23.6"W (59.94 cm)			
Max. Resolution	1920x1080			
Brightness (Typ.)	250cd/m <sup>2</sup>			
Intrinsic Contrast Ratio (Typ.)	1000:1			
Viewing Angle (CR>10)	170°(V) /160°(H)			
Display Colors	16.7 M(6bit+FRC)			
Response Time	1ms (G To G )			
Satellite Speaker	1.5W x 2 stereo			No
Sound from HDMI	Yes		No	
HDMI input	Yes		No	
DVI input	Yes	No	Yes	
D-Sub input	Yes			
DisplayPort	No	Yes	No	
Audio Line-in	Yes			No
Power ON Consumption	<16.8w			
Note	*Based on Energy Star 7.0 standard			
Chassis Colors	Black			
Power saving mode	< 0.5W			
Power off mode	< 0.5W			
Tilt	-5° ~ +20°			
VESA Wall Mounting	Yes (100mm x 100mm)			
Phys. Dimension with stand (WxHxD)	561.1mm x 400.1mm x 199.4mm			
Phys. Dimension without stand (WxHxD) (For VESA Wall Mount)	561.1mm x 335.8mm x 51.7mm			
Box Dimension (WxHxD)	617 x 457 x 135 mm			
Net Weight (Esti.)	4 kg			
Gross Weight (Esti.)	5.8 kg			
Voltage Rating	AC 100~240V(Built-in)			

<b>Model</b>	<b>VP247D</b>	<b>VP247HAE</b>
Panel Size	23.6"W (59.94 cm)	23.6"W (59.94 cm)
Max. Resolution	1920x1080	1920x1080
Brightness (Typ.)	250cd/m <sup>2</sup>	250cd/m <sup>2</sup>
Intrinsic Contrast Ratio (Typ.)	1000:1	3000:1
Viewing Angle (CR>10)	170°(V) /160°(H)	178°(V) /178°(H)
Display Colors	16.7 M(6bit+FRC)	16.7 M(6bit+FRC)
Response Time	No	5ms (G To G )
Satellite Speaker	No	No
Sound from HDMI	No	Yes
HDMI input	No	Yes
DVI input	No	No
D-Sub input	Yes	Yes
DisplayPort	No	No
Audio Line-in	No	No
Power ON Consumption	<16.8w	<16.8w
Note	*Based on Energy Star 7.0 standard	*Based on Energy Star 7.0 standard
Chassis Colors	Black	Black
Power saving mode	< 0.5W	< 0.5W
Power off mode	< 0.5W	< 0.5W
Tilt	-5° ~ +20°	-5° ~ +20°
VESA Wall Mounting	Yes (100mm x 100mm)	Yes (100mm x 100mm)
Phys. Dimension with stand (WxHxD)	561.1mm x 400.1mm x 199.4mm	561.1mm x 400.1mm x 199.4mm
Phys. Dimension without stand (WxHxD) (For VESA Wall Mount)	561.1mm x 335.8mm x 51.7mm	561.1mm x 335.8mm x 51.7mm
Box Dimension (WxHxD)	617 x 457 x 135 mm	617 x 457 x 135 mm
Net Weight (Esti.)	4 kg	4 kg
Gross Weight (Esti.)	5.8 kg	5.8 kg
Voltage Rating	AC 100~240V(Built-in)	AC 100~240V(Built-in)

### 3.3 Troubleshooting (FAQ)

Problem	Possible Solution
Power LED is not ON	<ul style="list-style-type: none"><li>• Press the  button to check if the monitor is in the ON mode.</li><li>• Check if the power cord is properly connected to the monitor and the power outlet.</li><li>• Check Power Indicator function in main menu OSD. Select "ON" to turn on power LED.</li></ul>
The power LED lights amber and there is no screen image	<ul style="list-style-type: none"><li>• Check if the monitor and the computer are in the ON mode.</li><li>• Make sure the signal cable is properly connected the monitor and the computer.</li><li>• Inspect the signal cable and make sure none of the pins are bent.</li><li>• Connect the computer with another available monitor to check if the computer is properly working.</li></ul>
Screen image is too light or dark	<ul style="list-style-type: none"><li>• Adjust the Contrast and Brightness settings via OSD.</li></ul>
Screen image bounces or a wave pattern is present in the image	<ul style="list-style-type: none"><li>• Make sure the signal cable is properly connected to the monitor and the computer.</li><li>• Move electrical devices that may cause electrical interference.</li></ul>
Screen image has color defects (white does not look white)	<ul style="list-style-type: none"><li>• Inspect the signal cable and make sure that none of the pins are bent.</li><li>• Perform Reset via OSD.</li><li>• Adjust the R/G/B color settings or select the Color Temperature via OSD.</li></ul>
No sound or sound is low (VP247H/T/QG)	<ul style="list-style-type: none"><li>• Make sure the audio cable is properly connected to the monitor.</li><li>• Adjust the volume settings of both your monitor and computer.</li><li>• Make sure the computer sound card driver is properly installed and activated.</li><li>• Make sure the audio source is correct on the OSD.</li></ul>

### 3.4 Supported Timing List

#### PC Supported Primary Timing

Resolution	Refresh Rate	Horizontal Frequency
640x480	60Hz	31.469kHz
640x480	72Hz	37.861kHz
640x480	75Hz	37.5kHz
800x600	56Hz	35.156kHz
800x600	60Hz	37.879kHz
800x600	72Hz	48.077kHz
800x600	75Hz	46.875kHz
1024x768	60Hz	48.363kHz
1024x768	70Hz	56.476kHz
1024x768	75Hz	60.023kHz
1152x864	75Hz	67.5kHz
1280x960	60Hz	60kHz
1280x1024	60Hz	63.981kHz
1280x1024	75Hz	79.976kHz
1440x900	60Hz	55.935kHz
1440x900	75Hz	70.635kHz
1680x1050	60Hz	65.29kHz
1920x1080	60Hz	67.5kHz
1920x1080(for VP247QG)	75Hz	83.894kHz

#### IBM Modes, Factory Preset Timing

Resolution	Refresh Rate	Horizontal Frequency
640x350	70Hz	31.469kHz
720x400	70Hz	31.469kHz

#### MAC Modes, Factory Preset Timing

Resolution	Refresh Rate	Horizontal Frequency
640x480	67Hz	35kHz
832x624	75Hz	49.725kHz

#### VESA Modes, User Available Timing

Resolution	Refresh Rate	Horizontal Frequency
848x480	60Hz	31.02kHz
1280x720(RB)	60Hz	44.444kHz
1280x720	60Hz	44.772kHz
1280x720	75Hz	56.456kHz
1280x768(RB)	60Hz	47.396kHz
1280x800(RB)	60Hz	49.306kHz
1280x800	60Hz	49.702kHz
1280x800	75Hz	62.795kHz
1366x768	60Hz	47.712kHz
1440x900(RB)	60Hz	55.469kHz
1440x900	75Hz	70.635kHz
1680x1050(RB)	60Hz	64.674kHz
1920x1080	60Hz	66.587kHz

## SD/HD Timings (HDMI input only)

HDMI 1.3,CEA-861B Formats, SD/HD Supported Primary Timings of (HDMI input only)

Resolution	Refresh Rate	Horizontal Frequency
640x480P	59.94 / 60Hz	31.469 / 31.5kHz
720x480P	59.94 / 60Hz	31.469 / 31.5kHz
720x576P	50Hz	31.25kHz
1280x720P	50Hz	37.5kHz
1280x720P	59.94 / 60Hz	44.955 /45kHz
1920x1080i	50Hz	28.125kHz
1920x1080i	59.94 / 60Hz	33.716 / 33.75kHz

HDMI 1.3,CEA-861B Formats, SD/HD Supported Optional Timings of (HDMI input only)

Resolution	Refresh Rate	Horizontal Frequency
1440x480P	59.94 / 60Hz	31.469 / 31.5kHz
1440x576P	50Hz	31.25kHz
1920x1080P	50Hz	56.25kHz
1920x1080P	59.94 / 60Hz	67.433 / 67.5kHz

\* The modes not listed in the above tables may not be supported. For optimal resolution, we recommend that you choose a mode listed in the above tables.



## Free Manuals Download Website

<http://myh66.com>

<http://usermanuals.us>

<http://www.somanuals.com>

<http://www.4manuals.cc>

<http://www.manual-lib.com>

<http://www.404manual.com>

<http://www.luxmanual.com>

<http://aubethermostatmanual.com>

Golf course search by state

<http://golfingnear.com>

Email search by domain

<http://emailbydomain.com>

Auto manuals search

<http://auto.somanuals.com>

TV manuals search

<http://tv.somanuals.com>