

**WS C246M
PRO**

ASUS[®]

Motherboard

Copyright© 2018 ASUSTeK COMPUTER INC. All Rights Reserved.

No part of this manual, including the products and software described in it, may be reproduced, transmitted, transcribed, stored in a retrieval system, or translated into any language in any form or by any means, except documentation kept by the purchaser for backup purposes, without the express written permission of ASUSTeK COMPUTER INC. ("ASUS").

Product warranty or service will not be extended if: (1) the product is repaired, modified or altered, unless such repair, modification of alteration is authorized in writing by ASUS; or (2) the serial number of the product is defaced or missing.

ASUS PROVIDES THIS MANUAL "AS IS" WITHOUT WARRANTY OF ANY KIND, EITHER EXPRESS OR IMPLIED, INCLUDING BUT NOT LIMITED TO THE IMPLIED WARRANTIES OR CONDITIONS OF MERCHANTABILITY OR FITNESS FOR A PARTICULAR PURPOSE. IN NO EVENT SHALL ASUS, ITS DIRECTORS, OFFICERS, EMPLOYEES OR AGENTS BE LIABLE FOR ANY INDIRECT, SPECIAL, INCIDENTAL, OR CONSEQUENTIAL DAMAGES (INCLUDING DAMAGES FOR LOSS OF PROFITS, LOSS OF BUSINESS, LOSS OF USE OR DATA, INTERRUPTION OF BUSINESS AND THE LIKE), EVEN IF ASUS HAS BEEN ADVISED OF THE POSSIBILITY OF SUCH DAMAGES ARISING FROM ANY DEFECT OR ERROR IN THIS MANUAL OR PRODUCT.

SPECIFICATIONS AND INFORMATION CONTAINED IN THIS MANUAL ARE FURNISHED FOR INFORMATIONAL USE ONLY, AND ARE SUBJECT TO CHANGE AT ANY TIME WITHOUT NOTICE, AND SHOULD NOT BE CONSTRUED AS A COMMITMENT BY ASUS. ASUS ASSUMES NO RESPONSIBILITY OR LIABILITY FOR ANY ERRORS OR INACCURACIES THAT MAY APPEAR IN THIS MANUAL, INCLUDING THE PRODUCTS AND SOFTWARE DESCRIBED IN IT.

Products and corporate names appearing in this manual may or may not be registered trademarks or copyrights of their respective companies, and are used only for identification or explanation and to the owners' benefit, without intent to infringe.

Offer to Provide Source Code of Certain Software

This product contains copyrighted software that is licensed under the General Public License ("GPL"), under the Lesser General Public License Version ("LGPL") and/or other Free Open Source Software Licenses. Such software in this product is distributed without any warranty to the extent permitted by the applicable law. Copies of these licenses are included in this product.

Where the applicable license entitles you to the source code of such software and/or other additional data, you may obtain it for a period of three years after our last shipment of the product, either

(1) for free by downloading it from <https://www.asus.com/support/>

or

(2) for the cost of reproduction and shipment, which is dependent on the preferred carrier and the location where you want to have it shipped to, by sending a request to:

ASUSTeK Computer Inc.
Legal Compliance Dept.
15 Li Te Rd.,
Beitou, Taipei 112
Taiwan

In your request please provide the name, model number and version, as stated in the About Box of the product for which you wish to obtain the corresponding source code and your contact details so that we can coordinate the terms and cost of shipment with you.

The source code will be distributed WITHOUT ANY WARRANTY and licensed under the same license as the corresponding binary/object code.

This offer is valid to anyone in receipt of this information.

ASUSTeK is eager to duly provide complete source code as required under various Free Open Source Software licenses. If however you encounter any problems in obtaining the full corresponding source code we would be much obliged if you give us a notification to the email address gpl@asus.com, stating the product and describing the problem (please DO NOT send large attachments such as source code archives, etc. to this email address).

Contents

Safety information.....	vi
About this guide.....	vii
WS C246M PRO specifications summary.....	ix
Package contents.....	xi
Installation tools and components.....	xii

Chapter 1: Product Introduction

1.1	Motherboard overview.....	1-1
1.1.1	Before you proceed.....	1-1
1.1.2	Motherboard layout.....	1-2
1.1.3	Central Processing Unit (CPU).....	1-4
1.1.4	System memory.....	1-5
1.1.5	Expansion slots.....	1-7
1.1.6	Onboard buttons and switches.....	1-8
1.1.7	Jumpers.....	1-9
1.1.8	Onboard LEDs.....	1-12
1.1.9	Internal connectors.....	1-17

Chapter 2: Basic Installation

2.1	Building your PC system.....	2-1
2.1.1	CPU installation.....	2-1
2.1.2	Cooling system installation.....	2-3
2.1.3	Motherboard installation.....	2-4
2.1.4	DIMM installation.....	2-6
2.1.5	ATX power connection.....	2-7
2.1.6	SATA device connection.....	2-7
2.1.7	Front I/O connector.....	2-8
2.1.8	Expansion card installation.....	2-9
2.1.9	M.2 installation.....	2-10
2.13	BIOS update utility.....	2-11
2.3	Motherboard rear and audio connections.....	2-13
2.3.1	Rear I/O connection.....	2-13
2.3.2	Audio I/O connections.....	2-15
2.4	Starting up for the first time.....	2-17
2.5	Turning off the computer.....	2-17

Contents

Chapter 3: BIOS Setup

3.1	Managing and updating your BIOS	3-1
3.1.1	ASUS CrashFree BIOS 3 utility.....	3-1
3.1.2	ASUS EzFlash Utility.....	3-2
3.1.3	BUPDATER utility	3-3
3.2	BIOS setup program	3-5
3.2.1	BIOS menu screen.....	3-6
3.2.2	Menu bar.....	3-6
3.2.3	Menu items.....	3-7
3.2.4	Submenu items	3-7
3.2.5	Navigation keys.....	3-7
3.2.6	General help.....	3-7
3.2.7	Configuration fields	3-7
3.2.8	Pop-up window.....	3-7
3.2.9	Scroll bar.....	3-7
3.3	Main menu	3-8
3.4	Advanced menu	3-9
3.4.1	CPU Configuration	3-10
3.4.2	Power & Performance.....	3-12
3.4.3	Server ME Configuration.....	3-14
3.4.4	Trusted Computing.....	3-14
3.4.5	ACPI Settings.....	3-15
3.4.6	APM Configuration.....	3-15
3.4.7	Runtime Error Logging Settings.....	3-16
3.4.8	Onboard LAN Configuration.....	3-16
3.4.9	Serial Port Console Redirection.....	3-17
3.4.10	Intel TXT Information.....	3-20
3.4.11	PCI Subsystem Settings	3-20
3.4.12	USB Configuration	3-21
3.4.13	Network Stack Configuration.....	3-22
3.4.14	CSM Configuration.....	3-23
3.4.15	NVMe Configuration.....	3-24
3.4.16	WHEA Configuration.....	3-24
3.4.17	TIs Auth Configuration.....	3-24
3.4.18	iSCSI Configuration	3-25
3.5	Chipset menu	3-26
3.5.1	System Agent (SA) Configuration	3-26
3.5.2	PCH-IO Configuration	3-28

Contents

3.6	Security menu	3-32
3.7	Boot menu	3-35
3.8	Monitor menu	3-37
3.9	Tool menu	3-37
3.10	Event Logs menu	3-38
3.10.1	Change Smbios Event Log Settings	3-38
3.10.2	View Smbios Event Log	3-39
3.11	Server Mgmt menu	3-39
3.11.1	System Event Log	3-41
3.11.2	Bmc self test log	3-42
3.11.3	BMC network configuration	3-42
3.11.4	View System Event Log	3-44
3.11.5	BMC User Settings	3-44
3.12	Save & Exit menu	3-44

Chapter 4: RAID Support

4.1	RAID configurations	4-1
4.1.1	RAID definitions	4-1
4.1.2	Installing Serial ATA hard disks	4-2
4.1.3	Setting the RAID item in BIOS	4-2
4.1.4	RAID configuration utilities	4-2
4.2	Intel® Rapid Storage Technology Option ROM utility	4-3
4.2.1	Creating a RAID set	4-4
4.2.2	Deleting a RAID set	4-6
4.2.3	Exiting the Intel® Rapid Storage Technology Option ROM utility	4-7
4.3	Creating a RAID driver disk	4-7
4.3.1	Creating a RAID driver disk in Windows®	4-7
4.4	Intel® Rapid Storage Technology (Windows)	4-8
4.3.1	Creating a RAID set	4-9
4.3.2	Changing a Volume Type	4-11
4.3.3	Deleting a volume	4-12
4.3.4	Preferences	4-13

Appendix

WS C246M PRO block diagram	A-1
Q-Code table	A-2
Notices	A-5
ASUS contact information	A-9

Safety information

Electrical safety

- To prevent electrical shock hazard, disconnect the power cable from the electrical outlet before relocating the system.
- When adding or removing devices to or from the system, ensure that the power cables for the devices are unplugged before the signal cables are connected. If possible, disconnect all power cables from the existing system before you add a device.
- Before connecting or removing signal cables from the motherboard, ensure that all power cables are unplugged.
- Seek professional assistance before using an adapter or extension cord. These devices could interrupt the grounding circuit.
- Ensure that your power supply is set to the correct voltage in your area. If you are not sure about the voltage of the electrical outlet you are using, contact your local power company.
- If the power supply is broken, do not try to fix it by yourself. Contact a qualified service technician or your retailer.

Operation safety

- Before installing the motherboard and adding devices on it, carefully read all the manuals that came with the package.
- Before using the product, ensure all cables are correctly connected and the power cables are not damaged. If you detect any damage, contact your dealer immediately.
- To avoid short circuits, keep paper clips, screws, and staples away from connectors, slots, sockets and circuitry.
- Avoid dust, humidity, and temperature extremes. Do not place the product in any area where it may become wet.
- Place the product on a stable surface.
- If you encounter technical problems with the product, contact a qualified service technician or your retailer.

About this guide

This user guide contains the information you need when installing and configuring the motherboard.

How this guide is organized

This guide contains the following parts:

1. Chapter 1: Product Introduction

This chapter describes the features of the motherboard and the new technology it supports. It includes description of the switches, jumpers, and connectors on the motherboard.

2. Chapter 2: Basic Installation

This chapter lists the hardware setup procedures that you have to perform when installing system components.

3. Chapter 3: BIOS Setup

This chapter tells how to change system settings through the BIOS Setup menus. Detailed descriptions of the BIOS parameters are also provided.

4. Chapter 4: RAID Support

This chapter describes the RAID configurations.

Where to find more information

Refer to the following sources for additional information and for product and software updates.

1. ASUS website

The ASUS website (www.asus.com) provides updated information on ASUS hardware and software products.

2. Optional documentation

Your product package may include optional documentation, such as warranty flyers, that may have been added by your dealer. These documents are not part of the standard package.

Conventions used in this guide

To ensure that you perform certain tasks properly, take note of the following symbols used throughout this manual.



DANGER/WARNING: Information to prevent injury to yourself when trying to complete a task.



CAUTION: Information to prevent damage to the components when trying to complete a task.



IMPORTANT: Instructions that you **MUST** follow to complete a task.



NOTE: Tips and additional information to help you complete a task.

Typography

Bold text

Indicates a menu or an item to select.

Italics

Used to emphasize a word or a phrase.

<Key>

Keys enclosed in the less-than and greater-than sign means that you must press the enclosed key.

Example: <Enter> means that you must press the Enter or Return key.

<Key1> + <Key2> + <Key3>

If you must press two or more keys simultaneously, the key names are linked with a plus sign (+).

WS C246M PRO specifications summary

CPU	LGA1151 socket for Intel® Xeon® Processor E Family (Coffee Lake) / Intel® Pentium™ processors / Intel® Celeron™ processors* Supports Intel® Turbo Boost Technology * Refer to www.asus.com for Intel® CPU support list
Chipset	Intel® C246 Chipset
Memory	4 x DIMM, Max 64GB, DDR4 2666 / 2400 / 2133 MHz, ECC/ non-ECC UDIMM* Dual channel architecture * Refer to www.asus.com for the Memory QVL(Qualified Vendors List)
Expansion slots	PCIEX1_1: PCI-E x1 slot, x1 Gen3 Link, from PCH PCIEX16_1: PCI-E x16 slot, x16 Gen3 Link PCIEX8_1: PCI-E x8 slot, x4 Gen3 Link, from PCH
VGA Output	Integrated Graphics Processor x 1 Multi-VGA output support: HDMI/DisplayPort/VGA - Supports HDMI with Max resolution 4096 x 2160@24 Hz - Supports DisplayPort with Max resolution 4096 x 2304@60 Hz - Supports VGA with Max resolution 1920 x 1200@60 Hz
Storage	Intel® C246 Chipset: - 8 x SATA 6Gb/s ports or - 7 x SATA 6Gb/s with 1 x M.2 (SATA 6Gb/s & PCI-E Gen3 x4 link, NGFF 2280 / 2260 / 2242 / 2230) Intel® RST (Windows & Linux) (Support software RAID 0, 1, 10 & 5)
LAN	1 x Intel® I210-AT GbE LAN 1 x Intel® I219-LM GbE LAN (Supports teaming function)
USB	Intel® C246 Chipset - 6 x USB 2.0 ports (4 from mid-board, 2 ports at back panel) - 4 x USB 3.1 Gen 1 ports (2 from mid-board, 2 ports at back panel) - 2 x USB 3.1 Gen 2 ports (2 Type-A ports at back panel)
Audio	Realtek® ALC887 8-channel high definition audio CODEC - Optical S/PDIF out port at back I/O

(continued on the next page)

WS C246M PRO specifications summary

Rear Panel I/O Ports	<ul style="list-style-type: none"> - 2 x USB 3.1 Gen 2 ports (Type-A) - 2 x USB 3.1 Gen 1 ports - 2 x USB 2.0 ports - 1 x HDMI - 1 x DisplayPort - 1 x VGA - 2 x RJ-45 ports - 8-channel Audio I/O ports (5+1 Audio jacks)
Internal I/O Connectors	<ul style="list-style-type: none"> - 2 x USB 2.0 connectors support additional 4 USB ports (9-pin) - 1 x USB 3.1 Gen 1 connectors support additional 2 USB ports (19-pin) - 8 x SATA 6.0 Gb/s ports - 1 x M.2 Socket - 24-pin EATX Power connector - 8-pin EATX 12V Power connector - CPU fan with PWM control - Front Fan 1~3 - Rear Fan 1 - 1 x AAFP connector - 1 x COM port header - 1 x TPM header - 1 x Chassis intrusion header - 1 x S/PDIF Out header - 19-pin front panel connector - 18-pin AUX panel connector
BIOS Feature	32 MB Flash ROM, EFI AMI BIOS, PnP, DMI3.0, WfM2.0, SM BIOS 3.0, ACPI 5.0a, ASUS EZ Flash Utility, ASUS CrashFree BIOS 3
Manageability	WfM 2.0, DMI 3.0, WOL by PME, WOR by PME, PXE
OS	<ul style="list-style-type: none"> Windows 2016/64 bit Windows 10/64 bit RedHat® Enterprise Linux SUSE Linux Enterprise Server
Form Factor	Micro ATX Form Factor, 9.6" x 9.6" (244mm x 244mm)



- Specifications are subject to change without notice.
- Visit the ASUS website for the software manual.

Package contents

Check your motherboard package for the following items.

Motherboard	1 x WS C246M PRO motherboard
Cables	6 x Serial ATA 6Gb/s cables
	1 x USB 2.0 bracket cable
Accessories	2 x M.2 screws kits
	1 x COM port brackets
	1 X I/O shield
Application DVD	1 x Motherboard support DVD
Documentation	1 x User guide



If any of the above items is damaged or missing, contact your retailer.

Installation tools and components

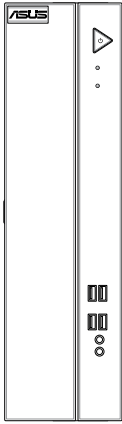

PC chassis

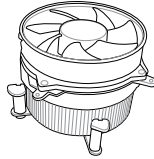

Intel® LGA1151 compatible CPU Fan

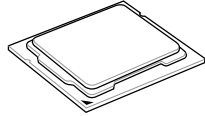

Intel® LGA1151 CPU

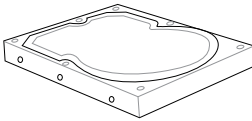

SATA hard disk drive



Phillips (cross) screwdriver

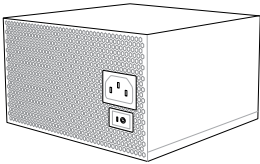

Power supply unit

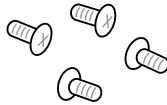

1 bag of screws

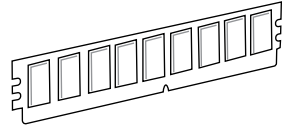

DIMM

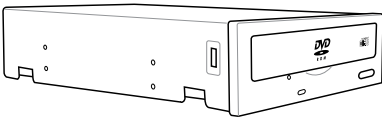

SATA optical disc drive (optional)

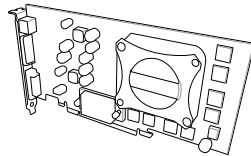

Graphics card



The tools and components in the table above are not included in the motherboard package.

Product Introduction

1

1.1 Motherboard overview

1.1.1 Before you proceed

Take note of the following precautions before you install motherboard components or change any motherboard settings.



-
- Unplug the power cord from the wall socket before touching any component.
 - Before handling components, use a grounded wrist strap or touch a safely grounded object or a metal object, such as the power supply case, to avoid damaging them due to static electricity.
 - Hold components by the edges to avoid touching the ICs on them.
 - Whenever you uninstall any component, place it on a grounded antistatic pad or in the bag that came with the component.
 - Before you install or remove any component, ensure that the ATX power supply is switched off or the power cord is detached from the power supply. Failure to do so may cause severe damage to the motherboard, peripherals, or components.
-

1.1.2 Motherboard layout

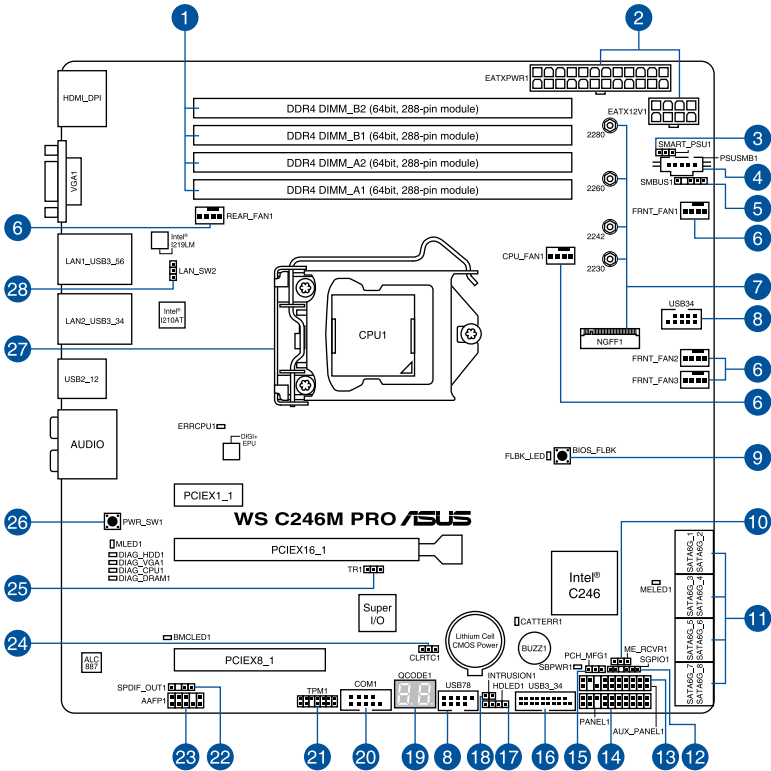

Refer to [1.1.9 Internal connectors](#) and [2.3.1 Rear I/O connection](#) for more information about rear panel connectors and internal connectors.

Layout contents

Connectors/Jumpers/Buttons and switches/Slots	Page
1. DDR4 DIMM slots	1-5
2. ATX power connectors (24-pin EATXPWR1; 8-pin EATX12V1)	1-24
3. Smart Ride Through (SmaRT) setting (3-pin SMART_PSU1)	1-11
4. Power Supply SMBus connector (5-pin PSUSMB1)	1-25
5. System Management Bus (SMBUS) connector (5-1 pin SMBUS1)	1-26
6. Fan connectors (4-pin CPU_FAN1; 4-pin FRNT_FAN1-3; 4-pin REAR_FAN1)	1-21
7. M.2 (NGFF) connector (NGFF1)	1-28
8. USB 2.0 connectors (10-1 pin USB34, USB78)	1-20
9. BIOS Flashback button	2-11
10. ME firmware force recovery setting (3-pin ME_RCVR1)	1-10
11. Intel® Serial ATA 6 Gb/s connectors (7-pin SATA6G_1-8)	1-17
12. Serial General Purpose Input/Output connector (6-1 pin SGPIO1)	1-25
13. Auxiliary panel connector (20-2 pin AUX_PANEL1)	1-23
14. System panel connector (20-1 pin PANEL1)	1-22
15. PCH_MFG1 setting (3-pin PCH_MFG1)	1-11
16. USB 3.1 Gen 1 connector (20-1 pin USB3_12)	1-19
17. Storage device activity LED connector (4-pin HDLED1)	1-20
18. Chassis Intrusion (2-pin INTRUSION1)	1-26
19. Q-Code LED	1-16
20. Serial port connector (10-1 pin COM1)	1-19
21. TPM connector (14-1 pin TPM1)	1-18
22. Digital audio connector (4-1 pin SPDIF_OUT1)	1-21
23. Front panel audio connector (10-1 pin AAFP)	1-18
24. Clear RTC RAM (3-pin CLRTC1)	1-9
25. Thermal sensor cable connector (3-pin TR1)	1-23
26. Power-on button	1-8
27. LGA1151 CPU socket	1-4
28. LAN controller setting (3-pin LAN_SW2)	1-10

1.1.3 Central Processing Unit (CPU)

The motherboard comes with a surface mount LGA1151 socket designed for the Intel® Xeon® Processor E Family (Coffee Lake) / Intel® Pentium™ processors / Intel® Celeron™ processors.

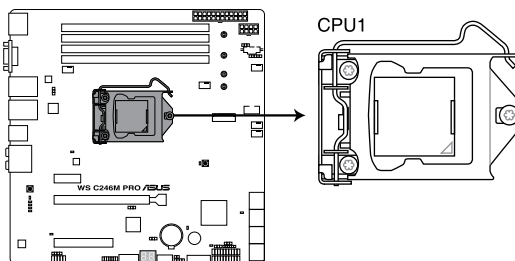

WS C246M PRO CPU LGA1151



Ensure that you install the correct CPU designed for LGA1151 socket only. DO NOT install a CPU designed for other sockets on the LGA1151 socket.



- Ensure that all power cables are unplugged before installing the CPU.
 - Upon purchase of the motherboard, ensure that the PnP cap is on the socket and the socket contacts are not bent. Contact your retailer immediately if the PnP cap is missing, or if you see any damage to the PnP cap/socket contacts/motherboard components. ASUS will shoulder the cost of repair only if the damage is shipment/transit-related.
 - Keep the cap after installing the motherboard. ASUS will process Return Merchandise Authorization (RMA) requests only if the motherboard comes with the cap on the LGA2066 socket.
 - The product warranty does not cover damage to the socket contacts resulting from incorrect CPU installation/removal, or misplacement/loss/incorrect removal of the PnP cap.
-

1.1.4 System memory

The motherboard comes with four DDR 4 (Double Data Rate 4) Dual Inline Memory Modules (DIMM) slots.



A DDR4 module is notched differently from a DDR, DDR2 or DDR3 module. DO NOT install a DDR, DDR2 or DDR3 memory module to the DDR4 slot.

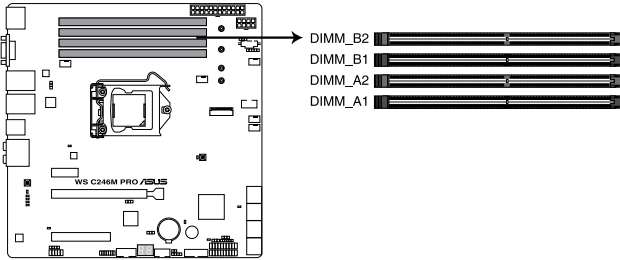

WS C246M PRO 288-pin DDR4 DIMM sockets

Recommended memory configurations

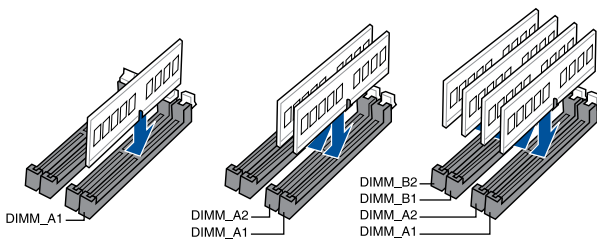

Memory configurations

You may install 2 GB, 4 GB, 8 GB and 16 GB unbuffered and ECC and non-ECC DDR4 DIMMs into the DIMM sockets.



You may install varying memory sizes in Channel A and Channel B. The system maps the total size of the lower-sized channel for the dual-channel configuration. Any excess memory from the higher-sized channel is then mapped for single-channel operation.



- The default memory operation frequency is dependent on its Serial Presence Detect (SPD), which is the standard way of accessing information from a memory module. Under the default state, some memory modules for overclocking may operate at a lower frequency than the vendor-marked value.
 - For system stability, use a more efficient memory cooling system to support a full memory load (8 DIMMs) or overclocking condition.
 - Always install the DIMMS with the same CAS Latency. For an optimum compatibility, we recommend that you install memory modules of the same version or data code (D/C) from the same vendor. Check with the vendor to get the correct memory modules.
 - Visit the ASUS website for the latest QVL.
-

1.1.5 Expansion slots



Unplug the power cord before adding or removing expansion cards. Failure to do so may cause you physical injury and damage motherboard components.

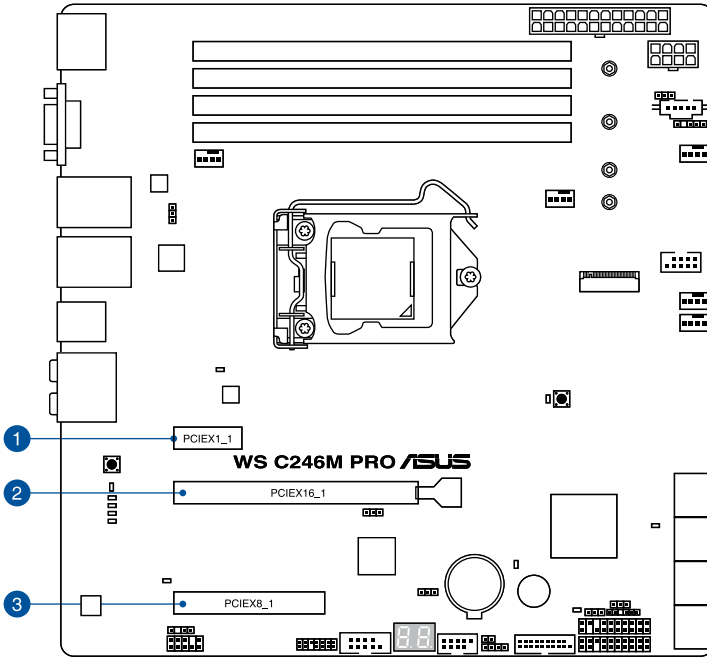

Slot No.	Slot Description
1	PCIe x1_1 slot
2	PCIe x16_1 slot
3	PCIe x8_1 slot

VGA / PCIe configuration	PCI Express 3.0 operating mode	
	Single VGA / PCIe card	
PCIe 3.0 x1_1	N/A	
PCIe 3.0 x16_1	X16	
PCIe 3.0 x8_1	N/A	

1.1.6 Onboard buttons and switches

Onboard buttons and switches allow you to fine-tune performance when working on a bare or open-case system. This is ideal for overclockers and gamers who continually change settings to enhance system performance.

1. Power-on button

The motherboard comes with a power-on button that allows you to power up or wake up the system. The LED near the button also lights up when the system is plugged to a power source indicating that you should shut down the system and unplug the power cable before removing or installing any motherboard component.

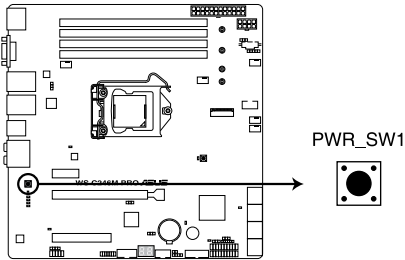

WS C246M PRO Power on button

1.1.7 Jumpers

1. Clear RTC RAM (3-pin CLRRTC1)

This jumper allows you to clear the Real Time Clock (RTC) RAM in CMOS. You can clear the CMOS memory of date, time, and system setup parameters by erasing the CMOS RTC RAM data. The onboard button cell battery powers the RAM data in CMOS, which include system setup information such as system passwords.

To erase the RTC RAM:

1. Turn OFF the computer and unplug the power cord.
2. Move the jumper cap from pins 1-2 (default) to pins 2-3. Keep the cap on pins 2-3 for about 5-10 seconds, then move the cap back to pins 1-2.
3. Plug the power cord and turn ON the computer.
4. Hold down the key during the boot process and enter BIOS setup to reenter data.



Except when clearing the RTC RAM, never short-circuit the CLRRTC1 jumper. Shorting the CLRRTC1 jumper will cause system boot failure!



If the steps above do not help, remove the onboard battery and move the jumper again to clear the CMOS RTC RAM data. After the CMOS clearance, reinstall the battery.

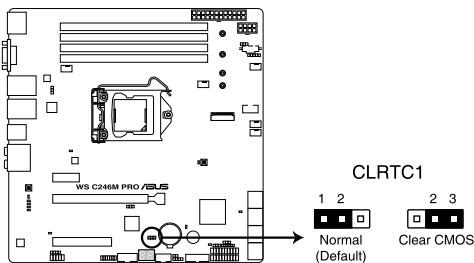

WS C246M PRO Clear RTC RAM

2. LAN controller setting (3-pin LAN_SW2)

This jumper allows you to enable or disable the onboard Intel® I210-AT Gigabit (LAN_SW2) controller. Set to pins 1–2 to activate the Gigabit LAN feature.

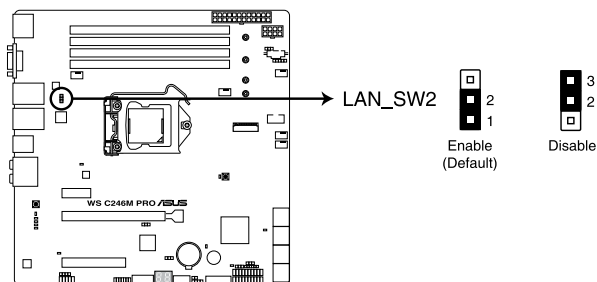

3. ME firmware force recovery setting (3-pin ME_RCVR1)

This jumper allows you to force Intel® Management Engine (ME) boot from recovery mode when ME becomes corrupted.

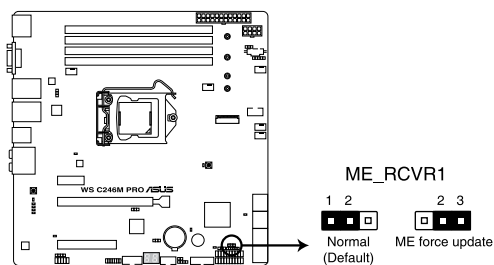

WS C246M PRO ME recovery setting

4. PCH_MFG1 setting (3-pin PCH_MFG1)

This jumper allows you to update the BIOS ME block.

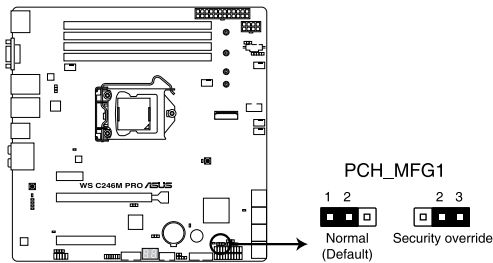

WS C246M PRO PCH_MFG1 setting

5. Smart Ride Through (SmaRT) setting (3-pin SMART_PSU1)

This jumper allows you to enable or disable the Smart Ride Through (SmaRT) function. This feature is enabled by default. Set to pins 2-3 to disable it. When enabled, SmaRT allows uninterrupted operation of the system during an AC loss event.

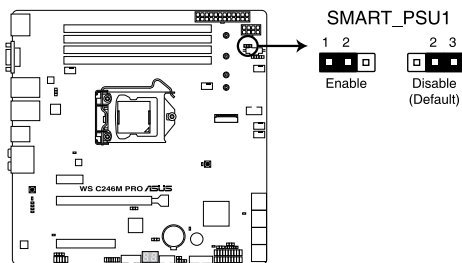

WS C246M PRO Smart Ride Through setting

1.1.8 Onboard LEDs

1. Diagnosis LEDs

The Diagnosis LEDs provide the status of these key components during POST (Power-On-Self Test): CPU, memory modules, VGA card, and hard disk drives. If an error is found, the critical component's LED stays lit up until the problem is solved.

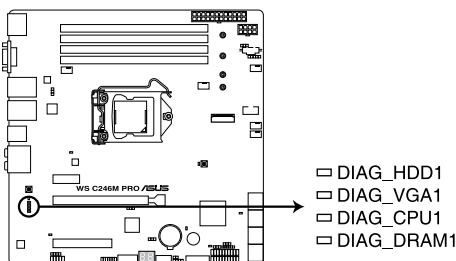

WS C246M PRO Diagnosis LED



The Diagnosis LEDs provide the most probable cause of an error code as a starting point for troubleshooting. The actual cause may vary from case to case.

2. Standby Power LED (SBPWR1)

The motherboard comes with a standby power LED. The green LED lights up to indicate that the system is ON, in sleep mode, or in soft-off mode. This is a reminder that you should shut down the system and unplug the power cable before removing or plugging in any motherboard component. The illustration below shows the location of the onboard LED.

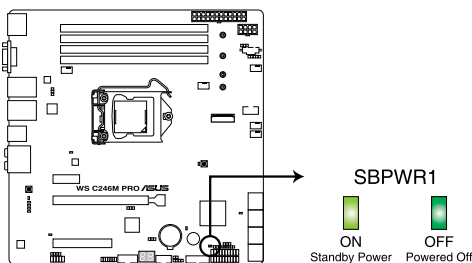

WS C246M PRO Standby Power LED

3. CPU Warning LED (ERRCPU1)

The CPU warning LED lights up to indicate that a CPU error or failure has occurred.

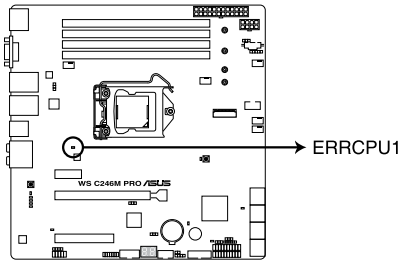

WS C246M PRO ERRCPU1 LED

4. Message LED (MLED1)

This onboard LED lights up to indicate that there is a temperature warning or a BMC event log is generated.

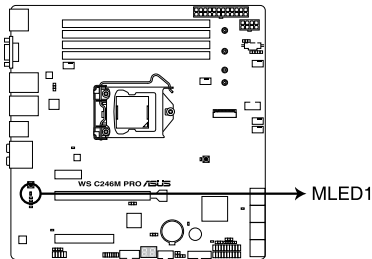

WS C246M PRO MLED1

5. BMC LED (BMCLED1)

The BMC LED lights up to indicate that the on-board BMC is functional.

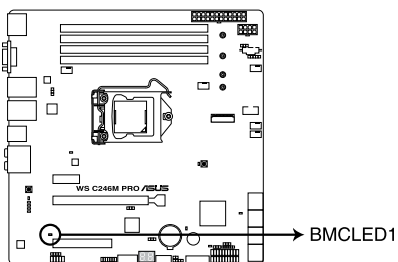

WS C246M PRO BMC LED

6. ME LED (MELED1)

The ME LED is an onboard LED that blinks when the ME is operating properly.

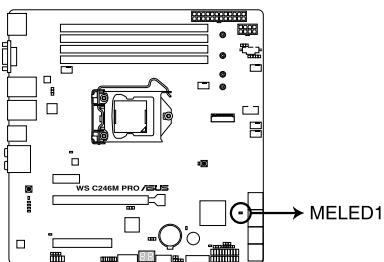

WS C246M PRO MELED1

7. CATT ERR LED (CATTERR1)

The CATT ERR LED indicates that the system has experienced a fatal or catastrophic error and cannot continue to operate.

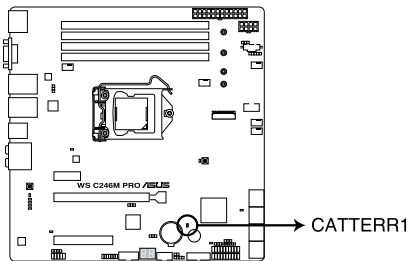

WS C246M PRO CATTERR1 LED

8. USB BIOS Flashback LED (FLBK_LED)

The BIOS Flashback LED flashes when you press the BIOS Flashback button for BIOS update.

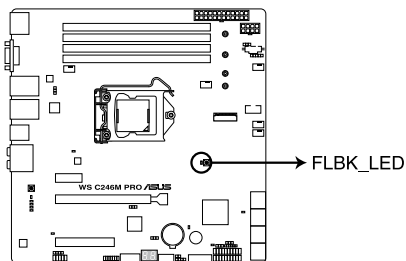

WS C246M PRO FLBK LED

9. Q-Code LED

The Q-Code LED design provides you with a 2-digit error code that displays the system status.

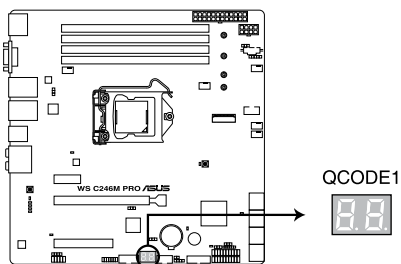

WS C246M PRO Q-Code LED



-
- The Q-Code LED provides the most probable cause of an error code as a starting point for troubleshooting. The actual cause may vary from case to case.
 - Please refer to the Q-Code table in the **Appendix** section for more details.
-

1.1.9 Internal connectors

1. Intel® Serial ATA 6 Gb/s connectors (7-pin SATA6G_1-8)

These connectors connect to Serial ATA 6 Gb/s hard disk drives via Serial ATA 6 Gb/s signal cables.

If you installed Serial ATA hard disk drives, you can create a RAID 0, 1, 5, and 10 configuration with the Intel® Rapid Storage Technology enterprise through the onboard Intel® C246 chipset.

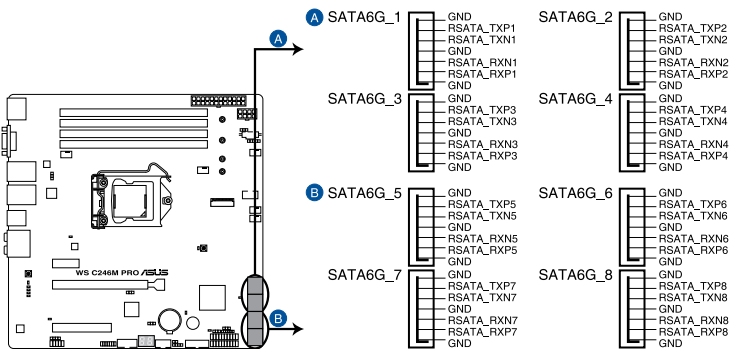

WS C246M PRO Intel® Serial ATA 6 Gb/s connectors



These connectors are set to **[AHCI Mode]** by default. If you intend to create a Serial ATA RAID set using these connectors, set the SATA Mode item in the BIOS to **[Intel RST Premium (RAID)]**.

2. Front panel audio connector (10-1 pin AAFP)

This connector is for a chassis-mounted front panel audio I/O module that supports HD Audio. Connect one end of the front panel audio I/O module cable to this connector.

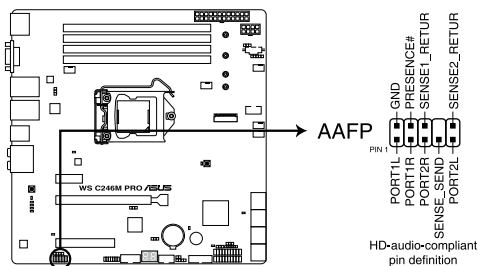

WS C246M PRO Front panel audio connector



We recommend that you connect a high-definition front panel audio module to this connector to avail of the motherboard's high-definition audio capability.

3. TPM connector (14-1 pin TPM1)

This connector supports a Trusted Platform Module (TPM) system, which securely store keys, digital certificates, passwords and data. A TPM system also helps enhance network security, protect digital identities, and ensures platform integrity.

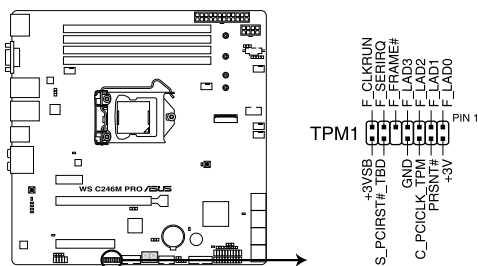

WS C246M PRO TPM connector



The TPM module is purchased separately.

4. Serial port connector (10-1 pin COM1)

This connector is for a serial (COM) port. Connect the serial port module cable to this connector, then install the module to a slot opening at the back of the system chassis.

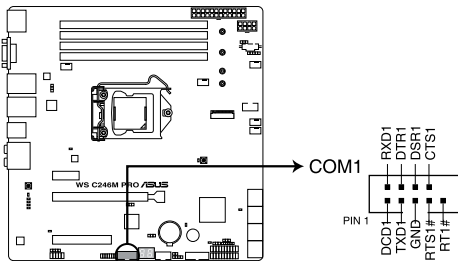

WS C246M PRO Serial port connectors

5. USB 3.1 Gen 1 connector (20-1 pin USB3_12)

This connector allows you to connect a USB 3.1 Gen 1 module for additional USB 3.1 Gen 1 front or rear panel ports. With an installed USB 3.1 Gen 1 module, you can enjoy all the benefits of USB 3.1 Gen 1 including faster data transfer speeds of up to 5 Gb/s, faster charging time for USB-chargable devices, optimized power efficiency, and backward compatibility with USB 2.0.

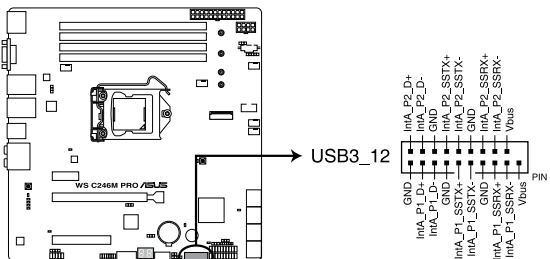

WS C246M PRO USB 3.0 connector



The USB 3.1 Gen 1 module is purchased separately.



The plugged USB 3.1 Gen 1 device may run on xHCI or EHCI mode depending on the operating system's setting.

6. USB 2.0 connectors (10-1 pin USB34, USB78)

The 10-1 pin connector allows you to connect a USB 2.0 module for additional USB 2.0 front or rear panel ports. These USB connectors comply with USB 2.0 specification that supports up to 480 Mbps connection speed.

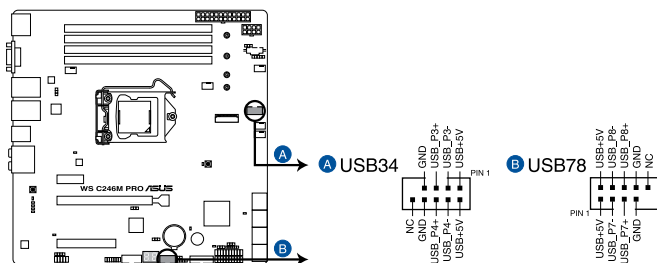

WS C246M PRO USB 2.0 connectors



DO NOT connect a 1394 cable to the USB connectors. Doing so will damage the motherboard!

7. Storage device activity LED connector (4-pin HDLED1)

This LED connector is for the storage add-on card cable connected to the SATA or SAS add-on card. The read or write activities of any device connected to the SATA or SAS add-on card causes the front panel LED to light up.

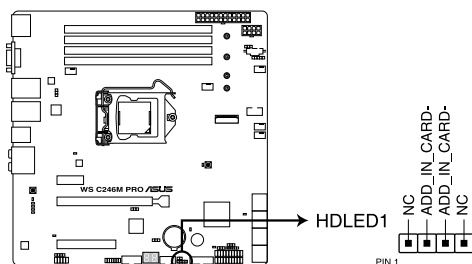

WS C246M PRO Storage device activity LED connector

8. Fan connectors (4-pin CPU_FAN1; 4-pin FRNT_FAN1-3; 4-pin REAR_FAN1)

Connect the fan cables to the fan connectors on the motherboard, ensuring that the black wire of each cable matches the ground pin of the connector.

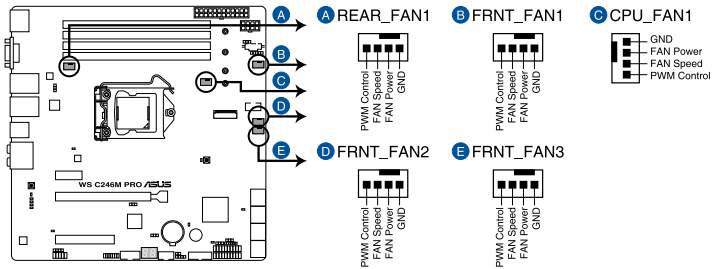

WS C246M PRO FAN connectors



- DO NOT forget to connect the fan cables to the fan connectors. Insufficient air flow inside the system may damage the motherboard components. These are not jumpers! Do not place jumper caps on the fan connectors!
- Ensure that the CPU fan cable is securely installed to the CPU fan connector.

8. Digital audio connector (4-1 pin SPDIF_OUT1)

This connector is for an additional Sony/Philips Digital Interface (S/PDIF) port. Connect the S/PDIF Out module cable to this connector, then install the module to a slot opening at the back of the system chassis.

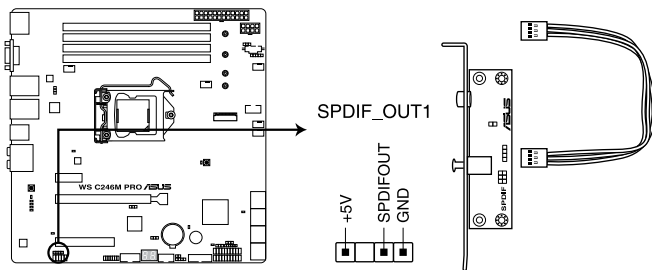

WS C246M PRO Digital audio connector



The S/PDIF module is purchased separately.

10. System panel connector (20-1 pin PANEL1)

This connector supports several chassis-mounted functions.

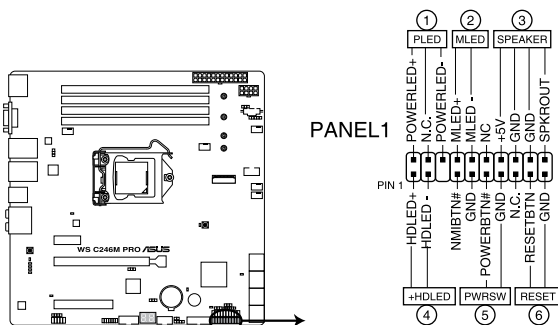

WS C246M PRO System panel connector

- **System power LED (3-pin PLED)**

This 3-pin connector is for the system power LED. Connect the chassis power LED cable to this connector. The system power LED lights up when you turn on the system power, and blinks when the system is in sleep mode.

- **Message LED (2-pin MLED)**

This 2-pin connector is for the message LED cable that connects to the front message LED. The message LED is controlled by the BMC to indicate an abnormal event occurrence.

- **System warning speaker (4-pin SPEAKER)**

This 4-pin connector is for the chassis-mounted system warning speaker. The speaker allows you to hear system beeps and warnings.

- **Hard disk drive activity LED (2-pin +HDLED)**

This 2-pin connector is for the HDD Activity LED. Connect the HDD Activity LED cable to this connector. The LED lights up or flashes when data is read from or written to the HDD.

- **Power button/soft-off button (2-pin PWRSW)**

This connector is for the system power button. Pressing the power button turns the system on or puts the system in sleep or soft-off mode depending on the BIOS settings. Pressing the power switch for more than four seconds while the system is ON turns the system OFF.

- **Reset button (2-pin RESET)**

This 2-pin connector is for the chassis-mounted reset button for system reboot without turning off the system power.

11. Auxiliary panel connector (20-2 pin AUX_PANEL1)

This connector is for additional front panel features including front panel SMB, locator LED and switch, chassis intrusion, and LAN LEDs.

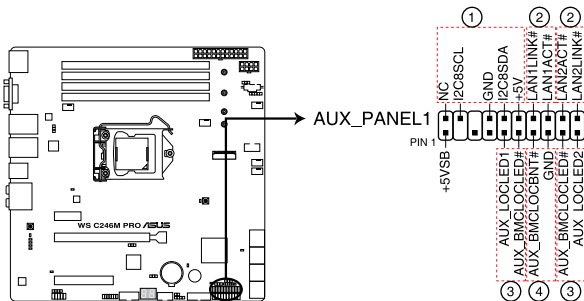

WS C246M PRO Auxiliary panel connector

- **Front panel SMB (6-1 pin FPSMB)**

This 6-1 pin connector is for the front panel SMBus cable.

- **LAN activity LED (2-pin LAN1_LED, LAN2_LED)**

This 2-pin connector is for the Gigabit LAN activity LEDs on the front panel.

- **Locator LED (2-pin LOCATORLED1, 2-pin LOCATORLED2)**

This 2-pin connector is for the locator LED1 and LED2 on the front panel. Connect the Locator LED cables to these 2-pin connector. The LEDs will light up when the Locator button is pressed.

- **Locator Button/Switch (2-pin LOCATORBTN)**

This 2-pin connector is for the locator button on the front panel. This button queries the state of the system locator.

12. Thermal sensor cable connector (3-pin TR1)

This connector allows you to connect a thermal sensor cable that is used for monitoring temperature. Connect the thermal sensor cable to the connector and place its probe to the device that you want to monitor.

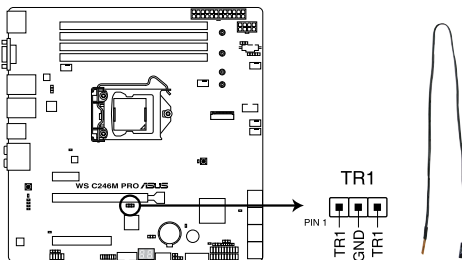

WS C246M PRO Thermal sensor cable connector

13. ATX power connectors (24-pin EATXPWR1; 8-pin EATX12V1)

These connectors are for ATX power supply plugs. The power supply plugs are designed to fit these connectors in only one orientation. Find the proper orientation and push down firmly until the connectors completely fit.

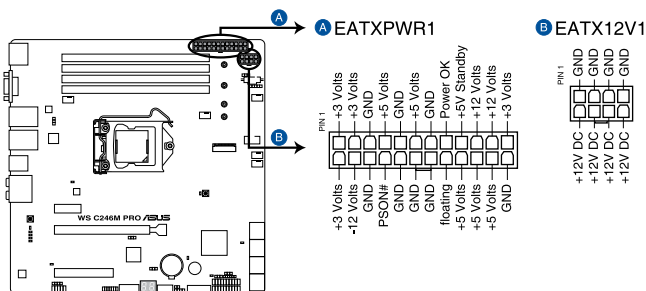

WS C246M PRO ATX power connectors



Ensure to connect the 8-pin power plug.



- For a fully configured system, we recommend that you use a power supply unit (PSU) that complies with ATX 12 V Specification 2.0 (or later version) and provides a minimum power of 350 W.
- DO NOT forget to connect the 8-pin EATX12V1 power plug. Otherwise, the system will not boot.
- We recommend that you use a PSU with a higher power output when configuring a system with more power-consuming devices. The system may become unstable or may not boot up if the power is inadequate.

14. Serial General Purpose Input/Output connector (6-1 pin SGPIO1)

The SGPIO1 connector is used for the Intel Rapid Storage Technology Enterprise SGPIO interface that controls the LED pattern generation, device information, and general purpose data.

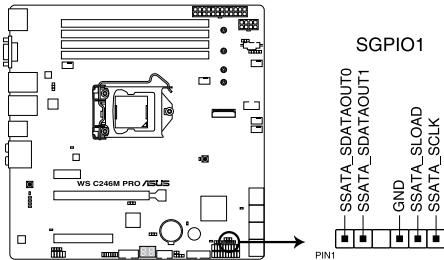

WS C246M PRO SGPIO1 connector

15. Power Supply SMBus connector (5-pin PSUSMB1)

This connector allows you to connect SMBus (System Management Bus) to the PSU (power supply unit) to read PSU information. Devices communicate with an SMBus host and/or other SMBus devices using the SMBus interface.

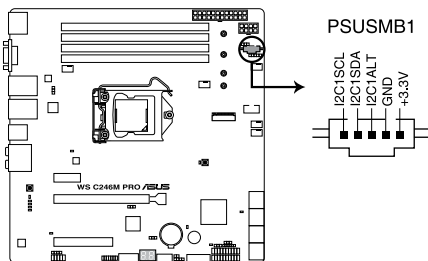

WS C246M PRO Power supply SMBus connector

16. Chassis Intrusion (2-pin INTRUSION1)

These leads are for the intrusion detection feature for chassis with intrusion sensor or microswitch. When you remove any chassis component, the sensor triggers and sends a high level signal to these leads to record a chassis intrusion event. The default setting is to short the CHASSIS# and the GND pin by a jumper cap to disable the function.

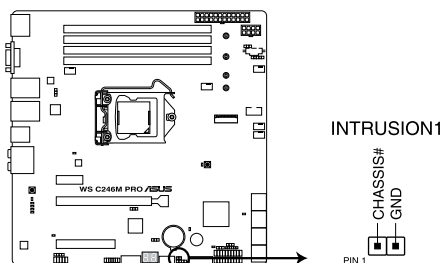

WS C246M PRO Chassis Intrusion connector

17. System Management Bus (SMBUS) connector (5-1 pin SMBUS1)

This connector controls the system and power management-related tasks. This connector processes the messages to and from devices rather than tripping the individual control lines.

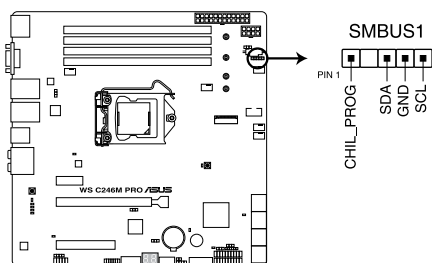

WS C246M PRO SMBUS connector

18. M.2 (NGFF) connector (NGFF1)

This connector allows you to install an M.2 device.

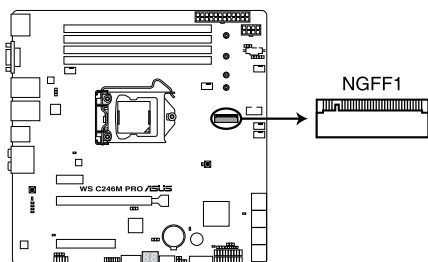

WS C246M PRO NGFF connector



- NGFF1 socket supports PCIe 3.0 x4 and SATA mode M Key design and type 2242 / 2260 / 2280 / 22110 PCIe and SATA storage devices.
- When the NGFF1 connector is operating in SATA mode, SATA connector 8 (SATA 6 Gbps_8) will be disabled.
- These sockets support IRST (Intel® Rapid Storage Technology).



The M.2 SSD module is purchased separately.

Basic Installation

2

2.1 Building your PC system



The diagrams in this section are for reference only. The motherboard layout may vary with models, but the installation steps are the same for all models.

2.1.1 CPU installation



- Ensure that you install the correct CPU designed for LGA1151 socket only. **DO NOT** install a CPU designed for LGA1155 and LGA1156 sockets on the LGA1151 socket.
- Upon purchase of the motherboard, ensure that the PnP cap is on the socket and the socket contacts are not bent. Contact your retailer immediately if the PnP cap is missing, or if you see any damage to the PnP cap/socket contacts/motherboard components. ASUS will shoulder the cost of repair only if the damage is shipment/transit-related.
- The product warranty does not cover damage to the socket contacts resulting from incorrect CPU installation/removal, or misplacement/loss/incorrect removal of the PnP cap.

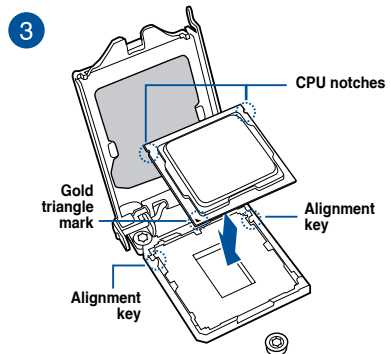
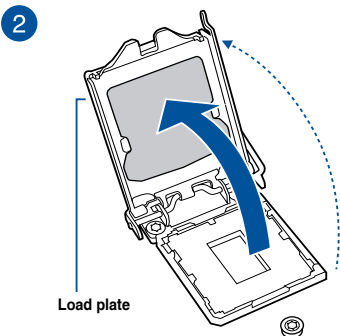
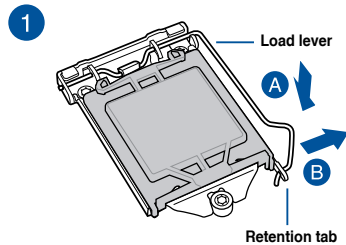
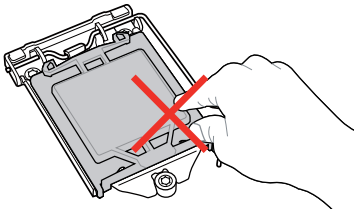

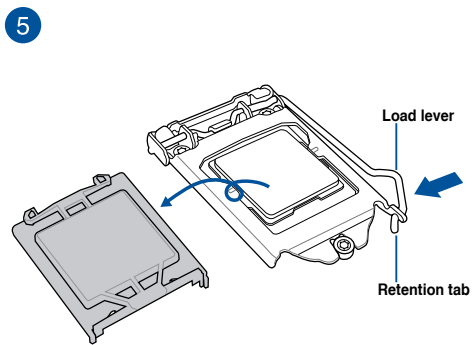
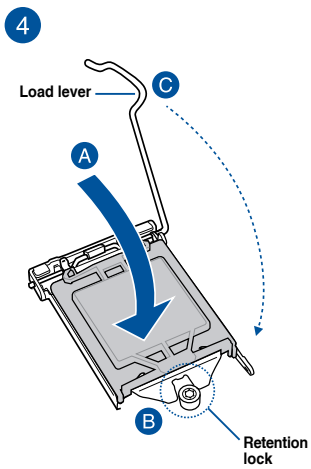

2.1.2 Cooling system installation

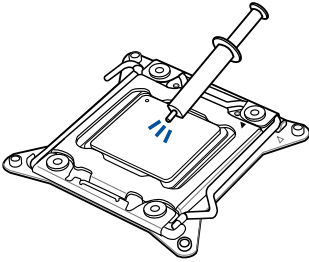

Apply the Thermal Interface Material to the CPU cooling system and CPU before you install the cooling system, if necessary.

To install the CPU heatsink and fan assembly

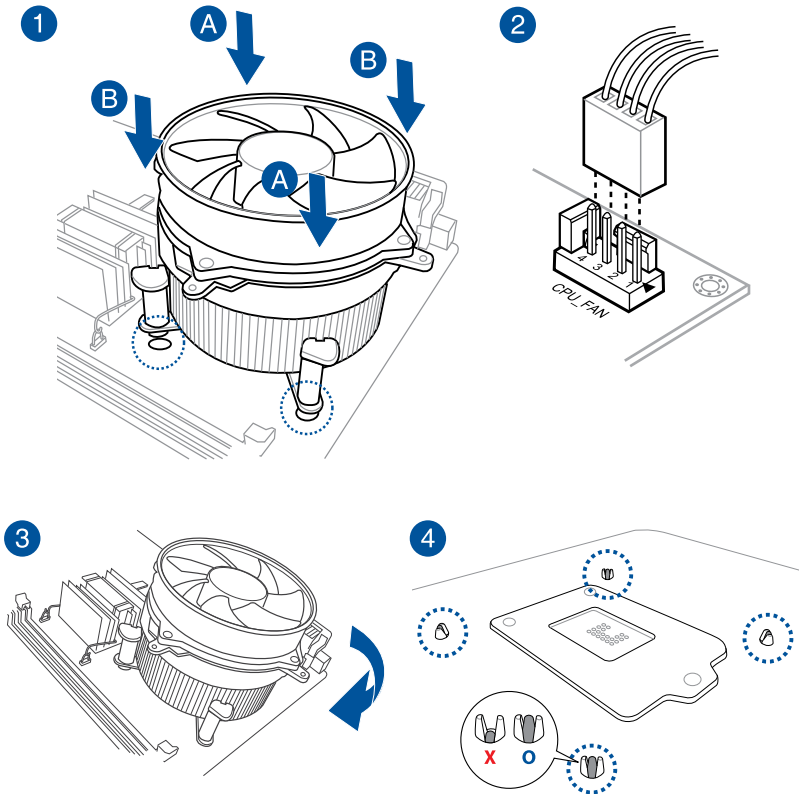

2.1.3 Motherboard installation

1. Install the ASUS Q-Shield to the chassis rear I/O panel.

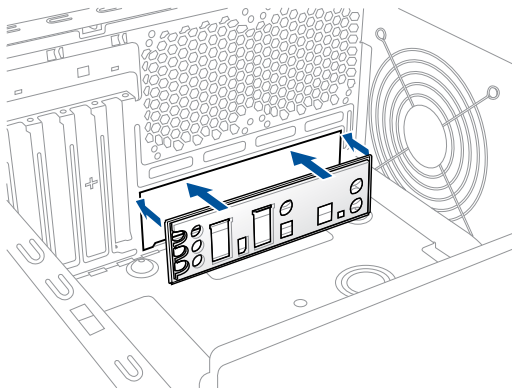

2. Place the motherboard into the chassis, ensuring that its rear I/O ports are aligned to the chassis' rear I/O panel.

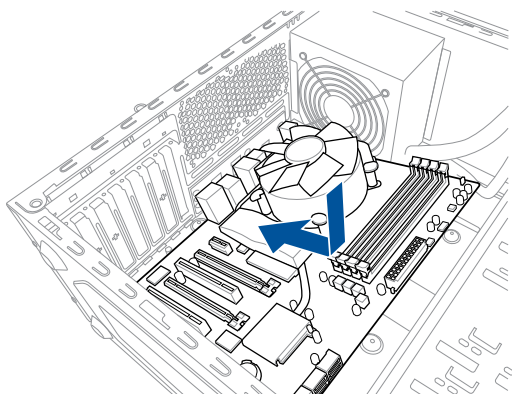

- Place eight (8) screws into the holes indicated by circles to secure the motherboard to the chassis.

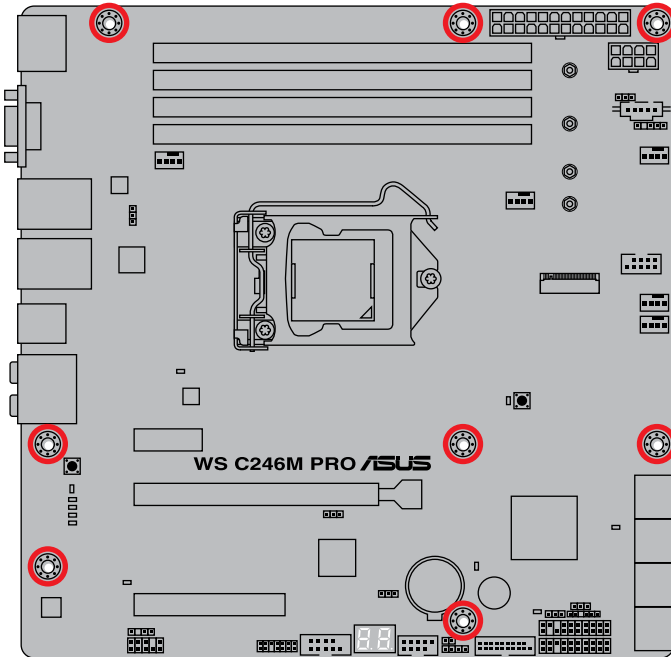
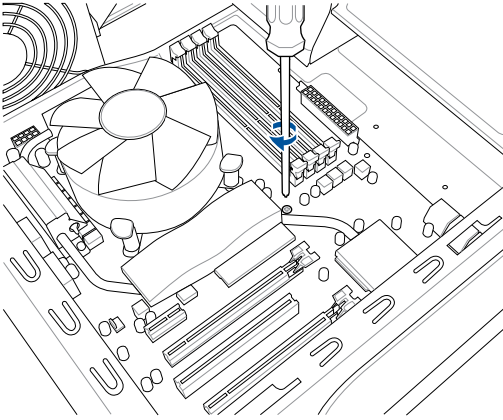

DO NOT overtighten the screws! Doing so can damage the motherboard.

2.1.4 DIMM installation

1

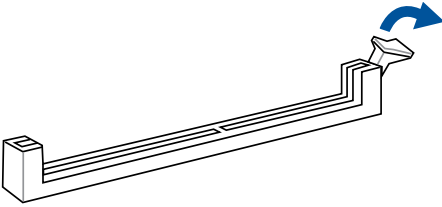

2

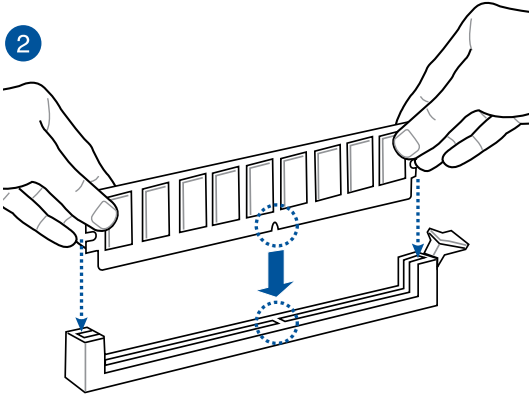

3

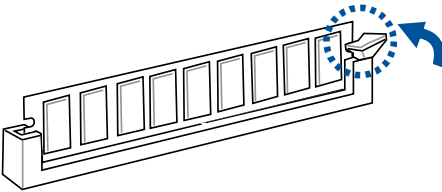

To remove a DIMM

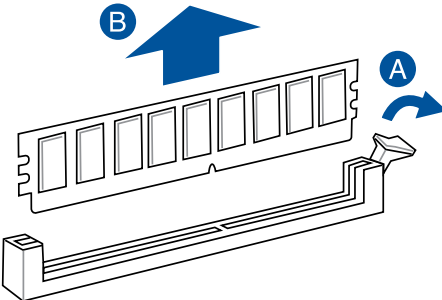

2.1.5 ATX power connection

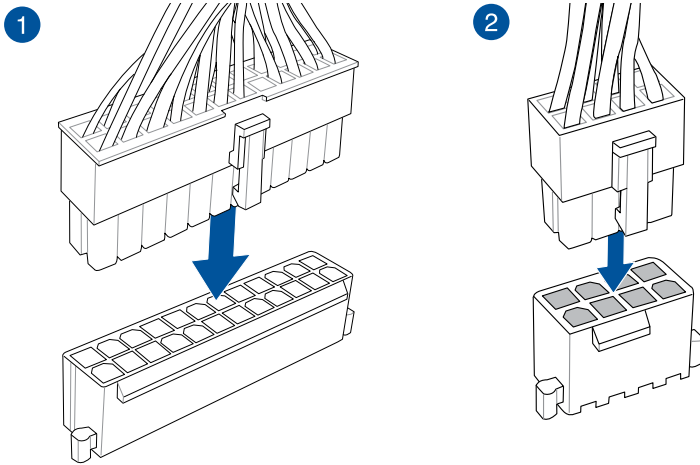

Ensure to connect the 8-pin power plug.

2.1.6 SATA device connection

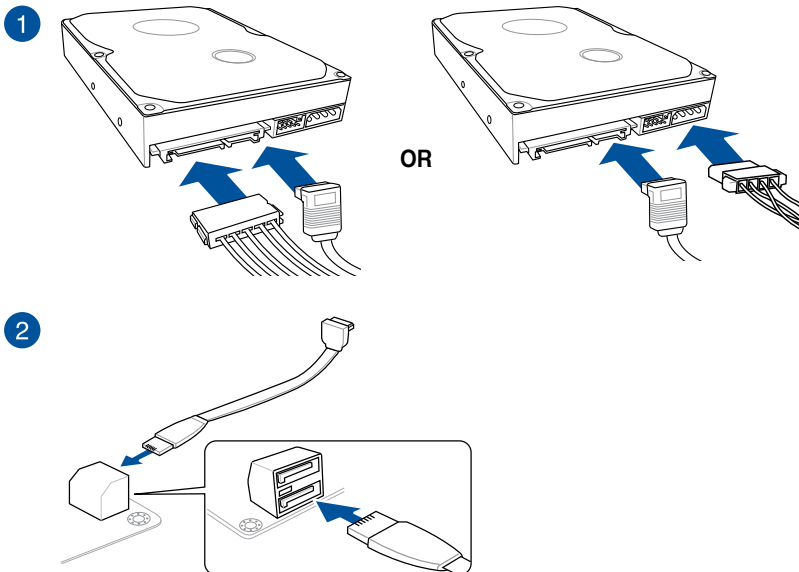

2.1.7 Front I/O connector

To install ASUS Q-Connector

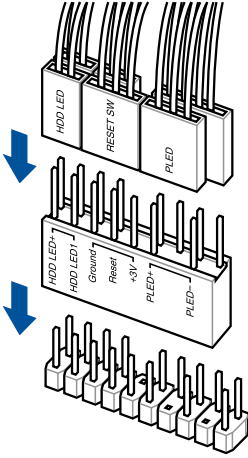

To install front panel audio connector

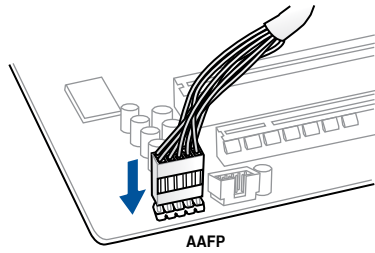

To install USB 3.1 Gen 1 connector

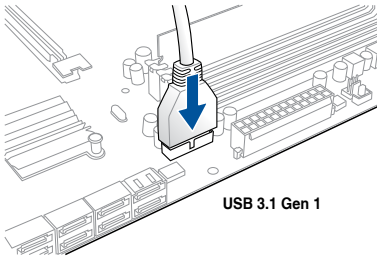

To install USB 2.0 connector

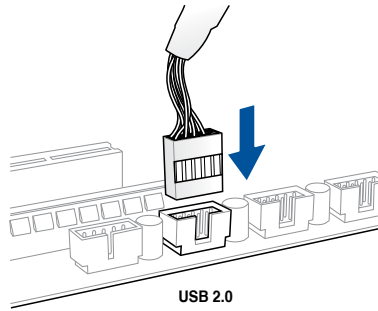

2.1.8 Expansion card installation

To install PCIe x16 cards

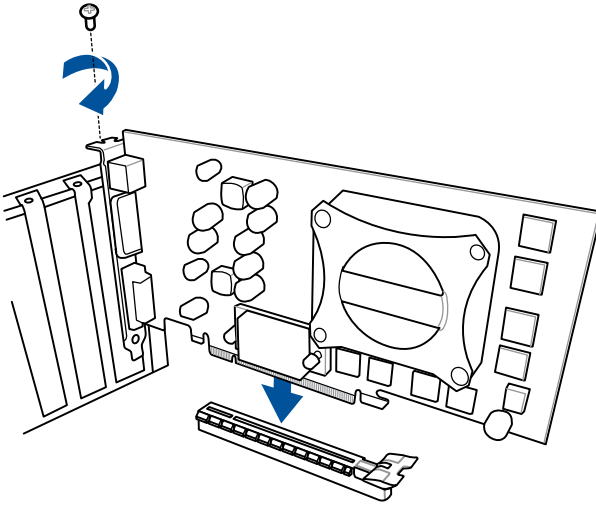

To install PCIe x1 cards

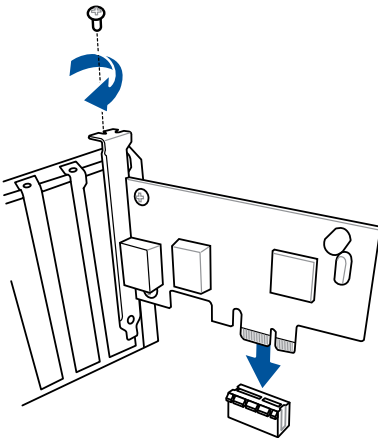

2.1.9 M.2 installation

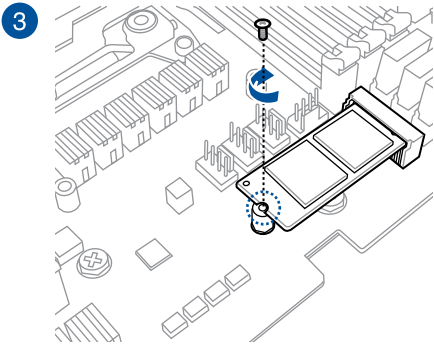
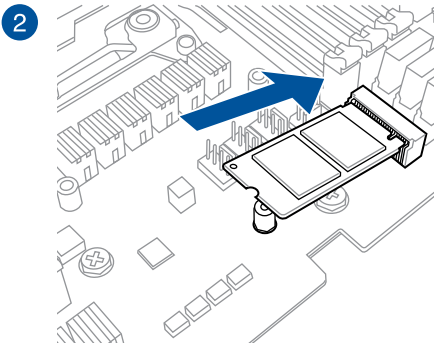
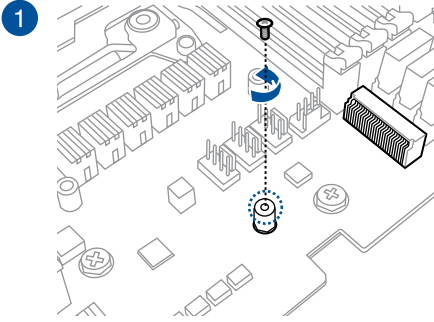

Supported M.2 type varies per motherboard.

2.13 BIOS update utility

USB BIOS Flashback

USB BIOS Flashback allows you to easily update the BIOS without entering the existing BIOS or operating system. Simply insert a USB storage device to the USB port (the USB port hole marked in green on the I/O shield) then press the USB BIOS Flashback button for three seconds to automatically update the BIOS.

To use USB BIOS Flashback:

1. Download the latest BIOS from the support site at www.asus.com/support/ and save it to as USB storage device.



- We recommend you to use a USB 2.0 storage device to save the latest BIOS version for better compatibility and stability.
- When downloading or updating the BIOS file, rename it as **WSC246MPRO.CAP** for this motherboard.

2. Insert the USB storage device to the USB Flashback port.
3. Shut down your computer.
4. On your motherboard, press the BIOS Flashback button for three seconds until the Flashback LED blinks three times, indicating that the BIOS Flashback function is enabled.

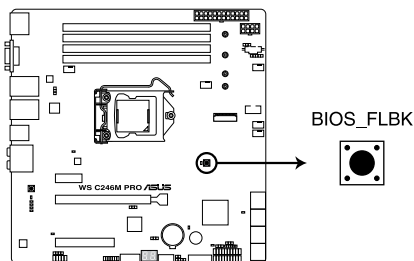

WS C246M PRO BIOS_FLBK button

5. Wait until the light goes out, indicating that the BIOS updating process is completed.



- Refer to section **1.1.8 Onboard LEDs** for more information of the Flashback LED.
- For more BIOS update utilities in BIOS setup, refer to the section **3.10 Updating BIOS** in Chapter 3.



-
- Do not unplug portable disk, power system, or short the CLRTC jumper while BIOS update is ongoing, otherwise update will be interrupted. In case of interruption, please follow the steps again.
 - If the light flashes for five seconds and turns into a solid light, this means that the BIOS Flashback is not operating properly. This may be caused by improper installation of the USB storage device and filename/file format error. If this scenario happens, please restart the system to turn off the light.
 - Updating BIOS may have risks. If the BIOS program is damaged during the process and results to the system's failure to boot up, please contact your local ASUS Service Center.
-

2.3 Motherboard rear and audio connections

2.3.1 Rear I/O connection

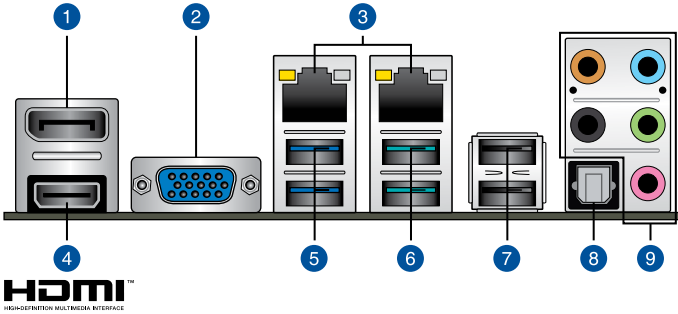

Rear panel connectors

1. DisplayPort	6. USB 3.1 Gen 2 Type-A ports 3 and 4
2. VGA port	7. USB 2.0 ports 1 and 2
3. Intel® LAN port 1 and 2 (I219-LM & I210-AT)*	8. Optical S/PDIF Out port
4. HDMI port	9. Audio I/O ports**
5. USB 3.1 Gen 1 ports 5 and 6	

* and **: Refer to the tables on the next page for LAN port LEDs and audio port definitions.



- USB 3.1 Gen 1/Gen 2 devices can only be used as data storage only.
- We strongly recommend that you connect your devices to ports with matching data transfer rate. Please connect your USB 3.1 Gen 1 devices to USB 3.1 Gen 1 ports and your USB 3.1 Gen 2 devices to USB 3.1 Gen 2 ports for faster and better performance for your devices.

* LAN ports LED indications

Activity Link LED		Speed LED	
Status	Description	Status	Description
Off	No link	Off	10 Mbps connection
Orange	Linked	Orange	100 Mbps connection
Orange (Blinking)	Data activity	Green	1 Gbps connection
Orange (Blinking then steady)	Ready to wake up from S5 mode		

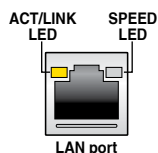

You can disable the LAN controllers in BIOS. Due to hardware design, the LAN1 port's LEDs may continue to blink even when disabled.

** Audio 2, 4, 5.1 or 7.1-channel configuration

Port	Headset 2-channel	4-channel	5.1-channel	7.1-channel
Light Blue	Line In	Line In	Line In	Side Speaker Out
Lime	Line Out	Front Speaker Out	Front Speaker Out	Front Speaker Out
Pink	Mic In	Mic In	Mic In	Mic In
Orange	–	–	Center/Sub woofer	Center/Sub woofer
Black	–	Rear Speaker Out	Rear Speaker Out	Rear Speaker Out

2.3.2 Audio I/O connections

Audio I/O ports

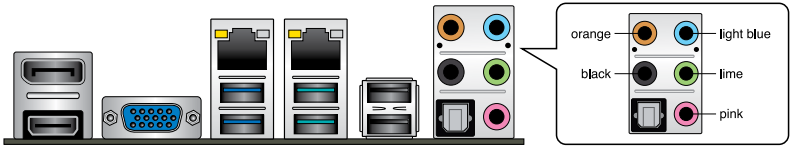

Connect to Headphone and Mic



Connect to Stereo Speakers

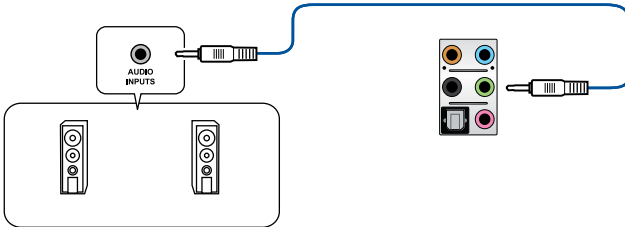

Connect to 2-channel Speakers

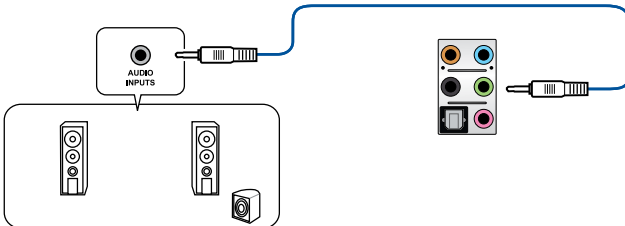

Connect to 4-channel Speakers

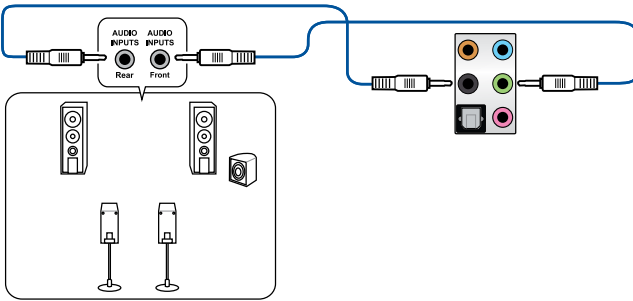

Connect to 5.1-channel Speakers

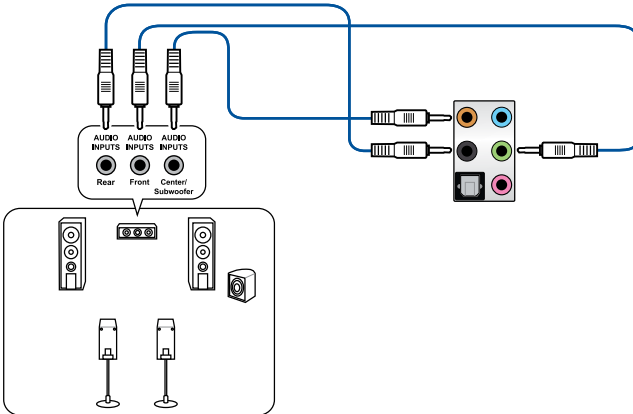

Connect to 7.1-channel Speakers

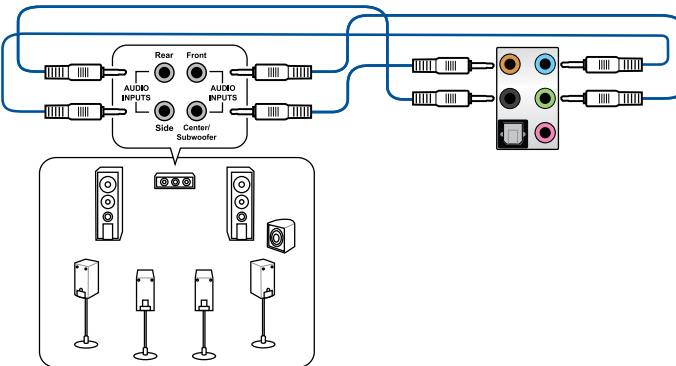

2.4 Starting up for the first time

1. After making all the connections, replace the system case cover.
2. Ensure that all switches are off.
3. Connect the power cord to the power connector at the back of the system chassis.
4. Connect the power cord to a power outlet that is equipped with a surge protector.
5. Turn on the devices in the following order:
 - a. Monitor
 - b. External storage devices (starting with the last device on the chain)
 - c. System power
6. After applying power, the system power LED on the system front panel case lights up. For systems with ATX power supplies, the system LED lights up when you press the ATX power button. If your monitor complies with the “green” standards or if it has a “power standby” feature, the monitor LED may light up or change from orange to green after the system LED turns on.

The system then runs the power-on self tests (POST). While the tests are running, the BIOS beeps (refer to the BIOS beep codes table) or additional messages appear on the screen. If you do not see anything within 30 seconds from the time you turned on the power, the system may have failed a power-on test. Check the jumper settings and connections or call your retailer for assistance.

BIOS Beep	Description
One short beep	VGA detected Quick boot set to disabled No keyboard detected
One continuous beep followed by two short beeps then a pause (repeated)	No memory detected
One continuous beep followed by three short beeps	No VGA detected
One continuous beep followed by four short beeps	Hardware component failure

7. At power on, hold down the <Delete> key to enter the BIOS Setup. Follow the instructions in Chapter 3.

2.5 Turning off the computer

While the system is ON, press the power button for less than four seconds to put the system on sleep mode or soft-off mode, depending on the BIOS setting. Press the power switch for more than four seconds to let the system enter the soft-off mode regardless of the BIOS setting.

BIOS Setup

3

3.1 Managing and updating your BIOS

The following utilities allow you to manage and update the motherboard Basic Input/Output System (BIOS) setup:

1. **ASUS CrashFree BIOS 3**
To recover the BIOS using a bootable USB flash disk drive when the BIOS file fails or gets corrupted.
2. **ASUS EzFlash**
Updates the BIOS using a USB flash disk.
3. **BUPDATER**
Updates the BIOS in DOS mode using a bootable USB flash disk drive.

Refer to the corresponding sections for details on these utilities.



Save a copy of the original motherboard BIOS file to a bootable USB flash disk drive in case you need to restore the BIOS in the future. Copy the original motherboard BIOS using the BUPDATER utility.

3.1.1 ASUS CrashFree BIOS 3 utility

The ASUS CrashFree BIOS 3 is an auto recovery tool that allows you to restore the BIOS file when it fails or gets corrupted during the updating process. You can update a corrupted BIOS file using a USB flash drive that contains the updated BIOS file.



Prepare a USB flash drive containing the updated motherboard BIOS before using this utility.

Recovering the BIOS from a USB flash drive

To recover the BIOS from a USB flash drive:

1. Insert the USB flash drive with the original or updated BIOS file to one USB port on the system.
2. The utility will automatically recover the BIOS. It resets the system when the BIOS recovery finished.



DO NOT shut down or reset the system while recovering the BIOS! Doing so would cause system boot failure!



The recovered BIOS may not be the latest BIOS version for this motherboard. Visit the ASUS website at www.asus.com to download the latest BIOS file.

3.1.2 ASUS EzFlash Utility

The ASUS EzFlash Utility feature allows you to update the BIOS using a USB flash disk without having to use a DOS-based utility.



Download the latest BIOS from the ASUS website at www.asus.com before using this utility.



The succeeding BIOS screens are for reference only. The actual BIOS screen displays may not be the same as shown.

To update the BIOS using EzFlash Utility:

1. Insert the USB flash disk that contains the latest BIOS file to the USB port.
2. Enter the BIOS setup program. Go to the **Tool** menu to select **Start EzFlash** and press <Enter> to enable it.

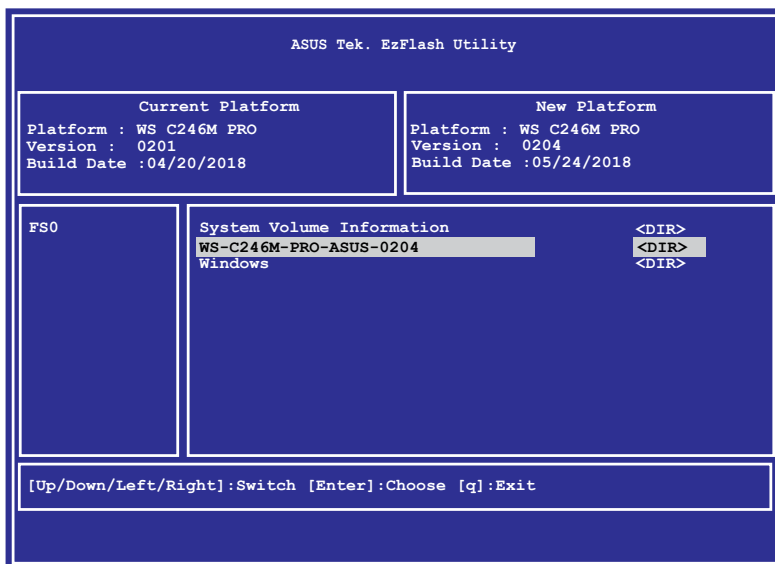

3. Press <Tab> to switch to the **Drive** field.
4. Press the Up/Down arrow keys to find the USB flash disk that contains the latest BIOS then press <Enter>.
5. Press <Tab> to switch to the **Folder Info** field.
6. Press the Up/Down arrow keys to find the BIOS file then press <Enter>.
7. Reboot the system when the update process is done.



- This function can support devices such as a USB flash disk with FAT 32/16 format and single partition only.
- DO NOT shut down or reset the system while updating the BIOS to prevent system boot failure!



Ensure to load the BIOS default settings to ensure system compatibility and stability. Press <F5> and select Yes to load the BIOS default settings.

3.1.3 BUPDATER utility



The succeeding BIOS screens are for reference only. The actual BIOS screen displays may not be the same as shown.

The BUPDATER utility allows you to update the BIOS file in DOS environment using a bootable USB flash disk drive with the updated BIOS file.

Updating the BIOS file

To update the BIOS file using the BUPDATER utility:

1. Visit the ASUS website at www.asus.com and download the latest BIOS file for the motherboard. Save the BIOS file to a bootable USB flash disk drive.
2. Download the BUPDATER utility (BUPDATER.exe) from the ASUS support website at support.asus.com to the bootable USB flash disk drive you created earlier.
3. Boot the system in DOS mode, then at the prompt, type:

```
BUPDATER /i[filename].CAP
```

where [filename] is the latest or the original BIOS file on the bootable USB flash disk drive, then press <Enter>.

```
A: \>BUPDATER /i[file name]CAP
```

The utility verifies the file, then starts updating the BIOS file.

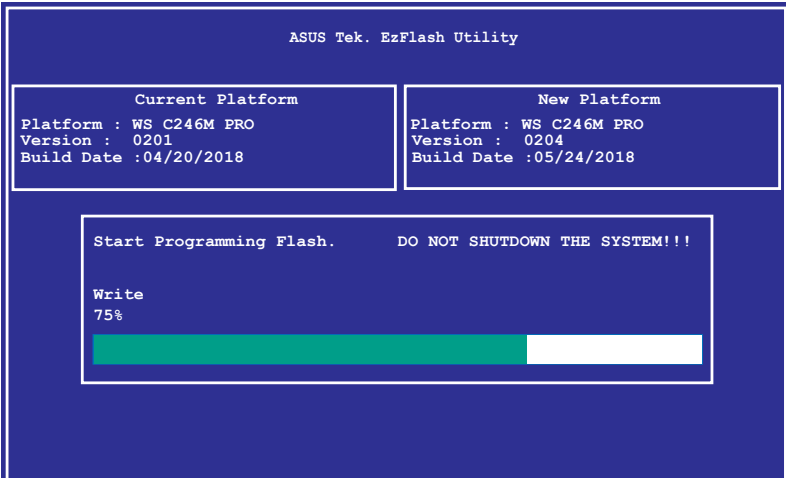

DO NOT shut down or reset the system while updating the BIOS to prevent system boot failure!

The utility returns to the DOS prompt after the BIOS update process is completed.

4. Reboot the system from the hard disk drive.

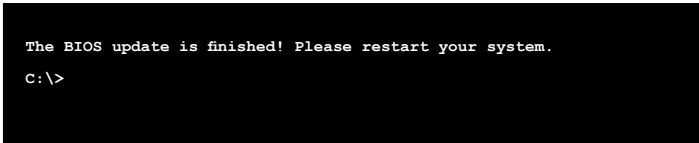

3.2 BIOS setup program

This motherboard supports a programmable firmware chip that you can update using the provided utility described in section **3.1 Managing and updating your BIOS**.

Use the BIOS Setup program when you are installing a motherboard, reconfiguring your system, or prompted to "Run Setup." This section explains how to configure your system using this utility.

Even if you are not prompted to use the Setup program, you can change the configuration of your computer in the future. For example, you can enable the security password feature or change the power management settings. This requires you to reconfigure your system using the BIOS Setup program so that the computer can recognize these changes and record them in the CMOS RAM of the firmware chip.

The firmware chip on the motherboard stores the Setup utility. When you start up the computer, the system provides you with the opportunity to run this program. Press during the Power-On Self-Test (POST) to enter the Setup utility; otherwise, POST continues with its test routines.

If you wish to enter Setup after POST, restart the system by pressing <Ctrl>+<Alt>+, or by pressing the reset button on the system chassis. You can also restart by turning the system off then back on. Do this last option only if the first two failed.

The Setup program is designed to make it as easy to use as possible. Being a menu-driven program, it lets you scroll through the various sub-menus and make your selections from the available options using the navigation keys.



-
- The default BIOS settings for this motherboard apply for most conditions to ensure optimum performance. If the system becomes unstable after changing any BIOS settings, load the default settings to ensure system compatibility and stability. Press <F5> and select Yes to load the BIOS default settings.
 - The BIOS setup screens shown in this section are for reference purposes only, and may not exactly match what you see on your screen.
 - Visit the ASUS website (www.asus.com) to download the latest BIOS file for this motherboard.
-

3.2.1 BIOS menu screen

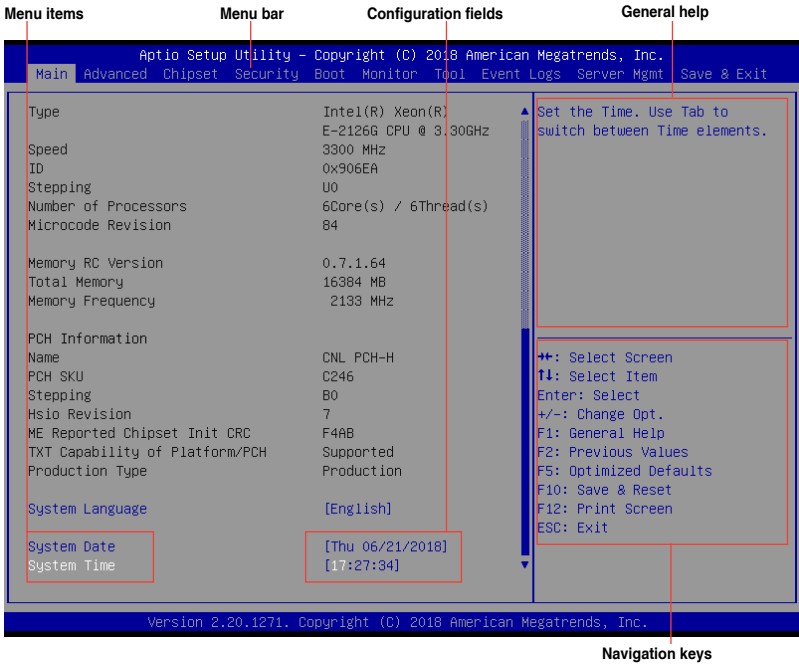

3.2.2 Menu bar

The menu bar on top of the screen has the following main items:

- Main** For changing the basic system configuration
- Advanced** For changing the advanced system settings
- Chipset** For changing the chipset settings
- Security** For changing the security settings
- Boot** For changing the system boot configuration
- Monitor** For displaying the system temperature, power status, and changing the fan settings
- Tool** For configuring options for special functions
- Event Logs** For changing the event log settings
- Server Mgmt** For changing the server mgmt settings
- Save & Exit** For selecting the save & exit options

To select an item on the menu bar, press the right or left arrow key on the keyboard until the desired item is highlighted.

3.2.3 Menu items

The highlighted item on the menu bar displays the specific items for that menu. For example, selecting Main shows the Main menu items. The other items (Advanced, Chipset, Security, Boot, Monitor, Tool, Event Logs, Server Mgmt, and Save & Exit) on the menu bar have their respective menu items.

3.2.4 Submenu items

A solid triangle before each item on any menu screen means that the item has a submenu. To display the submenu, select the item and press <Enter>.

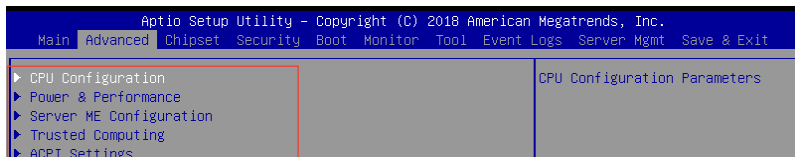

3.2.5 Navigation keys

At the bottom right corner of a menu screen are the navigation keys for the BIOS setup program. Use the navigation keys to select items in the menu and change the settings.

3.2.6 General help

At the top right corner of the menu screen is a brief description of the selected item.

3.2.7 Configuration fields

These fields show the values for the menu items. If an item is user-configurable, you can change the value of the field opposite the item. You cannot select an item that is not user-configurable. A configurable field is enclosed in brackets, and is highlighted when selected. To change the value of a field, select it and press <Enter> to display a list of options.

3.2.8 Pop-up window

Select a menu item and press <Enter> to display a pop-up window with the configuration options for that item.

3.2.9 Scroll bar

A scroll bar appears on the right side of a menu screen when there are items that do not fit on the screen. Press the Up/Down arrow keys or <Page Up> /<Page Down> keys to display the other items on the screen.

3.3 Main menu

When you enter the BIOS Setup program, the Main menu screen appears. The Main menu provides you an overview of the basic system information, and allows you to set the system date, time, and language.



Navigate to the second page of the screen to see the rest of items in this menu by pressing the Up or Down arrow keys.



To quickly go to the last item of the second page, press the Page Down button. Press the Page Up button to go back to the first item in the first page.

System Date [Day MM/DD/YYYY]

Allows you to set the system date.

System Time [HH:MM:SS]

Allows you to set the system time.

3.4 Advanced menu

The Advanced menu items allow you to change the settings for the CPU and other system devices.



Take caution when changing the settings of the Advanced menu items. Incorrect field values can cause the system to malfunction.

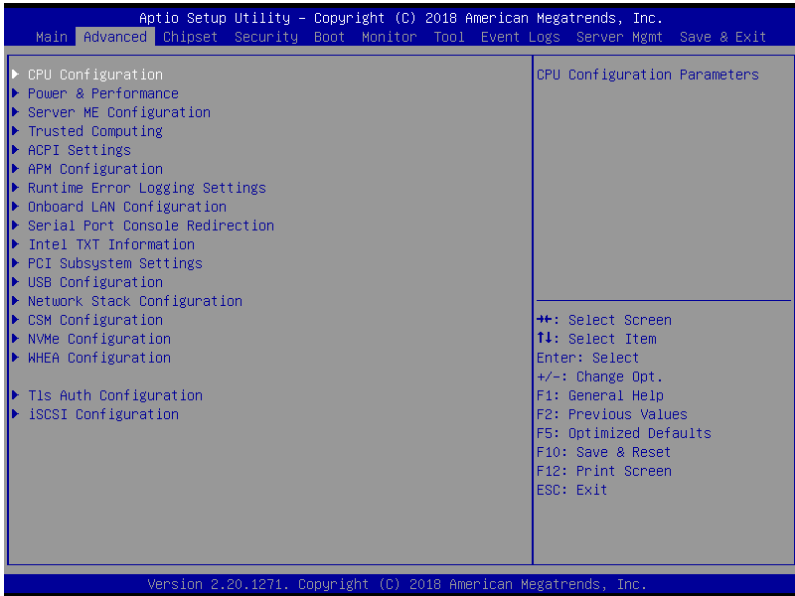

3.4.1 CPU Configuration

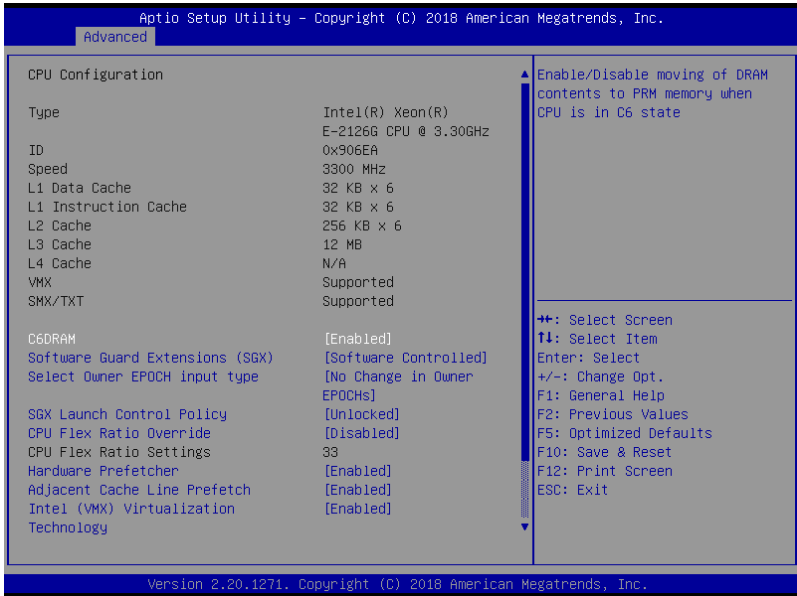

C6DRAM [Enabled]

Allows you to enable or disable moving of DRAM contents to PRM memory when the CPU is in C6 state.

Configuration options: [Disabled] [Enabled]

Software Guard Extensions (SGX) [Software Controlled]

Allows you to select the behavior of Software Guard Extensions (SGX).

Configuration options: [Software Controlled] [Disabled] [Enabled]



The following items appear only when you set **Software Guard Extensions (SGX)** to **[Enabled]** or **[Software Controlled]**.

Select Owner EPOCH input type [No change in Owner EPOCHs]

Allows you to select the behavior of EPOCH input type.

Configuration options: [No change in Owner EPOCHs] [Change to New Random EPOCHs] [Manual User Defined Owner EPOCHs]

SGX Launch Control Policy [Unlocked]

Allows you to select the behavior of SGX Launch Control Policy.

Configuration options: [Intel Locked] [Unlocked] [Locked]



The following items appear only when you set **SGX Launch Control Policy** to **[Locked]**.

SGX LE Public Key Hash 0-3 [0]

Allows you to set the Bytes of the Software Guard Extensions (SGX) Launch Enclave Public Key Hash.



The following item appears only when you set **Software Guard Extensions (SGX)** to **[Enabled]**.

PRMRR Size [128MB]

Allows you to set the PRMRR Size.

Configuration options: [32MB] [64MB] [128MB]

CPU Flex Ratio Override [Disabled]

Allows you to enable or disable CPU Flex Ratio Override.

Configuration options: [Disabled] [Enabled]



The following item appears only when you set **CPU Flex Ratio Override** to **[Enabled]**.

CPU Flex Ratio Settings [33]

Allows you to set the CPU Flex Ratio.

This value must be between the Max Efficiency Ratio (LFM) and the Maximum non-turbo ratio set by the Hardware (HFW).

Hardware Prefetcher [Enabled]

This Item allows you to turn on/off the MLC streamer prefetcher.

Configuration options: [Disabled] [Enabled]

Adjacent Cache Prefetch [Enabled]

This Item allows you to turn on/off prefetching of adjacent cache lines.

Configuration options: [Disabled] [Enabled]

Intel (VMX) Virtualization Technology [Enabled]

Enable this item to allow a VMM to utilize the additional hardware capabilities provided by Vanderpool Technology.

Configuration options: [Disabled] [Enabled]

Active Processor Cores [All]

This item allows you to set the number of cores to enable in each processor package.

Configuration options: [All] [1] [2] [3] [4] [5]

BIST [Disabled]

Allows you to enable or disable BIST (Built-In Self Test) on reset.

Configuration options: [Disabled] [Enabled]

AES [Enabled]

Allows you to enable or disable AES (Advanced Encryption Standard).

Configuration options: [Disabled] [Enabled]

Intel Trusted Execution Technology [Disabled]

Allows you to enable or disable utilization of additional hardware capabilities provided by Intel(R) Trusted Execution Technology. Changes require a full power cycle to take effect.
Configuration options: [Disabled] [Enabled]

3.4.2 Power & Performance

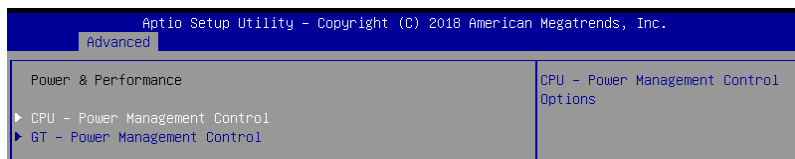

CPU - Power Management Control

Boot performance mode [Max Non-Turbo Performance]

This item allows you to select the performance state that the BIOS will set starting from reset vector.

Configuration options: [Max Battery] [Max Non-Turbo Performance] [Turbo Performance]

Intel(R) SpeedStep(tm) [Enabled]

Allows more than two frequency ranges to be supported.

Configuration options: [Disabled] [Enabled]

Race To Halt (RTH) [Enabled]

Allows you to enable or disable Race To Halt feature. RTH will dynamically increase CPU frequency in order to enter pkg C-State faster to reduce overall power. RTH is controlled through MSR 1FC bit 20.

Configuration options: [Disabled] [Enabled]

Intel(R) Speed Shift Technology [Disabled]

Allows you to enable or disable Intel(R) Speed Shift Technology support. Enabling will expose the CPPC v2 interface to allow for hardware controlled P-states.

Configuration options: [Disabled] [Enabled]

HDC Control [Enabled]

[Disabled] Disable HDC.

[Enabled] Can be enable by OS if OS native support available.

Turbo Mode [Enabled]

Allows you to enable or disable processor turbo mode if EMTTM is also enabled.

Configuration options: [Disabled] [Enabled]

C-States [Enabled]

Allows you to enable or disable CPU power management, this allows the CPU to enter C-state when not it is not 100 % utilized.

Configuration options: [Disabled] [Enabled]



The following items appears only when you set **C-States** to **[Enabled]**.

Enhanced C-States [Enabled]

Allows you to enable or disable C11E. Enable this item to allow the CPU to switch to minimum speed when all cores enter C-State.

Configuration options: [Disabled] [Enabled]

C-State Auto Demotion [C1 and C3]

This item allows you to configure the C-state auto demotion.

Configuration options: [Disabled] [C1] [C3] [C1 and C3]

C-State Un-demotion [C1 and C3]

This item allows you to configure the C-state Un-demotion.

Configuration options: [Disabled] [C1] [C3] [C1 and C3]

Package C-State Demotion [Disabled]

This item allows you to configure the Package C-State Demotion.

Configuration options: [Disabled] [Enabled]

Package C-State Un-demotion [Disabled]

This item allows you to configure the Package C-state Un-demotion.

Configuration options: [Disabled] [Enabled]

Package C-state Limit [Auto]

This item allows you to select the maximum package C-state limit setting.

Configuration options: [C0/C1] [C2] [C3] [C6] [C7] [C7S] [C8] [C9] [C10] [CPU Default] [Auto]

Thermal Monitor [Enabled]

Allows you to enable or disable Thermal Monitoring.

Configuration options: [Disabled] [Enabled]

GT - Power Management Control

RC6(Render Standby) [Enabled]

This item allows you to enable or disable standby support.

Configuration options: [Disabled] [Enabled]

Maximum GT frequency [Default Max Frequency]

This item allows you to set the maximum GT frequency limit. Choose between 350MHz (RPN) and 1150 MHz (RP0). Values beyond the range will be clipped to the min/max supported by SKU.

Configuration options: [Default Max Frequency] [100Mhz]-[1200Mhz]

Disable Turbo GT Frequency [Disabled]

[Enabled] Disabled Turbo GT Frequency

[Disabled] GT Frequency is not limited.

3.4.3 Server ME Configuration

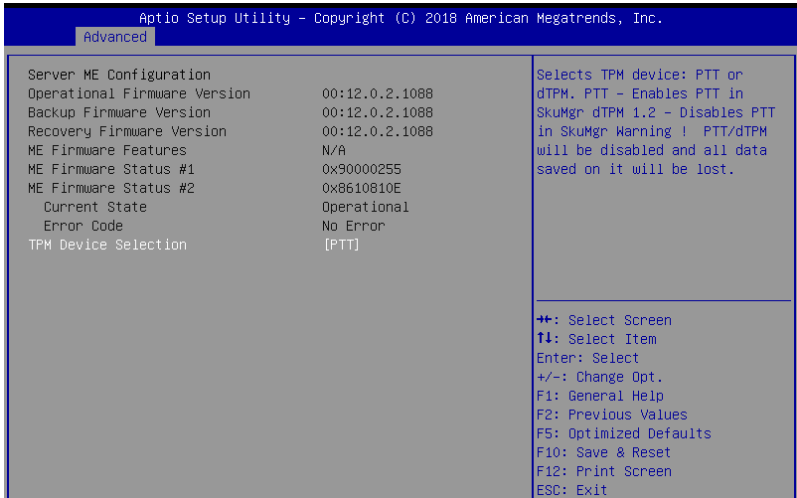

TPM Device Selection [PTT]

Allows you to select the TPM device.
 Configuration options: [PTT] [dTPM]

3.4.4 Trusted Computing

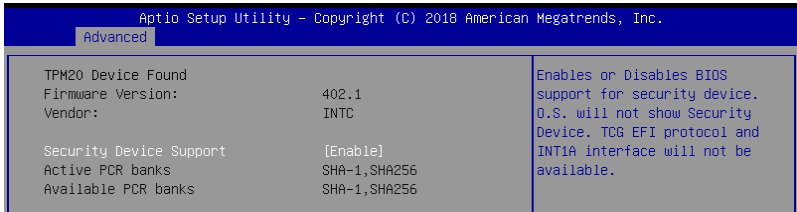

Security Device Support [Enabled]

This item allows you to enable or disable Security Device Support.
 Configuration options: [Disabled] [Enabled]

3.4.5 ACPI Settings

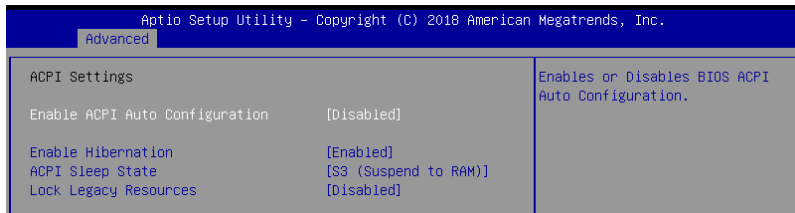

Enable ACPI Auto Configuration [Disabled]

This item allows you to enable or disable BIOS ACPI Auto Configuration.
Configuration options: [Disabled] [Enabled]



The following items appears only when you set **Enable ACPI Auto Configuration** to **[Disabled]**.

Enable Hibernation [Enabled]

This item allows you to enable or disable the system's ability to Hibernate (OS/S4 Sleep State).

Configuration options: [Disabled] [Enabled]



This option may not be effective with some operating systems.

ACPI Sleep State [S3 (Suspend to RAM)]

This item allows you to select the highest ACPI sleep state the system will enter when the SUSPEND button is pressed.

Configuration options: [Suspend Disabled] [S3 (Suspend to RAM)]

Lock Legacy Resources [Disabled]

This item allows you to enable or disable Lock of Legacy Resources.

Configuration options: [Disabled] [Enabled]

3.4.6 APM Configuration

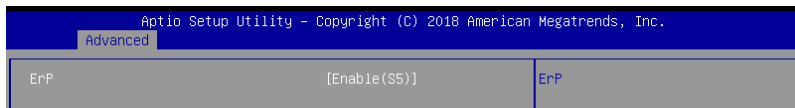

ErP [Disabled]

Allows you to switch off some power at S4+S5 or S5 to get the system ready for ErP requirement. When set to **[Enabled]**, all other PME options will be switched off.

Configuration options: [Disabled] [Enable (S4+S5)] [Enable (s5)]



The following items appears only when you set **ErP** to **[Disabled]**.

Restore AC Power Loss [Last State]

When set to [Power Off], the system goes into off state after an AC power loss. When set to **[Power On]**, the system will reboot after an AC power loss. When set to **[Last State]**, the system goes into either off or on state, whatever the system state was before the AC power loss.

Configuration options: [Power Off] [Power On] [Last State]

Power On By PCIE/PCI [Disabled]

[Disabled] Disables the PCI or PCIE devices to generate a wake event.

[Enabled] Enables the PCI or PCIE devices to generate a wake event.

Power On By RTC [Disabled]

[Disabled] Disables RTC to generate a wake event.

[Enabled] When set to **[Enabled]**, the items **RTC Alarm Date (Days)** and **Hour/Minute/Second** will become user-configurable with set values.

3.4.7 Runtime Error Logging Settings

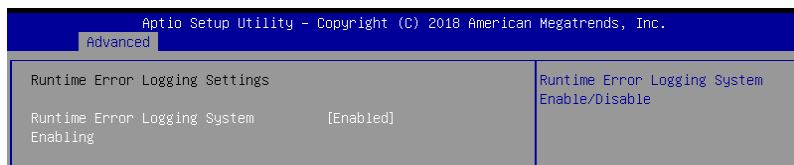

Runtime Error Logging System Enabling [Enabled]

This item allows you to enable or disable Runtime Error Logging System.

Configuration options: [Disabled] [Enabled]

3.4.8 Onboard LAN Configuration

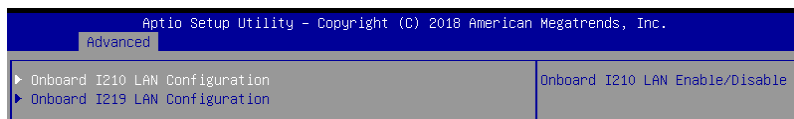

Onboard I210 LAN Configuration

Intel I210 LAN1

LAN Enable [Enabled]

Allows you to enable or disable the Intel LAN.

Configuration options: [Disabled] [Enabled]



The following item appears only when you set **LAN Enable** to **[Enabled]**.

Intel LAN ROM Type [PXE]

Allows you to select the Intel LAN ROM type.

Configuration options: [Disabled] [PXE] [iSCSI]



Due to Intel® limitations, both Intel LAN ROM Type options should be the same when [PXE] or [iSCSI] is selected.

Intel I219 LAN Configuration

LAN Enable [Enabled]

Allows you to enable or disable the Intel LAN.

Configuration options: [Disabled] [Enabled]

3.4.9 Serial Port Console Redirection

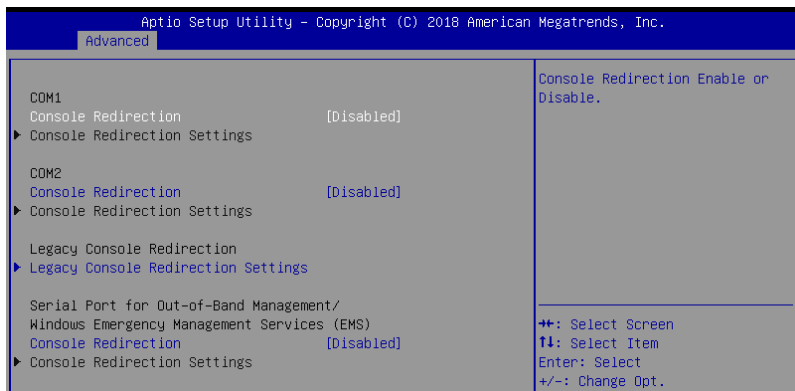

COM1/COM2

Console Redirection [Disabled]

Allows you to enable or disable the console redirection feature.

Configuration options: [Disabled] [Enabled]



The following item appears only when you set **Console Redirection** to [Enabled].

Console Redirection Settings

These items become configurable only when you enable the Console Redirection item. The settings specify how the host computer and the remote computer (which the user is using) will exchange data. Both computers should have the same or compatible settings.

Terminal Type [VT-UTF8]

Allows you to set the terminal type.

[VT100]	ASCII char set.
[VT100+]	Extends VT100 to support color, function keys, etc.
[VT-UTF8]	Uses UTF8 encoding to map Unicode chars onto 1 or more bytes.
[ANSI]	Extended ASCII char set.

Bits per second [57600]

Selects serial port transmission speed. The speed must be matched on the other side. Long or noisy lines may require lower speeds.

Configuration options: [9600] [19200] [38400] [57600] [115200]

Data Bits [8]

Configuration options: [7] [8]

Parity [None]

A parity bit can be sent with the data bits to detect some transmission errors. [Mark] and [Space] parity do not allow for error detection.

[None]	None
[Even]	parity bit is 0 if the num of 1's in the data bits is even
[Odd]	parity bit is 0 if num of 1's in the data bits is odd
[Mark]	parity bit is always 1
[Space]	parity bit is always 0

Stop Bits [1]

Stop bits indicate the end of a serial data packet. (A start bit indicates the beginning.) The standard setting is 1 stop bit. Communication with slow devices may require more than 1 stop bit.

Configuration options: [1] [2]

Flow Control [Hardware RTS/CTS]

Flow control can prevent data loss from buffer overflow. When sending data, if the receiving buffers are full, a "stop" signal can be sent to stop the data flow. Once the buffers are empty, a "start" signal can be sent to re-start the flow. Hardware flow control uses two wires to send start/stop signals.

Configuration options: [None] [Hardware RTS/CTS]

VT -UTF8 Combo Key Support [Enabled]

This allows you to enable the VT -UTF8 Combination Key Support for ANSI/VT100 terminals.

Configuration options: [Disabled] [Enabled]

Recorder Mode [Disabled]

With this mode enabled only text will be sent. This is to capture Terminal data.

Configuration options: [Disabled] [Enabled]

Resolution 100x31 [Disabled]

This allows you to enable or disable extended terminal resolution.

Configuration options: [Disabled] [Enabled]

Putty Keypad [VT100]

This allows you to select the FunctionKey and Keypad on Putty.

Configuration options: [VT100] [LINUX] [XTERMR6] [SCO] [ESCN] [VT400]

Legacy Console Redirection Settings

Legacy Console Redirection Port [COM1]

Allows you to select a COM port to display redirection of Legacy OS and Legacy OPROM Messages.

Configuration options: [COM1] [COM2]

Resolution [80x24]

Allows you to select a the number of rows and columns in supported redirection.

Configuration options: [80x24] [80x25]

Redirect After POST [Always Enable]

Allows you to select the redirection after POST.

Configuration options: [Always Enable] [BootLoader]

Serial Port for Out-of-Band Management/Windows Emergency Management Services (EMS)

Console Redirection [Disabled]

Allows you to enable or disable the console redirection feature.

Configuration options: [Disabled] [Enabled]



The following item appears only when you set **Console Redirection** to **[Enabled]**.

Console Redirection Settings

Out-of-Band Mgmt Port [COM1]

Microsoft Windows Emergency Management Services (EMS) allow for remote management of a Windows Server OS through a serial port.

Configuration options: [COM1] [COM2]

Terminal Type [VT-UTF8]

Microsoft Windows Emergency Management Services (EMS) allow for remote management of a Windows Server OS through a serial port.

Configuration options: [VT100] [VT100+] [VT-UTF8] [ANSI]

Bits per second [115200]

Microsoft Windows Emergency Management Services (EMS) allow for remote management of a Windows Server OS through a serial port.

Configuration options: [9600] [19200] [57600] [115200]

Flow Control [None]

Microsoft Windows Emergency Management Services (EMS) allow for remote management of a Windows Server OS through a serial port.

Configuration options: [None] [Hardware RTS/CTS] [Software Xon/Xoff]

3.4.10 Intel TXT Information

You may view the Intel TXT information in this menu.

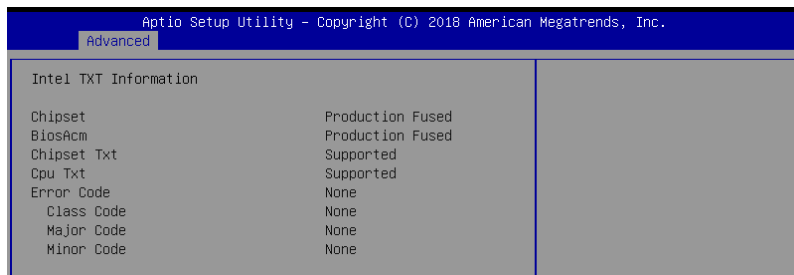

3.4.11 PCI Subsystem Settings

Allows you to configure PCI, PCI-X, and PCI Express Settings.

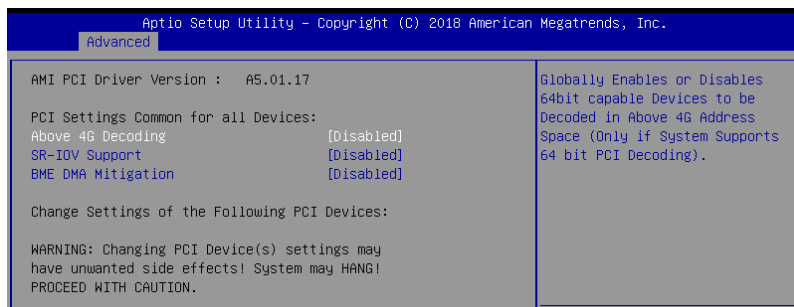

Above 4G Decoding [Disabled]

Allows you to enable or disable 64-bit capable devices to be decoded in above 4G address space. It only works if the system supports 64-bit PCI decoding.

Configuration options: [Disabled] [Enabled]

SR-IOV Support [Disabled]

This allows you to enable or disable Single Root IO Virtualization Support, if your system has SR-IOV capable PCIe Devices.

Configuration options: [Disabled] [Enabled]

BME DMA Mitigation [Disabled]

This allows you to enable or disable re-enabling Bus Master Attribute disabled during Pci enumeration for PCI Bridges after SMM locked.

Configuration options: [Disabled] [Enabled]

3.4.12 USB Configuration

Aptio Setup Utility - Copyright (C) 2018 American Megatrends, Inc.	
Advanced	
USB Configuration	Enables Legacy USB support. AUTO option disables legacy support if no USB devices are connected. DISABLE option will keep USB devices available only for EFI applications.
USB Module Version	20
USB Controllers:	
1 XHCI	
USB Devices:	
2 Drives, 1 Keyboard, 1 Mouse	
Legacy USB Support	[Enabled]
XHCI Hand-off	[Enabled]
USB Mass Storage Driver Support	[Enabled]
Port 60/64 Emulation	[Enabled]
USB hardware delays and time-outs:	
USB transfer time-out	[20 sec]
Device reset time-out	[20 sec]
Device power-up delay	[Auto]
Mass Storage Devices:	
Generic-Multi-Card 1.00	[Auto]
JetFlashTranscend 4GB 8.07	[Auto]

←+: Select Screen
↑↓: Select Item
Enter: Select
+/-: Change Opt.
F1: General Help
F2: Previous Values
F5: Optimized Defaults
F10: Save & Reset
F12: Print Screen
ESC: Exit

Legacy USB Support [Enabled]

[Disabled] The USB devices can be used only for the BIOS setup program. It cannot be recognized in boot devices list.

[Enabled] Enables the support for USB devices on legacy operating systems (OS).

[Auto] Allows the system to detect the presence of USB devices at startup. If detected, the USB controller legacy mode is enabled. If no USB device is detected, the legacy USB support is disabled.

XHCI Hand-off [Enabled]

Allows you to enable or disable workaround for OS(s) without XHCI hand-off support.

Configuration options: [Disabled] [Enabled]

USB Mass Storage Driver Support [Enabled]

Allows you to enable or disable USB Mass Storage driver support.

Configuration options: [Disabled] [Enabled]

Port 60/64 Emulation [Enabled]

Allows you to enable or disable Port 60/64 Emulation.

Configuration options: [Disabled] [Enabled]

USB hardware delays and time-outs

USB transfer time-out [20 sec]

Allows you to set the USB transfer time-out value.

Configuration options: [1 sec] [5 sec] [10 sec] [20 sec]

Device reset time-out [20 sec]

Allows you to set the device reset time-out value.

Configuration options: [10 sec] [20 sec] [30 sec] [40 sec]

Device power-up delay [Auto]

Allows you to set the maximum time the device takes before the device reports itself to the host controller properly.

Configuration options: [Auto] [Manual]



The following item appears only when you set **Device power-up delay** to **[Manual]**.

Device power-up delay in seconds [5]

Allows you to set the device power-up delay in seconds. Use the <+> or <-> to adjust the value. The values range from 1 to 40.

Mass Storage Devices

Allows you to select the mass storage device emulation type for devices connected.

Configuration options: [Auto] [Floppy] [Forced FDD] [Hard Disk] [CD-ROM]

3.4.13 Network Stack Configuration

Allows you to configure the network stack configuration.

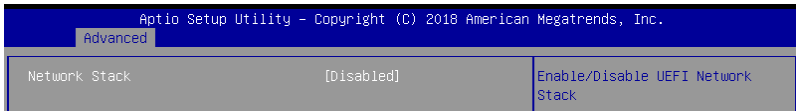

Network Stack [Disabled]

Allows you to enable or disable UEFI Network Stack.

Configuration options: [Disabled] [Enabled]



The following items appear only when you set **Network Stack** to **[Enabled]**.

Ipv4 PXE Support [Disabled]

Enables or disables the Ipv4 PXE Boot Support. If disabled, Ipv4 PXE boot option will not be created.

Configuration options: [Disabled] [Enabled]

Ipv4 HTTP Support [Disabled]

Enables or disables the Ipv4 HTTP Boot Support. If disabled, Ipv4 PXE boot option will not be created.

Configuration options: [Disabled] [Enabled]

Ipv6 PXE Support [Disabled]

Enables or disables the Ipv6 PXE Boot Support. If disabled, Ipv6 PXE boot option will not be created.

Configuration options: [Disabled] [Enabled]

Ipv6 HTTP Support [Disabled]

Enables or disables the Ipv6 HTTP Boot Support. If disabled, Ipv6 PXE boot option will not be created.

Configuration options: [Disabled] [Enabled]

IPSEC Certificate [Enabled]

Enables or disables support for IPSEC Certificate.
Configuration options: [Disabled] [Enabled]

PXE boot wait time [0]

Set the wait time to press ESC key to abort the PXE boot. Use the <+> or <-> to adjust the value. The values range from 0 to 5.

Media detect count [1]

Set the number of times presence of media will be checked. Use the <+> or <-> to adjust the value. The values range from 1 to 50.

3.4.14 CSM Configuration

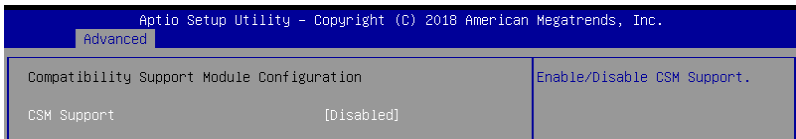

CSM Support [Disabled]

This option allows you to enable or disable CSM Support.
Configuration options: [Disabled] [Enabled]



The following items appear only when you set **CSM Support** to **[Enabled]**.

GateA20 Active [Upon Request]

This allows you to set the GA20 option.

[Upon Request]	GA20 can be disabled using BIOS services.
[Always]	Do not allow disabling GA20; this option is useful when any RT code is executed above 1MB.

Option ROM Messages [Force BIOS]

This allows you to set the display mode for option ROM.

Configuration options: [Force BIOS] [Keep Current]

INT19 Trap Response [Immediate]

This option allows you to control the BIOS reaction on INT19 trapping by Option ROM.

[Immediate]	Execute the trap right away.
[Postponed]	Execute the trap during legacy boot.

HDD Connection Order [Adjust]

This option allows you to select the HDD Connection Order. Some OS require HDD handles to be adjusted.

Configuration options: [Adjust] [Keep]

Boot Option filter [Legacy only]

This option allows you to control the Legacy/UEFI ROMs priority.
Configuration options: [UEFI and Legacy] [Legacy only] [UEFI only]

Network / Storage / Video [Legacy]

This option allows you to control the execution of UEFI and Legacy PXE/ Storage/ Video OpROM.

Configuration options: [UEFI] [Legacy]

Other PCI devices [Legacy]

This item determines the OpROM execution policy for devices other than Network, Storage, or Video.

Configuration options: [UEFI] [Legacy]

3.4.15 NVMe Configuration

You may view the NVMe controller and Drive information if an NVMe device is connected.

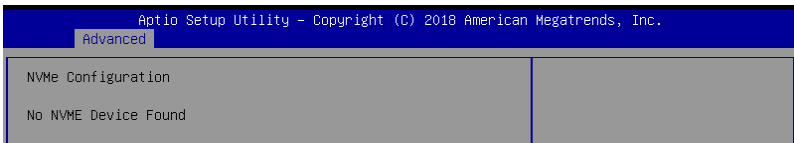

3.4.16 WHEA Configuration

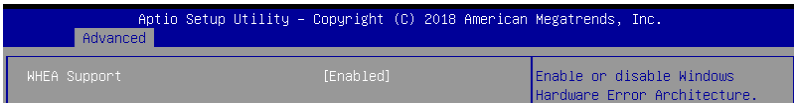

Whea Support [Enabled]

This item allows you to enable or disable the WHEA support.

Configuration options: [Disabled] [Enabled]

3.4.17 Tls Auth Configuration

Allows you to configure the Tls Auth.

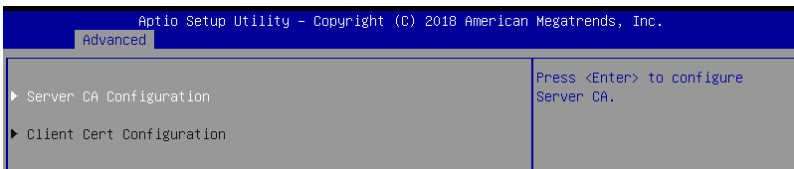

3.4.18 iSCSI Configuration

Allows you to configure the iSCSI parameters.

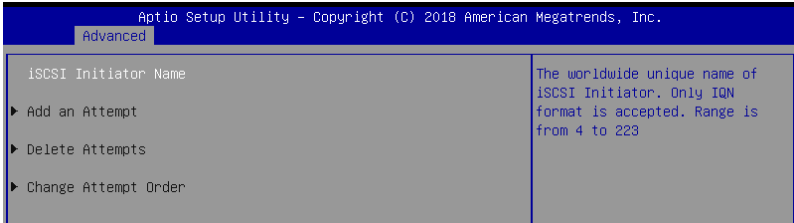

3.5 Chipset menu

The Chipset menu allows you to change the platform settings.

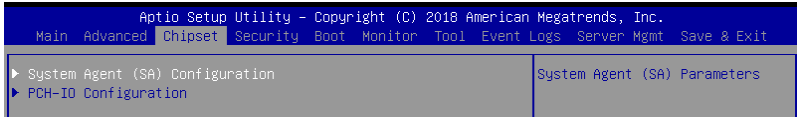

Take caution when changing the settings of the Chipset menu items. Incorrect field values can cause the system to malfunction.

3.5.1 System Agent (SA) Configuration

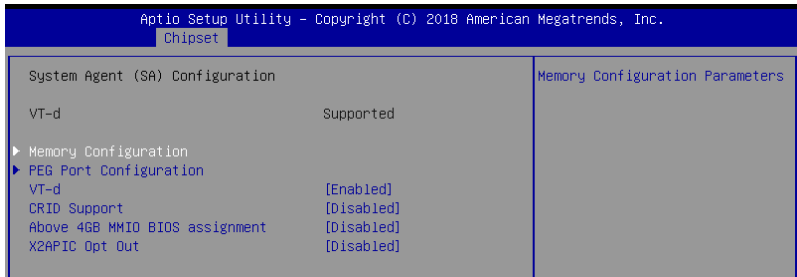

Memory Configuration

Memory Test on Warm Boot [Enabled]

Allows you to enable or disable the Base Memory Test Run on Warm Boot.
Configuration options: [Disabled] [Enabled]

Maximum Memory Frequency [Auto]

Allows you to select the maximum memory frequency setting.
Configuration options: [Auto] [2133] [2400] [2667]

ECC Support [Enabled]

Allows you to enable or disable the ECC support.
Configuration options: [Disabled] [Enabled]

Memory Scrambler [Enabled]

Allows you to enable or disable Memory Scrambler.
Configuration options: [Disabled] [Enabled]

Fast Boot [Disabled]

Allows you to enable or disable Fast Boot.
Configuration options: [Disabled] [Enabled]

PEG Port Configuration

PEG 0:1:0

Max Link Speed [Auto]

Allows you to set the Max Link Speed.

Configuration options: [Auto] [Gen1] [Gen2] [Gen3]

PEG0 Slot Power Limit Value [75]

Set the upper limit on power supplied by slot. Use the <+> or <-> to adjust the value. The values range from 0 to 255.

PEG0 Slot Power Limit Scale [1.0x]

Allows you to select the scale for the Slot Power Limit Value.

Configuration options: [1.0x] [0.1x] [0.01x] [0.001x]

PEG0 Physical Slot Number [1]

Allows you to set the physical slot number attached to this Port. The number has to be globally unique within the chassis. Use the <+> or <-> to adjust the value. The values range from 0 to 8191.

PEG 0:1:1

Max Link Speed [Auto]

Allows you to set the Max Link Speed.

Configuration options: [Auto] [Gen1] [Gen2] [Gen3]

PEG1 Slot Power Limit Value [75]

Set the upper limit on power supplied by slot. Use the <+> or <-> to adjust the value. The values range from 0 to 255.

PEG1 Slot Power Limit Scale [1.0x]

Allows you to select the scale for the Slot Power Limit Value.

Configuration options: [1.0x] [0.1x] [0.01x] [0.001x]

PEG1 Physical Slot Number [2]

Allows you to set the physical slot number attached to this Port. The number has to be globally unique within the chassis. Use the <+> or <-> to adjust the value. The values range from 0 to 8191.

PEG 0:1:2

Max Link Speed [Auto]

Allows you to set the Max Link Speed.

Configuration options: [Auto] [Gen1] [Gen2] [Gen3]

PEG2 Slot Power Limit Value [75]

Set the upper limit on power supplied by slot. Use the <+> or <-> to adjust the value. The values range from 0 to 255.

PEG2 Slot Power Limit Scale [1.0x]

Allows you to select the scale for the Slot Power Limit Value.

Configuration options: [1.0x] [0.1x] [0.01x] [0.001x]

PEG2 Physical Slot Number [3]

Allows you to set the physical slot number attached to this Port. The number has to be globally unique within the chassis. Use the <+> or <-> to adjust the value. The values range from 0 to 8191.

PEG3 Slot Power Limit Value [75]

Set the upper limit on power supplied by slot. Use the <+> or <-> to adjust the value. The values range from 0 to 255.

PEG3 Slot Power Limit Scale [1.0x]

Allows you to select the scale for the Slot Power Limit Value.

Configuration options: [1.0x] [0.1x] [0.01x] [0.001x]

PEG3 Physical Slot Number [3]

Allows you to set the physical slot number attached to this Port. The number has to be globally unique within the chassis. Use the <+> or <-> to adjust the value. The values range from 0 to 8191.

VT-d [Enabled]

Allows you to enable or disable VT-d capability.

Configuration options: [Disabled] [Enabled]

CRID Support [Disabled]

Allows you to enable or disable CRID control for Intel SIPP.

Configuration options: [Disabled] [Enabled]

Above 4GB MMIO BIOS Assignment [Disabled]

Allows you to enable or disable above 4 GB memory mapped IO BIOS assignment. This is enabled automatically if the aperture size is set to 2048MB.

Configuration options: [Disabled] [Enabled]



The following item is configurable only when you set **VT-d** to **[Enabled]**.

X2APIC Opt Out [Disabled]

Allows you to enable or disable X2APIC Opt Out.

Configuration options: [Disabled] [Enabled]

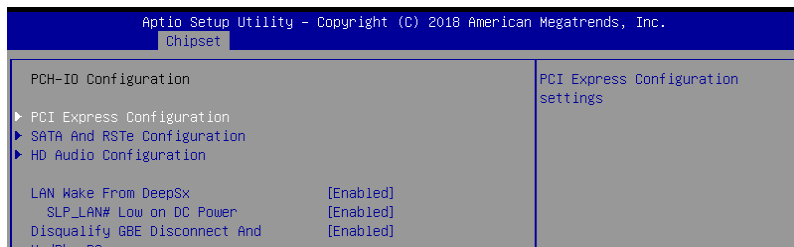
3.5.2 PCH-IO Configuration

PCI Express Configuration

PCI Express Clock Gating [Enabled]

Allows you to enable or disable PCI Express clock gating for each root port.

Configuration options: [Disabled] [Enabled]

DMI Link ASPM Control [Auto]

Allows you to enable or disable control of active state power management of DMI link.

Configuration options: [Disabled] [L0s] [L1] [L0sL1] [Auto]

Port8xh Decode [Disabled]

Allows you to enable or PCI express port 8xh decode.

Configuration options: [Disabled] [Enabled]



The following item appears only when you set Port8xh Decode to [Enabled].

Port8xh Decode Port# [0]

Select PCI Express Port8xh Decode Root Port. User to ensure port availability.

Configuration options: [0] - [23]

SATA And RST Configuration

SATA Controller(s) [Enabled]

Allows you to enable or disable the SATA Controller.

Configuration options: [Disabled] [Enabled]



The following items appear only when you set **SATA Controller(s)** to [Enabled].

SATA Mode Selection [AHCI]

Allows you to select the SATA controllers operation.

Configuration options: [AHCI] [RAID]

Serial ATA Port 0-5

Port 0-7 [Enabled]

Allows you to enable or disable the SATA port.

Configuration options: [Disabled] [Enabled]

Hot Plug [Enabled]

Allows you to enable or disable this port as hot pluggable.

Configuration options: [Disabled] [Enabled]

Spin Up Device [Disabled]

Allows you to enable or disable Spin Up Device.

Configuration options: [Disabled] [Enabled]

SATA Device Type [Hard Disk Drive]

Allows you to identify the SATA port is connected to a solid state drive or a hard disk drive

Configuration options: [Hard Disk Drive] [Solid State Drive]

HD Audio Configuration

HD Audio [Enabled]

Allows you to enable or disable the HD Audio.

Configuration options: [Disabled] [Enabled]



The following items appear only when you set **HD Audio** to **[Enabled]**.

Audio DSP [Disabled]

Allows you to enable or disable the Audio DSP.
Configuration options: [Disabled] [Enabled]



The following item appears only when you set **Audio DSP** to **[Enabled]**.

Audio DSP Compliance Mode [Non-UAA (IntelSST)]

Allows you to specify the DSP enabled system compliance.
[Non-UAA (IntelSST)] IntelSST driver support only
[UAA (HDA Inbox/IntelSST)] HD Audio Inbox or IntelSST driver support



NHLT (DMIC/BT/I2S configuration) is published for non-UAA only.

Audio Link Mode [HD Audio Link]

Allows you to select the audio link mode.
Configuration options: [HD Audio Link] [SSP (I2S)] [Soundwire] [Advanced Link Config]



The following items appear only when you set **Audio Link Mode** to **[Advanced Link Config]**.

HDA Link [Enabled]

Configuration options: [Disabled] [Enabled]

DMIC #0 [Enabled]

Configuration options: [Disabled] [Enabled]

DMIC #1 [Enabled]

Configuration options: [Disabled] [Enabled]

SSP #0 [Disabled]

Configuration options: [Disabled] [Enabled]

SSP #1 [Enabled]

Configuration options: [Disabled] [Enabled]

SSP #2 [Enabled]

Configuration options: [Disabled] [Enabled]

SNDW #1 [Disabled]

Configuration options: [Disabled] [Enabled]

SNDW #2 [Enabled]

Configuration options: [Disabled] [Enabled]

SNDW #3 [Disabled]

Configuration options: [Disabled] [Enabled]

SNDW #4 [Disabled]

Configuration options: [Disabled] [Enabled]

HDA-Link Codec Select [Platform Onboard]

Allows you to select the HDA-Link Codec.
Configuration options: [Platform Onboard] [External Kit]

HD Audio Advanced Configuration

iDisplay Audio Disconnect [Disabled]

Allows you to enable or disable iDisplay Audio Disconnect.
Configuration options: [Disabled] [Enabled]

Codec Sx Wake Capability [Disabled]

Allows you to enable or disable Codec Sx Wake Capability.
Configuration options: [Disabled] [Enabled]

PME Enable [Disabled]

Allows you to enable or disable PME wake of HD Audio controller during POST.
Configuration options: [Disabled] [Enabled]



The following item is configurable only when you set **Audio Link Mode** to **[Soundwire]**.

Soundwire Buffer RCOMP Setting [Non-ACT Topology]

This item allows you to select the Soundwire Buffer RCOMP Setting.
Configuration options: [Non-ACT Topology] [ACT Topology]

HD Audio Link Frequency [24 MHz]

Allows you to select the HD Audio Link Frequency.
Configuration options: [6 MHz] [12 MHz] [24 MHz]

iDisplay Audio Link Frequency [96 MHz]

Allows you to select the iDisplay Audio Link Frequency.
Configuration options: [48 MHz] [96 MHz]

iDisplay Audio Link T-Mode [2T Mode]

Allows you to select the iDisplay Audio Link T-Mode.
Configuration options: [1T Mode][2T Mode]

LAN Wake from DeepSx [Enabled]

This item allows you to enable wake from DeepSx by the assertion of LAN_WAKE# pin.
Configuration options: [Disabled] [Enabled]

SLP_LAN# Low on DC Power [Enabled]

This item allows you to enable or disable SLP_LAN# Low on DC Power.
Configuration options: [Disabled] [Enabled]

Disqualify GBE Disconnect And ModPhy PG [Enabled]

This item allows you to enable or disable Disqualify GBE Disconnect And ModPhy PG.
Configuration options: [Disabled] [Enabled]

3.6 Security menu

This menu allows a new password to be created or a current password to be changed. The menu also enables or disables the Secure Boot state and lets the user configure the System Mode state.

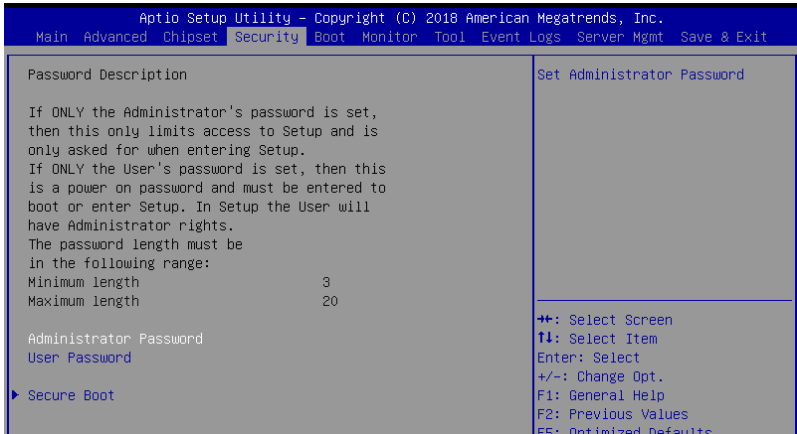

Administrator Password

To set an administrator password:

1. Select the Administrator Password item and press <Enter>.
2. From the Create New Password box, key in a password, then press <Enter>.
3. Confirm the password when prompted.

To change an administrator password:

1. Select the Administrator Password item and press <Enter>.
2. From the Enter Current Password box, key in the current password, then press <Enter>.
3. From the Create New Password box, key in a new password, then press <Enter>.
4. Confirm the password when prompted.



To clear the administrator password, follow the same steps as in changing an administrator password, but press <Enter> when prompted to create/confirm the password.

User Password

To set a user password:

1. Select the User Password item and press <Enter>.
2. From the Create New Password box, key in a password, then press <Enter>.
3. Confirm the password when prompted.

To change a user password:

1. Select the User Password item and press <Enter>.
2. From the Enter Current Password box, key in the current password, then press <Enter>.
3. From the Create New Password box, key in a new password, then press <Enter>.
4. Confirm the password when prompted.

To clear a user password:

1. Select the Clear User Password item and press <Enter>.
2. Select Yes from the Warning message window then press <Enter>.

Secure Boot

This item allows you to customize the Secure Boot settings.

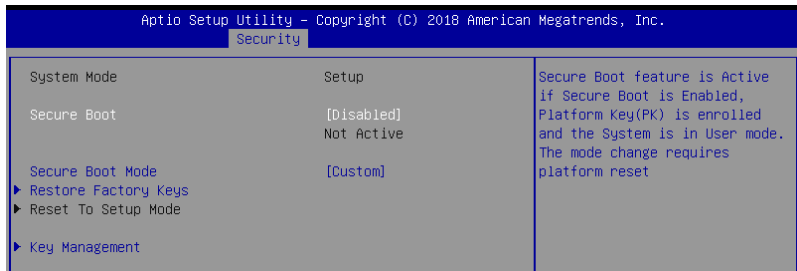

Secure Boot [Disabled]

Secure Boot can be enabled if the system is running in User mode with enrolled platform Key (EPK) or if the CSM function is disabled.

Configuration options: [Disabled] [Enabled]

Secure Boot Mode [Custom]

Allows you to set the Secure Boot selector.

Configuration options: [Custom] [Standard]

Restore Factory Keys

This option will force the system to User Mode, and install factory default Secure Boot key databases.

Reset to Setup Mode

This option will delete all Secure Boot key databases from NVRAM.

Key Management

This item only appears when the item Secure Boot Mode is set to [Custom]. The Key Management item allows you to modify Secure Boot variables and set Key Management page.

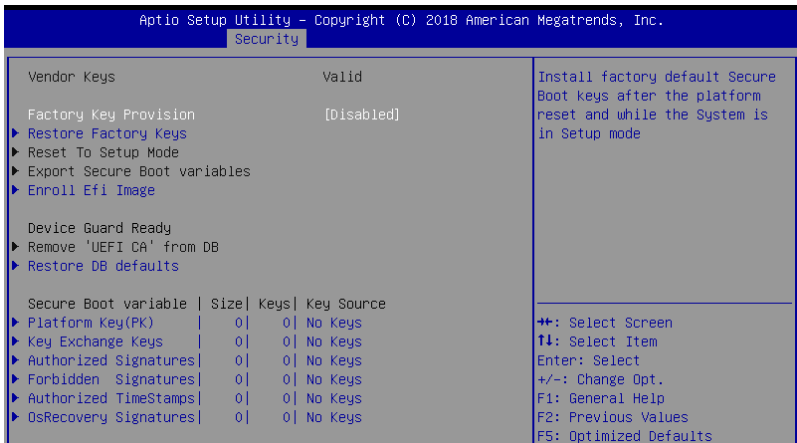

Factory Key Provision [Disabled]

Allows you to provision factory default Secure Boot keys when the system is in Setup Mode.

Configuration options: [Disabled] [Enabled]

Restore Factory keys

This item will install all Factory Default keys.

Reset to Setup Mode

This item appears only when you load the default Secure Boot keys. This item allows you to clear all default Secure Boot keys.

Export Secure Boot Variables

This item will ask you if you want to save all secure boot variables. Select Yes if you want to save all secure boot variables, otherwise select No.

Enroll Efi Image

This item will allow the image to run in Secure Boot mode.

Configuration options: [Set New] [Append]

Enroll Efi Image

This item will allow the image to run in Secure Boot mode.

Configuration options: [Set New] [Append]

Device Guard Ready

Remove 'UEFI CA' from DB

Remove Microsoft UEFI CA from Secure Boot DB.

Restore DB defaults

Restore DB variable to factory defaults.

Platform Key (PK)

Configuration options: [Details] [Export] [Update] [Delete]

Key Exchange Keys (KEK) / Authorized Signatures (DB) / Forbidden Signatures (DBX)

Configuration options: [Details] [Export] [Update] [Append] [Delete]

Authorized TimeStamps (DBT) / OsRecovery Signatures

Configuration options: [Update] [Append]

3.7 Boot menu

The Boot menu items allow you to change the system boot options.

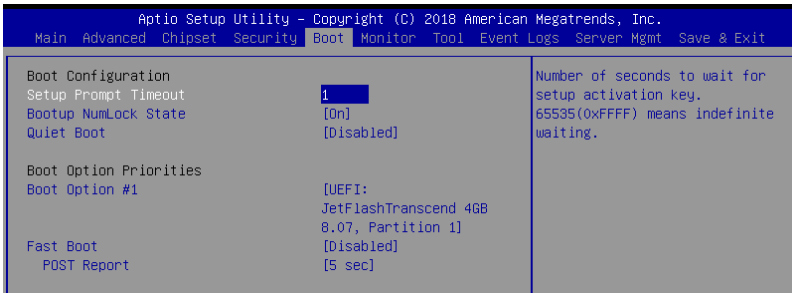

Setup Prompt Timeout [1]

Allows you to set the number of seconds that the firmware waits before initiating the original default boot selection. 65535(0xFFFF) means indefinite waiting. Use the <+> or <-> to adjust the value.

Bootup NumLock State [On]

Allows you to select the power-on state for the NumLock.

Configuration options: [Off] [On]

Quiet Boot [Disabled]

Allows you to enable or disable Quiet Boot option.

Configuration options: [Disabled] [Enabled]

Boot Option Priorities

These items specify the boot device priority sequence from the available devices. The number of device items that appears on the screen depends on the number of devices installed in the system.



- To select the boot device during system startup, press <F8> when ASUS Logo appears.
- To access Windows OS in Safe Mode, please press <F8> after POST.

Fast Boot [Disabled]

Allows you to enable or disable boot with initialization of a minimal set of devices required to launch active boot option. This has no effect for BBS boot options.

Configuration options: [Disabled] [Enabled]



The following item appears only when you set **Fast Boot** to **[Enabled]**.

Sata Support [All Sata Devices]

[Last Boot HDD Only] Only last booted HDD device will be available in POST.

[All Sata Devices] All SATA devices will be available in OS and POST.

VGA Support [EFI Driver]

[Auto] Only legacy OpRom with Legacy OS, and logo will NOT be shown during POST.

[EFI Driver] Efi driver will still be installed with EFI OS.

USB Support [Full Initial]

[Disabled] All USB devices will NOT be available until after OS boot.

[Partial Initial] USB Mass Storage and specific USB port/device will NOT be available before OS boot.

[Full Initial] All USB devices will be available in OS and POST.

PS2 Devices Support [Enabled]

If this option is disabled, PS2 devices will be skipped.

Configuration options: [Disabled] [Enabled]

Network Stack Driver Support [Disabled]

If this option is disabled, Network Stack Driver will be skipped.

Configuration options: [Disabled] [Enabled]

Redirection Support [Disabled]

If this option is disabled, Redirection function will be disabled.

Configuration options: [Disabled] [Enabled]



The following item appears only when you set **Quiet Boot** to **[Disabled]**.

POST Report [5 sec]

Allows you to set the desired POST Report waiting time from 1 to 10 seconds.

Configuration options: [1 sec] - [10 sec] [Until Press ESC]

3.8 Monitor menu

This menu displays the system temperature, fan speed, and power status. You can also change the fan settings in this menu.

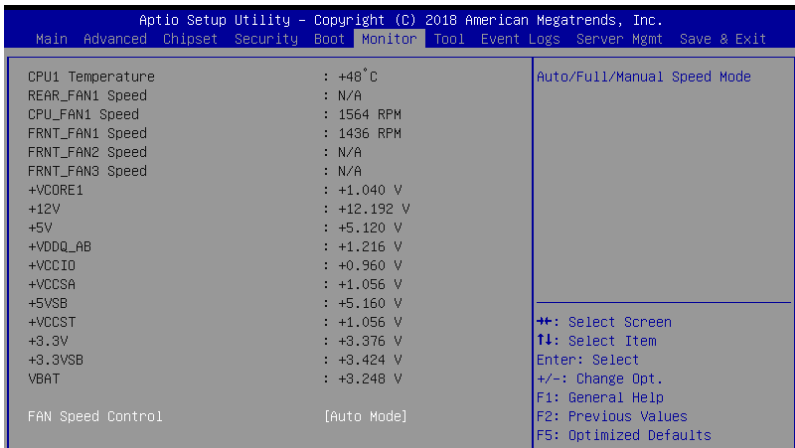

Fan Speed Control [Generic Mode]

Allows you to select the power-on state for the NumLock.

Configuration options: [Auto Mode] [Full Speed Mode] [Manual Speed Mode]



The following items appear only when you set **Fan Speed Control** to **[Manual Speed Mode]**.

REAR_FAN1 / CPU_FAN1 / FRNT_FAN1-3 Duty% [50]

Allows you to set the desired POST Report waiting time from 1 to 10 seconds. Use the <+> or <-> to adjust the value. The values range from 10 to 100.

3.9 Tool menu

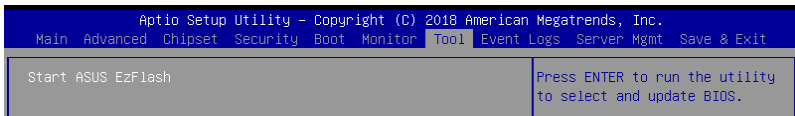

ASUS EZ Flash

Allows you to run ASUS EZ Flash BIOS ROM Utility when you press <Enter>. Refer to the ASUS EZ Flash Utility section for details.

3.10 Event Logs menu

The Event Logs menu items allow you to change the event log settings and view the system event logs.

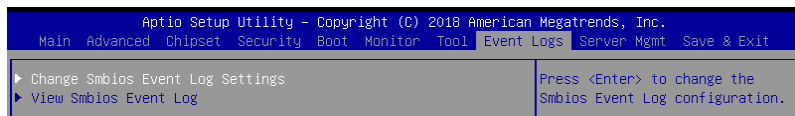

3.10.1 Change Smbios Event Log Settings

Press <Enter> to change the Smbios Event Log configuration.



All values changed here do not take effect until computer is restarted.

Enabling/Disabling Options

Smbios Event Log [Enabled]

Change this to enable or disable all features of Smbios Event Logging during boot.

Configuration options: [Disabled] [Enabled]



The following items appear only when you set **Smbios Event Log** to **[Enabled]**.

Erasing Settings

Erase Event Log [No]

Choose options for erasing Smbios Event Log. Erasing is done prior to any logging activation during reset.

Configuration options: [No] [Yes, Next reset] [Yes, Every reset]

When Log is Full [Do Nothing]

Choose options for reacting to a full Smbios Event Log.

Configuration options: [Do Nothing] [Erase Immediately]

Smbios Event Log Standard Settings

Log System Boot Event [Enabled]

This option allows you to enable or disable logging System boot event.

Configuration options: [Disabled] [Enabled]

MECI [1]

This option allows you to set the number of occurrences of a duplicate event that must pass before the multiple-event counter of log entry is updated. Use the <+> or <-> to adjust the value. The values range from 1 to 255.

METW [60]

This option allows you to set the number of minutes which must pass between duplicate log entries which utilize a multiple-event counter.

Use the <+> or <-> to adjust the value. The values range from 0 to 99.

Custom Options

Log EFI Status Code [Enabled]

This option allows you to enable or disable logging of the EFI Status Codes.
Configuration options: [Disabled] [Enabled]



The following item appears only when you set **Log EFI Status Code** to [Enabled].

Convert EFI Status Codes to Standard Smbios Type [Disabled]

This option allows you to enable or disable converting of EFI Status Codes to Standard Smbios Type (Not all may be translated).
Configuration options: [Disabled] [Enabled]

3.10.2 View Smbios Event Log

Press <Enter> to view all smbios event logs.

3.11 Server Mgmt menu

```
Aptio Setup Utility - Copyright (C) 2018 American Megatrends, Inc.
Main Advanced Chipset Security Boot Monitor Tool Event Logs Server Mgmt Save & Exit

BMC Self Test Status          FAILED
BMC Device ID                 Unknown
BMC Device Revision           Unknown
BMC Firmware Revision         Unknown
IPMI Version                  Unknown

BMC Support                    [Enabled]
Wait For BMC                  [Disabled]
FRB-2 Timer                   [Enabled]
FRB-2 Timer timeout           [6 minutes]
FRB-2 Timer Policy             [Do Nothing]
OS Watchdog Timer             [Disabled]
OS Wtd Timer Timeout          [10 minutes]
OS Wtd Timer Policy           [Reset]
Serial Mux                     [Disabled]
▶ System Event Log
▶ Bmc self test log
▶ BMC network configuration
▶ View System Event Log
▶ BMC User Settings
  BMC Warm Reset

Enable/Disable interfaces to
communicate with BMC

+*: Select Screen
↑↓: Select Item
Enter: Select
+/-: Change Opt.
F1: General Help
F2: Previous Values
F5: Optimized Defaults
F10: Save & Reset
F12: Print Screen
ESC: Exit
```

BMC Support [Enabled]

This item allows you to enable or disable interfaces to communicate with BMC.
Configuration options: [Disabled] [Enabled]



The following items appear only when **BMC Support** is set to **[Enabled]**.

Wait for BMC [Disabled]

Allows you to enable or disable wait for BMC response for specified time out.

Configuration options: [Disabled] [Enabled]

FRB-2 Timer [Enabled]

Allows you to enable or disable FRB-2 timer (POST timer).

Configuration options: [Disabled] [Enabled]

FRB-2 Timer timeout [6 minutes]

Allows you to select the FRB-2 Timer Expiration value.

Configuration options: [3 minutes] [4 minutes] [5 minutes] [6 minutes]

FRB-2 Timer Policy [Do Nothing]

Allows you to select the how the system should respond in FRB-2 Timer expires.

Configuration options: [Do Nothing] [Reset] [Power Down] [Power Cycle]

OS Watchdog Timer [Disabled]

This item allows you to start a BIOS timer which can only be shut off by Management Software after the OS loads.

Configuration options: [Disabled] [Enabled]



The following items are configurable only when **OS Watchdog Timer** is set to **[Enabled]**.

OS Wtd Timer Timeout [10 minutes]

Allows you to configure the length for the OS Boot Watchdog Timer.

Configuration options: [5 minutes] [10 minutes] [15 minutes] [20 minutes]

OS Wtd Timer Policy [Reset]

This item allows you to configure the how the system should respond if the OS Boot Watch Timer expires.

Configuration options: [Do Nothing] [Reset] [Power Down] [Power Cycle]

Serial Mux [Disabled]

Allows you to enable or disable Serial Mux configuration.

Configuration options: [Disabled] [Enabled]

BMC Warm Reset

This item allow you to perform a BMC warm reset.

3.11.1 System Event Log

Allows you to change the SEL event log configuration.

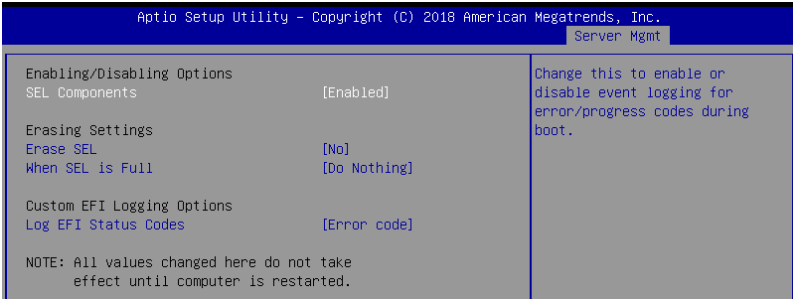

Enabling/Disabling Options

SEL Components [Enabled]

Allows you to enable or disable event logging for error/progress codes during boot.
Configuration options: [No] [Yes, On next reset] [Yes, On every reset]



- The following items are configurable only when **SEL Components** is set to **[Enabled]**.
- All values changed here do not take effect until computer is restarted.

Erasing Settings

Erase SEL [No]

Allows you to choose options for erasing SEL.
Configuration options: [No] [Yes, On next reset] [Yes, On every reset]

When SEL is Full [Do Nothing]

Allows you to choose options for reactions to a full SEL.
Configuration options: [Do Nothing] [Erase Immediately]

Custom EFI Logging Options

Log EFI Status Codes [Error code]

Allows you to select which codes to log.
Configuration options: [Disabled] [Both] [Error code] [Progress code]

3.11.2 Bmc self test log

Allows you to change the SEL event log configuration.

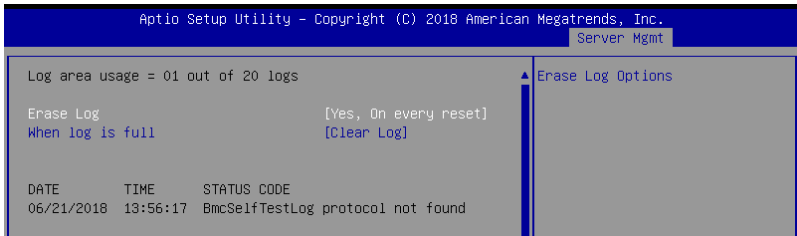

Erase Log [Yes, On every reset]

Choose options for erasing Smbios Event Log. Erasing is done prior to any logging activation during reset.

Configuration options: [No] [Yes, On every reset]

When Log is Full [Clear Log]

Allows you to choose options for reactions to a full Smbios Event Log.

Configuration options: [Clear Log] [Do not log any more]

3.11.3 BMC network configuration

The sub-items in this configuration allow you to configure the BMC network parameters.

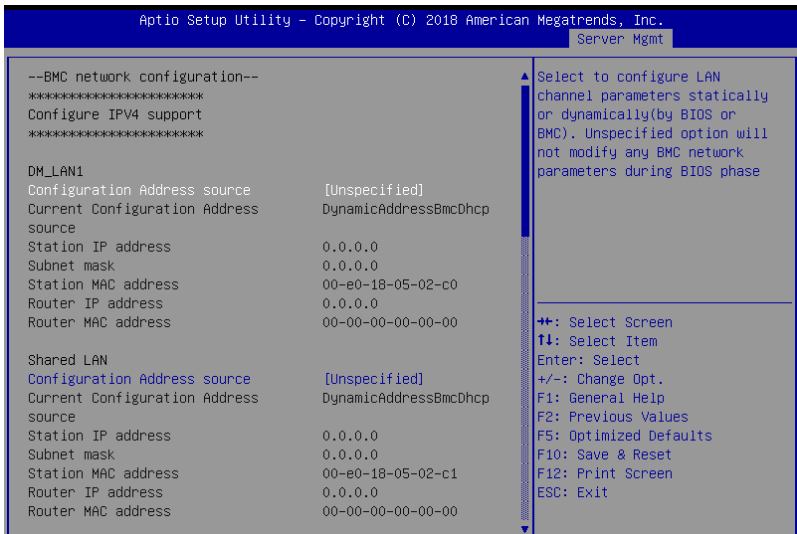

Navigate to the second page of the screen to see the rest of items in this menu by pressing the Up or Down arrow keys.



To quickly go to the last item of the second page, press the Page Down button. Press the Page Up button to go back to the first item in the first page.

IPV4

DM_LAN1 / Shared LAN

Configuration Address source [Unspecified]

This item allows you to configure LAN channel parameters statistically or dynamically (by BIOS or BMC). Unspecified option will not modify any BMC network parameters during BIOS phase.

Configuration options: [Unspecified] [Static] [DynamicBmcDhcp] [DynamicBmcNonDhcp]

IPV6

DM_LAN1

IPV6 Support [Enabled]

Allows you to enable or disable LAN1 IPV6 Support.

Configuration options: [Disabled] [Enabled]



The following items appear only when **IPV6 Support** is set to **[Enabled]**.

Configuration Address source [Unspecified]

This item allows you to configure LAN channel parameters statistically or dynamically (by BIOS or BMC). Unspecified option will not modify any BMC network parameters during BIOS phase.

Configuration options: [Unspecified] [Static] [DynamicBmcDhcp]

Shared LAN

IPV6 Support [Enabled]

Allows you to enable or disable LAN2 IPV6 Support.

Configuration options: [Disabled] [Enabled]



The following items appear only when **IPV6 Support** is set to **[Enabled]**.

Configuration Address source [Unspecified]

This item allows you to configure LAN channel parameters statistically or dynamically (by BIOS or BMC). Unspecified option will not modify any BMC network parameters during BIOS phase.

Configuration options: [Unspecified] [Static] [DynamicBmcDhcp]

3.11.4 View System Event Log

This item allows you to view the system event log records.

3.11.5 BMC User Settings

The sub-items in this configuration allow you to add, delete, or change BMC user settings.

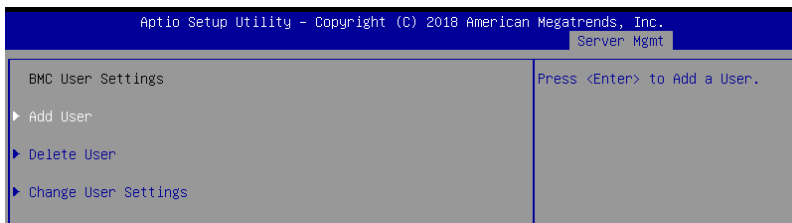

3.12 Save & Exit menu

The Exit menu items allow you to save or discard your changes to the BIOS items.

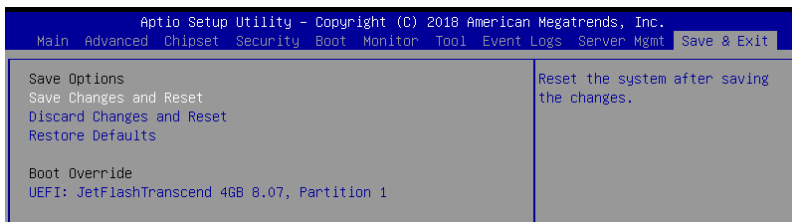

Pressing <Esc> does not immediately exit this menu. Select one of the options from this menu or <F10> from the legend bar to exit.

Save Changes and Reset

Exit System setup after saving the changes.

Discard Changes and Reset

Exit System setup without saving any changes.

Restore Defaults

Restore/load default values for all the setup options.

Boot Override

These items displays the available devices. The device items that appears on the screen depends on the number of devices installed in the system. Click an item to start booting from the selected device.

RAID Support

4

4.1 RAID configurations

The motherboard supports Intel® Rapid Storage Technology Option ROM Utility with RAID 0, RAID 1, RAID 10, and RAID 5 support.



If you want to install a Windows® operating system to a hard disk drive included in a RAID set, you have to create a RAID driver disk and load the RAID driver during OS installation. Refer to section **4.2 Creating a RAID driver disk** for details.

4.1.1 RAID definitions

RAID 0 (Data striping) optimizes two identical hard disk drives to read and write data in parallel, interleaved stacks. Two hard disks perform the same work as a single drive but at a sustained data transfer rate, double that of a single disk alone, thus improving data access and storage. Use of two new identical hard disk drives is required for this setup.

RAID 1 (Data mirroring) copies and maintains an identical image of data from one drive to a second drive. If one drive fails, the disk array management software directs all applications to the surviving drive as it contains a complete copy of the data in the other drive. This RAID configuration provides data protection and increases fault tolerance to the entire system. Use two new drives or use an existing drive and a new drive for this setup. The new drive must be of the same size or larger than the existing drive.

RAID 5 stripes both data and parity information across three or more hard disk drives. Among the advantages of RAID 5 configuration include better HDD performance, fault tolerance, and higher storage capacity. The RAID 5 configuration is best suited for transaction processing, relational database applications, enterprise resource planning, and other business systems. Use a minimum of three identical hard disk drives for this setup.

RAID 10 is data striping and data mirroring combined without parity (redundancy data) having to be calculated and written. With the RAID 10 configuration you get all the benefits of both RAID 0 and RAID 1 configurations. Use four new hard disk drives or use an existing drive and three new drives for this setup.

4.1.2 Installing Serial ATA hard disks

The motherboard supports Serial ATA hard disk drives. For optimal performance, install identical drives of the same model and capacity when creating a disk array.

To install the SATA hard disks for a RAID configuration:

1. Install the SATA hard disks into the drive bays.
2. Connect the SATA signal cables.
3. Connect a SATA power cable to the power connector on each drive.

4.1.3 Setting the RAID item in BIOS

You must set the RAID item in the BIOS Setup before you can create a RAID set from SATA hard disk drives attached to the SATA connectors supported by Intel® C621 chipset.

To do this:

1. Enter the BIOS Setup during POST.
2. Go to the **Chipset** menu > **PCH-IO Configuration** menu > **SATA And RST Configuration**, then press <Enter>.
3. Set **SATA Mode Selection** to **[RAID]**.
4. Press <F10> to save your changes and exit the BIOS Setup.



Refer to Chapter 3 for details on entering and navigating through the BIOS Setup.

4.1.4 RAID configuration utilities

Depending on the RAID connectors that you use, you can create a RAID set using the utilities embedded in each RAID controller. For example, use the Intel® Rapid Storage Technology if you installed Serial ATA hard disk drives on the Serial ATA connectors supported by the Intel® C246 chipset.

Refer to the succeeding section for details on how to use the RAID configuration utility.

4.2 Intel® Rapid Storage Technology Option ROM utility

The Intel® Rapid Storage Technology SATA Option ROM utility allows you to create RAID 0, RAID 1, RAID 10 (RAID 1+0), and RAID 5 set from Serial ATA hard disk drives that are connected to the Serial ATA connectors supported by the Southbridge.



Before you proceed, ensure that you have installed the Serial ATA hard disk drives, and have set the correct SATA mode in the BIOS setup.

To enter the Intel® Rapid Storage Technology Option ROM utility:

1. Turn on the system.
2. During POST, press <Ctrl> + <I> to display the utility main menu.

```
Intel(R) Rapid Storage Technology - Option - v10.5.1.1070
Copyright(C) 2003-14 Intel Corporation. All Rights Reserved.

[ MAIN MENU ]

1. Create RAID Volume          4. Recovery Volume Options
2. Delete RAID Volume         5. Acceleration Options
3. Reset Disks to Non-RAID    6. Exit

[ DISK/VOLUME INFORMATION ]

RAID Volumes:
None defined.

Physical Devices:
Port  Device Model  Serial #      Size   Type/Status (Vol ID)
0     ST3160812AS      9LS0HJA4     149.0GB Non-RAID Disk
1     ST3160812AS      9LS0F4HL     149.0GB Non-RAID Disk
2     ST3160812AS      3LS0JYL8     149.0GB Non-RAID Disk
3     ST3160812AS      9LS0BJ5H     149.0GB Non-RAID Disk

[↑↓]-Select      [ESC]-Exit      [ENTER]-Select Menu
```

The navigation keys at the bottom of the screen allow you to move through the menus and select the menu options.



The RAID BIOS setup screens shown in this section are for reference only and may not exactly match the items on your screen.



The utility supports maximum four hard disk drives for RAID configuration.

4.2.1 Creating a RAID set

To create a RAID set:

1. From the utility main menu, select **1. Create RAID Volume** and press <Enter>. The following screen appears:

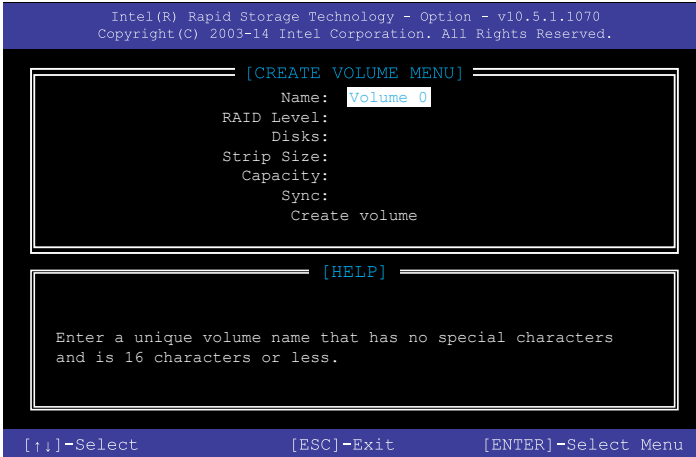

2. Enter a name for the RAID set and press <Enter>.
3. When the RAID Level item is selected, press the up/down arrow key to select a RAID level to create, and then press <Enter>.
4. When the Disks item is selected, press <Enter> to select the hard disk drives you want to include in the RAID set. The SELECT DISKS screen appears:

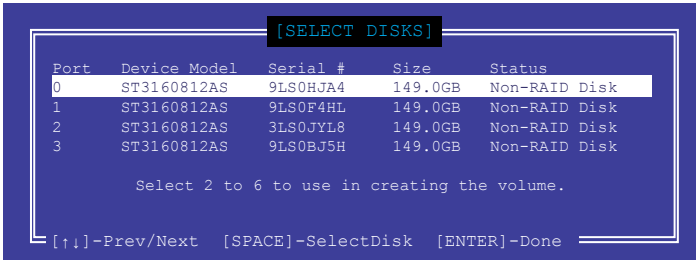

5. Use the up/down arrow key to select a drive, and then press <Space> to select. A small triangle marks the selected drive. Press <Enter> after completing your selection.
6. Use the up/down arrow key to select the strip size for the RAID array (for RAID 0, 10 and 5 only), and then press <Enter>. The available strip size values range from 4 KB to 128 KB. The following are typical values:
 - RAID 0: 128 KB
 - RAID 10: 64 KB
 - RAID 5: 64 KB



We recommend a lower strip size for server systems, and a higher strip size for multimedia computer systems used mainly for audio and video editing.

7. When the **Capacity** item is selected, enter the RAID volume capacity that you want and press <Enter>. The default value indicates the maximum allowed capacity.
8. When the **Create Volume** item is selected, press <Enter>. The following warning message appears:

```
WARNING: ALL DATA ON SELECTED DISKS WILL BE LOST.  
Are you sure you want to create this volume? (Y/N)
```

9. Press <Y> to create the RAID volume and return to the main menu, or <N> to go back to the CREATE VOLUME menu.

4.2.2 Deleting a RAID set



Be cautious when deleting a RAID set. You will lose all data on the hard disk drives when you delete a RAID set.

To delete a RAID set:

1. From the utility main menu, select **2. Delete RAID Volume** and press <Enter>. The following screen appears:

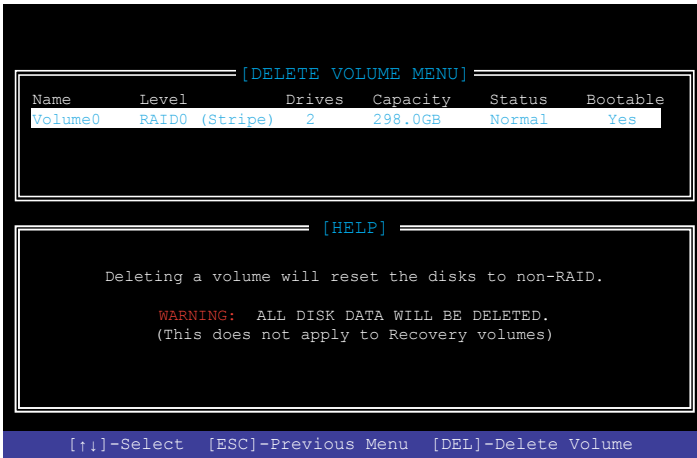

2. Use the up/down arrow key to select the RAID set you want to delete, and then press <Delete>. The following warning message appears:

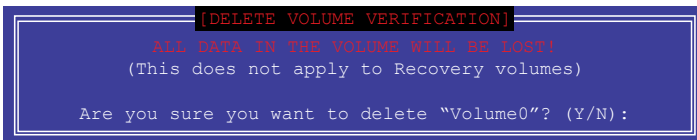

3. Press <Y> to delete the RAID set and return to the utility main menu, or press <N> to return to the DELETE VOLUME menu.

4.2.3 Exiting the Intel® Rapid Storage Technology Option ROM utility

To exit the utility:

1. From the utility main menu, select **6. Exit**, then press <Enter>. The following warning message appears:

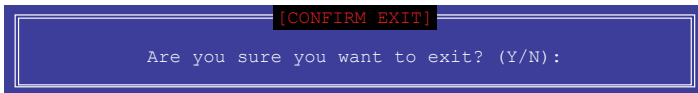

2. Press <Y> to exit or press <N> to return to the utility main menu.

4.3 Creating a RAID driver disk

4.3.1 Creating a RAID driver disk in Windows®

To install the RAID driver for Windows® OS:

1. During the OS installation, click **Load Driver** to allow you to select the installation media containing the RAID driver.
2. Insert the USB flash drive with RAID driver into the USB port or the support DVD into the optical drive, and then click **Browse**.
3. Click the name of the device you've inserted, go to **Drivers > RAID**, and then select the RAID driver for the corresponding OS version. Click **OK**.
4. Follow the succeeding screen instructions to complete the installation.



Before loading the RAID driver from a USB flash drive, you have to use another computer to copy the RAID driver from the support DVD to the USB flash drive.



To set up a Windows® UEFI operating system under RAID mode, ensure to load the UEFI driver for your optical drive.

4.4 Intel® Rapid Storage Technology (Windows)

The Intel® Rapid Storage Technology allows you to create RAID 0, RAID 1, RAID 10 (RAID 1+0), and RAID 5 set(s) from Serial ATA hard disk drives that are connected to the Serial ATA connectors supported by the Southbridge.



You need to manually install the Intel® Rapid Storage Technology utility on a Windows® operating system.

To enter the Intel® Rapid Storage Technology utility under Windows operating system:

1. Turn on the system and go to the windows desktop.
2. Click the **Intel® Rapid Storage Technology** icon to display the main menu.

Your storage system is configured for data protection, increased performance and optimal data storage capacity. You can create additional volumes to further optimize your storage system.

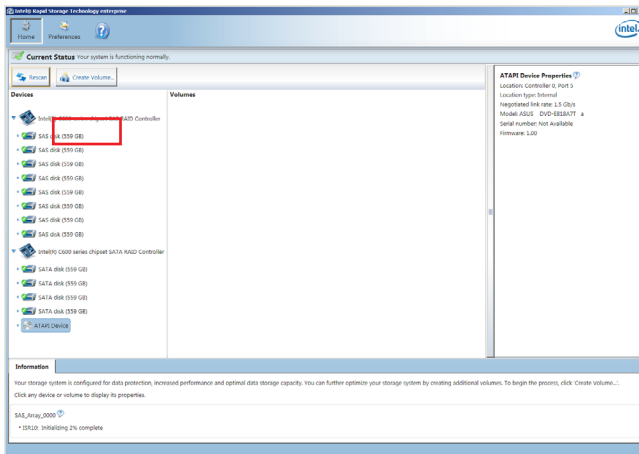

You can click **Rescan** to re-scan any attached hard disks.

4.3.1 Creating a RAID set

To create a RAID set:

1. From the utility main menu, select **Create Volume** and select volume type.
2. Click **Next**.

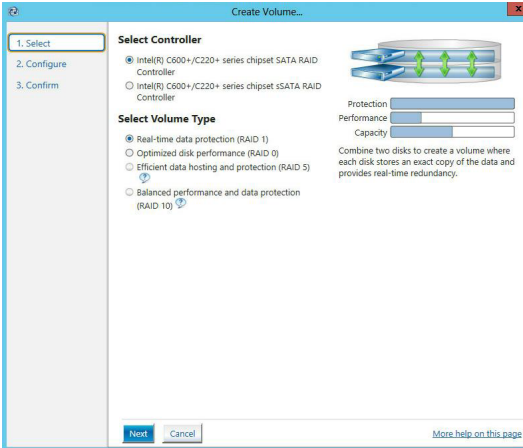

3. Enter a name for the RAID set, then select the array disks.
4. Select **Volume Size** tab, you can drag the bar to decide the volume size.
5. Click **Next**.

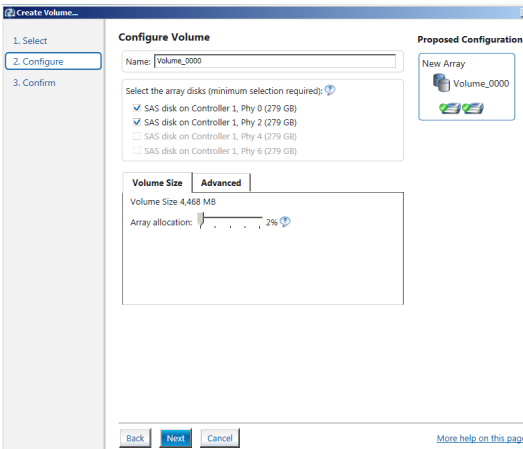

- If you do not want to keep the data on one of the selected disks, select **NO** when prompted.
- If you want to **Enable volume write-back cache** or **Initialize volume**, click **Advanced**.

6. Confirm the volume creation, then click **Create Volume** to continue.



This process could take a while depending on the number and size of the disks. You can continue using other applications during this time.

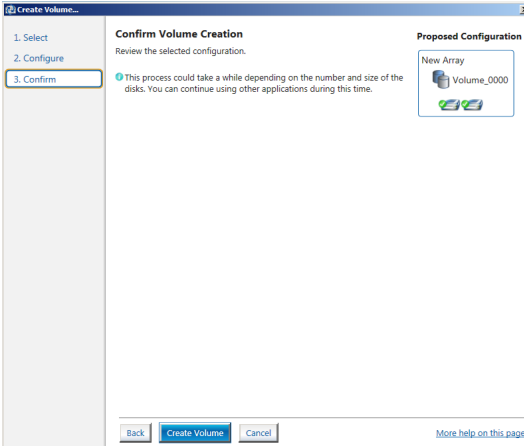

7. Wait until the process is completed, then click **OK** when prompted.

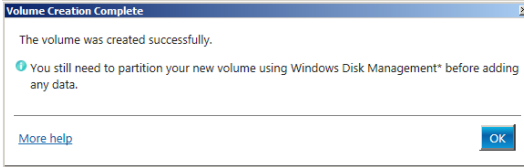

You still need to partition your new volume using Windows Disk Management before adding any data.

The RAID set is displayed in the **Volumes** list and you can change the settings in **Volume Properties**.

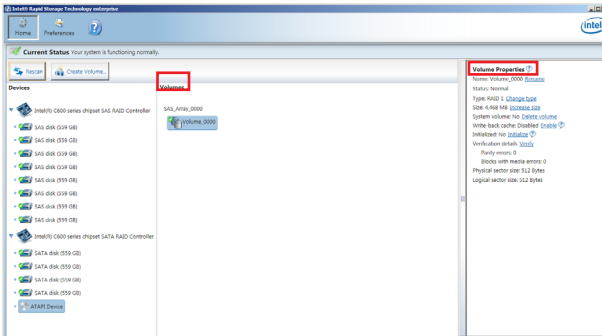

4.3.2 Changing a Volume Type

To change the volume type in **Volume Properties**:

1. Click the SATA array items you want to change in **Volumes** field.
2. From the **Volume Properties** field, select **Type: RAID 1 Change type**.

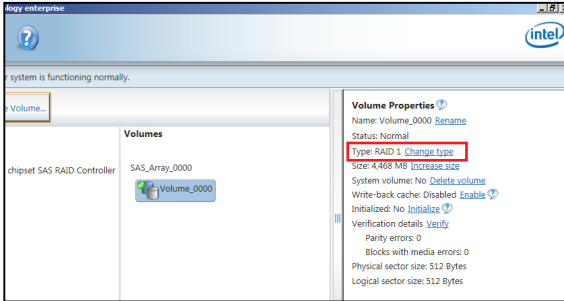

3. You can change the **Name**, **Select the new volume type**, and **Select additional disks to include in the new volume** if needed.
4. Select the **Data stripe size** for the RAID array (for RAID 0, 10 and 5 only), and click **OK**. The available stripe size values range from 4 KB to 128 KB. The following are typical values:
RAID 0: 128KB
RAID 10: 64KB
RAID 5: 64KB

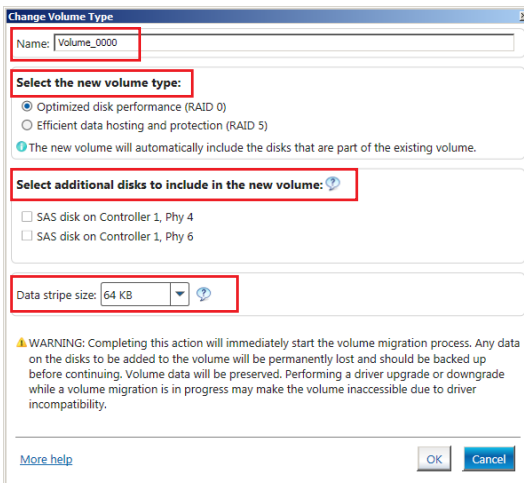

We recommend a lower stripe size for server systems, and a higher stripe size for multimedia computer systems used mainly for audio and video editing.

4.3.3 Deleting a volume



Be cautious when deleting a volume. You will lose all data on the hard disk drives. Before you proceed, ensure that you back up all your important data from your hard drives.

To delete a volume:

1. From the utility main menu, select the volume (ex. Volume_0000) in **Volumes** field you want to delete.

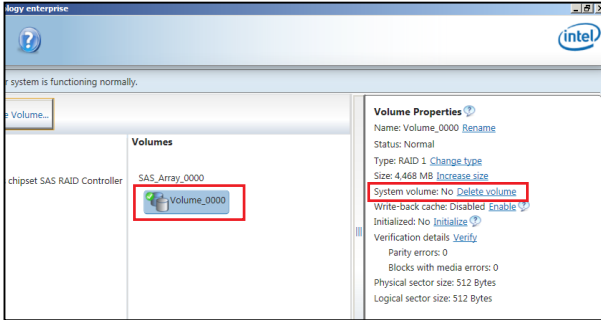

2. Select **Delete volume** in **Volume Properties** field. The following screen appears.

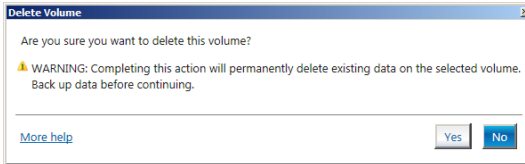

3. Click **Yes** to delete the volume and return to the utility main menu, or click **No** to return to the main menu.

4.3.4 Preferences

System Preferences

Allow you to set to show the notification area icon and show system information, warning, or errors here.

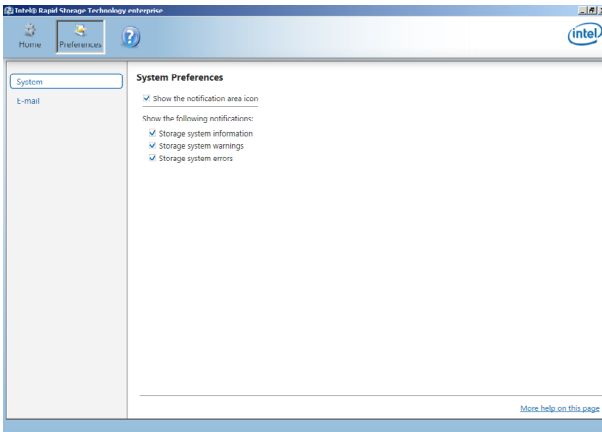

E-Mail Preferences

Allow you to set to sent e-mail of the following events:

- Storage system information
- Storage system warnings
- Storage system errors

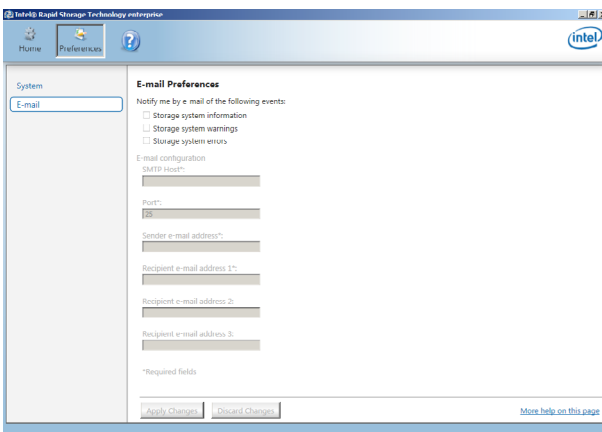

Appendix

WS C246M PRO block diagram

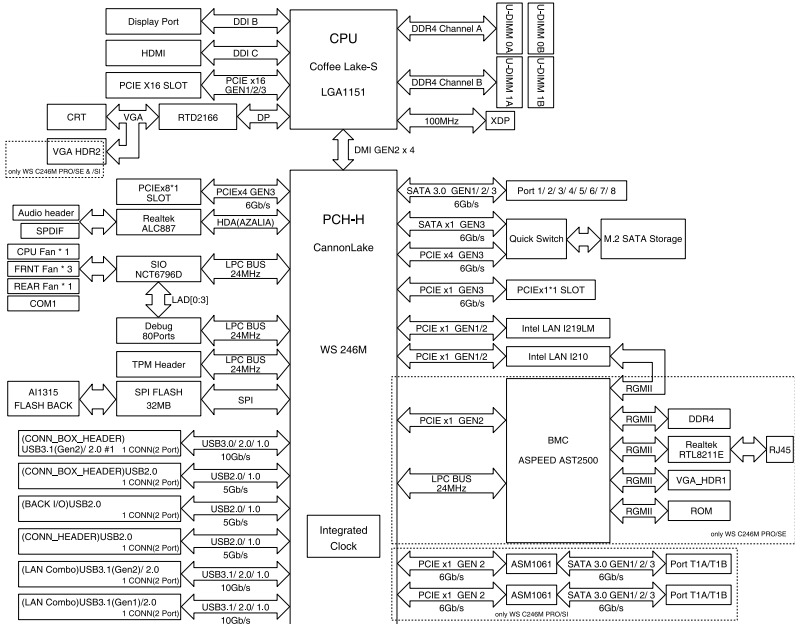

Q-Code table

Code	Description
00	Not used
02	microcode
03	CACHE_ENABLED
04	PCH initialization
06	CPU_EARLY_INIT
10	PEI Core is started
11 – 14	Pre-memory CPU initialization is started
15 – 18	Pre-memory System Agent initialization is started
19 – 1C	Pre-memory PCH initialization is started
2B – 2F	Memory initialization
30	Reserved for ASL (see ASL Status Codes section below)
31	Memory Installed
32 – 36	CPU post-memory initialization
37 – 3A	Post-Memory System Agent initialization is started
3B – 3E	Post-Memory PCH initialization is started
4F	DXE IPL is started
50 – 53	Memory initialization error. Invalid memory type or incompatible memory speed
4F	DXE IPL is started
54	Unspecified memory initialization error
55	Memory not installed
56	Invalid CPU type or Speed
57	CPU mismatch
58	CPU self test failed or possible CPU cache error
59	CPU micro-code is not found or micro-code update is failed
5A	Internal CPU error
5B	Reset PPI is not available
5C – 5F	Reserved for future AMI error codes
E0	S3 Resume is started (S3 Resume PPI is called by the DXE IPL)
E1	S3 Boot Script execution
E2	Video repost
E3	OS S3 wake vector call
E4 – E7	Reserved for future AMI progress codes
E8	S3 Resume Failed
E9	S3 Resume PPI not Found
EA	S3 Resume Boot Script Error
EB	S3 OS Wake Error
EC – EF	Reserved for future AMI error codes
F0	Recovery condition triggered by firmware (Auto recovery)
F1	Recovery condition triggered by user (Forced recovery)
F2	Recovery process started
F3	Recovery firmware image is found
F4	Recovery firmware image is loaded
F5 – F7	Reserved for future AMI progress codes
F8	Recovery PPI is not available
F9	Recovery capsule is not found

(continued on the next page)

Code	Description
FA	Invalid recovery capsule
FB – FF	Reserved for future AMI error codes
60	DXE Core is started
61	NVRAM initialization
62	Installation of the PCH Runtime Services
63 – 67	CPU DXE initialization is started
68	PCI host bridge initialization
69	System Agent DXE initialization is started
6A	System Agent DXE SMM initialization is started
6B – 6F	System Agent DXE initialization (System Agent module specific)
70	PCH DXE initialization is started
71	PCH DXE SMM initialization is started
72	PCH devices initialization
73 – 77	PCH DXE Initialization (PCH module specific)
78	ACPI module initialization
79	CSM initialization
7A – 7F	Reserved for future AMI DXE codes
90	Boot Device Selection (BDS) phase is started
91	Driver connecting is started
92	PCI Bus initialization is started
93	PCI Bus Hot Plug Controller Initialization
94	PCI Bus Enumeration
95	PCI Bus Request Resources
96	PCI Bus Assign Resources
97	Console Output devices connect
98	Console input devices connect
99	Super IO Initialization
9A	USB initialization is started
9B	USB Reset
9C	USB Detect
9D	USB Enable
9E – 9F	Reserved for future AMI codes
A0	IDE initialization is started
A1	IDE Reset
A2	IDE Detect
A3	IDE Enable
A4	SCSI initialization is started
A5	SCSI Reset
A6	SCSI Detect
A7	SCSI Enable
A8	Setup Verifying Password
A9	Start of Setup
AA	Reserved for ASL (see ASL Status Codes section below)
AB	Setup Input Wait

(continued on the next page)

Code	Description
AC	Reserved for ASL (see ASL Status Codes section below)
AD	Ready To Boot event
AE	Legacy Boot event
AF	Exit Boot Services event
B0	Runtime Set Virtual Address MAP Begin
B1	Runtime Set Virtual Address MAP End
B2	Legacy Option ROM Initialization
B3	System Reset
B4	USB hot plug
B5	PCI bus hot plug
B6	Clean-up of NVRAM
B7	Configuration Reset (reset of NVRAM settings)
B8– BF	Reserved for future AML codes
D0	CPU initialization error
D1	System Agent initialization error
D2	PCH initialization error
D3	Some of the Architectural Protocols are not available
D4	PCI resource allocation error. Out of Resources
D5	No Space for Legacy Option ROM
D6	No Console Output Devices are found
D7	No Console Input Devices are found
D8	Invalid password
D9	Error loading Boot Option (LoadImage returned error)
DA	Boot Option is failed (StartImage returned error)
DB	Flash update is failed
DC	Reset protocol is not available

ACPI/ASL Checkpoints (under OS)

Code	Description
03	System is entering S3 sleep state
04	System is entering S4 sleep state
05	System is entering S5 sleep state
30	System is waking up from the S3 sleep state
40	System is waking up from the S4 sleep state
AC	System has transitioned into ACPI mode. Interrupt controller is in PIC mode.
AA	System has transitioned into ACPI mode. Interrupt controller is in APIC mode.

Notices

Federal Communications Commission Statement

This device complies with Part 15 of the FCC Rules. Operation is subject to the following two conditions:

- This device may not cause harmful interference.
- This device must accept any interference received including interference that may cause undesired operation.

This equipment has been tested and found to comply with the limits for a Class B digital device, pursuant to Part 15 of the FCC Rules. These limits are designed to provide reasonable protection against harmful interference in a residential installation. This equipment generates, uses and can radiate radio frequency energy and, if not installed and used in accordance with manufacturer's instructions, may cause harmful interference to radio communications. However, there is no guarantee that interference will not occur in a particular installation. If this equipment does cause harmful interference to radio or television reception, which can be determined by turning the equipment off and on, the user is encouraged to try to correct the interference by one or more of the following measures:

- Reorient or relocate the receiving antenna.
- Increase the separation between the equipment and receiver.
- Connect the equipment to an outlet on a circuit different from that to which the receiver is connected.
- Consult the dealer or an experienced radio/TV technician for help.



The use of shielded cables for connection of the monitor to the graphics card is required to assure compliance with FCC regulations. Changes or modifications to this unit not expressly approved by the party responsible for compliance could void the user's authority to operate this equipment.

Compliance Statement of Innovation, Science and Economic Development Canada (ISED)

This device complies with Innovation, Science and Economic Development Canada licence exempt RSS standard(s). Operation is subject to the following two conditions: (1) this device may not cause interference, and (2) this device must accept any interference, including interference that may cause undesired operation of the device.

CAN ICES-3(B)/NMB-3(B)

Déclaration de conformité de Innovation, Sciences et Développement économique Canada (ISED)

Le présent appareil est conforme aux CNR d'Innovation, Sciences et Développement économique Canada applicables aux appareils radio exempts de licence. L'exploitation est autorisée aux deux conditions suivantes : (1) l'appareil ne doit pas produire de brouillage, et (2) l'utilisateur de l'appareil doit accepter tout brouillage radioélectrique subi, même si le brouillage est susceptible d'en compromettre le fonctionnement.

CAN ICES-3(B)/NMB-3(B)

VCCI: Japan Compliance Statement

Class B ITE

この装置は、クラスB情報技術装置です。この装置は、家庭環境で使用することを目的としていますが、この装置がラジオやテレビジョン受信機に近接して使用されると、受信障害を引き起こすことがあります。

取扱説明書に従って正しい取り扱いをして下さい。

VCCI-B

KC: Korea Warning Statement

B급 기기 (가정용 방송통신기자재)

이 기기는 가정용(B급) 전자파적합기기로서 주로 가정에서 사용하는 것을 목적으로 하며, 모든 지역에서 사용할 수 있습니다.

REACH

Complying with the REACH (Registration, Evaluation, Authorisation, and Restriction of Chemicals) regulatory framework, we published the chemical substances in our products at ASUS REACH website at <http://csr.asus.com/english/REACH.htm>.



DO NOT throw the motherboard in municipal waste. This product has been designed to enable proper reuse of parts and recycling. This symbol of the crossed out wheeled bin indicates that the product (electrical and electronic equipment) should not be placed in municipal waste. Check local regulations for disposal of electronic products.



DO NOT throw the mercury-containing button cell battery in municipal waste. This symbol of the crossed out wheeled bin indicates that the battery should not be placed in municipal waste.

ASUS Recycling/Takeback Services

ASUS recycling and takeback programs come from our commitment to the highest standards for protecting our environment. We believe in providing solutions for you to be able to responsibly recycle our products, batteries, other components as well as the packaging materials. Please go to <http://csr.asus.com/english/Takeback.htm> for detailed recycling information in different regions.

Regional notice for California



WARNING

Cancer and Reproductive Harm -
www.P65Warnings.ca.gov

RF exposure warning

This equipment must be installed and operated in accordance with provided instructions and the antenna(s) used for this transmitter must be installed to provide a separation distance of at least 20 cm from all persons and must not be co-located or operating in conjunction with any other antenna or transmitter. End-users and installers must be provided with antenna installation instructions and transmitter operating conditions for satisfying RF exposure compliance.

Google™ License Terms

Copyright© 2018 Google Inc. All Rights Reserved.

Licensed under the Apache License, Version 2.0 (the “License”); you may not use this file except in compliance with the License. You may obtain a copy of the License at:

<http://www.apache.org/licenses/LICENSE-2.0>

Unless required by applicable law or agreed to in writing, software distributed under the License is distributed on an “AS IS” BASIS, WITHOUT WARRANTIES OR CONDITIONS OF ANY KIND, either express or implied.

See the License for the specific language governing permissions and limitations under the License.

English ASUSTeK Computer Inc. hereby declares that this device is in compliance with the essential requirements and other relevant provisions of related Directives. Full text of EU declaration of conformity is available at: www.asus.com/support

Français ASUSTeK Computer Inc. déclare par la présente que cet appareil est conforme aux critères essentiels et autres clauses pertinentes des directives concernées. La déclaration de conformité de l'UE peut être téléchargée à partir du site Internet suivant: www.asus.com/support

Deutsch ASUSTeK Computer Inc. erklärt hiermit, dass dieses Gerät mit den wesentlichen Anforderungen und anderen relevanten Bestimmungen der zugehörigen Richtlinien übereinstimmt. Der gesamte Text der EU-Konformitätserklärung ist verfügbar unter: www.asus.com/support

Italiano ASUSTeK Computer Inc. con la presente dichiara che questo dispositivo è conforme ai requisiti essenziali e alle altre disposizioni pertinenti con le direttive correlate. Il testo completo della dichiarazione di conformità UE è disponibile all'indirizzo: www.asus.com/support

Русский Компания ASUS заявляет, что это устройство соответствует основным требованиям и другим соответствующим условиям соответствующих директив. Подробную информацию, пожалуйста, смотрите на www.asus.com/support

Български С настоящото ASUSTeK Computer Inc. декларира, че това устройство е в съответствие със съществени изисквания и другите приложими постановления на свързаните директиви. Пълният текст на декларацията за съответствие на ЕС е достъпен на адрес: www.asus.com/support

Hrvatski ASUSTeK Computer Inc. ovim izjavljuje da je ovaj uređaj sukladan s bitnim zahtjevima i ostalim odgovarajućim odredbama vezanih direktiva. Cijeli tekst EU izjave o sukladnosti dostupan je na: www.asus.com/support

Čeština Společnost ASUSTeK Computer Inc. tímto prohlašuje, že toto zařízení splňuje základní požadavky a další příslušná ustanovení souvisejících směrnic. Plné znění prohlášení o shodě EU je k dispozici na adrese: www.asus.com/support

Dansk ASUSTeK Computer Inc. erklærer hermed, at denne enhed er i overensstemmelse med hovedkravene og andre relevante bestemmelser i de relaterede direktiver. Hele EU-overensstemmelseserklæringen kan findes på: www.asus.com/support

Nederlands ASUSTeK Computer Inc. verklaart hierbij dat dit apparaat voldoet aan de essentiële vereisten en andere relevante bepalingen van de verwante richtlijnen. De volledige tekst van de EU-verklaring van conformiteit is beschikbaar op: www.asus.com/support

Eesti Käesolevaga kinnitab ASUSTeK Computer Inc, et see seade vastab asjakohaste direktiivide olulistele nõuetele ja teistele asjassepuutuvatele sätetele. El vastavusdeklaratsiooni täielik tekst on saadaval järgmisel aadressil: www.asus.com/support

Suomi ASUSTeK Computer Inc. ilmoittaa täten, että tämä laite on asiaankuuluvien direktiivien olennaisien vaatimusten ja muiden tätä koskevien säädösten mukainen. EU-yhdenmukaisuusilmoituksen koko teksti on luettavissa osoitteessa: www.asus.com/support

Ελληνικά Με το παρόν, η ASUSTeK Computer Inc. δηλώνει ότι αυτή η συσκευή συμμορφώνεται με τις θεμελιώδεις απαιτήσεις και άλλες σχετικές διατάξεις των Οδηγιών της ΕΕ. Το πλήρες κείμενο της δήλωσης συμμόρφωσης είναι διαθέσιμο στη διεύθυνση: www.asus.com/support

Magyar Az ASUSTeK Computer Inc. ezennel kijelenti, hogy ez az eszköz megfelel a kapcsolódó irányelvek lényeges követelményeinek és egyéb vonatkozó rendelkezéseinek. Az EU megfélelőégi nyilatkozat teljes szövege innen letölthető: www.asus.com/support

Latviski ASUSTeK Computer Inc. ar šo paziņo, ka šis ierīce atbilst saisto Direktīvu būtiskajām prasībām un citiem citiem saistošajiem nosacījumiem. Pilns ES atbilstības paziņojuma teksts pieejams šeit: www.asus.com/support

Lietuvių „ASUSTeK Computer Inc.“ šiuo tvirtina, kad šis įrenginys atitinka pagrindinius reikalavimus ir kitas svarbias susijusių direktyvų nuostatas. Visą ES atitikties deklaracijos tekstą galima rasti: www.asus.com/support

Norsk ASUSTeK Computer Inc. erklærer herved at denne enheten er i samsvar med hovedsaklige krav og andre relevante forskrifter i relaterede direktiver. Fullstendig tekst for EU-samsvarserklæringen finnes på: www.asus.com/support

Polski Firma ASUSTeK Computer Inc. niniejszym oświadcza, że urządzenie to jest zgodne z zasadniczymi wymogami i innymi właściwymi postanowieniami powiązanych dyrektyw. Pełny tekst deklaracji zgodności UE jest dostępny pod adresem: www.asus.com/support

Português A ASUSTeK Computer Inc. declara que este dispositivo está em conformidade com os requisitos essenciais e outras disposições relevantes das Diretivas relacionadas. Texto integral da declaração da UE disponível em: www.asus.com/support

Română ASUSTeK Computer Inc. declară că acest dispozitiv se conformează cerințelor esențiale și altor prevederi relevante ale directivelor conexe. Textul complet al declarației de conformitate a Uniunii Europene se găsește la: www.asus.com/support

Srpski ASUSTeK Computer Inc. ovim izjavljuje da je ovaj uređaj u saglasnosti sa osnovnim zahtevima i drugim relevantnim odredbama povezanih Direktiva. Pun tekst EU deklaracije o usklađenosti je dostupan da adresi: www.asus.com/support

Slovensky Spoločnosť ASUSTeK Computer Inc. týmto vyhlasuje, že toto zariadenie vyhovuje základným požiadavkám a ostatným príslušným ustanoveniam príslušných smerníc. Celý text vyhlásenia o zhode pre štáty EU je dostupný na adrese: www.asus.com/support

Slovenščina ASUSTeK Computer Inc. izjavlja, da je ta naprava skladna z bistvenimi zahtevami in drugimi ustreznimi določbami povezanih direktiv. Celotno besedilo EU-izjave o skladnosti je na voljo na spletnem mestu: www.asus.com/support

Español Por la presente, ASUSTeK Computer Inc. declara que este dispositivo cumple los requisitos básicos y otras disposiciones pertinentes de las directivas relacionadas. El texto completo de la declaración de la UE de conformidad está disponible en: www.asus.com/support

Svenska ASUSTeK Computer Inc. förklarar härmed att denna enhet överensstämmer med de grundläggande kraven och andra relevanta föreskrifter i relaterad direktiv. Fulltext av EU-försäkran om överensstämmelse finns på: www.asus.com/support

Українська ASUSTeK Computer Inc. заявляє, що цей пристрій відповідає основним вимогам та іншим відповідним положенням відповідних Директив. Повний текст декларації відповідності стандартам ЄС доступний на: www.asus.com/support

Türkçe ASUSTeK Computer Inc., bu aygıtın temel gereksinimlerle ve ilişkili Yönergelerin diğer ilgili koşullarla uyumlu olduğunu beyan eder. AB uygunluk bildiriminin tam metni şu adreste bulunabilir: www.asus.com/support

Bosanski ASUSTeK Computer Inc. ovim izjavljuje da je ovaj uređaj uskladen sa bitnim zahtjevima i ostalim odgovarajućim odredbama vezanih direktiva. Cijeli tekst EU izjave o usklađenosti dostupan je na: www.asus.com/support

ASUS contact information

ASUSTeK COMPUTER INC.

Address 4F, No. 150, Li-Te Road, Peitou, Taipei 112, Taiwan
Telephone +886-2-2894-3447
Fax +886-2-2890-7798
Web site <https://www.asus.com>

Technical Support

Telephone +86-21-38429911
Fax +86-21-5866-8722, ext. 9101#
Online support <https://www.asus.com/support/Product/ContactUs/Services/questionform/?lang=en>

ASUS COMPUTER INTERNATIONAL (America)

Address 48720 Kato Rd., Fremont, CA 94538, USA
Telephone +1-510-739-3777
Fax +1-510-608-4555
Web site <https://www.asus.com/us/>

Technical Support

Support fax +1-812-284-0883
Telephone +1-812-282-2787
Online support <https://www.asus.com/support/Product/ContactUs/Services/questionform/?lang=en-us>

ASUS COMPUTER GmbH (Germany and Austria)

Address Harkort Str. 21-23, 40880 Ratingen, Germany
Fax +49-2102-959931
Web site <https://www.asus.com/de>

Technical Support

Telephone +49-2102-5789555
Support Fax +49-2102-959911
Online support <https://www.asus.com/support/Product/ContactUs/Services/questionform/?lang=de-de>

FCC COMPLIANCE INFORMATION

Per FCC Part 2 Section 2.1077(a)



Responsible Party: **Asus Computer International**

Address: **48720 Kato Rd, Fremont, CA 94538**

Phone/Fax No: **(510)739-3777/(510)608-4555**

hereby declares that the product

Product Name : **Motherboard**

Model Number : **WS C246M PRO/FULL,
WS C246M PRO,
WS C246M PRO/SE,
WS C246M PRO/SI**

compliance statement:

This device complies with part 15 of the FCC Rules. Operation is subject to the following two conditions: (1) This device may not cause harmful interference, and (2) this device must accept any interference received, including interference that may cause undesired operation.

Ver. 180125

Free Manuals Download Website

<http://myh66.com>

<http://usermanuals.us>

<http://www.somanuals.com>

<http://www.4manuals.cc>

<http://www.manual-lib.com>

<http://www.404manual.com>

<http://www.luxmanual.com>

<http://aubethermostatmanual.com>

Golf course search by state

<http://golfingnear.com>

Email search by domain

<http://emailbydomain.com>

Auto manuals search

<http://auto.somanuals.com>

TV manuals search

<http://tv.somanuals.com>