



Exxcel 1100 Express

**en Instruction Manual and
Installation Instructions**



Household Appliances

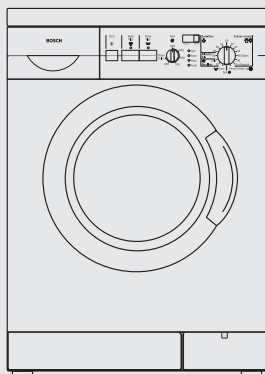

Internet: <http://www.bosch-hausgeraete.de>

BOSCH

Table of Contents

Operating Instructions

Disposal Information	4
Environmental Protection / Conservation Issues .	5
General Safety Instructions	6
Your New Washing Machine	7
Before Using Your Washing Machine For the First Time	9
Preparing, sorting and loading the washing	10
Laundry Detergents and Additives	15
Programmes and functions	17
Washing	23
When the Programme has Ended	25
Special Applications	26
Cleaning and Care	28
Troubleshooting Minor Faults	33
Consumption Rates	37
Customer service	38
Installation, Connection and Transport	39

Installation Instructions

The new washing machine which you have just purchased is a modern, high-quality domestic appliance.

Your washing appliance is distinguished by its economical consumption of power, water and detergent.

Each washing machine which leaves our factory has undergone a thorough performance test and is in fully working order. If you have any queries – especially concerning installation and connection of the washing machine – our customer service will be happy to advise you.

Further information and a selection of our products can be found on our Internet page:
<http://www.bosch-hausgeraete.de>

Please read and observe these operating and installation instructions and all other information enclosed with the washing machine.

Keep all documentation in a safe place for subsequent use or for the next owner of the appliance.

Disposal Information

Disposing of the packaging

The shipping package has protected your new appliance on its way to your home. All packaging materials are environment-friendly and recyclable. Please contribute to a better environment by disposing of packaging materials in an environmentally conscious manner.

Please ask your dealer or local authority about best means of disposal.

⚠ Danger of suffocation!

Keep children away from shipping carton and packaging components. Danger of suffocation from folding cartons and plastic film.

Disposing of your old appliance

Old appliances are not worthless rubbish! Environment-conscious recycling can reclaim valuable raw materials.

⚠ Danger of fatal injury!

On out-of service appliances, unplug mains plug. Cut off power cord and discard with mains plug.

To prevent playing children from becoming trapped and endangered, ensure that the door locking mechanism is disabled.

Environmental Protection / Conservation Issues

Your washing machine uses water, energy and detergent efficiently, thereby protecting the environment and reducing your household costs. See Page 37 for consumption values of your appliance.

Hints and tips

Using your washing machine in an efficient and environmentally friendly manner:

- ❑ Do not exceed recommended load.

Cottons+Linens	6 kg / 13.2 lb
Easy-care	3 kg / 6.6 lb
Delicates/Silk	2 kg / 4.4 lb
Woollens	2 kg / 4.4 lb

With smaller amounts of laundry, the load adjust reduces the water and energy consumption.

- ❑ Where possible, use the “60 °C Stains” programme instead of the “90 °C Cottons+Linens” programme. The extended washing time achieves a cleaning result comparable to that of the 90 °C programme, but uses considerably less energy.
- ❑ Do not use prewash for lightly to normally soiled washing.
- ❑ Add detergent according to the degree of soiling, amount of laundry and water hardness, and observe the detergent manufacturer’s instructions.
- ❑ If washing is then to be dried in the tumble dryer, select spin speed in accordance with the instructions supplied by the dryer manufacturer.

General Safety Instructions

Your washing machine is intended:

- For domestic use only.
- For washing machine-washable fabrics in washing lye.
- For operation with cold drinking water and commercially available detergents and cleaning products which are suitable for use in washing machines.

Do not leave children unsupervised near the washing machine.

Keep pets away from the washing machine.

Do not insert/pull out the mains plug with wet hands.

Do not pull out the mains plug by tugging the cable.

Do not touch the loading door when washing at high temperatures.

Take care when draining hot washing lye.

Do not climb on the washing machine.

Do not lean on the open loading door.

Your New Washing Machine

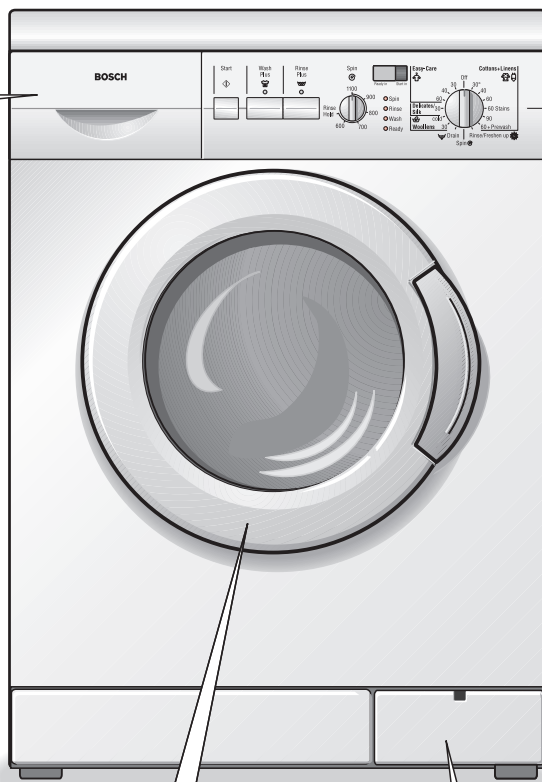
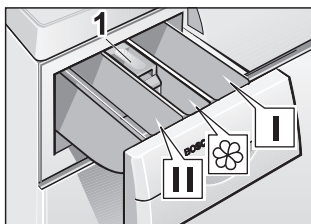

Filling laundry detergent and/or additive dispensers

Dispenser I:

Detergent for prewash or starch.

Dispenser II:

Detergent for main wash, water softener, pre-soaking agent, bleach and stain removal product.

Dispenser ☼:

Additives, e.g. fabric softener or former.

(Fill no higher than lower edge of insert 1).

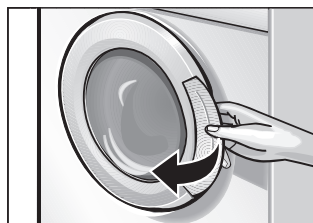

Opening ...



and closing the door

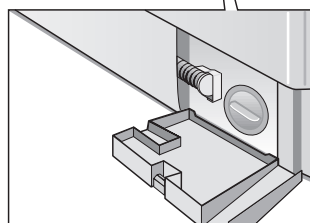

Service flap

Control panel

Buttons for additional options

(in addition to the programme if required)

"Wash Plus": extended intensive washing

"Rinse Plus": extra rinse cycle

Combination of additional options is possible.

The indicator lights of the buttons come on if the additional options are active.

Switch off additional option: press button again.

The "Ready in" time is displayed

if the programme is selected,

The "Start in" time is displayed

if the "Start in" time is additionally selected.

The point between the digit and "h" flashes until the "Start in" time has elapsed. The selected programme then starts automatically and the "Ready in" time is displayed.

"Start in" button (if required)

The "Start in" time can be delayed by hours up to a maximum of "19h".

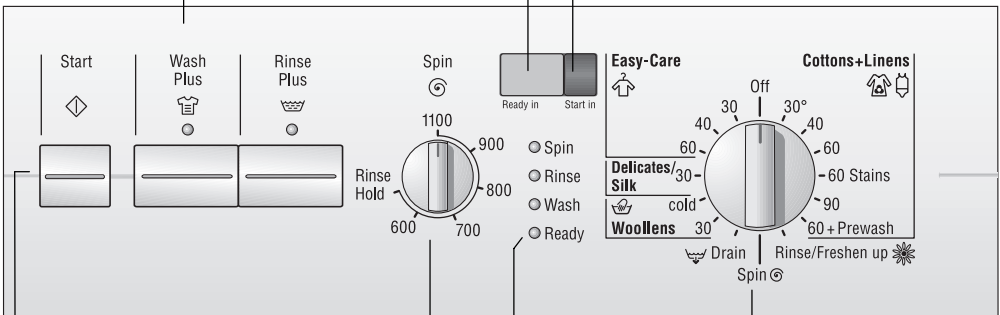

Spin speed selector (if required)

For stepless setting of the spin speed; must click in place at "Rinse Hold".

"Start" button.

For starting the wash cycle (programme must have been selected).

Programme selector

For switching the machine on and off and for selecting the programme.

Can be rotated in either direction.

The programme selector does not rotate while the programme is running – the programme sequence is electronically controlled.

Indicator light

"Wash", "Rinse", and "Spin" light up if the "Start" button is pressed and the respective programme segment runs.

"Ready" is on, if the programme is selected,

Indicator lights flash: Operation error.

Before Using Your Washing Machine For the First Time

Preparing your washing machine

Caution

The washing machine must have been installed and connected properly (refer to Page 39).

Your appliance was tested before leaving the factory. To remove any water left over from testing procedures, the first washing cycle should be carried out without laundry in the machine.

- Do not load any laundry.
 - Turn on water tap.
 - Pull out the detergent dispenser up to the end stop.
 - Pour approx. 1 litre / 1 $\frac{3}{4}$ pt of water into chamber II of the detergent dispenser.
 - Half fill the measuring beaker with detergent and pour into chamber II.
 - i** Do not use any special detergents for delicates or woollens (excessive foam).
 - Close the detergent dispenser.
 - Close the loading door.
 - Set the programme selector to "90 °C Cottons+Linens".
The "Ready" indicator light is on.
The "Ready in" time appears in the display.
 - Press the "Start" button.
The programme starts.
The "Wash" indicator light is on.
 - i** The indicator lights light up during the respective segments of the programme sequence.
- The programme is ended if "0" appears in the display:
- Turn the programme selector to "Off".

Preparing, sorting and loading the washing

Preparing the laundry

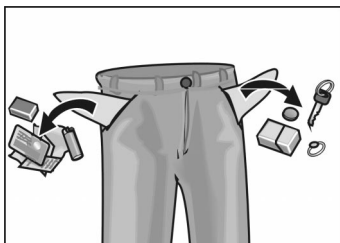

Caution

Loose debris (e.g. coins, paper clips, needles, nails) can damage items of clothing as well as parts of the washing machine (e.g. drum).

- Empty all pockets on items of clothing.
- Brush out any sand from pockets and cuffs.
- Close zip-fasteners and button up bed covers.
- Remove curtain runners or tie them up in a net / bag.
- The following items must be washed inside a net / pillow case:
 - Extremely delicate items, e.g. fine tights, net curtains.
 - Small items, e.g. small socks or handkerchiefs.
 - Underwired bras (the wire may come loose during washing and cause damage).
- When washing trousers, knitwear and woven fabrics, e.g. shirts, T-shirts or sweatshirts, always turn these items inside out.

Sorting the laundry

According to colour and degree of dirt

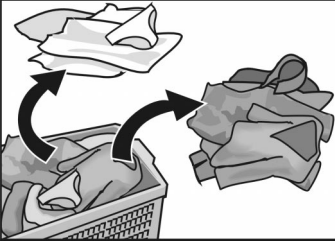

Degrees of dirt

Caution

Items of clothing can become discoloured. Never wash new multi-coloured items together with other items.

White items may become grey. Always wash white and coloured items separately.

Slight dirt

No recognizable dirt or staining. Laundry may have some body odour.

- Light summer clothing and sportswear that has only been worn for a few hours.
- T-shirts, shirts and blouses that have been worn for up to one day.
- Bed linen and guest towels that have been used for one day.

Normal dirt

Visible dirt and/or some light staining recognizable.

- T-shirts, shirts and blouses that are very sweaty or have been worn several times.
- Underwear that has been worn for one day.
- Tea towels, hand towels and bed linen that have been used for up to one week.
- Net curtains (without nicotine staining) that have not been washed for up to ½ year.

Intensive dirt

Dirt and/or staining recognizable.

- Kitchen hand towels that have been used for up to one week.
- Fabric napkins.
- Bibs.
- Children's outer clothing or football shirts and shorts with grass and soil stains.
- Working clothes such as overalls or baker's and butcher's coats.

Typical stains

- Skin fat, cooking oils / fat, sauces, mineral oil, wax (containing fat / oil).
- Tea, coffee, red wine, fruit, vegetables (bleachable).
- Blood, egg, milk, starch (containing protein / carbohydrate).
- Soot, soil, sand (pigments), red sand on tennis clothes.

Removing stains

Wherever possible, remove / pretreat stains whilst they are still fresh.

First, dab soapy water onto the stain. Do not rub.

Subsequently wash the items of clothing using the appropriate programme.

- i** Several washing cycles may sometimes be required in order to remove stubborn / dried in stains.

Sorting laundry according to their care label specifications

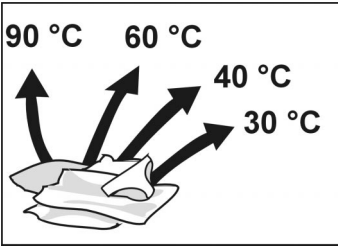

Only wash laundry that is labelled with the following care symbols:



90 °C Cottons+Linens



30, 40, 60 °C Cottons+Linens



30, 40, 60 °C Easy-Care



30 °C Delicate/Silk



Hand and machine-washable woollens cold, 30 °C

Laundry that is labelled with the following care symbol must not be washed in the washing machine:



= do not wash

Loading the laundry

⚠ Risk of explosion!

Items of clothing that have been pretreated with solvent-based cleaning agents, e.g. stain remover and dry cleaning spirit, represent an explosion hazard once loaded into the washing machine. Therefore, these items must first be rinsed thoroughly by hand.

Caution

Loose debris in the washing machine drum can damage the laundry. Before loading the laundry, check that there is no debris in the drum.

- ❑ Open the loading door.



- ❑ Unfold the sorted items of clothing and place them loosely into the drum. Mix large and small items. Laundry items which vary in size are more evenly distributed during the spin cycle.
- ❑ **i** Do not exceed recommended load. Overloading will cause poor wash results and encourage creasing.

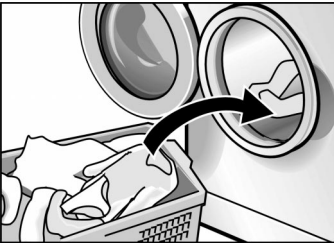

- ❑ Close the loading door. Take care not to trap any items of clothing between the loading door and rubber seal.



Laundry Detergents and Additives

Dispensing the correct amount of detergent

⚠ Risk of poisoning!

Keep detergents and additives out of the reach of children.

Dispense the detergent according to:

- the water hardness. This information can be obtained from your local water authority.
- the amount of laundry.
- the amount of soil.
Information on soiling can be found on Page 11.
- the specifications of the detergent manufacturer.
Dispensing the correct amount of detergent relieves the strain on the environment and ensures optimum washing results.

Pour liquid detergent into the appropriate dispensing chamber.

Too little detergent:

The laundry is not cleaned properly and will, after a while, become grey and stiff.

Greyish brown spots (fat globules) may appear on the laundry.

The heaters may calcify.

Too much detergent:

Environmentally incompatible, excessive foam reduces wash agitation causing poor washing and rinsing results.

Filling laundry detergent and/or additive dispensers

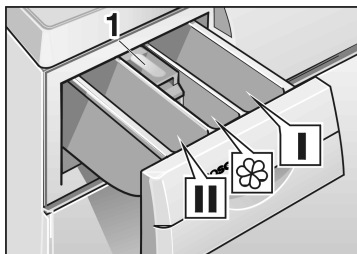

Dispenser I:
Detergent for prewash or starch.

Dispenser II
Detergent for main wash, water softener, pre-soaking agent, bleach and stain removal product.

Dispenser ☼
Additives, e.g. fabric softener or former (fill no higher than lower edge of insert **1**).

- i** Concentrated or thick fabric softener and conditioner must be diluted with a little water before being poured into the dispenser (prevents the overflow from becoming blocked).
- Pull out the detergent dispenser up to the end stop.
- Add the detergent and/or additive.
- Close the detergent dispenser.

Programmes and functions

Select the desired programme – see also the separate programme overview.

For maximum spin speeds of the programmes see Page 19.

Programme selector

Basic programmes

30, 40, 60 °C Cottons+Linens

For hard-wearing textiles, e.g. cotton or linen.

60 °C Stains

For stained, soiled textiles, e.g. cotton or linen.

Energy saving programme. The extended washing time achieves a cleaning result comparable to that of the 90 °C programme, but uses considerably less energy.

90 °C Cottons+Linens

An energy-intensive programme for heat-resistant textiles, e.g. cotton or linen.

To protect the waste-water pipes, the hot water is mixed with approx. 7 litres of cold water and cooled before being drained.

60 °C Cottons+Linens + Prewash

For hard-wearing textiles, e.g. cotton or linen.

i “Cottons+Linens” programmes have optimised run times for lightly soiled textiles. For heavily soiled textiles reduce the load or press the “Wash Plus” button!

30, 40, 60 °C Easy-Care

For easy-care textiles, e.g. cotton, linen, synthetic materials or blended fabrics.

30 °C Delicates / Silk

For delicate, washable textiles, e.g. silk, satin, synthetic materials or blended fabrics (e.g. curtains).

Delicates cycle at 30 °C for machine washable silk. We do not recommend washing these textiles with other rougher textiles.

No spinning between rinse cycles.

cold, 30 °C Woollens

For hand and machine washable wool or wool-rich textiles, e.g. cashmere, mohair or angora.

Also suited for hand washable silk.

Programme options

Rinse/Freshen up

Rinse cycle with subsequent spin cycle for rinsing hand-washed laundry or for starching.

Reduced spin speed.

Also suited to “Freshen up” items, that have been tucked away or stored for a period of time, to remove creases caused by folding and storage and to eliminate odours.

Use fabric conditioner for “fresh” smell

 Do not use detergent (this is not a wash programme).

Spin

Spin cycle for spinning hand-washed items after selection of required speed. Washing solution or rinsing water is drained prior to the spin cycle.

Reduced spin speed.

Drain

Water is drained after a programme with the “Rinse Hold” setting for gentle treatment of delicate laundry.

Spin speed selector

Basic setting

The spin speed selector is pointing up. In the “Cottons+Linens” programme the fabrics will be spun at the maximum possible spin speed.

In the “Easy-Care”, “Delicates/Silk” and “Woollens” programmes the washing machine spins at a low speed – for gentle treatment of delicate laundry.

Maximum spin speeds

Revolutions per minute	Type of laundry / Extra cycle
1100	Cottons+Linens
800	Easy-Care
600	Delicates / Silk
800	Woollens
800	Rinse/Freshen up
800	Spin

Additional option

Rinse hold

For delicate textiles and net curtains.

All programmes can be carried out without the final spin cycle. The laundry is left in the final rinsing water.

“---” appears in the “Ready in” display when programme is ended.

Before the washing can be removed, the “Drain” or “Spin” programme must be run by setting the speed selector to the required speed.

i All of the previous rinse cycles have a short intermediate spin cycle apart from the programme “Delicates/Silk”. This improves the results of the rinse.

Option buttons

Wash Plus

The washing time is extended so that highly soiled washing or 6 kg of cottons/linens are washed more intensively.

Press the button in addition to the programme for the following combinations of load and degree of soiling:

Laundry amount	Program and button „Intensive”	Degree of dirt
6 kg	30, 40, 60 °C Cottons+Linens	light to normal
	60 °C Stains, Cottons+Linens	normal with stains
	90 °C Cottons+Linens	normal
	60 °C+Prewash Cottons+Linens	heavy
up to 5 kg	30, 40, 60 °C Cottons+Linens	normal to heavy
	60 °C Stains, Cottons+Linens	normal to heavy with stains
up to 3 kg	30, 40, 60 °C Easy-Care	normal to heavy
up to 2 kg	30 °C Delicates/Silk cold, 30 °C Woollens	

See the separate programme table for further information.

Rinse Plus

An additional rinse cycle is carried out;
The wash time is extended accordingly.

Recommended application:
in areas with very soft water – for further improvement of the rinsing results.

"Ready in/Start in" displays and "Start in" button.

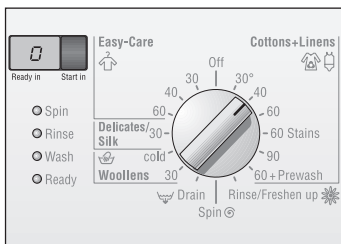
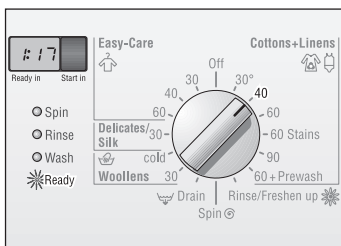

"Ready in" display

- ❑ Turn the programme selector to the desired programme.

The "Ready" indicator light is on.

The expected "Ready in" time (programme duration) is displayed, e.g. "1:17".

- ❗ The "Ready in" time is displayed in hours and minutes, e.g.

1:17 – 1 hour and 17 minutes

0:35 – 35 minutes. After the programme starts, the "Ready in" time is counted down by minutes.

When the programme ends, the display shows "0".

- ❗ At the start of the programme, a projection of the "Ready in" time occurs under the assumption of a full load and a water supply temperature of 15 °C. The actual load will be determined within the first 10 minutes.

The "Ready in" time can become increased or reduced while the programme is running for the following reasons.

Reductions in time occur because of:

- Small loads.

Increases in time occur because of:

- An additional rinse cycle if excessive foam is in the laundry,
- Multiple spinning if the laundry is distributed poorly in the drum,
- Increased heating times, e.g. when the water is too cold,
- Water pressure too low,
- Selection of the additional options, e.g. "Rinse Plus" and/or "Wash Plus" after the programme has started,
- Very absorbent laundry.



Example:



”Start in” display and button

Before starting a programme, you can specify by how many hours the ”Start in” time should be delayed.

- Turn the programme selector to the desired programme.

The ”Ready”indicator light is on.

The expected ”Ready in” time will be displayed.

- Press the ”Start in” button, ”1h” (h=hour) appears in the display.

The point between the digit and the ”h” flashes.

- Press the ”Start in” button until the desired number of hours is displayed.

- i** The ”Start in” time can be set by hours.

The time can be delayed up to a maximum of ”19h”.

If the ”Start in” time is set for ”19h”, you can arrive at the ”Ready in” mode by pressing the ”Start in” button again.

The ”Start in” time begins running immediately after setting. This is indicated by the point between the digit and the ”h” flashing. The point flashes until the ”Start in” time has elapsed.

- i** The ”Start in” time is counted down by the hour.

The programme is automatically started after the ”Start in” time has elapsed.

The indicator light of the respective programme segment comes on. The ”Ready in” time appears in the display.

- i** Changes to the ”Start in” time are possible at any time, press the ”Start in” button until the new number of hours appears, in order to do this. The new ”Start in” time elapses without having to restart the programme.

- i** If the programme sequence is changed, or if the programme is interrupted, the preselected ”Start in” time is also interrupted. The ”Ready in” time of the newly selected programme appears in the display. The ”Start in” time must be reselected.

- i** Topping up laundry is possible at any time during the ”Start in” time. Close the loading door.

Washing



- ❑ Turn on water tap.

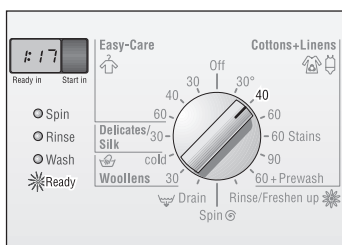

- ❑ Turn the programme selector to the desired programme – see also the separate programme overview
The "Ready" indicator light is on.
The "Ready in" time is displayed.

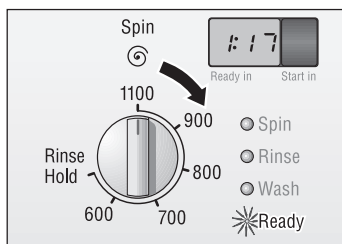

- ❑ If required, select the desired spin speed or "Rinse Hold".

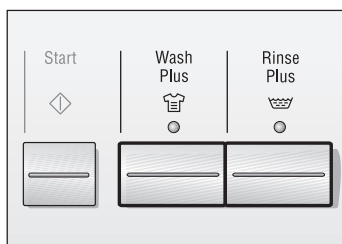

- ❑ If required, press the button(s) for additional option(s).

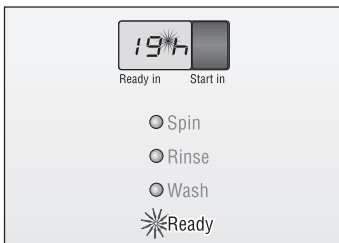

- If required, select the "Start in" time. The "Start in" time begins running immediately. The programme starts automatically after the "Start in" time has elapsed.

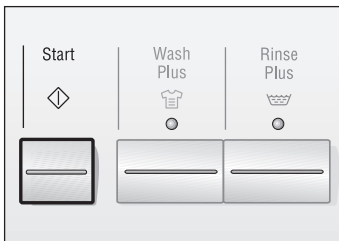

- Press the "Start" button. The programme starts.

Changing a programme

If you have accidentally selected the wrong programme:

- Turn the programme selector to "Off".
- Turn the programme selector to the desired programme. The "Ready" indicator light is on.
- If required, select a new "Start in" time with the "Start in" button.
- If required, press the "Start" button.

Cancelling active programme

If you wish to prematurely end a programme:

- Turn the programme selector to "Off".
- Turn the programme selector to "Drain" or "Spin". The "Ready" indicator light is on.

For "Spin", select the desired spin speed (but not "Rinse Hold").

- Press the "Start" button.

When the Programme has Ended

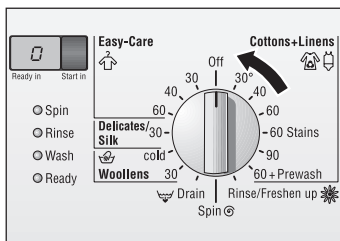

"0" or "---" appears in the display.

- Turn the programme selector to "Off".
and if required
- Select an additional programme ("Drain", "Spin" or "Rinse/Freshen up").
- Press the "Start" button.
- At the end of the additional programme turn the programme selector to "Off".

Unloading the laundry



- Turn off the water tap.
- Open the loading door.

If the loading door cannot be opened:
Wait 2 minutes (the safety function is active)
or

there is still water in the washing machine if the "Rinse Hold" option was selected. Select the "Drain" or "Spin" programme and press the "Start" button.

- Unload the laundry.

Caution

Remove any foreign objects (e.g. coins, paper clips) from the drum and rubber seal – **risk of rust!**

- Leave the loading door open to allow the inside of the washing machine to dry out.

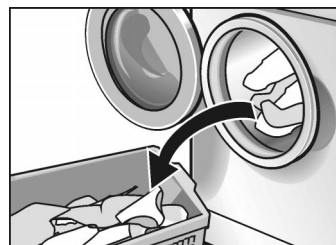

Special Applications

Pre-soak

- Load laundry of the same colour.
- Add the presoak agent to chamber **II** according to the manufacturer's specifications.
- Turn the programme selector to "30 °C Cottons+Linens".
The "Ready" indicator light is on
- Press the "Start" button.
The "Wash" indicator light is on, programme is running
- After approx. 15 minutes, turn the programme selector to "Off". The laundry is left to lie in the water.
- Select a programme after the desired soaking period.
- i** No additional detergent required, the soaking solution is used for washing.

Starching

The laundry must not be treated with fabric softener.

- Load the laundry.
- Dispense the correct amount of starch for approx. 15 litres / 3.3 gal. of water. Powdered starch must first be dissolved in water according to the manufacturer's specifications.
- Turn the programme selector to "Rinse/Freshen up".
- Set the spin speed ("Rinse Hold" is also possible).
- Press the "Start" button.

As soon as water starts to enter the machine:

- Pull out the detergent dispenser slightly.
- Add the starching solution to chamber **I**.
- Close the detergent dispenser.

If "Rinse Hold" is selected, the "Drain" programme must be subsequently selected.

Only use dyes that are environmentally compatible and suitable for use in washing machines.

Caution

Discoloration of the laundry in subsequent wash cycles cannot be completely ruled out.

- Always use dyes in accordance with the manufacturer's instructions.

After dyeing:

- Pour ½ measuring beaker of detergent into dispenser **II**.
- Without any laundry in the drum, allow the "90 °C Cottons+Linens" programme to run through.
- Wipe out the rubber seal.

Caution

Decolorants may contain sulphur or chlorine. These substances can cause parts of the washing machine to corrode. Do not decolorize items of laundry in the washing machine.

Dyeing

Decolorizing

Cleaning and Care

⚠ Risk of electric shock!

Always disconnect the appliance from the mains before cleaning.

Never clean the washing machine with a jet of water.

⚠ Risk of explosion!

Never use solvents to clean the appliance.

As required:

- Use hot soapy water or a mild, non-abrasive cleaning agent.
- Rub dry with a soft towel.

In the event that rust spots have formed due to left-over debris (e.g. coins, paper clips, needles, nails):

- Use a chlorine-free cleaning agent. Follow the manufacturer's instructions. Never use steel wool.

Cleaning the appliance housing and control panel

Cleaning the drum

Cleaning the detergent dispenser



In the event that residual detergents or additives have accumulated:

- Pull out the detergent dispenser up to the end stop,
- Press down the insert and
- Remove the detergent dispenser.

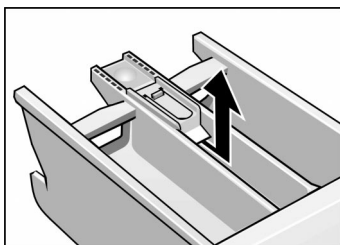

- Pull out the insert.
- Clean the detergent dispenser and insert under running water and dry.

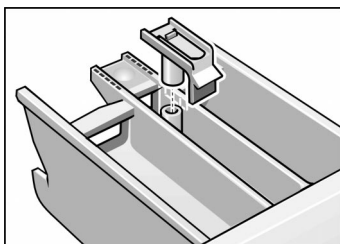

- Attach the insert and lock into position.
- Insert the detergent dispenser.

Cleaning the drain pump

Draining the washing solution

This is necessary if the washing solution has not been completely drained. The pump is blocked by either loose debris or fluff which accumulates if fluff-giving fabrics are washed.

(Up to 20 litres / 4.4 gal. Have a suitable container ready.)

⚠ Risk of scalding!

Allow the hot washing solution to cool.
Keep children and pets away.

- Turn the programme selector to "Off".
- Open service flap.

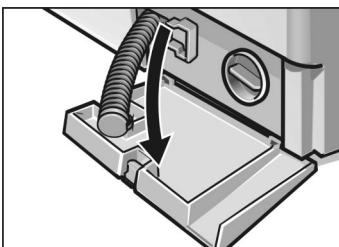
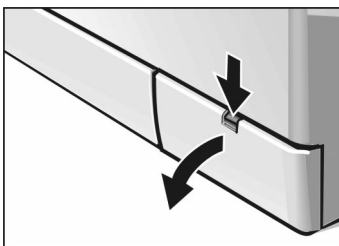

- Remove the drain hose from its holder and pull the hose out of the housing.
- Remove service flap.

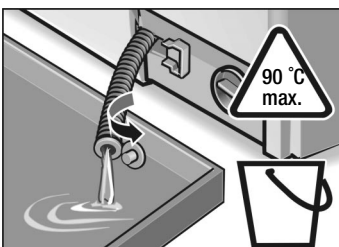

- Pull down the closing cap and allow the washing lye to flow into a suitable container.

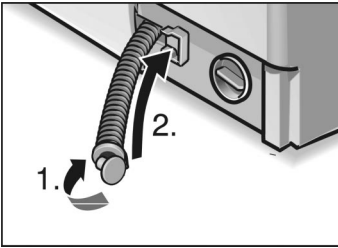

- ❑ Push up the closing cap (**1st**) and place the drain hose back in its holder (**2nd**).

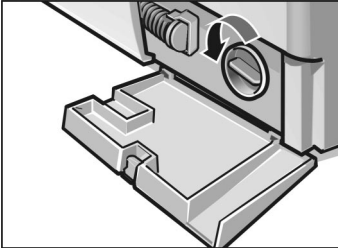

- ❑ Carefully remove the pump cap.
A little residual water will flow out.
- ❑ Remove any loose debris / fluff from inside the pump and clean the pump. The pump impeller must be able to rotate.
Clean any residual lye or fluff from the thread of the pump cap and pump housing.

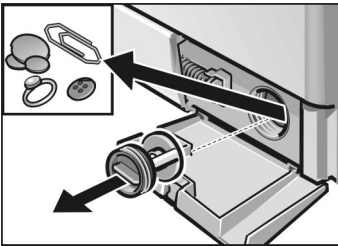

- ❑ Attach and tighten the pump cap.
 - ❑ Insert and close service flap.
- To avoid unused detergent from flowing into the drain during the next wash cycle:

- ❑ 1Pour 1 litre / 1 ¾ pt of water into chamber II.
- ❑ Select the programme "Drain".

Cleaning water inlet strainers

This is necessary if very little or no water flows into the washing machine. The "Rinse" indicator light flashes

First release the water pressure in the supply hose:

- ❑ Turn off the water tap.
- ❑ Turn the programme selector to any programme (except "Spin" and "Drain").
- ❑ Press the "Start" button, and allow the programme to run for approx. 40 seconds.
- ❑ Turn the programme selector to "Off".

Cleaning the strainer at the water tap

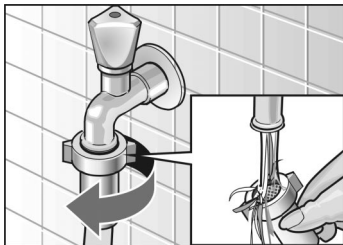

- Disconnect the hose from the water tap.
- Rinse the strainer under flowing water.
- Connect the hose.

Cleaning the strainer on the washing machine

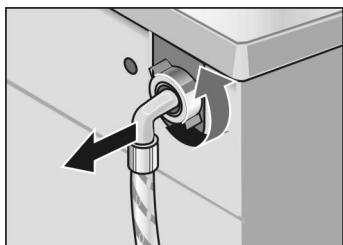

- Disconnect the hose from the back of the washing machine.

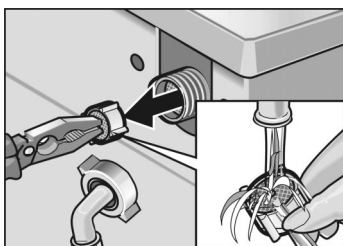

- Pull out the strainer and rinse under running water.
- Insert the strainer and reconnect the hose.
- Turn on the water tap and check whether water is still discharged. If water is still discharged, check that the strainer is attached properly.
- Turn off the water tap.

Descaling the washing machine

Caution

Descaling agents contain acids which can attack parts of the washing machine and discolour the laundry.

Provided that you use the correct amount of detergent, it is not necessary to descale the washing machine.

If, however, descaling the appliance becomes necessary, please follow the instructions provided by the descaling agent manufacturer.

Troubleshooting Minor Faults

⚠ Risk of electric shock!

Repairs must only be carried out by our Customer Service or an authorized technician.

If repairs are needed, and assuming that you cannot eliminate the fault yourself with the aid the following table:

- Turn the programme selector to "Off".
- Disconnect the washing machine from the mains.
- Turn off the water tap.
- Call Customer Service (refer to Page 38).

Fault	Cause	Action
The loading door cannot be opened.	"Rinse Hold" was selected.	Select "Drain" or "Spin".
	Safety function is active.	Wait for 2 minutes.
Detergent residue in the detergent dispenser.	Detergent was damp or lumpy.	Clean and dry the detergent dispenser; see Page 29.
		Use the dispensing aid for liquid detergents.
Control lights do not come on.	A fuse has triggered.	Switch on / replace the fuse.
	Power failure.	Call Customer Service if this fault is repeated.
		An interrupted programme will be resumed when the power returns. If the washing is to be removed, proceed as described under "Cleaning the drain pump"; see from Page 30.
Plug is loose or not inserted.		

Fault	Cause	Action
Programme does not start. The "Wash" indicator light flashes	Loading door not closed properly.	Check whether laundry is trapped in door. Close the loading door (a click should be heard).
Programme does not start.	"Start" button not pressed.	Press the "Start" button.
Water does enter the machine or detergent is not washed away. The "Rinse" indicator light flashes	Water tap not turned on. Supply hose kinked or trapped. Strainers in supply hose clogged.	Turn on water tap. Clean the strainers; see from Page 31.
Detergent in chamber I is not washed away.	A programme without Prewash was selected.	Select "60 °C Cottons+Linens + Prewash".
Water cannot be seen in drum.	This is not a fault. The water lies below the visible part of the drum.	
Washing solution is not completely drained. The "Spin" indicator light flashes.	Loose debris is blocking the pump. Fluff-producing laundry was washed. The water drainage pipe or drain hose is blocked.	Clean the pump (refer to page 30). Clean the water drainage pipe and/or drain hose.
Water is flowing out from underneath the machine.	The thread of the supply hose is not tight. Leak in the drain hose.	Tighten the thread. Replace the drain hose.
Foam coming out of the detergent dispenser.	To much detergent.	Mix 1 tablespoon of fabric softener with ½ litre / 1 pt of water and pour into chamber II of the detergent dispenser. Reduce the amount of detergent next time.
The laundry was not spun.	Large items of clothing became entangled and could not be distributed evenly in the drum. For safety reasons, the high-speed final spin cycle was automatically cancelled.	Always load large and small items together into the drum (see also imbalance compensation system).

Fault	Cause	Action
Spin result unsatisfactory.	The "Rinse/Freshen up" or "Spin" programme selected –maximum spin speed: see Page 19.	
Repeated spinning.	This is not a fault. The imbalance compensation system is attempting to balance the load through repeated spins.	
The programme takes longer than usual.	This is not a fault. Imbalance compensation system attempts to balance the laundry by repeated distribution.	Wash large and small items together in order to reduce the imbalance.
	The foam detection feature has activated an additional rinsing cycle to reduce the amount of foam.	Add a more appropriate amount of detergent next time.
Unsatisfactory washing result.	The degree of dirt was higher than supposed or recommended load has been exceeded.	Select suitable programme and press the "Wash Plus" button or reduce load.
	Not enough detergent.	Add detergent according to the manufacturer's specifications.
Detergent residue on the laundry.	Some phosphate-free detergents contain water-insoluble residues that may appear as light spots on the laundry.	Select "Rinse/Freshen up" immediately or brush out the washing after drying.
Grey residues on the laundry.	Dirt accumulation from ointments, fats or oils.	Add the maximum amount of detergent and select the highest permissible temperature next time.
Changes in the "Ready in" time while the programme is running.	This is not a fault. For this, see also the explanations under: ""Ready in/Start in" displays and ""Start in" button", Page 21.	
Reduction in "Ready in" time.	This is not a fault. For small amounts of laundry, a reduction in time of approx. 20 minutes can result, depending on washing programme.	

Fault	Cause	Action
Increase in "Ready in" time.	In the case of excessive foam, the foam detection system has activated an additional rinse cycle and an additional spin cycle to ensure the rinsing result.	Reduce the amount of detergent next time.
	For severe imbalances during spinning, an increase in time of approx. 10 minutes can occur because of repeated distribution of the laundry.	Wash large and small items together in order to reduce the imbalance.
	If very cold water must be heated up, an increase in time of approx. 20 minutes can result.	

Consumption Rates

Normal programme	Option buttons	Load	Consumption rates **		
			Electricity	Water	Duration
40 °C Cottons+Linens *	Wash Plus	6 kg / 13.2 lb	0.65 kWh	60 l	2:10 h
60 °C Cottons+Linens	–	5 kg / 11 lb	0.95 kWh	60 l	1:17 h
60 °C Stains, Cottons+Linens *	Wash Plus	6 kg / 13.2 lb	1.02 kWh	49 l	2:15 h
90 °C Cottons+Linens (the hot washing solution is mixed with approx. 7 litres of cold water before being drained)	Wash Plus	6 kg / 13.2 lb	2.1 kWh	67 l	2:10 h
40 °C Easy-Care *	Wash Plus	3 kg / 6.6 lb	0.5 kWh	50 l	1:18 h
30 °C Delicates / Silk	–	2 kg / 4.4 lb	0.3 kWh	42 l	0:35 h
30 °C Woollens *	Wash Plus	2 kg / 4.4 lb	0.2 kWh	35 l	0:50 h

* Programme setting with “Wash Plus” option for test in accordance or in conformity with EN 60 456 and IEC 60 456

** The consumption rates may deviate from the stated values depending on water pressure and hardness, room temperature, type and amount of laundry, detergents used, fluctuations in the mains voltage and selected additional functions.

Customer service

Before calling the Customer Service, please make sure that you cannot eliminate the fault yourself (refer to Page 33).

This is because consultation provided by our technicians, even within the warranty period, will lead to costs being incurred by yourself.

Your nearest Customer Service centre can be found in the index supplied. When calling the Customer Service, please specify the product number (E-Nr.) and production number (FD-Nr.) of your appliance.

These numbers are shown on the rating plate which can be found on the frame of the open door and also on the identification plate, enclosed by a thick line, on the front of the machine behind the nameplate.

Rating plate

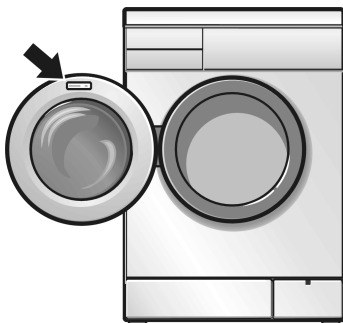

E-Nr. _____	FD _____
-------------	----------

Product number

Production number

Please note the two numbers in the space provided above.

In specifying the product number and production number of your appliance, you help us in our attempt to prevent unnecessary travelling and the associated extra costs.

Installation, Connection and Transport

Safety instructions

⚠ Risk of injury!

The washing machine is very heavy. Take care when lifting it.

Caution

Frozen hoses can tear / burst. Do not install the washing machine outdoors or in an area prone to frost.

Take care not to damage the washing machine. Do not hold onto protruding parts (e.g. loading door) when lifting.

In addition to the safety information listed here, the local water and electricity supplier may have special requirements.

If in any doubt, have the water connection carried out by an authorized technician.

Supplied accessories

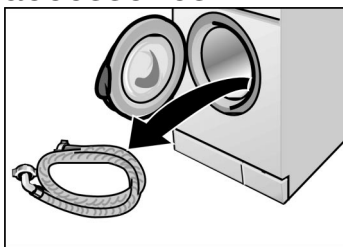

Inside the drum:

- Water-inlet hose.

Any dampness inside the drum is left over from final testing which every washing machine is subjected to before leaving the factory.

On the rear of the appliance:

- Water drainage hose.
- Elbow for attaching the drain hose, e.g. into a wash basin.
- Power cord with mains plug.

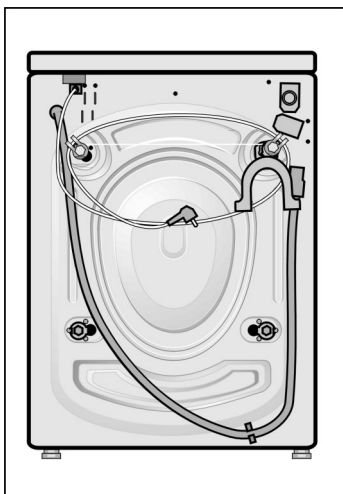

Depending on the connection situation:

- 1 hose clip Ø 24–40 mm (DIY store) is also required for connection to a siphon.

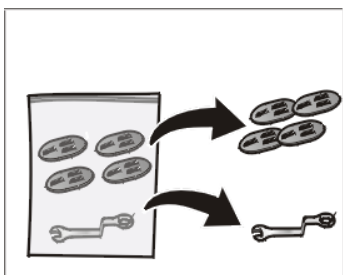

Useful tools

In the bag:

- Spanner,
- Covers for holes left by removing the transport bolts.

The following tools are helpful:

- Ring wrench (SW 13) for removing the transport bolts.
- Spirit level for aligning the appliance.

Dimensions

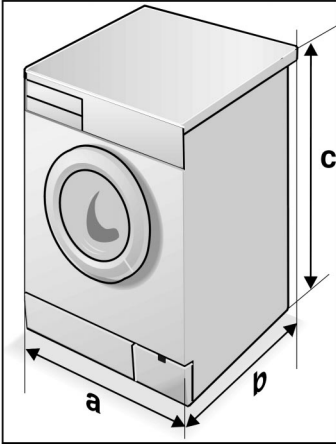

a = 600 mm

b = 590 mm

c = 852 mm

Weight approx. 69 kg

Installation area

Appliance stability is important so that the washing machine does not “wander” during the spin cycles.

The installation area must be solid and even. Soft floor surfaces, such as carpets or surfaces with foam backing, are not suitable.

If the washing machine is to be installed on a wood joist ceiling:

- If possible, place the washing machine in a corner of the room.
- Screw a water-resistant wooden board (at least 30 mm thick) to the floor.
- Affix the feet of the washing machine using holding brackets*.

If the washing machine is to be placed on a pedestal:

- Affix the feet of the washing machine using holding brackets*.

* Holding brackets (set) can be obtained from a specialist store or the Customer Service (order no. WMZ 2200).

Built-under or built-in appliance installation

The appliance must be built under or built in prior to connecting the power supply.

The appliance can be built into or under a kitchen work surface. For this purpose, a recess width of 60 cm is required.

- The washing machine must only be installed under a one-piece worktop that is permanently attached to the surrounding cabinets.

Caution

For safety reasons in built-under installation, a metal cover* must be assembled by a specialist in place of the appliance cover plate.

* The metal cover (set) can be obtained from a specialist store or the Customer Service (order no. WMZ 2390).

Removing the transport bolts

Caution

The transport bolts must always be removed before using the appliance for the first time and must be retained for any subsequent transport (e.g. when moving).

Before removing the transport bolts:

- Take the hose out of the holder.
- Detach the elbow.
- Release all four transport bolts using the SW 13 wrench until they can be moved freely.
- Completely remove transport bolts by reaching through the open washing machine door and pulling the drum forwards slightly.

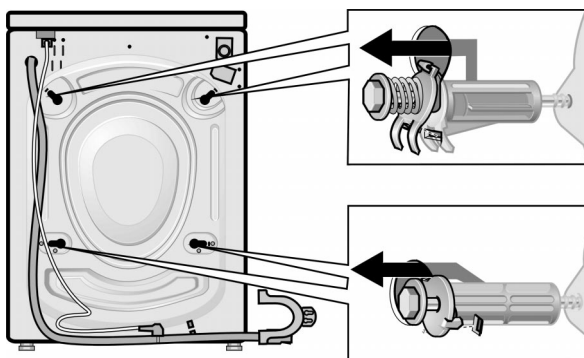

- Insert the covers.

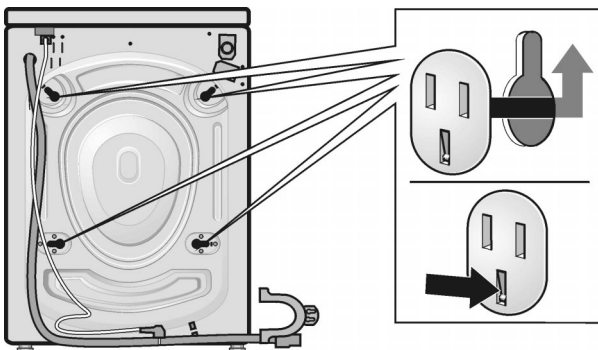

Storing the transport bolts

Always keep the transport bolts for subsequent transportation of the appliance (e.g. when moving house).

- Store the transport bolts with washer and bush (and spring) attached.

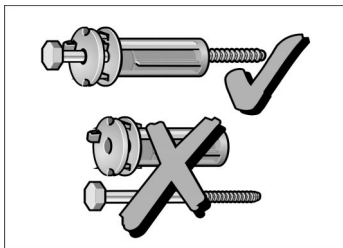

Hose and cable lengths

Left-hand connection

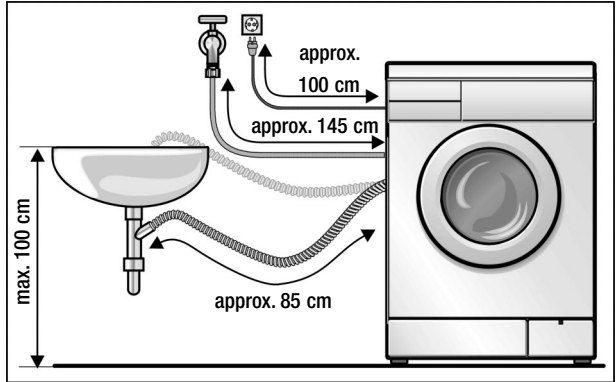

Right-hand connection

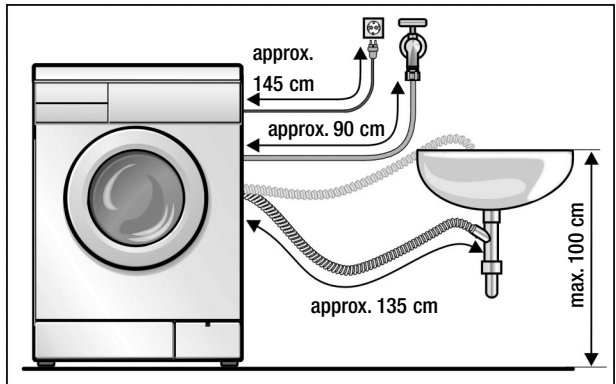

Other hoses

Available from specialist dealers:

- Connecting kit with plastic hose (approx. 2.50 m), order no. WMZ 2380,
- Extended supply hose (approx. 2.20 m).

Water connection

Water supply

To prevent leaks or water damage, it is essential to follow the instructions in this chapter!

Caution

Operate the washing machine with cold drinking water only. Do not connect the appliance to the mixer tap of an unpressurized hot-water boiler.

If in any doubt, have the water connection carried out by an authorized technician.

The water supply hose must not be:

- Bent or squashed.
- Modified or cut through (stability can no longer be guaranteed).

Plastic threads must only be tightened by hand. Do not remove the strainers from the water supply hose.

Observe the water pressure in the supply network:

- The water pressure should be between 1 and 10 bars (when the tap is turned on, at least 8 litres of water is discharged per minute).
- A pressure reducing valve must be installed if the maximum water pressure is exceeded.

Connect the water supply hose.

- to the rear panel of the washing machine and ...

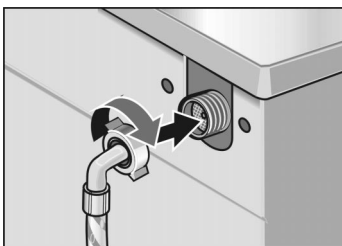

- to the tap.

- Subsequent to connection:
Turn on the water tap completely, and check connection points for water-tightness.

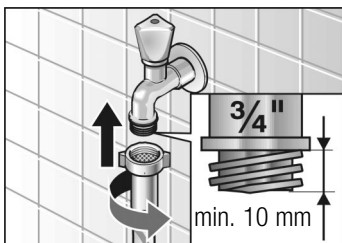

Water drainage

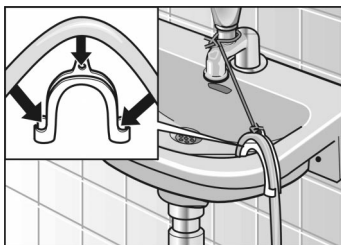
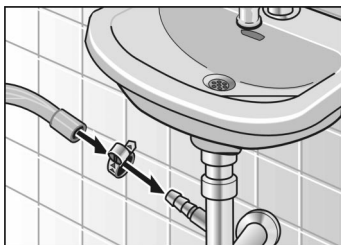

Caution

Do not bend or pull the water drainage hose.

Height difference between the placement area and drainage point: maximum 100 cm.

Drainage into a siphon:

- ❑ Secure the connection point with a hose band clip of 24–40 mm diameter (from specialist stores).

Drainage into a wash basin:

Caution

The plug must not block the drain of the wash basin.

- ❑ Secure the water drainage hose so that it does not slide out.
- ❑ When water is being drained, check that the water flow is fast enough.

Levelling procedure

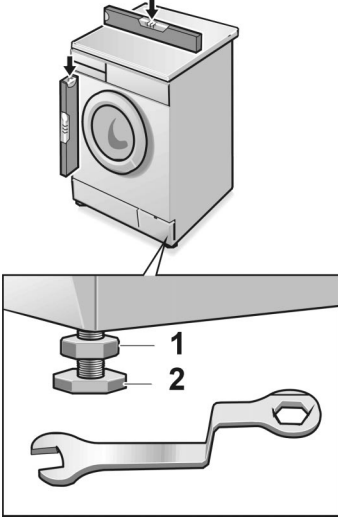

Align the washing machine with the aid of the four height-adjustable feet and a spirit level.

- Loosen lock nut **1** in a clockwise direction with a spanner.
- Adjust the height by rotating height-adjustable foot **2**.
- Tighten lock nut **1** against the housing; grip the foot and do not adjust the height.

All four appliance feet must be situated firmly on the ground. The washing machine must not wobble. The lock nuts on all four appliance feet must be tightened against the housing.

Attention

Loud noises, vibrations and “wandering” may be due to incorrect alignment!

Electrical connection

Caution

The washing machine must only be connected to alternating current and using a properly installed socket outlet with earthing contact.

The mains voltage must correspond to the voltage specification on the washing machine (nameplate). Connection specifications as well as the required fuses are stipulated on the appliance nameplate.

Make sure that:

- the mains plug fits the socket outlet.
- the cable cross-section is permissible.
- the earthing system is properly installed.

The mains cable may be replaced by an electrician only.

Replacement mains cable available from customer service.

Do not use multiple plugs / connectors or extension cables.

In the event that an earth-leakage circuit breaker is to be used, only use types marked with the following symbol: .

Only this symbol can guarantee compliance with all current regulations.

Do not insert/pull out the mains plug with wet hands.

Do not pull out the mains plug by tugging the cable.

Transport, e.g. when moving

Before transporting the washing machine:

- Turn off the water tap.
- Drain any residual washing solution (refer to Page 30).
- Release the water pressure in the supply hose (refer to Page 31).
- Disconnect the washing machine from the mains.
- Dismantle the supply and drainage hoses.
- Reinstall the transport bolts.

Having transported the appliance and ensured proper installation and connection, allow the “Drain” programme to run through before starting the first wash programme.

Preparing and inserting the transport bolts

- Remove the covers.
- Preparing the transport bolts:
Pull the bolt out of the sleeve until the end of the bolt is flush with the end of the sleeve.
- Insert and tighten the transport bolts.
The lug on the washer must be located in the groove in the rear panel of the housing.

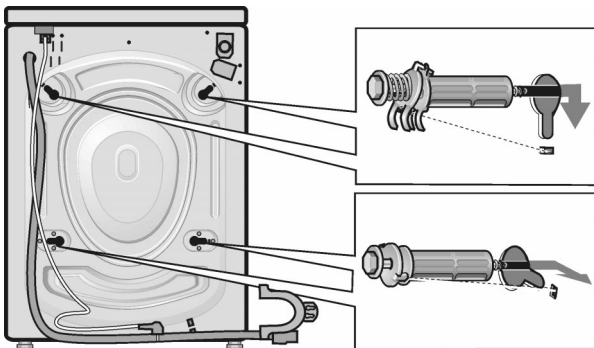

Free Manuals Download Website

<http://myh66.com>

<http://usermanuals.us>

<http://www.somanuals.com>

<http://www.4manuals.cc>

<http://www.manual-lib.com>

<http://www.404manual.com>

<http://www.luxmanual.com>

<http://aubethermostatmanual.com>

Golf course search by state

<http://golfingnear.com>

Email search by domain

<http://emailbydomain.com>

Auto manuals search

<http://auto.somanuals.com>

TV manuals search

<http://tv.somanuals.com>