

VideoJet 8008 / VideoJet 8004

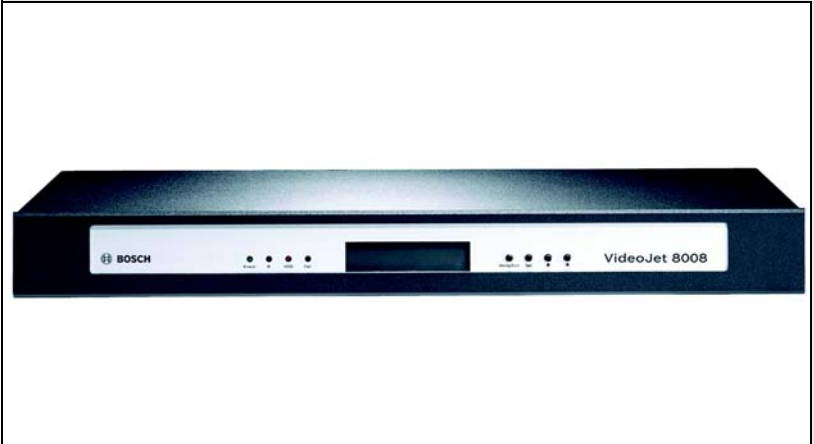

Security Systems

EN | Installation and Operating Manual
Network Video Server

BOSCH

Copyright

This manual is copyright protected by Bosch Security Systems. All rights reserved. No part of this document may be reproduced or transmitted for any purpose, by whatever method and by whatever means, electronically or mechanically, without the express written permission of Bosch Security Systems.

Issue: July 2006 (Software version 1.5)

© Copyright 2006 Bosch Security Systems

Note

This manual has been prepared with all due care and all information contained in it has been thoroughly checked. The description was complete and correct at the time of going to press. Our products are constantly developed and upgraded; as such, the content of the manual is subject to change without notice.

Bosch Security Systems accepts no liability for losses that arise directly or indirectly as a result of errors, incompleteness or discrepancies between the manual and the product described.

Trade marks

All of the hardware and software names used in this manual are highly likely to be registered trade marks and must be treated as such.

Content

Chapter 1 Preface

Conventions	5
Intended use	6
EU Directives	6
Rating plate	6

Chapter 2 Safety information

Electric shock hazard	7
Installation and operation	8
Maintenance and repair	8

Chapter 3 Product description

Components supplied	9
System requirements for setup	9
Configuration requirements	10
Operational requirements	10
Overview of functions	11
Connections on the rear panel	14
Front panel	15

Chapter 4 Installation

Installing in a switch cabinet	18
Connections	20
Power on/Power off	24
Setup using a terminal program	25

Chapter 5 Configuration using a Web browser

Connecting	29
Choosing the configuration mode	31
Unit overview	33
Configuration menu	63
Function test	117

Chapter 6 Operation

Operation with Microsoft Internet Explorer	119
The LIVEPAGE	121
Saving snapshots	124

Recording video sequences	124
Running recording program	125
The MEDIA-REPLAY page	126
Backup	130
Installing MPEG viewer	131
Hardware connections between video servers	132
Operation with decoder software	134
Operating options on the front panel	135

Chapter 7 Maintenance and upgrades

Testing the network connection	139
Restart (Reset)	139
Repairs	140
Transfer and disposal	140

Chapter 8 Appendix

Troubleshooting	141
LEDs	143
RS232/485 interface	144
RS232 interface (audio versions only)	145
Terminal block	146
Second terminal block (audio versions only)	147
Glossary	148
Technical data: VideoJet 8008	150
Technical data: VideoJet 8008 with audio	152
Technical data: VideoJet 8004	154
Technical data: VideoJet 8004 with audio	156

Chapter 9 Index

1

Preface

This manual is intended for persons responsible for the installation and operation of the VideoJet 8008 or VideoJet 8004. International, national and any regional electrical engineering regulations must be followed at all times. Relevant knowledge of network technology is required. The manual describes the installation and operation of the unit.

Conventions

In this manual, the following symbols and notations are used to draw attention to special situations:



Caution

This symbol indicates that failure to follow the safety instructions described may endanger persons and cause damage to the unit or other equipment. It is associated with immediate, direct hazards.



Note

This symbol refers to features and indicates tips and information for easier, more convenient use of the unit.

Intended use

The VideoJet 8008 and VideoJet 8004 network video servers transmit video and control signals over data networks (Ethernet LAN, Internet). The integrated hard drive allows you to use the device as a DVR. Audio signals can also be transmitted with the audio versions of the units. The units are designed for use in CCTV systems. Various functions can be triggered automatically by incorporating external alarm sensors. Other applications are not permitted.

In the event of questions concerning the use of the units which are not answered in this manual, please contact your sales partner or:

Bosch Sicherheitssysteme GmbH
Robert-Koch-Straße 100
85521 Ottobrunn
Germany

www.bosch-sicherheitssysteme.de

EU Directives

The VideoJet 8008 and VideoJet 8004 network video servers comply with the requirements of EU Directives 89/336 (Electromagnetic Compatibility) and 73/23, amended by 93/68 (Low Voltage Directive).

Rating plate

For exact identification, the model name and serial number are inscribed on the bottom of the housing. Please make a note of this information before installation if necessary so as to have it to hand in case of questions or when ordering spare parts.

2

Safety information

Electric shock hazard

- Never attempt to connect the unit to any power network other than the type for which it is intended.
- Never open the housing.
- If a fault occurs, disconnect the unit from the power supply and from all other units.
- Install the unit only in dry, weather-protected locations.
- If safe operation of the unit cannot be ensured, remove it from service and secure it to prevent unauthorized operation. Safe operation is no longer possible in the following cases:
 - if there is visible damage to the unit or power cables,
 - if the unit no longer operates correctly,
 - if the unit has been exposed to rain or moisture,
 - if foreign bodies have penetrated the unit,
 - after long storage under adverse conditions, or
 - after exposure to extreme stress in transit.

In such cases, have the unit checked by Bosch Security Systems.

Installation and operation

- The relevant electrical engineering regulations and guidelines must be complied with at all times during installation.
- Relevant knowledge of network technology is required to install the unit.
- Before installing or operating the unit, make sure you have read and understood the documentation for the other equipment connected to it, such as cameras. The documentation contains important safety instructions and information about permitted uses.
- Perform only the installation and operation steps described in this manual. Any other actions may lead to personal injury, damage to property or damage to the equipment.

Maintenance and repair

- Never open the housing of a VideoJet 8008 or VideoJet 8004. The units do not contain any user-serviceable parts.
- Ensure that all maintenance or repair work is carried out only by qualified personnel (electrical engineers or network technology specialists).

3

Product description

Components supplied

- VideoJet 8008 or VideoJet 8004 network video server (basic version or audio version)
- Power supply cable
- Configuration cable
- Mounting kit for installation in 19-inch racks
- Quick Installation Guide
- Product CD with the following content:
 - Quick Installation Guide
 - Manual
 - System Requirements document
 - MPEG ActiveX control
 - MPEG viewer
 - DirectX control
 - Microsoft Internet Explorer
 - Microsoft Virtual Machine
 - Adobe Acrobat Reader

System requirements for setup

- Computer with Windows 2000/XP operating system, access to a network and Microsoft Internet Explorer (version 6.0 or higher)

or

- Computer with Windows 2000/XP operating system, free serial interface and terminal program

Configuration requirements

- Computer with Windows 2000/XP operating system, access to a network and Microsoft Internet Explorer (version 6.0 or higher)

or

- Computer with Windows 2000/XP operating system, access to a network and receiver software, such as VIDOS

Note

Also note the information in the **System Requirements** document on the product CD supplied.

Make sure the graphics card is set to 16- or 32-bit color depth and that Microsoft Virtual Machine is installed and activated on your PC.

If necessary, you can install the required software and controls from the product CD supplied (see **Components supplied**, page 9).

Operational requirements

- Computer with Windows 2000/XP operating system, access to a network and Microsoft Internet Explorer (version 6.0 or higher)

or

- Computer with Windows 2000/XP operating system, access to a network and receiver software, such as VIDOS

or

- MPEG-4 compatible hardware decoder from Bosch Security Systems (for example VIP XD) as a receiver and connected video monitor

Note

Also note the information in the **System Requirements** document on the product CD supplied.

Make sure the graphics card for reception on the computer monitor is set to 16- or 32-bit color depth and that Microsoft Virtual Machine is installed and activated on your PC. If necessary, you can install the required software and controls from the product CD supplied (see **Components supplied**, page 9).

Overview of functions

Network video server

VideoJet 8008 and VideoJet 8004 are network video servers for eight independent video channels. They are primarily designed for encoding video and control data for transmission over an IP network. With the audio versions, audio signals can also be transmitted to and from compatible units. The use of existing networks means that integration with CCTV systems or local networks can be achieved quickly and easily.

The VideoJet 8008 offers full D1/4CIF resolution at a complete image rate of 25 images per second for 8 channels. The VideoJet 8004 is the more economic variant with half the image rate per channel.

VideoJet 8008 and VideoJet 8004 are designed as desktop units and intended for installation in the switch cabinet. Mounting in a 19-inch rack using the mounting kit supplied is a quick and easy operation.

Receiver

Compatible MPEG-4 enabled hardware decoders (for example the VIP XD) can be used as receivers. Computers with decoding software such as VIDOS or computers with the Microsoft Internet Explorer Web browser can also be used as receivers.

Video encoding

VideoJet 8008 and VideoJet 8004 use the MPEG-4 video compression standard. Thanks to efficient encoding, the data rate remains low even with high image quality and can also be adapted to local conditions within wide limits. In this manner, the simultaneous encoding of all eight video channels is supported.

Dual Streaming in the VideoJet 8008

Dual Streaming allows the incoming data stream to be encoded simultaneously according to two different, individually customized profiles. With VideoJet 8008, two data streams are created per camera that can serve different purposes, for example, one can be used for local recording and one can be optimized for transmission over the LAN.

The VideoJet 8004 does not offer Dual Streaming.

Multicast

In suitably configured networks, the multicast function enables simultaneous real-time video transmission to multiple receivers. The UDP and IGMP V2 protocols must be implemented on the network for this function.

DVR

The integrated hard drive means that VideoJet 8008 and VideoJet 8004 can be used as digital video recorders for local long-term recording. Both units support ANR technology, which guarantees seamless recording without gaps with VIDOS-NVR, even during network failures.

Remote control

For remote control of external units such as pan or tilt heads for cameras or motorized zoom lenses, control data is transmitted via the bidirectional serial interface. This interface can also be used to transmit transparent data.

Configuration

The units can be configured with a Web browser via the local network (Intranet) or via the Internet. In the same way, firmware updates and fast loading of device configurations are possible.

Snapshots

Individual video images (snapshots) can be called up from the unit, stored on the computer's hard drive or displayed in a separate browser window in JPEG format.

Backup

The LIVEPAGE and MEDIA-REPLAY pages both contain an icon for saving the video images shown as a file on your computer's hard drive. Video sequences can be stored by means of a mouse click and can be redisplayed using the MPEG viewer supplied as part of the scope of delivery.

Summary

VideoJet 8008 and VideoJet 8004 offer the following main functions:

- Video and data transmission over IP data networks
- Dual Streaming function for every encoder to allow simultaneous encoding based on two individually definable profiles (only VideoJet 8008)
- Multicast function for simultaneous image transmission to multiple receivers
- Eight independent analog BNC composite video inputs (PAL/NTSC)
- Video encoding to international standard MPEG-4
- Integrated Ethernet port (10/100/1000 Base-T)
- Transparent, bidirectional data channel via RS232/RS422/RS485 serial interface
- Local long-term recording on integrated hard drive
- Remote control for all internal functions with TCP/IP
- Password protection to prevent unauthorized connection or configuration changes
- Ten alarm inputs for external sensors (such as door contacts)
- Built-in video sensor for motion and tamper alarms
- Event-controlled automatic connection (for example at switch-on and for alarms)
- Fast and convenient configuration using built-in Web server and browser
- Firmware update using flash memory
- Convenient uploading of configuration data

The various audio versions also offer:

- Transmission and receipt of audio signals
- Bidirectional audio (mono) for line or microphone/speaker links
- Audio encoding to international standard G.711
- Five relay outputs for switching external units (such as lamps or sirens)
- Additional RS232 serial interface

Connections on the rear panel

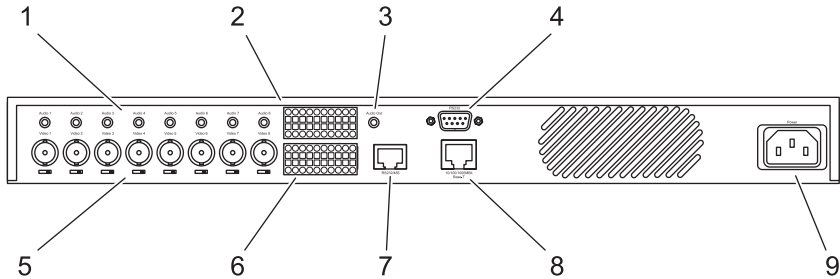

- 1 Eight audio ports (Mono): **Audio 1** to **Audio 8** (audio versions only)
3.5 mm stereo sockets for connecting audio cables
- 2 Additional terminal block (audio versions only)
Relay outputs, serial interface, audio port for microphone and loudspeaker (speaking level)
- 3 **Audio Out** audio output (audio versions only)
3.5 mm stereo socket, stereo output with line-out level
- 4 **RS232** serial interface (audio versions only)
9-pin sub-D socket (m) as additional serial interface
- 5 Eight video inputs: **Video 1** to **Video 8**
BNC sockets for connecting the video sources, each with a switch for 75 Ohm terminating resistance
- 6 Ten alarm inputs: **IN1** to **IN10**
Push-in terminal for connecting external signal sources or switches
- 7 **RS232/485** serial interface
RJ45 socket for transmitting control data (standards RS232, RS422 and RS485) and for configuration using a terminal program
- 8 **10/100/1000 MBit Base-T** RJ45 socket
for connecting to an Ethernet LAN (local network)
incl. green network connection LED (left) and orange data transmission LED (right)
- 9 **Power** socket
for connecting the power supply cable

Front panel

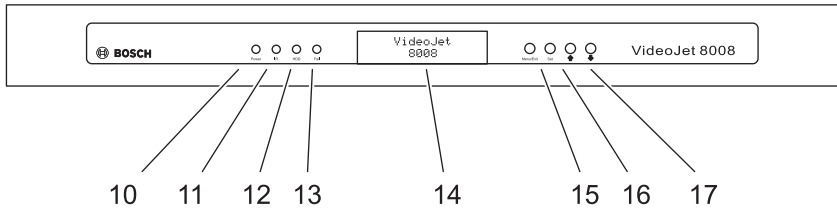

10 Power LED

lights up green when ready for operation

11 IR diode

infrared receiver (for future function extensions)

12 HDD LED

flashes red during data transmission to and from the hard drive

13 Fail LED

flashes red during hardware error (defective fans)

14 Display

for displaying operating parameters

15 Menu/Exit key

for activating and deactivating the configuration menu

16 Set key

for saving changes to the operating parameters
(for future function extensions)

17 Arrow keys

for navigation in the display menu

For more information about the LEDs, see page 143.

4

Installation

VideoJet 8008 and VideoJet 8004 are designed as desktop units and intended for installation in a switch cabinet. Mounting in a 19-inch rack using the mounting kit supplied is a quick and easy operation.

For desktop operation, four self-adhesive, non-slip rubber feet are included, which you can stick to the bottom of the unit.



Caution

The unit is designed for indoor operation. Select a suitable location for installation where the unit will not be subjected to conditions of extreme temperature or humidity. The ambient temperature must be between 0 and +40 °C (+32 and +104 °F), and the relative humidity must not exceed 80% (non-condensing).

The unit heats up during operation, so you should ensure that there is adequate ventilation and enough clearance between the unit and heat-sensitive objects or equipment.

Please ensure the following installation conditions:

- Do not install the unit close to heaters or other heat sources. Avoid locations exposed to direct sunlight.
- Allow sufficient space for running cables.
- Ensure that the unit has adequate ventilation. Bear the total heat output in mind, particularly when installing multiple units in a switch cabinet.
- When making connections, use only the cables supplied or use appropriate cables immune to electromagnetic interference.
- Position and run all cables so that they are protected from damage, and provide adequate cable strain relief where needed.
- Avoid impacts, blows and severe vibrations as these can irreparably damage the unit.

Installing in a switch cabinet

VideoJet 8008 and VideoJet 8004 are set up for installation in a 19-inch rack. The necessary mounting kit is already supplied.



Caution

When installing in a switch cabinet, ensure that there is sufficient ventilation for each unit: There must be at least 5 cm (1.97 in.) of free space to the left and right of the unit and at least 10 cm (3.94 in.) at the rear.

The ambient temperature must be between 0 and +40 °C (+32 and +104 °F), and the relative humidity must not exceed 80%.

The unit heats up during operation, so you should ensure that there is enough clearance between the unit and other heat-sensitive equipment or objects.

When mounting additional units, direct contact is permitted, provided that the surface temperature of the adjacent units does not exceed +40 °C (+104 °F).

Installing the unit

- On the left and right-hand sides of the housing, loosen the two screws on the front panel and remove them completely.
- Insert the two angle brackets from the mounting kit into the slots next to the screw holes on the housing and secure them with the four housing screws.
- Set the unit in the switch cabinet frame and secure the angle brackets using the four screws, washers and lock nuts provided.
- Connect the rubber connector of the power cable supplied to the **Power** socket on the rear panel of the unit.

Installation overview

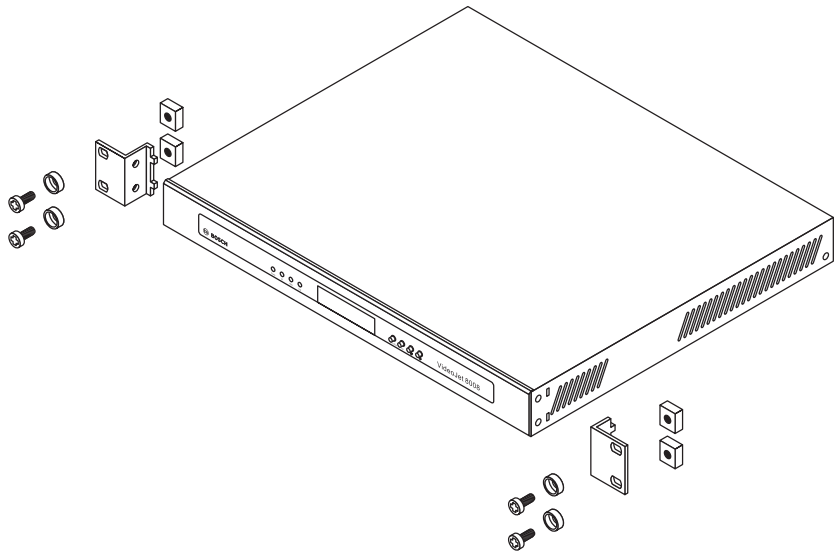

Connections

Cameras

You can connect a maximum of eight standard video sources (such as CCTV cameras). Any cameras and other video sources that produce a standard PAL or NTSC signal are suitable.

Note

On the VideoJet 8008, the maximum resolution at the complete image rate for each camera input is Full D1/4CIF. The VideoJet 8004 only supports the Full D1/4CIF resolution when every other camera input is assigned, that is, when the four uneven inputs (**Video 1, 3, 5, 7**) or the four even inputs (**Video 2, 4, 6, 8**) are assigned. If all eight inputs are assigned, the VideoJet 8004 supports a maximum resolution of 2CIF at the full image rate. Mixed assignment is also possible: for example, assign **Video 1** to **Video 4** (2CIF) and then only **Video 5** and **Video 7** (4CIF each).

VideoJet 8008	Video 1	Video 2	Video 3	Video 4	Video 5	Video 6	Video 7	Video 8
	4CIF	4CIF	4CIF	4CIF	4CIF	4CIF	4CIF	4CIF

VideoJet 8004	Video 1	Video 2	Video 3	Video 4	Video 5	Video 6	Video 7	Video 8
	4CIF	—	4CIF	—	4CIF	—	4CIF	—
	—	4CIF	—	4CIF	—	4CIF	—	4CIF
	2CIF	2CIF	2CIF	2CIF	2CIF	2CIF	2CIF	2CIF
	2CIF	2CIF	2CIF	2CIF	4CIF	—	4CIF	—

- Connect the cameras or other video sources with a video cable (75 Ohm, BNC plug) to the BNC **Video 1** to **Video 8** sockets.
- Set the **75 Ω** sliding switch under the BNC sockets to **●**, in order to terminate the video input, if the video signal is not looped through.

Data interface

The bidirectional data interface is used to control connected units, such as a dome camera with motorized lens. The range of controllable equipment is expanding constantly. The manufacturers of the relevant equipment provide specific information on installation and control.

The **RS232/485** connection supports the RS232, RS422 and RS485 transmission standards. The serial interface is designed as a RJ45 socket. See page 144 for the pin assignment.



Caution

Please take note of the appropriate documentation when installing and operating the unit to be controlled. The documentation contains important safety instructions and information about permitted uses.



Note

A video connection is necessary to transmit transparent data.

Network

You can connect the unit to a 10/100/1000 Base-T network using a standard UTP category 5 cable with RJ45 connectors.

- Connect the unit to the network via the **10/100/1000 MBit Base-T** socket.

Alarm inputs

VideoJet 8008 and VideoJet 8004 offer ten alarm inputs via an orange terminal block. The alarm inputs are used to connect to external alarm devices such as door contacts or sensors. When configured appropriately, an alarm device can, for example, trigger the unit to automatically establish a connection with a remote station.

A zero potential make contact or switch can be used as the actuator. You can find the pin assignment on page 146.



Note

If possible, use a bounce-free contact system as the actuator.

- Connect the lines to the appropriate terminals of the orange terminal block and check that the connection is secure.

Audio connections (audio versions only)

The audio versions of VideoJet 8008 and VideoJet 8004 have several audio ports for audio line signals as well as a microphone input and a loudspeaker output.

The audio signals are transmitted two-way and in sync with the video signals. As a result, you can connect a speaker or door intercom system at the destination point, for example. When transmitting audio signals, a maximum of one input and one output current is possible at the same time. However, several audio outputs can be connected with the same audio stream. Selection is carried out using the software user interface.

The following specific audio ports are available:

Audio 1 to Audio 8 Socket, input/output, mono, line level

Audio Out Socket, output, stereo, line level

AI Terminal connector, input, mono, speaking level

AO Terminal connector, output, mono, speaking level

Note

If possible you should use the line ports of the intercom for transmitting audio signals on the intercom systems. The following specifications should be complied with in all cases.

Audio 1 to 8 Line In: Impedance 50 kOhm typ.,
1 V_{p-p} max. input voltage

Audio 1 to 8 Line Out: Impedance 8 Ohm min.,
1 V_{p-p} max. output voltage

Audio Out: 2 × 5 W @ 8 Ohm / 2.5 W @ 4 Ohm

AI (microphone): Impedance 2 kOhm typ.,
2.8 V_{p-p} max. input voltage,
-20 dB in, supply 2.3 V typ.

AO (loudspeaker): Impedance 4 Ohm min.,
6 V_{p-p} max. output voltage,
power output RMS 1 W

The stereo socket plugs must be connected as follows:

Contact	Audio 1 to Audio 8	Audio Out
Tip	Line Out	Left channel
Middle ring	Line In	Right channel
Lower ring	Ground	Ground

- Connect the desired audio sources with line level to the **Audio 1 to Audio 8** sockets with a 3.5 mm stereo plug.
- If necessary, connect two loudspeakers to the **Audio Out** socket.

If you wish to connect a microphone and a loudspeaker directly:

- Connect the microphone cords to the **AI** and ground connections on the push-in terminal.
- Connect the loudspeaker cords to the **AO** and ground connections on the push-in terminal.

Relay outputs (audio versions only)

The audio versions of VideoJet 8008 and VideoJet 8004 have five relay outputs for connecting external units such as lamps or alarm sirens. You can operate these relay outputs manually while there is an active connection to the device. The output can also be configured to automatically activate sirens or other alarm units in response to an alarm signal. The relay outputs are also located on the orange terminal block.



Caution

A maximum load of 30 V and 2 A may be applied to the relay contacts.

- Connect the lines to the appropriate **R1 to R5** terminals of the orange terminal block and check that the connections are secure.

Second RS232 data interface (audio versions only)

The audio versions of VideoJet 8008 and VideoJet 8004 have a second serial interface. The **RS232** connection is designed as a 9-pin sub-D socket and supports the RS232 transmission standard.

Power on/Power off

Power supply

The VideoJet 8008 and VideoJet 8004 are supplied with a power supply cable and rubber connector. The units do not have a power switch. After you have connected the unit to the power supply and the unit has booted, it is ready for use.



Caution

Where necessary, use suitable equipment to ensure that the power supply is free from interference such as voltage surges, spikes or voltage drops.



Caution

You should only connect the unit to the mains once all other connections have been made.

- Plug the rubber connector of the power supply cable into the **Power** socket.
- Connect the power supply cable to a fused mains socket. The green **Power** LED on the front panel of the unit lights up. As soon as the text VideoJet 8008 or VideoJet 8004 is displayed on the screen after the unit has booted, the unit is ready for use.

If the network connection has been correctly set up, the green LED of the **10/100/1000 MBit Base-T** RJ45 socket on the back of the unit is illuminated. The flashing orange LED signals that data packets are being transmitted across the network.

Setup using a terminal program

Data terminal

You can connect a data terminal to the unit for setup and local control. The data terminal consists of a computer with a terminal program. Use the configuration cable supplied to establish the connection.

HyperTerminal, a communications accessory included with Microsoft Windows, can be used as the terminal program.

Note

Information on installing and using HyperTerminal can be found in the manuals or in the online help for MS Windows.

- Disconnect the unit from the data network before working with the terminal program.
- Connect the unit's **RS232/485** RJ45 socket to a free serial interface on the computer.

Configuring the terminal

Before the terminal program can communicate with the unit, the transmission parameters must be matched. Make the following settings for the terminal program:

- 19,200 bit/s
- 8 data bits
- No parity check
- 1 stop bit
- No protocol

Command inputs

After the connection has been established, you must log onto the unit to access the main menu. Other submenus and functions can be accessed using the on-screen commands.

- If necessary, turn off the local echo so that entered values are not repeated on the display.
- Enter one command at a time.
- When you have entered a value (such as an IP address), check the characters you have entered before pressing the [ENTER] key to transfer the values to the unit.

Assigning an IP Address

To use a VideoJet 8008 or VideoJet 8004 in your network, you must assign it an IP address that is valid for your network.

The following default address is preset at the factory: **192.168.0.1**

- Start a terminal program such as HyperTerminal.
- First enter `?` and then `service` as the user name. The terminal program displays the main menu.
- Enter command `i` to open the IP menu.

```

***** IP *****
(*) Device needs to be reset to change setting
-----
'i'  (*)local IP           (m) 192.168.0.1
's'  (*)local subnet mask  255.255.255.0
'g'  (*)local gateway      0.0.0.0
'r'  remote IP             0.0.0.0
     Mac Address           00-07-5f-60-07-91
'a'  Auto Connect         off
'h'  HTTP Port            80
'm'  Set HD/FD 10/100 auto mode
'p'  Ping remote IP       0.0.0.0
'l'  RTP Packet Loss Stats
'x'  Leave this Menu
'??' This Menu
*****
Current local IP: 192.168.0.1
New local IP: 192.168.0.88
  
```

- Enter `i` again. The terminal program displays the current IP address and prompts you to enter a new IP address.
- Enter the desired IP address and press [ENTER]. The terminal program displays the new IP address.
- If necessary, enter command `s` and a new subnet mask.

**Note**

You must restart to activate the new IP address, a new subnet mask or a gateway address.

Restart

Briefly disconnect the power supply from the unit (unplug the power supply cable and plug it in again after a few seconds).

Additional parameters

You can use the terminal program to check other basic parameters and modify them where necessary. Use the on-screen commands in the various submenus to do this.

5

Configuration using a Web browser

Connecting

The integrated HTTP server provides you with the option to configure the unit over the network with a Web browser. This option is significantly more comprehensive and convenient than configuration using a terminal program and also offers you the option of displaying live video images.

Note

Make sure the graphics card is set to 16- or 32-bit color depth and that Microsoft Virtual Machine is installed and activated on your PC. If necessary, you can install the required software and controls from the product CD supplied (see **Components supplied**, page 9).

Instructions for using the Web browser can be found in its online help.

System requirements

- Microsoft Internet Explorer (version 6.0 or higher)
- Monitor resolution 1024 × 768 pixels
- Network access (Intranet or Internet)

Note

Also note the information in the **System Requirements** document on the product CD supplied.

Installing MPEG ActiveX

Note

Suitable MPEG ActiveX software must be installed on the computer to allow the live video images to be played back. If necessary, you can install the required software and controls from the product CD supplied (see **Components supplied**, page 9).

- Insert the CD into the computer's CD-ROM drive. If the CD does not start automatically, open the root directory of the CD in Windows Explorer and double click **MPEGAx.exe**.
- Follow the on-screen instructions.

Establishing the connection

To operate the unit in your network, it must have a valid IP address for your network.

The following default address is preset at the factory: **192.168.0.1**

- Start the Web browser.
- Enter the unit's IP address as the URL. The connection is established and after a short time you will see the **LIVEPAGE** with the video image.



 **Note**

The screen display can differ from that shown above, depending on the unit variants that you use.

If you do not connect, the device may have reached its maximum number of connections. The maximum number of connections depends on the unit and network configuration.

Protected unit

If the unit is password protected against unauthorized access, the Web browser displays a message to that effect and prompts you to enter the password when you call up access-protected areas.

 **Note**

The unit offers the option of limiting access across various authorization levels (see pages 48 and 65).

- Enter the user name and associated password in the corresponding text fields.
- Click **OK**. If the password is entered correctly, the Web browser displays the page that was called up.

Choosing the configuration mode

There are two options for configuring the unit or checking the current settings:

- the unit overview or
- the configuration menu.

All settings are stored in the unit's memory so that they are retained even if the power supply is interrupted.

Unit overview

The unit overview shows the most important parameters summarized into six groups. This overview allows you to change the basic settings with just a few clicks and entries.

Configuration menu

The configuration menu is recommended for expert users or system administrators. You can access all unit parameters in this mode. Settings that affect the fundamental functioning of the unit (such as firmware updates) can only be made using the configuration menu.

Starting configuration

Click the **SETTINGS** link in the upper section of the **LIVEPAGE** window. The Web browser opens a new page containing the configuration menu (see **Configuration menu**, page 63) and the unit overview (see **Unit overview**, page 33):

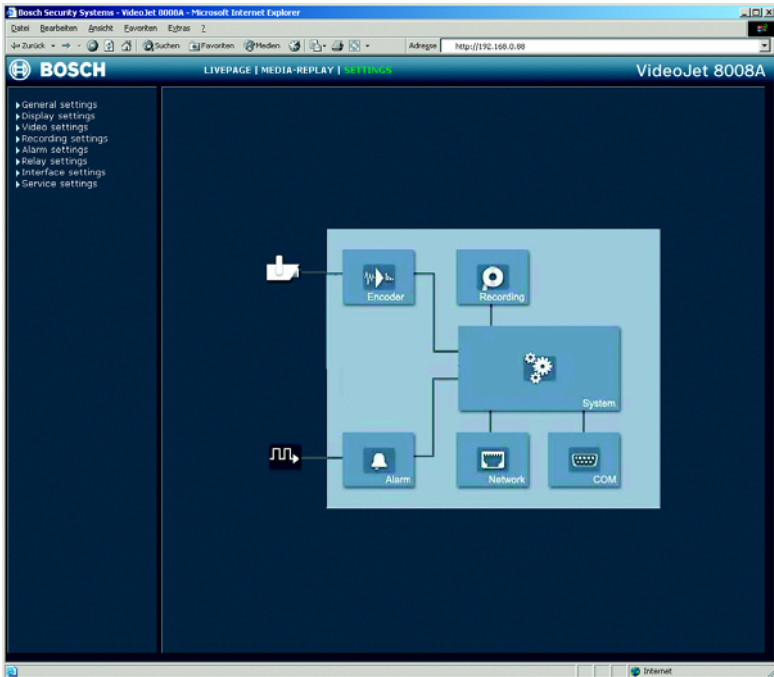

Note

The screen display can differ from that shown above, depending on the unit variants that you use.

Unit overview

The unit overview is a graphic presentation of the various areas of the configuration. The individual configuration parameters are arranged in groups and displayed in separate windows. You can access the individual areas directly.

- Click one of the graphic symbols. A new window will open.
- Click in the text fields to enter values or use the other controls that are available, such as buttons, checkboxes or list fields.
- Click the **SETTINGS** link at the top of the window to close the window without saving the changes made.

Making changes

After making changes in a window, click the **Set** button to send the new settings to the unit and to save them there.



Caution

Save the changes made in each window by clicking **Set**. If you click the **Set** button, only the settings in the current window are saved.

The following sections describe the individual windows that can be accessed using the graphic symbols in the unit overview.

Encoder settings



For encoding the video signal, you can select a profile for each camera, and for Dual Streaming compatible units you can select two profiles each.

You can identify the Dual Streaming compatible units from the additional **MPEG-4 Stream 2** tab.

Selecting a profile

MPEG-4 encoder

Active profile for video 1:	High resolution (D1/4CIF)
Active profile for video 2:	High resolution (D1/4CIF)
Active profile for video 3:	High resolution (D1/4CIF)
Active profile for video 4:	High resolution (D1/4CIF)
Active profile for video 5:	High resolution (D1/4CIF)
Active profile for video 6:	High resolution (D1/4CIF)
Active profile for video 7:	High resolution (D1/4CIF)
Active profile for video 8:	High resolution (D1/4CIF)

Set

MPEG-4 Stream 1 / MPEG-4 Stream 2

You can configure the MPEG-4 data transmission in accordance with the operating environment (for example network structure, bandwidth, data load). For Dual Streaming compatible units, each encoder can create two data streams at the same time, with different compression settings, such as for transmission and local saving.

Note

The settings must be made individually for each camera input and stream. The numbering is the same as the labeling of the video inputs on the rear panel of the unit.

Pre-programmed profiles are available, each giving priority to different perspectives.

- **Profile 1: Low bandwidth (CIF)**
High quality for low bandwidth connections,
resolution 352 × 288/240 pixels
- **Profile 2: Low delay (1/2 D1)**
High quality with low delay,
resolution 352 × 576/480 pixels
- **Profile 3: High resolution (D1/4CIF)**
High resolution for high bandwidth connections,
resolution 704 × 576/480 pixels
- **Profile 4: DSL**
For DSL connections at 500 kBit/s,
resolution 352 × 288/240 pixels
- **Profile 5: ISDN (2B)**
For ISDN connections via two B channels,
resolution 352 × 288/240 pixels
- **Profile 6: ISDN (1B)**
For ISDN connections via one B channel,
resolution 352 × 288/240 pixels
- **Profile 7: Modem**
For analog modem connections at 20 kBit/s,
resolution 352 × 288/240 pixels
- **Profile 8: GSM**
For GSM connections at 9,600 baud,
resolution 176 × 144/120 pixels

Active profile for video 1 to Active profile for video 8:

Here, you can select the desired profile.

- Dual Streaming compatible units only: Click a tab to select the relevant stream.
- Select the desired setting from the list.



Note

Dual Streaming compatible units only: For alarm connections and automatic connections, stream 2 is always transmitted. Bear this fact in mind when assigning the profile. Stream 2 is also used for local recording.

Note

When local recording is running, the profile set as the **Recording profile** for the relevant video input is active (see page 45).

Changing profiles

Profile configuration

Profile 1
Profile 2
Profile 3
Profile 4
Profile 5
Profile 6
Profile 7
Profile 8

Profile name:

Target data rate: kBit/s

Max. data rate: kBit/s

P-frame video quality: High Low

I-frame video quality: High Low

I-frame distance:

Encoding interval:

Video resolution:

Reset of profile:

You can change individual parameter values within a profile and you can also change the name. You can switch between the profiles by clicking the appropriate tab.



Caution

The profiles are rather complex. They include a large number of parameters that interact with one another, so it is generally best to use the default profiles. Change the profiles only once you are fully familiar with all the configuration options.

Note

All parameters combine to make up a profile and are dependent on one another. If you enter a parameter that is outside the permitted range, the nearest permitted value will automatically be substituted when the settings are saved.

Profile name:

You can enter a new name for the profile here. The name is then displayed in the **MPEG-4 encoder** field in the list of selectable profiles.

Target data rate:

You can limit the data rate for the unit to optimize utilization of the bandwidth in your network. The target data rate should be set according to the desired picture quality for typical scenes with no excessive motion.

For complex images or frequent changes of image content due to frequent movements, this limit can be temporarily exceeded up to the value you enter in the **Max. data rate** field.

Max. data rate:

This maximum data rate is not exceeded under any circumstances. Depending on the video quality settings for the I- and P-frames, this fact can result in individual images being skipped.

The value entered here should be at least 10% higher than the value entered in the **Target data rate** field.

P-frame video quality:

This setting allows you to adjust the image quality of the P-frames depending on the movement within the image. The **Auto** option automatically adjusts to the optimum combination of movement and image definition (focus). Selecting **Manual** allows you to set a value between 4 and 31 on the slide bar. The value **4** represents the best image quality with, if necessary, a lower frame refresh rate depending on the settings for the maximum data rate. A value of **31** results in a very high refresh rate and lower image quality.

I-frame video quality:

This setting allows you to adjust the image quality of the I-frames. The **Auto** option automatically adjusts the quality to the settings for the P-frame video quality. Selecting **Manual** allows you to set a value between 4 and 31 on the slide bar. The value **4** represents the best image quality with, if necessary, a lower frame refresh rate depending on the settings for the maximum data rate. A value of **31** results in a very high refresh rate and lower image quality.

I-frame distance:

This parameter allows you to set the intervals in which the I-frames will be coded. **0** means auto mode, whereby the video server inserts I-frames as necessary. An entry of **1** indicates that I-frames are continuously generated. An entry of **2** indicates that only every second image is an I-frame, and **3** only every third image etc.; the frames in between are coded as P-frames.

Encoding interval:

The figure selected here determines the interval at which images are encoded and transmitted. For example, entering **4** means that only every fourth image is encoded, the following three are skipped - this can be particularly advantageous with low bandwidths.

Video resolution:

Here you can select the desired resolution for the MPEG-4 video image. The following resolutions are available:

- **QCIF** 176 × 144/120 pixels
- **CIF** 352 × 288/240 pixels
- **1/2 D1** 352 × 576/480 pixels
- **2CIF** 704 × 288/240 pixels
- **D1/4CIF** 704 × 576/480 pixels

Reset of profile:

Click **Default** to return the profile to the factory default values.

Recording parameters



Here, you can set all parameters for recording on the local hard drive. Recording can be performed continuously or only in the case of an alarm.

Recording scheduler

Partition: Camera 1

Time recording |
 Alarm recording |
 Properties

☾ 0:00 3:00 6:00 9:00 12:00 ☀ 15:00 18:00 21:00 24:00 ☾

	0:00	3:00	6:00	9:00	12:00	15:00	18:00	21:00	24:00
Monday									
Tuesday									
Wednesday									
Thursday									
Friday									
Saturday									
Sunday									

00:00:00

Used filetracks on partition: 2 / 128

Used space on partition: 1 %

Free space on partition: 19424 MByte(s)

Recording status:

Partition:

Select the partition in which you want to record. Recording is performed for every video input in a separate partition.

Activating a partition for recording

After configuration, you can activate the partition for recording by clicking the **Start** button.

After starting, the Time recording, Alarm recording and Properties pages for the activated partition are displayed in gray and the configuration cannot be modified.

The graphic in the lower section of the pages indicates this partition's recording activity. You will see an animated graphic while recording is taking place.

You can terminate recording at any time and deactivate one, multiple or all partitions.

- Click the **Start** button to activate the currently selected partition for recording.
- Click the **Start all** button to activate all the partitions set up for the recording.
- Click the **Stop** button to deactivate the currently selected partition for recording. Recordings that are currently running will be interrupted and the configuration can be modified.
- Click the **Stop all** button to deactivate all the partitions set up for the recording. Running recordings are interrupted and the configuration can be changed.

Time recording

You can specify the times during which continuous recording to the hard drive should take place.

Separate selection fields per partition are available for each day of the week, allowing settings to be made per camera input. You can select up to 16 individual recording time intervals for each day of the week.

Note

If a period is already selected for alarm recording, you cannot select it for time recording (see **Alarm recording**, page 42).

- Left-click the point in the schedule at which recording should start and hold the button down.
- Drag the selected field to the desired recording end and then release the mouse key.
- Right-click a highlighted time interval to delete it.
- Click the **Select all** button to highlight all time intervals.
- Click the **Clear** button to delete all highlighted time intervals.

Used filetracks on partition:

Within a partition, up to 128 filetracks are created automatically. Each new recording has its own track.

In **Linear mode** (see page 45), no more new recordings are made when the 128 tracks are written; old recordings must first be deleted. In **Ring mode**, the 129th recording is written in the first track again etc., so that the oldest recording is overwritten with the most recent recording.

Used space on partition:

This displays how much space is already used in the partition.

Free space on partition:

This displays how much space is still available in the partition.

Recording status:

The graphic indicates the recording activity in this partition. You will see an animated graphic while recording is taking place.

Alarm recording

Here, you can specify the times during which continuous recording to the hard drives should take place in the event of an alarm.

As with time recording, there are separate selection fields for each partition and thus for each camera input. You can select up to 16 separate periods for each day of the week. Alarm recording occurs only during the highlighted time intervals.

Note

If a period is already selected for time recording, you cannot select it for alarm recording (see **Time recording**, page 40).

Caution

Alarm tracks must be set up in the required partition for alarm recording (see **Number of alarm tracks**, page 43).

The unit uses a special recording mode during alarm recording for optimal usage of storage capacity: as soon as a time gap for alarm recording begins, a recording is continuously made on one segment, which is the size of a complete alarm sequence (pre- and post-alarm time).

This segment in the partition functions in a similar manner to a ring buffer and is overwritten until an alarm is actually triggered. Recording occurs on the segment only for the duration of the preset post-alarm time and a new segment subsequently used in the same manner.

This ensures that the alarm recorded is always secured for its entire duration and the space required to save each alarm recording is easy to calculate.

Number of alarm tracks:

Select the number of alarm tracks to be used in the partition. One alarm event can be recorded in each alarm track. Accordingly, the number of alarms entered can be recorded and archived. A partition can contain a maximum of 128 alarm recordings.

If the **Ring mode** option (see page 45) is set for the partition, the latest alarm recordings are always saved in the preset number. If the **Linear mode** option is set for the partition, the recording stops as soon as all the alarm tracks have been written.

Pre-alarm duration:

Select the period to be covered by pre-alarm recording.

Post-alarm duration:

Select the period to be covered by alarm recording.

Used alarm tracks on partition:

This displays how many of the alarm tracks created have already been used.

Used space on partition:

This displays how much space is already used in the partition.

Free space on partition:

This displays how much space is still available in the partition.

Recording status:

The graphic indicates the recording activity in this partition. You will see an animated graphic while recording is taking place.

Properties

Recording scheduler

Partition:

Time recording | Alarm recording | **Properties**

Partition name:

Video input: 1 Stream 2

Type of recording:

Video recording: MPEG-4

Recording profile:

Alarm recording at

Alarm input: 1 2 3 4 5 6 7 8 9 10

Motion alarm: 1 2 3 4 5 6 7 8

Video loss: 1 2 3 4 5 6 7 8

Partition total size: 19620 MByte(s)

Remaining for recording: 2 day(s) 15 hour(s) 8 minute(s)

Free space on partition: 19424 MByte(s)

Recording status: 

Note: This partition will be re-organized if any properties on this partition are changed. Previous recordings on this partition will be lost. Please backup the video data first.

You can view the current properties for the partition selected in each case directly in the recording scheduler and modify them if necessary. You can also activate the alarms that should trigger recording. Similarly, you can also select the profile for recording.

**Caution**

All modifications result in the reorganization of the partition and the loss of all sequences on this partition.

Consequently, you should back up all important sequences on the computer's hard drive.

Partition name:

You can enter a new name for the partition.

Video input:

The number of the associated video input and the stream used for the recording are displayed here. The numbering is the same as the labeling of the video inputs on the rear panel of the unit.

**Note**

On Dual Streaming compatible units, stream 2 is always used for the recording.

Type of recording:

Select the required recording type.

In the case of **Ring mode** the recording proceeds continuously. If the maximum hard drive space has been reached, the oldest recordings are automatically overwritten.

In the case of **Linear mode** the recording proceeds until the entire hard drive space is full. The recording is then stopped until old recordings have been deleted.

Video recording:

The recording format is displayed here for information.

Recording profile:

Select the profile that is to be active during recording. You can view and modify the properties for the profiles (see **Encoder settings**, from page 34).

**Note**

The recording profile can differ from the standard setting **Active profile** for the video input set and is only used during an active recording.

Alarm recording at:

You can select the alarm sensor that is to trigger a recording. You can also use the motion and video alarm for a camera to trigger the alarm recording by another camera.

Note

The alarm sensor must be active to be able to trigger the recording. The alarm inputs and video loss alarms are activated on the **Alarm settings** page (see page 51). The motion alarms are configured and activated for each camera on the **Motion detector** page (see page 99).

- Check the box for the alarm sensor that is to trigger a recording. The selected check boxes are marked with a tick.

Note

The numbers of the alarm input check boxes correspond to the labeling of the alarm inputs on the rear panel of the unit. The motion and video loss alarm numbers correspond to the labeling of the video inputs.

Partition total size:

This displays how much storage space the partition occupies on the hard drive.

Remaining for recording:

This displays the maximum remaining recording time. The value is automatically updated after the parameters have been modified.

Free space on partition:

This displays how much space is still available in the partition.

Recording status:

The graphic indicates the recording activity in this partition. You will see an animated graphic while recording is taking place.

Format

You can delete all recordings in a partition at any time.



Caution

Check the recordings before deleting and back up important sequences on the computer's hard drive.

- Click the **Format** button to delete all recordings on the currently selected partition.

System settings



Here you can set or select various basic data for the unit.

Unit identification

Unit identification	
Unit name:	<input type="text"/>
Unit ID:	<input type="text"/>
<input type="button" value="Set"/>	

Unit name:

You can give the unit a name to make it easier to identify. The name simplifies the management of multiple units in larger systems, for example using the VIDOS program.

Note

The unit name is used for the remote identification of a unit, in the event of an alarm, for example, or to make it easier to call up a unit when using a DNS server. Enter a name that makes it as easy as possible to quickly identify the location.

Unit ID:

Every unit should be assigned a unique identifier that you enter here as an additional means of identification.

Password



The screenshot shows a web-based configuration interface for setting a password. It features a blue header with the title "Password". Below the header, there are three input fields: "User name:" with a dropdown menu showing "user", "Password:" with an empty text box, and "Confirm password:" with an empty text box. To the right of the Password field, there is a red error message: "No 'user'-password set!". At the bottom right, there is a blue button labeled "Set".

A unit is generally protected by a password to prevent unauthorized access to the unit. You can use different authorization levels to limit access.

Note

Proper password protection is only guaranteed when all higher authorization levels are also protected with a password. If a **live** password is assigned, for example, a **service** and a **user** password must also be set. When assigning passwords, you should therefore always start from the highest authorization level.

User name:

The unit operates with three user names: **service**, **user** and **live**, which correspond to different authorization levels.

The **service** user name is the highest authorization level. After entering the correct password, this user name allows you to use all the functions of the unit and change all configuration settings.

The **user** user name is the middle authorization level. You use it to operate the unit and also to control cameras, for example, but you cannot change the configuration.

The **live** user name is the lowest authorization level. It can only be used to view the live video image and switch between the different live image displays.

Password:

You can define and change a separate password for each user name if you are logged in as **service** or if the unit is not password protected.

Enter the password for the selected user name here.

Confirm password:

Enter the new password a second time to eliminate typing mistakes.

Note

The new password is only saved when you click the **Set** button. You should therefore click the **Set** button immediately after entering and confirming the password, even if you also wish to subsequently assign a password to another user name.

Language

Language		
Website language:	<input type="text" value="English"/>	<input type="button" value="Set"/>

Website language:

Select the language for the user interface here.

Date and time

Date and time	
Date format:	<input type="text" value="Europe"/>
Unit date:	<input type="text" value="Sunday"/> , <input type="text" value="23"/> . <input type="text" value="10"/> . <input type="text" value="2005"/>
Unit time:	<input type="text" value="16"/> : <input type="text" value="52"/> : <input type="text" value="54"/> <input type="button" value="Synchr. PC"/> <input type="button" value="Set"/>

Date format:

Select your required date format

(**Europe:** DD.MM.YYYY; **USA:** MM.DD.YYYY; **Japan:** YYYY/MM/DD).

Unit date and Unit time:

If there are multiple devices operating in your system or network, it is important to synchronize their internal clocks. For example, it is only possible to identify and correctly evaluate simultaneous recordings when all units are operating on the same time.

- Enter the current date. Since the unit time is controlled by the internal clock, there is no need to enter the day of the week - it is added automatically.
- Enter the current time or click the **Synchr. PC** button to copy your computer's system time to the unit.

Version information

Version information	
Hardware version:	<input type="text" value="C0079143"/>
Firmware version:	<input type="text" value="15000150"/>

The hardware and firmware version numbers are for information only and cannot be changed. Keep a record of these numbers in case technical assistance is required.

Hardware version:

The hardware version number of the unit is displayed.

Firmware version:

The firmware version number of the unit is displayed.

Alarm settings



In this option you can make your settings for the alarm sources and alarm connections.

Alarm sources

Alarm sources

Alarm input 1:	<input type="button" value="Off"/>	<input type="button" value="Active high"/>	Name: <input type="text" value="Input 1"/>
Alarm input 2:	<input type="button" value="Off"/>	<input type="button" value="Active high"/>	Name: <input type="text" value="Input 2"/>
Alarm input 3:	<input type="button" value="Off"/>	<input type="button" value="Active high"/>	Name: <input type="text" value="Input 3"/>
Alarm input 4:	<input type="button" value="Off"/>	<input type="button" value="Active high"/>	Name: <input type="text" value="Input 4"/>
Alarm input 5:	<input type="button" value="Off"/>	<input type="button" value="Active high"/>	Name: <input type="text" value="Input 5"/>
Alarm input 6:	<input type="button" value="Off"/>	<input type="button" value="Active high"/>	Name: <input type="text" value="Input 6"/>
Alarm input 7:	<input type="button" value="Off"/>	<input type="button" value="Active high"/>	Name: <input type="text" value="Input 7"/>
Alarm input 8:	<input type="button" value="Off"/>	<input type="button" value="Active high"/>	Name: <input type="text" value="Input 8"/>
Alarm input 9:	<input type="button" value="Off"/>	<input type="button" value="Active high"/>	Name: <input type="text" value="Input 9"/>
Alarm input 10:	<input type="button" value="Off"/>	<input type="button" value="Active high"/>	Name: <input type="text" value="Input 10"/>
Video loss alarm:	<input type="checkbox"/> 1 <input type="checkbox"/> 2 <input type="checkbox"/> 3 <input type="checkbox"/> 4 <input type="checkbox"/> 5 <input type="checkbox"/> 6 <input type="checkbox"/> 7 <input type="checkbox"/> 8		
1. SNMP host address:	<input type="text" value="0.0.0.0"/>		
2. SNMP host address:	<input type="text" value="0.0.0.0"/>		

You can configure the possible alarm triggers for the unit (for example, the alarm inputs).

Alarm input 1 to Alarm input 10:

Select the **On** option to activate the alarm by the corresponding external alarm sensor. Otherwise, select **Off**.

Select **Active high** if the alarm is to be triggered by closing the contact. Select **Active low** if the alarm is to be triggered by opening the contact.

Name:

You can enter a name for each alarm input, which is then displayed below the icon for the alarm input on the **LIVEPAGE** if configured correctly (see **Livepage configuration**, page 112).

Video loss alarm:

Activate the checkbox if you want an interruption of the video signal to trigger an alarm. A selected video input is indicated by a check mark.

**Note**

The numbering is the same as the labeling of the video inputs on the rear panel of the unit.

1. SNMP host address / 2. SNMP host address:

The unit supports the SNMP (Simple Network Management Protocol) for managing and monitoring network components and can send SNMP messages to IP addresses. It supports SNMP MIB II and its traps in their full functionality in the unified code. If you wish to send SNMP traps, enter the IP addresses of one or two required target devices here. UDP Port 161 is generally used as the port for the SNMP functionalities.

Alarm connections

Alarm connections

Connect on alarm:

Number of destination IP address:

Destination IP address:

Destination password:

Auto-connect:

Default camera:

You can select how the unit responds to an alarm. In the event of an alarm, the unit can automatically connect to a pre-defined IP address. You can enter up to ten IP addresses to which the unit will connect in sequence in the event of an alarm, until a connection is made. You can also select which camera image should automatically be shown first on the receiver in the event of an alarm.

Connect on alarm:

Select **On** so that the unit automatically connects to a predefined IP address in the event of an alarm.

Note

Dual Streaming compatible units only: Stream 2 is always transferred for alarm connections. Bear this fact in mind when assigning the profile (see page 34).

Number of destination IP address:

Specify the numbers of the IP addresses to be contacted in the event of an alarm. The unit contacts the remote stations one after the other in the numbered sequence until a connection is made.

Destination IP address:

For each number, enter the corresponding IP address for the desired remote station.

Destination password:

If the remote station is password protected, enter the password here.

Auto-connect:

Select the **On** option to automatically re-establish a connection to one of the previously specified IP addresses after each restart, after a connection breakdown or after a network failure.

**Note**

Dual Streaming compatible units only: Stream 2 is always transferred for alarm connections. Bear this fact in mind when assigning the profile (see page 34).

Default camera:

Here you can select the camera whose image will be automatically displayed first on the receiver when the alarm connection is made. Depending on the system configuration, the receiver can then select the other cameras as well.

**Note**

The numbering is the same as the labeling of the video inputs on the rear panel of the unit.

Network settings



Here you can specify network addresses and configure multiple connections.

Network

Network		
Unit IP address:	<input type="text" value="192.168.0.88"/>	Reboot after 'Set' necessary!
Subnet mask:	<input type="text" value="255.255.255.0"/>	Reboot after 'Set' necessary!
Gateway IP address:	<input type="text" value="0.0.0.0"/>	Reboot after 'Set' necessary!
Ethernet link type:	<input type="text" value="Auto"/>	
Dynamic DNS server IP address:	<input type="text" value="0.0.0.0"/>	
Dynamic DNS contact interval:	<input type="text" value="30"/> (30...86,400 sec)	<input type="button" value="Set"/>

The settings in this screen are used to integrate the unit into an existing network.



Caution

Changes to the IP address, subnet mask or gateway address are transferred to the unit by clicking **Set**. However, they only take effect after the unit is restarted.

- Click **Set** after entering a new IP address.
- Enter the old IP address followed by `/reset` (for example `192.168.0.88/reset`) in your Web browser's address bar. The unit restarts and can then only be accessed at the new IP address.

Unit IP address:

Enter the desired IP address for the unit. The IP address must be valid for the network.

Subnet mask:

Enter the appropriate subnet mask for the selected IP address here.

Gateway IP address:

If you want the unit to establish a connection to a remote location in a different subnet, enter the IP address of the gateway here. Otherwise leave the box blank (0.0.0.0).

Ethernet link type:

If the unit is connected to the network via a switch, both must have the same default for the type of network connection. If necessary, ask your network administrator what value the switch is set to.

The **Auto** setting automatically detects the network connection. If necessary, you can specify the value 10 or 100 MBit/s for full or half-duplex mode (**FD** or **HD**) or 1 GBit/s FD.

**Caution**

Malfunctions such as image faults can occur if the network does not have enough capacity to transmit the maximum data rate generated by the unit.

Dynamic DNS server IP address:

When operating a unit on the Internet, dynamic addresses are used to ensure efficient use of the available IP address pool. That is, the unit is reassigned a (changing) IP address each time a new connection is made. Access is easier if the unit is listed in a DNS server. It registers there at regular intervals and leaves the unit name and its IP address. If you wish to establish an Internet connection to a unit, it is sufficient to enter the appropriate unit name together with the URL of the DNS server. This then reports on the current Internet IP address used to establish the connection.

Dynamic DNS contact interval:

Enter the desired refresh interval in seconds here.

Multicasting

Multicasting

Multicast address video 1:	<input type="text" value="0.0.0.0"/>	Multicast port 1:	<input type="text" value="60200"/>	Streaming
Multicast address video 2:	<input type="text" value="0.0.0.0"/>	Multicast port 2:	<input type="text" value="60400"/>	<input type="checkbox"/>
Multicast address video 3:	<input type="text" value="0.0.0.0"/>	Multicast port 3:	<input type="text" value="60600"/>	<input type="checkbox"/>
Multicast address video 4:	<input type="text" value="0.0.0.0"/>	Multicast port 4:	<input type="text" value="60800"/>	<input type="checkbox"/>
Multicast address video 5:	<input type="text" value="0.0.0.0"/>	Multicast port 5:	<input type="text" value="61000"/>	<input type="checkbox"/>
Multicast address video 6:	<input type="text" value="0.0.0.0"/>	Multicast port 6:	<input type="text" value="61200"/>	<input type="checkbox"/>
Multicast address video 7:	<input type="text" value="0.0.0.0"/>	Multicast port 7:	<input type="text" value="61400"/>	<input type="checkbox"/>
Multicast address video 8:	<input type="text" value="0.0.0.0"/>	Multicast port 8:	<input type="text" value="61600"/>	<input type="checkbox"/>
Multicast packet TTL:	<input type="text" value="16"/>			
Multicast address audio:	<input type="text" value="0.0.0.0"/>	Multicast port 1:	<input type="text" value="55000"/>	<input type="button" value="Set"/>

MPEG-4 Stream 1
MPEG-4 Stream 2

In addition to a 1:1 connection between an encoder and a single receiver (unicast), the unit can enable multiple receivers to receive the video signal from an encoder simultaneously. The device either duplicates the data stream itself and then distributes it to multiple receivers (Multi-unicast) or it sends a single data stream to the network, where the data stream is simultaneously distributed to multiple receivers in a defined group (Multicast). For each of the eight encoders, you can enter a separate multicast address and the relevant port for each stream.

For Dual Streaming compatible units, you can toggle between the streams by clicking the appropriate tab pages.

Note

Multicast operation requires a multicast-enabled network that uses the UDP and the Internet Group Management IGMP protocols. Other group management protocols are not supported. The TCP protocol does not support multicast connections.

A special IP address (class D address) must be configured for multicast operation in a multicast-enabled network.

The network must support group IP addresses and the Internet Group Management Protocol (IGMP V2). The address range is 224.0.1.0 to 239.255.255.255.

The multicast address can be the same for multiple streams. However, it will be necessary to use a different port in each case so that multiple data streams are not sent simultaneously using the same port and multicast address.

 **Note**

The settings must be made individually for each video input and, on Dual Streaming compatible units, for each stream. The numbering is the same as the labeling of the video inputs on the rear panel of the unit.

Multicast address video 1 to Multicast address video 8:

Enter a valid multicast address for each stream from the relevant encoder to be operated in multicast mode (duplication of the data streams in the network).

With the setting **0.0.0.0** the encoder for the relevant stream operates in multi-unicast mode (copying of data streams in the unit). The unit supports multi-unicast connections for up to five simultaneously connected receivers.

 **Note**

Duplication of data places a heavy demand on the unit and can lead to impairment of the image quality under certain circumstances.

Multicast port 1 to Multicast port 8:

Assign a different port to each data stream if there are simultaneous data streams at the same multicast address.

Enter the port address of the required stream here.

Streaming:

Click the checkbox to activate multicast streaming mode for the relevant stream. The selected check boxes are marked with a tick.

Multicast packet TTL:

You can enter a value to specify how long the multicast data packets are active on the network. This value must be greater than one if multicast is to be run via a router.

Multicast address audio: (audio versions only)

For special applications, you can enter a separate multicast address for the audio data stream.

 **Note**

Audio signals are only transmitted if the audio function is activated on the **Audio Stream** configuration page (see page 78).

Multicast port 1: (audio versions only)

Enter the port address of the separate audio stream here.

COM settings



You can configure the parameters of the **RS232/485** serial interface to meet your requirements. On audio versions, you can also configure the parameters of the second **RS232** serial interface.

COM1

COM1	
Serial port function:	<input type="text" value="Terminal"/>
Camera ID:	<input type="text" value="0"/>
Baud rate:	<input type="text" value="19200"/> Bit/s
Data bits:	<input type="text" value="8"/>
Stop bits:	<input type="text" value="1"/>
Parity check:	<input type="text" value="None"/>
Interface mode:	<input type="text" value="RS232"/>
Half-duplex mode:	<input type="text" value="Off"/>

Note

If the unit is working in multicast mode (see page 57 onward), the first remote location to establish a video connection to the unit is also assigned the transparent data connection. However, after about 15 seconds of inactivity the data connection is automatically terminated and another remote location can exchange transparent data with the unit.

Serial port function:

Select a controllable unit from the list. If you wish to use the serial port to transmit transparent data, select **Transparent**. Select **Terminal** if you wish to operate the unit from a terminal.

Note

After selecting a unit, the remaining parameters in the window are set automatically and should not be changed.

Camera ID:

If necessary, enter the ID of the peripheral you wish to control (for example a dome camera or pan/tilt head).

 **Note**

If you are using a Bosch AutoDome, remember that the value of the Camera ID must always be selected one less than the Bosch camera number (for example: Bosch camera number: 1, Camera ID: 0).

Baud rate:

Select the value for the transmission rate in bit/s.

Data bits:

The number of data bits per character cannot be changed.

Stop bits:

Select the number of stop bits per character.

Parity check:

Select the type of parity check.

Interface mode:

Select the desired protocol for the serial interface.

Half-duplex mode:

Choose the setting appropriate for your application.

COM2 (audio versions only)

COM2	
Serial port function:	Terminal
Baud rate:	19200 Bit/s
Data bits:	8
Stop bits:	1
Parity check:	None

Set

Serial port function:

Select the desired function from the list. If you wish to use the additional **RS232** serial interface (9-pin sub-D socket) to transmit transparent data, select **Transparent**. Select **Terminal** if you wish to operate the unit from a terminal.

Baud rate:

Select the value for the transmission rate in bit/s.

Data bits:

The number of data bits per character cannot be changed.

Stop bits:

Select the number of stop bits per character.

Parity check:

Select the type of parity check.

Configuration menu

The configuration menu allows you to configure all parameters of the unit. You can view the current settings by opening one of the configuration screens. You can change the settings by entering new values or by selecting a predefined value from a list field.

Navigation

You see the configuration menu as well as the unit overview when you click the **SETTINGS** link on the **LIVEPAGE**.

- Click one of the menu items in the left-hand margin of the window. The associated submenu opens.

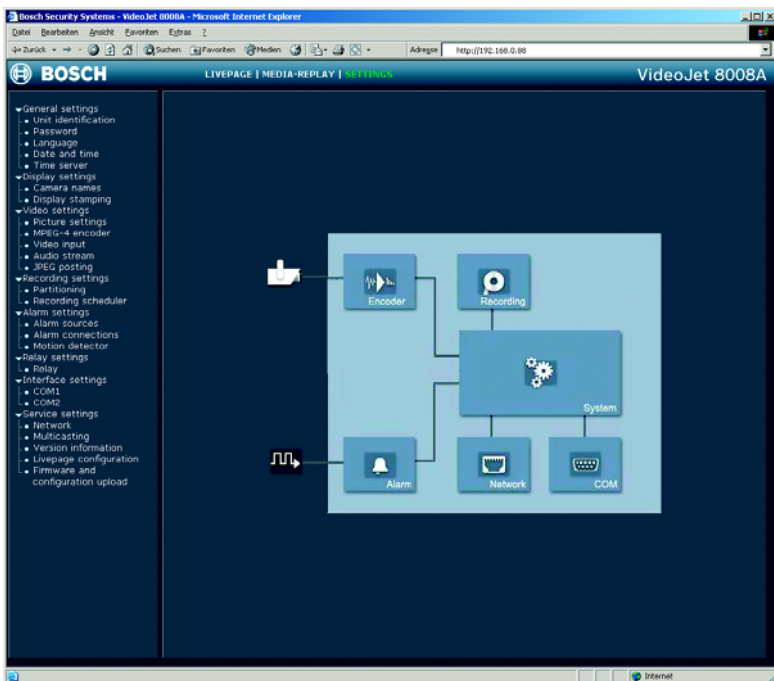

Note

The screen display can differ from that shown above, depending on the unit variants that you use.

- Click one of the links in the submenu. The Web browser opens the corresponding page.

Making changes

Each configuration screen shows the current settings. You can change the settings by entering new values or by selecting a predefined value from a list field.

- After each change, click **Set** to save the change.



Caution

Save each change with the associated **Set** button. Clicking the **Set** button saves the settings only in the current field. Changes in any other fields are ignored.

Unit identification

Unit identification	
Unit name:	<input type="text"/>
Unit ID:	<input type="text"/>
	<input type="button" value="Set"/>

You can give the unit a name and ID to make it easier to identify. They both simplify the management of multiple units in larger systems, for example using the VIDOS program.

Unit name:

Enter a name for the unit here.



Note

The unit name is used for the remote identification of a unit, in the event of an alarm, for example, or to make it easier to call up a unit when using a DNS server. Enter a name that makes it as easy as possible to quickly identify the location.

Unit ID:

Every unit should be assigned a unique identifier that you enter here as an additional means of identification.

Password



The screenshot shows a web-based configuration interface for setting a password. It features a blue header with the title "Password". Below the header, there are three input fields: "User name:" with a dropdown menu showing "user", "Password:" with a text box, and "Confirm password:" with a text box. To the right of the Password field, there is a red error message: "No 'user'-password set!". At the bottom right, there is a blue "Set" button.

A unit is generally protected by a password to prevent unauthorized access to the unit. You can use different authorization levels to limit access.

Note

Proper password protection is only guaranteed when all higher authorization levels are also protected with a password. If a **live** password is assigned, for example, a **service** and a **user** password must also be set. When assigning passwords, you should therefore always start from the highest authorization level.

User name:

The unit operates with three user names: **service**, **user** and **live**, which correspond to different authorization levels.

The **service** user name is the highest authorization level. After entering the correct password, this user name allows you to use all the functions of the unit and change all configuration settings.

The **user** user name is the middle authorization level. You use it to operate the unit and also to control cameras, for example, but you cannot change the configuration.

The **live** user name is the lowest authorization level. It can only be used to view the live video image and switch between the different live image displays.

Password:

You can define and change a separate password for each user name if you are logged in as **service** or if the unit is not password protected.

Enter the password for the selected user name here.

Confirm password:

Enter the new password a second time to eliminate typing mistakes.

Note

The new password is only saved when you click the **Set** button. You should therefore click the **Set** button immediately after entering and confirming the password, even if you also wish to subsequently assign a password to another user name.

Language

Language	
Website language:	<input type="text" value="English"/> <input type="button" value="Set"/>

You can select the language of the user interface to make the unit easier to use.

Website language:

Select the desired language here.

Date and time

Date and time	
Date format:	<input type="text" value="Europe"/>
Unit date:	<input type="text" value="Sunday"/> , <input type="text" value="23"/> . <input type="text" value="10"/> . <input type="text" value="2005"/>
Unit time:	<input type="text" value="16"/> : <input type="text" value="52"/> : <input type="text" value="54"/> <input type="button" value="Synchr. PC"/> <input type="button" value="Set"/>

If there are multiple devices operating in your system or network, it is important to synchronize their internal clocks. For example, it is only possible to identify and correctly evaluate simultaneous recordings when all units are operating on the same time.

Date format:

Select your required date format.

(**Europe**: DD.MM.YYYY; **USA**: MM.DD.YYYY; **Japan**: YYYY/MM/DD).

Unit date:

Enter the current date. Since the unit time is controlled by the internal clock, there is no need to enter the day of the week - it is added automatically.

Unit time:

Enter the current time or click the **Synchr. PC** button to copy your computer's system time to the unit.

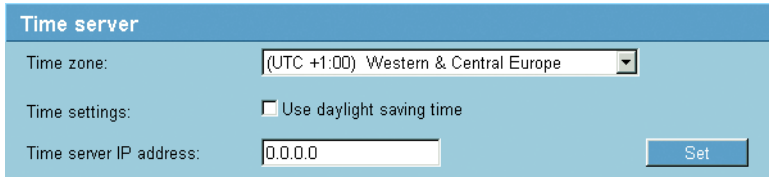
Time server

The screenshot shows a configuration window titled "Time server" with a light blue background. It contains three rows of settings:

- Time zone:** A dropdown menu showing "(UTC +1:00) Western & Central Europe".
- Time settings:** A checkbox labeled "Use daylight saving time" which is currently unchecked.
- Time server IP address:** A text input field containing "0.0.0.0" and a blue "Set" button to its right.

The unit can receive the time signal of a time server via the Time Server Protocol (RFC 868) and set the internal clock accordingly. The unit polls the time signal automatically every ten minutes.

Time zone:

Select the time zone in which your system is located.

Time settings:

Check this box during daylight saving time to include the time change. Deactivate the box again to return to winter time.

Time server IP address:

Enter the IP address of a time server that uses the RFC 868 protocol.

Camera names

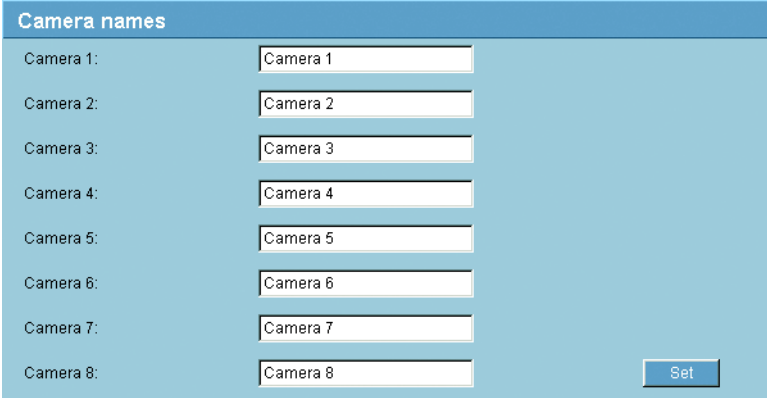

Camera names	
Camera 1:	<input type="text" value="Camera 1"/>
Camera 2:	<input type="text" value="Camera 2"/>
Camera 3:	<input type="text" value="Camera 3"/>
Camera 4:	<input type="text" value="Camera 4"/>
Camera 5:	<input type="text" value="Camera 5"/>
Camera 6:	<input type="text" value="Camera 6"/>
Camera 7:	<input type="text" value="Camera 7"/>
Camera 8:	<input type="text" value="Camera 8"/>

The camera name makes it easier to identify the remote camera location, in the event of an alarm for example. It will be displayed in the video screen if configured to do so (see page 69). The camera name is also used by VIDOS, the program for managing video surveillance systems, and makes it easier to identify the camera there.

Camera 1 to Camera 8:

Enter a unique and clear description as the camera name.



Note

The numbering is the same as the labeling of the video inputs on the rear panel of the unit.

Display stamping

Display stamping

Camera name stamping:	<input type="text" value="Off"/>
Time stamping:	<input type="text" value="Off"/>
Alarm mode stamping:	<input type="text" value="Off"/>
Displayed alarm message:	<input style="width: 80%;" type="text"/> (max. 31 characters)
Video watermarking:	<input type="text" value="Off"/>

Various overlays or “stamps” in the video image provide important supplementary information. These overlays can be enabled individually and are arranged on the image in a clear manner.

Note

The settings on this page apply to all camera inputs.

Camera name stamping:

This field sets the position of the camera name overlay. It can be displayed at the **Top**, at the **Bottom** or at a position of your choice that you can then specify using the **Custom** option. Or it can be set to **Off** for no overlay information.

Time stamping:

This field sets the position of the time overlay. It can be displayed at the **Top**, **Bottom** or at a position of your choice that you have previously defined via HyperTerminal using the **Custom** option. Or it can be set to **Off** for no overlay information.

Alarm mode stamping:

Choose **On** to display a text message overlay in the event of an alarm. It can be displayed at a position of your choice that you can then specify using the **Custom** option. Or it can be set to **Off** for no overlay information.

- Select the desired position from the lists.
- If you select the **Custom** option, additional fields are displayed where you can specify the exact position (**Position (XY):**).
- In the **Position (XY):** fields enter the values for the desired position.

Displayed alarm message:

Enter the message to be displayed for an alarm. The maximum text length is 31 characters.

Video watermarking:

Choose **On** if you wish the transmitted video images to be “watermarked”. After activation, all images are marked with a small green rectangle. A red rectangle indicates that the sequence (live or saved) has been manipulated.

Picture settings

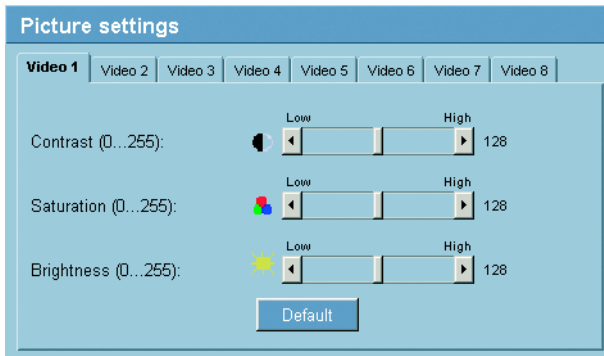

You can set the video image of each camera to suit your requirements. The current video image is displayed in the small window next to the slide controls as confirmation. Your changes are effective immediately.

- Click a tab to select the corresponding camera.
- Set the slide bar to the desired position.
- Click **Default** to reset all settings to their default value.

Contrast (0...255):

You can use this function to adapt the contrast of the video image to your working environment.

Saturation (0...255):

You can use this function to adjust the color saturation so as to make the reproduction of colors on your monitor as realistic as possible.

Brightness (0...255):

You can use this function to adapt the brightness of the video image to your working environment.

MPEG-4 encoder

For encoding the video signal, you can select a profile for each camera, and for Dual Streaming compatible units you can select two profiles each.

You can identify the Dual Streaming compatible units from the additional **MPEG-4 Stream 2** tab.

Selecting a profile

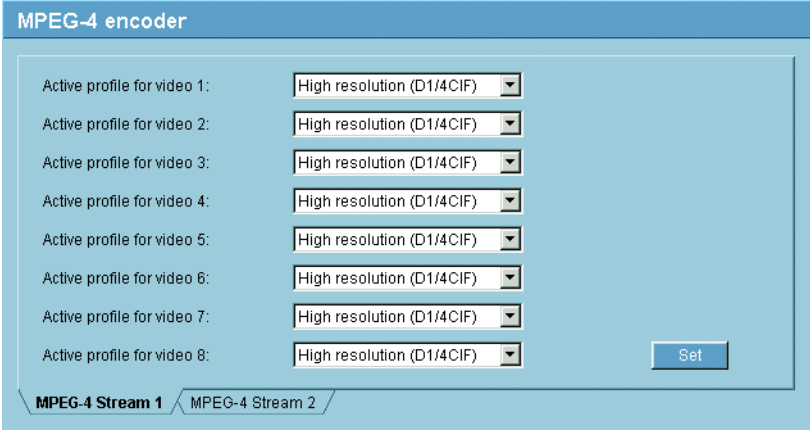

MPEG-4 encoder

Active profile for video 1: High resolution (D1/4CIF) ▼

Active profile for video 2: High resolution (D1/4CIF) ▼

Active profile for video 3: High resolution (D1/4CIF) ▼

Active profile for video 4: High resolution (D1/4CIF) ▼

Active profile for video 5: High resolution (D1/4CIF) ▼

Active profile for video 6: High resolution (D1/4CIF) ▼

Active profile for video 7: High resolution (D1/4CIF) ▼

Active profile for video 8: High resolution (D1/4CIF) ▼

Set

MPEG-4 Stream 1 / MPEG-4 Stream 2

You can configure the MPEG-4 data transmission in accordance with the operating environment (for example network structure, bandwidth, data load). For Dual Streaming compatible units, each encoder can create two data streams at the same time, with different compression settings, such as for transmission and local saving.

Note

The settings must be made individually for each camera input and stream. The numbering is the same as the labeling of the video inputs on the rear panel of the unit.

Pre-programmed profiles are available, each giving priority to different perspectives.

- **Profile 1: Low bandwidth (CIF)**
High quality for low bandwidth connections,
resolution 352 × 288/240 pixels
- **Profile 2: Low delay (1/2 D1)**
High quality with low delay,
resolution 352 × 576/480 pixels

- Profile 3: **High resolution (D1/4CIF)**
High resolution for high bandwidth connections,
resolution 704 × 576/480 pixels
- Profile 4: **DSL**
For DSL connections at 500 kBit/s,
resolution 352 × 288/240 pixels
- Profile 5: **ISDN (2B)**
For ISDN connections via two B channels,
resolution 352 × 288/240 pixels
- Profile 6: **ISDN (1B)**
For ISDN connections via one B channel,
resolution 352 × 288/240 pixels
- Profile 7: **Modem**
For analog modem connections at 20 kBit/s,
resolution 352 × 288/240 pixels
- Profile 8: **GSM**
For GSM connections at 9600 baud,
resolution 176 × 144/120 pixels

Active profile for video 1 to Active profile for video 8:

Here, you can select the desired profile.

- Dual Streaming compatible units only: Click a tab to select the relevant stream.
- Select the desired setting from the list.

Note

Dual Streaming compatible units only: For alarm connections and automatic connections, stream 2 is always transmitted. Bear this fact in mind when assigning the profile. Stream 2 is also used for local recording.

Note

When local recording is running, the profile set as the **recording profile** for the relevant video input is active (see page 45).

Changing profiles

Profile configuration

Profile 1
Profile 2
Profile 3
Profile 4
Profile 5
Profile 6
Profile 7
Profile 8

Profile name:

Target data rate: kBit/s

Max. data rate: kBit/s

P-frame video quality: High Low

I-frame video quality: High Low

I-frame distance:

Encoding interval:

Video resolution:

Reset of profile:

You can change individual parameter values within a profile and you can also change the name. You can switch between the profiles by clicking the appropriate tab.



Caution

The profiles are rather complex. They include a large number of parameters that interact with one another, so it is generally best to use the default profiles. Change the profiles only once you are fully familiar with all the configuration options.



Note

All parameters combine to make up a profile and are dependent on one another. If you enter a parameter that is outside the permitted range, the nearest permitted value will automatically be substituted when the settings are saved.

Profile name:

You can enter a new name for the profile here. The name is then displayed in the **MPEG-4-Encoder** field in the list of selectable profiles.

Target data rate:

You can limit the data rate for the unit to optimize utilization of the bandwidth in your network. The target data rate should be set according to the desired picture quality for typical scenes with no excessive motion.

For complex images or frequent changes of image content due to frequent movements, this limit can be temporarily exceeded up to the value you enter in the **Max. data rate** field.

Max. data rate:

This maximum data rate is not exceeded under any circumstances. Depending on the video quality settings for the I- and P-frames, this fact can result in individual images being skipped.

The value entered here should be at least 10% higher than the value entered in the **Target data rate** field.

P-frame video quality:

This setting allows you to adjust the image quality of the P-frames depending on the movement within the image. The **Auto** option automatically adjusts to the optimum combination of movement and image definition (focus). Selecting **Manual** allows you to set a value between 4 and 31 on the slide bar. The value **4** represents the best image quality with, if necessary, a lower frame refresh rate depending on the settings for the maximum data rate. A value of **31** results in a very high refresh rate and lower image quality.

I-frame video quality:

This setting allows you to adjust the image quality of the I-frames. The **Auto** option automatically adjusts the quality to the settings for the P-frame video quality. Selecting **Manual** allows you to set a value between 4 and 31 on the slide bar. The value **4** represents the best image quality with, if necessary, a lower frame refresh rate depending on the settings for the maximum data rate. A value of **31** results in a very high refresh rate and lower image quality.

I-frame distance:

This parameter allows you to set the intervals in which the I-frames will be coded. **0** means auto mode, whereby the video server inserts I-frames as necessary. An entry of **1** indicates that I-frames are continuously generated. An entry of **2** indicates that only every second image is an I-frame, and **3** only every third image etc.; the frames in between are coded as P-frames.

Encoding interval:

The figure selected here determines the interval at which images are encoded and transmitted. For example, entering **4** means that only every fourth image is encoded, the following three are skipped - this can be particularly advantageous with low bandwidths.

Video resolution:

Here you can select the desired resolution for the MPEG-4 video image. The following resolutions are available:

- **QCIF** 176 × 144/120 pixels
- **CIF** 352 × 288/240 pixels
- **1/2 D1** 352 × 576/480 pixels
- **2CIF** 704 × 288/240 pixels
- **D1/4CIF** 704 × 576/480 pixels

Reset of profile:

Click **Default** to return the profile to the factory default values.

Video input

Video input

Source type input 1:	<input type="text" value="Camera"/>
Source type input 2:	<input type="text" value="Camera"/>
Source type input 3:	<input type="text" value="Camera"/>
Source type input 4:	<input type="text" value="Camera"/>
Source type input 5:	<input type="text" value="Camera"/>
Source type input 6:	<input type="text" value="Camera"/>
Source type input 7:	<input type="text" value="Camera"/>
Source type input 8:	<input type="text" value="Camera"/>

Note

The numbering follows the labeling of the video inputs on the actual unit.

Source type input 1 to Source type input 8:

To allow video recorders to be connected as a video source, you can change the characteristic of the video source from the preset value of **Camera** to **VCR**. Video recorders require a more tolerant setting for the internal PLL as a result of jitter effects caused by the mechanical components of a video recorder.

Note

In some cases, selecting the **Video recorder** option can lead to an improvement in the video image even with a camera connected.

Audio stream (audio versions only)

Audio stream

Enable audio:

Audio input channel: Intercom use for input channel 8

Audio output channel: Output 8 Intercom Stereo out

The audio version of the unit has several audio ports for audio line signals as well as a microphone input and loudspeaker output.

The audio signals are transmitted two-way and in sync with the video signals. When transmitting audio signals, a maximum of one input and one output current is possible at the same time. However, several audio outputs can be connected with the same audio stream.

Here you can select the audio input and audio output that will be used.

Enable audio:

The audio signals are sent in a separate data stream parallel to the video data, and so increase the network load. The audio data are encoded according to G.711 and require an additional bandwidth of approx. 80 kBit/s per direction for each connection. Select **On** if you wish to enable the audio function.

Audio input channel:

Note

The numbering follows the labeling of the audio sockets on the unit.

- Select the desired audio input from the list.
- Select audio input **8** from the list and check the **Intercom use for input channel 8** box to select the station input **AI** (terminal connector).

Audio output channel:

Note

The numbering follows the labeling of the audio sockets on the unit. You can connect outputs **Audio 8 (Output 8)**, **AO (Intercom)** and **Audio Out (Stereo out)** to the same audio stream simultaneously.

- Select the desired audio output from the list.
- Select audio output **8** from the list and check the **Intercom** box to select the station output **AO** (terminal connector).
- Select audio output **8** from the list and check the **Stereo out** box to select the **Audio Out** output via the stereo socket.
- Deactivate the **Output 8** box if the **Audio 8** output is not to be connected.

JPEG posting

JPEG posting

JPEG format:

File name:

JPEG posting interval: sec (0 = OFF)

FTP server IP address:

FTP login name:

FTP password:

Path on FTP server:

Send JPEG from camera: 1 2 3 4 5 6 7 8

You can save individual JPEG images on an FTP server at certain intervals. You can then retrieve these images at a later date to reconstruct alarm events if required.

JPEG format:

Select the resolution you wish the JPEG images to have:

- **S** 176 × 144 pixels (QCIF)
- **M** 352 × 288 pixels (CIF)
- **XL** 704 × 576 pixels (4CIF)

File name:

You can select which file names will be created for the individual images which are transmitted.

- **Overwrite:** The same file name is always used and any existing file will be overwritten with the current file.
- **Increment:** A number from 000 to 255 is added to the file name and automatically incremented by 1. When it reaches 255 it starts again from 000.
- **Date/time suffix:** The date and time are automatically added to the file name. When setting this parameter, ensure that the unit's date and time are always correctly set. Example: the file snap011005_114530.jpg was stored on October 1, 2005 at 11.45 and 30 seconds.

JPEG posting interval:

Enter the interval in seconds at which the images will be sent to an FTP server. Enter zero if you do not want any images to be sent.

FTP server IP address:

Enter the IP address of the FTP server on which you wish to save the JPEG images.

FTP login name:

Enter your login name for the FTP server.

FTP password:

Enter the password that gives you access to the FTP server.

Path on FTP server:

Enter the exact path on which you wish to post the images on the FTP server.

Send JPEG from camera:

Click the check box to activate the camera input for the JPEG image. An enabled camera input is indicated by a check mark.

Partitioning

Partitioning

Partition Name	Number	Quality	Type	Size (MByte)
Camera 1	01	Low bandwidth (CIF)	Ring mode	19620
Camera 2	02	Low bandwidth (CIF)	Ring mode	19620
Camera 3	03	Low bandwidth (CIF)	Ring mode	19620
Camera 4	04	Low bandwidth (CIF)	Ring mode	19620
Camera 5	05	Low bandwidth (CIF)	Ring mode	19620
Camera 6	06	Low bandwidth (CIF)	Ring mode	19620
Camera 7	07	Low bandwidth (CIF)	Ring mode	19620
Camera 8	08	Low bandwidth (CIF)	Ring mode	19620

Create partition
Delete partition
Edit partition

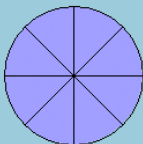
Total memory:	156966.0	MByte(s)		<div style="font-size: 0.8em; margin: 0;"> partitioned unpartitioned </div>
Number of partitions:	8 of 8 partitions created			
Partitioned memory:	156960.0	MByte(s)		
Unpartitioned memory:	6	MByte(s)		

Set

Eight partitions can be set up for the unit's hard drive, in a similar manner to the partitioning often found on computer hard drives. Parameters such as size, quality and type of video recording or compression standard used can be specified for each partition. Modifying these parameters leads to reorganization, during which stored data is lost.

The unit requires a dedicated partition for the recordings of each connected camera. Each partition is linked to its own encoder or camera input: camera input **Video 1** with partition number **01**, camera input **Video 2** with partition **02** etc. This assignment cannot be modified. As a result, all numbers are always displayed in the list, regardless of whether a corresponding partition is available or has been deleted. For recording from eight cameras, it is necessary to configure all eight possible partitions. Eight partitions are already preset in the default configuration.

All partitions are listed in the table on the **Partitioning** page together with their partition name, number, quality type and size.

In addition, the page provides you with an overview of the drive data, for example total memory, number of partitions created and the partitioned and unpartitioned memory space. A pie chart indicates how much memory space is partitioned for recordings.

Creating a partition



Caution

Modifications to the size or number of partitions lead to the entire hard drive being reorganized and the loss of all sequences stored on the drive. Consequently, you should check the recordings before any modification to the parameters mentioned and back up important sequences on the computer's hard drive.



Note

If the maximum number of eight partitions has been set up, you can only create a new partition after deleting at least one of the existing partitions (see page 86).

Creating a new partition is performed using separate help windows in which information is presented to you and you are led step by step through the necessary settings.

The process must be completed for each partition to be set up on the hard drive. After starting up the wizard, you can select the total number of partitions to be set up. The wizard is then automatically started up as often as necessary to configure all the partitions.



Note

You can create multiple partitions of the same type in one process. To do this, check the **Apply same settings for all new partitions** box in the first window of the wizard.

- Click the **Create partition** button to start the wizard for creating partitions. The first window of the wizard opens.

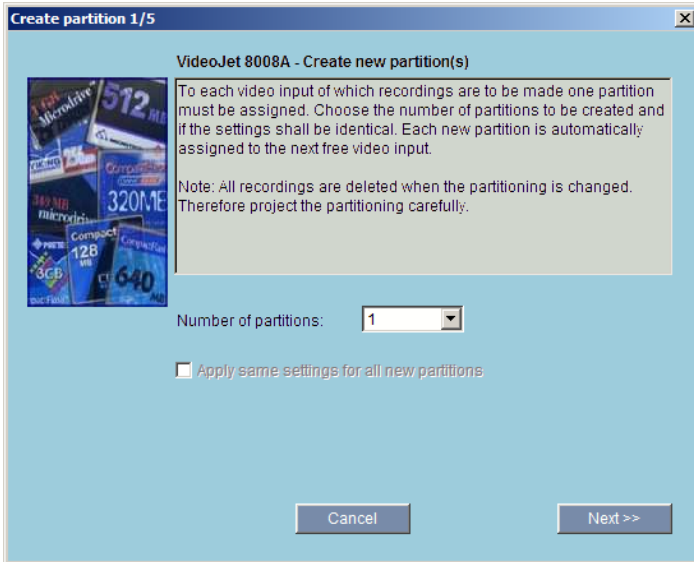

- You should always first read the information text in the upper section of the window.
- Click in the text fields to enter values or use the other controls that are available, such as buttons, checkboxes or list fields.
- Click the **Next>>** button at the bottom of the window to continue with the next step.
- Click the **<<Back** button at the bottom of the window to view the previous step again.
- Click the **Cancel** button to cancel the process and close the wizard.

Making changes

After you have made all necessary settings, you must transfer the settings to the unit and save them. To do this, you need to close the wizard in the last window using the **Finish** button.



Caution

All modifications to settings are only effective if you complete the configuration in the last window of the wizard by clicking **Finish**.

- Switch to the last window of the wizard if necessary.
- Click **Finish** to complete the configuration. All settings are now transferred to the unit and subsequently become effective.

Editing a partition

Partition name: Camera 1

Video input: 1 Stream 2

Recording type: Ring mode

Recording profile: Low bandwidth (CIF)

Number of alarmtracks: 0

Recording duration: 0 sec Pre-alarm 0 sec Post-alarm

Partition total size: 19620 MByte(s)

Remaining for recording: 2 day(s) 15 hour(s) 8 minute(s)

Free space on partition: 19404 MByte(s)

Unpartitioned memory: 6 MByte(s)

Note: This partition will be re-organized if any properties on this partition are changed. Previous recordings on this partition will be lost. Please backup the video data first.

Cancel Set

You can modify the configuration of a partition at any time.



Caution

All modifications result in the reorganization of the partition and the loss of all sequences on this partition.

Changes to the size of a partition (**Partition total size**) lead to the entire hard drive being reorganized and the loss of all sequences stored on the drive.

Consequently, you should back up all important sequences on the computer's hard drive before modifying the partition.

You can perform the required modifications in the **Partition properties** window.

- In the list, click the partition that you want to modify in order to select this partition.
- Click the **Edit partition** button. A new window with the entries for the selected partition is opened.
- Make the desired changes.
- Click the **Set** button to save the modifications.
- After closing the window, click the **Set** button in the main window to transfer the changes to the unit and to save them.

Deleting a partition

You can delete a partition at any time.



Caution

Deleting a partition leads to the entire hard drive being reorganized and the loss of all sequences stored on the drive. Consequently, you should check the recordings before deleting any partitions and back up important sequences on the computer's hard drive.

- Click a partition in the list in order to select the partition.
- Click the **Delete partition** button to delete the highlighted partition. The line containing the associated number remains in the display. Only the partition name is deleted and the size is indicated as 0.
- Click the **Set** button to transfer the changes to the unit and to save them.

Recording scheduler

Here, you can set all parameters for recording on the local hard drive. Recording can be performed continuously or only in the case of an alarm.



Partition:

Select the partition in which you want to record. Recording is performed for every video input in a separate partition.

Activating a partition for recording

After configuration, you can activate the partition for recording by clicking the **Start** button.

After starting, the Time recording, Alarm recording and Properties pages for the activated partition are displayed in gray and the configuration cannot be modified.

The graphic in the lower section of the pages indicates this partition's recording activity. You will see an animated graphic while recording is taking place. You can terminate recording at any time and deactivate one, multiple or all partitions.

- Click the **Start** button to activate the currently selected partition for recording.
- Click the **Start all** button to activate all the partitions set up for the recording.
- Click the **Stop** button to deactivate the currently selected partition for recording. Recordings that are currently running will be interrupted and the configuration can be modified.
- Click the **Stop all** button to deactivate all the partitions set up for the recording. Running recordings are interrupted and the configuration can be changed.

Time recording

You can specify the times during which continuous recording to the hard drive should take place.

Separate selection fields per partition are available for each day of the week, allowing settings to be made per camera input. You can select up to 16 individual recording time intervals for each day of the week.

Note

If a time interval has already been selected for alarm recording, you cannot select it for time recording (see **Alarm recording**, page 90).

- Left-click the point in the schedule at which recording should start and hold the button down.
- Drag the selected field to the desired recording end and then release the mouse key.
- Right-click a highlighted time interval to delete it.
- Click the **Select all** button to highlight all time intervals.
- Click the **Clear** button to delete all highlighted time intervals.

Used filetracks on partition:

Within a partition, up to 128 filetracks are created automatically. Each new recording has its own track.

In **Linear mode** (see page 93), no more new recordings are made when the 128 tracks are written; old recordings must first be deleted. In **Ring mode**, the 129th recording is written in the first track again etc., so that the oldest recording is overwritten with the most recent recording.

Used space on partition:

This displays how much space is already used in the partition.

Free space on partition:

This displays how much space is still available in the partition.

Recording status:

The graphic indicates the recording activity in this partition. You will see an animated graphic while recording is taking place.

Alarm recording

The screenshot shows the 'Recording scheduler' window for 'Camera 1'. At the top, there are buttons for 'Stop', 'Start', 'Stop all', and 'Start all'. Below these are tabs for 'Time recording', 'Alarm recording', and 'Properties'. The main area is a weekly grid with time slots from 0:00 to 24:00. Below the grid, there are several settings:

- Number of alarmtracks: 0
- Pre-alarm duration: 0 sec
- Post-alarm duration: 0 sec
- Used alarmtracks on partition: 0 / 0
- Used space on partition: 1 %
- Free space on partition: 19424 MByte(s)
- Recording status:

Buttons for 'Select all', 'Clear', and 'Set' are also present.

Here, you can specify the times during which continuous recording to the hard drives should take place in the event of an alarm.

As with time recording, there are separate selection fields for each partition and thus for each camera input. You can select up to 16 separate periods for each day of the week. Alarm recording occurs only during the highlighted time intervals.

Note

If a time interval has already been selected for time recording, you cannot select it for alarm recording (see **Time recording**, page 88).



Caution

Alarm tracks must be set up in the required partition for alarm recording (see **Number of alarm tracks**, page 91).

The unit uses a special recording mode during alarm recording for optimal usage of storage capacity: as soon as a time gap for alarm recording begins, a recording is continuously made on one segment, which is the size of a complete alarm sequence (pre- and post-alarm time).

This segment in the partition functions in a similar manner to a ring buffer and is overwritten until an alarm is actually triggered. Recording occurs on the segment only for the duration of the preset post-alarm time and a new segment subsequently used in the same manner.

This ensures that the alarm recorded is always secured for its entire duration and the space required to save each alarm recording is easy to calculate.

Number of alarm tracks:

Select the number of alarm tracks to be used in the partition. One alarm event can be recorded in each alarm track. Accordingly, the number of alarms entered can be recorded and archived. A partition can contain a maximum of 128 alarm recordings.

If the **Ring mode** option (see page 93) is set for the partition, the latest alarm recordings are always saved in the preset number. If the **Linear mode** option is set for the partition, the recording stops as soon as all the alarm tracks have been written.

Pre-alarm duration:

Select the period to be covered by pre-alarm recording.

Post-alarm duration:

Select the period to be covered by alarm recording.

Used alarm tracks on partition:

This displays how many of the alarm tracks created have already been used.

Used space on partition:

This displays how much space is already used in the partition.

Free space on partition:

This displays how much space is still available in the partition.

Recording status:

The graphic indicates the recording activity in this partition. You will see an animated graphic while recording is taking place.

Properties

Recording scheduler

Partition: Camera 1

Time recording | Alarm recording | Properties

Partition name: Camera 1

Note: This partition will be re-organized if any properties on this partition are changed. Previous recordings on this partition will be lost. Please backup the video data first.

Video input: 1 Stream 2

Type of recording: Ring mode

Video recording: MPEG-4

Recording profile: Low bandwidth (CIF)

Alarm recording at:

Alarm input:
 1
 2
 3
 4
 5
 6
 7
 8
 9
 10

Motion alarm:
 1
 2
 3
 4
 5
 6
 7
 8

Video loss:
 1
 2
 3
 4
 5
 6
 7
 8

Partition total size: 19620 MByte(s)

Remaining for recording: 2 day(s)
15 hour(s)
8 minute(s)

Free space on partition: 19424 MByte(s)

Recording status:

Format
Set

You can view the current properties for the partition selected in each case directly in the recording scheduler and modify them if necessary. You can also activate the alarms that should trigger recording. Similarly, you can also select the profile for recording.



Caution

All modifications result in the reorganization of the partition and the loss of all sequences on this partition.

Consequently, you should back up all important sequences on the computer's hard drive.

Partition name:

You can enter a new name for the partition.

Video input:

The number of the associated video input and the stream used for the recording are displayed here. The numbering is the same as the labeling of the video inputs on the rear panel of the unit.

Note

On Dual Streaming compatible units, stream 2 is always used for the recording.

Type of recording:

Select the required recording type.

In the case of **Ring mode** the recording proceeds continuously. If the maximum hard drive space has been reached, the oldest recordings are automatically overwritten.

In the case of **Linear mode** the recording proceeds until the entire hard drive space is full. The recording is then stopped until old recordings have been deleted.

Video recording:

The recording format is displayed here for information.

Recording profile:

Select the profile that is to be active during recording. You can view and modify the parameters for the profile (see **MPEG-4 encoder**, from page 72).

Note

The recording profile can differ from the standard setting **Active profile** for the video input set and is only used during an active recording.

Alarm recording at:

You can select the alarm sensor that is to trigger a recording. You can also use the motion and video alarm for a camera to trigger the alarm recording by another camera.

Note

The alarm sensor must be active to be able to trigger the recording. The alarm inputs and video loss alarms are activated on the **Alarm sources** page (see page 95). The motion alarms are configured and activated for each camera on the **Motion detector** page (see page 99).

- Check the box for the alarm sensor that is to trigger a recording. The selected check boxes are marked with a tick.

**Note**

The numbers of the alarm input check boxes correspond to the labeling of the alarm inputs on the rear panel of the unit. The motion and video loss alarm numbers correspond to the labeling of the video inputs.

Partition total size:

This displays how much storage space the partition occupies on the hard drive.

Remaining for recording:

This displays the maximum remaining recording time. The value is automatically updated after the parameters have been modified.

Free space on partition:

This displays how much space is still available in the partition.

Recording status:

The graphic indicates the recording activity in this partition. You will see an animated graphic while recording is taking place.

Format

You can delete all recordings in a partition at any time.

**Caution**

Check the recordings before deleting and back up important sequences on the computer's hard drive.

- Click the **Format** button to delete all recordings on the currently selected partition.

Alarm sources

Alarm sources

Alarm input 1:	<input type="button" value="Off"/> <input type="button" value="Active high"/>	Name: <input type="text" value="Input 1"/>
Alarm input 2:	<input type="button" value="Off"/> <input type="button" value="Active high"/>	Name: <input type="text" value="Input 2"/>
Alarm input 3:	<input type="button" value="Off"/> <input type="button" value="Active high"/>	Name: <input type="text" value="Input 3"/>
Alarm input 4:	<input type="button" value="Off"/> <input type="button" value="Active high"/>	Name: <input type="text" value="Input 4"/>
Alarm input 5:	<input type="button" value="Off"/> <input type="button" value="Active high"/>	Name: <input type="text" value="Input 5"/>
Alarm input 6:	<input type="button" value="Off"/> <input type="button" value="Active high"/>	Name: <input type="text" value="Input 6"/>
Alarm input 7:	<input type="button" value="Off"/> <input type="button" value="Active high"/>	Name: <input type="text" value="Input 7"/>
Alarm input 8:	<input type="button" value="Off"/> <input type="button" value="Active high"/>	Name: <input type="text" value="Input 8"/>
Alarm input 9:	<input type="button" value="Off"/> <input type="button" value="Active high"/>	Name: <input type="text" value="Input 9"/>
Alarm input 10:	<input type="button" value="Off"/> <input type="button" value="Active high"/>	Name: <input type="text" value="Input 10"/>
Video loss alarm:	<input type="checkbox"/> 1 <input type="checkbox"/> 2 <input type="checkbox"/> 3 <input type="checkbox"/> 4 <input type="checkbox"/> 5 <input type="checkbox"/> 6 <input type="checkbox"/> 7 <input type="checkbox"/> 8	
1. SNMP host address:	<input type="text" value="0.0.0.0"/>	
2. SNMP host address:	<input type="text" value="0.0.0.0"/>	<input type="button" value="Set"/>

You can configure the possible alarm triggers for the unit (for example, the alarm inputs).

Alarm input 1 to Alarm input 10:

Select the **On** option to activate the alarm by the corresponding external alarm sensor. Otherwise, select **Off**.

Select **Active high** if the alarm is to be triggered by closing the contact. Select **Active low** if the alarm is to be triggered by opening the contact.

Name:

You can enter a name for each alarm input, which is then displayed below the icon for the alarm input on the **LIVEPAGE** if configured correctly (see **Livepage configuration**, page 112).

Video loss alarm:

Activate the checkbox if you want an interruption of the video signal to trigger an alarm. The selected video inputs are marked with a tick.

 **Note**

The numbers of the check boxes correspond to the labeling of the video inputs on the rear panel of the unit.

1. SNMP host address / 2. SNMP host address:

The unit supports the SNMP (Simple Network Management Protocol) for managing and monitoring network components and can send SNMP messages to IP addresses. It supports SNMP MIB II and its traps in their full functionality in the unified code. If you wish to send SNMP traps, enter the IP addresses of one or two required target devices here. UDP Port 161 is generally used as the port for the SNMP functionalities.

Alarm connections

Alarm connections

Connect on alarm:

Number of destination IP address:

Destination IP address:

Destination password:

Auto-connect:

Default camera:

You can select how the unit responds to an alarm. In the event of an alarm, the unit can automatically connect to a pre-defined IP address. You can enter up to ten IP addresses to which the unit will connect in sequence in the event of an alarm, until a connection is made. You can also select which camera image should automatically be shown first on the receiver in the event of an alarm.

Connect on alarm:

Select **On** so that the unit automatically connects to a predefined IP address in the event of an alarm.

Note

Dual Streaming compatible units only: Stream 2 is always transferred for alarm connections. Bear this fact in mind when assigning the profile (see page 72).

Number of destination IP address:

Specify the numbers of the IP addresses to be contacted in the event of an alarm. The unit contacts the remote stations one after the other in the numbered sequence until a connection is made.

Destination IP address:

For each number, enter the corresponding IP address for the desired remote station.

Destination password:

If the remote station is password protected, enter the password here.

Auto-connect:

Select the **On** option to automatically re-establish a connection to one of the previously specified IP addresses after each restart, after a connection breakdown or after a network failure.

 **Note**

Dual Streaming compatible units only: Stream 2 is always transferred for alarm connections. Bear this fact in mind when assigning the profile (see page 72).

Default camera:

Here you can select the camera whose image will be automatically displayed first on the receiver when the alarm connection is made. Depending on the system configuration, the receiver can then select the other cameras as well.

 **Note**

The numbering is the same as the labeling of the video inputs on the rear panel of the unit.

Motion detector

Motion detector

Video 1 | Video 2 | Video 3 | Video 4 | Video 5 | Video 6 | Video 7 | Video 8

Detector: Off

Current video standard: PAL Alarm state: Off

Sensitivity: Low High 100

Min. object size: 4

Tamper protection

Global change %: 90

Scene too bright Scene too dark Scene too noisy

Select area Default Set

The unit has an integrated video sensor that can detect changes in the video signal on the basis of image processing. Such changes are due primarily to movements in the camera's field of view.

You can configure the video sensor for any encoder, i.e. for any connected camera.

The sensitivity of the video sensor can be adjusted, so that an alarm is generated only if specified values are exceeded. Various options for tamper protection allow you to set the reaction to tampering with cameras and video lines.

In order for the sensor to function, the following conditions must be met:

- The motion detector must be enabled.
- At least one sensor field must be activated.
- The individual parameters must be set for the operating environment and the desired responses configured.
- The sensitivity must be set to a value greater than zero.



Caution

Reflections of light (off glass surfaces etc.), switching lights on or off or changes in the light level caused by cloud movement on a sunny day can trigger unintended responses from the video sensor and generate false alarms. Run a series of tests at different times of the day and night to ensure that the video sensor is operating as intended.

For indoor surveillance, ensure constant lighting of the areas during the day and at night.

- Click one of the tabs to open the configuration of the corresponding encoder or camera.
- Enter the desired settings.
- If necessary, click the **Default** button to return all settings to their default values.

Detector:

Select **On** to activate the video sensor. The current video standard and the current alarm state are displayed.

Sensitivity

The basic sensitivity of the video sensor can be adjusted for the environmental conditions to which the camera is subject.

The sensor reacts to variations in the brightness of the video image. The darker the observation area, the higher the value that must be selected.

Min. object size

You can specify the number of sensor fields that a moving object must cover to generate an alarm. This is to prevent objects that are too small from triggering an alarm.

A minimum value of **4** is recommended. This value corresponds to four sensor fields.

Tamper protection

Various options for tamper protection allow you counteract typical attempts to tamper with cameras and video lines. Run a series of tests at different times of the day and night to ensure that the video sensor is operating as intended.

Global change %

You can define the percentage of sensor fields that must register a change simultaneously before generating an alarm. This setting is independent of the sensor fields selected under **Select area**.

This option allows you to counteract, independently of motion alarms, manipulation of the orientation or location of a camera resulting from turning the camera mounting bracket, for instance.

Scene too bright

Activate this function if tampering associated with exposure to extreme light (for instance, shining a flashlight directly on the objective) should trigger an alarm. The average brightness of the scene provides a basis for recognition.

Scene too dark

Activate this function if tampering associated with covering the objective (for instance, by spraying paint on it) should trigger an alarm. The average brightness of the scene provides a basis for recognition.

Scene too noisy

Activate this function if tampering associated with EMR interference (noisy scene due to strong interference signal in the vicinity of the video lines) should trigger an alarm.

Select area

The areas of the image to be monitored by the video sensor can be selected. The video image is subdivided into 858 square sensor fields. Each of these fields can be activated or deactivated individually. If you wish to exclude particular regions of the camera's field of view from monitoring due to continuous movement (by a tree in the wind, etc.), the relevant fields can be deactivated.

- Click **Select area** to configure the sensor fields. A new window will open.
- If necessary, click **Clear** first to clear the current selection (fields marked red).
- Left-click the fields to be activated. Activated fields are marked red.

- If necessary, click **Select all** to select the entire video frame for monitoring.
- Right-click any fields you wish to deactivate. “Inactive” fields are marked white.
- Click **OK** to save the configuration.
- Click the close button **X** in the window title bar to close the window without saving the changes.

Relay configuration (audio versions only)

The screenshot shows a window titled "Relay configuration" with a light blue background. It contains five columns of settings for individual relays. Each column has a label on the left and a control element on the right. The controls are: "Idle state" (dropdown menu), "Operating mode" (dropdown menu), "Relay follows" (dropdown menu), "Relay name" (text input field), and "Trigger relay" (button). A "Set" button is located at the bottom right of the window.

Label	Relay 1	Relay 2	Relay 3	Relay 4	Relay 5
Idle state:	Open	Open	Open	Open	Open
Operating mode:	Bistable	Bistable	Bistable	Bistable	Bistable
Relay follows:	Off	Off	Off	Off	Off
Relay name:	Relay	Relay	Relay	Relay	Relay
Trigger relay:	Relay	Relay	Relay	Relay	Relay

You can configure the switching behavior of the five relay outputs separately. For each relay, you can specify an open switch relay (normally closed contact) or a closed switch relay (normally open contact).

You can also specify whether the output should operate as a bistable or monostable relay. In bistable mode, the triggered state of the relay is maintained. In monostable mode, you can set the time after which the relay will return to the idle state.

You can select different events that automatically activate the output. It is possible, for example, to turn on a floodlight by triggering a motion alarm and then turning the light off again when the alarm has stopped.

Idle state:

Select **Open** if you want the relay to operate as an NO contact, or select **Closed** if the relay is to operate as an NC contact.

Operating mode:

Select an operating mode for the relay.

For example, if you want an alarm-activated lamp to stay on after the alarm ends, select **Bistable**. If you wish an alarm-activated siren to sound for 10 seconds, for example, select **10 sec**.

Relay follows:

If required, select a specific event that will trigger the relay. The following events are possible triggers:

■ Off

Relay is not triggered by events

■ Connection

Trigger whenever a connection is made

■ Video alarm 1

Trigger by interrupting the video signal at the **Video 1** input

■ Motion 1

Trigger by motion alarm at **Video 1** input

■ Local input 1

Trigger by external alarm input 1

■ Remote input 1

Trigger by remote station's switching contact (only if a connection exists)

Relay name:

You can assign a name for the relay here. The name is shown on the button next to **Trigger relay**. The Livepage can also be configured to display the name under the relay icon.

Trigger relay:

Click the button to trigger the relay manually (for testing or to operate a door opener, for example).

COM1

COM1

Serial port function:

Camera ID:

Baud rate: Bit/s

Data bits:

Stop bits:

Parity check:

Interface mode:

Half-duplex mode:

You can configure the parameters of the **RS232/485** serial interface to meet your requirements.

Note

If the unit is working in multicast mode (see page 57 onward), the first remote location to establish a video connection to the unit is also assigned the transparent data connection. However, after about 15 seconds of inactivity the data connection is automatically terminated and another remote location can exchange transparent data with the unit.

Serial port function:

Select a controllable unit from the list. If you wish to use the serial port to transmit transparent data, select **Transparent**. Select **Terminal** if you wish to operate the unit from a terminal.

Note

After selecting a unit, the remaining parameters in the window are set automatically and should not be changed.

Camera ID:

If necessary, enter the ID of the peripheral you wish to control (for example a dome camera or pan/tilt head).

Note

If you are using a Bosch AutoDome, remember that the value of the Camera ID must always be selected one less than the Bosch camera number (for example: Bosch camera number: 1, Camera ID: 0).

Baud rate:

Select the value for the transmission rate in bit/s.

Data bits:

The number of data bits per character cannot be changed.

Stop bits:

Select the number of stop bits per character.

Parity check:

Select the type of parity check.

Interface mode:

Select the desired protocol for the serial interface.

Half-duplex mode:

Choose the setting appropriate for your application.

COM2 (audio versions only)

COM2	
Serial port function:	Terminal
Baud rate:	19200 Bit/s
Data bits:	8
Stop bits:	1
Parity check:	None

Set

Serial port function:

Select the desired function from the list. If you wish to use the additional **RS232** serial interface (9-pin sub-D socket) to transmit transparent data, select **Transparent**. Select **Terminal** if you wish to operate the unit from a terminal.

Baud rate:

Select the value for the transmission rate in bit/s.

Data bits:

The number of data bits per character cannot be changed.

Stop bits:

Select the number of stop bits per character.

Parity check:

Select the type of parity check.

Network

Network		
Unit IP address:	<input type="text" value="192.168.0.88"/>	Reboot after 'Set' necessary!
Subnet mask:	<input type="text" value="255.255.255.0"/>	Reboot after 'Set' necessary!
Gateway IP address:	<input type="text" value="0.0.0.0"/>	Reboot after 'Set' necessary!
Ethernet link type:	<input type="text" value="Auto"/>	
Dynamic DNS server IP address:	<input type="text" value="0.0.0.0"/>	
Dynamic DNS contact interval:	<input type="text" value="30"/> (30...86,400 sec)	<input type="button" value="Set"/>

The settings in this screen are used to integrate the unit in an existing network.



Caution

Changes to the IP address, subnet mask or gateway address are transferred to the unit by clicking **Set**. However, they only take effect after the unit is restarted.

- Click **Set** after entering a new IP address.
- Enter the old IP address followed by `/reset` (for example `192.168.0.88/reset`) in your Web browser's address bar. The unit restarts and can then only be accessed at the new IP address.

Unit IP address:

Enter the desired IP address for the unit. The IP address must be valid for the network.

Subnet mask:

Enter the appropriate subnet mask for the selected IP address here.

Gateway IP address:

If you want the unit to establish a connection to a remote location in a different subnet, enter the IP address of the gateway here. Otherwise leave the box blank (0.0.0.0).

Ethernet link type:

If the unit is connected to the network via a switch, both must have the same default for the type of network connection. If necessary, ask your network administrator what value the switch is set to.

The **Auto** setting automatically detects the network connection. If necessary, you can specify the value 10 or 100 MBit/s for full or half-duplex mode (**FD** or **HD**) or 1 GBit/s FD.

**Caution**

Malfunctions such as image faults can occur if the network does not have enough capacity to transmit the maximum data rate generated by the unit.

Dynamic DNS server IP address:

When operating a unit on the Internet, dynamic addresses are used to ensure efficient use of the available IP address pool. That is, the unit is reassigned a (changing) IP address each time a new connection is made. Access is easier if the unit is listed in a DNS server. It registers there at regular intervals and leaves the unit name and its IP address. If you wish to establish an Internet connection to a unit, it is sufficient to enter the appropriate unit name together with the URL of the DNS server. This then reports on the current Internet IP address used to establish the connection.

Dynamic DNS contact interval:

Enter the desired refresh interval in seconds here.

Multicasting

Multicasting

Multicast address video 1:	<input type="text" value="0.0.0.0"/>	Multicast port 1:	<input type="text" value="60200"/>	Streaming <input type="checkbox"/>
Multicast address video 2:	<input type="text" value="0.0.0.0"/>	Multicast port 2:	<input type="text" value="60400"/>	<input type="checkbox"/>
Multicast address video 3:	<input type="text" value="0.0.0.0"/>	Multicast port 3:	<input type="text" value="60600"/>	<input type="checkbox"/>
Multicast address video 4:	<input type="text" value="0.0.0.0"/>	Multicast port 4:	<input type="text" value="60800"/>	<input type="checkbox"/>
Multicast address video 5:	<input type="text" value="0.0.0.0"/>	Multicast port 5:	<input type="text" value="61000"/>	<input type="checkbox"/>
Multicast address video 6:	<input type="text" value="0.0.0.0"/>	Multicast port 6:	<input type="text" value="61200"/>	<input type="checkbox"/>
Multicast address video 7:	<input type="text" value="0.0.0.0"/>	Multicast port 7:	<input type="text" value="61400"/>	<input type="checkbox"/>
Multicast address video 8:	<input type="text" value="0.0.0.0"/>	Multicast port 8:	<input type="text" value="61600"/>	<input type="checkbox"/>
Multicast packet TTL:	<input type="text" value="16"/>			
Multicast address audio:	<input type="text" value="0.0.0.0"/>	Multicast port 1:	<input type="text" value="55000"/>	<input type="button" value="Set"/>

MPEG-4 Stream 1
MPEG-4 Stream 2

In addition to a 1:1 connection between an encoder and a single receiver (unicast), the unit can enable multiple receivers to receive the video signal from an encoder simultaneously. The device either duplicates the data stream itself and then distributes it to multiple receivers (Multi-unicast) or it sends a single data stream to the network, where the data stream is simultaneously distributed to multiple receivers in a defined group (Multicast). For each of the eight encoders, you can enter a separate multicast address and the relevant port for each stream.

For Dual Streaming compatible units, you can toggle between the streams by clicking the appropriate tab pages.

Note

Multicast operation requires a multicast-enabled network that uses the UDP and the Internet Group Management IGMP protocols. Other group management protocols are not supported. The TCP protocol does not support multicast connections.

A special IP address (class D address) must be configured for multicast operation in a multicast-enabled network.

The network must support group IP addresses and the Internet Group Management Protocol (IGMP V2). The address range is 224.0.1.0 to 239.255.255.255.

The multicast address can be the same for multiple streams. However, it will be necessary to use a different port in each case so that multiple data streams are not sent simultaneously using the same port and multicast address.

 **Note**

The settings must be made individually for each video input and, on Dual Streaming compatible units, for each stream. The numbering is the same as the labeling of the video inputs on the rear panel of the unit.

Multicast address video 1 to Multicast address video 8:

Enter a valid multicast address for each stream from the relevant encoder to be operated in multicast mode (duplication of the data streams in the network).

With the setting **0.0.0.0** the encoder for the relevant stream operates in multi-unicast mode (copying of data streams in the unit). The unit supports multi-unicast connections for up to five simultaneously connected receivers.

 **Note**

Duplication of data places a heavy demand on the unit and can lead to impairment of the image quality under certain circumstances.

Multicast port 1 to Multicast port 8:

Assign a different port to each data stream if there are simultaneous data streams at the same multicast address.

Enter the port address of the required stream here.

Streaming:

Click the checkbox to activate multicast streaming mode for the relevant stream. The selected check boxes are marked with a tick.

Multicast packet TTL:

You can enter a value to specify how long the multicast data packets are active on the network. This value must be greater than one if multicast is to be run via a router.

Multicast address audio: (audio versions only)

For special applications, you can enter a separate multicast address for the audio data stream.

**Note**

Audio signals are only transmitted if the audio function is activated on the **Audio Stream** configuration page (see page 78).

Multicast port 1: (audio versions only)

Enter the port address of the separate audio stream here.

Version information

Version information	
Hardware version:	<input type="text" value="C0079143"/>
Firmware version:	<input type="text" value="15000150"/>

The hardware and firmware version numbers are for information only and cannot be changed. Keep a record of these numbers in case technical assistance is required.

Hardware version:

The hardware version number of the unit is displayed.

Firmware version:

The firmware version number of the unit is displayed.

Livepage configuration

Livepage configuration			
Logo URL:	<input type="text" value="Default"/>	<input type="button" value="Search"/>	
Device logo URL:	<input type="text" value="Default"/>	<input type="button" value="Search"/>	
Show alarm inputs:	<input checked="" type="checkbox"/>		
Show relay output:	<input checked="" type="checkbox"/>		
Show event log:	<input checked="" type="checkbox"/>		
Show system log:	<input checked="" type="checkbox"/>		
Save event log:	<input checked="" type="checkbox"/>		
Save system log:	<input checked="" type="checkbox"/>		
Path for event log:	<input type="text" value="C:\Event.txt"/>	<input type="button" value="Search"/>	
Path for system log:	<input type="text" value="C:\System.txt"/>	<input type="button" value="Search"/>	
Path for JPEG and MPEG files:	<input type="text" value="C:\"/>	<input type="button" value="Search"/>	<input type="button" value="Set"/>

In this window you can customize the appearance of the **LIVEPAGE** to suit your requirements. You can opt to have selected information and controls displayed in addition to the video image.

Individual background graphics can also be used for the main window and the upper part of the window (banner).

Note

You can use either GIF or JPEG images. The file paths must correspond to the access mode (for example `C:\Images\Logo.gif` for access to local files, or `http://www.mycompany.com/images/logo.gif` for access via the Internet/Intranet).

For access via the Internet/Intranet, ensure that a connection is always available to display the image to be displayed. The image file is not saved in the unit.

- Activate the checkboxes for the items you wish to have displayed on the **LIVEPAGE**. The selected items are indicated by a check mark.
- Go to the **LIVEPAGE** to check whether and how the required items are displayed.

Logo URL:

Enter the path to a suitable background graphic in this field. The image can be stored on a local computer, the local network or at an Internet address.

If necessary, click **Search** to find a suitable image on the local network.

Device logo URL:

Enter the path for a suitable image in the upper part of the window (banner). The image can be stored on a local computer, the local network or at an Internet address.

– If necessary, click **Search** to find a suitable image on the local network.

 **Note**

To restore the original graphics, simply delete the entries in the **Logo URL** and **Device logo URL** fields.

Show alarm inputs:

Alarm inputs are shown next to the video image as icons, along with their assigned names. If an alarm is active, the corresponding icon changes color.

Show relay outputs: (audio versions only)

Relay outputs are shown next to the video image as icons, along with their assigned names. If the relay is switched, the corresponding icon changes color.

Show event log:

The event messages are displayed along with the date and time in a field next to the video image.

Show system log:

The system messages are displayed along with the date and time in a field next to the video image and provide information about the establishing and ending connections, for example.

Save event log:

Check this option to save event messages in a text file on your local computer.

You can then view, edit and print this file with any text editor or the standard Office software.

Save system log:

Check this option to save system messages in a text file on your local computer.

You can then view, edit and print this file with any text editor or the standard Office software.

Path for event log:

Enter the path for saving the event log here.

- If necessary, click **Search** to find a suitable directory.

Path for system log:

Enter the path for saving the system log here.

- If necessary, click **Search** to find a suitable directory.

Path for JPEG and MPEG files:

Enter the path for saving individual images and video sequences that you can save from the **LIVEPAGE** or from the **MEDIA-REPLAY** page.

- If necessary, click **Search** to find a suitable directory.

Firmware and configuration upload

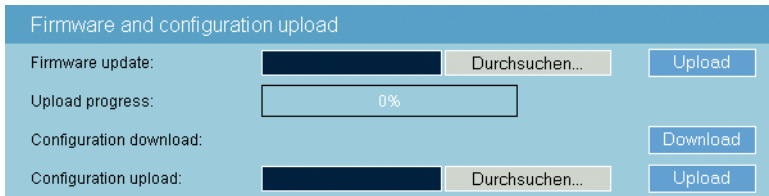

Firmware update:

The unit is designed so that its functions and parameters can be updated via firmware. To do this, transfer the current firmware package to the unit via the selected network. It will then be automatically installed there.

In this way, a unit can be serviced and updated remotely without a technician having to change the installation on site.

You obtain the current firmware from your customer service or from the download area on our Internet site.



Caution

Before launching the firmware update, make sure that you have selected the correct upload file. Uploading the wrong files can result in the unit no longer being addressable, in which case you must replace the unit.

You should never interrupt the installation of firmware. An interruption can lead to the flash-EPROM being incorrectly programmed. This in turn can result in the unit no longer being addressable, in which case it will have to be replaced.

- First, save the update file to your hard drive.
- Enter the full path for the update file in the field or click **Browse...** to locate and select the file.
- Next, click **Upload** to begin transferring the file to the unit. The progress bar allows you to monitor the transfer.

The new firmware is unpacked and the Flash EPROM is reprogrammed. The time remaining is shown in the message **going to reset. Reconnecting in ... seconds**. The unit restarts automatically once the upload has successfully completed.

If the **Fail** LED then flashes, the upload has failed and must be repeated. To perform the upload you must switch to a special page:

- In the address field of the browser, enter `/main.htm` (for example, `192.168.0.88/main.htm`).
- Repeat the upload.

Configuration download:

You can save configuration data for the unit on a computer and then load saved configuration data from a computer to the unit.

- Click the **Download** button. A dialog box opens.
- Follow the on-screen instructions to save the current settings.

Configuration upload:

- Enter the full path of the file to upload or click **Browse...** to select the required file.
- Make certain that the file to be loaded comes from the same unit type as the unit you want to configure.
- Next, click **Upload** to begin transferring the file to the unit. The progress bar allows you to monitor the transfer.

Once the upload is complete the new configuration is activated. The time remaining is shown by the message **going to reset Reconnecting in ... seconds**. The unit restarts automatically once the upload has successfully completed.

Function test

The unit offers a range of configuration options. You should therefore check that it is functioning correctly after installation and configuration.

The function test is the only way to ensure that the unit operates as expected in the event of an alarm.

Your check should include the following functions:

- Can the unit be called up remotely?
- Does the unit transmit all the data required?
- Does the unit react to alarms as desired?
- Is it possible to control peripherals if necessary?

6

Operation

Operation with Microsoft Internet Explorer

A computer with Microsoft Internet Explorer (version 6.0 or higher) can receive live images from the unit, control cameras or other peripherals and play back sequences stored on the local hard drive.

 **Note**

Make sure the graphics card is set to 16- or 32-bit color depth and that Microsoft Virtual Machine is installed and activated on your PC. If necessary, you can install the required software and controls from the product CD supplied (see **Components supplied**, page 9).

Instructions for using the Web browser can be found in its online help.

System requirements

- Microsoft Internet Explorer (version 6.0 or higher)
- Monitor resolution 1024 × 768 pixels
- Network access (Intranet or Internet)

 **Note**

Also note the information in the **System Requirements** document on the product CD supplied.

Installing MPEG ActiveX

 **Note**

Suitable MPEG ActiveX software must be installed on the computer to allow the live video images to be played back. If necessary, you can install the required software and controls from the product CD supplied (see **Components supplied**, page 9).

- Insert the CD into the computer's CD-ROM drive. If the CD does not start automatically, open the root directory of the CD in Windows Explorer and double click **MPEGAx.exe**.
- Follow the on-screen instructions.

Establishing the connection

To use the unit in your network, you must assign it an IP address that is valid in your network.

The following default address is preset at the factory: **192.168.0.1**

- Start the Web browser.
- Enter the unit's IP address as the URL. The connection is established and after a short time you will see the **LIVEPAGE** with the video image.



Note

The screen display can differ from that shown above, depending on the unit variants that you use.

The LIVEPAGE

Once the connection is established, the Web browser displays the **LIVEPAGE**. It shows the live video image on the right of the browser window. Depending on the configuration, various text overlays may be visible on the live video image (see **Display stamping**, page 69).

Other information may be shown next to the live video image on the Livepage. What is shown will depend on the settings you have made on the **Livepage configuration** screen (see page 112).

Note

If you do not connect, the device may have reached its maximum number of connections. The maximum number of connections depends on the unit and network configuration.

Protected unit

If the unit is password protected against unauthorized access, the Web browser displays a message to that effect and prompts you to enter the password when you call up access-protected areas.

Note

The unit offers the option of limiting access across various authorization levels (see pages 48 and 65).

- Enter the user name and associated password in the corresponding text fields.
- Click **OK**. If the password is entered correctly, the Web browser displays the page that was called up.

Image selection

You can view the image from each camera individually on a full screen.

- Click one of the **Camera 1** to **Camera 8** tabs above the video image to view the corresponding camera image.
- Click one of the **MPEG-4 Stream 1**, **MPEG-4 Stream 2** (only on Dual-Streaming-enabled units) or **M-JPEG** tabs below the video image to switch between the different displays for the camera image.

Camera control

The options for controlling peripheral devices (for example a pan/tilt camera head or a dome camera) are dependent on the unit type installed and on the configuration of the VIP X1600.

If a controllable unit is connected and configured, the operating items for controlling the peripheral device can be seen to the left of the video image.



- To control a peripheral, click the appropriate controls.
- Move the mouse cursor over the video image. Additional options for controlling peripherals are displayed with the mouse cursor.

Digital I/O



In the event of an alarm, the green alarm LED for the triggering alarm input appears next to the video image. The unit's configuration determines whether the alarm is displayed, as well as additional details (see **Livepage configuration**, page 112).

The alarm symbols **Input 1** to **Input 10** are for information purposes and show the input status of an alarm input: **Active high** = icon lit green, **Active low** = icon not lit.

Triggering relay (audio versions only)

With the relay on the audio versions, you can trigger different units (such as lamps or the door opener).

- To activate this, click the icon for the corresponding relay next to the video image. The icon will be red when the relay is activated.

System log / Event log

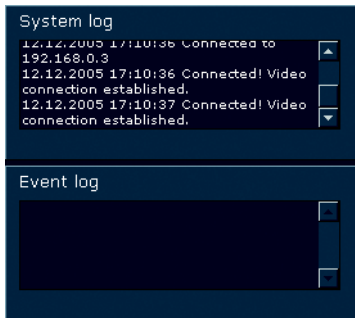

The **System log** field contains information about the operating status of the unit and the connection. You can save these messages automatically in a file (see page 114).

Events such as the triggering or end of alarms are shown in the **Event log** field. You can save these messages automatically in a file (see page 114).

Audio function (audio versions only)

Depending on the configuration, the unit can send and receive audio signals. All users who are connected by browsers receive the audio signals sent by the unit.

Only the user who first connected to the unit can send audio signals to the unit.

- On the **LIVEPAGE**, click anywhere next to the video image to remove the focus from the ActiveX.
- Press and hold the **F12** key to establish a voice connection with the unit. The browser's status bar displays the message **Send Audio ON**.
- Release the **F12** key if you no longer wish to send audio signals to the unit. The browser's status bar displays the message **Send Audio OFF**.

Note

If the browser connection that establishes voice contact with the unit is disconnected, the next user to establish a browser connection to the unit can send audio data to the unit.

Saving snapshots

You can save individual images from the video sequence currently shown on the **LIVEPAGE** in JPEG format on your computer's hard drive.

- Click the icon for saving single images. The image is saved at a resolution of 704 × 576 pixels (4CIF/D1). The storage location depends on the configuration of the unit (see page 114).



Recording video sequences

You can save sections of the video sequence currently shown on the **LIVEPAGE** on your computer's hard drive.

- Click the icon for recording video sequences to start recording. The storage location depends on the configuration of the unit (see page 114). The flashing red dot in the icon indicates that recording is in progress.



- Click the icon for recording video sequences again to stop recording.

Image resolution

The sequences will be recorded at the resolution specified in the encoder configuration (see pages 38 and 76).

Installing MPEG viewer

You can play back saved video sequences using the MPEG viewer from Bosch Security Systems, which can be found on the product CD supplied (see **Components supplied**, page 9).



Note

Suitable MPEG ActiveX software must be installed on the computer in order to play back saved video sequences using the MPEG viewer. Further information can be found on page 29.

- Insert the CD into the computer's CD-ROM drive. If the CD does not start automatically, open the CD in Windows Explorer.
- Open the **MPEG viewer** directory and copy the **MPEGViewer.exe** file to your computer's hard drive.
- If necessary, you can also start the MPEG viewer by double-clicking the **MPEGViewer.exe** file.

Running recording program

The hard drive icon below the MPEG video image on the **LIVEPAGE** changes during an automatic recording on the unit's hard drive by one of the saved programs.



The icon lights up green and displays a moving graphic to indicate a running recording. If no recording is taking place, a gray icon is displayed.

The MEDIA-REPLAY page

The integrated hard drive means the unit can be used as a digital video recorder for local long-term recording.

The **MEDIA-REPLAY** page for playing back recorded video sequences can be accessed from the **LIVEPAGE** and from **SETTINGS**.

- Click in the navigation bar in the upper section of the window on the **MEDIA-REPLAY** link. The playback page appears.

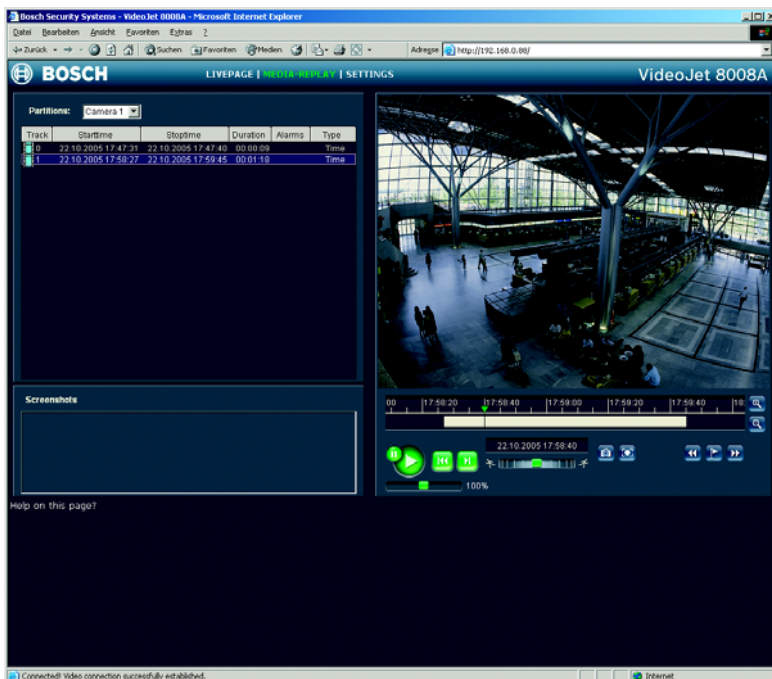

Note

The screen display can differ from that shown above, depending on the unit variants that you use.

Selecting recordings

In the left section of the page, first select the partition whose recordings you want to view.

All sequences that are saved in the partition are displayed in the list. A running number (track) is assigned to each sequence. Start time and stop time, recording duration, number of alarms, and recording type are displayed.

- Click a partition name from the list to display the recordings for this partition.
- Click a list entry. The playback for the selected sequence starts immediately in the video window.

Controlling a playback

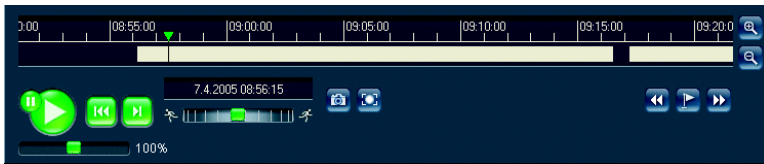

You will see a time bar below the video image for quick orientation. If a particular sequence has been clicked and selected for playback, the selected sequence appears in the list in blue with a green border. The associated time interval is displayed in the bar in gray. A green arrow above the bar indicates the position of the image currently being played back within the sequence.

The time bar offers various options for navigation in and between sequences.

- You can change the time interval displayed by moving the gray area to the left or right while holding down the mouse button.
- You can change the time interval displayed by clicking the zoom keys (magnifying glass icons). The display can span a range from two months to a few seconds.
- You can select a different sequence for playback by clicking the corresponding gray marking.

- If required, drag the green arrow to the point in time at which the playback should begin. Alternatively you can double-click directly in the gray time interval or in the timescale to jump to the position selected in this manner. The date and time display below the bar provides orientation to the second.

You can control playback by means of the buttons below the video image. The buttons have the following functions:



Start playback
or pause



Jump to the start of active video sequence or
to the previous sequence in the list



Jump to the end of active video sequence or
to the next sequence in the list

You can use the slide control to control playback speed and fast forward/rewind: positioning in the middle indicates playback at recording speed, left indicates rewind, and right fast forward. The fast forward or rewind speed changes, depending on how far you move the slide control toward the runner icons.



You can continuously select playback speed by means of the speed regulator:



Red bars within the gray sequence fields indicate the points in time where alarms were triggered. Drag the green arrow to navigate to these points quickly.

Bookmarks

In addition, you can set markers in the sequences, so-called bookmarks, and jump directly to these. These bookmarks are indicated as small yellow arrows above the time interval. Use the bookmarks as follows:



Jump to the previous bookmark



Set bookmark



Jump to the following bookmark

– Right-click a bookmark to delete it.



Note

Bookmarks are only valid if you remain on the **MEDIA-REPLAY** page; they are not saved with the sequences. As soon as you leave the page all bookmarks are deleted.

Backup

You can back up the videosequences or single images stored on the hard drive of the unit to the computer's hard drive.

First select the required sequence as described in the previous section. The following buttons are available for the backup:



Back up a sequence to the computer's hard drive



Back up a single image to the computer's hard drive

- Start playback of the sequence that you want to save either completely or partially on the computer's hard drive.
- Click the icon for the sequence backup. The backup starts immediately – this process is displayed by a flashing red dot in the icon.
- Click the sequence backup icon again to end the backup.

This procedure can be repeated many times within the sequence to back up multiple extracts from a longer sequence.

- Click the button for backing up a single image to back up only snapshots from the running sequence to your computer's hard drive.

The single images are displayed in the **Event log** area immediately after they are clicked.

The storage location for the sequences and single images can be specified in the configuration of the unit (see page 114).

Installing MPEG viewer

You can play back saved video sequences using the MPEG viewer from Bosch Security Systems, which can be found on the product CD supplied (see **Components supplied**, page 9).

Note

Suitable MPEG ActiveX software must be installed on the computer in order to play back saved video sequences using the MPEG viewer. Further information can be found on page 29.

- Insert the CD into the computer's CD-ROM drive. If the CD does not start automatically, open the CD in Windows Explorer.
- Open the **MPEG viewer** directory and copy the **MPEGViewer.exe** file to your computer's hard drive.
- If necessary, you can also start the MPEG viewer by double-clicking the **MPEGViewer.exe** file.

Hardware connections between video servers

You can easily connect a VideoJet 8008 or VideoJet 8004 with connected cameras as a sender, and a suitable MPEG-4 compatible hardware decoder (such as the VIP XD) with a connected monitor as a receiver via an Ethernet network connection. In this way it is possible to cover long distances without the need for major installation or cabling work.

Installation

Compatible video servers are designed to connect to one another automatically, provided they are correctly configured. They only need to be part of a closed network. Proceed as follows to install the units:

- Connect the units to the closed network using Ethernet cables.
- Connect them to the power supply.

Note

Make sure that the units are configured for the network environment and that the correct IP address for the remote location to be contacted in the event of an alarm is set on the **Alarm connections** configuration page (see pages 53 and 97).

Connecting

There are three options for establishing a connection between a sender and a compatible receiver in a closed network:

- an alarm,
- a terminal program or
- a Web browser.

Connecting alarm

With the appropriate configuration, a connection between a sender and a receiver is made automatically when an alarm is triggered (see page 97). After a short time the live video image from the sender appears on the connected monitor.

This option can also be used to connect a sender and a compatible receiver using a switch connected to the alarm input. You do not need a computer to make the connection in this case.

Connecting with a terminal program

Various requirements must be met in order to operate with a terminal program (see page 25).

- Start the terminal program and enter command `i` in the main menu to switch to the **IP** menu.
- In the **IP** menu, enter command `r` to change the remote IP and enter the IP address of the unit to which you wish to establish a connection.
- In the **IP** menu, enter command `a` to activate automatic connection.

Connecting with a Web browser

Various requirements must be met in order to operate with a Web browser (see page 29).

Note

The sender and receiver must be located in the same subnet to establish a hardware connection (see pages 55 and 107).

- Use the Web browser to connect to the receiver. You see its home page.
- On the **CONNECTIONS** page, select VideoJet 8008 or VideoJet 8004 under **video sources**. A JPEG snapshot of the selected video source will be displayed on the home page.
- Set the video input from which the images should be taken.
- Click **Connect MPEG-4** to begin displaying the video images on the connected monitor.

Closing the connection

The connection can be closed using a terminal program or Web browser.

Closing the connection with a terminal program

- Start the terminal program (see page 25) and enter command **i** in the main menu to switch to the **IP** menu.
- In the **IP** menu, enter command **a** to deactivate automatic connection.

Closing the connection with a Web browser

- Use the Web browser to connect to the receiver. You see its home page.
- On the **CONNECTIONS** page, click the **X** symbol in the title line of the 'Monitor' window to terminate the display of video images on the connected monitor.

Operation with decoder software

The VideoJet 8008 and VideoJet 8004 video servers combine with the VIDOS program for an efficient system solution.

VIDOS is a software package for operating, controlling and managing CCTV installations (such as surveillance systems) at remote locations. It runs under Microsoft Windows operating systems. It is primarily designed for decoding video, audio and control data received from a remote sender.

During operation of a unit with VIDOS, you will be offered many operating and configuration options. Please refer to the software documentation for more details.

Operating options on the front panel

VideoJet 8008 and VideoJet 8004 have different operating and display elements on the front panel (see page 15). You can display some of the most important configuration parameters on the screen. However, it is not possible to change the parameters here.

- Press the **Menu/Exit** key. The menu opens. You can see the first parameter (**IP Address**) and the configured value.
- Press the arrow keys to view other parameters.
- Then press the **Menu/Exit** key to close the menu again.



Note

The **Set** key is designed for future function extensions.

Parameters in the display menu

Below is a brief description of the parameters available in the display menu.

IP Address

Current IP address of the unit.

Subnet Mask

Current subnet mask of the unit.

Gateway

Current gateway IP address of the unit.

MAC address

Current MAC address of the unit.

Ethernet link

Quality of the network connection.

Current connections

Indicator of the total number of all current connections via the network.

Video locked

Indicator of the camera inputs at which there is currently a video signal (labeled **O**).

Input pin states

Indicator of the alarm inputs at which there is currently an alarm (labeled **H**).

EthTX**EthRX**

Current data transmission speed to and from the unit.

HDD Throughput

Current recording speed on the hard drive.

SW version

Firmware version number of the unit.

HW version

Hardware version number of the unit.

HDD Capacity

Current free space on the hard drive.

COM1

Information on the serial interface (standard, interface parameters).

Fan 1**Fan 2**

Information on the operating status of the two fans on the rear panel of the unit.

Date**Time**

Information on the date and time settings.

System uptime

Operating time of the unit since the last power on or since the last reset (in days, hours, minutes and seconds).

Encoder status

Indication of the correct operation of the encoder (labeled +).

7

Maintenance and upgrades

Testing the network connection

You can use the `ping` command to check the connection between two IP addresses. This allows you to test whether a unit in the network is active.

- Open the DOS command prompt.
- Type `ping` followed by the IP address of the unit.

If the unit is found, the response appears as `Reply from ...` followed by the number of bytes sent and the transmission time in milliseconds. If not, the unit cannot be accessed over the network. This might be because:

- The unit is not properly connected to the network. Check the cable connections in this case.
- The unit is not correctly integrated into the network. Check the IP address, the subnet mask and the gateway address.

Restart (Reset)

If necessary, you can restart the unit, for example if it no longer responds. In this case all settings are maintained.

- In the address field of the Web browser, enter `/reset` after the unit's IP address (e.g. `192.168.0.88/reset`).

A new page with the message **going to reset Reconnecting in ... seconds** appears, showing the length of time to the next automatic reconnection.

Repairs



Caution

Never open the housing of the unit. The unit does not contain any user-serviceable parts.

Ensure that all maintenance or repair work is carried out only by qualified personnel (electrical engineers or network technology specialists). In case of doubt, contact your dealer's technical service center.

Transfer and disposal

The device should only be passed on together with this installation and operating manual.

Your Bosch product is designed and manufactured with high quality materials and components which can be recycled and reused.



This symbol means that electrical and electronic equipment, at their end-of-life, should be disposed of separately from your household waste.

In the European Union, there are separate collection systems for used electrical and electronic products. Please dispose of this equipment at your local community waste collection/recycling center.

8

Appendix

Troubleshooting

If you cannot resolve a fault, please contact your supplier or systems integrator or go directly to Bosch Security Systems Customer Service.

The version numbers of the internal processors can be viewed on a special page. Make a note of this information before contacting Customer Service.

- In the address field of the browser, enter `/version.htm` after the unit's IP address (for example `192.168.0.88/version.htm`).
- Write down the information or print out the page.

The following table is intended to help you identify the causes of malfunctions and correct them where possible.

Malfunction	Possible causes	Solution
No connection between the unit and terminal program.	Incorrect cable connections.	Check all cables, plugs, contacts and connections.
	The computer's serial interface is not connected.	Check the other serial interface.
	Interface parameters do not match.	If necessary select a different interface and make sure that the computer's interface parameters match those of the unit. Try the following standard parameters: 19,200 baud, 8 data bits, no parity, 1 stop bit. Next, disconnect the unit from the power supply and reconnect it again after a few seconds.
No image transmission to remote station.	Camera error.	Connect local monitor to the camera and check the camera function.
	Faulty cable connections.	Check all cables, plugs, contacts and connections.

Malfunction	Possible causes	Solution
No connection established, no image transmission.	The unit's configuration.	Check all configuration parameters.
	Faulty installation.	Check all cables, plugs, contacts and connections.
	Wrong IP address.	Check the IP addresses (terminal program).
	Faulty data transmission within the LAN.	Check the data transmission with ping.
	The maximum number of connections has been reached.	Wait until there is a free connection and then call the sender again.
No audio transmission to remote station.	Hardware fault.	Check that all connected audio units are operating correctly.
	Faulty cable connections.	Check all cables, plugs, contacts and connections.
	Incorrect configuration.	Check the configuration of the audio settings (gain and activation).
	Audio voice connection is already in use by another receiver.	Wait until the connection is free and then call the sender again.
The unit does not report an alarm.	Alarm source is not selected.	Select possible alarm sources on the Alarm sources configuration page.
	No alarm response specified.	Specify the desired alarm response on the Alarm connections configuration page, change the IP address if necessary.
Control of cameras or other units is not possible.	The cable connection between the serial interface and the connected unit is not correct.	Check all cable connections and ensure all plugs are properly fitted.
	The interface parameters do not match those of the other unit connected.	Make sure that the settings of all units involved are compatible.
The unit is not operational after a firmware upload.	Power failure during programming by the update file.	Have the unit checked by Customer Service and replace if necessary.
	Incorrect update file.	Enter the unit's IP address followed by /main.htm in the Web browser and repeat the upload.

LEDs

The VideoJet 8008 and VideoJet 8004 network video servers are equipped with a number of LEDs that show the operating status and can give indications of possible malfunctions:

Power

Not lit:	Unit is switched off.
Lit green:	Unit is switched on, not connected.
Flashes green:	600 ms (50:50) = One active connection 300 ms (50:50) = Two active connections 150 ms (50:50) = Three or more active connections

HDD

Flashes red:	Data being transmitted to and from the hard drive.
--------------	--

Fail

Flashes red:	Hardware error (faulty fan); Firmware upload failed (in connection with VideoJet-8008 DEFAULT or VideoJet-8004 DEFAULT screen display).
--------------	---

LAN interface (rear panel)

Green LED lit up:	Network connection exists.
Orange LED flashes:	Data transmission via the network.

RS232/485 interface

Options for using the serial interface include transferring transparent data, controlling connected units or operating the unit with a terminal program. Depending on the setting, the serial interface uses the RS232 or RS422/485 standards. The standard that is used depends on the current configuration (see pages 60 and 104).

RJ45 socket pin assignment

The pin assignment depends on the standard used.

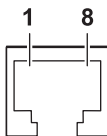

Contact	RS232 standard	RS422/485 standard
1	RxD (receive data)	RxD+ (receive data plus)
2	CTS (clear to send)	RxD- (receive data minus)
3	–	–
4	–	–
5	GND (ground)	GND (ground)
6	–	–
7	TxD (transmit data)	TxD- (transmit data minus)
8	RTS (ready to send)	TxD+ (transmit data plus)

RS232 interface (audio versions only)

The second serial interface can be used to transmit transparent data or for using the unit with a terminal program. It uses the RS232 standard.

9-pin sub-D socket pin assignment

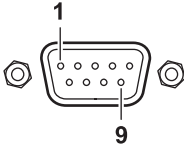











Contact	RS232 standard
1	DCD (data carrier detect)
2	RxD (receive data)
3	TxD (transmit data)
4	DTR (data terminal ready)
5	GND (ground)
6	DSR (data set ready)
7	RTS (ready to send)
8	CTS (clear to send)
9	RI (ring indication)

Terminal block

The terminal block is used for connecting alarm switches.

Terminal assignment (starting at top left)

Terminal	Function
IN1	Input alarm 1
	Ground to Input 1
IN2	Input alarm 2
	Ground to Input 2
IN3	Input alarm 3
	Ground to Input 3
IN4	Input alarm 4
	Ground to Input 4
IN5	Input alarm 5
	Ground to Input 5
IN6	Input alarm 6
	Ground to Input 6
IN7	Input alarm 7
	Ground to Input 7
IN8	Input alarm 8
	Ground to Input 8
IN9	Input alarm 9
	Ground to Input 9
IN10	Input alarm 10
	Ground to Input 10

Connect one alarm input via a trigger contact to the ground contact on the left of it when connecting alarm inputs.





Second terminal block (audio versions only)

The second terminal block contains several contacts for:

- Relay outputs
- Serial data transmission
- Audio functions
- Power supply

Options for using the serial interface include transferring transparent data, controlling connected units or operating the unit with a terminal program.

Terminal assignment (starting at top left)

Terminal	Function
R1	Relay output 1
R1	Relay output 1
R2	Relay output 2
R2	Relay output 2
R3	Relay output 3
R3	Relay output 3
R4	Relay output 4
R4	Relay output 4
R5	Relay output 5
R5	Relay output 5
12 V	12 V (power supply)
	Ground
RX	Receive Data
	Ground
TX	Transmit Data
	Ground
AI	Audio In
	Ground
AO	Audio Out
	Ground

Glossary

Brief explanations of some of the terms and abbreviations used in this manual are given below.

10/100/1000 Base-T	IEEE-802.3 specification for 10, 100 or 1000 MBit/s Ethernet
ARP	Address Resolution Protocol: a protocol for mapping MAC and IP addresses
Baud	Unit of measure for the speed of data transmission
Bit/s	Bits per second, the actual data rate
CIF	Common Intermediate Format, video format with $352 \times 288/240$ pixels
DNS	Domain Name Service
FTP	File Transfer Protocol
Full duplex	Simultaneous data transmission in both directions (sending and receiving)
GoP	Group of Pictures
HTTP	Hypertext Transfer Protocol
ICMP	Internet Control Message Protocol
ID	Identification: a machine readable character string
IEEE	Institute of Electrical and Electronics Engineers
IGMP	Internet Group Management Protocol
Internet Protocol	The main protocol used on the Internet, normally in conjunction with the Transfer Control Protocol (TCP): TCP/IP
IP	See Internet Protocol
IP address	A 4-byte number uniquely defining each unit on the Internet. It is usually written in dotted decimal notation, for example "209.130.2.193"
ISDN	Integrated Services Digital Network
JPEG	An encoding process for still images (Joint Photographic Experts Group)
kBit/s	Kilobits per second, the actual data rate
LAN	See Local area network
Local area network	A communications network serving users within a limited geographical area such as a building or university campus. It is controlled by a network operating system and uses a transfer protocol.
MAC	Media Access Control
MIB	Management Information Base; a collection of information for remote servicing using the SNMP protocol

MPEG-4	A further development of MPEG-2 designed for transmitting audiovisual data at very low transfer rates (for example over the Internet)
Net mask	A mask that explains which part of an IP address is the network address and which part is the host address. It is usually written in dotted decimal notation, for example "255.255.255.192"
Parameters	Values used for configuration
QCIF	Quarter CIF, video format with 176 × 144/120 pixels
RFC 868	A protocol for synchronizing computer clocks over the Internet
RS232/RS422/RS485	Standards for serial data transmission
RTP	Realtime Transport Protocol; a transmission protocol for real-time video and audio
SNMP	Simple Network Management Protocol; a protocol for network management, for managing and monitoring network components
Subnet mask	See Net mask
TCP	Transfer Control Protocol
Telnet	Login protocol with which users can access a remote computer (Host) on the Internet
TTL	Time-To-Live; life cycle of a data packet in station transfers
UDP	User Datagram Protocol
URL	Uniform Resource Locator
UTP	Unshielded Twisted Pair
WAN	See Wide area network
Wide area network	A long distance link used to extend or connect remotely located local area networks

Technical data: VideoJet 8008

Unit

Operating voltage	90 to 250 V AC, 50/60 Hz
Power consumption	Maximum of 60 VA
LAN interface	1 × Ethernet 10/100/1000 Base-T, automatic adjustment, half/full duplex, RJ45
Data interface	1 × RS232/RS422/RS485, bidirectional, RJ45
Alarm inputs	10 × push-in terminal (non-isolated closing contact), max. activation resistance 10 Ohm
Video inputs	8 × BNC socket 0.7 to 1.2 V _{p-p} , 75 Ohm switchable, PAL/NTSC
Dual Streaming	Yes
Displays	3 × LED (operating voltage, hard drive activity, hardware error) and display on the front panel, 2 × LED (network connection, data transmission) to the LAN interface on the rear panel
Storage medium	1 × 160, 250, 500 GB or 1 TB hard drive
Operating conditions	Temperature: 0 to +40 °C (+32 to +104 °F) relative humidity: 20 to 80%, non-condensing, altitude 0 to 3,000 m
Storage conditions	Temperature: -20 to +60 °C (-4 to +140 °F) relative humidity: 0 to 95%, non-condensing, maximum altitude 10,000 m
Regulatory approvals	CE: IEC 60950; UL 1950; AS/NZS 3548; EN 55103-1, -2; EN 55130-4; EN 55022; EN 55024; EN 61000-3-2; EN 61000-3-3; FCC 47 CFR Chapter 1 Part 15
Dimensions (W × H × D)	409.2 × 48.6 × 351.5 mm (16.11 × 1.91 × 13.84 inches) including feet and BNC connections
Weight (with HDD 160 GB)	Approx. 5.3 kg

Protocols/standards

Video standards	PAL, NTSC
Video coding protocols	MPEG-4, JPEG
Video data rate	1 MBit/s to 5 MBit/s per channel
Image resolutions (PAL/NTSC)	704 × 576/480 pixels (4CIF/D1) 704 × 288/240 pixels (2CIF) 352 × 576/480 pixels (1/2 D1) 352 × 288/240 pixels (CIF) 176 × 144/120 pixels (QCIF)
Overall delay	120 ms (PAL/NTSC)
Image refresh rate	1 to 50/60 fields/s variable (PAL/NTSC), Field/image-based encoding
Network protocols	RTP, Telnet, UDP, TCP, IP, HTTP, IGMP V2, IGMP V3, ICMP, ARP

Technical data: VideoJet 8008 with audio

Unit

Operating voltage	90 to 250 V AC, 50/60 Hz
Power consumption	Maximum of 60 VA
LAN interface	1 × Ethernet 10/100/1000 Base-T, automatic adjustment, half/full duplex, RJ45
Data interface	1 × RS232/RS422/RS485, bidirectional, RJ45 1 × RS232, 9-pin. sub-D socket
Alarm inputs	10 × push-in terminal (non-isolated closing contact), max. activation resistance 10 Ohm
Relay outputs	5 × push-in terminal, 30 V _{p-p} , 2 A
Video inputs	8 × BNC socket 0.7 to 1.2 V _{p-p} , 75 Ohm switchable, PAL/NTSC
Dual Streaming	Yes
Audio inputs (Line In)	8 × 3.5 mm stereo socket, 1 V _{p-p} max., impedance 50 kOhm typ.
Audio outputs (Line Out)	8 × 3.5 mm stereo socket, 1 V _{p-p} max., impedance 8 Ohm min. 1 × 3.5 mm stereo socket, 5 W @ 8 Ohm / 2.5 W @ 4 Ohm
Microphone input	1 × push-in terminal, 2.8 V _{p-p} max. at -20 dB, impedance 2 kOhm typ., supply 2.3 V typ.
Speaker output	1 × push-in terminal, 6 V _{p-p} max., 1 W rms, impedance 4 Ohm min.
Displays	3 × LED (operating voltage, hard drive activity, hardware error) and display on the front panel, 2 × LED (network connection, data transmission) to the LAN interface on the rear panel
Storage medium	1 × 160, 250, 500 GB or 1 TB hard drive
Operating conditions	Temperature: 0 to +40 °C (+32 to +104 °F) relative humidity: 20 to 80%, non-condensing, altitude 0 to 3,000 m

Storage conditions	Temperature: -20 to +60 °C (-4 to +140 °F) relative humidity: 0 to 95%, non-condensing, maximum altitude 10,000 m
Regulatory approvals	CE: IEC 60950; UL 1950; AS/NZS 3548; EN 55103-1, -2; EN 55130-4; EN 55022; EN 55024; EN 61000-3-2; EN 61000-3-3; FCC 47 CFR Chapter 1 Part 15
Dimensions (W × H × D)	409.2 × 48.6 × 351.5 mm (16.11 × 1.91 × 13.84 inches) including feet and BNC connections
Weight (with HDD 160 GB)	Approx. 5.35 kg

Protocols/standards

Video standards	PAL, NTSC
Video coding protocols	MPEG-4, JPEG
Video data rate	1 MBit/s to 5 MBit/s per channel
Image resolutions (PAL/NTSC)	704 × 576/480 pixels (4CIF/D1) 704 × 288/240 pixels (2CIF) 352 × 576/480 pixels (1/2 D1) 352 × 288/240 pixels (CIF) 176 × 144/120 pixels (QCIF)
Audio coding protocol	G.711
Overall delay	120 ms (PAL/NTSC)
Image refresh rate	1 to 50/60 fields/s variable (PAL/NTSC), Field/image-based encoding
Network protocols	RTP, Telnet, UDP, TCP, IP, HTTP, IGMP V2, IGMP V3, ICMP, ARP

Technical data: VideoJet 8004

Unit

Operating voltage	90 to 250 V AC, 50/60 Hz
Power consumption	Maximum of 60 VA
LAN interface	1 × Ethernet 10/100/1000 Base-T, automatic adjustment, half/full duplex, RJ45
Data interface	1 × RS232/RS422/RS485, bidirectional, RJ45
Alarm inputs	10 × push-in terminal (non-isolated closing contact), max. activation resistance 10 Ohm
Video inputs	8 × BNC socket 0.7 to 1.2 V _{p-p} , 75 Ohm switchable, PAL/NTSC
Dual Streaming	No
Displays	3 × LED (operating voltage, hard drive activity, hardware error) and display on the front panel, 2 × LED (network connection, data transmission) to the LAN interface on the rear panel
Storage medium	1 × 160, 250, 500 GB or 1 TB hard drive
Operating conditions	Temperature: 0 to +40 °C (+32 to +104 °F) relative humidity: 20 to 80%, non-condensing, altitude 0 to 3,000 m
Storage conditions	Temperature: -20 to +60 °C (-4 to +140 °F) relative humidity: 0 to 95%, non-condensing, maximum altitude 10,000 m
Regulatory approvals	CE: IEC 60950; UL 1950; AS/NZS 3548; EN 55103-1, -2; EN 55130-4; EN 55022; EN 55024; EN 61000-3-2; EN 61000-3-3; FCC 47 CFR Chapter 1 Part 15
Dimensions (W × H × D)	409.2 × 48.6 × 351.5 mm (16.11 × 1.91 × 13.84 inches) including feet and BNC connections
Weight (with HDD 160 GB)	Approx. 5.25 kg

Protocols/standards

Video standards	PAL, NTSC
Video coding protocols	MPEG-4, JPEG
Video data rate	1 MBit/s to 5 MBit/s per channel
Image resolutions (PAL/NTSC)	704 × 576/480 pixels (4CIF/D1) 704 × 288/240 pixels (2CIF) 352 × 576/480 pixels (1/2 D1) 352 × 288/240 pixels (CIF) 176 × 144/120 pixels (QCIF)
Overall delay	120 ms (PAL/NTSC)
Image refresh rate	1 to 50/60 fields/s variable (PAL/NTSC), Field/image-based encoding
Network protocols	RTP, Telnet, UDP, TCP, IP, HTTP, IGMP V2, IGMP V3, ICMP, ARP

Technical data: VideoJet 8004 with audio

Unit

Operating voltage	90 to 250 V AC, 50/60 Hz
Power consumption	Maximum of 60 VA
LAN interface	1 × Ethernet 10/100/1000 Base-T, automatic adjustment, half/full duplex, RJ45
Data interface	1 × RS232/RS422/RS485, bidirectional, RJ45 1 × RS232, 9-pin. sub-D socket
Alarm inputs	10 × push-in terminal (non-isolated closing contact), max. activation resistance 10 Ohm
Relay outputs	5 × push-in terminal, 30 V _{p-p} , 2 A
Video inputs	8 × BNC socket 0.7 to 1.2 V _{p-p} , 75 Ohm switchable, PAL/NTSC
Dual Streaming	No
Audio inputs (Line In)	8 × 3.5 mm stereo socket, 1 V _{p-p} max., impedance 50 kOhm typ.
Audio outputs (Line Out)	8 × 3.5 mm stereo socket, 1 V _{p-p} max., impedance 8 Ohm min. 1 × 3.5 mm stereo socket, 5 W @ 8 Ohm / 2.5 W @ 4 Ohm
Microphone input	1 × push-in terminal, 2.8 V _{p-p} max. at -20 dB, impedance 2 kOhm typ., supply 2.3 V typ.
Speaker output	1 × push-in terminal, 6 V _{p-p} max., 1 W rms, impedance 4 Ohm min.
Displays	3 × LED (operating voltage, hard drive activity, hardware error) and display on the front panel, 2 × LED (network connection, data transmission) to the LAN interface on the rear panel
Storage medium	1 × 160, 250, 500 GB or 1 TB hard drive
Operating conditions	Temperature: 0 to +40 °C (+32 to +104 °F) relative humidity: 20 to 80%, non-condensing, altitude 0 to 3,000 m

Storage conditions	Temperature: -20 to +60 °C (-4 to +140 °F) relative humidity: 0 to 95%, non-condensing, maximum altitude 10,000 m
Regulatory approvals	CE: IEC 60950; UL 1950; AS/NZS 3548; EN 55103-1, -2; EN 55130-4; EN 55022; EN 55024; EN 61000-3-2; EN 61000-3-3; FCC 47 CFR Chapter 1 Part 15
Dimensions (W × H × D)	409.2 × 48.6 × 351.5 mm (16.11 × 1.91 × 13.84 inches) including feet and BNC connections
Weight (with HDD 160 GB)	Approx. 5.3 kg

Protocols/standards

Video standards	PAL, NTSC
Video coding protocols	MPEG-4, JPEG
Video data rate	1 MBit/s to 5 MBit/s per channel
Image resolutions (PAL/NTSC)	704 × 576/480 pixels (4CIF/D1) 704 × 288/240 pixels (2CIF) 352 × 576/480 pixels (1/2 D1) 352 × 288/240 pixels (CIF) 176 × 144/120 pixels (QCIF)
Audio coding protocol	G.711
Overall delay	120 ms (PAL/NTSC)
Image refresh rate	1 to 50/60 fields/s variable (PAL/NTSC), Field/image-based encoding
Network protocols	RTP, Telnet, UDP, TCP, IP, HTTP, IGMP V2, IGMP V3, ICMP, ARP

9

Index

A

Activating audio function 78
Activating partition 39, 87
Actuator 21
Alarm 51, 122
Alarm input 14, 21
Alarm message 70
Alarm recording 90
Alarm sources 95
Alarm tracks 42, 43, 90, 91
Audio connections 22
Audio input channel 78
Audio output channel 79
Audio settings 78
Auto-connect 54, 98

B

Backup 130
Banner 112
Basic data 47
Baud rate 37, 61, 75, 105
Bookmarks 129
Brightness 71
Browser window 121

C

Cables 17
Camera 61, 104
Camera name 68
Camera selection 121
Cameras 20
Changes 33, 64, 84
Changes in light level 100
Checking network 139
Closing the connection 134
Color depth 10, 29, 119
COM1 60, 104

Components supplied 9
Configuration 29, 116
Configuration menu 32, 63
Configuration mode 31
Connecting 132
Contrast 71
Control 60, 104
Control functions 122
Controlling playback 127
Conventions 5
Creating a partition 83

D

Danger 7
Data bits 61, 105
Data interface 21
Data terminal 25
Data transmission 15
Date and time 66
Date format 49, 66
Daylight saving time 67
Default camera 54, 98
Default settings 38, 76
Defaults 100
Deleting a partition 86
Deleting recordings 46, 94
Desktop unit 11, 17
Display 15
Display menu 135
Display stamping 69
DNS server 108
Dome camera 21
Dual Streaming 11, 34, 72
DVR 12

E

Echo 26
Editing a partition 85
Electromagnetic compatibility 6
Encoder 34
Encoder numbering 34, 58, 72, 110
Encoding 11
EPROM 115
Establishing the connection 30, 120
Event log 113, 123

F

False alarms 100
Filetracks 41, 89
Firmware update 115
Format 46, 94
Front panel 15, 135
FTP server 80, 81
Function test 117

G

Gateway 56, 107

H

Half-duplex mode 61, 105
Hardware error 15
Heat 17, 18
Heat load 17

I

Identification 6, 47, 64
IGMP 57, 109
Image quality 58, 110
Image resolution 124
Image selection 121
Installation 8, 18
Installation conditions 17
Installation location 17
Installation overview 19
Installing in
a switch cabinet 11, 17, 18
Interface 14, 144, 145

Interface mode 61, 105
Internal clock 50, 66
IP address 26, 55, 107

J

JPEG format 80
JPEG posting 80
JPEG posting interval 81

L

Language 49, 66
LED 15
Linear mode 41, 43, 45, 89, 91, 93
Live video images 29, 119
LIVEPAGE 112
Loudspeaker 23
Low Voltage Directive 6

M

Main functions 13
Maintenance 8
Make contact 21
Maximum data rate 37, 75
Media-replay 126
Microphone 23
Monitor resolution 29, 119
Motion detector 99
Motion detector defaults 100
Motion detector object size 100
Motion detector sensitivity 100
Mounting kit 18
MPEG ActiveX 29, 119, 124, 131
MPEG viewer 12, 124, 131
MPEG-4 encoder 72
Multicast 57, 109
Multicast connection 57, 109
Multicast function 12
Multicast port 58, 110
Multi-unicast 57, 109

N

Network 21, 55, 107
Network connection 24
Number of connections 31, 121

O

Operation 7, 119
Overview of functions 11

P

Parameters 27
Parity 61, 105
Partition 82, 87
Partition name 45, 92
Partitioning 82
Password 31, 65, 121
Password protection 48, 65
Peripheral device control 122
Picture settings 71
Pin assignment 144, 145
Playback 126
Playback button 128
Post-alarm duration 43, 91
Power off 24
Power on 24
Power supply 24
Power switch 24
Pre-alarm duration 43, 91
Profile settings 36, 74
Profiles 34, 72
Protocol 61, 105
Protocols 151, 153, 155, 157

R

Rear panel 14
Receiver 11
Receiver password 53, 97
Recording parameters 39
Recording profile 45, 93
Recording program 125
Recording scheduler 87
Recording

status 41, 43, 46, 89, 91, 94
Recording video sequences 124
Reflections of light 100
Regulations 5
Relay configuration 102
Relay output 23, 102
Remote control 12
Repair 8, 140
Reset 139
Reset of profile 38, 76
Restart 27, 139
Ring mode 41, 43, 45, 89, 91, 93
Router 58, 110
RS232 144
RS422/RS485 144

S

Safety 7
Saturation 71
Saving event log 114
Saving system log 114
Selecting a profile 34, 72
Selecting the area 101
Sensor fields 101
Serial number 6
Serial port function 60, 62, 104, 106
Setup 9
Setup location 17
Signal source 21
Snapshots 12, 124
SNMP 52, 96
Software decoder 134
Source type 77
Standard 144, 145
Standards 151, 153, 155, 157
Stop bits 61, 105
Streaming 58, 110
Subnet mask 55, 107
Symbols 5
Synchronize 50, 66
System 47
System log 113, 123

T

Tamper protection 101
Target data rate 37, 75
Technical data
 VideoJet 8004 154
 VideoJet 8004 with audio 156
 VideoJet 8008 150
 VideoJet 8008 with audio 152
Terminal 60, 62, 104, 106
Test 117
Time 50, 67
Time recording 40, 88
Time server 67
Time server IP address 67
Time server protocol 67
Time signal 67
Time zone 67
Total size 46, 94
Total time 46, 94
Transmission parameters 25
Transmission rate 61, 62, 105, 106
Transmission standards 21, 23
Transparent 60, 62, 104, 106
Triggering relay 103
TTL 58, 110

U

Unicast 57, 109
Unit date 50, 66
Unit ID 47, 64
Unit name 47, 64
Unit overview 31, 33
Unit time 50, 66
Upload file 115
URL 30, 120
User name 48, 65

V

Ventilation 18
Version 50, 111
Video input 77
Video inputs 14

Video loss alarm 52, 95
Video recorder 77
Video recording 45, 93
Video sensor 99
Video signal interruption 52, 95
Video sources 20

W

Watermarking 70

Bosch Sicherheitssysteme GmbH
Robert-Koch-Straße 100
85521 Ottobrunn
Germany
www.bosch-sicherheitssysteme.de

Bosch Security Systems B.V.
P.O. Box 80002
5600 JB Eindhoven
The Netherlands
www.boschsecuritysystems.com

Copyright © 2006 BOSCH Sicherheitssysteme GmbH
Subject to change.
2908B/0706/en/6

BOSCH

Free Manuals Download Website

<http://myh66.com>

<http://usermanuals.us>

<http://www.somanuals.com>

<http://www.4manuals.cc>

<http://www.manual-lib.com>

<http://www.404manual.com>

<http://www.luxmanual.com>

<http://aubethermostatmanual.com>

Golf course search by state

<http://golfingnear.com>

Email search by domain

<http://emailbydomain.com>

Auto manuals search

<http://auto.somanuals.com>

TV manuals search

<http://tv.somanuals.com>