

brother[®]

PORTABLE ELECTRONIC TYPEWRITER

AX-10

INSTRUCTION MANUAL

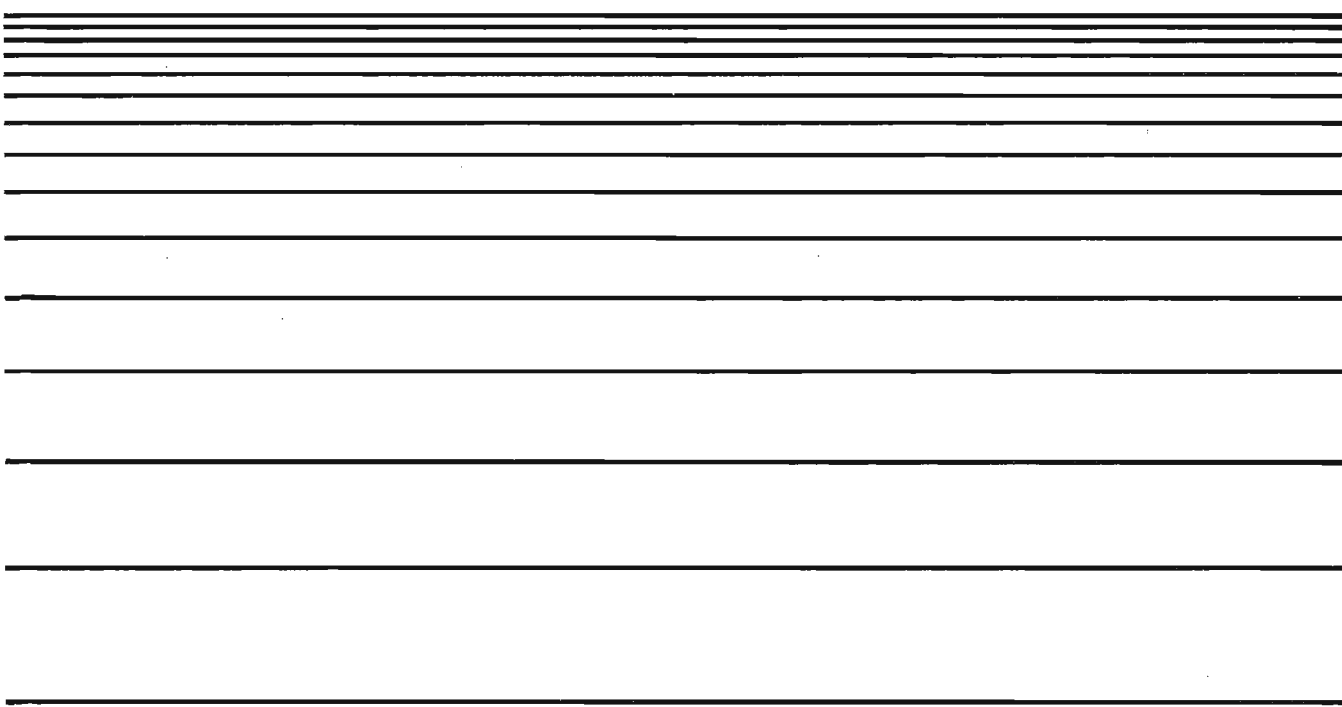

UNPACKING

Brother AX-10 is packed with all of the necessary supporting items. Make sure that the following have been included in the package

- Typewriter
- Cassette Ribbon
- Daisy Wheel Cassette
- Correction Tape
- Instruction Manual



AX-10

Brother electronic typewriter AX-10 is designed to provide years of reliable operations.



Cassette Ribbon

You can keep your fingers clean with Brother's mess-less cassette ribbon. Correctable and Nylon ribbons (option) are available.

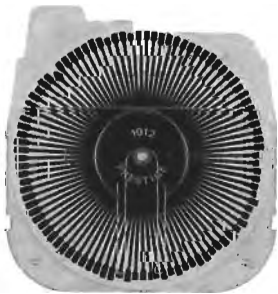

Cassette Daisy Wheel

Brother's cassette daisy wheel can be easily slipped in and out of the typewriter without fuss or damage.

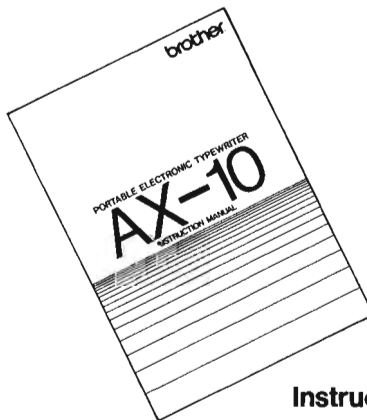

Instruction Manual



Correction Tape

Lift-off and Cover-up (option).

INTRODUCTION

Thank you for purchasing a Brother AX-10 electronic typewriter. The AX-10 is designed to provide years of reliable operations.

CONTENTS

UNPACKING	1
INTRODUCTION	2
CONTENTS	2
PART AND FEATURE GUIDE	3
1. TAB KEY	3
2. MARGIN RELEASE KEY	3
3. LINE SPACE SELECTOR	3
4. PLATEN KNOB (PLATEN RELEASE PUSH BUTTON)	3
5. LEFT/RIGHT MARGIN SET KEY	3
6. TAB SET KEY	3
7. TAB CLEAR KEY	3
8. PITCH INDICATOR	3
9. PITCH SELECTOR	3
10. CODE KEY	3
11. SHIFT LOCK KEY	3
12. REPEAT KEY	3
13. SHIFT KEY	3
14. PAPER GUIDE	4
15. PAPER RELEASE LEVER	4
16. PAPER BAIL SCALE	4
17. CARRIER ASSEMBLY	4
18. HALF BACKSPACE KEY	4
19. RELOCATE KEY	4
20. BACKSPACE KEY	4
21. EXPRESS BACKSPACE KEY	4
22. CARRIER RETURN KEY	4
23. CORRECTION KEY	4
24. SPACE BAR	4
FUNCTION INDEX	5
KEYBOARD COVER	6
HANDLE	6
POWER	6
COVER SWITCH	6
CORRECTION TAPE	7
CASSETTE RIBBON	7
CASSETTE DAISY WHEEL	7
PAPER SETTING AND FEED	9
PITCH SELECT	10
LINE SPACE SELECT	10
MARGIN SETTING	11
MARGIN RELEASE	11
LEFT MARGIN	12
RIGHT MARGIN	12
TAB SET	13
TAB CLEAR	13
ALL TAB CLEAR	13
TYPING FUNCTION	14
1. SHIFT	14
2. SHIFT LOCK	14
3. CODE KEY	14
4. RETURN	14
5. REPEAT	14
6. BACKSPACE	14
7. EXPRESS BACKSPACE	14
8. HALF BACKSPACE	14
CORRECTION FUNCTIONS	15
MEMORY CORRECTION	15
MANUAL CORRECTION	15
INSERTION	16
CARE OF UNIT	17
TROUBLE SHOOTING	17
DAISY WHEEL SAMPLES	18
SPECIFICATIONS	18

This equipment generates and uses radio frequency energy and if not installed and used properly, that is, in strict accordance with the manufacturer's instructions, may cause interference to radio and television reception. It has been type tested and found to comply with the limits for a Class B computing device in accordance with the specifications in Subpart J of Part 15 of FCC Rules, which are designed to provide reasonable protection against such interference in a residential installation. However, there is no guarantee that interference will not occur in a particular installation. If this equipment does cause interference to radio or television reception, which can be determined by turning the equipment off and on, the user is encouraged to try to correct the interference by one or more of the following measures:

- reorient the receiving antenna
- relocate the typewriter with respect to the receiver
- move the typewriter away from the receiver
- plug the typewriter into a different outlet so that typewriter and receiver are on different branch circuits.

If necessary, the user should consult the dealer or an experienced radio/television technician for additional suggestions. The user may find the following booklet prepared by the Federal Communications Commission helpful: "How to Identify and Resolve Radio – TV Interference Problems". This booklet is available from the US. Government Printing Office, Washington, D.C., 20402, Stock No. 004-000-00345-4.

PART AND FEATURE GUIDE



LINE SPACE SELECTOR Page 10

Sets the number of lines to be fed each time the carrier return is pressed.



MARGIN RELEASE KEY Page 11

Temporarily releases either the left or right margin.



TAB KEY Page 12

Advances the position to the position.

PLATEN KNOB (LEFT) with PLATEN RELEASE PUSH BUTTON Page 9

In order to make minor vertical adjustments in the position of the paper, push the platen release button (located on the left platen knob) and rotate the platen.

L MAR
R MAR

LEFT/RIGHT MARGIN SET KEY Page 12

Sets the left and right margins.

TAB+

TAB SET KEY Page 13

Sets a tab at the current carrier position.

TAB-

TAB CLEAR KEY Page 13

Release tabs that have been set using the tab set key.

PITCH

○ 12
○ 10

PITCH INDICATOR Page 10

Indicates the currently selected typing pitch.

PITCH SELECTOR Page 10

Selects between Pica and Elite typing pitches.

CODE

CODE KEY Page 14

Used to type the characters or to enable the functions to be noted on the keyboard in green letters.

SHIFT LOCK

SHIFT LOCK KEY Page 14

Locks the keyboard into the uppercase mode.

REPEAT

REPEAT Page 15

Used to correct the character repeated immediately after the character pressed immediately.

SHIFT

SHIFT KEY Page 15

Used to type characters in the shift lock mode.

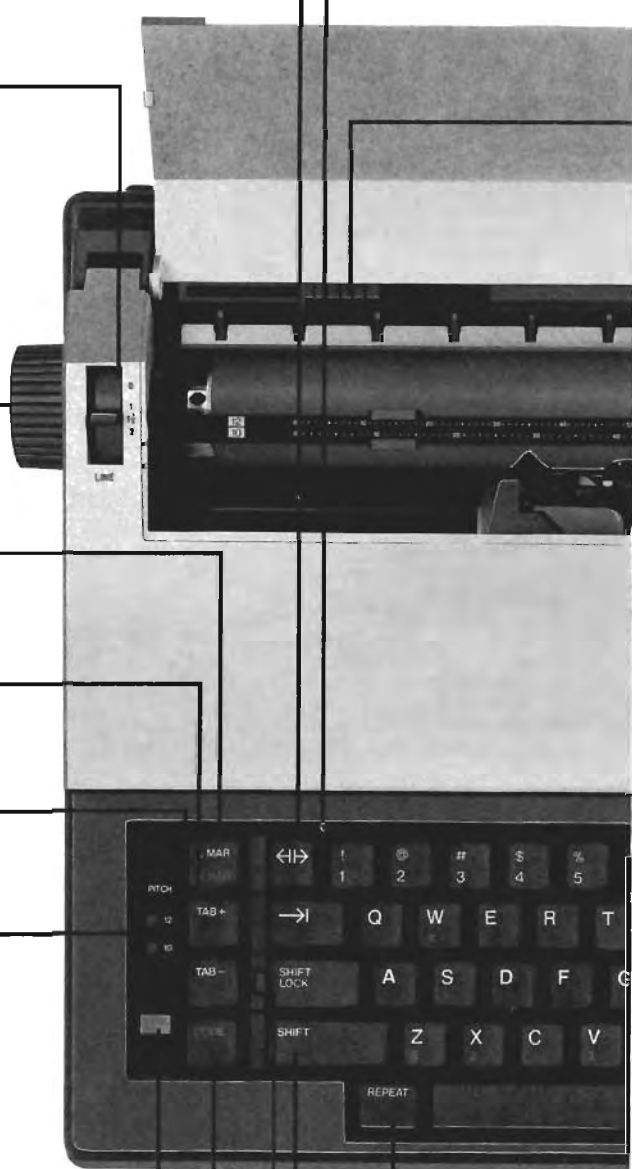

ge 13
carrier to the next tab
right of its present

PAPER GUIDE Page 9
Ensures that paper is fed straight
through the platen and keeps the
following papers in the same position.

PAPER RELEASE LEVER Page 9
In the set position, locks the paper
against the platen. When released,
the paper can be easily moved by
hand.

PLATEN KNOB (RIGHT) Page 9

PAPER BAIL SCALE Page 9
Holds the top of the paper against
the platen. Pitch scales for both Pica
and Elite are noted on the bail.

CARRIER ASSEMBLY
Made up of the daisy wheel, cassette
ribbon, correction tape and impact
mechanism.



HALF BACKSPACE KEY Page 10
Move the carrier one half space to
the left. Used to keep text balanced
when inserting and deleting characters.



RELOCATE KEY Page 10
Returns the carrier to the typing
position after it has been moved to
the left for correction of text.



BACKSPACE KEY Page 10
Moves the carrier one space to the left.
**EXPRESS
BACKSPACE KEY** Page 10
Moves the carrier to the left margin
position of the current line.



CORRECTION KEY Page 15
Used to delete characters
either with the correction
memory or during
manual correction.

CARRIER RETURN KEY Page 10
Returns the carrier to the left margin
position of the next line and clears
the correction memory.

KEY Page 14
Continuously
function type of
er of the key
mediately before.

KEY Page 14
e uppercase
and to release
k.

SPACE BAR Page 11
Moves the carrier one space to the
right.

FUNCTION INDEX

Page

17

HITEC INDUSTRY CONSULTANTS
115 Sansone Street
San Francisco, CA 94104

Mr. J. C. Bartel
2345 West Brady Avenue
Duluth, Minnesota 12345

Dear Mr. Bartel,

We understand that you are in the market for an electronic typewriter and we would like to take this opportunity to strongly suggest the new AX-10 by Brother. The AX-10 is designed for portable efficiency and is alone in its class.

Page

17

Both Pica pitch which types 10 characters per inch, and Elite pitch that types at 12 characters per inch can be selected quickly and easily.

A repeat function lets you print a continuous series of characters by simply holding down a single key-----

In addition, the following functions are also readily available:

Page

18

40-character
correction memory

Relocate after
correction

Half backspace

Express backspace

Add to these Brother's cassette daisy wheels and ribbons, as well as a worldwide reputation for excellence, and you have a combination that's unbeatable.

We strongly suggest the Brother AX-10 as the logical choice for your applications.

Sincerely yours

Edward Macleod

KEYBOARD COVER

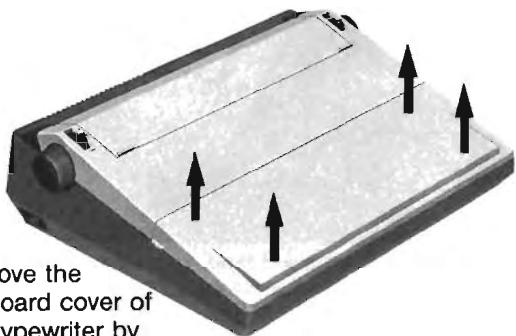

Remove the keyboard cover of the typewriter by gripping and slightly rotating outward at the two tabs on the left and right. Open the power cord compartment cover at the rear of the typewriter by pressing the two tabs at the top of the cover.

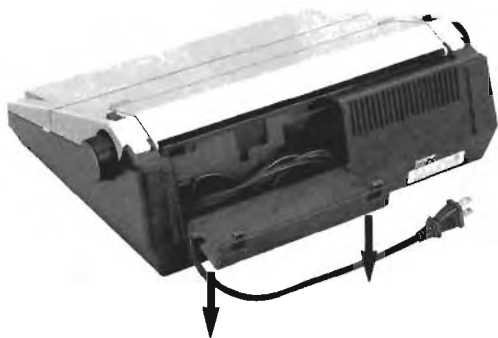

HANDLE

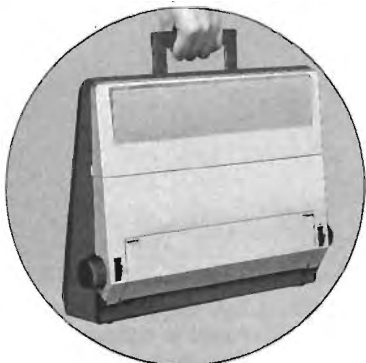

Your compact, lightweight Brother AX-10 comes equipped with a built-in handle that makes carrying your AX-10 easy.

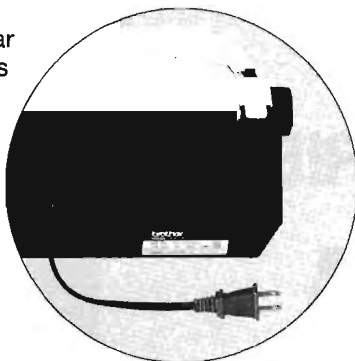

Remove the power cord from the compartment. Close the power cord compartment cover and insert the plug of the typewriter into a standard AC electrical outlet.

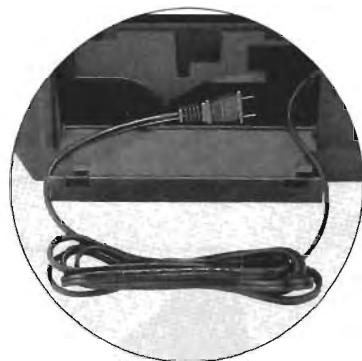

To return the power cord to its compartment, first place the plug inside the compartment and then fold the cord carefully into the compartment.

POWER

Set the power switch located on the left side of the typewriter to the ON position. Whenever power is turned on, the typewriter is automatically set to Pica pitch, the left margin is set at position 10 and the right margin is set at position 75. The carrier will move to the left end of the platen and then return to the left margin setting.

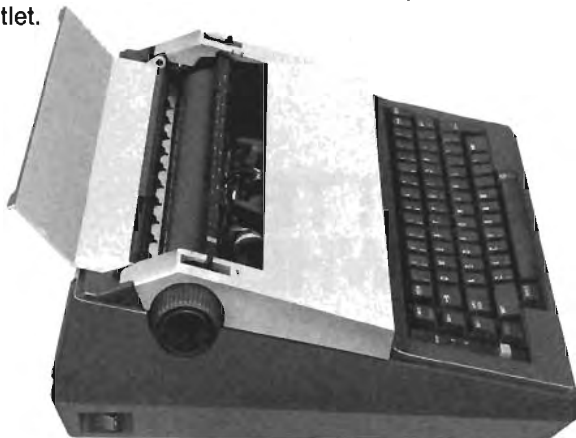

COVER SWITCH

When the cover is lifted (e.g., to replace a daisy wheel), the power to the carriage and daisy wheel motor is shut off by a cover switch. When the cover is then closed, the carriage moves to the left and then returns to its original position.

CORRECTION TAPE



Both lift-off correctable ribbon correction tape and cover-up nylon correction tape are available. The lift-off tape removes the character from the paper and the cover-up tape leaves the character on the paper but covers it with white ink.

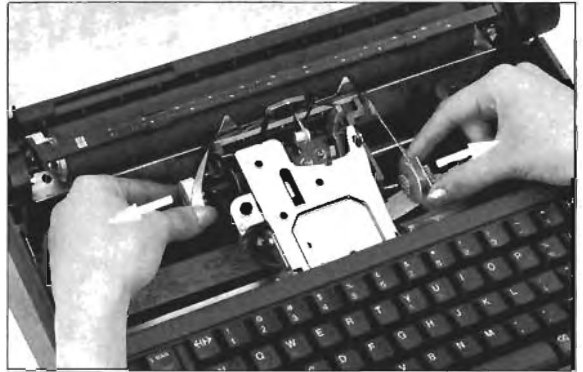

To replace the correction tape, first remove the cassette ribbon and then remove the used correction tape. Insert new correction tape then replace cassette ribbon. Use the space bar to locate the carrier to the center of the platen. Open the top cover of the typewriter and hold a new roll of correction tape so the feed spool is in your left hand and the take-up spool in your right hand. The rough side of the tape should be toward the platen.

CASSETTE RIBBON

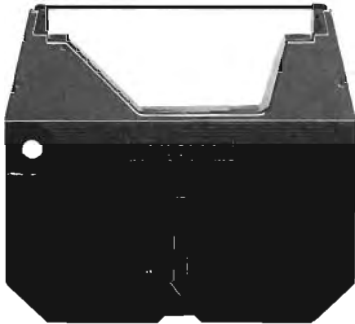

To insert a cassette ribbon, turn the ribbon feed knob on the cassette counterclockwise to tighten the ribbon. Then use both hands to slip the back edge of the cassette onto the carrier.

CASSETTE DAISY WHEEL

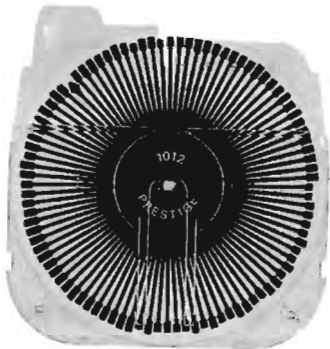

Pull the green motor lock lever on the carrier toward you.

Note: Use authorized cassette ribbon and correction tape only.

7 Failure to do so, will invalidate the guarantee.

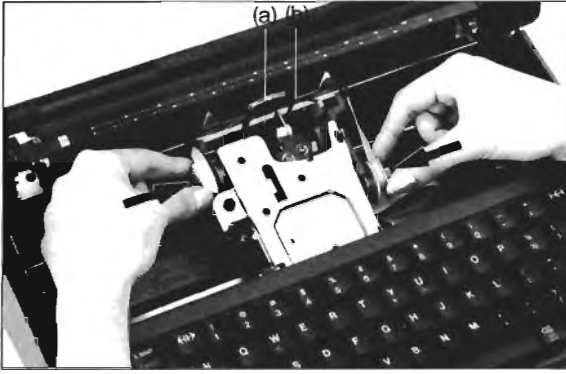

Pass the tape through the space between the paper meter (a) and the ribbon guide (b). Set the tape in the tape guides on the left and right.

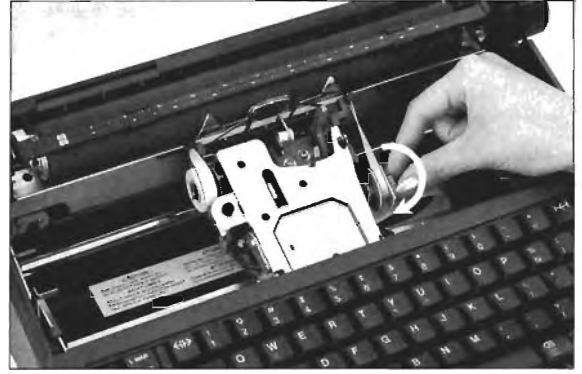

After setting the feed spool on the left pin and the take-up spool on the right pin, turn the take-up spool counterclockwise until the white tape winds around the take-up spool.



Set the ribbon into the ribbon guides and then gently press the cassette down until it clicks into place.



Turn the ribbon feed knob counterclockwise to take up any slack. (To remove the cassette ribbon, simply reverse this procedure.)

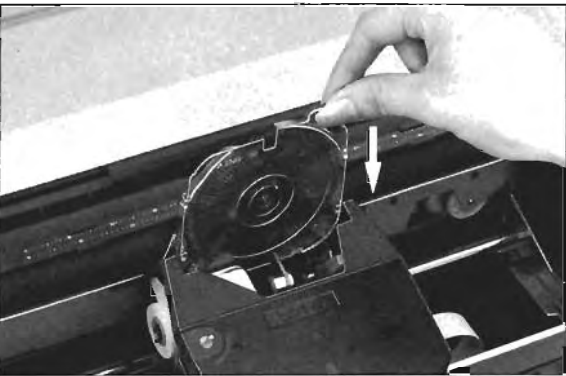

To prevent damage and ensure proper installation, always handle daisy wheels by gripping the clear plastic tab of the cassette between the thumb and forefinger of your right hand and insert the daisy wheel into the carrier. Make sure that the daisy wheel slips all the way down into place.



Press the motor lock lever toward the platen until it clicks into place. Do not force the lever. If you have difficulty, check again to see that the daisy wheel is set properly.

PAPER SETTING AND FEED

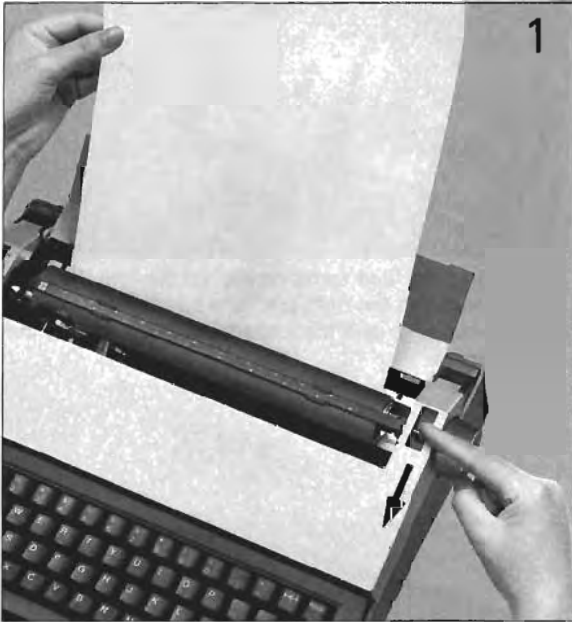

Lift paper supporter then insert the paper behind the platen.

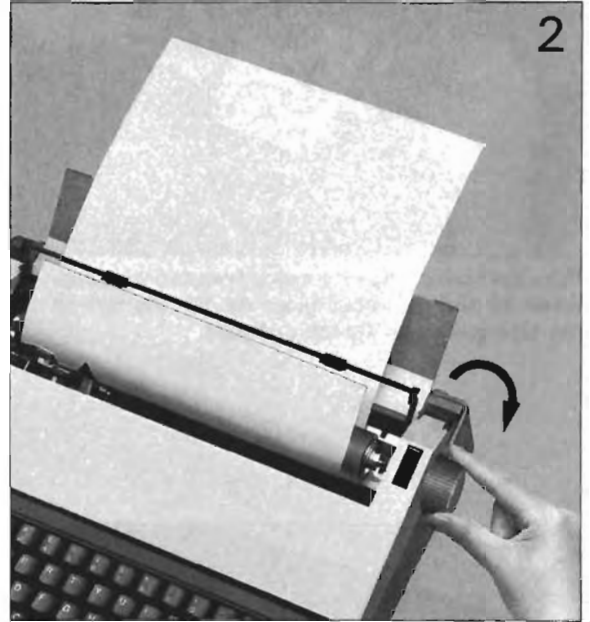

Turn platen knobs until paper wraps around platen. When the top edge of the paper appears, lift the paper bail scale and continue to turn the platen knob.

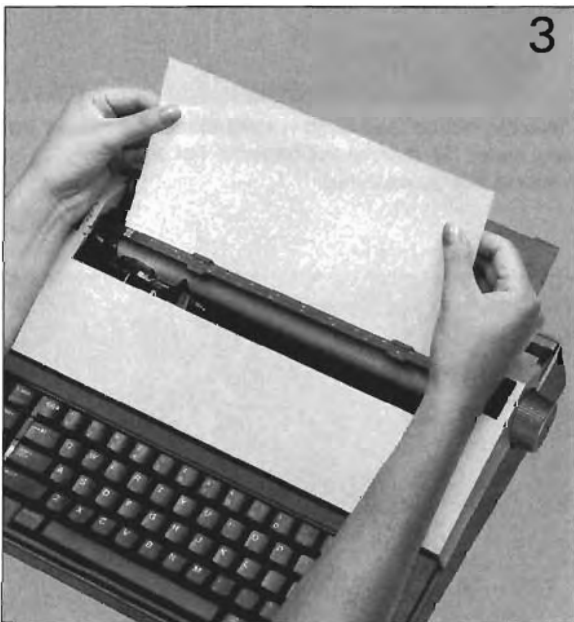

When the paper comes between the platen and the paper bail scale, return the paper bail scale to its original position. In order to adjust the paper, push the paper release lever (which loosens the paper) and make necessary adjustments.



Then return the paper release lever.

PITCH SELECT



When the power of the typewriter is switched ON, the pitch is automatically set to Pica. The pitch selector can be used to switched between Pica and Elite any time the carrier is positioned at the left margin. Note that the upper scale on the paper bail is for Elite while the lower scale is for Pica.

	Selector	Chr. per inch.	Max. chr. per line
Pica	10	10	90
Elite	12	12	108

We strongly suggest the Brother AX-10 as the logical <Pica pitch>

We strongly suggest the Brother AX-10 as the logical <Elite pitch>

LINE SPACE SELECT

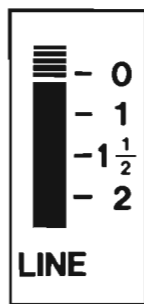

Use the line space selector to choose the number of lines you wish the paper to be fed when you press the carrier return key. The line space setting can be changed at any time.

Brother
electronic
typewriter
AX-10

Line space
selection 1

Brother
electronic
typewriter
AX-10

Line space
selection 1½

Brother
electronic
typewriter
AX-10

Line space
selection 2

MARGIN SETTING

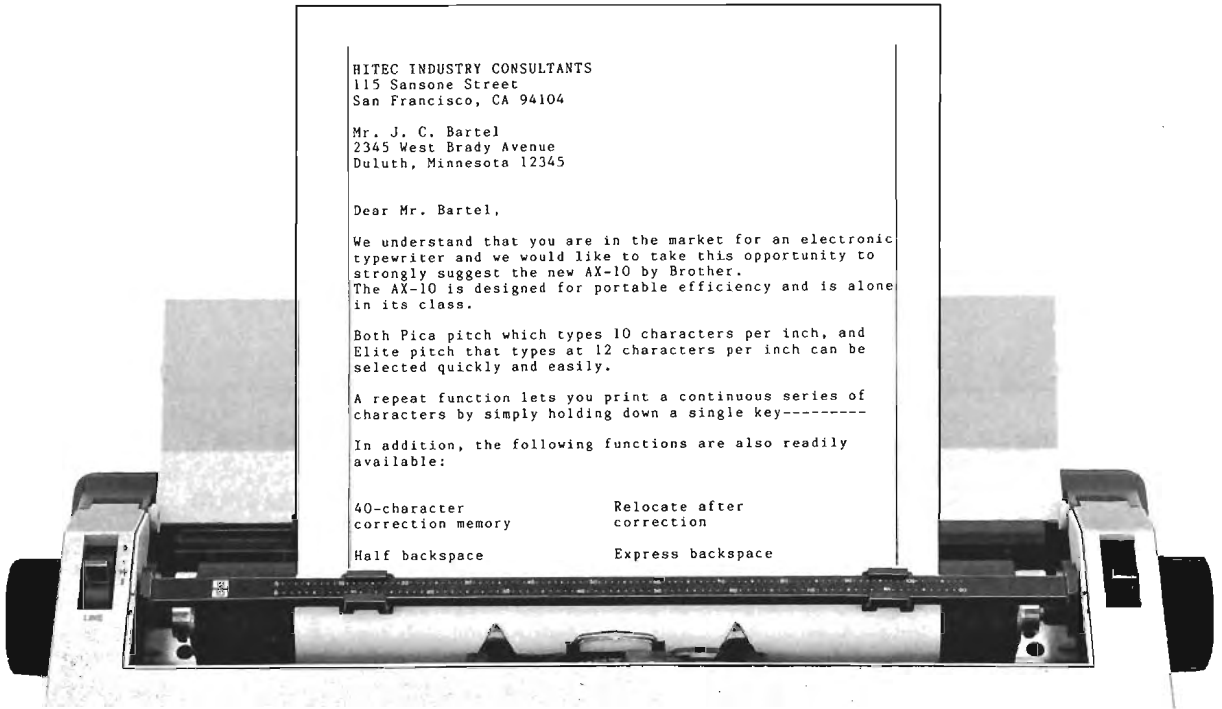

When the power of the typewriter is switched ON, the left margin is set to position 10 and the right margin is set to position 75 of Pica pitch. The margin can be freely changed by following the procedures outlined below:

Note: The minimum number of characters between the margins is 20 for Pica pitch, and 24 for Elite pitch.

MARGIN RELEASE

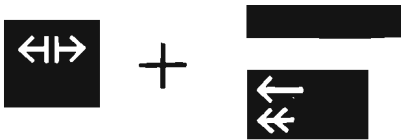

The margin release key is used to move past an existing margin either temporarily for typing or in order to set a new margin. When a presently set margin is reached the carrier will stop. To continue carrier movement past the margin, press the margin release key.

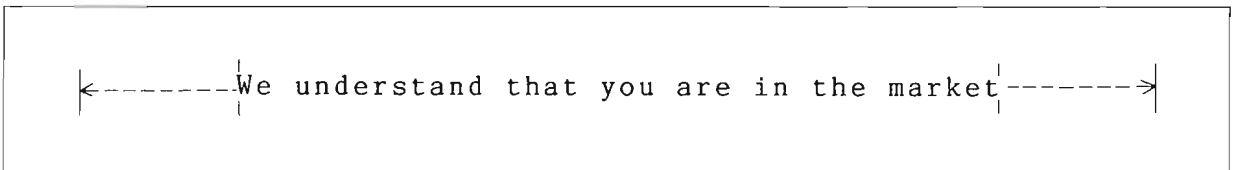

LEFT MARGIN



Use the space bar, backspace key and margin release key as required to bring the carrier to the position at which you desire to set the left margin. Then press the L MAR/R MAR key.

We understand that you are in the market for an electronic typewriter and we would like to take this opportunity to strongly suggest the new AX-10 by Brother. The AX-10 is designed for portable efficiency and is alone in its class.

RIGHT MARGIN

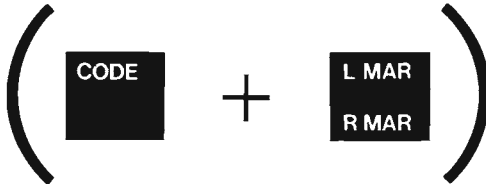

Use the space bar, backspace key and margin release key as required to bring the carrier to the position at which you desire to set the right margin. Then hold down the CODE key as you press the L MAR/R MAR key.

As you type a beep will sound when the carrier reaches the 6th character position from the right margin. When this happens, either press the carrier return at the end of the current word or press the margin release key when you reach the right margin and continue to type.

HOT ZONE

Beep will sound →

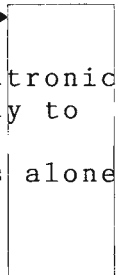

We understand that you are in the market for an electronic typewriter and we would like to take this opportunity to strongly suggest the new AX-10 by Brother. The AX-10 is designed for portable efficiency and is alone in its class.

TAB SET



Use the space bar and the backspace key as required to bring the carrier to the position at which you desire to set a tab. Then press the TAB + key to set the tab. A maximum of 12 tabs can be set any time.



Note: If you change the pitch from Pica to Elite (or Elite to Pica) while you are typing, the tab positions may be slightly altered.

TAB CLEAR

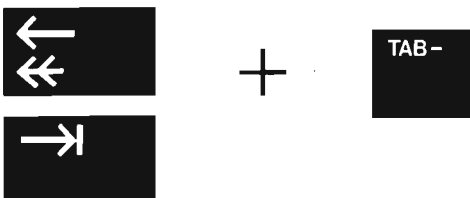

Use the space bar and backspace key, or the TAB key as required to bring the carrier to the position at which you desire to clear a tab. Then press the TAB – key to clear the tab.

ALL TAB CLEAR



To clear all the tabs that have been set, simply move to any tab stop, and press the TAB – key followed by the repeat key.

TYPING FUNCTION

SHIFT

Uppercase characters can be typed when the shift key is pressed. When you release the shift key, the keyboard returns to the lowercase mode. This key is also used to release the shift lock (see below).



!@#\$\$%&*()_+¼[:"°,.,?

REPEAT (SELF REPEAT)

Pressing any key followed by the REPEAT key will continuously repeat the corresponding character or function until the repeat key is released.



AAAAAAAAAAAAAAAAAAAAAAAAAAAAAAAAAAAA

Note: The space bar, backspace and correction keys will repeat their respective functions until released, without having to use the repeat key.

SHIFT LOCK

When you press the shift lock key, the keyboard locks in the uppercase mode and the shift lock indicator lamp comes on. To return to the lowercase mode, press the shift key.



!@#\$\$%&*()_+¼[:"°,.,?

BACKSPACE

Press the backspace key to move one space to the left of the current carrier position.



EXPRESS BACKSPACE

Hold down the code key and press the backspace key to return to the left margin position of the current line.

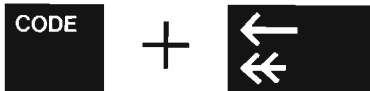

CODE KEY

The characters and functions marked in green on the keyboard can only be used while the CODE key is being held down.



<¶>§^{2 3}

HALF BACKSPACE

This key moves one half space to the left of the current carrier position. The benefit of this key will become evident in the insertion procedure outlined on page 16.



RETURN

Press the return key when you reach the end of a line and want to advance to the beginning of the next line. At this time the paper will be fed the number of lines set with the line space selector. Note that pressing this key also clears the correction memory.



CORRECTION FUNCTIONS

The 40-character correction memory of the AX-10 makes it possible to delete or correct text with the touch of a single key. Manual corrections outside of the memory range are also clean and quick. A handy half backspace function provides added versatility for easy insertion or deletion of extra letters.

MEMORY CORRECTION

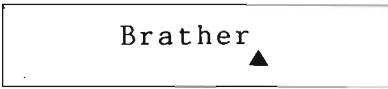
1 

Let's say you mistyped the word "Brother".

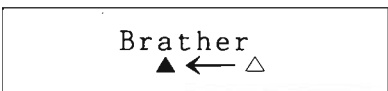
2 

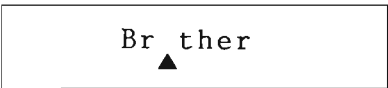

Use the BACKSPACE key to move the carrier back spaces to the position of the "a".

3 



Now all you do is press the correction key and the "a" is erased from the page. If you hold the correction key down, the "r", "B" and all text to the left will continue to be erased until you release the key or you reach the end of the correction memory range.

4 



Type in the correct letter; in this case the letter "o".

5 



Finally, pressing the relocate key brings the carrier back to the position you were at before you began your correction.

MANUAL CORRECTION

Let's say you mistyped "Brother" again, but, this time, the mistake is on a different line or in another position outside of the correction memory range.

1 

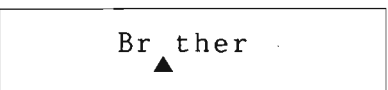

In this case, you should first press the return key to clear the contents of the correction memory. Now use the platen knobs, space bar and backspace key as required to bring the carrier to the position of the error (in this case the "a" of "Brather").

2 



Next, hold down the code key and press the correction key. Now, press the "a" key, and the letter "a" will be erased from the page.

3 



Finally, press "o" to complete the correction.

INSERTION

Often when we get to the end of a typed page we find a word in which we missed a letter or doubled a letter. With the half backspace feature of the AX-10, such mistakes can be corrected while still presenting an overall balanced appearance. The following correction procedures can be performed either using memory correction or manual correction.

As you know, Brther typewriters are

In this case, the letter "o" has been omitted from the word "Brother", so the simple deletion/correction procedure outlined on page 15 cannot be done.

1 Brther ←



First of all, delete the entire misspelled word, "Brther" using the manual correction procedures explained on page 15.

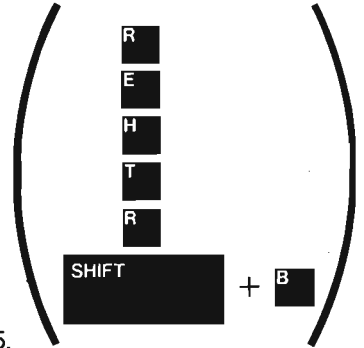

2 Brther ←



After you make sure that the carrier is at the position where the "B" of "Brther" was located, press the half backspace key.

3 Brother →



Now type in the word "Brother" and you can hardly tell that a correction was made.

As you know, Broother typewriters are

Now we have an example where there are too many letters. Just deleting and correcting will leave an extra space either before or after "Brother", resulting in an unbalanced appearance.

1 Broother ←



Again, delete the entire misspelled word.

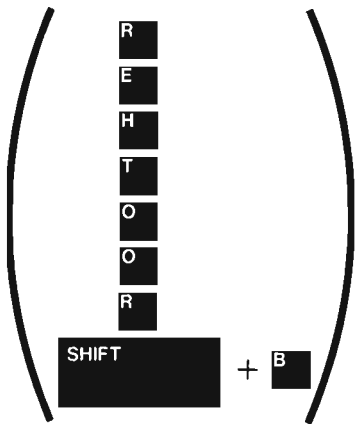

2 Broother ←



Now locate the carrier at the position where the second letter ("r") of "Broother" was located and press the half backspace key.

3 Brother →



Finally, type in the word "Brother".

CARE OF UNIT

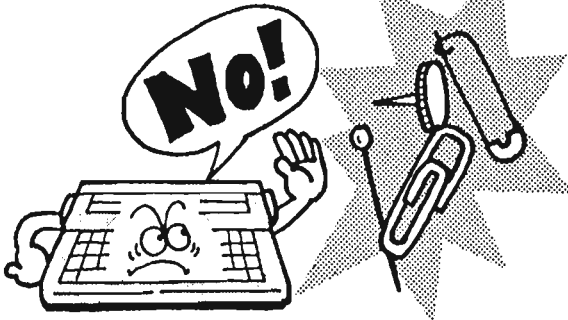

Do not allow any foreign matter to enter the interior of the typewriter or get between the keys. Be especially careful of metal objects such as paper clips and staples.



Never use volatile liquids such as thinner or benzene to clean the exterior surface of the typewriter. Use only a soft cloth dampened with a mild detergent solution.

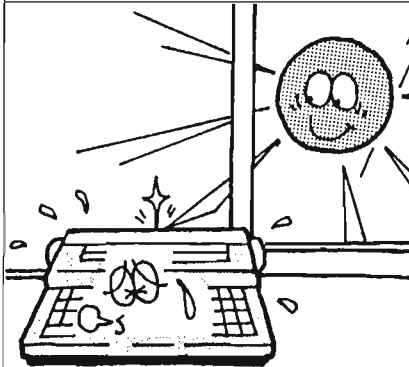

Do not locate your typewriter where it is exposed to direct sunlight, heat or intense vibration.

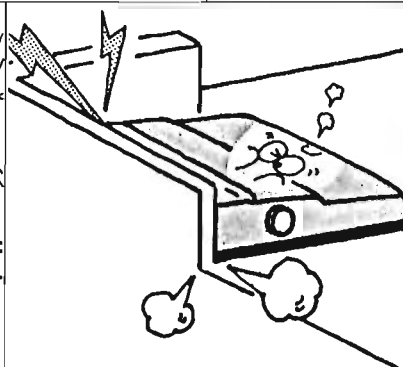

Do not block the ventilation slits provided in the back of the unit to protect against the danger of overheating.

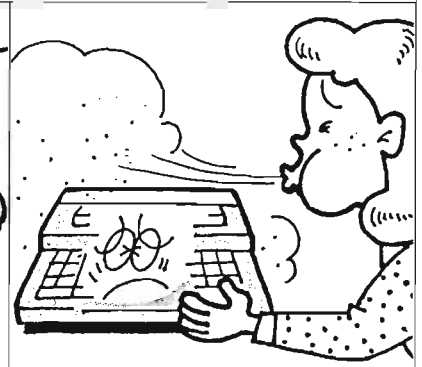

When the typewriter is not in use, be sure to replace the keyboard cover.

TROUBLESHOOTING

If any operational difficulty arises, check below. If the trouble can not be overcome by following these instructions, then consult your Brother dealer.

Typewriter remains at a standstill with the on-off switch set at ON.	<ol style="list-style-type: none"> (1) Make sure the power cord is plugged in. (2) Be sure the top cover is closed.
Printing is faint or does not appear.	<ol style="list-style-type: none"> (1) Be sure daisy wheel is properly set. (2) Check positioning of cassette ribbon. (3) Check to see that the ribbon has not been fully used.
Correction cannot be made.	<ol style="list-style-type: none"> (1) Be sure the correction tape is properly set and passed through the tape guides. (2) Check to see that the correction tape has not been fully used. (3) Be sure the correction tape has been properly selected to match the cassette ribbon.
Cassette ribbon lifts up and remains up (this rarely happens).	Turn the power off first. Then turn it on again while holding down the code key and the pitch selector.

DAISY WHEEL SAMPLES

Pica 10 (Standard Pica)	ABCDEFGHIJKLMNOPQRSTUVWXYZ abcdefghijklmnopqrstuvwxyz 1234567890
Prestige 1012	ABCDEFGHIJKLMNOPQRSTUVWXYZ abcdefghijklmnopqrstuvwxyz 1234567890
Elite 12 (Standard Elite)	ABCDEFGHIJKLMNOPQRSTUVWXYZ abcdefghijklmnopqrstuvwxyz 1234567890
<i>Script 1012</i>	<i>ABCDEFGHIJKLMNOPQRSTUVWXYZ</i> <i>abcdefghijklmnopqrstuvwxyz 1234567890</i>
GRANDE 10	ABCDEFGHIJKLMNOPQRSTUVWXYZ ABCDEFGHIJKLMNOPQRSTUVWXYZ 1234567890
Quadro 1012	ABCDEFGHIJKLMNOPQRSTUVWXYZ abcdefghijklmnopqrstuvwxyz 1234567890
Brougham 10	ABCDEFGHIJKLMNOPQRSTUVWXYZ abcdefghijklmnopqrstuvwxyz 1234567890
Brougham 12	ABCDEFGHIJKLMNOPQRSTUVWXYZ abcdefghijklmnopqrstuvwxyz 1234567890
<i>Prestige Italic 1012</i>	<i>ABCDEFGHIJKLMNOPQRSTUVWXYZ</i> <i>abcdefghijklmnopqrstuvwxyz 1234567890</i>
OCR-A 10	ABCDEFGHIJKLMNOPQRSTUVWXYZ abcdefghijklmnopqrstuvwxyz 1234567890
OCR-B 10	ABCDEFGHIJKLMNOPQRSTUVWXYZ abcdefghijklmnopqrstuvwxyz 1234567890
Letter Gothic 12	ABCDEFGHIJKLMNOPQRSTUVWXYZ abcdefghijklmnopqrstuvwxyz 1234567890

Note: "1012" indicates that the same daisy wheel can be used for both Pica and Elite. "10" indicates Pica pitch only, and "12" indicates Elite pitch only.

Specifications

Number of keys	46 (96 characters)
Print speed	10 cps
Copy capacity	Original + 4 copies
Print element	Cassette daisy wheel (96 chrs.)
Keyboard buffer	31 chrs.
Correction memory	40 chrs.
Line pitch	0, 1, 1½, 2
Print capacity	9" max.
Paper capacity	12" max.
Character pitch	Pica: 10 chrs/inch, 90 chrs/line Elite: 12 chrs/inch, 108 chrs/line
Ribbon	Correctable film Nylon
Correction tape	Lift off Cover up
Tab set capacity	12
Dimensions	15.1" (W) × 12.6" (D) × 4.9" (H) 385.5 (W) × 320 (D) × 124.8 (H) mm
Weight	10.8 lbs./4.9 kg

Accessory Order Form

Dear Customer:

Please use this order form when ordering accessories for your typewriter.
Please enclose check or money order. All prices include shipping and handling charges.

Interchangeable cassette ribbon

Item No.		Price @	Quantity	Total
1030	Correctable Film Ribbon	\$4.95		
1032	Nylon Ribbon	\$5.45		
3010	Lift-Off Correction Tape	\$9.90		
4010	Cover-up Correction Tape	\$9.90		

Cassette daisy wheels

Item No.		Type Pitch	Price @	Quantity	Total
M401	Pica 10 (Standard Pica)	10	\$24.95		
M402	Prestige 1012	10,12	\$24.95		
M403	Elite 12 (Standard Elite)	12	\$24.95		
M405	Script 1012	10, 12	\$24.95		
M408	Grande 10	10	\$24.95		
M409	Quadro 1012	10, 12	\$24.95		
M411	Brougham 10	10	\$24.95		
M412	Brougham 12	12	\$24.95		
M414	Prestige Italic 1012	10, 12	\$24.95		
M415	OCR-B 10	10	\$24.95		
M416	OCR-A 10	10	\$24.95		
M417	Letter Gothic 12	12	\$24.95		

See attached sample pages.

SHIPPING LABEL

Brother International Corporation Typewriter
Division
P.O. Box 159
Piscataway, New Jersey 08854

NAME _____

ADDRESS _____

CITY, STATE, ZIP _____

Sub Total _____

New Jersey and California
residents add applicable sales tax _____

Total _____

Above pricing subject to change without notice.
For any further information on these accessory items, call
toll free 800-526-3537.

JAPAN

BROTHER INDUSTRIES LTD.

Head Office

35, 9-chome, Horita-Dori,
Mizuho-ku, Nagoya 467, Japan
TEL: (052) 824-2511
CABLE: BROTHER NAGOYA

Kamimaezu Office**Business Machines Div.**

46-15, Ohsu 3-chome,
Naka-ku, Nagoya 460
TEL: (052) 263-5821

BROTHER INTERNATIONAL
CORPORATION**Head Office**

No. 3-8, 3-chome, Kyobashi
Chuo-ku, Tokyo, 104, Japan
TEL: (03) 281-6521

U.S.A.BROTHER INTERNATIONAL
CORPORATION**Headquarters and****Eastern Regional Office**

8 Corporate Place, Piscataway,
New Jersey 08854
TEL: (201) 981-0300

Western Regional Office

20 Goodyear Irvine, California 92714
TEL: (714) 859-9700.

CANADABROTHER INTERNATIONAL CORP.
(CANADA) LTD.**Head Office**

1515 Pittfield Blvd., Montreal,
Quebec H4S 1G5
TEL: (514) 334-5590

Toronto Office

1947 Leslie Street, Don Mills,
Ontario M3B 2M3
TEL: (416) 445-2714

Vancouver Office

7611 Alderbridge Way, Richmond,
BC V6X 1Z9
TEL: (064) 273-8466

ENGLANDBROTHER INTERNATIONAL
EUROPE LTD.

Shepley Street, Guide Bridge,
Audenshaw, Manchester M34 5JD.
TEL: 061-330-6531

JONES SEWING MACHINE CO., LTD.

Shepley Street, Guide Bridge,
Audenshaw, Manchester M34 5JD.
TEL: 061-330-6531

WEST GERMANY

BROTHER INTERNATIONAL

G.m.b.H.
Im Rosengarten 14, D-6368, Bad Vilbel.
TEL: 06101-8050

BROTHER INTERNATIONALE
INDUSTRIEMASCHINEN G.m.b.H.

D-424 Emmerich am Rhein,
Dusseldorfstr.
TEL: 010-492-822-5016

IRELANDBROTHER INTERNATIONAL
CORPORATION (IRELAND) LTD.

Newtown Industrial Estate, Malahide Road,
Coolock, Dublin 5.
TEL: 477333

BROTHER INTERNATIONAL
CORPORATION (EUROPE) LTD.

Shannon Airport House,
Shannon, Co. Clare
TEL: 061-62711

FRANCE

BROTHER FRANCE S.A.

8, Rue Nicolas Robert,
93602 Aulnay-sous-Bois Cedex
TEL: 869-96-16

NETHERLANDSBROTHER INTERNATIONAL
(NETHERLAND) B.V.

Zanderij 25-27
Industrie-Terrein Legmeer
Amstelveen
TEL: 020-474471

DENMARKBROTHER INTERNATIONAL
MASKINAKTIESELSKAB A/S
Baidersbaekvej 18 DK 2635 ISHOJ
TEL: 02 525600**PORTUGAL**BROTHER INTERNATIONAL
(PORTUGAL) DISTRIBUIDORES DE
EQUIPAMENTOS ELECTRICOS LDA.

Rua Bulhao Pato, 3D 1700
Lisboa
TEL: 89-97-75

AUSTRIABROTHER INTERNATIONAL
G.m.b.H.

Darmautgasse 13, 1120 wien
TEL: 222-855276

BELGIUMS.A. BROTHER INTERNATIONAL
(BELGIUM) N.V.

Rue J Tieboutstraat 67,
1730 Zellik, Brussels.
TEL: 02-4651946

SWITZERLANDBROTHER HANDELS A.G.
Taefernstrasse 30, 5405 Baden
TEL: 056/84 02 21**NORWAY**

BROTHER NORGE A.S.

Stenersgaten 22, Oslo 1.
TEL: 422179

KOREA

PUSAN PRECISION INDUSTRIES, LTD.

Factory

820-2, Pukok-Dong, Tongnae-Ku, Pusan
TEL: 56-7204

Head Office

No. 118, 2-Ka, Namdaemoon-Ro,
Chung-ku, Seoul
TEL: 752-0305/9

TAIWAN

TAIWAN BROTHER INDUSTRIES, LTD.

P.O. Box 35-94, Nantze Export Processing
Zone, Kaohsiung
TEL: 07-3613111

SINGAPOREBROTHER INDUSTRIES (S) PTE. LTD.
01-02 GSM Building, Ground Floor,
141 Middle Road, Singapore 0718.
TEL: 3389911**AUSTRALIA**BROTHER INDUSTRIES (AUST.)
PTY. LTD.**Head Office**

7 Khartoum Road
North Ryde, N.S.W. 2113
TEL: (02) 887-4344

Victoria Office

16 Thornton Crescent
Mitcham, VIC. 3132
TEL: (03) 873-3655

Queensland Office

19 Thompson Street, Mayne,
QLD. 4006
TEL: (07) 52-5257

South Australia Office

101 King William Street, Kent Town,
S.A. 5067
TEL: (08) 42-6373

Western Australia Office

Unit 2, 78 Daly Street, Belmont,
W.A. 6104
TEL: (09) 478-1955

BRAZILBROTHER INTERAMERICANA LTDA.
01216 Alameda Nothmann 354 Sao Paulo-SP
TEL: 223-2211

FLIAIS: Rio de Janeiro/Porta Alegre/Fortaleza
Distribuidores Autorizados em todo Brazil.

ELGIN BROTHER INDUSTRIAL LTDA.
Rua Barão de Campinas, 305 01201 Sao Paulo
TEL: 220-1611 (PABX)

BROTHER INDUSTRIES, LTD.

Business Machines Div. 46-15, Ohsu 3-chome, Naka-ku, Nagoya 460 JAPAN TEL: (052) 263-5821

Free Manuals Download Website

<http://myh66.com>

<http://usermanuals.us>

<http://www.somanuals.com>

<http://www.4manuals.cc>

<http://www.manual-lib.com>

<http://www.404manual.com>

<http://www.luxmanual.com>

<http://aubethermostatmanual.com>

Golf course search by state

<http://golfingnear.com>

Email search by domain

<http://emailbydomain.com>

Auto manuals search

<http://auto.somanuals.com>

TV manuals search

<http://tv.somanuals.com>