

**FAX-235**  
**FAX-236**  
**FAX-335MC**

.....  
**brother**

## If You Need to Call Customer Service

Please complete the following information for future reference:

Model: FAX-235 FAX-236 FAX-335MC  
(Circle your model number)

Serial Number:\* \_\_\_\_\_

Date of Purchase: \_\_\_\_\_

Place of Purchase: \_\_\_\_\_

\* The serial number is on the underside of the unit. Retain this Owner's Manual with your sales receipt as a permanent record of your purchase, in the event of a theft, fire or warranty service.

## Compilation and Publication Notice

Under the supervision of Brother Industries, Ltd., this manual has been compiled and published, covering the latest product descriptions and specifications.

The contents of this manual and the specifications of this product are subject to change without notice.

Brother reserves the right to make changes without notice in the specifications and materials contained herein and shall not be responsible for any damages (including consequential) caused by reliance on the materials presented, including but not limited to typographical and other errors relating to the publication.

## Trademarks

The Brother logo is a registered trademark of Brother Industries, Ltd.

Brother is a registered trademark of Brother Industries, Ltd.

**All other terms and brand and product names mentioned in this manual are registered trademarks of their respective companies.**

# Table of contents

---

## 1

<b>Introduction .....</b>	<b>1-1</b>
Using This Manual .....	1-1
Finding Information .....	1-1
About fax machine .....	1-1
Fax Tones and Handshake .....	1-2
ECM (Error Correction Mode) (For FAX-335MC Only) ..	1-2
FAX-235 and FAX-236 Control Panel Overview .....	1-3
FAX-335MC Control Panel Overview .....	1-4

## 2

<b>Location and Connections .....</b>	<b>2-1</b>
Caution .....	2-1
Packing List .....	2-1
Choosing a Location .....	2-2
Assembly .....	2-2
Load the recording paper .....	2-2
About Brother Paper .....	2-4
Connections .....	2-4
Connecting the Machine .....	2-4
Attach the document support .....	2-5
Multi-Line Connections (PBX) .....	2-6
If you are installing the fax machine to work with a PBX: ..	2-6
Custom Features on a Single Line .....	2-6
Connecting an External Telephone Answering Device (TAD) (TAD Cannot Be Connected in Some Countries) .....	2-7
Sequence .....	2-7
Connections .....	2-8
Outgoing Message (OGM) .....	2-8
Connecting an External Telephone .....	2-8

## 3

<b>On-Screen Programming .....</b>	<b>3-1</b>
User-Friendly Programming .....	3-1
Function Mode .....	3-1
Alternating Displays .....	3-1
Function Selection Table .....	3-2

<b>Initial Setup .....</b>	<b>4-1</b>
Getting Started .....	4-1
Setting Dialing Mode (Tone/Pulse) .....	4-1
Setting Date and Time .....	4-1
Setting Station ID .....	4-2
Details for Entering Text .....	4-2
Inserting spaces .....	4-2
Making corrections .....	4-3
Repeating letters .....	4-3
Special characters and symbols .....	4-3
Setting Beeper Volume .....	4-4
Setting the Speaker Volume .....	4-4
Setting the Ring Volume .....	4-4
Memory Storage .....	4-4
Key Lock System .....	4-5
Using Key Lock System .....	4-5
Setting Up the Key Lock System for the First Time .....	4-5
Changing the Key Lock System Password .....	4-6
Switching Key Lock System ON .....	4-6
Switching OFF Key Lock System .....	4-7

<b>Setup Receive .....</b>	<b>5-1</b>
Basic Receiving Operations .....	5-1
Select Answer Mode.....	5-1
To select or change your Answer Mode .....	5-2
Setting Ring Delay .....	5-3
Setting Melody for Rings (FAX-335MC only) .....	5-3
Setting F/T Ring Time .....	5-4
Record FAX/TEL Outgoing Announcement (F/T OGM)	
(For FAX-335MC only) .....	5-4
Fax Detect .....	5-5
Advanced Receiving Operations .....	5-6
Operation from External or Extension Telephone.....	5-6
For FAX/TEL Mode Only .....	5-6
Remote Call Transfer (Semi-DECT Management) .....	5-6
To transfer telephone call to the fax machine .....	5-6
Changing Remote Codes .....	5-7
Polling .....	5-7
Setting Up Polling Receive .....	5-8
Setting Up Delayed Polling Receive .....	5-8

Setup for Polling Receive with Secure Code .....	5-9
Setting Up Sequential Polling Receive (For FAX-335MC Only) .....	5-9

## 6

<b>Setup Send .....</b>	<b>6-1</b>
Automatic Document Feeder (ADF) .....	6-1
ADF (Automatic Document Feeder) .....	6-1
Manual Transmission .....	6-2
Automatic Transmission .....	6-2
Manual and Automatic Fax Redial .....	6-2
Memory Transmission (For FAX-335MC Only) .....	6-2
Basic Sending Operations .....	6-3
Composing Electronic Cover Page (For FAX-236/335MC Only) .....	6-3
Cover Page for Next Fax Only (For FAX-236/335MC Only) .....	6-4
Always Send Cover Page (For FAX-236/335MC Only) ...	6-4
Using a Printed Cover Page (For FAX-236/335MC Only)	6-5
Cover Page Message (For FAX-236/335MC Only) .....	6-5
Composing Your Own Comments (For FAX-236/335MC Only) .....	6-6
Contrast.....	6-6
Resolution .....	6-6
Advanced Sending Operations .....	6-7
Overseas Mode .....	6-7
Call Reservation (For FAX-236/335MC Only) .....	6-7
Print Sample Call Back Message (For FAX-236/335MC Only) .....	6-8
TIMER .....	6-8
Next-Fax Reservation (For FAX-236/335MC Only) .....	6-9
Multiple Resolution Transmission .....	6-9
Setting Up for Polled Transmit .....	6-10
Canceling a Scheduled Job .....	6-10
Interrupting Timer and Polled Transmit Jobs .....	6-11

## 7

<b>QUICK-DIAL Numbers and Dialing Options .....</b>	<b>7-1</b>
Storing Numbers for Easy Dialing .....	7-1
Storing One Touch Dial Numbers/Storing Junk Fax/Call Numbers .....	7-1

Storing Speed Dial Numbers/Storing Junk Fax/Call	
Numbers .....	7-2
Changing One Touch and Speed Dial Numbers .....	7-3
Setting Up Groups for Broadcasting	
(For FAX-335MC Only) .....	7-3
Dialing Options .....	7-4
Manual Dialing .....	7-4
One Touch Dialing .....	7-5
Speed Dialing .....	7-5
Search .....	7-6
Redial .....	7-6
Answering Calls with the Speaker phone	
(For FAX-335MC Only) .....	7-6
Broadcasting (For FAX-335MC Only) .....	7-6
Pause .....	7-7
Hold .....	7-7
Tone/Pulse .....	7-7

## 8

<b>Telephone Services .....</b>	<b>8-1</b>
Custom Features .....	8-1
Distinctive Ring (For Singapore and Hong Kong) .....	8-1
Setting the Distinctive Ring .....	8-2
Caller ID (For Singapore and Hong Kong) .....	8-2
Caller ID Log .....	8-2
Printing the Caller ID Log .....	8-3
Viewing the Caller ID Log .....	8-3
Returning a Call from the Log .....	8-3
Registering a Caller ID Number .....	8-4

## 9

<b>Message Center (For FAX-335MC Only) .....</b>	<b>9-1</b>
Message Center Mode .....	9-1
Flexible Memory Settings (Message Store) .....	9-1
Setting Up the Message Center .....	9-2
Setting Message Store .....	9-2
Recording Message Center Outgoing Message .....	9-2
Listening to Outgoing Message (OGM) .....	9-3
Erasing Outgoing Message (OGM) .....	9-3
Activating Message Center Mode .....	9-3
Message Indicator .....	9-3
Playing Voice Messages .....	9-4

Printing a Fax Message .....	9-4
Backup Printing Option .....	9-4
Erasing Messages .....	9-4
To erase voice messages individually .....	9-5
To erase messages all at once .....	9-5
Setting Maximum Time for Incoming Messages .....	9-5
Setting Toll Saver .....	9-5
ICM Recording Monitor .....	9-6
Recording a Conversation .....	9-6
Fax Forwarding/Paging .....	9-6
Programming a Fax Forwarding Number .....	9-6
Recording the Paging Outgoing Message (OGM) .....	9-7
Programming Paging Number .....	9-7
Remote Retrieval .....	9-8
Using Remote Retrieval Access Code .....	9-8
Changing Remote Retrieval Access Code .....	9-8
Remote Commands .....	9-9
Retrieving Memory Status List .....	9-11
Retrieving Fax Messages .....	9-11
Changing Fax Forwarding Number .....	9-12

## 10

<b>Making Copies .....</b>	<b>10-1</b>
Copy Functions .....	10-1
Making a Single Copy .....	10-1
Copy Options: Single or Multiple Copies, Sort/Stack (For Fax-335MC Only) .....	10-1

## 11

<b>Printing Reports .....</b>	<b>11-1</b>
Fax machine Settings and Activity .....	11-1
To Print a Report .....	11-1
Transmission Verification Report .....	11-2
JOURNAL Interval .....	11-2

## 12

<b>Important Information .....</b>	<b>12-1</b>
Important Safety Instructions .....	12-1

## 13

<b>Troubleshooting and Maintenance .....</b>	<b>13-1</b>
Troubleshooting .....	13-1
Error Messages .....	13-1
Recording Paper Jam .....	13-4

If You Are Having Difficulty with Your Fax Machine ....	13-4
Printing or Receiving Faxes .....	13-4
Phone Line or Connections .....	13-5
Sending Faxes .....	13-5
Handling Incoming Calls .....	13-6
<b>Specifications .....</b>	<b>S-1</b>
<b>Glossary .....</b>	<b>G-1</b>
<b>Index .....</b>	<b>I-1</b>
<b>Using Remote Retrieval Access Code (For FAX-335MC Only)</b>	<b>R-1</b>



# 1 Introduction

## *Using This Manual*

---

Thank you for purchasing a Brother fax machine. This fax machine has been designed to be simple to use, with LCD screen prompts to guide you through functions. However, you can use your fax machine to its fullest potential by taking a few minutes to read this manual.



Additionally, your fax machine has a Help Key. Press **Copy/Help** and then press **Start** to print a list of basic operational steps and functions.

## **Finding Information**

All chapter headings and subheadings are listed in the Table of Contents. You will be able to find information about a specific feature or function by checking the Index at the back of this manual. Also, throughout this manual, you'll see special symbols alerting you to important information, cross-references, and warnings. Illustrations of some screen displays also help you choose the correct key-presses.

## *About fax machine*

---

If you're a first-time fax machine user, fax operation might seem a little mysterious. You'll soon get used to the unusual fax tones on your phone line, and be able to send and receive faxes easily.

## Fax Tones and Handshake

When someone is sending a fax, the fax machine sends fax calling tones (CNG tones)—soft, intermittent beeps at 4-second intervals. You'll hear them when you dial and press **Start**, and they continue for about 40 seconds after dialing. During that time, the sending machine must begin the “handshake” with the receiving machine. Each time you use automatic procedures to send a fax, you are sending CNG tones over the phone line. You'll soon learn to listen for these soft beeps each time you answer a phone on your fax line, so you know if you are receiving a fax message.

The receiving fax responds with fax receiving tones—loud, chirping sounds. A receiving fax chirps for about 40 seconds over the phone line, and the screen displays **RECEIVE**. If your fax machine is set to the **FAX ONLY Mode**, it will answer every call automatically with fax receiving tones. Even if the other party hangs up, your fax machine continues to send the “chirps” for about 40 seconds, and the screen continues to display “**RECEIVE**”. To cancel the receiving mode, press **Stop**.

When your fax machine answers in **FAX/TEL Mode**, the fax machine listens for CNG tones and then responds with receiving tones.

The fax “handshake” is the time in which the sending machine's CNG tones and the receiving machines “chirps” overlap. This must be for at least 2 to 4 seconds, so the machines can understand how each is sending and receiving the fax. The handshake cannot begin until the call is answered, and the CNG tones only last for about 40 seconds after the number is dialed. Therefore, it's important for the receiving machine to answer the call in as few rings as possible.



When you have an external telephone answering device (TAD) on your fax line, your TAD will determine the number of rings before the call is answered. Pay special attention to the directions in the **Installation** chapter for connecting a TAD to your fax machine.

## ECM (Error Correction Mode) (For FAX-335MC Only)

The Error Correction Mode (ECM) is a way for the fax machine to check the integrity of a fax transmission while it is in progress. ECM transmissions are possible only between machines that both have the ECM feature. If they do, you may send and receive fax messages that are continuously checked for their integrity.

Sufficient memory must be available in your fax machine for this feature to work.

# FAX-235 and FAX-236 Control Panel Overview

(FAX-236 panel is the same as FAX-235)

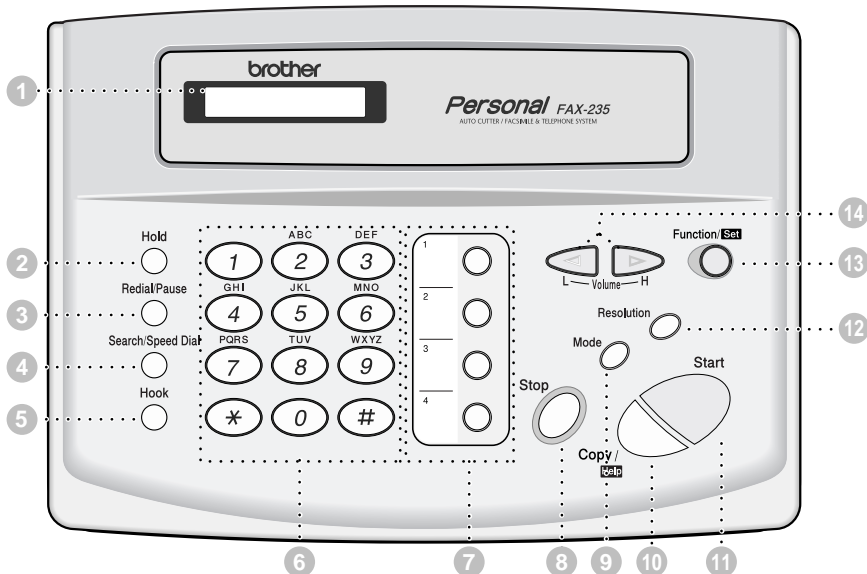

## 1 LCD (Liquid Crystal Display)

Displays messages to help you set up and operate your fax machine.

## 2 Hold

Lets you put calls on hold. Also, lets you view or print the Caller ID list. (For Singapore and Hong Kong only)

## 3 Redial/Pause

Re-dials the last number called. Also inserts a pause in autodial numbers.

## 4 Search/Speed Dial

Lets you dial stored phone numbers by pressing # and a two-digit number. Also lets you look up numbers stored in the dialing memory.

## 5 Hook

Lets you dial telephone and fax numbers without lifting the handset.

## 6 Dial Pad

Dials phone and fax numbers, and can be used as a keyboard for entering information into the fax machine.

## 7 One Touch Dial Keys

These four keys give you instant access to previously stored phone numbers.

## 8 Stop

Stops a fax, cancels an operation or exits from Function mode.

## 9 Mode

Use to select how fax machine will handle incoming calls.

## 10 Copy/Help

Makes a copy. If no originals are in the ADF, it prints a quick reference Help List.

## 11 Start

Starts an operation, such as sending a fax.

## 12 Resolution

Sets the resolution when you send a fax or make a copy.

## 13 Function/Set

Lets you access the function and programming mode. Also, stores a function setting into the fax machine.

## 14 ◀ (Left Arrow) ▶ (Right Arrow) Volume

Moves the LCD cursor to the left or right. Adjusts speaker and ring volume.

# FAX-335MC Control Panel Overview

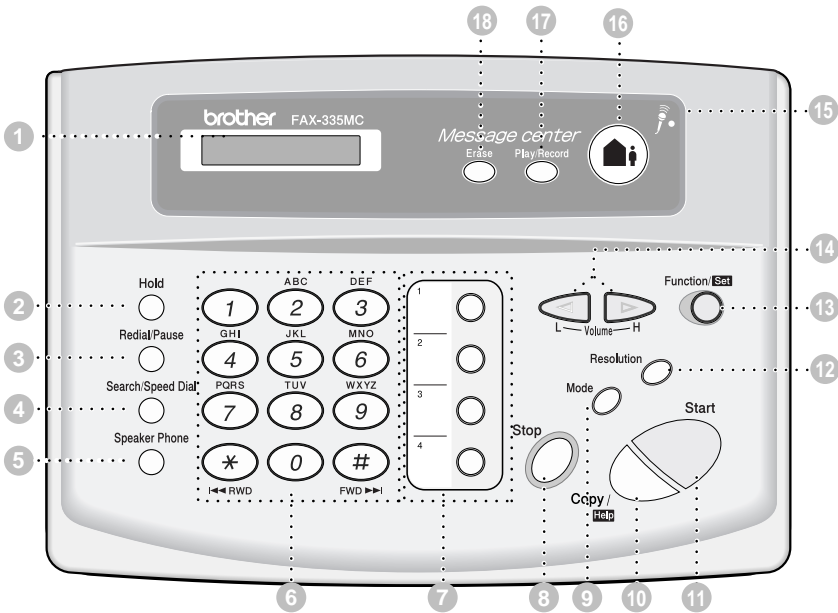

## 1 LCD (Liquid Crystal Display)

Displays messages to help you set up and operate your fax machine.

## 2 Hold

Lets you put calls on hold. Also, lets you view or print the Caller ID list. (For Singapore and Hong Kong only)

## 3 Redial/Pause

Re-dials the last number called. Also inserts a pause in autodial numbers.

## 4 Search/Speed Dial

Lets you dial stored phone numbers by pressing # and a two-digit number. Also lets you look up numbers stored in the dialing memory.

## 5 Speaker Phone

Lets you speak to the person at the other end and dial telephone numbers without lifting the handset.

## 6 Dial Pad

Dials phone and fax numbers, and can be used as a keyboard for entering information into the fax machine.

## 7 One Touch Dial Keys

These four keys give you instant access to previously stored phone numbers.

## 8 Stop

Stops a fax, cancels an operation or exits from Function mode.

## 9 Mode

Use to select how fax machine will handle incoming calls.

## 10 Copy/Help

Makes a copy. If no originals are in the ADF, it prints a quick reference Help List.

## 11 Start

Starts an operation, such as sending a fax.

## 12 Resolution

Sets the resolution when you send a fax or make a copy.

## 13 Function/Set

Lets you access the function and programming mode.

Also, stores a function setting into the fax machine.

## 14 ◀ (Left Arrow) ▶ (Right Arrow) Volume

Moves the LCD cursor to the left or right. Adjusts speaker and ring volume.

## 15 Microphone

Picks up your voice when you speak to another party using speakerphone.

## 16 MC ON/OFF

Lets you activate the Message Center. Also, notifies you that you have voice or fax messages in the memory.

## 17 Play/Record

Lets you listen to voice messages and print fax messages stored in memory. Also, lets you record telephone calls.

## 18 Erase

Lets you delete voice messages, fax messages or all messages.

# 2

## Location and Connections

### Caution

- 1 Never install telephone wiring during a lightning storm.
- 2 We recommend that this product be used with a surge protection device to protect the product against lightning storms.
- 3 Never install a telephone jack in a wet location unless the jack is specifically designed for a wet location.
- 4 Never touch telephone wires or terminals that are not insulated unless the telephone line has been disconnected at the network interface.
- 5 Use caution when installing or modifying telephone lines.
- 6 Avoid using a telephone (other than a cordless type) during an electrical storm. There may be a remote risk of electric shock from lightning.
- 7 Do not use the telephone to report a gas leak in the vicinity of the leak.
- 8 For **PLUGGABLE EQUIPMENT**, the socket-outlet should be installed near the equipment and should be easily accessible.

### Packing List

Check that you have the following items:

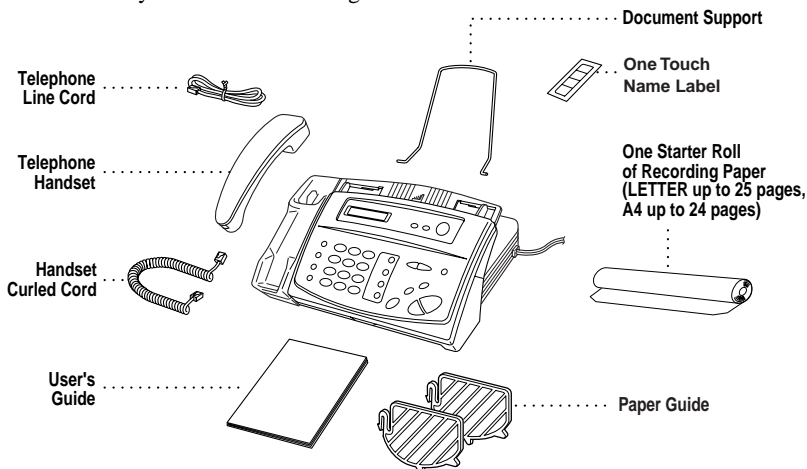

Keep the packing materials for possible future transport. If you do not pack the machine properly, it may void your warranty.

## Choosing a Location

Place your fax machine on a flat, stable surface, such as a desk. Select a place that is free of vibration and shocks. Locate the fax machine near a telephone jack and a standard, grounded power outlet.

- ⊘ Avoid placing your machine in a high-traffic area. Do not place near heaters, air conditioners, water, chemicals or refrigerators. Do not expose the fax machine to direct sunlight, excessive heat, moisture or dust. Do not connect your machine to electrical outlets controlled by wall switches or automatic timers. Disruption of power can wipe out information in the unit's memory. Do not connect your machine to electrical outlets on the same circuit as large appliances or other equipment that might disrupt the power supply. Avoid interference sources, such as speakers or the base units of cordless phones.

## Assembly

### Load the recording paper

- 1 Open the cover by placing your finger in the groove under the cover and lifting up.



- 2 Pull up the blue release lever so you can remove the two protective sheets (initial set up) or any paper remaining in the machine from the last roll.
- 3 Unwrap the new recording paper roll and insert it into the paper bin, with the paper feeding from the bottom of the roll.

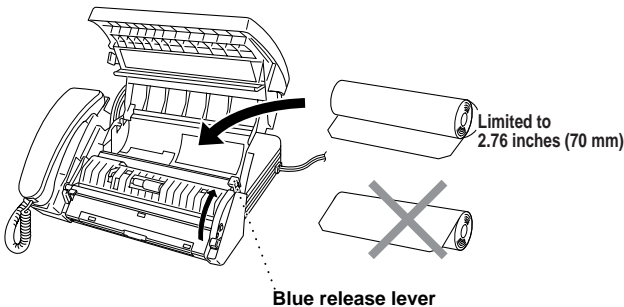



When you use 210mm recording paper roll size...

There are two different types of recording paper roll size (216mm/210mm). If you use 210mm recording paper roll size, please set recording paper after attaching the paper guides as below.

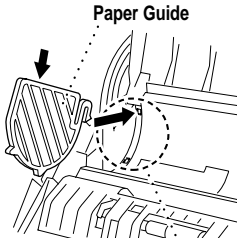

Setting position

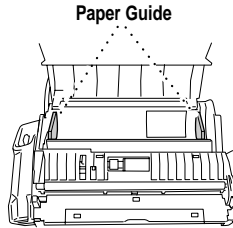

- 4 Raise the paper enough to pass it over the ↓ until it feeds out the front of the machine. Make sure there is no slack.

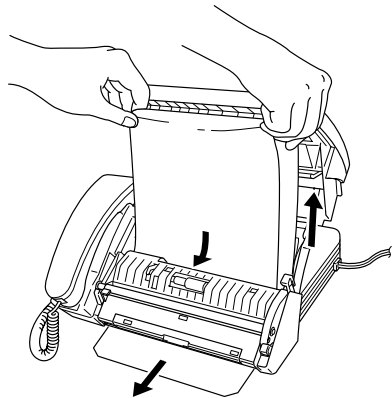

- 5 Pull down the blue lever and close the cover.

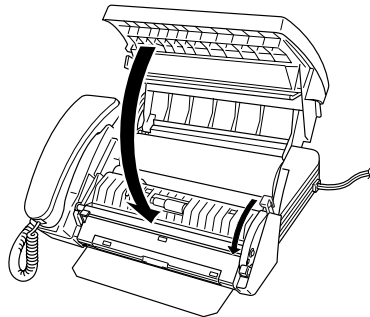

## About Brother Paper

For the best print quality, use Brother Therma Plus Paper, Item Numbers 6890 (two 98' rolls) or 6840 (four 98' rolls). Therma Plus paper is thicker, like plain paper, and produces the best print quality.



The recording paper roll size for your fax machine is limited to a diameter of 2.76 inches (70 mm). You can use a 164' roll of thinner thermal paper as long as it meets these requirements.

## Connections

---

### Connecting the Machine

Connect the handset, power cord, and telephone line.

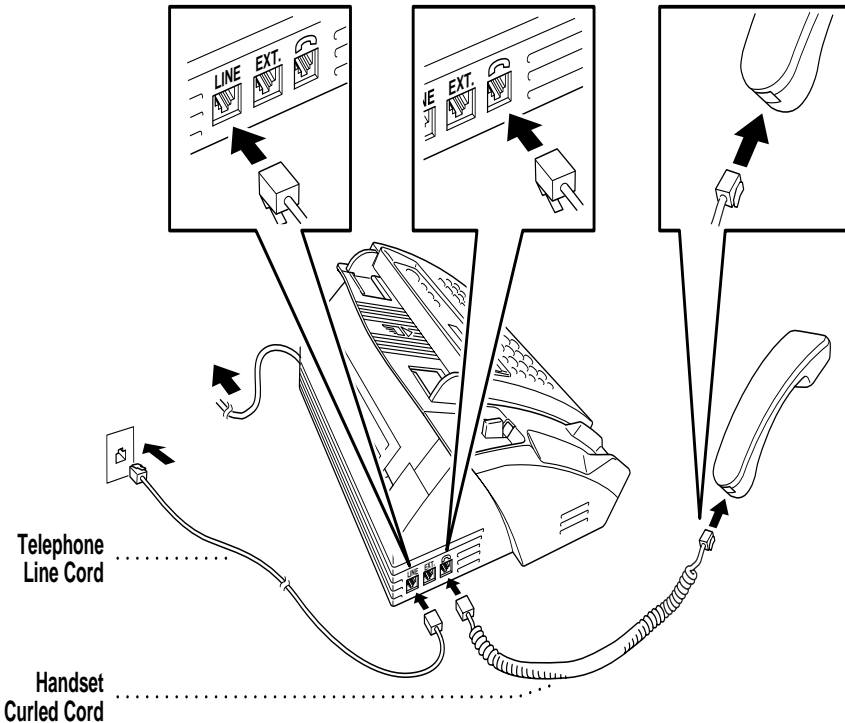



### **1 Connect the handset**

Connect the curled handset cord to the bottom of the handset and the side of the fax machine.

### **2 Connect the power cord.**

### **3 Connect the telephone line.**

Connect one end of the telephone line cord to the jack labeled **LINE** on the left side of the machine. Connect the other end to a modular wall jack.

## **⚠ WARNING**

- This machine must be grounded using a three-prong plug.
- Since the machine is grounded through the power outlet, you can protect yourself from potentially hazardous electrical conditions on the telephone line by keeping the power to your machine on when you connect it to a telephone line. When you want to move your machine, protect yourself by disconnecting the telephone line first, and then the power cord.
- Lightning and power surges can damage this product! We recommend that you use a quality surge protection device on the AC power line as well as on the telephone line, or unplug the lines during a lightning storm.

## **Attach the document support**

Attach the document support as shown in the illustration below.

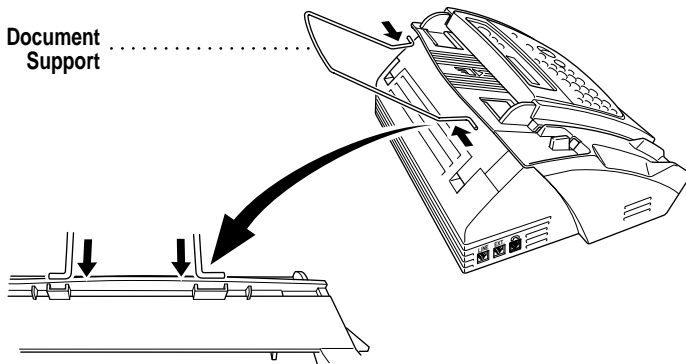

## Multi-Line Connections (PBX)

Most offices use a central telephone system. While it is often relatively simple to connect the fax machine to a key system or a PBX (Private Branch Exchange), we suggest that you contact the company that installed your telephone system and ask them to connect the fax machine for you. It is advisable to have a separate line for the fax machine. You can then leave the fax machine in FAX ONLY Mode to receive faxes any time of day or night.

If the fax machine is to be connected to a multi-line system, ask your installer to connect the unit to the last line on the system. This prevents the unit from being activated each time a telephone call is received. (See *Fax Detect*, page 5-5.)

- ⊘ As with all fax units, this machine must be connected to a two wire system. If your line has more than two wires, proper connection of the fax machine cannot be made.

### **If you are installing the fax machine to work with a PBX:**

- 1** It is not guaranteed that the unit will operate correctly under all circumstances with a PBX. Any cases of difficulty should be reported first to the company that handles your PBX.
- 2** If all incoming calls will be answered by a switchboard operator, it is recommended that the Answer Mode be set to MANUAL. All incoming calls should initially be regarded as telephone calls.
- 3** The unit may be used with either pulse or tone dialing telephone service.

## Custom Features on a Single Line

If you have Call Waiting, Ring Master, Voice Mail, an answering service, alarm system or any other custom feature on your telephone line, it may create a problem in the operation of your fax machine.

# Connecting an External Telephone Answering Device (TAD) (TAD Cannot Be Connected in Some Countries)

## Sequence

You might choose to connect an additional answering system. When you have an external TAD on the same telephone line as the fax machine, the TAD answers all calls. The fax machine “listens” for fax calling (CNG) tones. If it hears them, the fax machine takes over the call and receives the fax. If it doesn’t hear CNG tones, the fax machine lets the TAD continue playing your outgoing message so your caller can leave you a voice message.

The TAD must answer within four rings (the recommended setting is two rings). The fax machine cannot hear CNG tones until the TAD has answered the call, and with four rings there are only 8–10 seconds of CNG tones left for the fax “handshake”. Make sure you carefully follow instructions in this manual for recording your outgoing message. We do not recommend using the toll saver feature on your external answering machine if it exceeds 4 rings.

- ⊘ Do not connect a TAD elsewhere on the same phone line—your fax machine and TAD will both try to control the line.

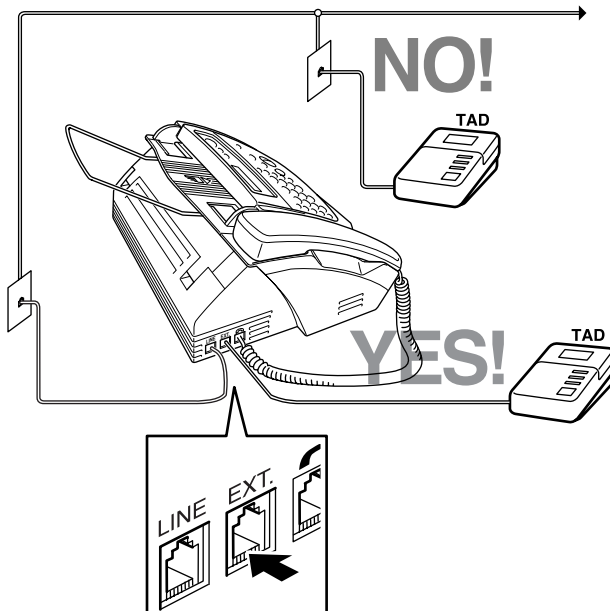

## Connections

The external TAD must be plugged into the left side of the fax machine, into the jack labeled EXT. Your fax machine cannot work properly if you plug the TAD into a wall jack.

- 1** Plug the telephone line cord from the wall jack into the left side of the fax machine, in the jack labeled LINE.
- 2** Plug the telephone line cord from your TAD into the left side of the fax machine, in the jack labeled EXT. (Make sure this cord is connected to the TAD at the TAD's telephone line jack (not to telephone set jack).)
- 3** Set your external TAD to four rings or less. (The fax machine's Ring Delay setting does not apply.)
- 4** Record the outgoing message (see below).
- 5** Set the TAD to answer calls.
- 6** See Message Storage (**Function/Set, 8, 1**) to VOICE:EXT. (For FAX-335MC only)
- 7** Set the Answer Mode to MC:MSG CTR. (For FAX-335MC only)  
On the FAX-235 or FAX-236, set the Answer Mode to TAD:ANSWER MACH.

## Outgoing Message (OGM)

Timing is important in recording this message. The message sets up the ways to handle both manual and automatic fax reception.

- 1** Record 5 seconds of silence at the beginning of your message. (This allows your fax machine time to listen for the fax CNG tones of automatic transmissions before they stop.)
- 2** Limit your speaking to 20 seconds.
- 3** End your 20-second message by giving your Fax Receive Code for people sending manual faxes. For example:  
"After the beep, leave a message or send a fax by pressing \* 5 1 and Start."

## Connecting an External Telephone

Your fax machine is equipped with a handset that you can use as a regular phone. However, you can also connect a separate telephone (or telephone answering device) directly to your fax machine.

Connect the modular plug on the telephone's line cord to the jack labeled EXT. on the left side of the fax machine.

Whenever this phone (or TAD) is in use, the screen displays EXT. TEL IN USE, and, if the fax machine handset is lifted, an alarm sounds. To disconnect the call and switch to the fax machine, press **Hook** or **Speaker Phone**.



**External Telephone can not be connected in some countries.**

# 3

# On-Screen Programming

## User-Friendly Programming



---

We have designed your fax machine with on-screen programming and a Help key. User-friendly programming helps you take full advantage of all the functions your fax machine has to offer. (See *Using This Manual*, page 1-1.)

Since your fax programming is done on the LCD, we created step-by-step on-screen prompts to help you program your fax machine. All you need to do is follow the prompts as they guide you through the function menu selections and programming options and settings.

### Function Mode

You can access the function mode by pressing **Function/Set**. When you enter the function mode, your fax machine displays a list of main menu options from which you can choose. These options appear one after the other on the display. Select a menu option by pressing **Function/Set** when the option appears on the screen. The display will scroll the options within that menu.

You can “scroll” more quickly through options by pressing . When the screen displays your selection, press **Function/Set**. (Press  to scroll backward if you passed your choice or to save key strokes. Both arrow keys show all options, in the opposite order.)

Before you press **Function/Set** after entering information in a field using the dial pad, you can correct a mistake. Use  to back up and then type over the incorrect characters.



When you finish a function, the screen displays **ACCEPTED**.

If you want to exit the Function mode, press **Stop**.

### Alternating Displays

When you see alternating displays, the LCD sometimes alternates between the currently selected option, and a help message giving brief instructions about how to proceed. The display you’ll probably see most often is shown below, showing you, when you place an original in the ADF, that you can dial a number and send a fax, or you can make a copy.



## Function Selection Table

If you have a basic understanding of how to program your fax machine, you can perform most of the programming settings without the Owner's Manual. To help you understand the function selections, options, and settings that are found in your fax programs, use the Function Selection Table below.

Main Menu	Menu Selections	Options	Description	More Info
<b>1. INITIAL SETUP</b>	<b>1. DATE/TIME</b>	—	Enter date and time for LCD display and to print on transmissions.	4-1
	<b>2. STATION ID</b>	—	Program name, fax number and telephone number to appear on each transmitted page.	4-2
	<b>3. BEEPER</b>	OFF <b>LOW</b> MED HIGH	Adjust volume level of beeper.	4-4
	<b>4. TONE/PULSE</b>	<b>TONE</b> PULSE	Selects dialing mode.	4-1
<b>2. SETUP RECEIVE</b>	<b>1. RING DELAY</b>	10 09 08 07 06 05 04 03 <b>02</b> 01 00 TOLL SAVER:OFF (FAX-335MC only)	Number of rings before fax machine answers in FAX/TEL, FAX, or MC mode.	5-3
	<b>2. F/T RING TIME</b>	70 40 30 <b>20</b>	Sets the time for "double ring" in FAX/TEL mode.	5-4
	<b>3. FAX DETECT</b>	<b>ON</b> SEMI OFF	Receive fax messages without pressing the Start key.	5-5
	<b>4. REMOTE CODE</b>	<b>ON</b> (* 51, # 51, * 81) OFF	Enter code to activate or deactivate machine from a remote location or to transfer voice call from DECT cordless phone to the machine.	5-7
	<b>5. POLLING RX</b>	<b>STANDARD</b> SECURE TIMER	Sets up your fax machine to poll another fax machine.	5-8
	<b>6. MELODY SETUP</b> (FAX-335MC Only)	<b>SIGNAL</b> MELODY 1 MELODY 2 MELODY 3 MELODY 4	You can change rings to a melody.	5-3

\* The factory setting (option) is shown in bold.

Main Menu	Menu Selections	Options	Description	More Info
<b>3. SETUP SEND</b>	<b>1. COVERPG SETUP</b> (FAX-236/335MC Only)	NEXT FAX ONLY <b>ON</b> <b>OFF</b> PRINT SAMPLE	Automatically sends a cover page you program.	6-4, 6-5
	<b>2. COVERPAGE NOTE</b> (FAX-236/335MC Only)	—	Program customized message for fax cover page.	6-6
	<b>3. CONTRAST</b>	<b>AUTO</b> LIGHT DARK	Change lightness or darkness of a fax you are sending.	6-6
	<b>4. RESOLUTION</b>	<b>STANDARD</b> FINE S.FINE PHOTO	Allows you to change resolutions page by page.	6-6, 6-9
	<b>5. OVERSEAS MODE</b>	<b>ON</b> <b>OFF</b>	Adjusts for sometimes difficult overseas transmissions	6-7
	<b>6. CALL RESERVE</b> (FAX-236/335MC Only)	<b>ON</b> <b>OFF</b> PRINT SAMPLE	You can send a fax, then speak.	6-7, 6-8
	<b>7. TIMER</b>	—	Send originals later.	6-8
	<b>8. POLLED TX</b>	<b>STANDARD</b> SECURE	Sets up your fax machine with an original to be retrieved by another fax machine.	6-10
	<b>9. MEMORY TX</b> (FAX-335MC Only)	NEXT FAX ONLY <b>ON</b> <b>OFF</b>	You can send faxes from memory.	6-2
<b>4. CANCEL JOB</b>			Cancel a delayed fax or polling job.	6-10
<b>5. INTERRUPT</b>			Send a fax now, even if you have the machine set to send a fax later, or if you have it set for Polling.	6-11
<b>6. SET QUICK-DIAL</b>	<b>1. ONE-TOUCH DIAL</b>	—	Dial numbers stored in memory by pressing only one key.	7-1
	<b>2. SPEED-DIAL</b>	—	Dial numbers stored in memory by pressing only four keys.	7-2
	<b>3. SETUP GROUPS</b> (FAX-335MC Only)	—	Set up a Group number for broadcasting.	7-3

\* The factory setting (option) is shown in bold.

Main Menu	Menu Selections	Options	Description	More Info
7. PRINT REPORTS	1. TRANSMISSION	ON <b>OFF</b>		11-1, 11-2
	2. JOURNAL	EVERY 15 FAXES (FOR FAX-235/236) EVERY 30 FAXES (FOR FAX-335MC) 2/7 Days 6/12/24 Hours OFF		11-1, 11-2
	3. QUICK-DIAL	—	Print lists and reports of activity.	11-1
	4. TEL. INDEX	—	(Details in Chapter 11)	11-1
	5. SYSTEM SETUP	—		11-1
	6. MEMORY STATUS (FAX-335MC Only)	—		11-1
8. SETUP MSG CTR (FAX-335MC Only)	1. MESSAGE STORE	DOC:ON <b>DOC:OFF</b> VOICE:ON VOICE:EXT VOICE:OFF	Select if memory will store fax, voice or both.	9-2
	2. BACKUP PRINT	ON OFF	Prints copy of faxes received into memory.	9-4
	3. OGM	MSG CTR OGM FAX/TEL OGM PAGING OGM	Select/Record outgoing message.	5-4, 9-2, 9-3, 9-7
	4. ICM MAX. TIME	20-60 seconds ( <b>Factory setting is 30 seconds</b> )	Select maximum length of incoming messages.	9-5
	5. ICM REC. MONITR	ON OFF	Adjust speaker volume for voice messages as they come in.	9-6
	6. FAX FWD/ PAGING	<b>OFF</b> FAX FORWARD PAGING	Set fax machine to forward fax/ message— <b>OR</b> —to call your pager.	9-6, 9-7
	7. REMOTE ACCESS	159✳	Set code for retrieving messages.	9-8
0. MISCELLANEOUS	1. DISTINCTIVE (For Singapore and Hong Kong only)	ON <b>OFF</b>	Use with phone company Distinctive Ring service to register the ring pattern with fax machine.	8-1, 8-2
	2. KEY LOCK	—	Prohibits most functions except Receiving faxes into memory.	4-5, 4-6

\* The factory setting (option) is shown in bold.



# 4 Initial Setup

## Getting Started

---



### Setting Dialing Mode (Tone/Pulse)

Your fax machine comes set to accommodate tone (multi-frequency) dialing service. If you have pulse (rotary) dialing service, you need to change the dialing mode.

- 1 Press **Function/Set**, **1**, **4**.

DIALLING:TONE

DIALLING:PULSE

- 2 Use  or  to select TONE or PULSE and press **Function/Set**.
- 3 Press **Stop** to exit.

### Setting Date and Time

Your fax machine displays the date and time, and prints it on every fax you send.

In the event of a power failure, you may have to reset the date and time. All other settings remain unaffected.

- 1 Press **Function/Set**, **1**, **1**.

ENTER YEAR:20--

- 2 Enter the last two digits of the year and press **Function/Set**.

ENTER MONTH:--

- 3 Enter two digits for the month and press **Function/Set**. (For example, enter 09 for September, or 10 for October)

ENTER DAY:--

- 4 Enter two digits for the day and press **Function/Set**. (For example, 06)

ENTER TIME:--:--

- 5 Enter the time in 24-hour format and press **Function/Set**. (For example, enter 15:25 for 3:25 PM)

- 6 Press **Stop**. The screen now displays the date and time you set, and displays it whenever the fax machine is in Standby mode.



There are two different types of this display. One shows MONTH/DAY/YEAR, the other shows DAY/MONTH/YEAR.

## Setting Station ID

You can store your name, fax number, and telephone number to be printed on all fax pages.

- 1 Press **Function/Set, 1, 2.**
  - 2 Enter your fax number (up to 20 digits) and press **Function/Set.**
  - 3 Enter your telephone number (up to 20 digits) and press **Function/Set.** If your telephone number and fax number are the same, enter the same number again. The screen displays your entry.
  - 4 Use the dial pad to enter your name (up to 20 characters) and press **Function/Set.** (You can use the chart on next page to help you enter letters.)
  - 5 Press **Stop.** The screen returns to the date and time.
-  In Turkey, user cannot register the Station ID because of PTT regulation. Please contact Brother fax dealer to register your ID.

### Details for Entering Text

When you are setting certain functions, such as the Station ID, you may need to enter text into the fax machine. Most keys on the dial pad have three or four letters printed above them. The keys for 0, # and \* don't have printed letters because they are used for special characters or operations.

By pressing the appropriate number on the dial pad the correct number of times, you can access the character you want.

Press Key	one time	two times	three times	four times
2	A	B	C	2
3	D	E	F	3
4	G	H	I	4
5	J	K	L	5
6	M	N	O	6
7	P	Q	R	S
8	T	U	V	8
9	W	X	Y	Z

### Inserting spaces

If you want to enter a blank space, press  twice.

## Making corrections

If you entered a letter incorrectly and want to change it, press  to move the cursor after the last correct letter. Then press **Stop**; the letters above and to the right of the cursor are deleted. Re-enter the correct text and/or digits. You can also back up and type over incorrect letters.

## Repeating letters

If you need to enter a character assigned to the same key as the previous character, press  to move the cursor to the right.

## Special characters and symbols

Press \*, # or 0 repeatedly to move the cursor under the special character or symbol you want, then press  to select it.

Press \* for (space) ! “ # \$ % & ` ( ) \* + , - . /

Press # for ; < = > ? @ [ ] ^ \_

Press 0 for Ä Ë Ö Ü À Ç È É

## NOTICE

The Telephone Consumer Protection Act of 1991 makes it unlawful for any person to use a computer or electronic device to send any message via a telephone fax machine unless such messages clearly contain, in a margin at the top or bottom of each transmitted page, or on the first page of the transmission, the date and time it is sent and an identification of the business or other entity or other individual sending the message and the telephone number of the sending machines or such business, other entity or individual.

In order to program this information into your fax machine, you should complete the steps described on page 4-1.



- The telephone number you enter is used only for Call Back Message and Cover Page features. (FAX-236/335MC Only)
- If you do not enter a fax number, no additional information can be entered.
- To enter a space, press  once between numbers and twice between characters.
- If your Station ID has already been programmed, the screen prompts “1” to make a change, or “2” to exit without changing.

## Setting Beeper Volume

You can set the beeper to LOW, MED, HIGH or OFF. The default setting is **LOW**. When the beeper is set to LOW, MED or HIGH, the fax machine beeps every time you press a key or make an error, and at the end of fax sending or receiving.

- 1 Press **Function/Set, 1, 3**.
- 2 Press ◀ or ▶ to select your setting and press **Function/Set**.
- 3 Press **Stop** to exit.

## Setting the Speaker Volume

You can adjust the speaker volume when your fax machine is on hook (after you pressed **Hook** or **Speaker Phone**), by selecting a speaker volume level.

Press ◀ or ▶ to adjust the volume level. The display shows the setting you are choosing. Each key press changes the volume to the next setting. The new setting will remain until you change it again.



If you have FAX-335MC, you can adjust the speaker volume while you are listening to your OGM (Outgoing Message) and ICMs (incoming messages).



If you turn Incoming Recording Monitor to OFF (**Function/Set, 8, 5**) on the FAX-335MC, the Speaker for screening calls will be disabled and you won't hear callers leaving messages. The volume for other operations can still be controlled using ◀ and ▶.

## Setting the Ring Volume

You can adjust the ring volume when your fax machine is idle. You can select a ring volume level or press until the ring is off.

Press ◀ or ▶ to adjust the volume level. With each key press, the fax machine rings so you can hear the current setting and the display shows the setting you are choosing. Each key press changes the volume to the next setting. The new setting will remain until you change it again.

## Memory Storage

In the event of a power failure, all settings in the INITIAL SETUP, SETUP RECEIVE, SET QUICK-DIAL and SETUP MSG CTR plus the COVERPG SETUP (FAX-236/335MC only) and COVERPAGE NOTE (from SETUP SEND) (FAX-236/335MC only) functions are stored permanently. You may have to reset the date and time.

# Key Lock System

This feature allows you to prevent unauthorised access to the fax machine. When switched ON, Key Lock System prohibits most functions. The following functions listed are available while Key Lock System is switched ON.

- Receiving faxes
- Answering Calls
- Scheduled Delayed Transmission\*
- Polling\*
- Fax Forwarding\*
- Remote Retrieval

\* Provided it was set before Key Lock System was switched ON.

## Using Key Lock System

You must use a password to switch Key Lock System ON and OFF.

### Setting Up the Key Lock System for the First Time

- 1** Press **Function/Set, 0, 2**.

The screen prompts you to enter the password, and then press **Function/Set**.



NEW PASSWD:----  
ENTER & SET

- 2** Enter a 4-digit number as a new password.

- 3** Press **Function/Set**.

The screen prompts you re-enter the password.



VERIFY:----  
ENTER & SET

- 4** Re-enter the password and press **Function/Set**.

- 5** The screen displays

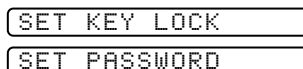

SET KEY LOCK  
SET PASSWORD

- 6** Press **◀** or **▶** to choose SET KEY LOCK.

- 7** Press **Function/Set**. The screen prompts you to enter the password.



PASSWORD:----  
ENTER & SET

- 8** Enter a 4-digit password, followed by **Function/Set**.









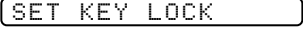

This is the same as the password of your machine already stored.

The screen displays ACCEPTED for 2 seconds, followed by KEY LOCK MODE - Key Lock System is now switched ON.







If the password you enter at Step 8 is incorrect, the screen would display **WRONG PASSWORD**. After 2 seconds the display will then return to select menu for Function 0. You must then try again to switch Key Lock System ON.

## Changing the Key Lock System Password

- 1 Press **Function/Set, 0, 2**. 
- 2 Press  or  to choose SET PASSWORD. 
- 3 Press **Function/Set**.  
The screen prompts you to enter the old password.   

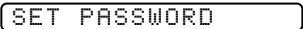
- 4 Enter the current password.
- 5 Press **Function/Set**.  
The screen prompts you to enter the new password.   

- 6 Enter a 4-digit number as a new password.
- 7 Press **Function/Set**.  
The screen prompts you to re-enter the new password.   

- 8 Enter the new password again and press **Function/Set**.
- 9 Press **Stop** to exit.

## Switching Key Lock System ON

- 1 Press **Function/Set, 0, 2**. The screen displays 
- 2 Press  or  to choose SET KEY LOCK. 
- 3 Press **Function/Set**. The screen prompts you to enter the password.   

- 4 Enter a 4-digit password, followed by **Function/Set**.  
This is the same as the password of your machine already stored.  
The screen displays **ACCEPTED** for 2 seconds, followed by **KEY LOCK MODE - Key Lock System is now switched ON**.



If the password you enter at Step 4 is incorrect, the screen would display **WRONG PASSWORD**. After 2 seconds the display will then return to select menu for Function 0. You must then start from Step 1 to set Key Lock System.

## Switching OFF Key Lock System

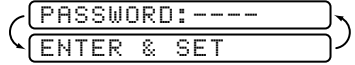

- 1 When Key Lock System is switched ON, press **Function/Set**.

The screen prompts you to enter the password, followed by **Function/Set**.



- 2 Enter a 4-digit password and press **Function/Set**.

The screen displays ACCEPTED, then after 2 seconds the display reverts to normal. Key Lock System is now switched OFF.

-  If the password you enter at Step 2 is incorrect, the screen would display WRONG PASSWORD. After 2 seconds the display will then return to displaying KEY LOCK MODE. You must then start from Step 1 to switch OFF Key Lock System.
-  If you forget the Key Lock System password, please contact your Brother dealer for service.

# 5 Setup Receive

## Basic Receiving Operations

---

### Select Answer Mode

**MANUAL**—You must answer all calls yourself. If you hear fax tones, press **Start** to begin receiving the fax, then hang up. You can use this mode with Distinctive Ringing. (See *Distinctive Ring (For Singapore and Hong Kong)*, page 8-1.)

**FAX ONLY**—The fax machine automatically answers every call as a fax call. You cannot receive a voice call, but you can dial out and make a voice call.

**FAX/TEL**—The fax machine automatically answers every call. If the call is a fax, it prints the fax. If the call is not a fax, it signals you with a F/T pseudo-ring, different from the phone company ringing, to alert you to pick up the call. If you select this setting, you'll need to set the Ring Delay and F/T Ring Time features (on the following pages). (See *For FAX/TEL Mode Only*, page 5-6.)

**TAD:ANSWER MACH.** (For FAX-235/236 only)—This is the only setting in which you can use an external answering machine. Your telephone answering device is connected to your FAX, and answers every call. Once the TAD answers, the FAX listens for fax tones. If it detects fax tones, it prints the fax.

The TAD setting works only with an external telephone answering device (TAD); it does not work with telephone company voice mail. Ring Delay and F/T Ring Time do not work in this setting.



**TAD can not be connected in some countries.**

**NIGHT** (For FAX-235 and FAX-236)—This is the Night Mode setting. The fax machine receives incoming fax calls without ringing. In case of a voice call, the fax machine does not ring and it doesn't receive the voice call. The caller hears fax tones after few rings.

**NIGHT** (For FAX-335MC only)—If you set the receiving mode to Night, MC ON/OFF button is automatically turned on. The fax machine receives incoming fax calls without ringing. In the event of voice call, the incoming voice call is stored in the message manager memory. As the ICM recording monitor (for call screening) is automatically set to OFF, the user is not disturbed by the voice of the caller. In case of memory full, the machine change to F/T mode if the machine still has paper. It changes to Manual mode if it both memory full and out of paper.



If you have not recorded the Outgoing Message for Message Center mode (See chapter 9), your fax machine does not receive the voice call.



Night mode overrides the receiving mode set by the user. In the morning, the user must press **Mode** to manually revert to the Answer mode they have set (such as F/T or FAX ONLY).



**MSG CTR** (For FAX-335MC only)—The fax machine provides you with a built-in digital Message Center for fax and voice. When you set the machine to answer calls, it will record up to 15 minutes of messages. For more information about Message Center (MSG CTR) operation, please see Chapter 9.

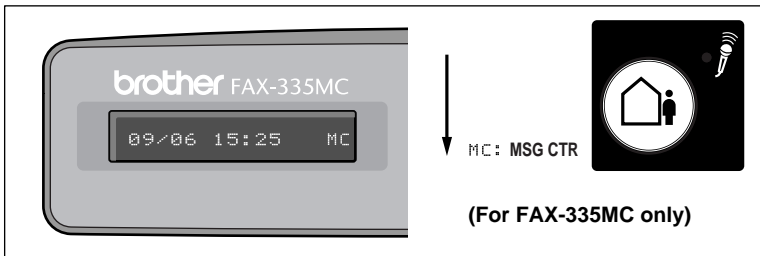
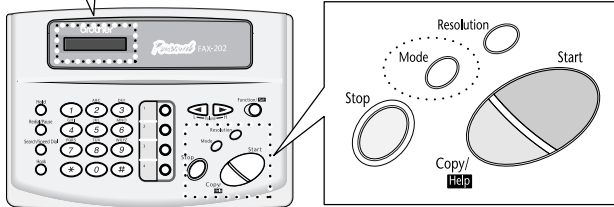
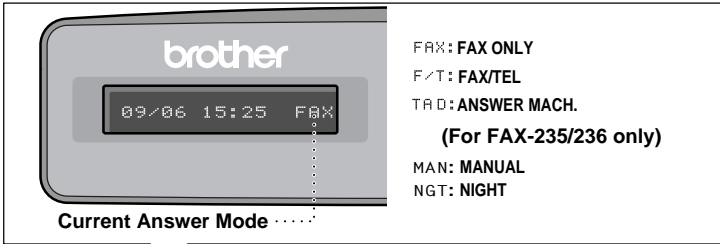

## To select or change your Answer Mode

- 1 Press **Mode**. The screen displays your current selection.  
 The options on the FAX-235/236 are:

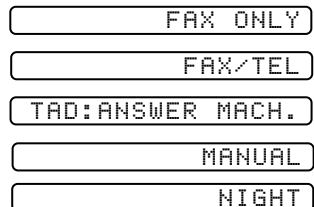

The options on the FAX-335MC are:

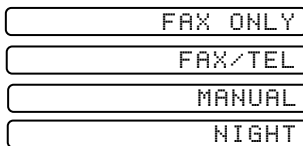

Or, if Message Center Mode is ON, it overrides your Answer Mode Setting, so the display shows:

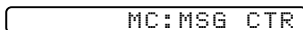

- 2 Continue to press **Mode** until your new selection appears. After 2 seconds, the screen returns to the date and time display, along with your new Answer Mode setting.



If you're changing Answer Mode while in another operation, the screen returns to the current operation display.

## Setting Ring Delay

The Ring Delay setting determines the number of times the fax machine rings before it answers. (See *Fax Detect*, page 5-5 and *Operation from External or Extension Telephone*, page 5-6 and *For FAX/TEL Mode Only*, page 5-6.)

- 1 Press **Function/Set, 2, 1**. If you have a FAX-235 or FAX-236, go to Step 3.
- 2 Press or to select RING DELAY and press **Function/Set**.
- 3 Press or to select how many times the line rings before the fax machine answers (00 – 04 or 00 – 10) and press **Function/Set**. If you select 00, the line doesn't ring at all.
- 4 Press **Stop** to exit.

## Setting Melody for Rings (FAX-335MC only)

You can select a favorite music out of 4 choices for rings. If you select a melody for rings, the melody will be played when the machine received a telephone call or fax message.

The default setting is SIGNAL.

- 1 Press **Function/Set, 2, 6**.
- 2 Press or to select SIGNAL, MELODY 1, MELODY 2, MELODY 3, MELODY 4 or SINGLE and press **Function/Set**.
- 3 Press **Stop** to exit.

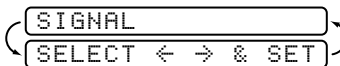

Even if you select a melody for rings, F/T pseudo-ring can not be changed to the melody.

## Setting F/T Ring Time

You need to determine how long the fax machine will notify you with its special F/T pseudo-ring when you have a voice call. It will ring happens after the initial ringing from the phone company. Only the fax machine rings for 20, 30, 40 or 70 seconds; no other phones on the same line ring the special F/T pseudo-ring. However, you can answer the call on any phone (in a separate wall jack) on the same line as the fax machine.

- 1 Press **Function/Set, 2, 2**.
- 2 Press ◀ or ▶ to select how long the fax machine will ring to alert you that you have a voice call and press **Function/Set**.
- 3 Press **Stop** to exit.

RING TIME: 20 SEC

Now, when a call comes in and the machine is set to FAX/TEL Mode, all phones on this line will ring the number of times you selected in Ring Delay.

You can let the fax machine pick up and detect if it's a fax or voice call. If it's a fax call, the machine prints the fax. If it's a voice call, the machine signals you with a F/T pseudo-ring for the length of time you selected in F/T Ring Time.



Even if the caller hangs up during the F/T pseudo-ring, the fax machine continues for the set time.

## Record FAX/TEL Outgoing Announcement (F/T OGM) (For FAX-335MC only)



This is the announcement played by your fax machine (not an external TAD) when someone calls and your machine is set to FAX/TEL mode. Although callers hear your announcement, they cannot leave a message. To erase the announcement, follow the directions on *Activating Message Center Mode*, page 9-3.

- 1 Press **Function/Set, 8, 3**. The screen prompts you to choose FAX/TEL OGM, MSG CTR OGM or PAGING MSG.
- 2 Press ◀ or ▶ to select FAX/TEL OGM (not MSG CTR OGM) and press **Function/Set**.
- 3 Press ◀ or ▶ to select RECORD MSG and press **Function/Set**.  
Then pick up the handset to record a message.
- 4 Replace the handset. Your OGM is played.
- 5 Press **Stop** to exit.

## Fax Detect

When you use this feature, you don't have to press **Start** when you answer a fax call and hear calling beeps. Just hold the handset and wait a few seconds. When you see **RECEIVE** on the fax screen or when you hear "chirps" through the handset of an extension phone connected to another wall jack, just replace the handset, and your machine does the rest. Selecting **ON** allows the fax machine to receive fax calls automatically, even if you lift the handset of an extension or external phone. Selecting **SEMI** lets the machine receive the call only if you've answered it at the fax machine. Selecting **OFF** means you'll have to activate the fax machine yourself, by pressing **Start** or by pressing **\* 5 1** if you are not at your machine. (See *Operation from External or Extension Telephone*, and *For FAX/TEL Mode Only*, page 5-6.)

If you've set the feature to **ON**, but your fax machine doesn't automatically connect a fax call when you lift an external or extension phone handset, press the Fax Receive code **\* 5 1**. At the fax machine, lift the handset and press **Start**.

- 1** Press **Function/Set, 2, 3**.
- 2** Press  or  to select **ON, SEMI** or **OFF** and press **Function/Set**.
- 3** Press **Stop** to exit.



**External Telephone can not be connected in some countries.**

# Advanced Receiving Operations

## Operation from External or Extension Telephone

If you answer a fax call on an extension phone or on an external phone in the EXT. jack, you can make your fax machine take over by using the Fax Receive Code. When you press the Fax Receive Code ✕ **5 1**, the fax machine starts to receive a fax. (See *Fax Detect*, page 5-5.)

If the fax machine answers a voice call and F/T pseudo-ring for you to take over, use the Telephone Answer Code **# 5 1** to take the call at an extension phone. (See *Setting F/T Ring Time*, page 5-4.)

If you answer a call, and no one is on the line, assume you're receiving a fax. At the fax machine phone, press **Start**, then hang up. At an extension phone, press ✕ **5 1**, wait for fax receiving tones (chirps), then hang up. At an external phone, press ✕ **5 1** and wait for the phone to be disconnected (the screen displays RECEIVE) before you hang up. (Your caller will have to press **Start** to send the fax.)



**External phone can not be connected in some countries.**

### For FAX/TEL Mode Only

When the fax machine is in FAX/TEL mode, it will use the F/T Ring Time (F/T pseudo-ring) to alert you to a voice call. If you're at the fax machine, you can lift the handset to answer.

If you're at an extension phone, you'll need to lift the handset during the F/T Ring Time and press **# 5 1** between the F/T pseudo-ring. If no one is on the line, or if someone wants to send you a fax, send the call back to the fax machine by pressing ✕ **5 1**.

### Remote Call Transfer (Semi-DECT Management)

This function works when you receive the incoming Voice call at the remote DECT cordless phone externally connected to the fax machine. You can transfer voice call to the fax machine. But you can not transfer the incoming voice call from the fax machine to the DECT cordless phone.

### To transfer telephone call to the fax machine

When you pick up the voice call at remote DECT cordless phone and would like to transfer it to the fax machine,

- 1 Press Activation Voice Code ✕ **8 1** at remote cordless phone.
- 2 The fax machine rings (pseudo-ring same as current F/T ring) and the display shows "PICK UP PHONE".
- 3 Pick up the handset and press **Hook** or **Speaker Phone** —OR— just press **Speaker Phone** at the fax machine in order to transfer the voice call to the fax machine.



Don't hang up the call from the cordless phone until the voice call has been transferred to the fax machine. You will know when this is because you will no longer be able to hear or talk to the caller via the cordless phone. If you do not wait until this point before hanging up from the cordless phone, the call will be lost.

If nobody answers at the fax machine, pseudo-ringing stops after 30 seconds. In that case, it may still be possible to speak with the caller from the cordless phone. Speech between the fax machine and the cordless phone (= intercom) is not possible.

## Changing Remote Codes

Remote Codes might not work with some telephone systems. The preset Fax Receive Code is \* 5 1. The preset Telephone Answer Code is # 5 1.



If you are always disconnected when accessing your external TAD remotely, try changing the Fax Receive Code from \* 5 1 to ### and the Telephone Answer Code from # 5 1 to 9 9 9.

**1** Press **Function/Set**, **2**, **4**.

**2** Press ◀ or ▶ to select ON (or OFF) and press **Function/Set**.

REMOTE ACT.:ON

**3** If you want to, enter a new Fax Receive Code, then press **Function/Set**.

ACT.CODE:\*51

**4** If you want to, enter a new Telephone Answer Code, then press **Function/Set**.

DEACT.CODE:#51

**5** If you want to, enter a new Activation Voice Code, then press **Function/Set**.

ACT.VOICE:\*81

**6** Press **Stop** to exit.

## Polling



Polling is the process of retrieving faxes from another fax machine. You can use your fax machine to "poll" other machines, or you can have someone poll your machine.

All parties involved in polling need to set up their fax machines to accommodate polling. When someone polls your machine to receive a fax, they pay for the call; if you poll someone's fax machine to receive a fax, you pay for the call.



(See *Canceling a Scheduled Job*, page 6-10.)



Some fax machines do not respond to the polling function.

## Setting Up Polling Receive

Polling Receive is when you call another fax machine to receive a fax from it.

- 1 Press **Function/Set, 2, 5**.  
The screen displays:
- 2 Press  or  to choose STANDARD.
- 3 Press **Function/Set**. The screen prompts you to enter the fax number you want to poll, and then to press **Start**.
- 4 Enter the fax number you are polling.
- 5 Press **Start**. The screen displays DIALING.



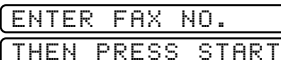

POLLING:STANDARD  
SELECT < > & SET



ENTER FAX NO.  
THEN PRESS START

## Setting Up Delayed Polling Receive

You can set your fax machine to begin Polling Receive at a later time. (See *Canceling a Scheduled Job*, page 6-10.)

- 1 Press **Function/Set, 2, 5**. The screen displays:
- 2 Press  or  to choose TIMER.
- 3 Press **Function/Set**.  
The screen prompts you to enter the time you want to begin polling.
- 4 Enter the time (in 24-hour format) you want to begin polling. For example, enter 21:45 for 9:45 PM.
- 5 Press **Function/Set**. The screen prompts you to enter the fax number to be polled.
- 6 Enter the fax number (you can use One Touch or Speed Dial, or dial manually).
- 7 Press **Start**. The fax machine makes the polling call at the time you entered.



POLLING:TIMER

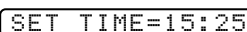

SET TIME=15:25





ENTER FAX NO.  
THEN PRESS START



This function is not available in some countries.



## Setup for Polling Receive with Secure Code

You need to make sure you are using the same ID number as the other party.

- 1 Press **Function/Set, 2, 5**.
- 2 Press  or  to choose SECURE and press **Function/Set**. 
- 3 Enter a four-digit number.  
This is the same as the security code of the fax machine you are polling.
- 4 Press **Function/Set**.
- 5 The screen prompts you to enter the fax number you want to poll, and then to press **Start**.
- 6 Enter the fax number, and press **Start**.

## Setting Up Sequential Polling Receive (For FAX-335MC Only)

Your fax machine can request documents from several fax units in a single operation. Afterward, a Sequential Polling Report will be printed.

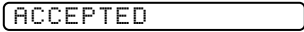
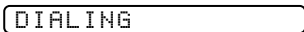
- 1 Press **Function/Set, 2, 5**.  
The screen displays: 
- 2 Press  or  to select Polling STANDARD, SECURE or TIMER, and press **Function/Set** when the screen displays the setting you want.
- 3 If you selected STANDARD, the screen prompts you to enter the fax number you want to poll, and then to press **Start**.
  - If you selected SECURE, enter a four-digit number and press **Function/Set**.
  - If you selected TIMER, enter the time (in 24-hour format) you want to begin polling and press **Function/Set**.
- 4 Specify the destination fax machines, which you wish to poll by using One Touch, Speed Dial or a Group. For example, for One Touch **3** and Speed Dial location 09, press One Touch Dial key **3**, **Search/Speed Dial, #** and 09.
- 5 Press **Start**.  
Your fax machine will poll each number or group member in turn for an original.   



# 6 Setup Send

## ***Automatic Document Feeder (ADF)***

---

- Originals must be between 5.8 and 8.5 inches (148 and 216 mm) wide, and 5.9 and 23.7 (150 and 600 mm) inches long. Your fax machine can only scan an image 8.2 inches (208 mm) wide, regardless the paper width.
- Make sure you place the original **face down, top edge first**.
- Adjust the paper guides to fit the width of your original.

Paper guides

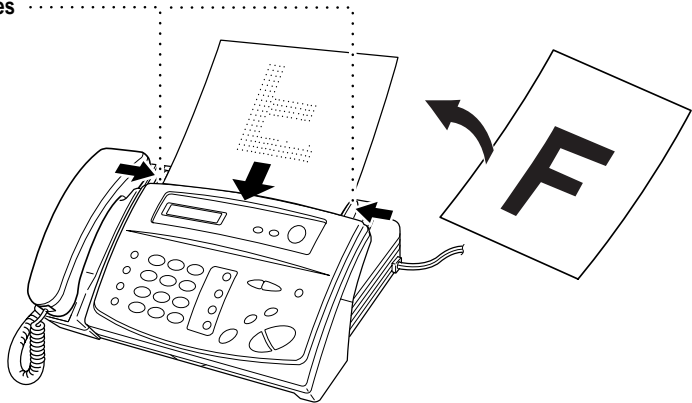

## ***ADF (Automatic Document Feeder)***

---

The automatic document feeder (ADF) can hold up to 10 pages, feeding each one individually through the fax machine. Use standard (17 lb–24 lb) paper when using the ADF; if you're using heavier paper, feed each sheet individually to prevent paper jams.

- ⊘ **DO NOT** use curled, wrinkled, folded or ripped paper, or paper with staples, paper clips, paste or tape attached. **DO NOT** use cardboard, newspaper or fabric.
- Make sure originals written with ink are completely dry.

## Manual Transmission

Manual transmission lets you hear the dial tone, ringing and fax receiving tones before sending the fax.

- 1 Place the original face down in the ADF.
- 2 Pick up the handset and listen for a dial tone  
—OR—press **Hook** or **Speaker Phone** and listen for a dial tone.
- 3 Enter the fax number you want to call. (You can enter the digits using the dial pad, or you can enter a One Touch or Speed Dial number or you can call using **Search/Speed Dial**.) (See *One Touch Dialing*, page 7-5 and *Search*, page 7-6.)
- 4 When you hear the fax tone, press **Start**.
- 5 If you're using the handset, hang up.

## Automatic Transmission

This is the easiest way to send a fax.

**IMPORTANT:** Do **not** pick up the handset, nor press **Hook** or **Speaker Phone**.

- 1 Place the original face down in the ADF.
- 2 Enter the fax number using One Touch, Speed Dial, Search or the dial pad. (See *One Touch Dialing*, *Speed Dialing* and *Search*, page 7-5 to 7-5.)
- 3 Press **Start**.

## Manual and Automatic Fax Redial

*If you're sending a fax manually* and the line is busy, press **Redial/Pause** to retry the number.

*If you're sending a fax automatically* and the line is busy, the fax machine will redial automatically up to three times at five minute intervals.

## Memory Transmission (For FAX-335MC Only)

This feature allows your machine to scan a fax into its memory and send it as soon as the scan is complete. This way, you don't have to wait for the entire fax to be transmitted before you retrieve your original.

- 1 Place the original face down in the ADF.
- 2 Press **Function/Set**, **3**, **9**.
- 3 To change the default setting, press ◀ or ▶ to select ON (or OFF) and press **Function/Set**. Go to Step 5—OR—For the next fax transmission only, press ◀ or ▶ to select NEXT FAX ONLY and press **Function/Set**.
- 4 For the next fax only, press ◀ or ▶ to select ON (or OFF) and press **Function/Set**.

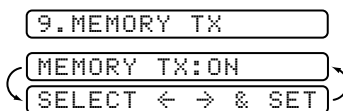

**5** Press **1** to select additional settings. The display returns to the SETUP SEND menu—**OR**—Press **2** if you are finished choosing settings and go to Step 6.

**6** Enter fax number and press **Start**.



If you get a OUT OF MEMORY message while scanning the first page of a fax, press **Stop** to cancel the scan. If you get a OUT OF MEMORY message while scanning in a subsequent page, you'll have the option to press **Start** to transmit the pages scanned so far, or to press **Stop** to cancel the operation. In this case, send the fax by the Manual Transmission.



Depending on your typical faxes, OUT OF MEMORY errors can occur frequently. If this happens, change the Memory Transmission setting back to OFF.

## ***Basic Sending Operations***

---

### **Composing Electronic Cover Page (For FAX-236/335MC Only)**

The cover page is generated at the receiving party's machine. Your cover page includes the name stored in the One Touch or Speed Dial memory. If you're dialing manually, the name is left blank. (See *One Touch Dialing*, page 7-5, *Speed Dialing*, page 7-5.)

The cover page indicates the fax is from your Station ID, and the number of pages you're sending. If you have Coverpage Setup set to ON (**Function/Set 3 1**), the number of pages remains blank. (See *Setting Station ID*, page 4-2.)

Most of the SETUP SEND functions are temporary settings that allow you to make adjustments for each original you send. However, so that you can set up your cover page and cover page comments in advance, the Cover Page Setup and Cover Page Message functions will change their default settings.

You can select a comment to include on your cover page.

1. COMMENT OFF

2. PLEASE CALL

3. URGENT

4. CONFIDENTIAL

Instead of using one of the comments above, you can enter up to two customized messages, each 27 characters long. Use the chart on page 4-2 to help enter characters.

## Cover Page for Next Fax Only (For FAX-236/335MC Only)

Make sure the Station ID is set up (See *Setting Station ID*, page 4-2.). This feature does not work without the Station ID.

You can set the fax to send a cover page with a particular original. This cover page will include the number of pages in your original.

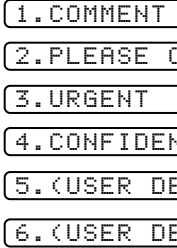
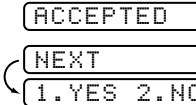
- 1 Place the original in the ADF.
- 2 Press **Function/Set, 3, 1**.
- 3 When the screen displays NEXT FAX ONLY, press **Function/Set**.
- 4 Press ◀ or ▶ to select ON.
- 5 Press **Function/Set**.
- 6 Press ◀ or ▶ to view the comment selections.
- 7 Press **Function/Set** when the screen displays your selection.
- 8 Enter two digits to indicate the number of pages your are sending. (Enter **00** to leave the number of pages blank.) If you make a mistake, press ◀ to back up and reenter the number of pages.
- 9 Press **Function/Set**. The screen displays:
- 10 Press **1** if you want to select additional settings. The display returns to the SETUP SEND menu—**OR**—Press **2** if you are finished choosing settings, and go to Step 11.
- 11 Enter the fax number you're calling.
- 12 Press **Start**.

## Always Send Cover Page (For FAX-236/335MC Only)

Make sure Station ID is set up (See *Setting Station ID*, page 4-2.). This feature does not work without the Station ID.

You can set the fax machine to send a cover page whenever you send a fax. The number of pages in your fax is not included when you use this setting.

- 1 Press **Function/Set, 3, 1**.
- 2 Press ◀ or ▶ to select.
- 3 Press **Function/Set** when the screen displays COVERPAGE:ON. (If you select ON, a coverpage is always sent when you send a fax.)

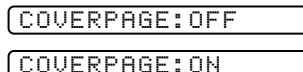

- 4** If you selected ON, you must select a comment. Press ◀ or ▶ to view possible selections. (You can select your custom comment.)

1.COMMENT OFF

2.PLEASE CALL

3.URGENT

4.CONFIDENTIAL

5.<USER DEFINED>

6.<USER DEFINED>

- 5** Press **Function/Set** when the screen displays your selection. The screen displays:

ACCEPTED

- 6** Press **1** if you want to select additional settings. The display returns to the SETUP SEND menu—**OR**—Press **2** to exit if you are finished choosing settings.

NEXT

1.YES 2.NO

## Using a Printed Cover Page (For FAX-236/335MC Only)

If you prefer using a printed cover page that you can write on, you can print the sample page and attach it to your fax.



- 1** Press **Function/Set, 3, 1**.
- 2** Press ◀ or ▶ to select PRINT SAMPLE.
- 3** Press **Function/Set** when the screen displays your selection.
- 4** Press **Start**. Your fax machine prints a copy of your cover page.

=== COVER PAGE ===	
TO:	_____
FROM:	_____
FAX:	
TEL:	
	PAGE[S] TO FOLLOW
COMMENT:	

## Cover Page Message (For FAX-236/335MC Only)

You can set up two custom comments.

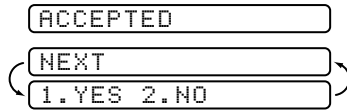

## Composing Your Own Comments (For FAX-236/335MC Only)

- 1 Press **Function/Set**, **3**, **2**. The screen displays: COVERPAGE NOTE.
- 2 Press  or  to choose position 5 or 6 for your customized comment.
- 3 Press **Function/Set**.
- 4 Use the dial pad to enter your customized comment (up to 27 characters).
- 5 Press **Function/Set**. The screen displays:
- 6 Press **1** if you want to select additional settings. The display returns to the SETUP SEND menu—**OR**—Press **2** to exit.



## Contrast

If your original is very light or very dark, you might want to set the contrast accordingly. Use LIGHT to send a very light original. Use DARK to send a very dark original.

- 1 Place the original face down in the ADF.
- 2 Press **Function/Set**, **3**, **3**.
- 3 Press  or  to select AUTO, LIGHT or DARK and press **Function/Set**.
- 4 Press **2** if you have finished choosing settings, and go to Step 5—**OR**—Press **1** if you want to select additional settings. The display returns to the SETUP SEND menu.
- 5 Enter a fax number and press **Start** to send a fax—**OR**—Press **Copy/Help** to make a copy.

## Resolution



You must press **Resolution** (before you send the fax) to select the resolution for the type of original you're sending.

**STANDARD**—suitable for most typed originals.

**FINE**—good for small print; transmits a little slower than standard resolution.

**S. FINE**—good for small print or artwork; transmits slower than fine resolution.

**PHOTO**—use when original has varying shades of gray; slowest transmission time.





If the receiving fax machine does not have the resolution you select, the transmission will fall back to the next available resolution on receiving machine.

# Advanced Sending Operations

## Overseas Mode

If you have difficulty sending a fax overseas, use the Overseas mode.









After you send a fax using this feature, the feature turns itself off.

- 1 Place the original face down in the ADF.
- 2 Press **Function/Set, 3, 5.** 
- 3 Press  or  to select ON (or OFF) and press **Function/Set.**
- 4 Press **1** if you want to select additional settings. The display returns to the SETUP SEND menu—**OR**—Press **2** if you have finished choosing settings and go to Step 5.
- 5 Enter the fax number you're calling.
- 6 Press **Start.**

## Call Reservation (For FAX-236/335MC Only)

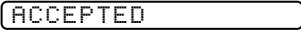
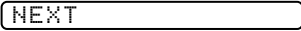
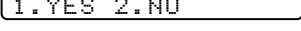

You can send a fax and let the other party know that you want to have a conversation after the fax transmission is complete. The other fax machine will ring as if it were receiving a telephone call; if the other party picks up the handset, your fax machine will ring. Lift the handset to speak.

If you set Call Reservation and Call Back message to ON, your fax machine leaves a message if the other party does not answer.

- 1 Place the original in the ADF.
- 2 Press **Function/Set, 3, 6.** The screen displays the current setting for Call Reservation.   

- 3 Press  or  to select ON (or OFF).
- 4 If you set Call Reservation to ON, press **Function/Set** when the screen displays your selection. The screen displays the current setting for Call Back Message.   

- 5 Press  or  to select ON (or OFF).
- 6 Press **Function/Set** when the screen displays your selection. The screen displays   
  

- 7 Press **1** if you want to select additional settings. The display returns to the SETUP SEND menu—**OR**—Press **2** if you are finished choosing settings, and go to Step 8. The screen prompts you to enter the fax number you want to call.

- 8 Enter the fax number.
- 9 Press **Start**.
- 10 If you've set Call Reservation to ON, pick up your handset if the fax machine rings.
-  You cannot use auto redial with Call Reservation. You cannot use Call Reservation with Delayed Transmission or with Polling. You must register your Station ID to set Call Back Message to ON.

## Print Sample Call Back Message (For FAX-236/335MC Only)

- 1 Press **Function/Set**, **3**, **6**.
- 2 Press  or  to select PRINT SAMPLE.
- 3 Press **Function/Set**.
- 4 Press **Start**.

## TIMER

You can use this function to send a fax up to 24 hours later.

- 1 Place the original face down in the ADF.
- 2 Press **Function/Set**, **3**, **7**.
- 3 Enter the time, in 24-hour format, that you want the fax to be sent and press **Function/Set**. (For example, enter 19:45 for 7:45 PM)  
If you have a FAX-235 or FAX-236, go to Step 5.

- 4 Press **1** to leave the originals waiting in the ADF—**OR**—Press **2** to scan the original into memory.

1.DOC 2.MEMORY

(See *Interrupting Timer and Polled Transmit Jobs*, page 6-11.)

- 5 Press **1** to select additional settings. The display returns to the SETUP SEND menu—**OR**—Press **2** if you have finished choosing settings and go to Step 6.

NEXT  
1.YES 2.NO

- 6 Enter the fax number.
- 7 Press **Start**. The machine will wait to send the fax at the time you set up.

ENTER FAX NO.  
THEN PRESS START



## Next-Fax Reservation (For FAX-236/335MC Only)

Even if your fax machine is receiving another fax, you can set your machine to send your fax next. This way, you don't have to wait for it to finish sending or receiving the other fax. You can dial this fax call manually, or by using Redial, One Touch, Speed Dial, or Chain dialing. (When you use One Touch and Speed Dial, only the memory location—not the name of the person you're calling—is displayed.)

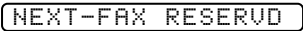
- 1 Place the originals in the ADF. If necessary, press **Resolution** to adjust resolution.
- 2 Enter the fax number.
- 3 Press **Start**.
- 4 Press **Function/Set**. The screen displays: 
- 5 To cancel the reservation, remove the originals and press **Stop**.





You can't use this feature if there is an original waiting in the ADF (possibly for Delayed Fax or Polled Transmit).



If you use Next-Fax Reservation, the machine will send an original without storing it in memory.

## Multiple Resolution Transmission

Use this feature to select separate resolution settings for each page of the fax you're sending. This could be useful if you're sending a fax with photos and letters, or some pages with small print and others with normal print. Resolution settings return to STANDARD after the fax is sent. (See *Resolution*, page 6-6.)

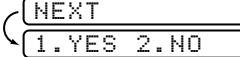
- 1 Insert the originals in the feeder, then press **Function/Set**, **3**, **4**.
- 2 Use  or  to select resolution for page 1, then press **Function/Set**.
- 3 Repeat Step 2 for subsequent pages.
- 4 Press **Stop** when you're finished. The screen displays 
- 5 Press **1** if you want to select additional settings. The display returns to the Setup Send menu—**OR**—Press **2** if you are finished choosing settings, and go to Step 6. The screen prompts you to enter the fax number you want to call. 
- 6 Enter the fax number you're calling.
- 7 Press **Start**.





To copy an original using multiple resolutions, press **Copy/Help** in Step 6.

## Setting Up for Polled Transmit

Polled Transmit is when you set up your fax machine to wait with a document so another fax machine can retrieve it.

**1** Place the document to be retrieved face down in the ADF.

**2** Press **Function/Set, 3, 8.**

**3** Press  or  to choose STANDARD and press **Function/Set.**

If you have a FAX-235 or FAX-236, go to Step 5.



POLLING: STANDARD  
SELECT < > & SET

**4** Press **1** to select DOC if you want your machine to scan the printed document at the time it is polled—**OR**—Press **2** to select MEMORY.



1. DOC 2. MEMORY

**5** Press **1** if you want to select additional settings. The display returns to the SETUP SEND menu—**OR**—Press **2** if you are finished choosing settings and go to step 6.

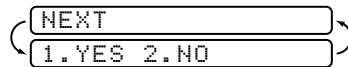

NEXT  
1. YES 2. NO

**6** Press **Start.**



If you pressed **1** in Step 4, the printed document remains in the ADF until your machine is polled. However, you can “interrupt” it to send another fax.



## Canceling a Scheduled Job

You can cancel tasks you’ve scheduled, such as Delayed Fax or Polling Transmit.

**1** Press **Function/Set, 4.** Any waiting jobs appear on the display. If there are no jobs waiting, the screen displays NO JOB WAITING.



4. CANCEL JOB

**2** If you have more than two jobs waiting, press  or  to select the job you want to cancel and press **Function/Set.**

—**OR**—

If you have only one job waiting, go to Step 3.

**3** Press **1** to cancel—**OR**—Press **2** to exit without canceling.

**4** Press **Stop** to exit.

## Interrupting Timer and Polled Transmit Jobs

You can send a fax or make a copy now, even if you have the fax machine set to send a fax later, or if you have it set to be polled. However, you cannot use automatic redial or the function mode.

- 1** Press **Function/Set, 5**.
- 2** Wait 2 seconds, then remove the document that is waiting in the ADF. INSERT DOCUMENT
- 3** Place the document you want to send now in the ADF.
- 4** Enter the number for the fax you want to send now.
- 5** Press **Start**.
- 6** After the transmission is finished, return the first document to the ADF.
- 7** Press **Function/Set, 5** to restore the Timer and/or Polling.



If you have set up a Timer or Polled Transmit job in memory, you don't have to interrupt it to send a fax or make a copy. (For FAX-335MC Only)



If you have set up a Timer or Polled Transmit job, the machine will send a document without storing it in memory. (For FAX-335MC Only)

## Storing Numbers for Easy Dialing

You can set up your fax machine to do three types of easy dialing:

One Touch, Speed Dial, and Groups for Broadcasting of faxes (For Fax-335MC only).

If you use the Caller ID subscriber service offered by your local phone company (For Singapore and Hong Kong only), you can register the number for Anti-Junk Fax/Call in One Touch and Speed Dial locations.



*If you lose electrical power, auto dial numbers in memory will not be lost.*

### Storing One Touch Dial Numbers/Storing Junk Fax/Call Numbers

You can store four fax/phone numbers that you can dial by pressing one key (and **Start**). You also can store names with these numbers. When you press a One Touch dial location, the screen displays the name or number as the call is dialed. (See *One Touch Dialing*, page 7-5.)

*One Touch keys are not the dial pad keys. They are the four keys (numbers 1–4) located in the middle of the control panel.*



If you want to store a Junk number, you have to set ANTI JUNK to ON in Step 6.

- 1 Press **Function/Set**, **6**, **1**.
- 2 Press the One Touch key where you want to store a number. The screen displays the location you selected.

The screen displays the location you selected.



- 3 Enter a number (up to 20 digits) and press **Function/Set**.



If you want to enter a pause in the dialing sequence (to wait for an “outside line,” for example), press **Redial/Pause** as you’re entering digits. Pressing **Redial/Pause** enters a 3.5-second pause when the number is dialed, and a dash appears on the screen.

- 4 Use the dial pad to enter the name or company (up to 15 characters) and press **Function/Set**. You can use the chart on page 4-2 to help you enter letters —**OR**—To store the number without a name, press **Function/Set**. (See *Details for Entering Text*, page 4-2.)

NAME:



**5** Press  or  to select the type of number and press **Function/Set**.

**FAX** a fax only number

**TEL** a telephone (voice) number

**F/T** both a fax and telephone (voice) number

**CHAIN** a number (usually an access code) for chain dialing.

**6** Press  or  to select if you set ANTI JUNK to ON (OFF) and press **Function/Set**.



If you set ANTI JUNK to ON, the number is registered as the Junk Fax or Call in the machine. The machine will reject receiving the fax message or telephone call.



If you don't use the Caller ID subscriber service offered by your local telephone company, you don't use the Anti-Junk function.

**7** Press to Step 2 to store another One Touch number—**OR**—Press **Stop** to exit.

When you dial an QUICK-DIAL number, the screen displays the name you've stored, or, if you haven't stored a name, the number you've stored.



If you must wait for another dial tone at any point in the dialing sequence, store a pause at that place in the number by pressing **Redial/Pause**. Each key press adds a 3.5 second pause.

You can use chain dialing to store long dialing sequences. For example, to store **9 1 201 555 1234 987 65 4321**, divide the number into two parts. Store the first part as a Chain type number (this tells the system that the dialing sequence is not complete).

**CHAIN—9 1 201 555 1234**

The last part of the One Touch number must be stored as any of the other following three types.

**FAX or F/T or TEL—987 65 4321**

Now, when you dial, just press the two keys (one after the other, in order) where you've stored the two parts of the number.

## Storing Speed Dial Numbers/Storing Junk Fax/Call Numbers

You can store Speed Dial numbers, when you dial by pressing only four keys. There are 60 (FAX-235), 100 (FAX-236/FAX-335MC) Speed Dial locations.



If you want to store a Junk number, you have to set ANTI JUNK to ON in Step 6.

**1** Press **Function/Set, 6, 2**.

SPEED-DIAL? #

**2** Use the dial pad to enter a two-digit location and press **Function/Set**. (01-60) FAX-235, (00-99) FAX-236 and FAX-335MC.

#05:

ENTER & SET

- 3** Enter the number (up to 20 digits) and press **Function/Set**. NAME :
- 4** Use the dial pad to enter the name or company (up to 15 characters) and press **Function/Set**—**OR**—Press **Function/Set** to store the number without a name. (See *Details for Entering Text*, page 4-2.)
- 5** Press ◀ or ▶ to select the type of number and press **Function/Set**.
- |              |  |
|--------------|--|
| <b>FAX</b>   | a fax only number                                    |
| <b>TEL</b>   | a telephone (voice) number                           |
| <b>F/T</b>   | both a fax and telephone (voice) number              |
| <b>CHAIN</b> | a number (usually an access code) for chain dialing. |
- 6** Press ◀ or ▶ to select if you set ANTI JUNK to ON (or OFF) and press **Function/Set**.
- 7** Return to Step 2 to store another Speed Dial number—**OR**—Press **Stop** to exit.

## Changing One Touch and Speed Dial Numbers

If you try to store a One Touch or Speed Dial number in a location where a number is already stored, the screen displays the current name stored there, then prompts you to either

### 1. CHANGE—OR—2. QUIT.

- 1** Press **1** to change the number stored, or press **2** to exit without making a change.
- 2** Enter a new number.
- If you want to erase the entire number, press **Stop** when the cursor is to the left of the digits. The letters above and to the right of the cursor are deleted.
  - If you want to change a digit, use ◀ or ▶ to position the cursor under the digit you want to change, then type over it.
- 3** Follow the directions from Step 3 in Storing One Touch Numbers or Storing Speed Dial Numbers.

## Setting Up Groups for Broadcasting (For FAX-335MC Only)

Groups allow you to send the same fax message to many fax numbers by pressing only one One Touch key (Broadcasting). **First**, you'll need to store each fax number as a One Touch or Speed Dial number. **Then**, you can combine them into a Group. **Each Group uses up a One Touch key**. **Finally**, you can have up to four small Groups, or you can assign up to 103 numbers to one large Group. (See *Storing One Touch Dial Numbers/Storing Junk Fax/Call Numbers*, page 7-1, *Storing Speed Dial Numbers/Storing Junk Fax/Call Numbers*, page 7-2 and *Broadcasting (For FAX-335MC Only)*, page 7-6.)

- 1** Press **Function/Set, 6, 3**. SELECT ONE-TOUCH
- 2** Select a One Touch key where you wish to store the number. (For example, press One Touch key **2** to store a Group.)

- 3** Use the dial pad to identify the Group with a number and press **Function/Set**. (For example, press **1** for Group 1.)



- 4** To include One Touch or Speed Dial numbers in the Group, enter them as if you were dialing. For example, for One Touch key 3, press One Touch key **3**. For Speed Dial location 09, press **Search/Speed Dial**, then press **0, 9** on the dial pad. The LCD shows **\*03, #09**.

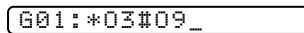

- 5** Press **Function/Set** to accept the numbers for this group.

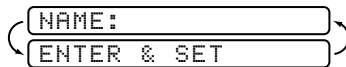

- 6** Use the dial pad to enter a name for the group and press **Function/Set**. (For example, NEW CLIENTS) (See *Details for Entering Text*, page 4-2.)

- 7** Press **Stop** to exit.



You can print a list of all One Touch and Speed Dial numbers. See *Printing Reports*, Chapter 11.

## Dialing Options

---

You can use your fax machine to make voice telephone calls, by dialing manually, or by using Search, One Touch or Speed Dial memory. You can use the handset or, if you have FAX-335MC, you can use the **Speaker Phone** to make and receive calls.

The Speaker phone allows you to operate the phone hands free, or allows more than one person in the room to participate in a two-way phone conversation. When using the Speaker phone, make sure to speak clearly and close to the microphone .

When you dial an auto dial number, the screen displays the name you've stored, or, if you haven't stored a name, the fax number you've stored.

### Manual Dialing



Manual dialing is simply pressing all of the digits of the phone number.

- 1** Pick up the handset—**OR**—Press **Hook** or **Speaker Phone**.
- 2** When you hear a dial tone, dial the number using the dial pad.
- 3** If you pressed **Hook** to dial the call, pick up the handset when the other party answers. (The speaker works only one way; the other party won't be able to hear you unless you pick up the handset.)

On the FAX-335MC, you can switch from handset to Speaker phone by pressing **Speaker Phone**, then replacing the handset. You can switch from Speaker phone to handset by lifting the handset.

- 4** To hang up, replace the handset—**OR**—Press **Speaker Phone**.

## One Touch Dialing

- 1 Pick up the handset—**OR**—Press **Hook** or **Speaker Phone**. (See *Storing One Touch Dial Numbers/Storing Junk Fax/Call Numbers*, page 7-1.)
  - 2 When you hear a dial tone, press the One Touch key of the location you want to call.
  - 3 If you pressed **Hook** to dial the call, pick up the handset when the other party answers. (The speaker works only one way; the other party won't be able to hear you unless you pick up the handset.)
  - 4 To hang up a voice call, replace the handset—**OR**—Press **Speaker Phone**.
-  If you try to use a One Touch location with no number stored in it, you hear a warning sound, and screen displays NOT ASSIGNED. The display returns to normal after 2 seconds.
-  If you are sending a fax, press **Start** after pressing the One Touch key. If you picked up the handset, press **Start** when the receiving fax machine answers with fax tones.



## Speed Dialing

- 1 Pick up the handset—**OR**—Press **Hook** or **Speaker Phone**. (See *Storing Speed Dial Numbers/Storing Junk Fax/Call Numbers*, page 7-2.)
  - 2 When you hear a dial tone, press **Search/Speed Dial**, press **#**, then press the two-digit Speed Dial number.
  - 3 If you pressed **Hook** to dial the call, pick up the handset when the other party answers. (The speaker works only one way; the other party won't be able to hear you unless you pick up the handset.)
  - 4 To hang up a voice call, replace the handset—**OR**—Press **Speaker Phone**.
-  If you are sending a fax, press **Start** after entering the Speed Dial number. If you picked up the handset, press **Start** when the receiving fax machine answers with fax tones.



## Search

You can search for names you have stored in One Touch and Speed Dial memories. Names are shown alphabetically. (See *Storing One Touch Dial Numbers/Storing Junk Fax/Call Numbers*, page 7-1 and *Storing Speed Dial Numbers/Storing Junk Fax/Call Numbers*, page 7-2.)

- 1 Press **Search/Speed Dial**, then enter the first letter of the name you're looking for.
- 2 Press  or  to search the memory.
- 3 When the screen displays the name you want to call, pick up the handset or press **Hook** or **Speaker Phone** for a voice call.
- 4 Press **Start** to begin dialing.
- 5 If you pressed **Hook** to dial the call, pick up the handset when the other party answers. (The speaker works only one way; the other party won't be able to hear you unless you pick up the handset.)
- 6 When the call is over, hang up—**OR**—Press **Speaker Phone** (For FAX-335MC Only) to cancel the call.

## Redial

If the last number you dialed was busy, press **Redial/Pause** for easy dialing.

## Answering Calls with the Speaker phone (For FAX-335MC Only)

When the fax machine rings, instead of lifting the handset, press **Speaker Phone**. Speak clearly, toward the microphone . To end the call, press **Speaker Phone**.

If you have a bad telephone line connection, the other party might hear your voice echoed during the call. Hang up and try the call again—**OR**—Pick up the handset.

## Broadcasting (For FAX-335MC Only)

Using the numbers you have stored in Groups, One Touch and Speed Dial memory, you can “broadcast” faxes automatically to a maximum of 104 different locations in a few simple steps. (See *Setting Up Groups for Broadcasting (For FAX-335MC Only)*, page 7-3.) To Broadcast, you must set MEMORY TX to either ON or NEXT FAX ONLY.

After the Broadcast is completed, a Broadcast Report will be printed automatically to let you know the results.

- 1 Place the original face down in the ADF.

- 2** Press **Function/Set, 3, 9** to select ON or NEXT FAX ONLY and press **Function/Set**.
    - If you select ON, the screen displays to choose additional setting and press 2 to go to Step 3.
    - If you select NEXT FAX ONLY, then select NEXT FAX:ON and press **Function/Set**.  
The screen displays to choose additional setting and press 2 to go to Step 3.
  - 3** Enter the One Touch and Speed Dial numbers (one after the other) or a Group Number you have stored.
  - 4** Press **Start**. The fax machine stores the original in memory, then transmits it to all the numbers you entered.
-  Press **Stop** during transmission to cancel the current fax broadcast.

## Pause

Press **Redial/Pause** to insert a pause between numbers. Each key press adds a 3.5 second delay.

## Hold

- 1** Press **Hold** to put a call on Hold.
- 2** You can put down the handset without disconnecting the call.
- 3** Pick up the fax machine handset—**OR**—Press **Speaker Phone** (For FAX-335MC only) to release the call from Hold. Picking up an extension handset will not release the call from Hold.

## Tone/Pulse

If you have pulse dialing service, but need to send tone signals (for telephone banking, for example), follow the directions below. If you have touch tone service, you do not need this feature to send tone signals.

- 1** Lift the handset.
- 2** Press **#**. Any digits dialed after this send tone signals.
- 3** When you hang up, the fax machine returns to pulse dialing service.

## Custom Features

---

Your fax machine supports the Distinctive Ring and Caller ID telephone services offered by some telephone companies.



If you have Call Waiting, Ring Master, Voice Mail, an answering service or an alarm system or other custom feature on your telephone line, it may create a problem in the operation of your fax machine. The Distinctive Ring and Caller ID feature may not be available in certain area.

### Distinctive Ring (For Singapore and Hong Kong)

This fax machine feature lets you use the Distinctive Ring subscriber service offered by some telephone companies, which allows you to have several telephone numbers on one phone line. Each phone number has its own Distinctive Ring pattern, so you know which phone number is ringing. This is one way you can have a separate phone number for your fax machine.



Your fax machine has a Distinctive Ring function, allowing you to dedicate one phone number just for receiving faxes. You'll need to set Distinctive Ringing to ON.



You can switch it off temporarily, then turn it back on. When you get a new fax number, make sure you reset this function.

- The fax machine will answer only calls to the Distinctive Ringing number.
- To have your TAD answer only the main number, the fax machine must be in Manual Mode.
- In FAX/TEL or FAX ONLY mode, the fax machine will answer all numbers on the phone line.
- The first two rings are silent on the fax machine.
- When you set Distinctive Ringing to ON, the fax machine becomes in Manual Mode automatically, and will not accept a change to the Answer Mode.

## Setting the Distinctive Ring

- 1** If you have Voice Mail from the Telephone Company, you must disconnect it now (temporarily).
- 2** Disconnect the fax machine from any external telephone answering device (TAD).
- 3** Set the fax machine to MANUAL mode.
- 4** Press **Function/Set, 0, 1**.
- 5** Press  or  to select **ON** (or **OFF**).
- 6** Press **Function/Set**.
- 7** Press **Stop** to exit.

## Caller ID (For Singapore and Hong Kong)

The Caller ID feature of this fax machine lets you use the Caller ID subscriber service offered by many local telephone companies. After at least two rings, the screen displays the telephone number of your caller (or up to 16 characters of the name, if available). Once you pick up the handset, the Caller ID information disappears from the screen, but the call information remains stored in the Caller ID memory.

- CALL PICKUP display remains on the screen when no Caller ID information was transmitted.
- OUT-OF-AREA display means the call originates outside your Caller ID service area.
- PRIVATE CALL display means the caller has intentionally blocked transmission of information.

Caller ID service varies with different carriers. Call your local telephone company to determine the kind of service available in your area.

## Caller ID Log





Your fax machine stores up to 10 (FAX-235 and FAX-236) or 30 (FAX-335MC) of the last Caller IDs received into the fax machine's memory in the Caller ID Log. When the 11th (FAX-235 and FAX-236) or 31st (FAX-335MC) call comes in, information about the first call is erased. You can print the report or scroll through Caller ID information to review those calls made to your fax machine.



## Printing the Caller ID Log

- 1 Press **Hold**.
- 2 To print the Caller ID Log, press **Start**.

CALLER ID LOG  
PRINTING

## Viewing the Caller ID Log

- 1 Press **Hold**.
- 2 After 2 seconds, press  or  to scroll through the Caller ID Log.
- 3 When you want to see more detailed information for a displayed ID (phone number and date and time call was received) press **Function/Set**.
- 4 To continue viewing the Caller ID Log (Step 2), press  or .  
—OR—
- 5 To exit the Caller ID Log, press **Stop**.

CALLER ID LOG  
PRESS START KEY  
SELECT   & SET  
01>MARY HENDERSON  
02>TOM HENDERSON  
03>ABC COMPANY  
03>ABC COMPANY  
03>9087772837  
03>02/01 12:00  
DIAL:PRESS START





If you have FAX 335MC, you can delete a name from the Caller ID Log, by pressing **Erase** in Step 2 or Step 3.



ERASE THIS DATA?  
1.YES 2.NO

Press **1** to erase the selected Caller ID (or **2** to return to the Log without erasing).

## Returning a Call from the Log

You can scroll through the Caller ID Log and select a call to return automatically. (See page 8-2)

- 1 Press **Hold**.
- 2 Press  or  to scroll through the Caller ID Log and when you see a call you want to return immediately, press **Function/Set**.
- 3 To begin dialing, press **Start**.
- 4 Begin speaking when the other party answers.

CALLER ID LOG  
PRESS START KEY  
SELECT   & SET  
01>MARY HENDERSON  
01>9082438436  
01>02/01 12:00  
DIAL:PRESS START



This feature may not be available in certain area.

## Registering a Caller ID Number

You can set up a caller in the Caller ID Log as a One Touch or Speed Dial number.

- 1 Press **Hold**.

CALLER ID LOG

PRESS START KEY

SELECT ← → & SET

- 2 After 2 seconds, press ◀ or ▶ to scroll through the Log and when you see a caller you want to register, press **Function/Set**.

03>ABC COMPANY

03>9087772837

03>02/01 12:00

- 3 To register the caller as a One Touch number, press the One Touch key where you want the number to be stored.

DIAL:PRESS START

—OR—

To register the caller as a Speed Dial number, press **Search/Speed Dial** and use the dial pad to press the two-digit location code (01–60 (FAX-235) or 00-99(FAX-236/335MC)), and press **Function/Set**.

NAME:

ENTER & SET



If the LCD shows REGISTERED, the auto dial location already has a number.

- 4 Enter the caller's name and press **Function/Set**.
- 5 Press ◀ or ▶ to select the type of number and press **Function/Set**:

FAX            A fax number

TEL            A telephone (voice) number

F/T            Both a fax and telephone number

CHAIN        A number, usually an access code, for chain dialing

- 6 Press ◀ or ▶ to select if you set ANTI JUNK to ON (or OFF) and press **Function/Set**.

- 7 Return to Step 2 to store another auto dial number—OR—Press **Stop** to exit.

### Message Center Mode

Message Center Mode allows you to store incoming fax and voice messages in a flexible memory. The memory stores 15 minutes of voice messages, or up to 20 pages of fax memory. Any voice or fax message can be retrieved remotely. Memory is shared between fax and voice messages, which are stored on a “first-come, first-served” basis.

You must record an outgoing message in order to use the Message Center Mode. (See *Recording Message Center Outgoing Message*, page 9-2.)

### Flexible Memory Settings (Message Store)

Message Center Mode offers you six flexible memory settings, so you can decide the kinds of messages you want to receive.

- |                            |   |
|----------------------------|---|
| <b>1.DOC:ON VOICE:ON</b>   | Both voice and fax messages are stored. You can use the Fax Forwarding or Paging features and retrieve voice and fax messages remotely.   |
| <b>2.DOC:ON VOICE:EXT</b>  | You need an external answering machine connected to the EXT jack for this setting. Fax messages are stored in the message center memory, but voice messages are stored in your external answering machine. Retrieve messages from the external answering machine. You cannot use the Paging feature for voice messages with this setting. |
| <b>3.DOC:ON VOICE:OFF</b>  | All memory is used to store fax messages—no voice messages will be stored.  |
| <b>4.DOC:OFF VOICE:ON</b>  | All memory is used to store voice messages—no fax messages will be stored. Incoming faxes will print on paper. You can use the Paging feature, and retrieve voice messages remotely.  |
| <b>5.DOC:OFF VOICE:EXT</b> | You need an external answering machine connected to the EXT jack for this setting. Incoming faxes are not stored in memory, but will print on paper. Voice messages are stored in the external answering machine. <b>(External answering machine can not be connected in some countries.)</b>   |
| <b>6.DOC:OFF VOICE:OFF</b> | Incoming faxes are not stored in memory, but will print on paper. Voice calls are not stored in memory.   |





## Setting Up the Message Center

You must set up the Message Center in the following order:

- 1 Setting Message Storage. (See *Setting Message Store*, page 9-2.)
- 2 Record Message Center Outgoing Message (MSG CTR OGM). (See *Recording Message Center Outgoing Message*, page 9-2.)
- 3 Activate Message Center Mode. (See *Activating Message Center Mode*, page 9-3.)

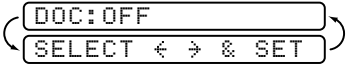

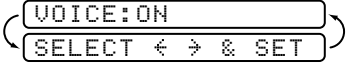
## Setting Message Store

Read the Flexible Memory Setting descriptions on page 9-1 before you select the FAX and VOICE settings below.

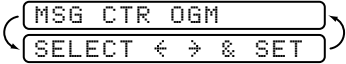

- 1 Press **Function/Set, 8, 1.**  

- 2 Press  or  to select ON (or OFF) and press **Function/Set.**  

- 3 Press  or  to select your setting from the list on pages *Flexible Memory Settings (Message Store)*, page 9-1 (ON, OFF, EXT) and press **Function/Set.**
- 4 Press **Stop** to exit.

## Recording Message Center Outgoing Message

Recording the Message Center Outgoing Message (MSG CTR OGM) is the second step you need to follow before you can turn on the Message Center. Make sure your OGM is less than 20 seconds long.

- 1 Press **Function/Set, 8, 3.**  
The screen prompts you to choose an OGM.  

- 2 Press  or  to select MSG CTR OGM (not FAX/TEL OGM) and press **Function/Set.**

**This is the only setting you can select if you want to turn the Message Center on.**

- 3 Press  or  to select RECORD MSG and press **Function/Set.**
- 4 Pick up the handset to record a message.

**For example:** *Hello. We are unable to take your call at this time. Please leave a message after the signal. If you wish to send a fax, please press \*5 1, wait for fax tones, then press the Start button.*

- 5 Replace the handset. The Message Center will play your OGM.
- 6 Press **Stop** to exit.



## Listening to Outgoing Message (OGM)

- 1 Press **Function/Set**, **8**, **3**.
- 2 Press ◀ or ▶ to select MSG CTR OGM (or FAX/TEL OGM or PAGING OGM) and press **Function/Set**.
- 3 Press ◀ or ▶ to select PLAY MSG and press **Function/Set**. Adjust volume by pressing Volume ◀ or ▶.
- 4 Press **Stop** to exit.

## Erasing Outgoing Message (OGM)

- 1 Press **Function/Set**, **8**, **3**.
- 2 Press ◀ or ▶ to select MSG CTR OGM (or FAX/TEL OGM or PAGING OGM) and press **Function/Set**.
- 3 Press ◀ or ▶ to select ERASE MSG and press **Function/Set**.
- 4 Press **1** to erase the OGM—**OR**—Press **2** to exit without erasing.
- 5 Press **Stop** to exit.

## Activating Message Center Mode

Press and hold  until it lights and the screen displays

MC:MSG CTR

When  light is out, the Message Center is off. (See *Setting Up the Message Center*, page 9-2.)

## Message Indicator

The  light flashes when you have *new* messages or faxes waiting for your review.

The LCD screen displays the total number of voice and fax messages stored in the Message Center memory.

VOICE:03 DOC:02

If you press the flashing  to turn off the Message Center before getting your new messages, they won't be lost. The new messages will be played automatically and the LCD will ask you to acknowledge the new faxes:

PRINT DOC?  
1.YES 2.NO

Press **1** to print (and automatically delete) the faxes from memory—**OR**—Press **2** to save the faxes in memory until printing is convenient.

## Playing Voice Messages

Follow the steps below to listen to voice messages.

- 1 Press **Play/Record**. Adjust the Volume by pressing ◀ or ▶.

All messages are played in the order they were recorded. The display shows the number of the current message, and the total number of messages.

If Caller ID information was received, the fax machine beeps during the message and displays the Caller ID information for one second (for some countries).

During playback, the screen displays the time and date the message was recorded.

- 2 Press \* (RWD) at the end of the message to repeat a message. Press # (FWD) to skip to the next message. You can press \* and # repeatedly until you reach the message you want to play.
- 3 Press **Stop** to exit.

## Printing a Fax Message

Once you print a new fax message stored in memory, it is erased from the memory automatically.

- 1 Press **Play/Record**. After two seconds, the fax machine begins to play voice messages.
- 2 If there are fax messages in memory, the LCD displays:
- 3 To print the faxes, press **1**

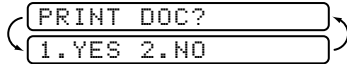

PRINT DOC?  
1.YES 2.NO

—OR—

Press **2** to exit without printing.

## Backup Printing Option

When you choose DOC: ON in the Message Center mode, all incoming fax messages are stored in the available memory for retrieval. To print a backup copy automatically, turn this option on.

- 1 Press **Function/Set, 8, 2**.
- 2 Press ◀ or ▶ to display **ON** (or **OFF**) and press **Function/Set**.
- 3 Press **Stop** to exit.



BACKUP PRINT:ON  
SELECT < > & SET

## Erasing Messages



If you choose to erase all *fax* messages, the fax machine will print any previously unprinted faxes before erasing them from memory. Fax messages cannot be erased individually.

You can erase *voice* messages individually, or all at once.

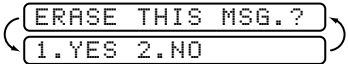
## To erase voice messages individually



- 1 Press **Play/Record**. The fax machine sounds a two-second beep and begins message playback. Each message is preceded by one long beep, and followed by two short beeps.
- 2 To erase a specific message, press **Erase** immediately after the two short beeps, or while the message is playing. The screen prompts 
- 3 Press **1** to erase the message—**OR**—Press **2** to cancel.
- 4 Press **Stop** to exit.

## To erase messages all at once

- 1 Press **Erase**.
- 2 Press  or  to select erasing all voice messages (**VOICE**), all document messages (**DOC**), or all messages—both voice and fax—(**MSG**) and press **Function/Set**. 
- 3 Press **1** to erase—**OR**—Press **2** to cancel.
- 4 Press **Stop** to exit.

## Setting Maximum Time for Incoming Messages



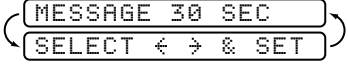

Your fax machine comes set to receive voice messages up to 30 seconds long. You can change this setting to any length from 20 seconds to 60 seconds, in 5-second increments.

- 1 Press **Function/Set, 8, 4**.
- 2 Press  or  to select the maximum time setting for incoming messages and press **Function/Set**. 
- 3 Press **Stop** to exit.

## Setting Toll Saver



When you set the toll saver feature, the fax machine answers after four rings if you *don't* have messages, and after two rings if you *do* have messages. This way, when you call the fax machine, if it rings three times, you know you have no messages, and can hang up, to avoid a toll charge.

 When Toll Saver is ON, it overrides your Ring Delay setting. Toll Saver must be off for the fax machine to operate using your Ring Delay setting. (See *Setting Ring Delay*, page 5-3.)

- 1 Press **Function/Set, 2, 1**.
- 2 Press  or  to select the TOLL SAVER (or RING DELAY) and press **Function/Set**.
- 3 Press  or  to select ON and press **Function/Set**.
- 4 Press **Stop** to exit.

## ICM Recording Monitor

This feature lets you turn the speaker volume for voice messages ON or OFF. When you turn the monitor OFF, you will not hear messages as they come in.

- 1 Press **Function/Set, 8, 5**.
- 2 Use  or  to select OFF (or ON) and press **Function/Set**.
- 3 Press **Stop** to exit.

## Recording a Conversation

You can record a telephone conversation by pressing **Play/Record** during the conversation. Your recording can be as long as the Incoming Message Maximum Time. The other party will hear a beep every 15 seconds while recording. To stop recording, press **Stop**. You cannot record a conversation using Speaker Phone.

## Fax Forwarding/Paging



When Paging is set to ON, your fax machine dials the pager number you've programmed, and plays the Paging OGM you have recorded when connected, to activate your pager and let you know you have a fax or voice message in the Message Center memory.

When Fax Forwarding is set to ON, your fax machine dials the fax machine phone number you've programmed, and forwards any faxes you've received.



You can *not* use Paging and Fax Forwarding at the same time.

## Programming a Fax Forwarding Number

- 1 Press **Function/Set, 8, 6**.
- 2 Press  or  until the LCD displays **FAX FORWARD** and press **Function/Set**.
- 3 Enter the number of the fax machine where faxes will be forwarded (up to 20 digits) and press **Function/Set**.
- 4 Press **Stop** to exit.

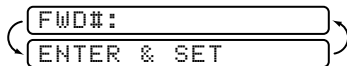





You can change a Fax Forwarding number remotely. (See page 9-12.)



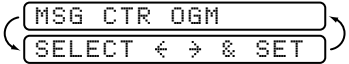

You can *not* use Paging and Fax Forwarding at the same time.

## Recording the Paging Outgoing Message (OGM)

Before paging can work, you should first record the Paging OGM.

- 1 Press **Function/Set, 8, 3**. The screen prompts you to choose an OGM. 
- 2 Press  or  to reach PAGING OGM and press **Function/Set**.
- 3 Press  or  to Select RECORD MSG and press **Function/Set**. Then pick up the handset to record a message.
- 4 Replace the handset. Your OGM is played.
- 5 Press **Stop**.

## Programming Paging Number

- 1 Press **Function/Set, 8, 6**.
- 2 Press  or  until the LCD displays PAGING and press **Function/Set**.
- 3 Enter your pager phone number (up to 20 digits) and press **Function/Set**. 
- 4 Press **Stop** to exit.



You can *not* change a Paging number remotely.

# Remote Retrieval

---

## Using Remote Retrieval Access Code

- 1 Dial your fax number from a touch tone phone.
- 2 When your fax machine answers, immediately enter your Remote Retrieval Access Code.
- 3 The fax machine signals the kinds of messages received:
  - 1 long beep—**Fax message(s)**
  - 2 long beeps—**Voice message(s)**
  - 3 long beeps—**Fax and Voice message(s)**
  - No beeps—**no messages**
- 4 The fax machine then prompts you with two short beeps to enter a command. If you wait longer than 30 seconds to enter a command, the MFC hangs up. If you enter an invalid command, the fax machine beeps three times.
- 5 Press **9 0** to reset the fax machine when you finish.
- 6 Hang up.



If your fax machine is set to MANUAL mode, you can access the Message Center by waiting about 2 minutes, then entering the Remote Access Code within 30 seconds.

## Changing Remote Retrieval Access Code

Enter your Remote Retrieval Access Code when the fax machine picks up your call, so you can access features remotely. The access code is preset to 159✳, but you can change it.

- 1 Press **Function/Set, 8, 7**.
  - 2 Enter a three-digit number from 000 to 999 and press **Function/Set**. The “✳” cannot be changed.
-  Do not use the same digits that appear in your Fax Receive Code or Telephone Answer Code.
- 3 Press **Stop** to exit.

## Remote Commands

Follow the commands below to access features remotely. When you call the fax machine and enter your Remote Retrieval Access Code (159\*), the system will signal you with two short beeps to enter a remote command.

Remote Commands		Operation Details	
<b>91 Playing Voice Messages</b>		After one long beep, the fax machine plays ICM.	
	1 ◀ (go back)	Press <b>1</b> while listening to an ICM to repeat it. If you press <b>1</b> before a message, you will hear the previous message.	
	2 ▶ (Skip to next)	While playing the ICM, you can skip to the next message.	
	9 STOP Playing	Stop playing the ICM.	
<b>93 Erase all ICM</b>		If you hear one long beep, the erase is accepted. If you hear three short beeps, you cannot erase because all voice messages have not been played, or there is no voice message to erase. *This code erases all recorded messages, not one at a time.	
<b>94 Play and Record OGM in memory</b>	1 Play	1 MSG CTR OGM	The fax machine plays the selected OGM. You can stop playing OGMs by pressing <b>9</b> .
		2 F/T OGM	
		3 PAGING OGM	
	2 Record	1 MSG CTR OGM	After one long beep, you can record the selected OGM. You will hear the message played once. You can stop recording the message by pressing <b>9</b> .
		2 F/T OGM	
		3 PAGING OGM	
<b>95 Changing Fax Forwarding/Paging Setting</b>	1 OFF	If you hear one long beep, the change is accepted. If you hear three short beeps, you cannot change it because the conditions have not been met (Example: registering paging number). You can register your fax forwarding number by using 4. FAX FWD NO. (See page 9-12.) Once you have registered the number, the fax machine will change automatically to FAXFWD:ON mode. Then retrieve a Memory Status List by entering <b>9 6 1</b> (See page 9-11.) to make sure that the Fax Forwarding number you registered is correct in the List.	
	2 Fax Forwarding		
	3 Paging		
	4 FAX FWD NO.		

Remote Commands		Operation Details
<b>96 Retrieve a fax</b>	1 Memory Status List	Enter the number of a remote fax machine to receive a report or stored fax messages. (See page 9-11.)
	2 Retrieve all faxes	
	3 Erase fax in the memory	If you hear one long beep, you can erase the fax message from the memory.
<b>97 Check the receiving status</b>	1 DOCUMENT	You can check whether your fax machine has received any FAX or VOICE messages. If yes, you will hear one long beep. If no, you will hear three short beeps.
	2 VOICE	
<b>98 Change Answer Mode</b>	1 MSG CTR	If you hear one long beep, you can change the answer mode. If you hear three short beeps, you cannot change it. (Example: There is no MSG CTR OGM when you want to change to MSG CTR mode.)
	2 FAX/TEL	
	3 FAX	
<b>90 Exit</b>		After a long beep, you can exit remote control.



## Retrieving Memory Status List

You can retrieve the Memory Status List from a remote fax machine to see if you have any fax messages.

- 1** Dial your fax number.
- 2** When you hear the beep, immediately enter your Remote Retrieval Access Code (**1 5 9 \***).
- 3** When you hear two short beeps, use the dial pad to press **9 6 1**.
- 4** Using the dial pad, enter the number of the remote fax machine (up to 20 digits) where you want the Memory Status List forwarded, and then press **##**.



You can *not* use \* or # as dial numbers. However, if you want to store a pause, press #.

- 5** After you hear your fax machine beep, hang up and wait.

Your fax machine calls the remote fax machine. The remote fax machine prints the Memory Status List.

## Retrieving Fax Messages

- 1** Dial your fax from a remote telephone or fax machine using touch tone.
- 2** When you hear the beep, immediately enter your Remote Retrieval Access Code (**1 5 9 \***).
- 3** As soon as you hear two short beeps, use the dial pad to press **9 6 2**.
- 4** Using the dial pad, enter the number of the remote fax machine (up to 20 digits) where you want your fax messages forwarded, and then press **##**.



You can *not* use \* or # as dial numbers. However, if you want to store a pause, press #.

- 5** After you hear your fax machine beep, hang up and wait.

Your fax machine calls the remote fax machine. The remote fax machine prints your fax messages.

## Changing Fax Forwarding Number

You can change the default setting of your fax forwarding number from a remote fax machine.

- 1** Dial your fax number.
- 2** When you hear the beep, immediately enter your Remote Retrieval Access Code (**1 5 9 \***).
- 3** When you hear two short beeps, use the dial pad to press **9 5 4**.
- 4** Enter the new number of the remote fax machine where you want your fax messages forwarded, then press **# #**.



You can *not* use **\*** or **#** as dial numbers. However, if you want to store a pause, press **#**.

- 5** To retrieve the Memory Status List, when you hear two short beeps, use the dial pad to press **9 6 1**.
- 6** Use the dial pad to enter the number of the remote fax machine (up to 20 digits), then press **# #**.
- 7** After you hear your fax machine beep, hang up and wait.  
Your fax machine calls the remote fax machine. The remote fax machine prints the Memory Status List showing the new forwarding number.
- 8** Check the forwarding number.

If the forwarding number is not correct, return to Step 1 to reset it.

# 10 Making Copies

## Copy Functions

---

To make a single copy that is not reduced, enlarged or sorted, you only have to press one key. The default resolution for a single copy is Super Fine. Set the resolution to PHOTO for photographs. Remember, your machine cannot scan anything closer than one-eighth inch from the edge of the paper.

### Making a Single Copy

- 1 Place the original face down in the ADF.
- 2 Press **Copy/Help**.  
(If you have FAX-335MC, press **Copy/Help** twice.)

To cancel, press **Stop**.

Do NOT pull on the paper while copying is in progress.

### Copy Options: Single or Multiple Copies, Sort/Stack (For Fax-335MC Only)

You can choose additional copy options. First, you can select the number of copies. Next, you can choose whether multiple copies will be STACKED (all copies of page 1, then all copies of page 2, etc.) or SORTED (collated).

- 1 Place the original face down in the ADF.
- 2 Press **Copy/Help**.
- 3 Enter the number of copies you want (1-99).  
For example, press 9 for nine copies.  
*To start copying now*, press **Copy/Help**.

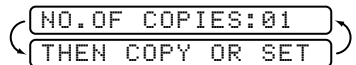

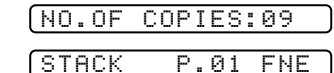

NO. OF COPIES: 01  
THEN COPY OR SET

*If you would like to set SORT*, press **Function/Set** and then press **Copy/Help**.



NO. OF COPIES: 09  
STACK P. 01 FNE

- 4 Press  or  to select **SORT** or **STACK**.  
For example, select **SORT** and **Copy/Help**.

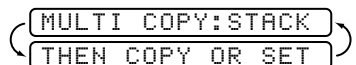

MULTI COPY: STACK  
THEN COPY OR SET

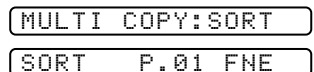

MULTI COPY: SORT  
SORT P. 01 FNE



If you are making multiple copies and get a **OUT OF MEMORY** message while you are scanning the first page, press **Stop** to cancel the job. Then make a single copy. If you selected SORT and the **OUT OF MEMORY** message appears while scanning subsequent pages, you can press **Copy/Help** to copy the portion that is in memory, or press **Stop** to cancel. To restart the copy job using less memory, press **Copy/Help** for stacked copies.

# 11 Printing Reports

## Fax machine Settings and Activity

---

You can print the following lists and reports:

1. TRANSMISSION

Choose to print a Transmission Verification Report after each fax you send.

2. JOURNAL

Journal lists information about the last 15 (FAX-235/236) or 30 (FAX-335MC) incoming and outgoing faxes. TX means Transmit; RX means Receive.

3. QUICK-DIAL

Lists names and numbers stored in One Touch and Speed Dial memory, in numerical order.

4. TEL. INDEX

QUICK-DIAL LIST (above), alphabetically.

5. SYSTEM SETUP



Lists settings for INITIAL SETUP, SETUP RECEIVE, SETUP SEND, PRINT REPORTS, MISCELLANEOUS, and SETUP MSG CTR (for FAX-335MC only).

6. MEMORY STATUS

(For FAX-335MC Only)

Lists summary information and amount of memory in use.

### To Print a Report

- 1 Press **Function/Set, 7**.
- 2 Enter the number of the report you want to print. For example, press **4** to print the TEL.INDEX.
-  For the Activity Report, also press  or  to select PRINT REPORT.
- 3 Press **Start**.
- 4 Press **Stop** to exit.

## Transmission Verification Report

You can use the TRANSMISSION as proof that you sent a fax. This report lists the name or fax number of the receiving party, the time and date of transmission, and whether the transmission was successful.

When the feature is OFF, the report is printed automatically only if there's an error during transmission. If the report indicates NG, send the original again. If the report indicates you should check the readability of certain pages, resend those pages.

When the feature is ON, the report is printed with every fax you send.

- 1 Press **Function/Set, 7, 1.**
- 2 Press ◀ or ▶ to select ON (or OFF) and press **Function/Set.**
- 3 Press **Stop** to exit.

## JOURNAL Interval

You can set the fax machine to print journals at specific intervals (6, 12, 24 hours, 2, 7 days). If you set the interval to OFF, you can print the report by following the steps in the previous section.

- 1 Press **Function/Set, 7, 2.**
- 2 Press ◀ or ▶ to display: JOURNAL PERIOD and press **Function/Set.**
- 3 Press ◀ or ▶ to choose your setting and press **Function/Set.** If you choose 7 days, the screen prompts you to choose a day at which to begin the 7-day countdown.
- 4 Enter the time, in 24-hour format, that printing will begin and press **Function/Set.** (For example, enter 19:45 for 7:45 PM)
- 5 Press **Stop** to exit.

# 12 Important Information

## Important Safety Instructions

- 1** Read all of these instructions and save them for future use.
- 2** Follow all warnings and instructions marked on the product.
- 3** Unplug this product from the wall outlet before cleaning. Do not use liquid or aerosol cleaners. Use a damp cloth for cleaning.
- 4** Do not use this product near water.
- 5** Do not place this product on an unstable cart, stand, or table. The product may drop, causing serious damage to the product.
- 6** Slots and openings in the cabinet and the back or bottom of the machine are provided for ventilation; to ensure reliable operation of the product and to protect it from overheating, these openings must not be blocked or covered. The openings should never be blocked by placing the product on a bed, sofa, rug, or other similar surface. This product should never be placed near or on a radiator or heater. This product should never be placed in a built-in installation unless proper ventilation is provided.
- 7** This product should be operated from the type of power source indicated on the label. If you are not sure of the type of power available, consult with your dealer or local power company.
- 8** This product is equipped with a 2-wire grounding type plug or a 3-wire grounding type plug (for Singapore, Malaysia, Hong Kong and India). This plug will only fit into a grounding-type power outlet. This is a safety feature. If you are unable to insert the plug into the outlet, contact your electrician to replace your obsolete outlet. Do not defeat the purpose of the grounding-type plug.
- 9** Do not allow anything to rest on the power cord. Do not place this product where people can walk on the cord.
- 10** If an extension cord is used with this product, make sure that the total ampere ratings on the products plugged into the extension cord do not exceed ampere rating of the extension cord ampere rating.
- 11** Do not place anything in front of the fax machine that will block the exit- path of sent documents, originals and received faxes.
- 12** Do not touch an original during printing.
- 13** Never push objects of any kind into this product through cabinet slots, because they may touch dangerous voltage points or short out parts resulting in a risk of fire or electric shock. Never spill liquid of any kind on the product.

- 14** Do not attempt to service this product yourself, as opening or removing covers may expose you to dangerous voltage points and/or other risks, and may void your warranty. Please refer all servicing to our Authorized Service Personnel. You may contact the Brother Dealer for Service.
- 15** Unplug this product from the wall outlet and refer servicing to Authorized Service Personnel under the following conditions:
- A** If the power cord is damaged or frayed.
  - B** If liquid has been spilt on the product.
  - C** If the product has been exposed to rain or water.
  - D** If the product does not operate normally when the operating instructions are followed. Adjust only those controls that are covered by the operating instructions. Improper adjustment of other controls may result in damage and will often require extensive work by a qualified technician to restore the product to normal operation.
  - E** If the product has been dropped or the cabinet has been damaged.
  - F** If the product exhibits a distinct change in performance, indicating a need for service.
- 16** To protect your product against power surges, we recommend the use of a power protection device (Surge Protector).

 **WARNING**

For protection against the risk of electrical shock, always disconnect all cables from the wall outlet before servicing, modifying or installing the equipment.

This equipment may not be used on coin service lines provided by the telephone company or connected to party lines.

Brother cannot accept any financial or other responsibilities that may be the result of your use of this information, including direct, special or consequential damages. There are no warranties extended or granted by this document.



# 13 Troubleshooting and Maintenance

## Troubleshooting

### Error Messages

You may occasionally encounter a difficulty with your fax machine or telephone line. If this happens, your fax machine often identifies the problem and displays an error message. The list below explains the most common error messages.

COMM.ERROR XX XX

A poor quality phone line resulted in a communications error. Try the call again.

CONNECTION FAIL

You have requested a polling call from another party, but the other fax machine is not in Poll Waiting mode.

COVER OPEN  
PLS CLOSE COVER

The cover is not completely closed.

CUTTER JAM  
PLS OPEN COVER  
CUTTER JAM  
REMOVE PAPER

The fax paper is jammed in the cutter.

- 1 Open the cover.
- 2 Unplug the power cord.
- 3 Pull up the blue release lever on the print head unit and raise it.
- 4 Gently turn the paper roll toward the front of the machine to roll out the jammed paper.

Recording paper .....

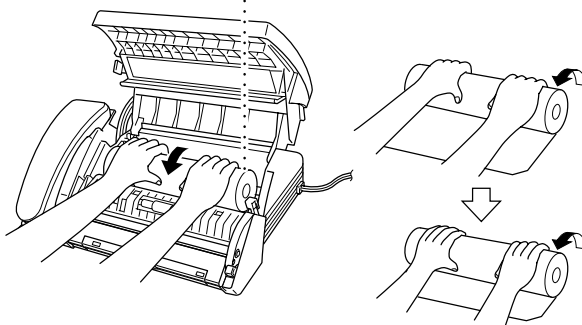

- 5** Pull up the tab on the left side of the print head unit to open the print head cover.

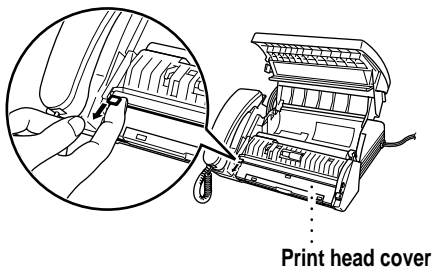

- 6** Remove the jammed paper if there is any left.

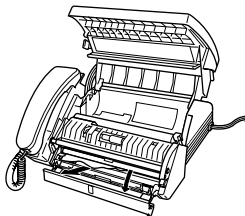

- 7** Press down on the middle of the print head cover to close it.

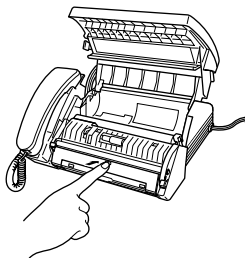

- 8** Use scissors to cut off the wrinkled portion of the paper.  
**9** Load the fax paper again, and push the blue release lever down. Close the cover.  
**10** Plug in the power cord.

DISCONNECTED

The other party has disconnected during a call or fax. Try calling the other party.

CHECK DOCUMENT

REMOVE DOCUMENT

CHECK DOCUMENT

PRESS STOP KEY

The documents were not inserted or fed properly, or were too long or too short.

- 1 Open the cover.
- 2 Pull the documents toward the front of the fax machine, in the same direction they were feeding.
- 3 Close the cover.

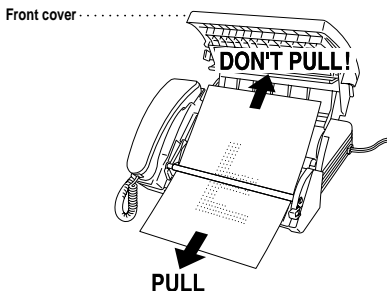

CALL BROTHER CS  
MACHINE ERROR XX

Contact your Brother Dealer for service,

NO RESPONSE/BUSY

The number you called does not answer or is busy. You may also have reached a number not connected to a fax. Check the number and call again.

NOT ASSIGNED

You've tried accessing a One Touch or Speed Dial location with no number assigned to it. See chapter 7 for information about storing One Touch and Speed Dial numbers.

PAPER ROLL EMPTY  
RELOAD PAPER

The paper roll is empty; follow the instructions in Installation to replace the paper roll.

COOLING DOWN  
WAIT FOR A WHILE

The recording head has overheated. Unplug the machine and wait 30 minutes for it to cool.

SCANNER ERROR

Try cleaning the white bar and the glass under the bar with isopropyl alcohol.

If you still get a scanner error, contact Brother Dealer for service.

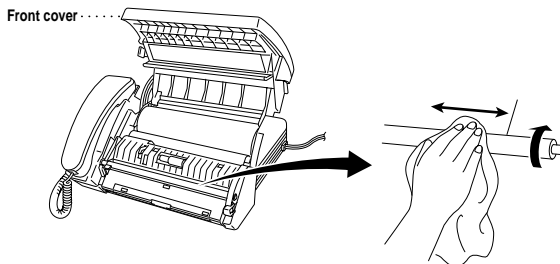

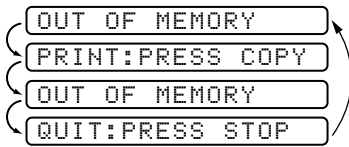

The memory capacity has been exceeded while you are copying. (See *Making Copies*, page 10-1.) Erase the incoming voice messages or fax messages stored in memory in order to make additional memory available. (See *Erasing Messages*, page 9-4.)

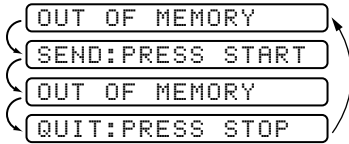

The memory capacity has been exceeded while you are sending a fax. (See *Memory Transmission (For FAX-335MC Only)*, page 6-2.) Erase the incoming voice messages or fax messages stored in memory in order to make additional memory available. (See *Erasing Messages*, page 9-4.)

## Recording Paper Jam

If something was placed in front of your fax machine, during printing the recording paper may become jammed. To roll out the jammed paper, follow the instructions for CUTTER JAM, see page 13-1.

## If You Are Having Difficulty with Your Fax Machine

If you think there is a problem with your fax machine, make a copy first. If the copy looks good, the problem is probably not your fax machine. Check the difficulties below and follow the troubleshooting tips.

### Printing or Receiving Faxes

#### Condensed Print and Horizontal Streaks;

#### Top and Bottom of Sentences Cut Off

If your copy looks good, you probably had a bad connection, with static or interference on the phone line.

#### Enabling/Disabling Anti-Curl Check Sheet (ACS)

#### (For Some Countries)

Although the factory setting of Anti-Curl Check Sheet feature is OFF, you can check the status of your fax machine's Anti-Curl (ACS) feature by printing an Anti-Curl Check Sheet.

Press One touch key **1** and **4** at the same time to print an ACS Check Sheet.

Press One touch key **1** and **4** at the same time to discontinue printing ACS Check Sheet.

#### Vertical Black Lines When Receiving

The sender's scanner may be dirty. Ask the sender to make a copy to see if the problem is with the sending machine. Try receiving from another fax machine.

## Phone Line or Connections

### Fax Machine Does Not Answer When Called

Make sure the fax machine is in the correct receiving mode for your setup (either FAX, FAX/TEL or MSG CTR). Check for dial tone. If possible, call your fax machine to hear it answer. If there is still no answer, check the telephone line cord connection. Connect a standard telephone handset to the fax machine telephone jack. If there is no ringing when you call your fax machine, call your Telephone Company to check the line.

### No Dial Tone on the Handset

Press **Hook** or **Speaker Phone**—**OR**—Lift the handset. If you hear no dial tone, check telephone line cord connections at the fax machine and wall jack. Check that the handset is connected to the fax machine's handset jack. Test the wall jack with another single line telephone. If no dial tone on the wall outlet, call your Telephone Company.

## Sending Faxes

### Poor Transmitting Quality

Try changing your resolution to FINE or SUPERFINE (see *Resolution*, page 6-6). Try cleaning the white pressure bar of the scanner and the glass under the bar (see page 13-1).

### Dialing Does Not Work

Check for a dial tone.

Change TONE/PULSE setting (see *Setting Dialing Mode (Tone/Pulse)*, page 4-1).

Check all line cord connections, and make sure the curled handset cord is not in the **EXT** jack.

Check power cord connection.

Send a manual fax by pressing **Hook** or **Speaker Phone** —**OR**— Lifting the handset, and dialing the number. Wait to hear fax receiving tones before pressing **Start**.

### Vertical Black Lines When Sending

Use your fax machine to make a copy. If the copy shows the same problem, the scanner area is dirty. Lift the front cover and check the document path. Clean the scanner's white pressure bar and the glass under the bar using isopropyl alcohol and a lint-free cloth (see page 13-1).

## Handling Incoming Calls

### **F/T pseudo-ring in FAX/TEL Mode**

The fax machine knows the incoming call is not a fax so it is signaling you to answer the telephone call. Pick up the fax machine handset or answer from an extension phone and press your fax machine's Telephone Answer Code (default setting is #51). (See *For FAX/TEL Mode Only*, page 5-6.)

### **Transferring a Call to the Fax Machine**

If you have answered the fax machine handset, press **Start**, and hang up immediately.

If you answered at an extension phone, press your three-digit Fax Receive Code (the factory setting is ✕ 51). When your fax machine answers, hang up.

### **Fax Machine "Hears" Voice as CNG Tone**

If your fax machine is set to Easy Receive ON, and it answers voice calls by trying to receive a fax, try turning Easy Receive to OFF.

### **Transmission Verification Report Prints "Result: NG"**

There is probably temporary noise or static on the phone line. Try sending the fax again. If the problem continues, call the Telephone Company to check your phone line.

### **Custom Features on a Single Line**

If you have Call Waiting, Caller ID, Ring Master, Voice Mail, an answering machine, alarm system or any other custom feature on a single phone line with your fax machine, it may create a problem with sending or receiving fax data and telephone calls.

# Specifications

<b>Type</b>	Desktop facsimile transceiver
<b>Compatibility</b>	ITU-T Group 3
<b>Coding System</b>	Modified Huffman (MH)
<b>Modem Speed</b>	9600/7200/4800/2400; Automatic Fallback (FAX-235, FAX-236) 14400/12000/9600/7200/4800/2400; Automatic Fallback (FAX-335MC)
<b>Original Input Width</b>	5.8 inches to 8.5 inches (148 mm to 216 mm)
<b>Scanning/Printing Width</b>	8.2 inches (208 mm)
<b>Paper Roll Size: Width</b>	8.5 inches (216 mm)
<b>Length</b>	164 feet (50 m) with standard thermal paper 98 feet (30 m) with Therma PLUS paper
<b>Diameter</b>	Limited to 2.76 inches (70 mm)
<b>Printer type</b>	Line Thermal
<b>Gray Scale</b>	64 levels (Dithered)
<b>Display</b>	LCD, 16 characters
<b>Polling Types</b>	Standard, Sequential (For FAX-335MC Only), Delayed, Secure
<b>Contrast Control</b>	Automatic/Light/Dark (manual setting)
<b>Resolution</b>	<ul style="list-style-type: none"><li>• Horizontal 203 dot/inch (8 dot/mm)</li><li>• Vertical Standard—98 line/inch (3.85 line/mm) Fine, Photo—196 line/inch (7.7 line/mm) Superfine, Photo (copy)—392 line/inch (15.4 line/mm)</li></ul>
<b>Memory Capacity</b>	512 KB (up to 20 pages*) (For FAX-335MC Only)
<b>One Touch Dial</b>	4
<b>Speed Dial</b>	60 stations (FAX-235) 100 stations (FAX-236) 100 stations (FAX-335MC)
<b>Automatic Redial</b>	3 times at 5 minute intervals
<b>Speaker Type</b>	Monitor (FAX-235, FAX-236) Full Duplex, Digital (FAX-335MC)
<b>Auto Answer</b>	0, 1, 2, 3, 4, 5, 6, 7, 8, 9, 10 rings (Singapore, Malaysia, Hong Kong, India) 0, 1, 2, 3 or 4 rings (in some countries)

\* “Pages” refers to the ITU-T Test Chart #1 (in Out of Paper Reception in ECM mode). Specifications are subject to change without prior notice.

<b>Communication Source</b>	Public switched telephone network
<b>Operating Environment</b>	41 - 95° F (5° - 35°C)
<b>Power Source</b>	220~240V AC 50/60Hz
<b>Power Consumption</b>	Standby: under 3.5 watts — Peak: under 110 watts
<b>Dimensions</b>	11.8 x 9.4 x 5.4 (inches)/ 299 x 240 x 137 (mm)
<b>Weight</b>	6.4 lb / 2.9 kg



# Glossary

- ADF (Automatic Document Feeder)** Refers to the number of pages that can be placed in the original feeder and fed one at a time automatically.
- automatic fax transmission** Sending a fax without picking up the handset or pressing Hook or Speaker Phone.
- beeper** The sound the keys make when they are pressed, an error occurs or an original has been received or transmitted.
- Broadcasting** The ability to send the same fax message to more than one location.
- Call Back Message** Allows you to send a fax and then leave a message for the other party to call you back.
- Call Reservation** Allows you send a fax and then at the end of transmission, you can talk with the other party.
- Cancel Job** Cancels a programmed job, like Delayed Fax or Polling.
- CNG tones** The special tones (beeps) sent by fax machines during automatic transmission to tell the receiving machine that they are a from fax machine.
- communication error (or Comm. Error)** An error during fax sending or receiving, usually caused by line noise or static.
- Contrast** Setting to compensate for dark or light originals, by lightening dark originals or darkening light originals.
- Cover Page** Prints a page at the other party's machine, that contains the sender and recipient's name and fax number, number of pages and comment. You can generate an electronic cover page at the other end with pre-programmed information from memory or you can print a sample cover page to fax with your original.
- Distinctive Ring** A service purchased from the Telephone Company that provides another phone number on an existing phone line. The Brother fax machine uses the new number to simulate a dedicated fax line.
- ECM (Error Correction Mode)** Detects errors during fax transmission and resends the page(s) of the original that had an error.
- F/T Ring Time** The length of time the fax machine rings (when the answer mode setting is FAX/TEL) to notify you to pick up a voice call that it answered.
- Fax Forwarding** Sends a fax received in memory to another preprogrammed fax number.
- fax tones** The signals sent by sending and receiving fax machines while communicating information.
- Fine Mode** Resolution is 196 x 203 dpi. It is used for small print and graphs.
- gray scale** The shades of gray available for copying and faxing photographs.
- group number** A combination of One Touch and/or Speed Dial numbers that are stored on a One Touch key for Broadcasting.
- Interrupt** Temporarily puts a waiting job on hold while you perform another operation.

**interval** The preprogrammed time period between automatically printed Activity Reports. You can print Activity Reports on demand without interrupting this cycle.

**Journal** Lists information about the last 15 (FAX-235, FAX-236) or 30 (FAX-335MC) incoming and outgoing faxes. TX means Transmit. RX means Receive.

**LCD (liquid crystal display)** The display screen on the fax machine that shows interactive messages during On-Screen Programming and defaults to the date and time when the machine is idle.

**manual fax** When you press **Hook** or **Speaker phone**—**OR**—lift the handset so you can hear the receiving fax machine answer before you press Start to begin transmission.

**Memory Status List** Shows how much memory is being used, how much is left, and the type of messages in memory.

**Memory Transmission** You can set your machine to scan originals before dialing, so you do not have to leave them at the fax machine.

**memory usage** Instructs the fax machine how to allocate the memory.

**Next Fax Reservation** Accepts the next original in the original feeder for transmission while the fax machine is still receiving.

**OGM (Out-Going Message)** The message callers hear when you call your external answering machine.

**One Touch** Keys on the fax machine control panel where you can store numbers for easy dialing. You must use a separate key for each number.

**Out of Paper Reception** Receives faxes into the fax machine's memory when the machine is out of paper.

**Overseas Mode** Makes temporary changes to the fax tones to accommodate noise and static on overseas phone lines.

**Paging** Feature enables your fax unit to call your pager when a fax and/or a voice message is received into its memory.

**Pause** Allows you to place a 3.5 second delay in the dialing sequence stored on One Touch and Speed Dial numbers.

**Photo Mode** A resolution setting that uses varying shades of gray for the best representation of photographs.

**polling** The process of a fax machine calling another fax machine to retrieve waiting fax messages.

**Pulse** A form of dialing on a telephone line.

**QUICK-Dial List** A listing of names and numbers stored in One Touch and Speed Dial memory, in numerical order.

**remote access** The ability to access your fax machine remotely from a touch tone phone.

**remote activation** allows you to transfer a fax call, answered at an extension phone, to the fax machine.

**remote access code** The four-digit code that allows you to call and access your fax machine from a remote location.

**resolution** The number of vertical and horizontal lines per inch. See: Standard, Super Fine and Photo.

**Rotary** A form of dialing on a telephone line.

**scanning** The process of sending an electronic image of a paper document into your computer.

**Search** An electronic, alphabetical listing of stored One Touch, Speed Dial and Group numbers.

**Speed dial** A preprogrammed number for easy dialing. You must press the Search/Speed Dial key, press **#**, and then the two digit code to start the dialing process.

**Standard resolution** 98 x 203 dpi. It is used for regular size text and quickest transmission.

**Station ID** The stored information that appears on the top of faxed pages. It includes the sender's name and fax number.

**super fine resolution** 392 x 203 dpi. Best for very small print and line art.

**SYSTEM SETUP List** A printed report that shows the current settings of your fax machine.

**Timer** Sends your fax at a later time that day.

**Tone** A form of dialing on the telephone line used for Touch Tone telephones.

**transmission** The process of sending originals over the phone lines from your fax machine to the receiving fax machine.

**Transmission Verification Report** A listing of each transmission, showing caller ID, date, time, and number of pages.

# Index

## A

Alternating Displays .....3-1  
Answer Mode ..... 5-1, 5-2  
Answering Machine .....2-7  
Automatic Transmission .....6-2

## B

Backup Printing .....9-4  
Beeper Volume .....4-4  
Beeps .....9-8  
Broadcasting .....7-6  
Broadcasting (Set Up Groups) .....7-3

## C

CALL PICKUP .....8-2  
Caller ID .....8-2  
Caller ID (Printing Log) .....8-3  
Caller ID (Viewing Log) .....8-3  
Canceling Job .....6-10  
Chain Dialing .....7-2  
Connect (External Telephone Answering Machine) .....2-7  
Connect (External Telephone) .....2-8  
Connect (Telephone Line) .....2-4  
Contrast .....6-6  
Control Panel ..... 1-3, 1-4  
Copy (Enlarging) .....10-1  
Copy (Multiple) .....10-1  
Copy (Reducing) .....10-1  
Copy (Sorted) .....10-1  
Copy (Stacked) .....10-1  
Corrections (Entering Text) .....4-3

## D

Date and Time .....4-1  
Dialing Mode .....4-1

Dialing Options ..... 7-4  
Distinctive Ring ..... 8-1  
Documents (Size) ..... 6-1

## E

ECM (Error Correction Mode) ..... 1-2  
Entering Text ..... 4-2  
Erasing Messages .....9-4, 9-5  
External Telephone ..... 2-8  
External Telephone Answering Device 2-7

## F

F/T (FAX/TEL) Mode ..... 5-1  
F/T Ring Time ..... 5-4  
Fax Detect ..... 5-5  
Fax Forwarding ..... 9-6  
FAX ONLY Mode ..... 5-1  
Fax Receive Code ..... 5-6  
Fax Tones and Handshake ..... 1-2  
Fine (Resolution) ..... 6-6  
Flexible Memory Settings ..... 9-1  
Function Mode ..... 3-1  
Function Selection Table ..... 3-2

## G

Gray Scale ..... S-1

## H

Help ..... 1-1  
Hold ..... 1-3, 1-4, 7-7

## I

ICM Recording Monitor ..... 9-6  
Inserting Spaces ..... 4-2  
International Calls ..... 6-7  
Interrupting ..... 6-11

<b>J</b>	
JOURNAL .....	11-2

<b>M</b>	
Manual Dialing .....	7-4
MANUAL Mode .....	5-1
Manual Transmission .....	6-2
Maximum Message Time .....	9-5
MEMORY STATUS REPORT .....	11-1
Memory Storage .....	4-4
Memory Transmission .....	6-2
Message Center .....	9-1
Message Center Mode .....	9-1
Message Indicator .....	9-3
Message Storage .....	9-1
Multi-Line Connections .....	2-6

<b>O</b>	
One Touch Dial (Changing) .....	7-3
One Touch Dial (Storing) .....	7-1
One Touch Dialing .....	7-5
On-Screen Programming .....	3-1
Outgoing Message .....	9-2, 9-3, 9-7
Outgoing Message (OGM) .....	2-8
Overseas Mode .....	6-7

<b>P</b>	
Paging .....	9-6
Pause .....	7-7
PBX .....	2-6
Photo (Resolution) .....	6-6
Playing Messages .....	9-4
Polled Transmit .....	6-10
Polling (Receive) .....	5-7
Power Consumption .....	S-2
Print (Caller ID Log) .....	8-3
Print (Report) .....	11-1
Pulse .....	4-1

<b>Q</b>	
QUICK-DIAL REPORT .....	11-1

<b>R</b>	
Recording a Conversation .....	9-6
Redial (Automatic) .....	6-2
Redial (Manual) .....	6-2
Remote Commands .....	9-9
Remote Retrieval .....	9-8
Remote Retrieval Access Code .....	9-8
Resolution .....	6-6
Ring Delay .....	5-3
Ring Volume .....	4-4

<b>S</b>	
Safety Instructions .....	12-1
Scroll .....	3-1
Search .....	7-6
Speaker Volume .....	4-4
Special characters .....	4-3
Speed Dial (Changing) .....	7-3
Speed Dial (Storing) .....	7-2
Speed Dialing .....	7-5
Standard (Resolution) .....	6-6
Station ID .....	4-2
Storing Telephone Numbers .....	7-1
Super Fine (Resolution) .....	6-6
SYSTEM SETUP REPORT .....	11-1

<b>T</b>	
TAD .....	2-7
Telephone Answer Code .....	5-6
Telephone Numbers .....	7-1
Timer .....	6-8
Toll Saver .....	9-5
Tone (Send Signals) .....	7-7
TRANSMISSION VERIFICATION REPORT .....	11-2

Troubleshooting .....13-1

**V**

Verification Report .....11-1

**W**

WARNING ..... 12-1, 12-2

# Using Remote Retrieval Access Code (For FAX-335MC Only)

If you plan to retrieve voice or fax messages while away from your fax machine, carrying the Remote Retrieval Access Card printed below will serve as a convenient reminder of the retrieval procedures. Simply cut out the card and fold it to fit in your wallet or organizer. Keeping it handy will help you derive the full benefit of your fax machine's forwarding, paging, and remote retrieval features.

<p><b>Changing Remote Retrieval Access Code</b></p> <ol style="list-style-type: none"><li>1 Press <b>[Forward]</b>, <b>[3]</b>, <b>[7]</b>.</li><li>2 Enter a three-digit number from 000 to 999. The * cannot be changed.</li><li>3 Press <b>[Forward]</b>.</li><li>4 Press <b>[Exit]</b> to exit.</li></ol> <p><b>Remote Commands</b></p> <p><b>Listen to Voice Messages</b></p> <p>Press <b>[3]</b>, <b>[1]</b>.</p> <p><i>then to</i> Repeat a message press <b>[1]</b>.</p> <p>Skip to next message press <b>[2]</b>.</p> <p>Stop playing the message press <b>[3]</b>.</p>	<p><b>Erase All Messages</b></p> <p>Press <b>[3]</b>, <b>[3]</b>. If you hear three beeps, all messages have not yet been played, and the system will not erase.</p> <p><b>Play/Record Outgoing Message</b></p> <p>Press <b>[3]</b>, <b>[4]</b>.</p> <p><i>then to</i> Play Message Center OGM, press <b>[1]</b>, <b>[1]</b>.</p> <p>Play F/T OGM press <b>[1]</b>, <b>[2]</b>.</p> <p><b>Record new Message Center OGM</b>, press <b>[2]</b>, <b>[1]</b>, then speak after beep. Press <b>[3]</b> to stop.</p> <p><b>Record new F/T OGM</b>, press <b>[2]</b>, <b>[2]</b>, then speak after beep. Press <b>[3]</b> to stop.</p>	<p><b>Change Paging/Fax Forwarding Setting</b></p> <p>Press <b>[3]</b>, <b>[3]</b>.</p> <p><i>then to</i> Turn feature off press <b>[1]</b>.</p> <p>Enter Fax Forwarding Number press <b>[2]</b>.</p> <p><b>Enter Paging Number</b> press <b>[3]</b>.</p> <p><b>Program Fax Forward Number</b> press <b>[2]</b>. Enter the new number of the remote fax machine where you want your fax messages forwarded and then press <b>[3]</b>, <b>[3]</b>. After two short beeps, press <b>[2]</b>, <b>[3]</b>, <b>[1]</b>. To retrieve a Memory Status List, enter the number of the remote fax machine, and press <b>[3]</b>, <b>[3]</b>.</p> <p><b>Retrieve a Fax</b></p> <p>Press <b>[3]</b>, <b>[3]</b>.</p> <p><i>then to</i> <b>Print a Memory Status List</b> press <b>[1]</b>, enter the number of remote fax machine, and then <b>[3]</b>, <b>[3]</b>. After the beep, hang up and wait.</p>
--	--	---

**MESSAGE CENTER  
REMOTE RETRIEVAL ACCESS CARD**

**Using Remote Access Code**

- 1** Dial your fax number from a fax machine using touch tone.
- 2** When your fax machine answers and beeps, immediately enter your Remote Retrieval Access Code (159 \*).
- 3** Your fax machine signals the kinds of messages received:
  - 1 long beep — Fax message(s)**
  - 2 long beeps — Voice message(s)**
  - 3 long beeps — Fax and Voice**
  - No beeps — No messages**
- 4** After 2 short beeps, enter a command.
- 5** Press **[2][0]** to reset the machine when you finish.
- 6** Hang up.

**Exit Remote Operation**

Press **[3][0]**.

**Check Receiving Status**

Press **[3][7]**.

*then for* Fax message, press **[1]**.  
Voice message, press **[2]**.

- 1** long beep — Received message
- 3** short beeps — No messages

**Change Answer Mode**

Press **[3][8]**.

*then for* Message Center, press **[1]**.  
Fax/Telephone (F/T), press **[2]**.  
Fax Only, press **[3]**.



**brother**<sup>®</sup>



LF8878040  
AS.GU  
Printed in Malaysia

## Free Manuals Download Website

<http://myh66.com>

<http://usermanuals.us>

<http://www.somanuals.com>

<http://www.4manuals.cc>

<http://www.manual-lib.com>

<http://www.404manual.com>

<http://www.luxmanual.com>

<http://aubethermostatmanual.com>

Golf course search by state

<http://golfingnear.com>

Email search by domain

<http://emailbydomain.com>

Auto manuals search

<http://auto.somanuals.com>

TV manuals search

<http://tv.somanuals.com>