

# GT-541

## INSTRUCTION MANUAL

---

Please read this manual before using the printer.  
Please keep this manual within easy reach for quick reference.

---

### GARMENT PRINTER

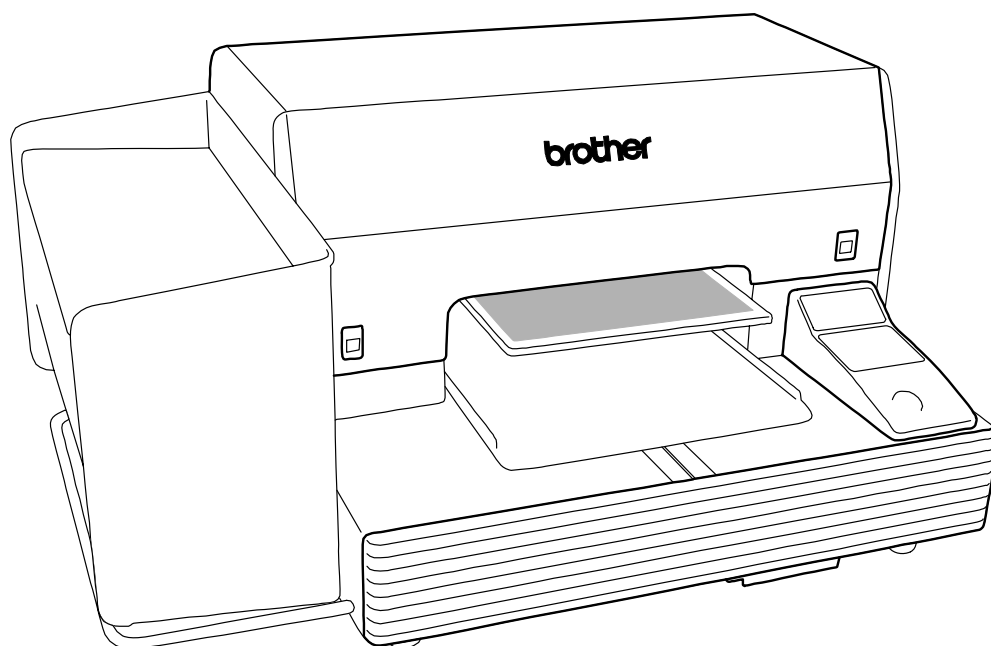

---

**brother**<sup>®</sup>

GT-541 support homepage <http://www.brother.com/usa/garmentprinters/>



Thank you very much for buying a BROTHER printer. Before using your new printer, please read the safety instructions below and the explanations given in the instruction manual.

# SAFETY INSTRUCTIONS

## [1] Safety indications and their meanings

This instruction manual and the indications and symbols that are used on the printer itself are provided in order to ensure safe operation of this printer and to prevent accidents and injury to yourself or other people. The meanings of these indications and symbols are given below.

### Indications

	<b>DANGER</b>	The instructions which follow this term indicate situations where failure to follow the instructions may result in death or serious injury.
	<b>WARNING</b>	The instructions which follow this term indicate situations where failure to follow the instructions can result in severe injury or death.
	<b>CAUTION</b>	The instructions which follow this term indicate situations where failure to follow the instructions could cause injury when using the machine or physical damage to equipment and surroundings.

### Symbols



..... This symbol (  ) indicates something that you should be careful of. The picture inside the triangle indicates the nature of the caution that must be taken.  
(For example, the symbol at left means “beware of injury”.)









..... This symbol (  ) indicates something that you must not do.



..... This symbol (  ) indicates something that you must do. The picture inside the circle indicates the nature of the thing that must be done.  
(For example, the symbol at left means “you must make the ground connection”.)

## [2] Notes on safety

 <b>DANGER</b>	
	Wait at least 5 minutes after turning off the power switch and disconnecting the power cord from the wall outlet before opening the cover of the control unit. Touching areas where high voltages are present can result in severe injury.

 <b>WARNING</b>	
<b>Basic precautions</b>	
	Do not disassemble or modify the printer, otherwise it may cause fire or electric shocks or problems with correct operation.
	Ask the place of purchase or a qualified technician to carry out any internal inspections, adjustments or repairs that may be required. (Any problems with correct operation that occur as a result of the customer attempting to disassemble or modify the printer will not be covered by the warranty.)
	Do not handle the power cord with wet hands, otherwise it may cause electric shocks.

## **WARNING**

### **Installation**



Do not set up the printer in places where there is a lot of dust. If dust collects inside the printer, it may cause fire or electric shocks or problems with correct operation.



When securing the cords, do not bend the cords excessively or fasten them too hard with staples or anything similar, otherwise there is the danger that fire or electric shocks could occur.



Be sure to connect the ground. If the ground connection is not secure, you run a high risk of receiving a serious electric shock, and problems with correct operation may also occur.

### **Printing**



If a foreign object gets inside the printer, immediately turn off the power switch and disconnect the power cord, and contact the place of purchase or a qualified technician.



If you continue to use the printer while there is a foreign object inside, it may result in fire or electric shocks or problems with correct operation.



Do not allow water or oil to get onto the printer, otherwise it may cause fire or electric shocks or problems with correct operation.



If any liquids get onto the printer, immediately turn off the power switch and disconnect the power cord, and contact the place of purchase or a qualified technician.



Do not use the printer if a problem is noticed such as smoke or a bad odor coming from the printer, otherwise it may cause fire or electric shocks or problems with correct operation.



Immediately turn off the power switch and disconnect the power cord, and contact the place of purchase or a qualified technician.

(The printer must never be repaired by the customer, as it can be extremely dangerous to do so.)

### **Maintenance**



Do not put your hands in the ink cartridge slot, otherwise the needle inside the slot may cause injury.

## **CAUTION**

### **Environmental requirements**



Use the printer in an area which is free from sources of strong electrical noise such as electrical line noise or static electric noise.

Sources of strong electrical noise may cause problems with correct operation.



Any fluctuations in the power supply voltage should be within  $\pm 10\%$  of the rated voltage for the printer.

Voltage fluctuations which are greater than this may cause problems with correct operation.



The power supply capacity should be greater than the requirements for the printers power consumption.

Insufficient power supply capacity may cause problems with correct operation.



The ambient temperature should be within the range of 15°C to 30°C during use.

Temperatures which are lower or higher than this may cause problems with correct operation.



The relative humidity should be within the range of 20% to 85% during use, and no dew formation should occur in any devices.

Excessively dry or humid environments and dew formation may cause problems with correct operation.



Use the printer in a place which is adequately ventilated.

A slight odor is generated when the printed articles are being fixed by heat.









In the event of an electrical storm, turn off the power and disconnect the power cord from the wall outlet.







Lightning may cause problems with correct operation.

## CAUTION







### Installation

-  Setting up and moving of the printer should only be carried out by a qualified technician.
-  The printer machine weighs approximately 100 kg. Transporting and setting up of the printer should be carried out by four or more people.
-  Furthermore, do not hold the printer by the ink cartridge housing when transporting it, otherwise the ink cartridge housing may become damaged and the printer may fall down and cause personal injury or damage to the printer.
-  Do not place the printer on unstable surfaces such as unsteady tables or high shelves, otherwise it may tip over or fall down and cause injury. Furthermore, the table that supports the printer should be at least 100 cm in width and 80 cm in depth, and should be able to bear a weight of 150 kg or more.
-  Do not set up the printer in a place where it will be affected by vibration from other equipment, otherwise it may become unbalanced and fall down and cause injury or damage to the printer.
-  Do not connect the power cord until setup is complete, otherwise the printer may operate if the power switch is turned on by mistake, which could result in injury.
-  Do not climb onto the printer or place heavy objects on top of it, otherwise it may become unbalanced and tip over or fall down and cause injury.

### Printing

-  This printer should only be used by operators who have received the necessary training in safe use beforehand.
-  Leave sufficient space at the front of the printer, and avoid placing items in front of it, otherwise the platen may hit them and be damaged, and if your hands get caught between the platen and the object, injury may result.
-  Release your hand from the platen while the printer is operating. If your hand gets caught between the platen or the T-shirt tray and the covers, injury may result.
-  Do not push nor pull the platen by hands quickly. It must be a cause of operation troubles or failures of printed circuit boards.
-  Do not put your hands inside the covers while the printer's power is turned on, otherwise your hands may touch against moving parts and this may result in injury.
-  If a problem occurs with the operation of the printer, contact the place of purchase or a qualified technician.

### Maintenance

-  Wait at least 1 minute after turning off the power switch before opening the front cover. Touching the heat sink on the head can result in burns.
-  Be careful not to get your fingers caught when closing the front cover, otherwise it may result in injury to your fingers.
-  Do not push nor pull the platen by hands quickly. It must be a cause of operation troubles or failures of printed circuit boards.
-  Do not disassemble the ink cartridge or the waste ink cartridge. If the ink cartridge or waste ink cartridge is disassembled, it can no longer be used.
-  Take care not to let the ink, waste liquid or wash liquid come into contact with your eyes or onto your skin, otherwise inflammation can result. Furthermore, do not drink the ink, waste liquid or wash liquid under any circumstances, as they can cause vomiting and diarrhoea. Keep the ink, waste liquid and wash liquid out of the reach of children.
-  Use only the proper replacement parts as specified by Brother.

### [3] Warning labels

The following warning labels appear on the printer.

Please follow the instructions on the labels at all times when using the printer. If the labels have been removed or are difficult to read, please contact your nearest Brother dealer.

**1**

	<b>▲ 危険 ▲ 危険</b> 高電圧部分にふれて、大けがをすることがある。電源を切り、5分たつてからカバーを開けずこと。 ▲ DANGER ▲ GEFAHR ▲ DANGER ▲ PELIGRO Hazardous voltage will cause injury. Turn off main switch and wait 5 minutes before opening this cover.	▲ 危険 触媒高電圧部分、会导致受伤。在切断电源5分钟后、再开启盖罩。 Un voltage non adapte provoque des blessures. Eteindre l'interrupteur et attendre 5 minutes avant d'ouvrir le capot. Un voltaje inadecuado puede provocar las heridas. Apagar el interruptor principal y esperar 5 minutos antes de abrir esta cubierta.
--	--	---

**2**

	<b>▲ WARNING</b> Needle inside can cause injury. Do not put hands in ink cartridge slot.	<b>▲ AVISO</b> La aguja dentro puede causar herida. No meta la mano en la ranura de cartucho de tinta.
--	---	---

**3**

Do not put your hands in the ink cartridge slot, otherwise the needle inside the slot may cause injury.

**4**

	<b>▲ CAUTION</b> Do not push nor pull the platen by hands quickly. It must be a cause of operation troubles or failures of printed circuit boards. <b>▲ ATENCION</b> No empuje y no tire LA PLACA con la mano rápidamente. Será la causa de la avería del fundamento y defecto de movimiento.
--	--

**5**

	<b>▲ CAUTION</b> Opening front cover turns off power and cancels printing. Do not open front cover while printing. Putting fingers in front cover can result in injury. Carefully close front cover. <b>▲ ATENCION</b> Al abrir la cubierta del frente, el poder se corta y anula la imprenta. No abra la cubierta del frente estando en imprenta. La puesta de dedos al frente de la cubierta puede resultar en herida. Con cuidado cierre la cubierta del frente.
--	--

**6**

	<b>▲ CAUTION</b> Keep hands off platen while printing. Moving platen, T-shirt tray and covers can cause bodily injury. Moving carriage and belt can cause injury. Do not put hands in covers while power is on. <b>▲ ATENCION</b> Moviendo al plato, la bandeja de camiseta y las tapas pueden aplastar y corta su mano. No toque el plato mientras imprimiendo. El movimiento de la canesta y cinturón puede causar herida. No ponga manos en tapas mientras el poder es conectado.
--	---

**7**

<b>▲ CAUTION</b> Observe the following instructions, otherwise this printer may fall and cause personal injury or damage to this printer may result. Move and install this printer as instructed in the instruction manual. This printer should be carried by four or more people. (Weight: Approx. 100 kg) Do not hold the ink cartridge housing when carrying. Hold the bar below the ink cartridge housing. Place this printer on a table that can withstand load of 150 kg or more. Place this printer on a table of 100 cm (W) and 80 cm (D) or more. <b>▲ ATENCION</b> Observe instrucciones siguiente, por otra parte esta impresora puede caerse y herida personal o daño a esta impresora puede resultar. Mueva e instala esta impresora como instruido en el manual de instrucciones. Esta impresora debería ser llevada por cuatro o más personas. (Peso aproximadamente 100 kilogramos) No sostenga el alojamiento de cartucho de tinta al llevar. Sostenga la barra debajo del cartucho de tinta alojamiento. Coloque esta impresora sobre una mesa con soporte de carga hasta 150 kilogramos o más. Coloque esta impresora sobre una mesa de 100 cm (w) y 80 cm (D) o más.
---

**8**

High temperature warning display

**9**

<b>▲ CAUTION</b> Waste liquid can cause inflammation. Avoid contact with eyes and skin. Waste liquid can cause vomiting and diarrhea. Do not drink. Keep waste ink cartridge out of reach of children. <b>▲ ATENCION</b> El líquido de desecho puede causar inflamación. Evitan el contacto con ojos y piel. El líquido de desecho puede causar vómito y diarrea. No beber. Guarde la caja de desecho fuera de alcance de niños.
 Check Comprobar
Insert and dispose the waste ink cartridge as instructed in the instruction manual. Asegurarse de seguir el manual de instrucciones.

**10**

<b>▲ CAUTION</b> Ink can cause inflammation. Avoid contact with eyes and skin. Ink can cause vomiting and diarrhea. Do not drink. Keep ink cartridge out of reach of children. Unpack the ink cartridge just before use. Use before expiration date. Ink can stain hands or clothes. Do not refill the ink cartridge. Do not disassemble the ink cartridge. Dispose it as waste material in accordance with regulations in your area.	<b>▲ ATENCION</b> Tinta puede causar inflamación. Evite contacto con los ojos o la piel. Puede causar diarrea y vómito. No beber la tinta. Guarde el cartucho de tinta fuera de alcance de niños. Desempaquetar el cartucho de la tinta justo antes del uso. Use antes de fecha de expiración. Tinta puede causar manchas en las manos o la ropa. No rellene el cartucho de tinta. No haga disasemblo el cartucho de tinta. Dispongalo como el material de desecho de acuerdo con regulaciones en su área.
Use before Use antes de	
GC-50Y	

**11**

<b>▲ CAUTION</b> Wash liquid can cause vomiting and diarrhea. Do not drink.	<b>▲ ATENCION</b> El líquido de lavar puede causar vómitos y diarrea. No beber el líquido de lavar.
--	--

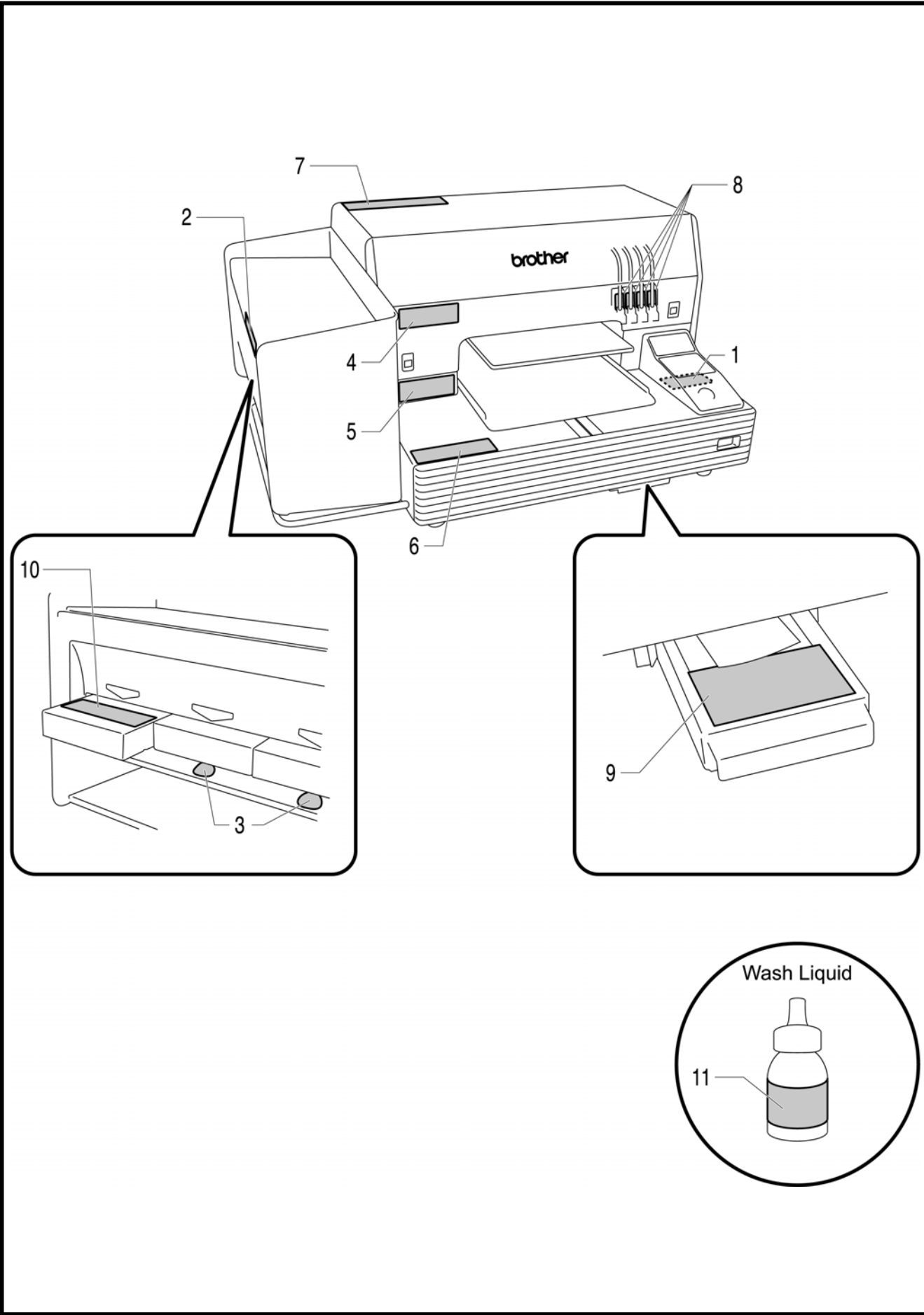

## Table of Contents

1. Read This First.....	1
1-1. Precautions.....	1
1-2. Unpacking Your Printer.....	3
1-3. Required Condition.....	4
1-3-1. Environment.....	4
1-3-2. Electrical Requirements.....	4
1-3-3. Software Information.....	4
1-3-4. Other Requirements.....	5
1-3-5. Consumable Requirements.....	5
2. Identifying Your Printer's Parts.....	6
2-1. Front.....	6
2-2. Left.....	7
2-3. Right.....	7
2-4. Rear.....	8
2-5. Inside of the Front Cover.....	9
2-6. Under the Platen.....	10
2-7. Control Panel.....	11
2-7-1. Indication Lamps.....	12
2-7-2. Display.....	13
3. Getting Started.....	14
3-1. Placing Your Printer.....	15
3-2. Turning On/Off Your Printer.....	16
3-2-1. Turning On Your Printer.....	16
3-2-2. Turning Off Your Printer.....	16
3-3. Preparing Your PC.....	17
3-3-1. For Windows XP Users.....	17
3-3-2. For Windows 2000 Users.....	25
3-3-3. Installing the Useful Tools.....	31
3-4. Setting Up Your Printer.....	32
3-4-1. Adjusting the Display Contrast.....	32
3-4-2. Adjusting the Speaker Volume.....	33
4. Printing Directly from Applications.....	34
4-1. Basic Printing Procedure.....	35
4-2. Setting the Applications' Print Condition.....	36
4-2-1. Setting CorelDRAW 10/11/12 Print Condition.....	36
4-2-2. Setting Adobe Photoshop 6 Print Condition.....	38
4-2-3. Setting Adobe Photoshop 7/ CS Print Condition.....	43
4-2-4. Setting Adobe Illustrator 10 Print Condition.....	48
4-2-5. Setting Adobe Illustrator CS Print Condition.....	52
4-2-6. Setting Adobe Photoshop Elements 3 Print Condition.....	58
4-2-7. Setting Paint Shop Pro 9 Print Condition.....	60
4-2-8. Printing From Other Applications.....	60
4-2-9. Common Notice for All Applications.....	61
4-3. Setting the Printer Driver Condition.....	62
4-3-1. Entering the Job Comment.....	63
4-3-2. Selecting the Platen Size.....	63

4-3-3. Setting the Media Color.....	63
4-3-4. Increasing the Vividness.....	63
4-3-5. Setting Double Printing.....	63
4-3-6. Selecting the Ink Volume.....	64
4-3-7. Setting Yellow / Black Printing.....	65
4-4. Uninstalling / Installing the Platen.....	66
4-4-1. Uninstalling the Platen.....	66
4-4-2. Installing the Platen.....	67
4-5. Placing the T-shirt on the Platen.....	68
4-6. Printing.....	71
4-6-1. Making One Print.....	71
4-6-2. Printing More than One Print Using the Same Print Data.....	72
4-7. Removing the T-shirt From the Platen.....	72
4-8. Setting the Ink onto the T-shirt.....	72
5. Printing ARP Files.....	73
5-1. Making Print Data in ARP Format.....	74
5-2. Reading ARP Files Saved in a Compact Flash.....	76
5-3. Sending ARP Files from GT File Viewer to your Printer.....	77
6. Maintenance.....	79
6-1. Replacing Consumables.....	80
6-1-1. Replacing an Ink Cartridge.....	80
6-1-2. Replacing the Wiper Cleaner.....	81
6-1-3. Replacing the Waste Ink Cartridge.....	86
6-1-4. Replacing the Platen Sheet.....	88
6-1-5. Required Maintenance for the Long Storage.....	89
6-2. Updating Your Printer Driver.....	91
7. Troubleshooting.....	96
7-1. Solving Printer Problems.....	97
7-1-1. How to Check the Error Logs.....	98
7-2. Solving Print Quality Problems.....	100
7-2-1. Procedure for Solving the Print Quality Problems.....	101
7-2-2. Cleaning the Print Heads.....	103
7-2-3. Printing and Checking the Nozzle Check Pattern.....	104
7-2-4. Changing the Print Direction.....	105
7-2-5. Changing the Auto Head Cleaning Setting.....	106
7-2-6. Cleaning the Print Head Nozzle.....	107
7-2-7. Replacing the Print Heads.....	110
7-2-8. Cleaning the Carriage Shafts.....	119
7-2-9. Replacing the Wiper Blade.....	120
7-3. Solving Application Problems.....	126
7-4. Error Messages.....	128
8. Specifications.....	130
8-1. Mechanical Specification.....	130
8-2. Software Specification.....	130



# 1. Read This First

## 1-1. Precautions

Please observe the following precautions before using your printer.

- Please note the following information to buyers of T-shirts printed with your printer:  
A color transfer may happen if a printed side of T-shirt touches to a white or light-colored synthetic leather made with PVC (polyvinyl chloride). If it is happened, clean it by using a household cleaner or alcohol.
- Please meet the following temperature/ humidity requirements.

	Temperature	Humidity
Keeping your printer	32 °F to 104 °F (0 °C to 40 °C)	20 % to 85 % (no condensation)
Operating your printer	50 °F to 95 °F (10 °C to 35 °C)	
For the best print result	59 °F to 86 °F (15 °C to 30 °C)	35 % to 85 % (no condensation)

- Do not uninstall an Ink Cartridge during the operation; it may result in poor print quality or cause damage to your printer.
- Do not turn off your printer, or open the Front Cover during the operation; your printer may be damaged.
- Be careful handling a printed T-shirt that is not heat-treated. If you get ink on your clothing, it is hard to wash off.
- When you replace the Yellow Ink Cartridge, the Wiper Cleaner also needs to be replaced. The Wiper Cleaner replacement includes cleaning of the Print Head Cap and Wiper Blade. If not, it may cause poor print quality or your printer may be damaged.
- When cleaning the Print Head Cap and Wiper Blade, use the Cap Cleaner Kit following the procedure described in “6-1-2. Replacing the Wiper Cleaner”. Never use alcohol; it will cause damage to the Print Heads.
- Install the Ink Cartridges properly. Be careful with their directions and the colors of Ink Cartridges (confirm both the colors of labels on your printer and the Ink Cartridges).
- To keep the best print result, your printer will show empty status for the color cartridge that is empty. At this point you will need to replace with a new Ink Cartridge. Ink Cartridge will not be totally empty. A small amount of ink remains to avoid damage to your printer. If you see the message “EMPTY XXXX (color)”, replace the Ink Cartridge.

## 1. Read This First

- Keep new consumables stored away from direct sunlight until you are ready to use them. For the best print result, we recommend you start using them by the date written on their packages and finish using them within six months of that date.
- Never use refilled or reconstructed Ink Cartridges. We assume no responsibility for any problem caused by using them.
- Do not leave your printer without installing the Ink Cartridges; otherwise your printer may be damaged or soiled with ink.
- Leaving your printer unused for a long period of time may cause damage to it, because dry ink may cause ink clogging. To avoid this, turn on your printer at least once a week and press the Head Cleaning Button to clean the Print Head. If you are planning not to use your printer for more than two weeks, follow “6-1-5. Required Maintenance for the Long Storage” to prevent ink clogging.

### <Note>

*Product names used in this manual are, in general, trademarks or registered trademarks of their respective developer or manufacture. However, in this manual, the ® marks or <sup>TM</sup> marks are not used. Microsoft and Windows are either registered trademarks of Microsoft Corporation in the United States and/or other countries.*

*Corel and CorelDRAW are registered trademarks of Corel Corporation.*

*Adobe, Adobe Photoshop, Adobe Illustrator and Adobe Photoshop Elements are either registered trademarks of Adobe Systems Incorporated in the United States and/or other countries.*

*Paint Shop Pro is a trademark of Jasc Software, Inc.*

*CompactFlash is a trademark of SanDisk Corporation.*

*Beefy-T is a trademark of Hanes Corporation.*

*Other product and company names mentioned herein may be the trademarks or registered trademarks of their respective owners.*

*Screen shots used in this document are in accordance with the guidelines of Microsoft Corporation.*

---

## 1-2. Unpacking Your Printer

<Note>

*Your printer must be unpacked by a Brother representative or a Brother authorized shipping company.*

After unpacking, check that the following parts are included.

Contact Brother Customer Service Hot Line if any of these is missing.

- GT-541 Printer
- Rear Cover
- 4 Print Heads
- Install CD
- AC cord, UL/CSA 15 A
- Ink Cartridges:  
Ink GC-50K (black), Ink GC-50M (magenta), Ink GC-50C (cyan), and Ink GC-50Y (yellow)
- Nozzle Cleaning Kit
- Basic Operation Manual
- Instruction Manual (this manual)

<Note>

*Four Filter Cartridges are installed in the Ink Cartridge Slots. Keep them since they must be used for maintenance operations.*

### 1-3. Required Condition

Please use your printer under the conditions described in this section.

#### 1-3-1. Environment

	Temperature	Humidity
Keeping your printer	32 °F to 104 °F (0 °C to 40 °C)	20 % to 85 % (no condensation)
Operating your printer	50 °F to 95 °F (10 °C to 35 °C)	
For the best print result	59 °F to 86 °F (15 °C to 30 °C)	35 % to 85 % (no condensation)

#### 1-3-2. Electrical Requirements

**Power:**

115 V (+/- 10%), 60 Hz (+/- 1)

**Power Consumptions:**

90 VA (average)

#### 1-3-3. Software Information

**Supported OS:**

Windows 2000 Professional SP4, Windows XP Professional SP2/ Home SP2

**Supported Interface:**

USB 1.1/ 2.0

**Operationally Approved Application:**

Adobe Photoshop 6.0/ 7.0/ CS, Adobe Photoshop Elements 3,  
Adobe Illustrator 10/ CS, CorelDRAW 10/ 11/ 12, Paint Shop Pro 9

**Minimum System Requirements:**

256 MB RAM (512 MB or more is recommended),  
128 MB free disk space (256 MB or more is recommended),  
1 GHz CPU (2 GHz or more is recommended.)

### 1-3-4. Other Requirements

When purchasing optional tools, choose one that meets the following requirements.

**USB cable:**

USB 2.0-compliant device cable (A/B)

<Note>

*Using other than USB 2.0-compliant device cable may result in improper connection.*

**CompactFlash:**

Type I Memory Card, Capacity of 64 MB to 2 GB,

FAT16 formatted,

SanDisk CompactFlash is recommended.

**Heat Press:**

Must be able to handle the Platen 14 x 16, and maintain heat production of 356 °F (180 °C) for 35 seconds.

**T-shirt:**

White or light-colored

Made with 100 % cotton, or 50 % cotton and 50 % polyester

“Hanes Beefy-T” is recommended.

### 1-3-5. Consumable Requirements

When you replace or use up the consumables, please use the following Brother genuine items.

Consumable	Item Code
Black Ink Cartridge	GC-50K
Magenta Ink Cartridge	GC-50M
Cyan Ink Cartridge	GC-50C
Yellow Ink Cartridge	GC-50Y
Waste Ink Cartridge	SA5629001
Cap Cleaning Kit	SA5774001
Nozzle Cleaning Kit	SA5885001
Platen Sheet	SA5620101
Wash Liquid	SA6248001

## 2. Identifying Your Printer's Parts

### 2-1. Front

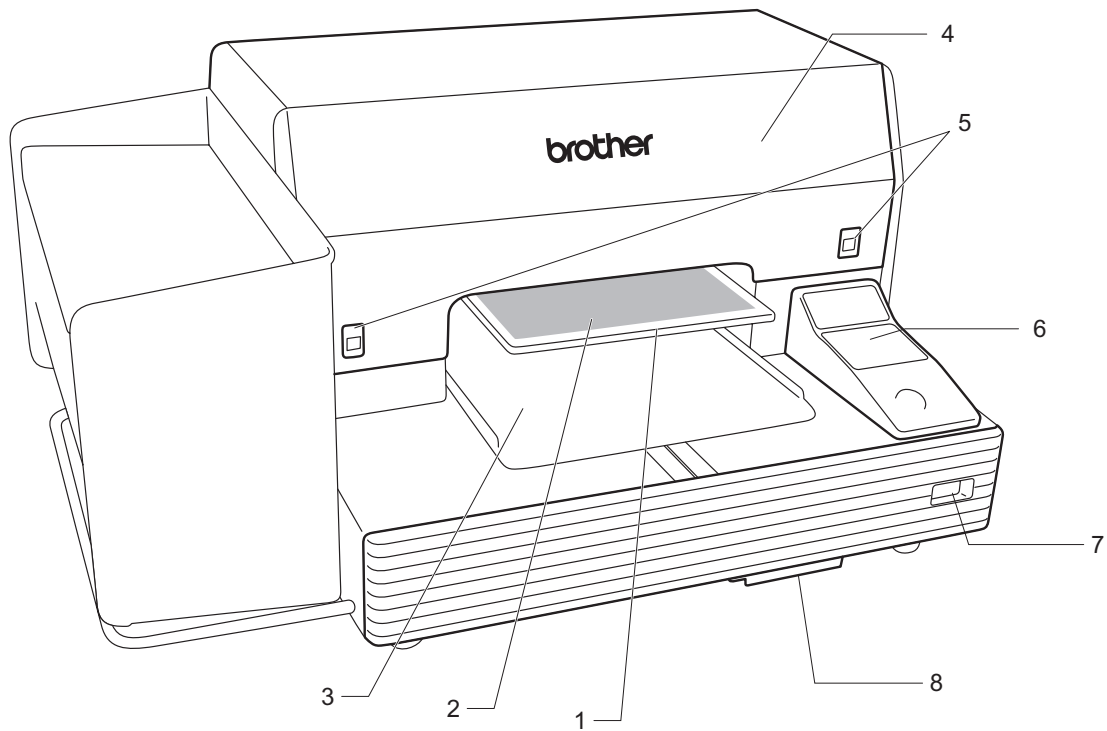

No.	Name	Description
1	Platen	Place a T-shirt on it.
2	Platen Sheet	Prevents a T-shirt from slipping so that an image is printed on your desired position.
3	T-shirt Tray	Keeps parts of T-shirt hanging from the Platen (e.g. sleeves) on this T-shirt Tray.
4	Front Cover	Open this to work on the inside of your printer.
5	Cover Locks	Push this up to open the Front Cover.
6	Control Panel	Use this to operate your printer. See "2-7. Control Panel" for the details.
7	Power Switch	Turns on/off your printer.
8	Waste Cartridge Tray	Contains the Waste Ink Cartridge.

**2-2. Left**

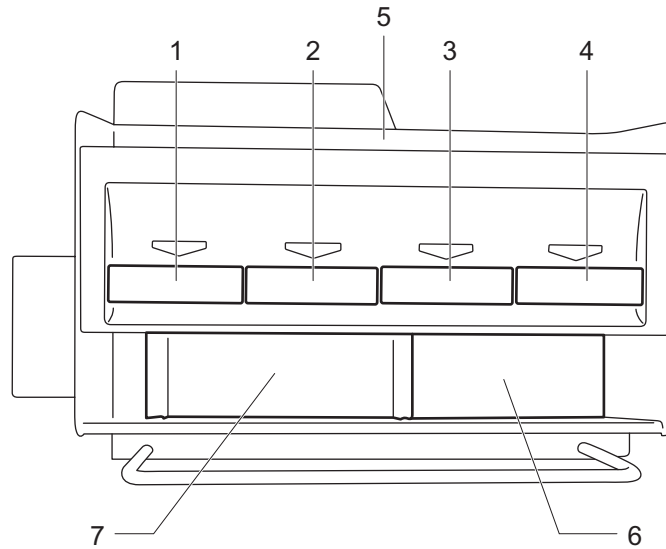

No.	Name	Description
1	Black Ink Cartridge Slot	Load an Ink Cartridge of the appropriate color.
2	Magenta Ink Cartridge Slot	
3	Cyan Ink Cartridge Slot	
4	Yellow Ink Cartridge Slot	
5	Ink Cartridge Storage	Store the new Ink Cartridges.
6	Cleaning Tool Storage	Store the Cleaning Kits.
7	Filter Cartridge Storage	Store the four Filter Cartridges.

**2-3. Right**

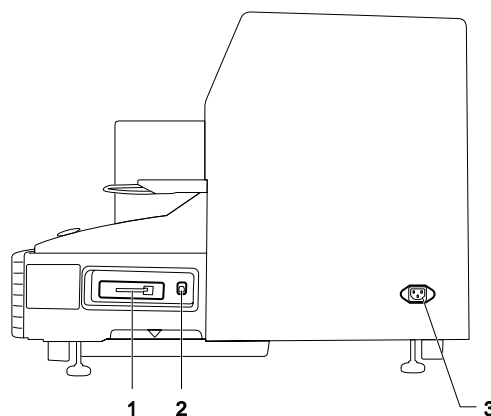

- 1. CompactFlash slot
- 2. USB port
- 3. Power cord jack

## 2-4. Rear

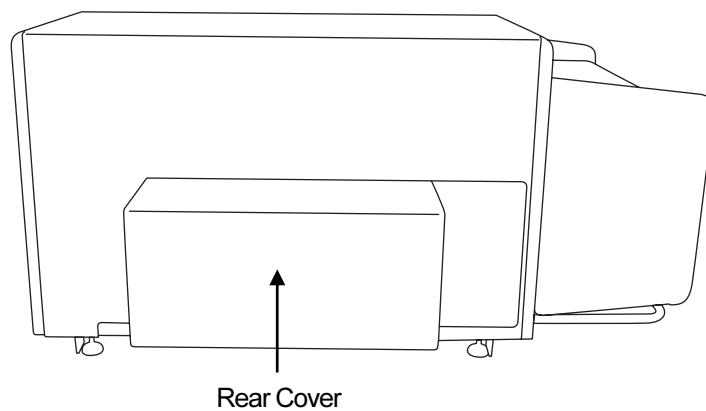



## 2-5. Inside of the Front Cover

<Note> Cancel any operation and turn off your printer before opening the Front Cover.

Open the Front Cover by pushing up the Cover Locks.

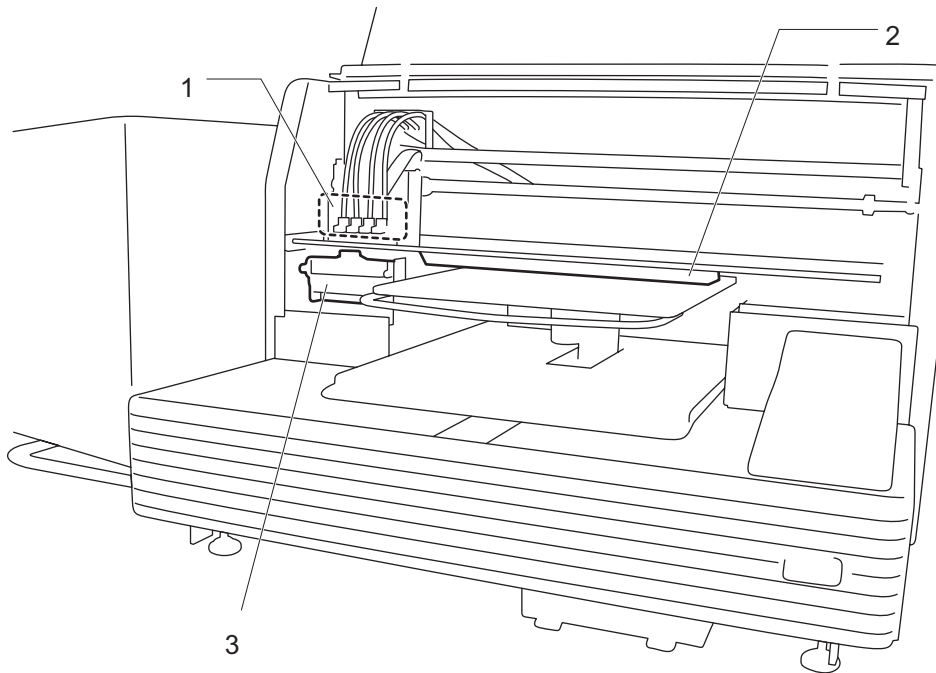
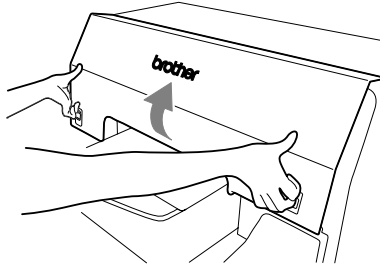

No.	Name	Description
1	Print Heads	Jets the ink. From the left black, magenta, cyan, and yellow.
2	Obstruction Sensor	Cancels an operation for safety, if it detects obstructions on the Platen.
3	Wiper Cleaner Cassette	Contains the Wiper Cleaner.

---

## 2-6. Under the Platen

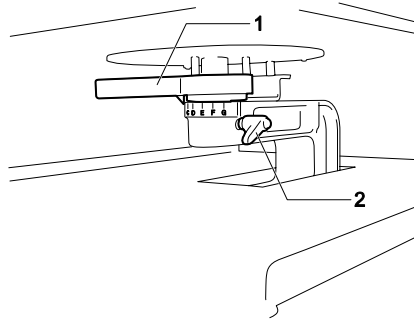

No.	Name	Description
1	Platen Height Adjustment Lever	Adjusts the Platen height.
2	Platen Fixing Lever	Fixes the Platen. Tighten/Loosen this lever to install/uninstall the Platen, and when adjusting the Platen height.

## 2-7. Control Panel

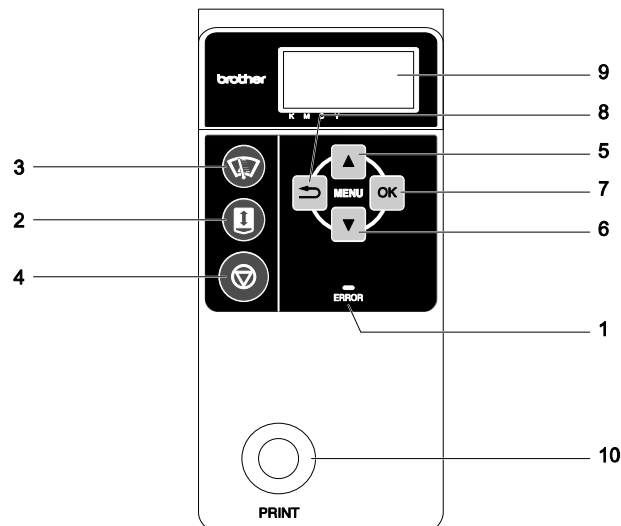

No.	Name	Description
1	Error Lamp	Indicates errors or warnings. See "2-7-1. Indication Lamps" for the details.
2	Platen Button	Store / Eject the Platen.
3	Head Cleaning Button	Cleans the Print Heads. See "7-2-2. Cleaning the Print Heads" for the details.
4	Stop Button	Cancels printing and Print Head cleaning. Backs to the Stand By mode.
5	Up Button	Selects the previous (upper) item. Increases a numeric value. Opens the Menu display.
6	Down Button	Selects the next (lower) item. Decreases a numeric value. Opens the Menu display.
7	OK Button	Executes the selected command. Opens the Menu display. Clears the error status.
8	Back Button	Backs to the previous display. Opens the Menu display.
9	Display	Displays the Job Comment of the print data received, the status of your printer, and the menu items for various settings.
10	Print Button	Starts printing.

### 2-7-1. Indication Lamps

The lamps on the control panel indicate the status of your printer as shown below.

Lamp	Printer Status
Print Button	Off: No print data has been received.
	Flashing: Receiving a print data.
	On: A print data has been received.
Error Lamp	Off: No error is detected.
	On: An error has been detected (See "7-4. Error Messages" for the details).

<Note>

*They turn on during the initialization after you turn on your printer (for approx. 30 seconds).*

### 2-7-2. Display

#### Menu Display:

This display is used to select an operation for maintenance or setting up.



#### Job/ Status Display

When your printer has received a print data, it shows the Job/ Status Display: it displays the information needed for printing operations.

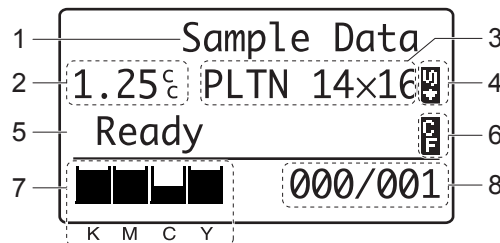

No.	Item Shown	Description
1	Job Comment	Shows the last 17 characters of a name of data received.
2	Amount of Ink Required	Shows warning messages if there is any. Shows how much ink (cc) is required for making one print of the received data.
3	Platen Size	The appropriate size of Platen (inches) or the Platen name.
4	Double Print Icon	Appears when "Double Printing" is checked.
5	Printer Status	Shows the printer status.
6	CF Icon	Appears when a CompactFlash is inserted.
7	Amount of Ink Remained	Shows amount of ink remained in each cartridge (from the left, <K (Black)>/ <M (Magenta)>/ <C (Cyan)>/ <Y (Yellow)>). It flashes when the ink is low.
8	Number of Print	Shows "Number of print completed"/ "Total number of print you have set".

<Note> When an error is detected, an error message will be displayed.

## 3. Getting Started

Before using your printer, you need to do the setup first. Complete the setup described in this chapter, and then you are ready to start printing.

### WARNING



Do not handle the power cord with wet hands, otherwise it may cause electric shocks.



Do not set up the printer in places where there is a lot of dust. If dust collects inside the printer, it may cause fire or electric shocks or problems with correct operation.



Be sure to connect the ground. If the ground connection is not secure, you run a high risk of receiving a serious electric shock, and problems with correct operation may also occur.



When securing the cords, do not bend the cords excessively or fasten them too hard with staples or anything similar, otherwise there is the danger that fire or electric shocks could occur.



### CAUTION



Setting up and moving of the printer should only be carried out by a qualified technician.



The printer machine weighs approximately 100 kg. Transporting and setting up of the printer should be carried out by four or more people.



Furthermore, do not hold the printer by the ink cartridge housing when transporting it, otherwise the ink cartridge housing may become damaged and the printer may fall down and cause personal injury or damage to the printer.



Do not place the printer on unstable surfaces such as unsteady tables or high shelves, otherwise it may tip over or fall down and cause injury.

Furthermore, the table that supports the printer should be at least 100 cm in width and 80 cm in depth, and should be able to bear a weight of 150 kg or more.



Do not set up the printer in a place where it will be affected by vibration from other equipment, otherwise it may become unbalanced and fall down and cause injury or damage to the printer.



Do not connect the power cord until setup is complete, otherwise the printer may operate if the power switch is turned on by mistake, which could result in injury.



Do not climb onto the printer or place heavy objects on top of it, otherwise it may become unbalanced and tip over or fall down and cause injury.

---

### 3-1. Placing Your Printer

Select the place where meets the following requirements:

- A place where is away from heat, high humidity, and direct sunlight.
- An indoor place where no dust enters your printer.
- Never use an extension cable.
- A place you can keep enough space around your printer.  
Minimum space of 800 mm on the front, 100 mm on the rear, 150 mm on the sides.  
See the figure below.

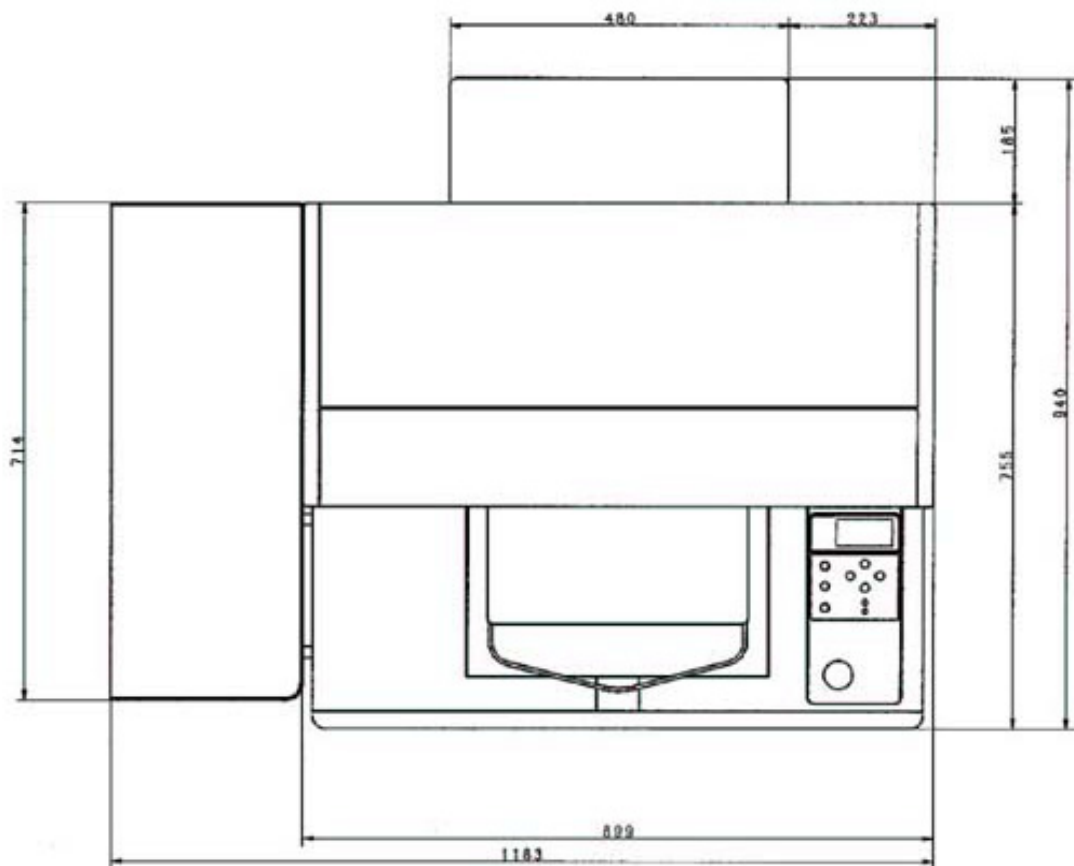

---

## 3-2. Turning On/Off Your Printer

*<Note> Before you connect the power code, make sure:*

- *The Ink Cartridges, Waste Cartridge Tray, and Wiper Cleaner Cassette are installed.*
- *The Rear Cover is mounted.*
- *Clear the front of the Platen as it slides out approximately 12 inches when operating.*

### 3-2-1. Turning On Your Printer

- (1) Connect the power cord (included) to the power cord jack of your printer.
- (2) Connect the power plug to the power outlet.  
Ground the power outlet using triode plug with protective earth terminal or triode-to-diode adaptor.
- (3) Press the Power Switch to turn on your printer.  
Your printer turns on, displays "Welcome to GT-541", and lights up the Error Lamp and the Print Button while initializing.  
The initialization requires approx. 40 seconds: a start-operation sound will be made when the initialization has been completed.  
When the installation finishes, "Stand By" appears on the display and your printer turns into standby mode.

### 3-2-2. Turning Off Your Printer

When you have finished using your printer, follow the instructions below to turn it off.

- (1) Make sure that your printer is not in the middle of any operation.
- (2) Press the Platen Button to store the Platen.
- (3) Press the Power Switch to turn off your printer.
- (4) If you are planning not to use your printer for long periods of time, disconnect the power plug from the power outlet.

*<Note>*

- *Do not turn off your printer during the operation; it may cause serious damage to your printer. If you turn off your printer accidentally during the operation, immediately restart it, and then turn it off correctly following the steps described in this section.*
- *Leaving your printer unused for a long period of time may cause damage to it, because dry ink may cause ink clogging. To avoid this, turn on your printer at least once a week and press the Head Cleaning Button to clean the Print Head.  
If you are planning not to use your printer for more than two weeks, follow "6-1-5. Required Maintenance for the Long Storage" to prevent ink clogging.*



### 3-3. Preparing Your PC

This section describes how to install the GT-541 Printer Driver, manuals (Basic Operation Manual/ Instruction Manual), Brother GT File Viewer, and other tools.

All of them can be installed at once.

#### 3-3-1. For Windows XP Users

**<Before installing!> Start installing without connecting your printer to your PC.**

<Note>

With Windows XP, you need to log on with a Computer Administrator account for the installation. You cannot install the software programs as a Limited account user.

- (1) Turn on your PC.
- (2) Close all applications opening.
- (3) Insert the Install CD (included) to your PC.

If the following installer automatically opens, then skip step (4) and (5) and go to step (6).



If not, go on to the next step to open the installer.

- (4) Click "Run..." on "Start" menu.
- (5) Enter "(CD-ROM drive location):\GTSetup.exe", and then click "OK".

\*The location of CD-ROM drive depends on your PC.



The installer opens.

### 3. Getting Started

- (6) Click “Install Driver & Tools”.



The following window appears.

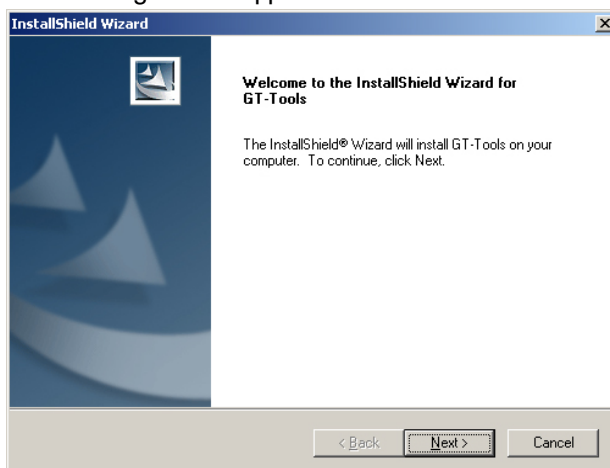

<Note>

*If you click “Install Driver & Tools” after completing the installation, the “Confirm Uninstall” window appears. Executing uninstalling on this window, uninstalls the necessary tools (the printer driver is not uninstalled). If you accidentally uninstall them, make sure you install them again.*

- (7) Click “Next”.

The installation starts.

- (8) During the installation, the following warning appears. Click "Continue Anyway".



The installation continues.

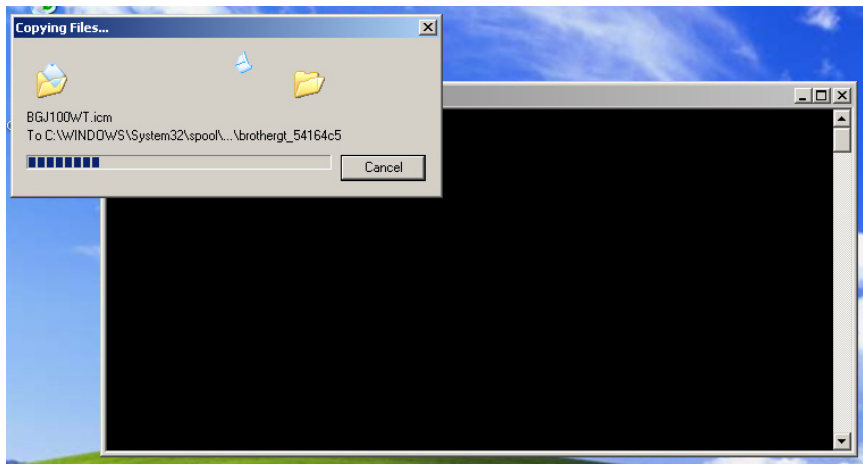

<Note>

- This software has proved to work sufficiently with Windows XP. You do not have to stop the installation.
- Do not cancel installing, or close the dialogs until the installation completed.

- (9) Remove the Install CD when the following window appears.

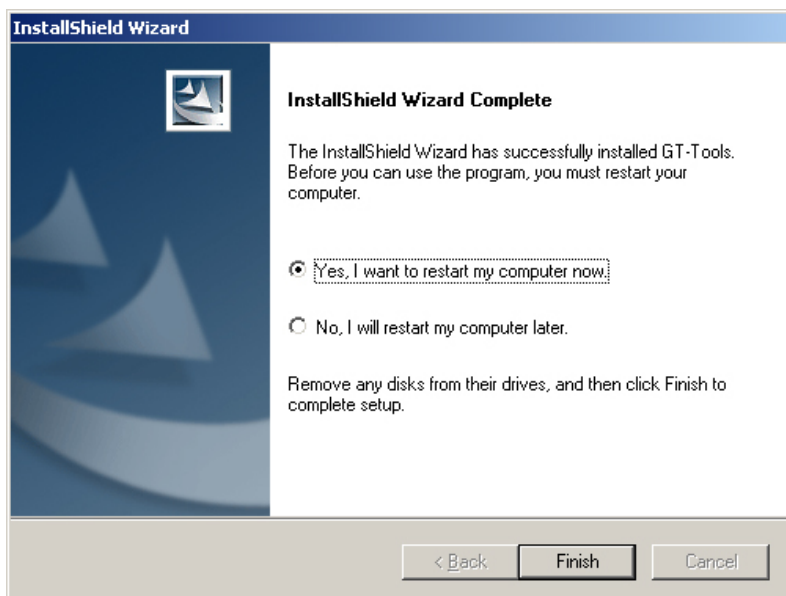

- (10) Select “Yes, I want to restart my computer now”, and then click “Finish” to restart your PC.  
If you are going to use your printer without connecting it to your PC, this will be the end of PC preparation.  
If you are going to use your printer connected to your PC, go on to the next step.  
<Note>  
*If you select “No, I will restart my computer later”, make sure you restart your PC before going to the next step.*
- (11) Connect the USB 2.0 cable to your printer.  
<Note>
- *Do not connect the USB 2.0 cable to your PC first.*
  - *The USB 2.0 cable is not included. Separate purchase is required.*
  - *To connect your printer to your PC using a USB hub, please contact Brother Customer Service Hot Line before you connect.*
- (12) Connect the other end of the USB 2.0 cable to your PC.

- (13) Turn on your printer.

The following window appears.



- (14) Select "No, not this time", and then click "Next".

- (15) Insert the Install CD.

The following window appears.

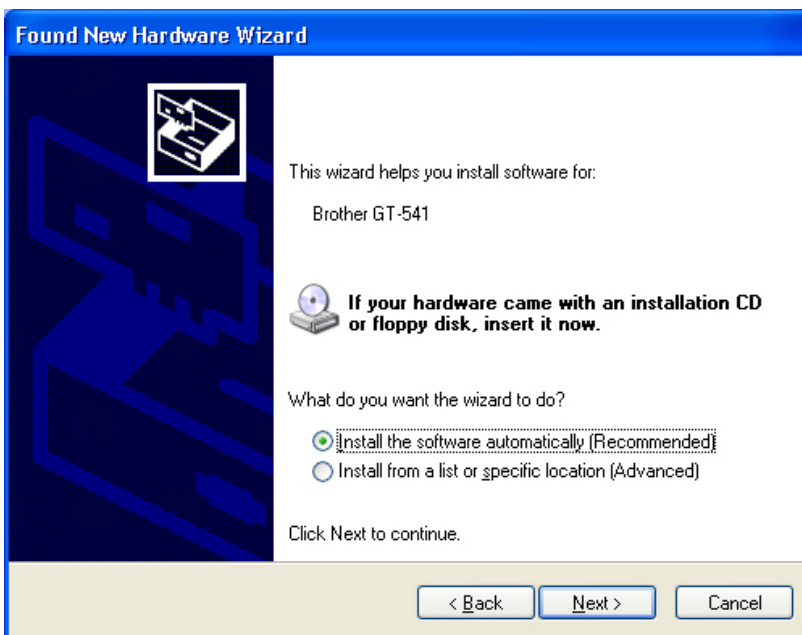

### 3. Getting Started

(16) Select "Install the software automatically (Recommended)", and then click "Next".

The installation starts.

During the installation, the following warning appears.



(17) Click "Continue Anyway".

The installation continues.

<Note>

- This software has proved to work sufficiently with Windows XP. You do not have to stop the installation.
- If the following window appears, follow the instruction below:

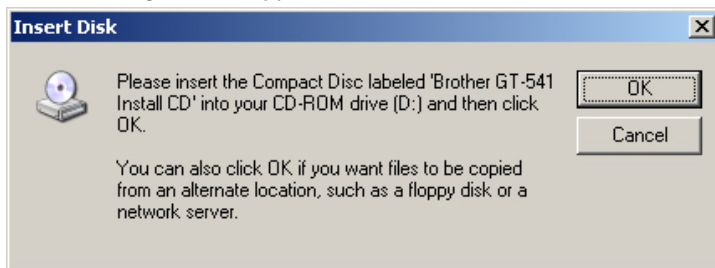

(1) Confirm that the Install CD is inserted properly, and then click "OK".

The following window appears.

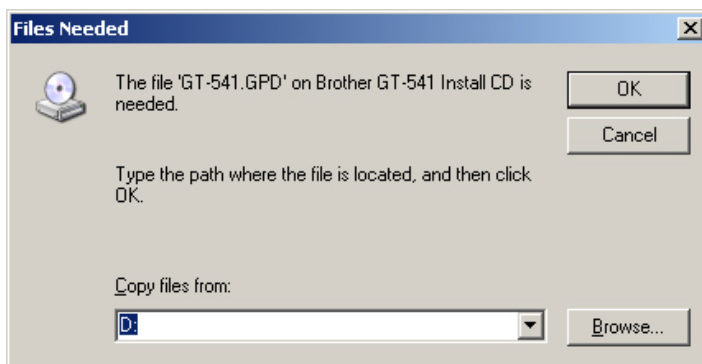

(2) Click "Browse..." to select the CD drive, and then click "OK".

The installation continues.

(18) Click "Finish" when the following window appears.

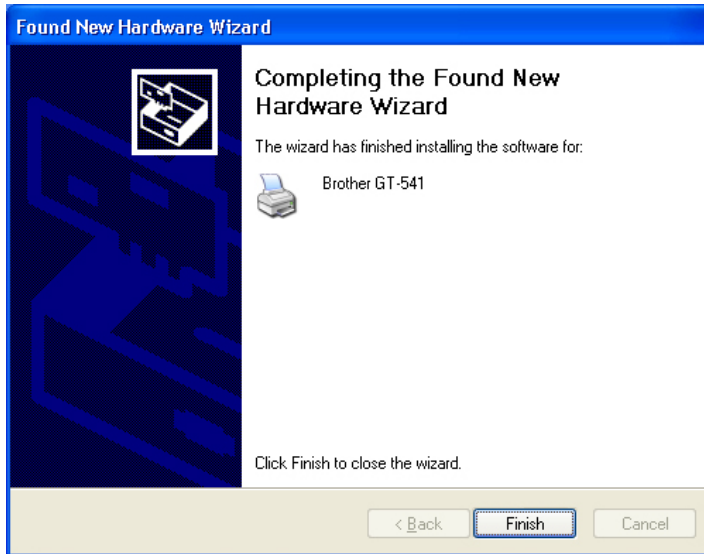

(19) Open the "Printer and Faxes" in the "Control Panel".

(20) Click the "Brother GT-541" icon, and then select "Set as Default Printer" on "File" menu.

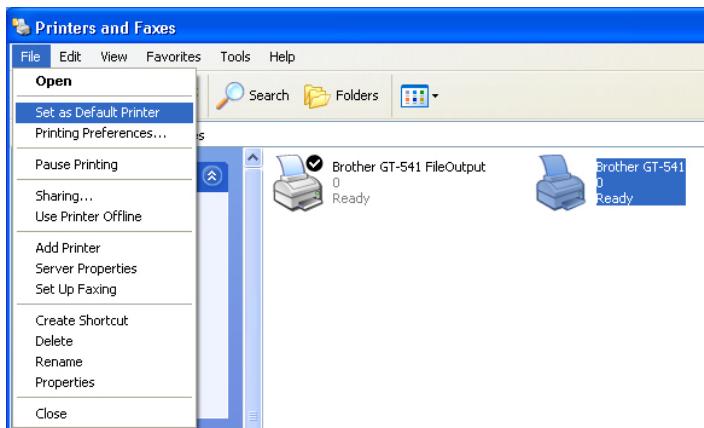

"Brother GT-541" icon is checked and Brother GT-541 is set as the default printer.



The PC preparation has been completed.

<Note>

To connect another GT-541 to the PC, repeat the steps (11) to (18). From the second GT-541, the printer names automatically become "GT-541(copyX)". You can change the names in the "Printer and Faxes" in the "Control Panel" for your workability.

### 3. Getting Started

#### Opening the installed manuals:

- (1) Click "All Programs" on "Start" menu.
- (2) Select "Brother GT-Tools".

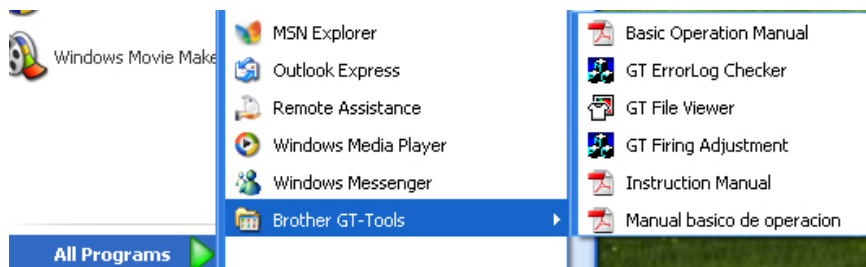

- (3) Click the manual you want to open.



### 3-3-2. For Windows 2000 Users

**<Before installing!> Start installing without connecting your printer to your PC.**

<Note>

With Windows 2000, you need to log on as a user with administrative rights for the installation.

- (1) Turn on your PC.
- (2) Close any applications opening.
- (3) Insert the Install CD (included) to your PC.

If the following installer automatically opens, skip step (4) and (5) and go to step (6).



If not, go on to the next step to open the installer.

- (4) Click "Run" on "Start" menu.
- (5) Enter "(CD-ROM drive location):\GTSetup.exe", and then click "OK".

\*The location of CD-ROM drive depends on your PC.

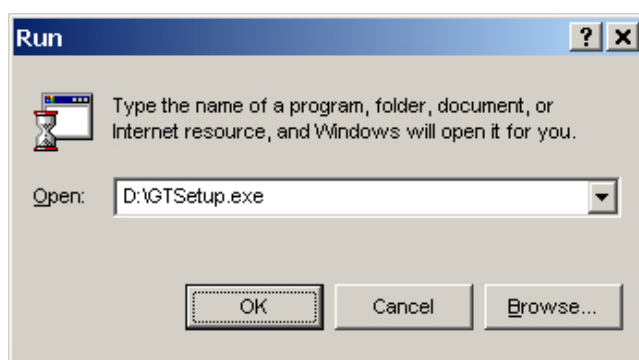

The installer opens.

### 3. Getting Started

- (6) Click “Install Driver & Tools”.

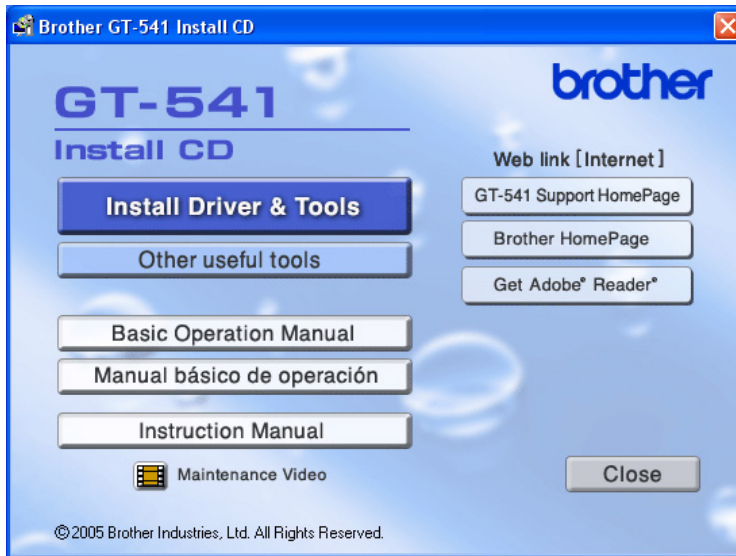

The following window appears.

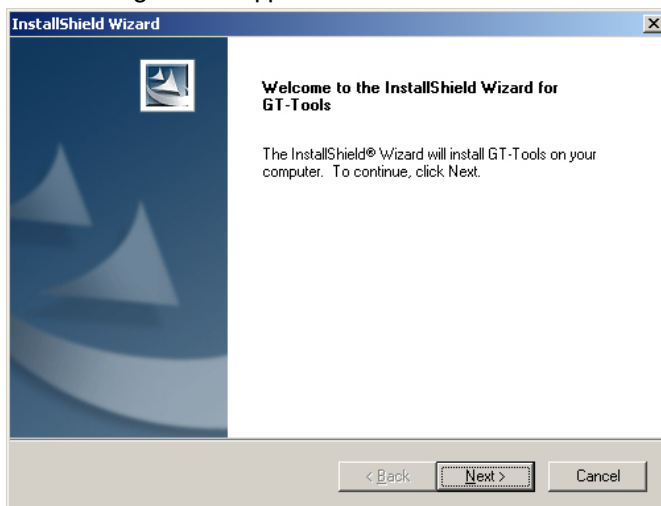

<Note>

If you click “Install Driver & Tools” after completing the installation, the “Confirm Uninstall” window appears. Executing uninstalling on this window, uninstalls the necessary tools (the printer driver is not uninstalled). If you accidentally uninstall them, make sure you install them again.

- (7) Click “Next”.

The installation starts.

- (8) During the installation, the following warning appears.  
Click "YES".

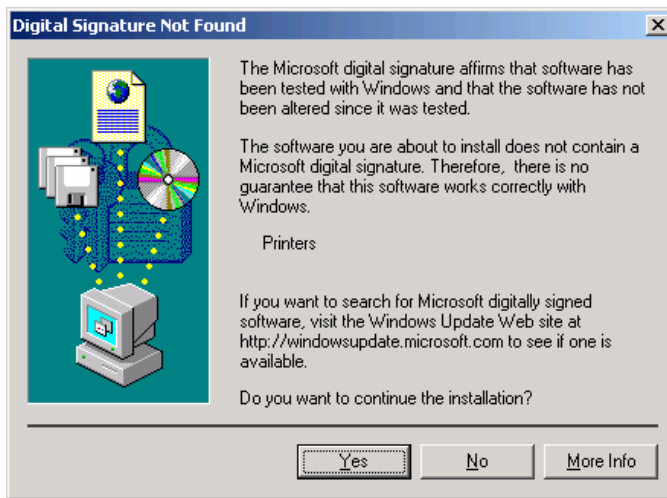

The installation continues.

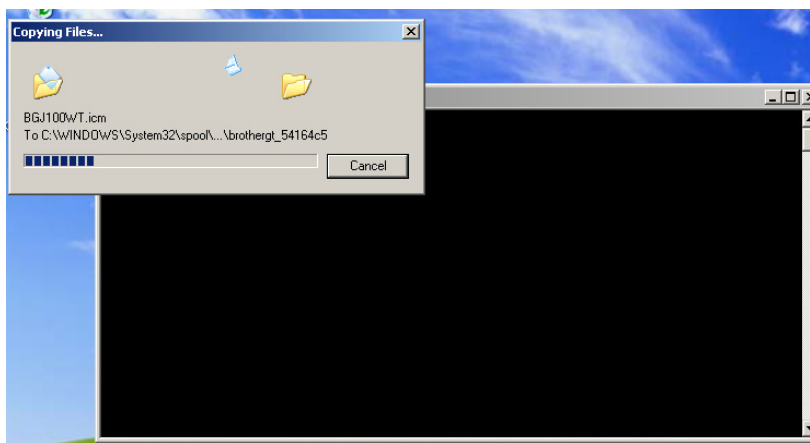

<Note>

- This software has proved to work sufficiently with Windows 2000. You can continue the installation.
- Do not cancel installing, or close the dialogs until the installation completed.

- (9) Remove the Install CD when the following window appears.

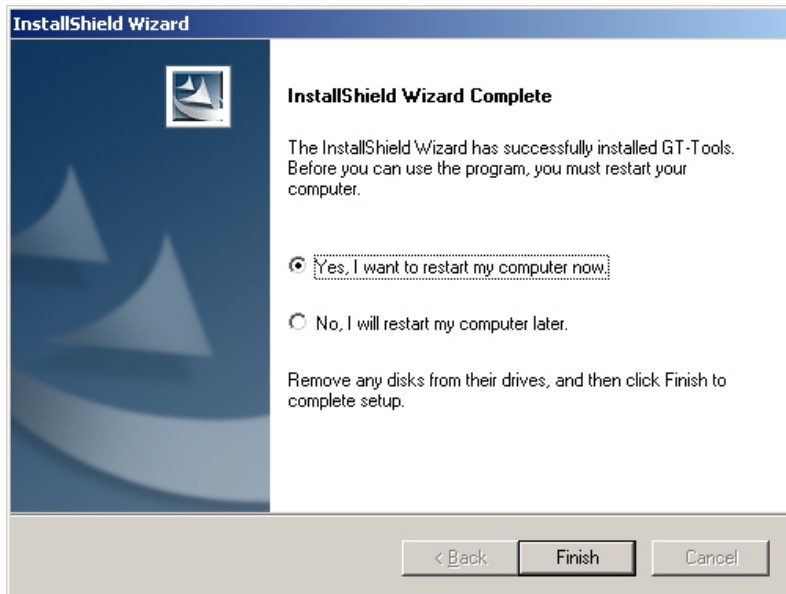

- (10) Select “Yes, I want to restart my computer now”, and then click “Finish” to restart your PC.  
If you are going to use your printer without connecting it to your PC, this will be the end of PC preparation.  
If you are going to use your printer connected to your PC, go on to the next step.
- (11) Connect the USB 2.0 cable to your printer.  
<Note>
- Do not connect the USB 2.0 cable to your PC first.
  - A USB cable is not included. Separate purchase is required.
  - To connect your printer to your PC using a USB hub, please contact Brother Customer Service Hot Line before you connect.
- (12) Connect the other end of the USB 2.0 cable to your PC.

(13) Turn on your printer.

Brother GT-541 is installed automatically.

<Note>

If Brother GT-541 is not installed, the following window appears: follow the instruction below to install it manually:

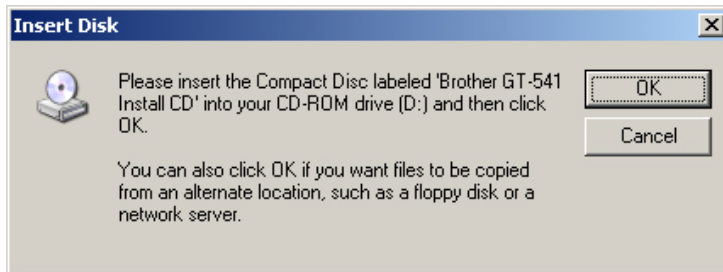

(1) Insert the Install CD, and then click "OK".

The following window appears.

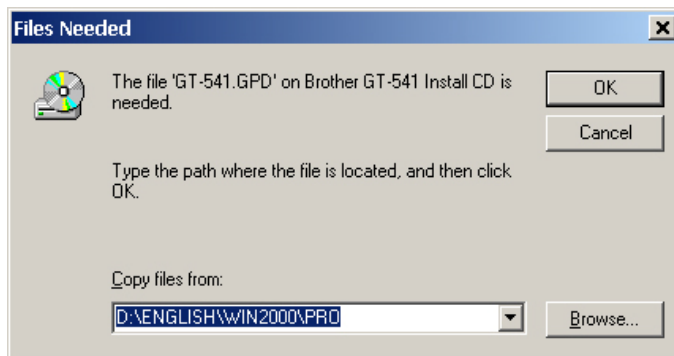

(2) Click "Browse..." to select the CD drive, and then click "OK".

Brother GT-541 is installed.

(14) Open the "Printers" in the "Control Panel".

### 3. Getting Started

(15) Click the "Brother GT-541" icon, and then select "Set as Default Printer" on "File" menu.

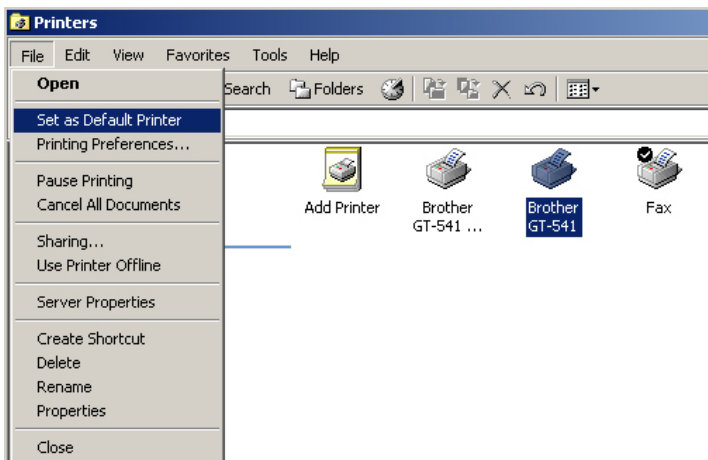

"Brother GT-541" icon is checked and Brother GT-541 is set as the default printer.



The PC preparation has been completed.

<Note>

To connect another GT-541 to the PC, repeat the steps (11) to (13). From the second GT-541, the printer names automatically become "GT-541(copyX)". You can change the names in the "Printers" in the "Control Panel" for your workability.

#### Opening the installed manuals:

- (1) Click "All Programs" on "Start" menu.
- (2) Select "Brother GT-Tools".

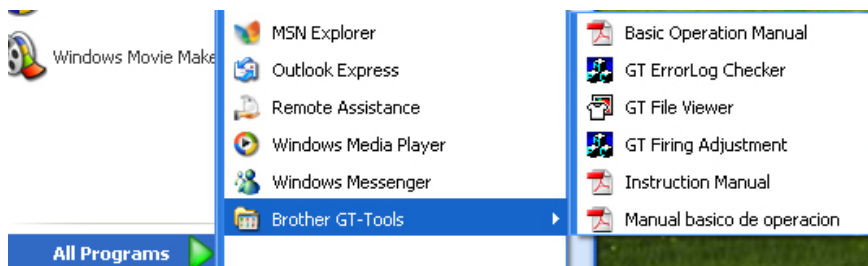

- (3) Click the manual you want to open.

### 3-3-3. Installing the Useful Tools

We provide useful tools and the color palette for Adobe Photoshop/ CorelDRAW to help you make the print image.

Follow the instructions below to install them.

- (1) Turn on your PC.
- (2) Insert the Install CD (included) to your PC.

If the following installer automatically opens, skip step (3) and (4) and go to step (5).



If not, go on to the next step to open the installer.

- (3) Click "Run..." on "Start" menu.
- (4) Enter "(CD-ROM drive location):\GTSetup.exe", and then click "OK".

\*The location of CD-ROM drive depends on your PC.



The installer opens.

- (5) Click “Other useful tools”.



Follow the instruction appeared on your PC's display.

---

## 3-4. Setting Up Your Printer

Adjust the display contrast and the speaker volume for your best workability.

### 3-4-1. Adjusting the Display Contrast

- (1) Turn on your printer if it is off.
- (2) Press the OK Button on your printer's Control Panel.

The following display appears.

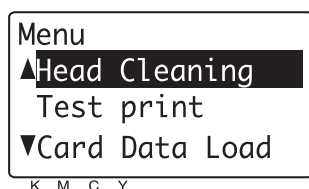

- (3) Use the Up/Down Button to highlight “LCD Contrast”, and then press the OK Button.

The following display appears.

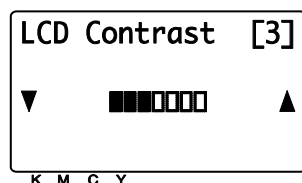

- (4) Use the Up/Down Button to select your desired contrast from 0 to 7, and then press the OK Button.  
The contrast is adjusted to your desired level.



### 3-4-2. Adjusting the Speaker Volume

<Note> The adjusted volume is also applied to the error sound.

- (1) Turn on your printer if it is off.
- (2) Press the OK Button on your printer's Control Panel.

The following display appears.



- (3) Use the Up/Down Button to select "Speaker Volume", and then press the OK Button.

The following display appears.

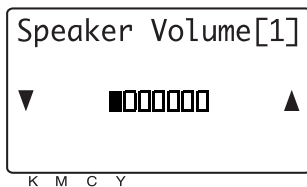

- (4) Use the Up/Down Button to select your desired volume from 0 (silent) to 7, by listening to the confirmation sound made when pressing the Up/Down Button, and then press the OK Button.

The volume is adjusted to your desired level.

## 4. Printing Directly from Applications

### **WARNING**



If a foreign object gets inside the printer, immediately turn off the power switch and disconnect the power cord, and contact the place of purchase or a qualified technician.



If you continue to use the printer while there is a foreign object inside, it may result in fire or electric shocks or problems with correct operation.



Do not allow water or oil to get onto the printer, otherwise it may cause fire or electric shocks or problems with correct operation.



If any liquids get onto the printer, immediately turn off the power switch and disconnect the power cord, and contact the place of purchase or a qualified technician.



Do not use the printer if a problem is noticed such as smoke or a bad odor coming from the printer, otherwise it may cause fire or electric shocks or problems with correct operation.



Immediately turn off the power switch and disconnect the power cord, and contact the place of purchase or a qualified technician.

(The printer must never be repaired by the customer, as it can be extremely dangerous to do so.)

### **CAUTION**



This printer should only be used by operators who have received the necessary training in safe use beforehand.



Do not push nor pull the platen by hands quickly.

It must be a cause of operation troubles or failures of printed circuit boards.



If a problem occurs with the operation of the printer, contact the place of purchase or a qualified technician.

---

## 4-1. Basic Printing Procedure

- (1) Create a print data using a graphic application (Adobe Photoshop, CorelDRAW, etc.):  
Design a print image using an operationally approved application. See "1-3-3. Software Information".
- (2) Set the print condition in the application:  
See "4-2. Setting the Applications' Print Condition" and set the print condition properly.
- (3) Set the printer driver condition:  
See "4-3. Setting the Printer Driver Condition".
- (4) Turn on your printer:  
See "3-2-1. Turning On Your Printer".
- (5) Send a print data from the application to your printer:  
When the printing command is executed from the applications, the print data is sent to your printer.
- (6) Install the Platen of the size you have selected in step (2):  
See "4-4. Uninstalling / Installing the Platen".  
*<Note> Only Platen 14 x 16 is included. Platen 10 x 12 is optional.*
- (7) Place the T-shirt on the Platen and adjust the Platen height:  
See "4-5. Placing the T-shirt on the Platen".
- (8) Start printing:  
Press the Print Button on the Control Panel to start printing.
- (9) Remove the T-shirt from the Platen.  
See "4-7. Removing the T-shirt From the Platen".
- (10) Set the ink onto the T-shirt:  
Use the Heat Press to set the ink onto the T-shirt. See "4-8. Setting the Ink onto the T-shirt".
- (11) Turn off your printer.  
See "3-2-2. Turning Off Your Printer".

## 4-2. Setting the Applications' Print Condition

This section describes required settings for each application used to make a proper print data. See the pages for applications used. Also see "4-2-9. Common Notice for All Applications". To save a print image as an ARP file, see "5. Printing ARP Files".

Refer to the manual of each application used for detailed printing steps.

### 4-2-1. Setting CoreIDRAW 10/11/12 Print Condition

First, make the color settings.

- (1) Select "Color Management" on "Tools" menu.

The following window appears. The orange arrow indicates it is active, and the grayed out arrow indicates it is inactive.



- (2) Select "Color Management off" as the style.

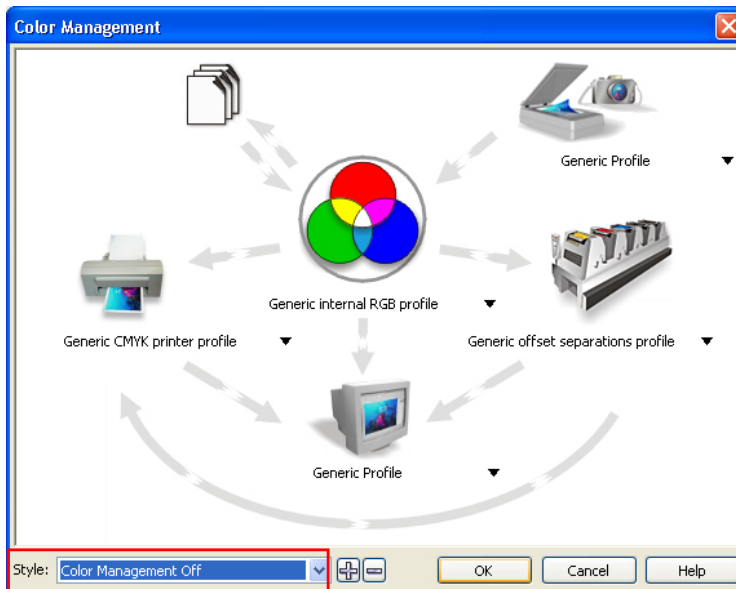

All arrows are deactivated.

After setting the color, preview the created image by following the instructions below and adjust its size or layout if necessary.

- (1) Select "Print Setup" on "File" menu.
- (2) Select "Brother GT-541" for the printer to be used.
- (3) Select "Page Setup" on "Layout" menu.  
*<Note> These steps can be applied to set an accurate layout for already existing files.*
- (4) Click "Set From Printer" to preview the created image in the Platen size.

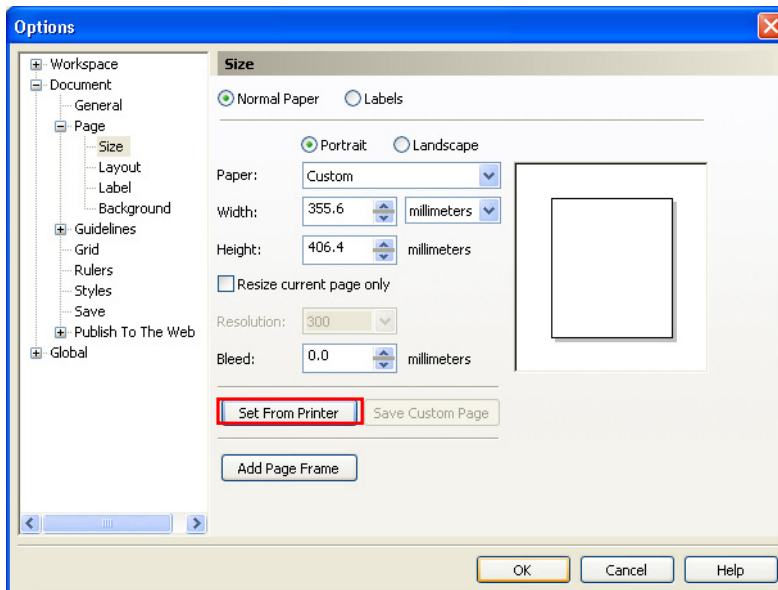

*<Note>*  
 The image may not be able to be previewed properly with the Platen 10 x 12. In this case, enter the Platen size using the numeric buttons.

After setting the print condition and the printer driver condition (see "4-3. Setting the Printer Driver Condition"), send the print data to your printer as follows.

- (1) Select "Print" on "File" menu.
- (2) Click "Print".

For the setting of the printer driver, click "Properties". See "4-3. Setting the Printer Driver Condition" for the detailed settings of the printer driver.

**<Important!>**

Do not check "Print to File" on Print window to make print files.

## 4-2-2. Setting Adobe Photoshop 6 Print Condition

Color settings and print settings are required before printing. After the printer driver is installed, set the color before editing the document.

### Color settings:

- (1) Select "Color Settings..." on "Edit" menu.  
The Color Settings window appears.
- (2) Make color settings as follows, and then click "OK".  
Advanced Mode: Check  
RGB: sRGB IEC61966-2.1  
CMYK: U.S. Web Coated (SWOP) v2  
Conversion Options/ Intent: Relative Colorimetric

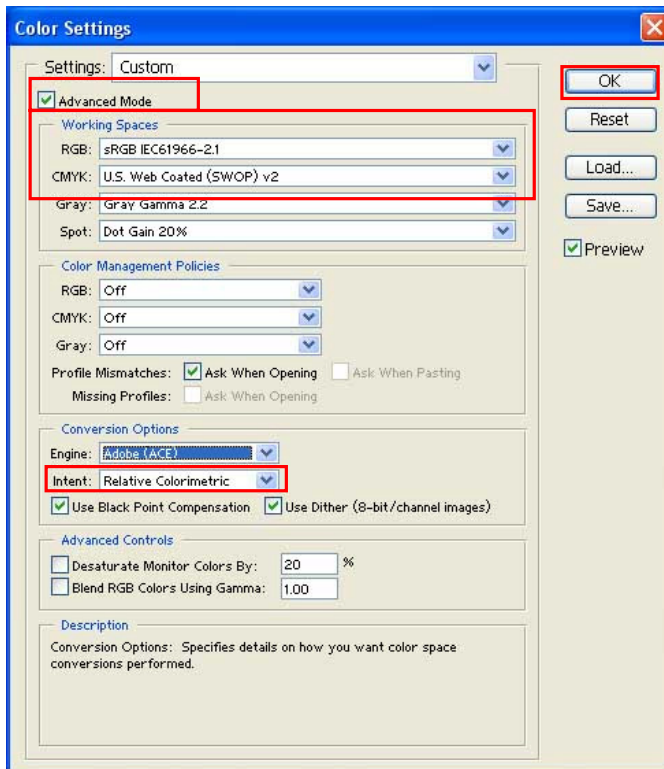

**Opening files:**

<Note for opening image files>

- **Opening the new file:**  
Create an image in RGB color mode to get the best color accuracy.
- **Opening the existing file:**  
If you see the following warning when opening files, follow one of the instructions below.  
For RGB document:  
Check as follows, and then click "OK".

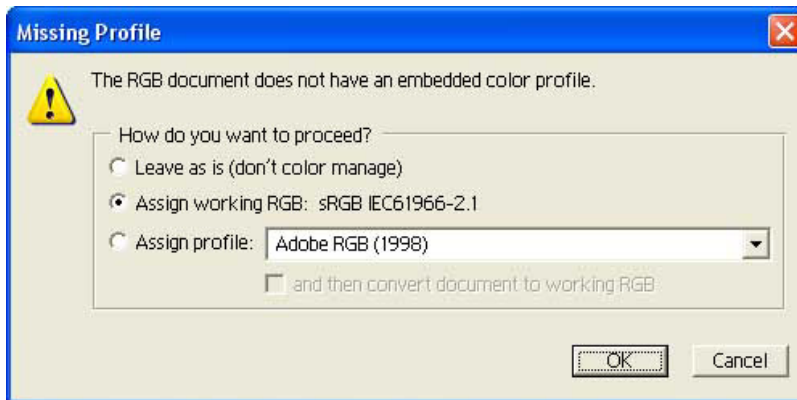

For CMYK document:  
Check as follows, and then click "OK".

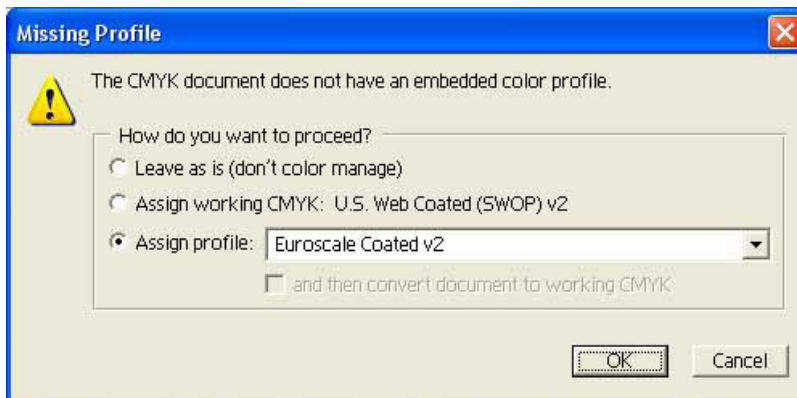

**<Important!>**

If the image is made in CMYK color, transform it into the RGB color (select "Image" -> "Mode" -> "RGB" color from the tool bar) for best color accuracy.

## Printing

- (1) Select "Print Options..." on "File" menu.

The Print Options window appears.

If the default printer of the PC used is set "Brother GT-541", the layout is set in this window.

- (2) Make print options as follows, and then click "OK".

Show More Options: Check

Pull-down menu: Color Management

Source Space/ Document: sRGB IEC61966-2.1 or Untagged RGB

Print Space/ Profile: Printer Color Management

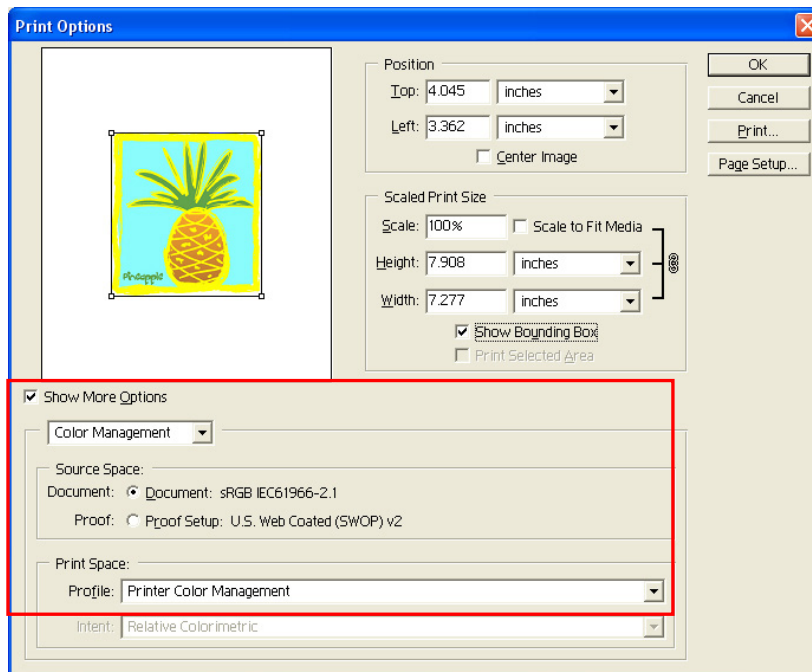



- (3) Click "Page Setup..." to set Printer Driver condition.

<Note>

If the "Brother GT-541" is NOT set as the default printer of your PC, set it prior to layout setting according to the following procedure.

(1) Select "Brother GT-541" for the Printer Name, and then click "OK".

(2) Click "Properties..." to set the printer driver condition.

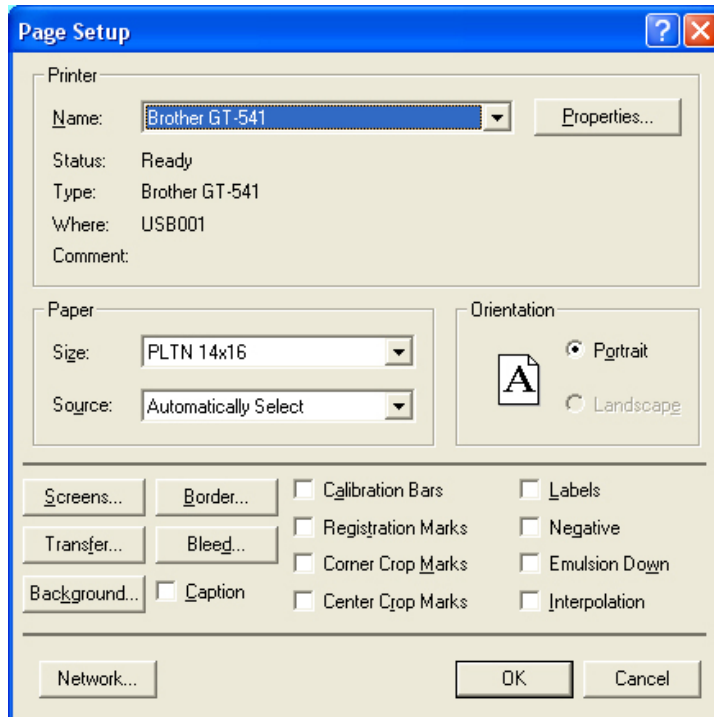

After setting the print condition and the printer driver condition (see "4-3. Setting the Printer Driver Condition"), send the print data to your printer as follows:

- (1) Select "Print" on "File" menu.

The Print window appears.

#### 4. Printing Directly from Applications

- (2) Confirm that “sRGB IEC61966-2.1” or “Untagged RGB” is set as the Source Space, and "Printer Color Management" as “Print Space/ Profile”, and then click “OK”.

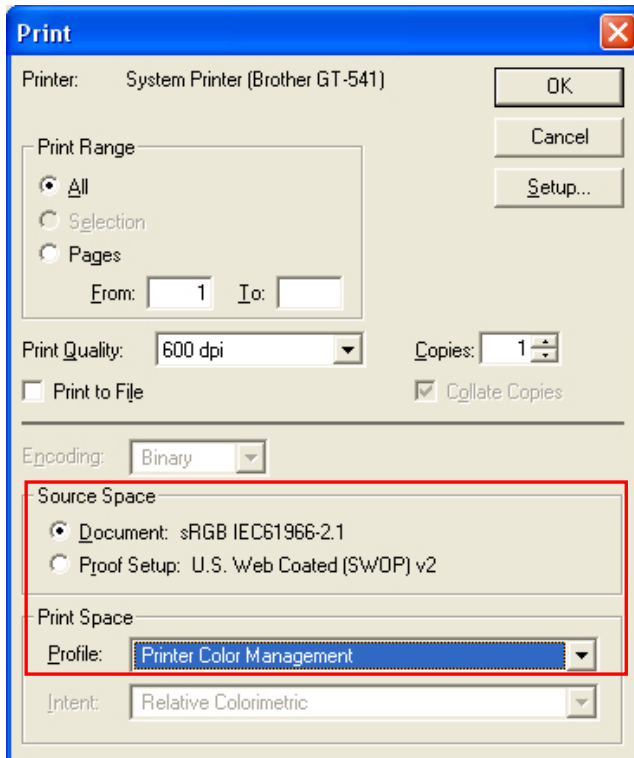

When the print data has been sent to your printer and ready to be printed, the Print Button on your printer's Control Panel turns on.

**<Important!>**

- The number of copies may not be able to be set to more than two.
- Do not check "Print to File" on Print window to make print files.

### 4-2-3. Setting Adobe Photoshop 7/ CS Print Condition

Color settings and print settings are required before printing. After the printer driver is installed, set the color before editing the document.

#### Color settings:

- (1) Select "Color Settings..." on "Edit" menu.  
The Color Settings window appears.
- (2) Make color settings as follows, and then click "OK".  
Advanced Mode: Check  
RGB: sRGB IEC61966-2.1  
CMYK: U.S. Web Coated (SWOP) v2  
Conversion Options/ Intent: Perceptual

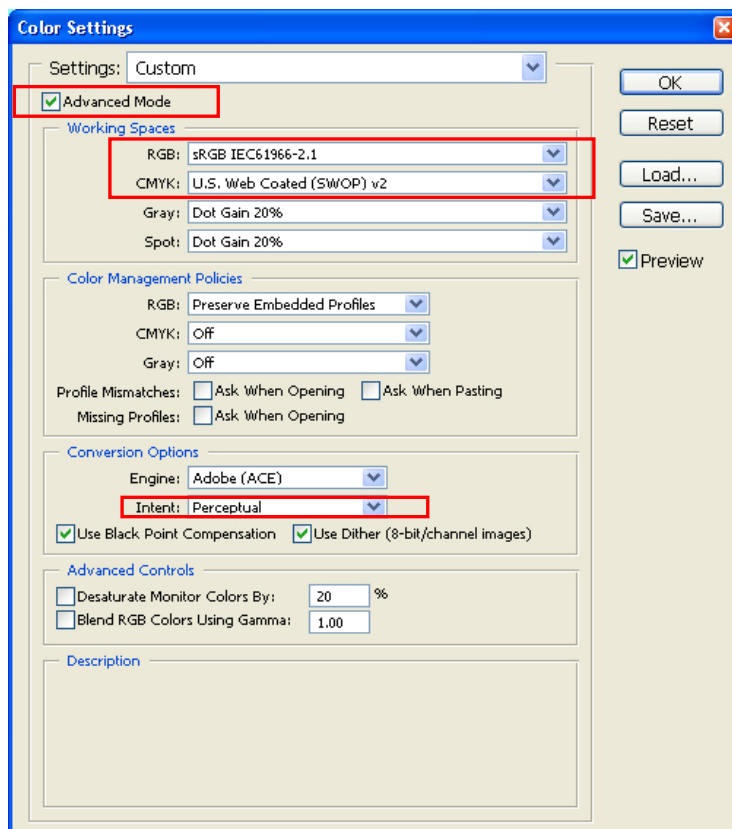

### Opening files:

<Note for opening image files>

- Opening the new file:

Create an image in RGB color mode to get the best color accuracy.

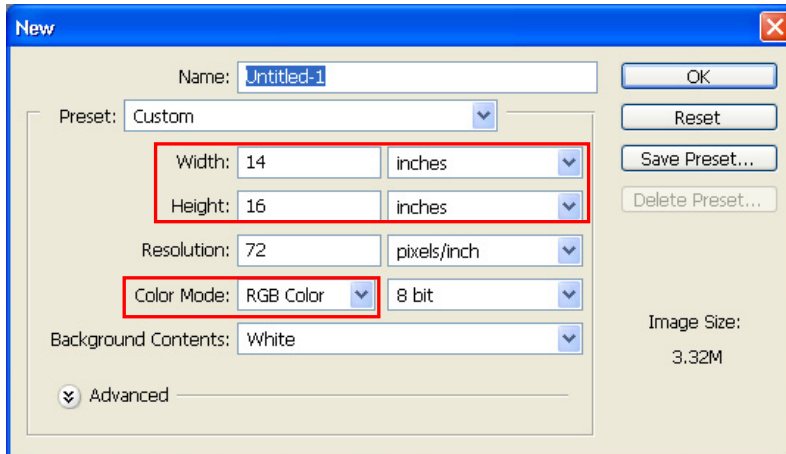

- Opening the existing file:

If you see the following warning when opening files, follow one of the instructions below.

For RGB document:

Check as follows, and then press "OK".

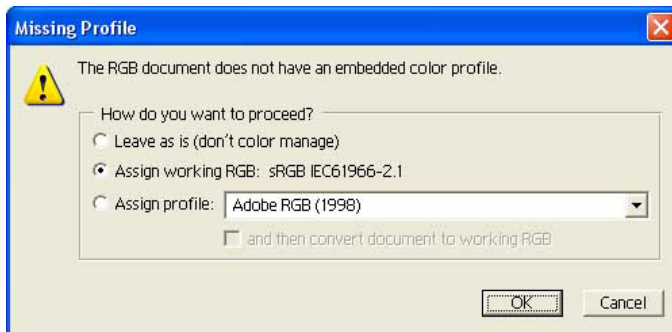

For CMYK document:

Check as follows, and then press "OK".

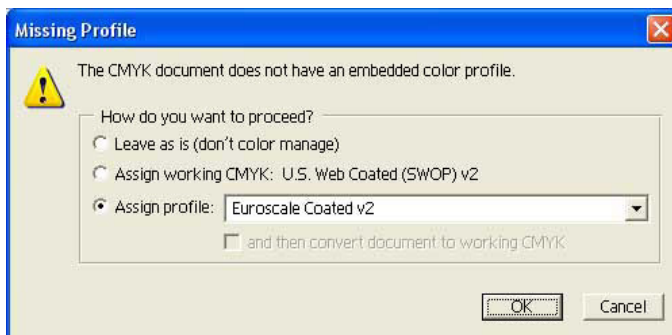

### <Important!>

If the image is made in CMYK color, transform it into the RGB color (select "Image" -> "Mode" -> "RGB" color from the tool bar) for best color accuracy.

**Printing:**

- (1) Select "Print with Preview" on "File" menu.

The Print with Preview window appears.

If the default printer of the PC is set "Brother GT-541", the layout is set in this window.

- (2) Make print options as follows, and then click "OK".

Show More Options: Check

Pull-down menu: Color Management

Source Space/ Document: sRGB IEC61966-2.1 or Untagged RGB

Print Space/ Profile: Printer Color Management

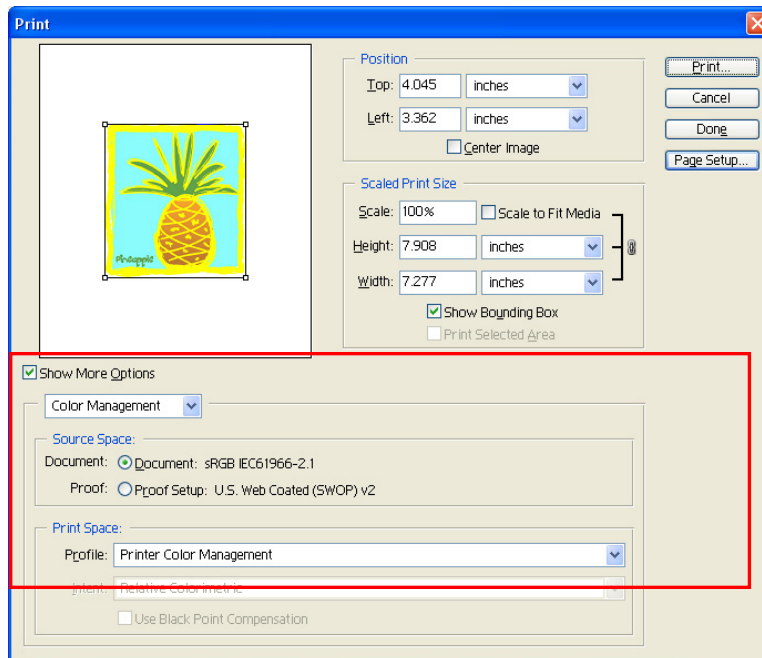

- (3) Select "Page Setup" to set the Printer Driver condition.

<Note>

If the "Brother GT-541" is NOT set as the default printer of your PC , set it prior to layout setting according to the following procedure.

- (1) Select "Page Setup" on this Print window or select "Print" on "File" menu.

#### 4. Printing Directly from Applications

The Print window appears.

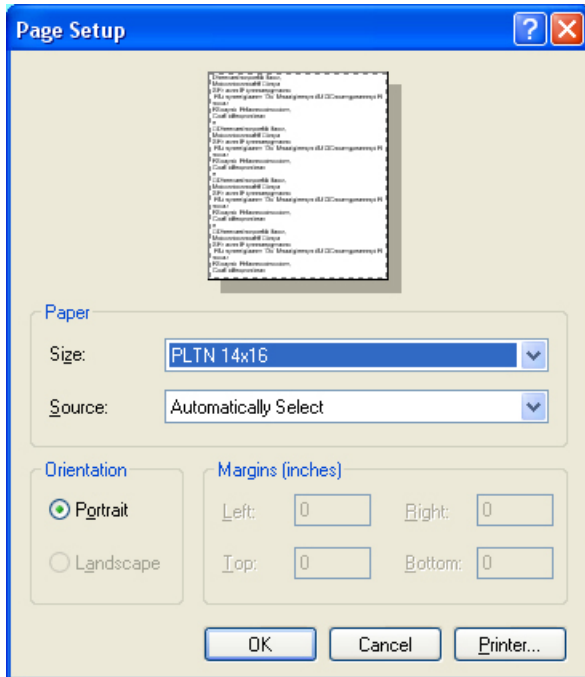

(2) Click "Printer..." and select "Brother GT-541" for the Printer Name, and then click "Properties..." to set Printer Driver condition.

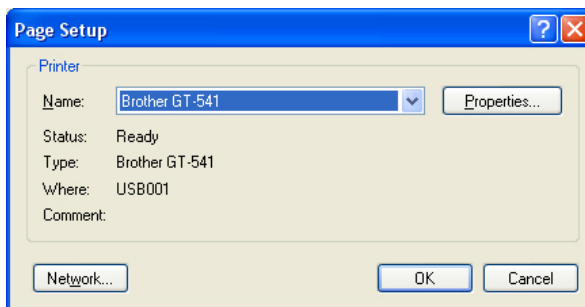

(3) After setting the layout, click "Print". Then the following window appears. Click "OK" when all settings are ready.

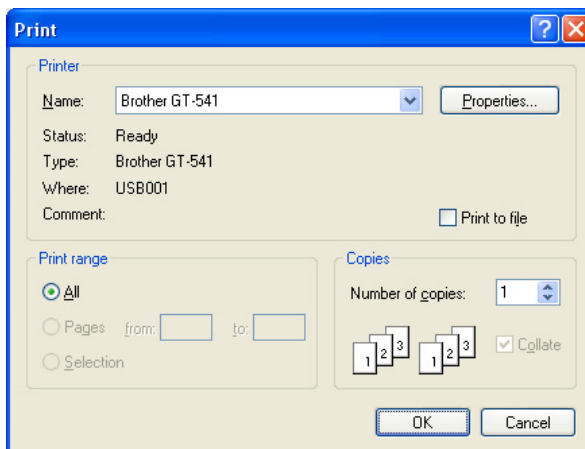

*When the print data is sent to your printer and ready to be printed, the Print Button on the printer's Control Panel turns on.*

**<Important!>**

- *There are several ways to set Properties of Printer Driver condition in Photoshop 7. When the values of Printing Preferences in Windows are set beforehand and you modified the values from the printer driver Properties dialog box of Photoshop, mismatching condition may appear among different dialog boxes. In that case, the valid values are the ones set in the Properties of the Print dialog box.*
- *Do not make "Print to File" checked on the Print window to make print files.*

#### 4-2-4. Setting Adobe Illustrator 10 Print Condition

Color settings and print settings are required before printing. After the printer driver is installed, set the color before editing the document.

**<Important!>**

- Set Brother GT-541 as the default printer before you go on to the following steps, otherwise, an image may be printed in the wrong direction, or wrong size, etc.
- Make the print data in RGB color mode to get the best color accuracy. Using the CMYK color mode image may result in dull, unclear print. Transforming it to RGB ("Document Color Mode" on "File" menu) may improve the result, but black, yellow, and violet cannot be printed accurately. We recommend you edit those colors or use Vivid Processing (see 4-3-4. Increasing the Vividness).

**Color settings:**

- (1) Select "Color Settings..." on "Edit" menu.  
The Color Settings window appears.
- (2) Make color settings as follows, and then click "OK".  
Advanced Mode: Check  
Working Spaces/ RGB: sRGB IEC61966-2.1  
Working Spaces/ CMYK: U.S. Web Coated (SWOP) v2  
Conversion Options/ Intent: Relative Colorimetric

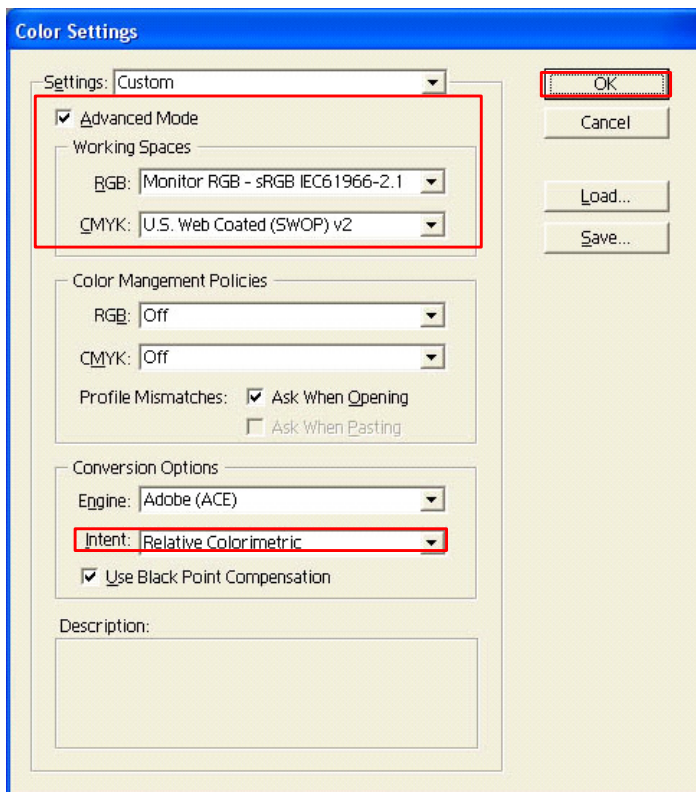



**Opening the new file:**

Set the New Document settings as follows:

Width: 14 in

Height: 16 in

Orientation: Portrait

Color Mode: RGB Color

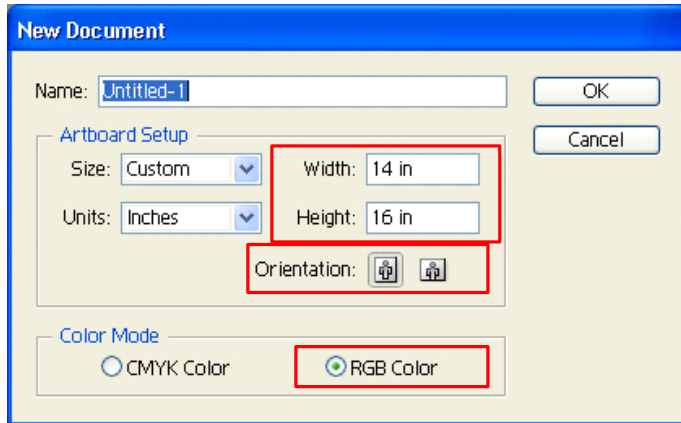

**Printing:**

- (1) Click "Print..." on "File" menu.
- (2) For the data made in RGB Color, make the settings as follows, and then click "OK":  
Print Space/ Profile: Same As Source  
Make sure Source Space is either "sRGB IEC61966-2.1" or "Untagged RGB".

For the data made in CMYK Color, select "sRGB IEC61966-2.1" for the Profile of Print Space, and then click "OK".

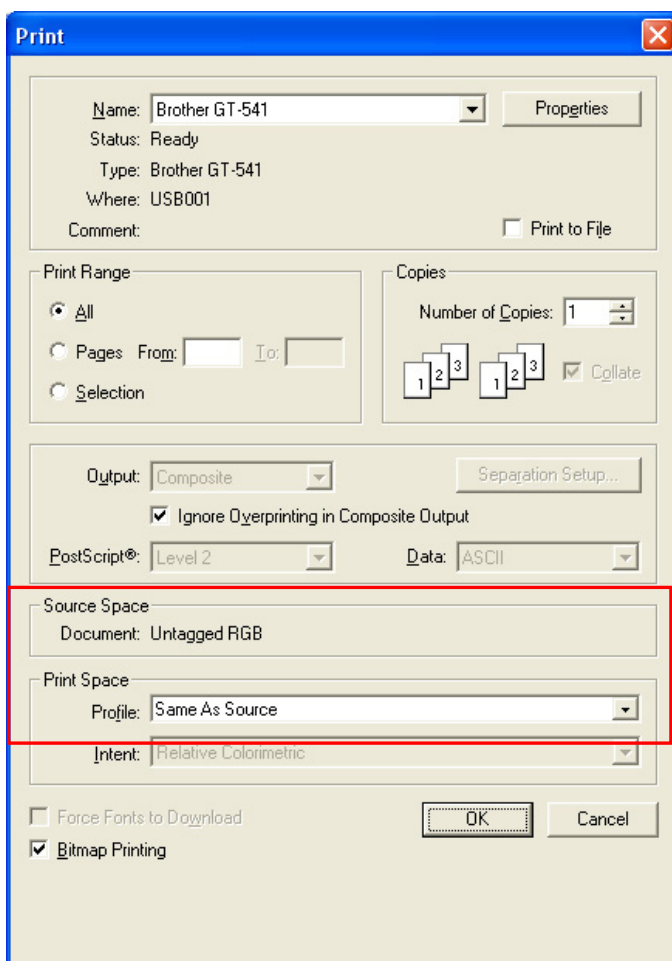

When the print data has been sent to your printer and ready to be printed, the Print Button on your printer's Control Panel turns on.

**<Important!>**

- If "Use Print Setup" is selected as the Artboard and "Single Full Page" is selected as the View in "Document Setup" window, proper print image will not be sent to your printer. If you want to use "Use Print Setup", apply "Tile Full Pages" or "Tile Imageable Areas" as the View, and then select "Use Print Setup".
- The tile print is not available with your printer; only the last-received image will be printed.
- When printing a small image (especially an image smaller than 14 x 16 inches), the Platen Size may be set to Platen 10 x 12 automatically. Confirm the Platen Size in the Printer Driver window before you print.

- Do not check "Print to File" on Print window to make print files.
- An image that is smaller than 14 x 16 inches (e.g. a letter-size image) may not be printed on proper positions, or may result in errors. In this case, follow the steps below to solve these problems.
  - (1) Open "Document Setup" on "File" menu.
  - (2) Select "Artboard".
  - (3) Check "Use Print Setup", and then click "Print Setup...".

The Print Setup window appears.

If "Platen 14x16" is selected for "Size", temporarily change it to "Platen 10x12", and then click "OK".

If "Platen 10x12" is selected for "Size", temporarily change it to "Platen 14x16", and then click "OK".
  - (4) Click "OK" on the Document Setup window.
  - (5) Open "Document Setup" in "File" menu again, and select "Artboard".
  - (6) Click "Print Setup..." to open the Print Setup window.
  - (7) Change "Size" back to the original setting, and then click "OK".
  - (8) Click "OK" on the Document Setup window.

### 4-2-5. Setting Adobe Illustrator CS Print Condition

Color settings and print settings are required before printing. After the printer driver is installed, set the colors before editing the document.

**<Important!>**

- Set Brother GT-541 as the default printer before you go on to the following steps, otherwise, an image may be printed in the wrong direction, or wrong size, etc.
- Make the print data in RGB color mode to get the best color accuracy. Using the CMYK color mode image may result in dull, unclear print. Transforming it to RGB ("Document Color Mode" in "File" menu) may improve the result, but black, yellow, and violet cannot be printed accurately. We recommend you edit those colors or use Vivid Processing (see 4-3-4. Increasing the Vividness).

**Color settings:**

- (1) Select "Color Settings..." on "Edit" menu.  
The Color Settings window appears.
- (2) Make color settings as follows, and then click "OK".  
Advanced Mode: Check  
Working Spaces/ RGB: sRGB IEC61966-2.1  
Working Spaces/ CMYK: U.S. Web Coated (SWOP) v2  
Conversion Options/ Intent: Relative Colorimetric

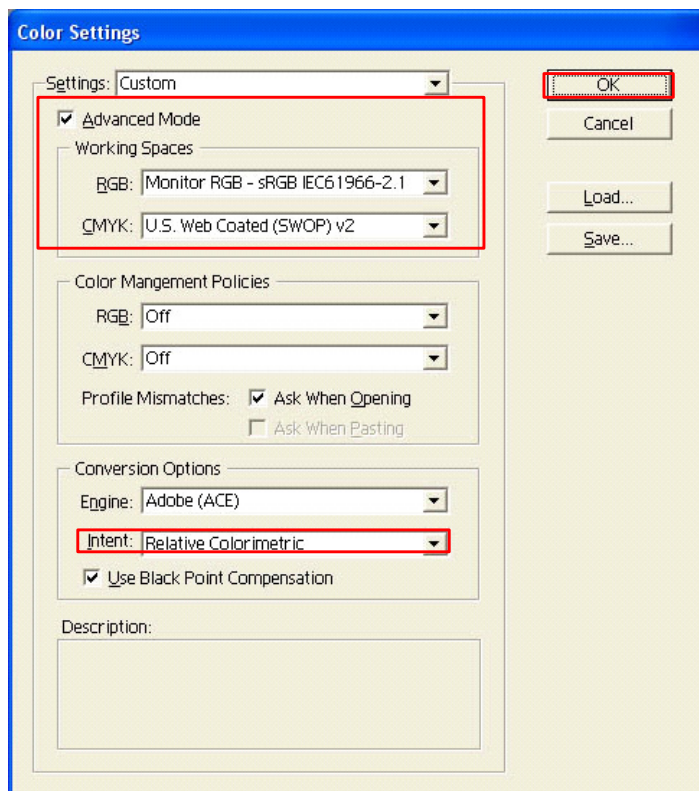

**Opening the new file:**

Set the New Document setting as follows:

Width: 14 in

Height: 16 in

Orientation: Portrait

Color Mode: RGB Color

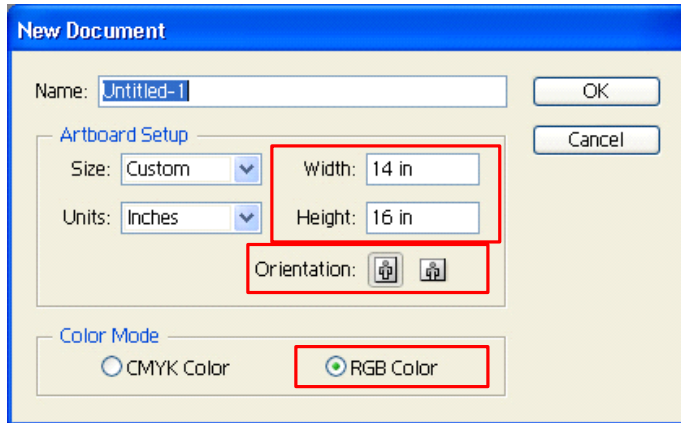

#### 4. Printing Directly from Applications

##### Printing:

(1) Click "Print..." on "File" menu.

The following window appears.

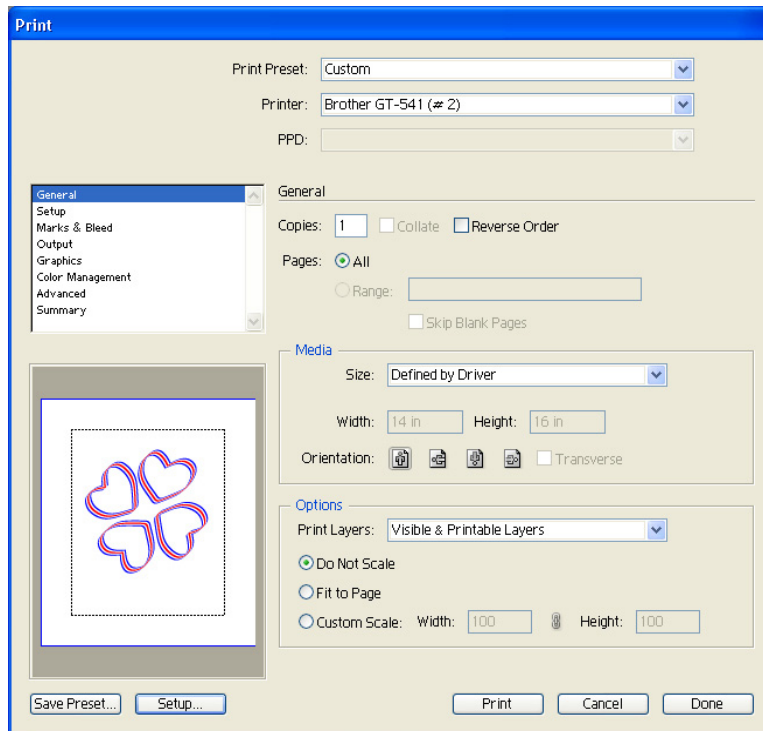

(2) Confirm that the Media size is 14 x 16 inches.

(3) Select "Color Management".

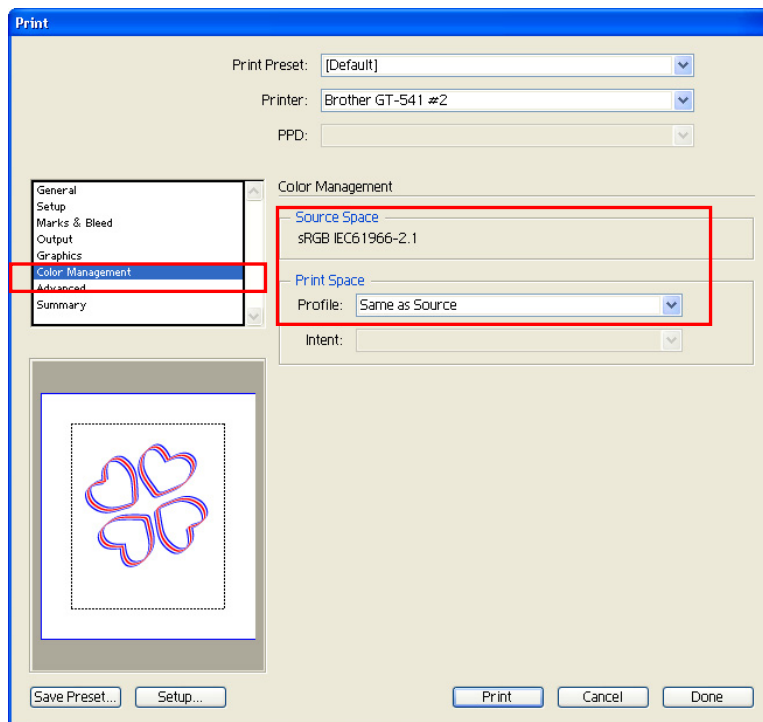

- (4) Confirm that the settings are as follows.

Source Space: “sRGB IEC61966-2.1” or “Untagged RGB”

Print Space/ Profile: “Same As Source” for the image made with RGB color mode, “sRGB IEC61966-2.1” for the image made with CMYK color mode

If you change any setting, click “Save Preset...” before going to the next step.

<Note>

CMYK color mode is not recommended. Use RGB color mode as much as possible.

- (5) Click “Setup”, and make the printer driver settings.

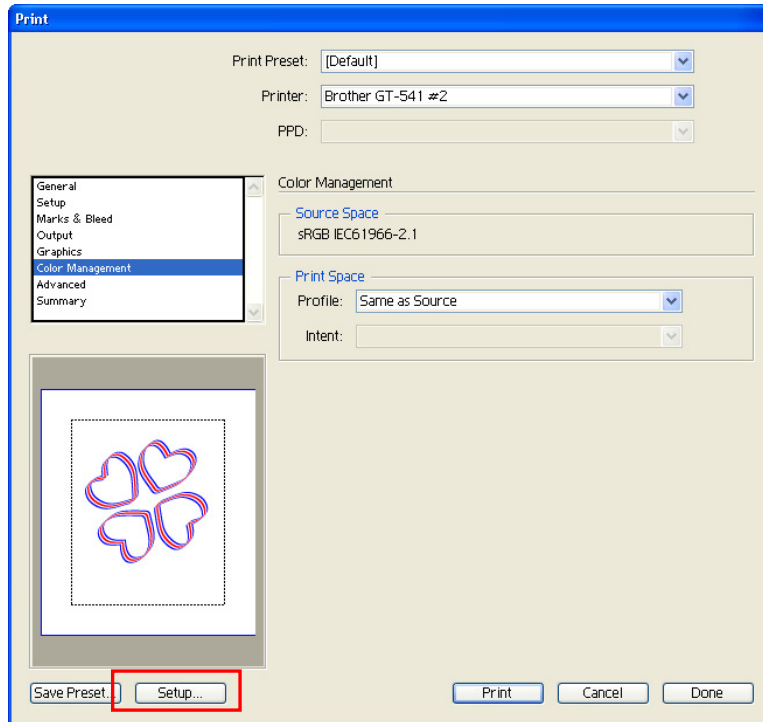

Click “Continue” when the following warning appears.

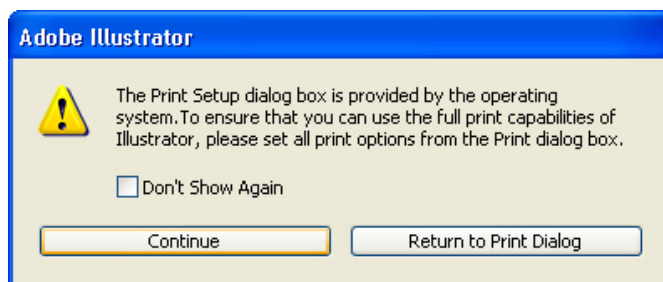

#### 4. Printing Directly from Applications

(6) The following window appears.

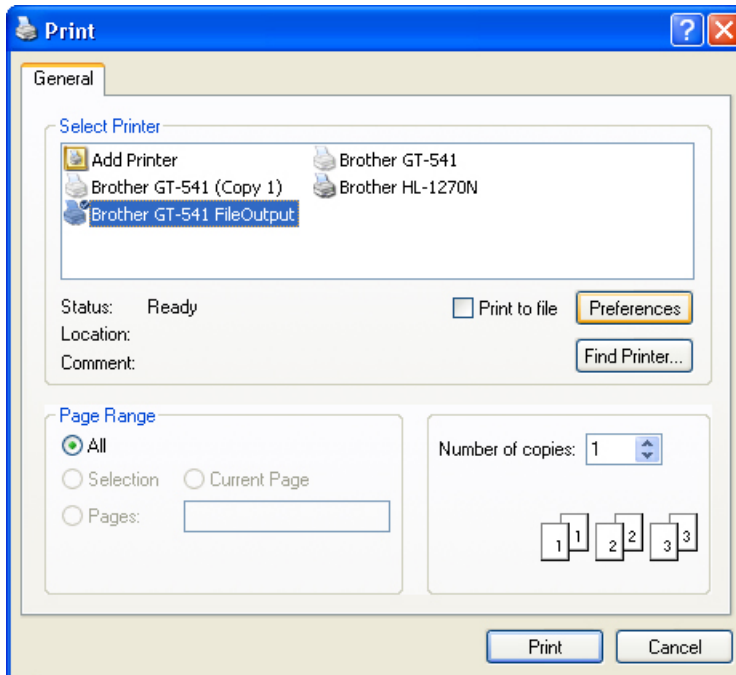

(7) Select the printer (Brother GT-541 FileOutput as selected in the example above), and then click "Preferences" to make the printer driver settings.



**<Important!>**

- If "Use Print Setup" is selected as the Artboard and "Single Full Page" is selected as the View in "Document Setup" window, proper print image will not be sent to your printer. If you want to use "Use Print Setup", apply "Tile Full Pages" or "Tile Imageable Areas" as the View, and then select "Use Print Setup".
- The tile print is not available with your printer; only the last-received image will be printed.
- When printing a small image (especially an image smaller than 14 x 16 inches), the Platen Size may be set to Platen 10 x 12 automatically. Confirm the Platen Size in the Printer Driver window before you print.
- Landscape images (horizontally long images) may not be printed properly. Check the preview on Print window, and if it is not correct, follow the procedure below to solve the problem.
  - (1) Confirm the Media Size in Print window is "Defined by Driver (it is set as default; do not change it)".
  - (2) Change the Orientation to portrait (vertically long).  
To change the Platen Size, go on to the next step. If not, skip to step (6).
  - (3) Click "Setup...". Click "Continue" when the warning window appears.
  - (4) Another Print window appears. Click "Preferences".
  - (5) Change the Platen Size on Printer Driver window, and then click "OK".
  - (6) Confirm the preview on the original Print window, and then click "Print".
- Do not check "Print to File" on Print window to make print files.
- An image that is smaller than 14 x 16 inches (e.g. a letter-size image) may not be printed on proper positions, or may result in errors. In this case, follow the steps below to solve these problems.
  - (1) Open "Document Setup" on "File" menu.
  - (2) Select "Artboard".
  - (3) Check "Use Print Setup", and then click "Print Setup...".  
The Print Setup window appears.  
If "Platen 14x16" is selected for "Size", temporarily change it to "Platen 10x12", and then click "OK".  
If "Platen 10x12" is selected for "Size", temporarily change it to "Platen 14x16", and then click "OK".
  - (4) Click "OK" on the Document Setup window.
  - (5) Open "Document Setup" in "File" menu again, and select "Artboard".
  - (6) Click "Print Setup..." to open the Print Setup window.
  - (7) Change "Size" back to the original setting, and then click "OK".
  - (8) Click "OK" on the Document Setup window.

### 4-2-6. Setting Adobe Photoshop Elements 3 Print Condition

Color settings and print settings are required before printing. After the printer driver is installed, set the colors before editing the document.

#### Color settings:

- (1) Select "Color Settings..." on "Edit" menu.  
The Color Settings window appears.
- (2) Select "Limited color management" – optimized for Web graphics", and then click "OK".

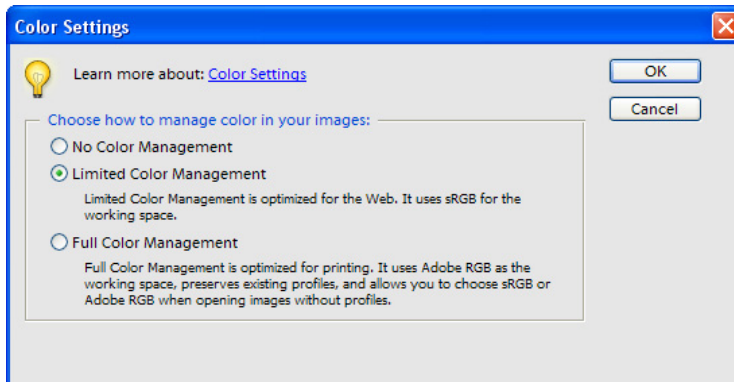

**Printing:**

- (1) Select "Print..." on "File" menu.  
The Print Preview window appears.
- (2) Make settings as follows.  
Show More Options: Check  
Print Space/ Profile: Printer Color Management

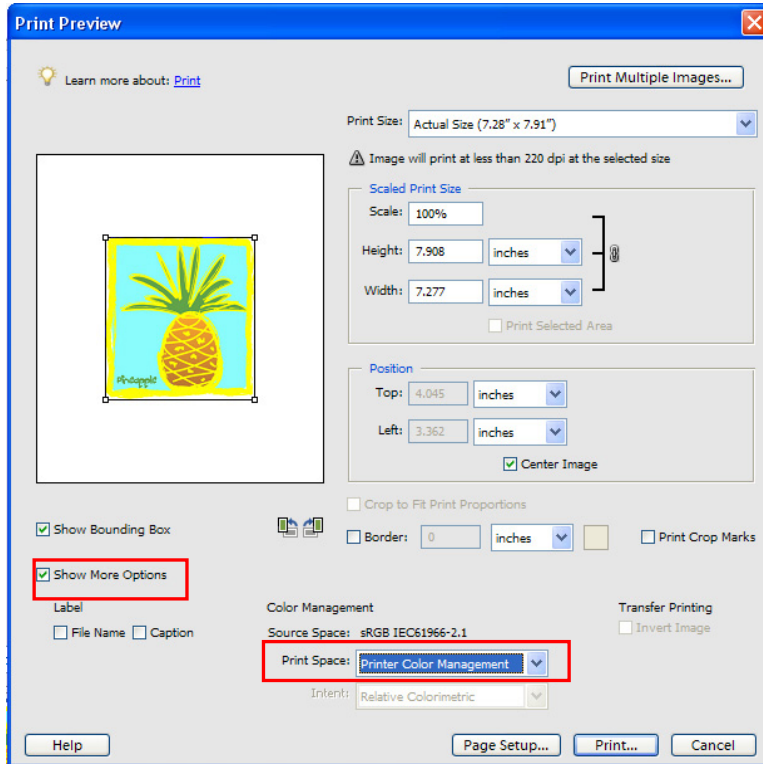

### 4-2-7. Setting Paint Shop Pro 9 Print Condition

Color settings are required before printing. After the printer driver is installed, set the color before editing the document.

#### Color settings:

- (1) Select "Preferences" on "File" menu.
- (2) Select "Color Management".  
The Color Management window appears.
- (3) Uncheck "Enable Color Management", and then click "OK".

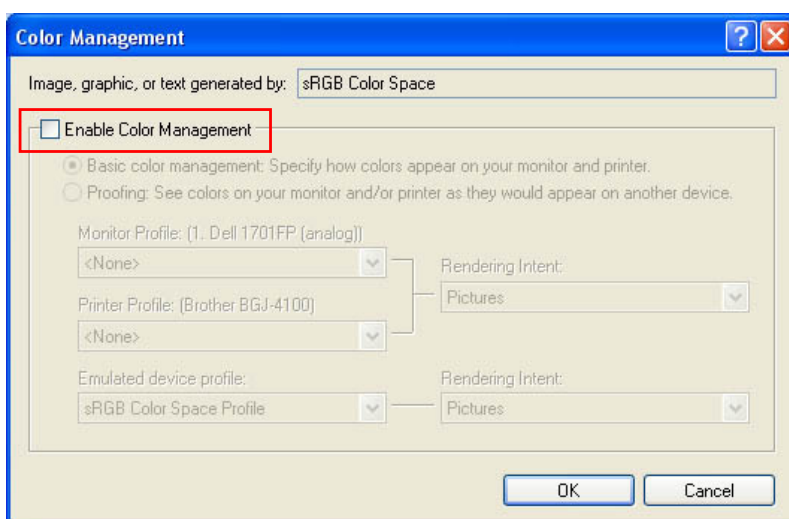

#### <Important!>

Leaving the Job Comment blank displays "PSP PRINT (indicates the application name)" on your printer's display. If you have entered the Job Comment, it will be displayed.

### 4-2-8. Printing From Other Applications

#### <Note>

Your printer does not support other application officially. We assume no responsibility for any problem caused by using other applications.

Print in sRGB for most images with no special color settings.

- (1) Select "Brother GT-541" as the printer to be used.
- (2) Make necessary settings and follow the instruction of the application to make a print.  
The Print Button on your printer's Control Panel turns on if the data has been sent successfully.

#### **4-2-9. Common Notice for All Applications**

**If you want to cancel printing the image you have sent to your printer:**

Your printer does not start printing until you press the Print Button; you can replace the print data by sending the new data (your printer holds only one print data received most recently).

**<Important!>**

*Do not execute canceling command from "Printer and Faxes (for Windows XP)" / "Printers (for Windows 2000)" in "Control Panel". Doing so causes an error and you may have to restart your printer.*

**If you want to print ARP files:**

Use "GT-541 FileOutput" for the printer (the printer designed for saving print data in ARP format). See "5. Printing ARP Files" for the details.

**<Important!>**

*Do not use "Print to File" command in the applications' Print window.*

**If you want to set the print condition in your PC's Control Panel:**

The settings made in your PC's Control Panel may not be applied to the application. If so, make the settings again in the menu of printer driver; these are applied to the actual settings.

**<Note>**

*The settings made in the menu of printer driver may not be applied depending on the application.*

### 4-3. Setting the Printer Driver Condition

Set the printer driver condition following the procedure below.

- (1) Select "Print" on "File" menu of the graphic application.

The Print window appears.

- (2) Select "Brother GT-541" for the printer, and then click "Properties".

The following window appears: make the necessary settings, and then click "OK".

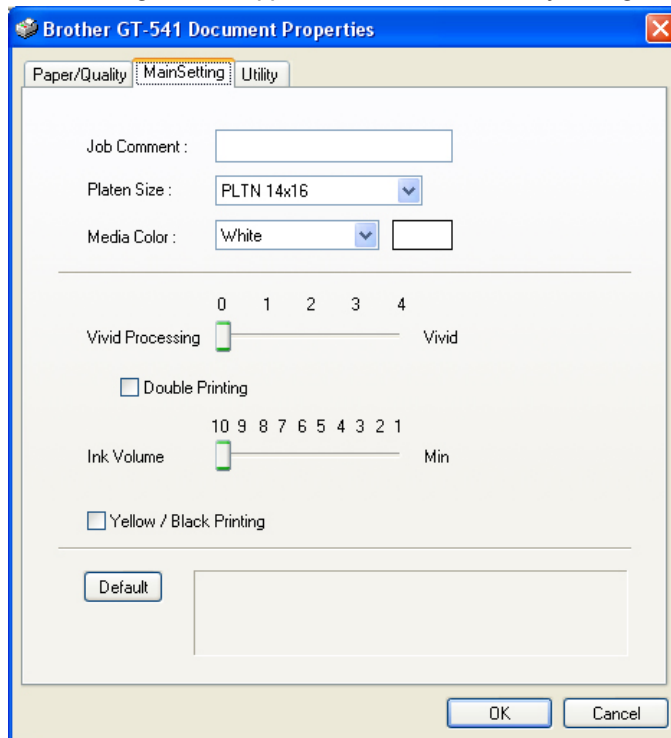

The following items can be set in this window.

- Job Comment (See "4-3-1. Entering the Job Comment".)
- Platen Size (See "4-3-2. Selecting the Platen Size".)
- Media Color (See "4-3-3. Setting the Media Color".)
- Vivid Processing (See "4-3-4. Increasing the Vividness".)
- Double Printing (See "4-3-5. Setting Double Print".)
- Ink Volume (See "4-3-6. Selecting the Ink Volume".)
- Yellow / Black Printing (See "4-3-7. Setting Yellow / Black Printing".)

Click "Default" to make all items to their defaults.

#### **4-3-1. Entering the Job Comment**

You can enter a comment (max. of 17 characters) to display on your printer's Control Panel. Use it to identify the print data, write an instruction on the print operation, and so on. Leaving it blank displays the last 17 characters of file name, application name, or nothing on the Control Panel, depending on the application you are using.

#### **4-3-2. Selecting the Platen Size**

Select the appropriate Platen size from the pull-down menu.

*<Note> A print data made for the Platen 14 x 16 cannot be printed using the Platen 10 x 12.*

#### **4-3-3. Setting the Media Color**

To reproduce the color on a T-shirt, you need to specify the color of T-shirt: then your printer automatically adjusts the color suitable for it. Select "White", "Pink", "Yellow", "Blue", or "Gray" from the pull-down menu.

#### **4-3-4. Increasing the Vividness**

Use this function to increase the vividness of an image. Slide the "Vivid Processing" tab to select 0 (almost the same vividness as shown on the display), 1 (increases the vividness one level without changing the tone; suitable for photo images), 2 (increases the vividness two levels; select this to print photo images most vividly), 3 (increases the vividness three levels; suitable for illustrated images), or 4 (increases the vividness four levels; also suitable for illustrated images).

The bigger the number is, the more vivid the image is printed.

#### **4-3-5. Setting Double Printing**

Check the Double Printing to print an image clearer and sharper by widening the color gamut. This is recommended especially for black and white images.

*<Note>*

*When you are using this function, you cannot select the "Ink Volume" or "Yellow / Black Printing".*

### 4-3-6. Selecting the Ink Volume

To get the best print result, you may need to adjust the amount of ink depending on the fabric of the T-shirt.

Select the best ink volume by sliding the Ink Volume tab.

To select the proper Ink volume, we recommend you to print "Ink volume check pattern" following the procedure below.

- (1) Select the Utility tab.

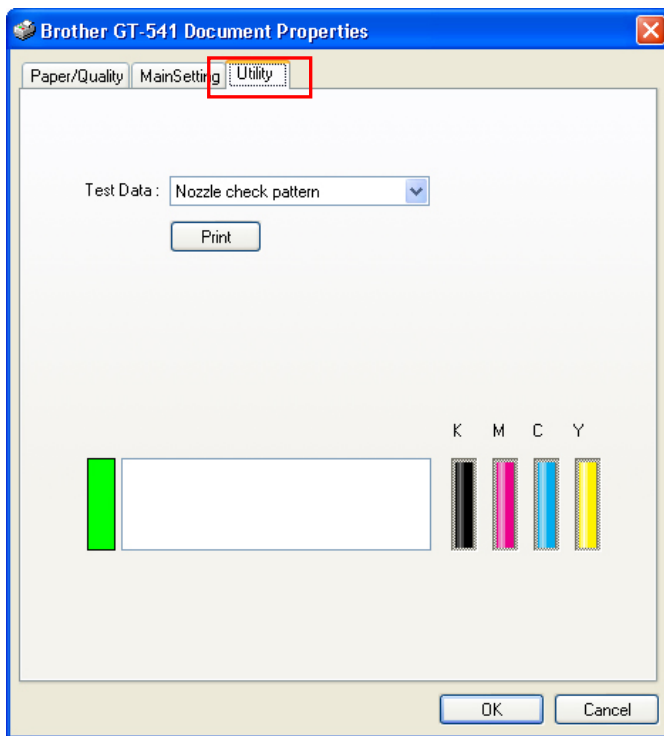

- (2) Select "Ink volume check pattern" from the pull down menu, and then click "Print" to send the data to your printer.
- (3) Set the Platen selected in the Main Setting tab.  
See "4-4. Uninstalling / Installing the Platen".
- (4) Place the T-shirt you want to test on the Platen.  
See "4-5. Placing the T-shirt on the Platen".
- (5) Press the Print Button on your printer's Control Panel to start printing the "Ink volume check pattern".
- (6) Remove the T-shirt from the Platen.  
See "4-7. Removing the T-shirt From the Platen".
- (7) Set the ink onto the T-shirt using the Heat Press.  
See "4-8. Setting the Ink onto the T-shirt".



Check the printed pattern.

Select the one printed most deeply without ink bleeding. The number below is the appropriate ink volume to choose for the fabric.

Example 1

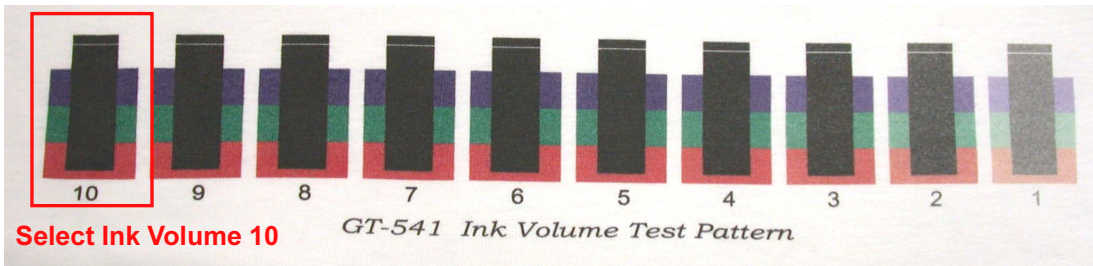

Example 2

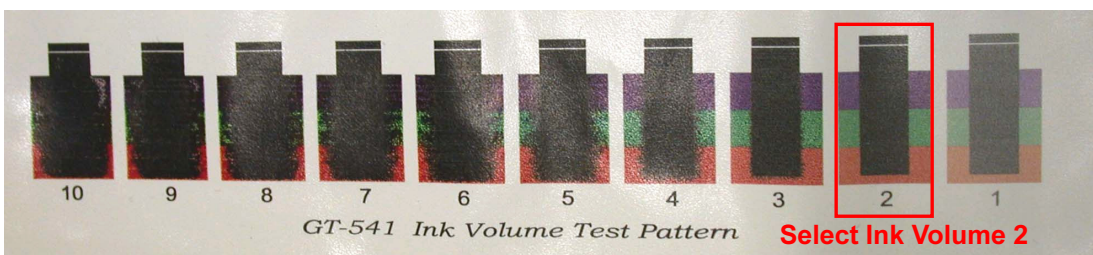

### 4-3-7. Setting Yellow / Black Printing

Printing an image that has black next to yellow may make smudges on the image. If this happens, check the Yellow / Black Printing check box to solve the problem.

Checking the Yellow / Black Printing prints with yellow ink first, and then prints with other colors, which minimize the smudges.



Yellow / Black Printing off



Yellow / Black Printing on

<Note> When you are using this function, you cannot select the "Double Printing".

---

## 4-4. Uninstalling / Installing the Platen

Replace the Platen to the size you have selected in “4-3-2. Selecting the Platen Size”.

### 4-4-1. Uninstalling the Platen

- (1) Press the Platen Button to eject the Platen, if it is stored.
- (2) Loosen the Platen Fixing Lever underneath the Platen.

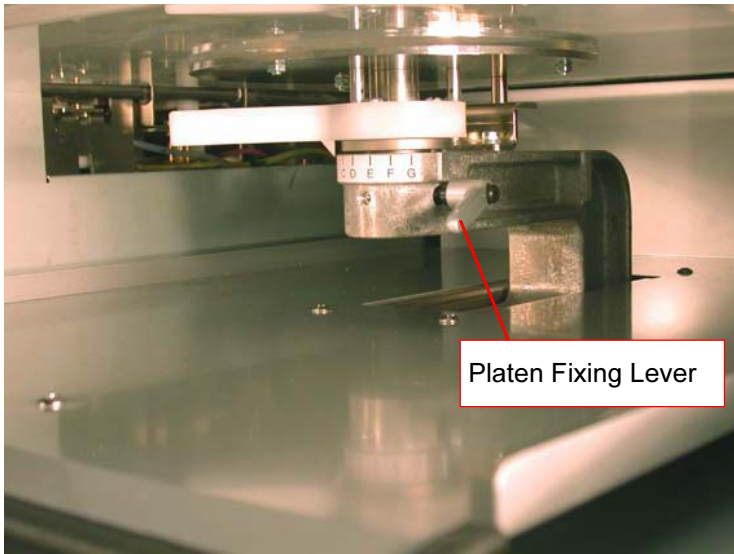

- (3) Uninstall the Platen by lifting it up straight.

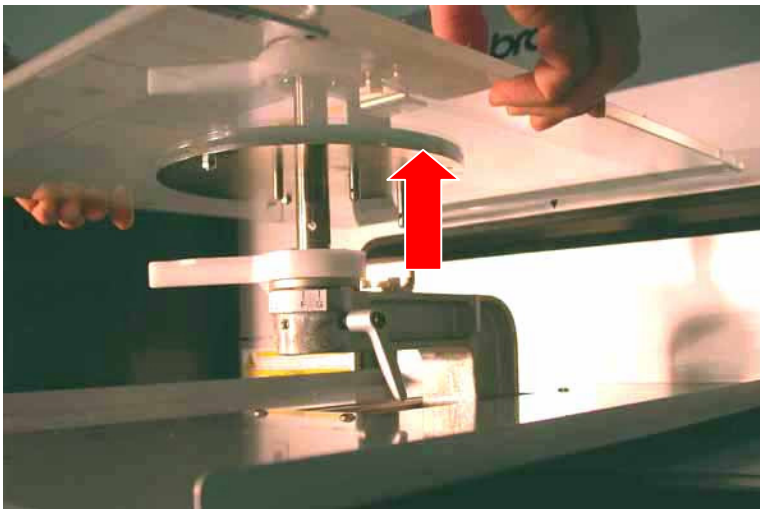

### 4-4-2. Installing the Platen

- (1) Install the Platen.

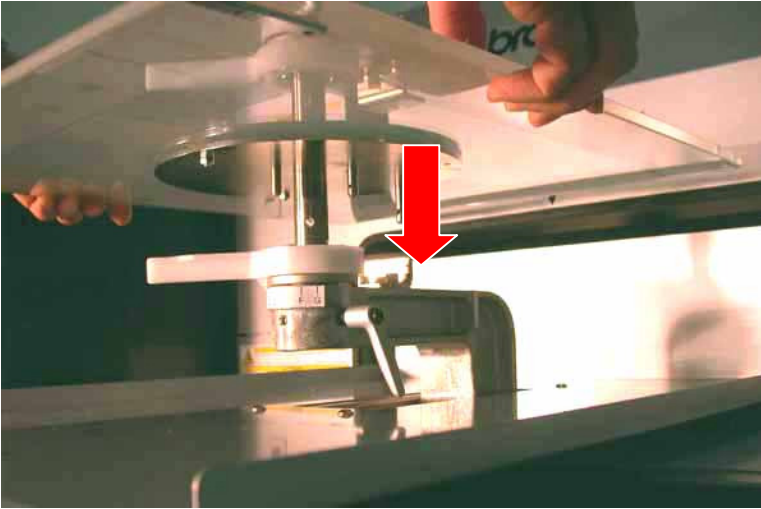

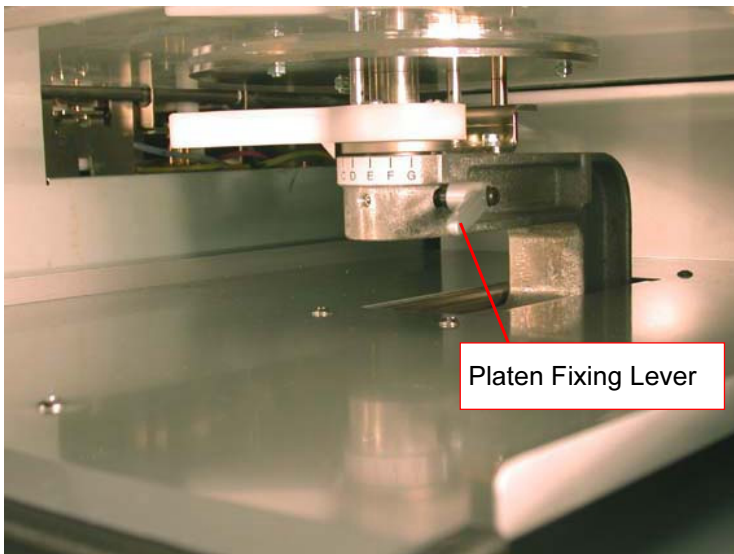

- (2) Tighten the Platen Fixing Lever securely.



## 4-5. Placing the T-shirt on the Platen

**⚠ CAUTION**

 Leave sufficient space at the front of the printer, and avoid placing items in front of it, otherwise the platen may hit them and be damaged, and if your hands get caught between the platen and the object, injury may result.

 Release your hand from the platen while the printer is operating. If your hand gets caught between the platen or the T-shirt tray and the covers, injury may result.

 Do not push nor pull the platen by hands quickly.  
It must be a cause of operation troubles or failures of printed circuit boards.

To get the quality print result, you need to adjust the Platen height depending on the thickness of the T-shirt.

<Note>

*Printing with inappropriate Platen height results in unclear print, or makes smudges on a T-shirt.*

- (1) If the Platen is not ejected, press the Platen Button to eject it.
- (2) Gently turn the Platen Height Adjustment Lever to the left until it stops.

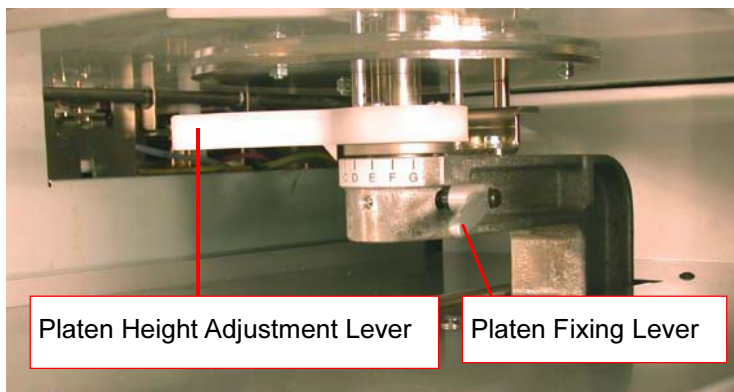

<Note> Do not turn it by force.

- (3) Loosen the Platen Fixing Lever.
- (4) Turn the Platen Height Adjustment Lever to the "A" (leftmost) position that is suitable for most T-shirts.
- (5) Tighten the Platen Fixing Lever securely.

- (6) Place the T-shirt, with its print side on the top of Platen and the other side underneath the Platen, as shown below.



- (7) Smooth wrinkles with your hands. It is easier if you move your hands from the center of T-shirt.  
<Note>
- If the surface of T-shirt is not smooth enough, the Obstruction Sensor may be activated, or result in poor print quality.
  - When placing a thick fabric such as a sweatshirt, keep its surface as flat as possible.
- (8) Keep all portions of the T-shirt hanging from the Platen on the T-shirt Tray.



- (9) Press the Platen Button to insert the Platen, and check the space between the Obstruction Sensor and the T-shirt.  
If the Platen height is appropriate, the space is 2.0 mm to 3.0 mm.  
<Note>  
Make sure you check the space when the Platen is moving, since Obstruction Sensor changes its height when the Platen stops moving.



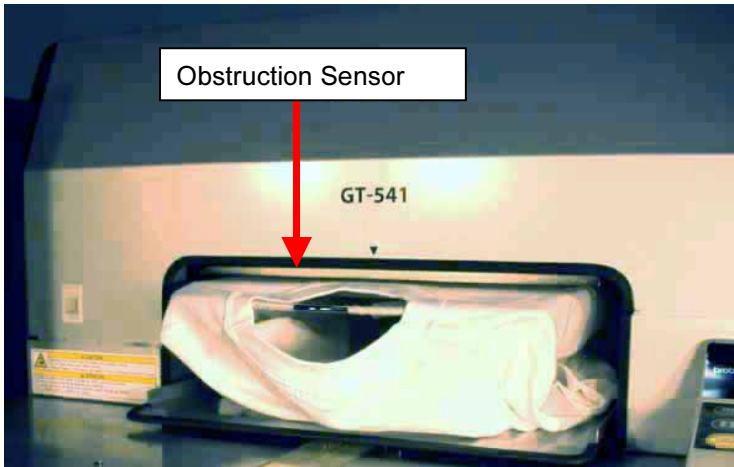

#### 4. Printing Directly from Applications

*If the Platen height is too high, the T-shirt, Print Head, or both of them may be damaged when printing.*



- (10) Press the Platen Button to eject the Platen.  
If the Platen height is appropriate, you can go to "4-6. Printing" to start printing.  
If the Platen height is not appropriate, go on to the following steps to adjust it.
- (11) Loosen the Platen Fixing Lever.
- (12) Adjust the Platen height by turning the Platen Height Adjustment Lever.  
The "A" position is the highest. The Platen lowers as you turn the Platen Height Adjustment Lever to the right.
- (13) Tighten the Platen Fixing Lever securely.
- (14) Repeat steps (9) and (10) and check the Platen height.  
Repeat steps (11) to (14) until the Plate height becomes appropriate.

## 4-6. Printing

 <b>CAUTION</b>	
	Leave sufficient space at the front of the printer, and avoid placing items in front of it, otherwise the platen may hit them and be damaged, and if your hands get caught between the platen and the object, injury may result.
	Release your hand from the platen while the printer is operating. If your hand gets caught between the platen or the T-shirt tray and the covers, injury may result.
	Do not push nor pull the platen by hands quickly. It must be a cause of operation troubles or failures of printed circuit boards.
	Do not put your hands inside the covers while the printer's power is turned on, otherwise your hands may touch against moving parts and this may result in injury.

### 4-6-1. Making One Print

- (1) Make sure the Print Button has been turned on, which indicates your printer has received the print data successfully.

If it is not on, send the print data before going to the next step.

<Note>

*Your printer cannot receive a print data when printing or when the Menu Display is on. Do not send a print data from your PC in these cases.*

- (2) If the Platen is not ejected, press the Platen Button to eject it.
- (3) Confirm the Job Comment on the Display.
- (4) Press the Print Button to start printing.

When the printing is completed, the Platen is ejected and the alarm sounds.

You can cancel printing by pressing the Stop Button.

<Note>

- *By pressing the Print Button, your printer automatically starts cleaning the Print Head every 24 prints (default) or every numbers of prints you have set (see "7-2-5. Changing the Auto Head Cleaning Setting"), or after your printer has not been used for more than two hours. In this case, wait until the cleaning completes (takes about 20 seconds), and then printing will automatically start.*
- *Do not stand or place anything within the range of the Platen movement; it is ejected when printing is completed.*
- *If the Platen is not at the appropriate position, it cancels printing and automatically adjusts the position as you press the Print Button. In this case, wait until the Platen stops moving, and then press the Print Button again to start printing.*
- *Do not open unlock or open the Cover during printing.*
- *Press the Stop Button to cancel printing.*

#### **4-6-2. Printing More than One Print Using the Same Print Data**

After making one print following the procedure in “4-6-1. Making One Print”, you can continue making more prints using the same print data.

- (1) If the fabric of the T-shirt is changed, set the necessary print condition (see “4-3. Setting the Printer Driver Condition”) before you print.
  - (2) Place the T-shirt on the Platen. See “4-5. Placing the T-shirt on the Platen” for the details.
  - (3) Press the Print Button to start printing.
- 

#### **4-7. Removing the T-shirt From the Platen**

*<Note> Be careful not to get ink on your hands or clothing.*

- (1) Let some air between the T-shirt and the Platen from the neckline of the T-shirt.
  - (2) Hold both shoulders of the T-shirt, and then pull it out straight from the Platen.
- 

#### **4-8. Setting the Ink onto the T-shirt**

To set the ink onto the T-shirt, the heat treatment using the Heat Press is required. Follow the instruction manual that comes with your Heat Press.

*<Note>*

- *An appropriate heat treatment requires 356 °F (180 °C) of heat for 35 seconds.*
- *Insufficient heat treatment causes the washout or color staining of the printed image.*
- *Use the Heat Press in a place where you can ensure a good air ventilation.*
- *After using the Heat Press, always confirm if the ink is completely dry.*
- *Make sure the platen of the Heat Press is clean.*



## 5. Printing ARP Files

By making print data in ARP format, you can select the printing procedure by the following two ways.

- Print ARP files with GT File Viewer; this way, you can check the detailed print condition before sending a print data to your printer.
- Print ARP files saved in a CompactFlash; this way, your printer does not need to be connected to the PC.

### The procedure of printing ARP files:

- (1) Make print data in ARP format:  
See "5-1. Making Print Data in ARP Format".
- (2) Turn on your printer:  
See "3-2-1. Turning On Your Printer".
- (3) Send the ARP file to your printer using GT File Viewer or a CompactFlash:  
See "5-2. Reading ARP Files Saved in a Compact Flash" or "5-3. Sending ARP Files from GT File Viewer to your Printer".
- (4) Install the Platen:  
See "4-4. Uninstalling / Installing the Platen".
- (5) Place the T-shirt on the Platen and adjust the Platen height:  
See "4-5. Placing the T-shirt on the Platen".
- (6) Start printing:  
Press the Print Button on the Control Panel to start printing.
- (7) Remove the T-shirt from the Platen.  
See "4-7. Removing the T-shirt From the Platen".
- (8) Set the ink onto the T-shirt:  
Use the Heat Press to set the ink onto the T-shirt. See "4-8. Setting the Ink onto the T-shirt".
- (9) Turn off your printer:  
See "3-2-2. Turning Off Your Printer".

## 5-1. Making Print Data in ARP Format

<Note>

You cannot edit ARP files; we recommend you save the data in the original format as well.

- (1) Design a print data using an operationally approved graphic application. See “1-3-3. Software Information”.
- (2) Select "Print" on "File" menu of the application.  
Print dialog box appears.
- (3) Select “Brother GT-541 FileOutput ” for the printer (Brother GT-541 FileOutput is the printer used to save print data in ARP format), and click "Properties".  
The following window appears.

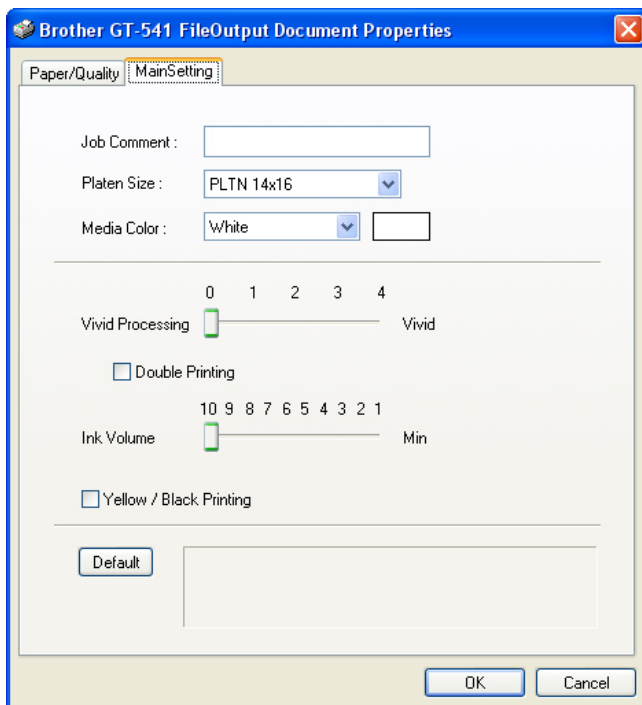

Set the following items in this window, and then click “OK”:

- Enter the job comment (see “4-3-1. Entering the Job Comment”).
- Select the Platen size (see “4-3-2. Selecting the Platen Size”).
- Select the media color (see “4-3-3. Setting the Media Color”).
- Increase the vividness if necessary (see “4-3-4. Increasing the Vividness”).
- Check Double Printing if necessary (see “4-3-5. Setting Double Print”).
- Select the ink volume (see “4-3-6. Selecting the Ink Volume”).
- Check Yellow / Black if necessary (see “4-3-7. Setting Yellow / Black Printing”).

Click “Default” to make all items to their default.

- (4) Follow the procedures in “4-2. Setting the Applications’ Print Condition”, as selecting “Brother GT-541 FileOutput” for the printer, and then click “Print” or “OK” on the application’s print window. Wait for a while until the following preview window appears.

**<Important!>**

Depending on the application or the image, it may take a long time to open the Preview window after clicking “OK” or “Print”. Do not click “Print” or “OK” again.

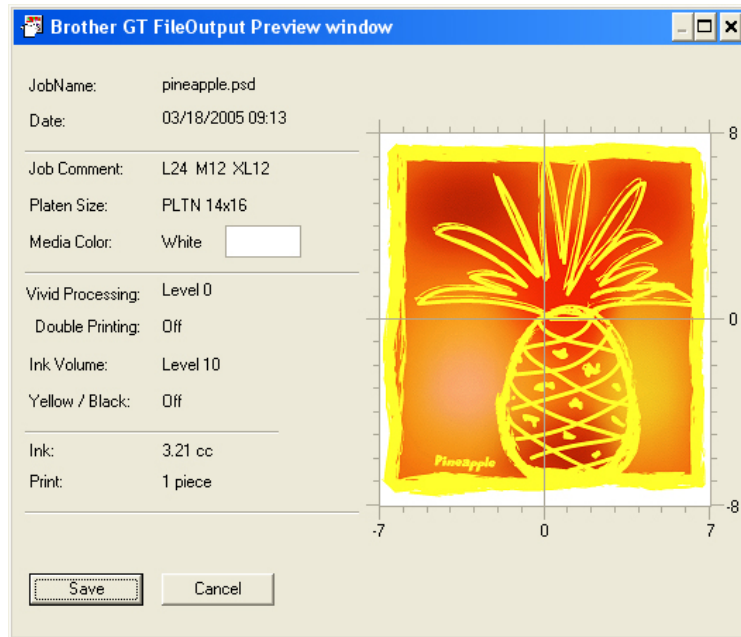

- (5) Click “Save”.  
The following window appears.

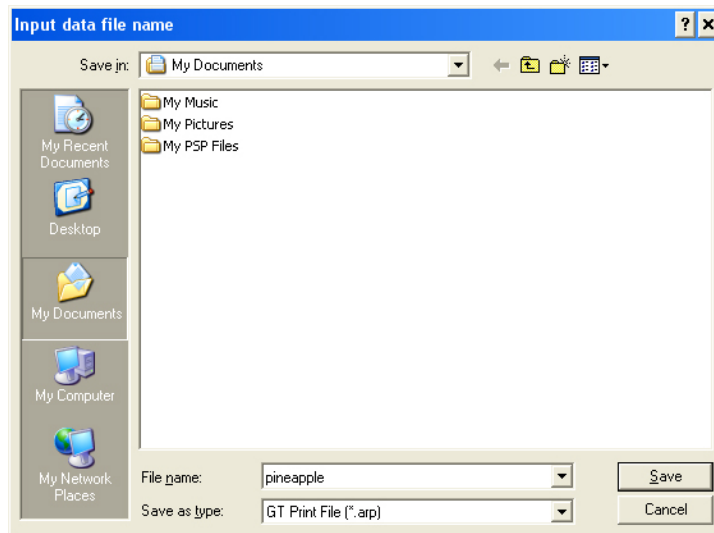

## 5. Printing ARP Files

- (6) Select where to save the data, enter the file name, select "GT-541 Print File (\*.arp)" as the file type, and then click "Save".

The ARP file is created and saved in the selected location.

**<Important!>**

Your printer cannot read files in a CompactFlash if it is saved in a folder. Save files directly under the drive.

**<Note>**

To read the file name of data saved in a CompactFlash and display it correctly on your printer's Display, the file name should be 8 characters or less.

---

## 5-2. Reading ARP Files Saved in a Compact Flash

**<Note>**

- Use a CompactFlash that meets the requirements (see "1-3-4. Other Requirements").
- Your printer can only read ARP files from a CompactFlash.
- Save ARP files directly in a CompactFlash without making folder beneath it.
- The names of ARP files must be less than 8 characters.

- (1) Open the CompactFlash Slot Cover and insert the CompactFlash, and then close the CompactFlash Slot Cover.

**<Note>** Do not insert the CompactFlash by force; it may destroy the data saved in it.

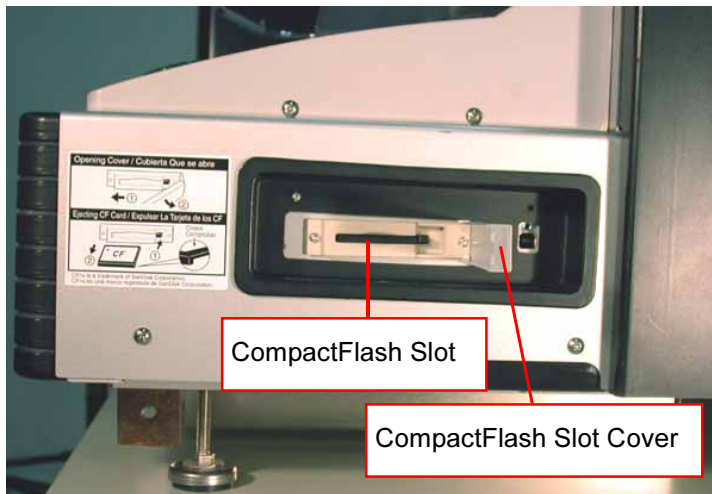

- (2) Press the OK Button on your printer's Control Panel.
- (3) Press the Up/Down Button to select "Card Data Load", and then press the OK Button.  
The file information (file names, Job Comments, Platen Sizes, etc.) of the data in the CompactFlash is displayed (one display per data).
- (4) Press the Up/Down Button to select the file to be printed, and then press the OK Button.  
Your printer starts reading the CompactFlash and the Print Button on your printer's Control Panel starts flashing.  
When the ARP file has been read, the alarm sounds and the Print Button turns on.

<Note>

- If a file name of the data saved in a CompactFlash cannot read properly, see “7-1. Solving Printer Problems”.
  - Do not touch the CompactFlash while the Print Button is flashing; it may destroy the data saved in it.
  - Reading the CompactFlash may take more than two minutes depending on the data sizes stored in it.
- (5) Pull out the CompactFlash when you have finished printing the data, and then close the CompactFlash Slot Cover.

### 5-3. Sending ARP Files from GT File Viewer to your Printer

- (1) Double-click the shortcut of GT File Viewer on the PC desktop.  
GT File Viewer opens.
- (2) Click “File” and select the ARP file you want to open, and then click “OK”.  
The file’s print condition and the preview appear in the following window.

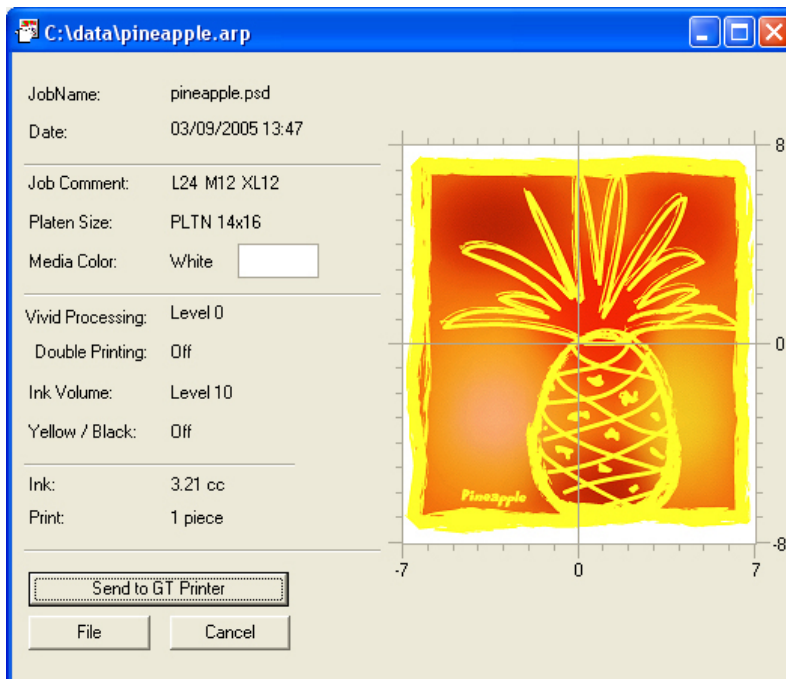

<Note>

You can open the ARP file by double-clicking it instead of doing steps 1 and 2.

## 5. Printing ARP Files

- (3) Confirm the print conditions, and then click “Send to GT Printer”.  
The ARP file has been sent to your printer, and the Print Button on your printer’s Control Panel turns on.

<Note>

*If more than one GT-541 are installed in you PC, the Select Printer window appears.  
Select the one to send the data to, and then click OK.*

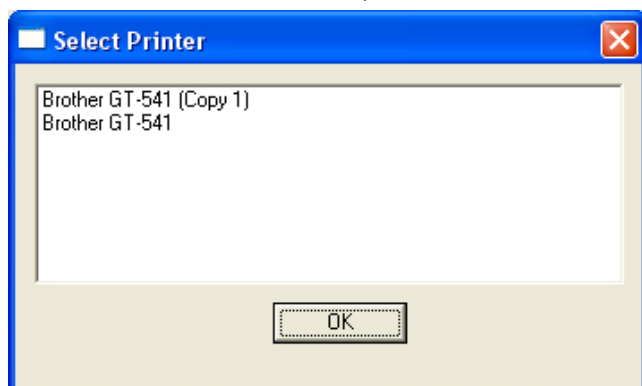

## 6. Maintenance

To keep your printer working properly and maintain the fine print result, appropriate maintenance is required.

### DANGER



Wait at least 5 minutes after turning off the power switch and disconnecting the power cord from the wall outlet before opening the cover of the control unit. Touching areas where high voltages are present can result in severe injury.

### WARNING



Do not put your hands in the ink cartridge slot, otherwise the needle inside the slot may cause injury.

### CAUTION



Wait at least 1 minute after turning off the power switch before opening the front cover. Touching the heat sink on the head can result in burns.



Be careful not to get your fingers caught when closing the front cover, otherwise it may result in injury to your fingers.



Do not push nor pull the platen by hands quickly. It must be a cause of operation troubles or failures of printed circuit boards.



Do not disassemble the ink cartridge or the waste ink cartridge. If the ink cartridge or waste ink cartridge is disassembled, it can no longer be used.



Take care not to let the ink, waste liquid or wash liquid come into contact with your eyes or onto your skin, otherwise inflammation can result.

Furthermore, do not drink the ink, waste liquid or wash liquid under any circumstances, as they can cause vomiting and diarrhoea.

Keep the ink, waste liquid and wash liquid out of the reach of children.



Use only the proper replacement parts as specified by Brother.

---

## 6-1. Replacing Consumables

This section describes how to replace the Ink Cartridge, Wiper Cleaner, Waste Ink Cartridge, and Platen Sheet.

### 6-1-1. Replacing an Ink Cartridge

The ink indicator on the Display blinks when the Ink Cartridge is getting low. Prepare the new Ink Cartridge, and replace it when "EMPTY XXXX (color)" is displayed.

<Note>

- Use the Ink Cartridges described in "1-3-5. Consumable Requirements".
- Be careful not to get ink on your hands or clothing.
- Do not replace cartridges while printing or head cleaning; it may cause damage to your printer.
- Do not disassemble the Ink Cartridge.
- To keep the best print result, your printer will show empty status for the color cartridge that is empty. At this point you will need to replace with a new Ink Cartridge. Ink Cartridge will not be totally empty. A small amount of ink remains to avoid damage to your printer.

- (1) Remove the new Ink Cartridge from its packing.
- (2) Carefully pull out the used Ink Cartridge from your printer.

<Note>

- Leave the used Ink Cartridge installed until just before the replacement. Leaving your printer with no Ink Cartridge installed may cause ink leakage.
- Do not put your finger to the Ink Cartridge Slot; otherwise the needle attached to it may injure you.

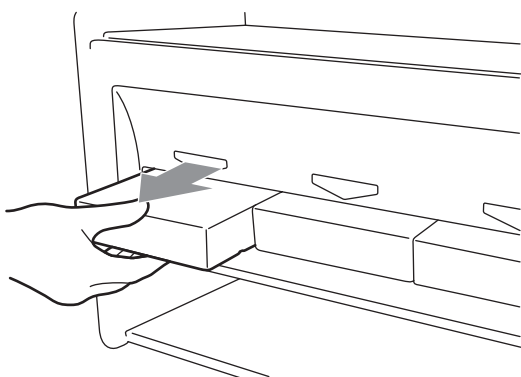



- (3) Insert the new Ink Cartridge securely (be careful with the direction).

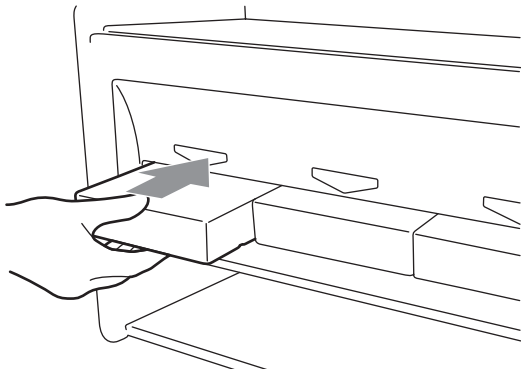

<Note>

Confirm the color of ink. Loading a wrong color of ink causes damage to the Print Heads.

If you have installed a wrong color of ink, immediately contact Brother Customer Service Hot Line.

- (4) If you have replaced the Yellow Ink Cartridge, you need to replace the Wiper Cleaner attached to it. See "6-1-2. Replacing the Wiper Cleaner".

<Note>

- Do not repeat uninstalling/ installing the Ink Cartridge.
- Dispose the used Ink Cartridge in compliance with your local regulations.

### 6-1-2. Replacing the Wiper Cleaner

The Wiper Cleaner is attached to the Yellow Ink Cartridge, and it needs to be replaced when the Yellow Ink Cartridge is replaced. Always clean the Print Head Cap and Wiper Blade when replacing the Wiper Cleaner.

- (1) Turn on your printer if it is off.  
 (2) Press the OK Button to open the Menu Display.

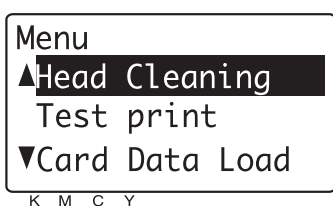

- (3) Press the Up/Down Button to select the "Maintenance", and then press the OK Button.  
 (4) Press the Up/Down Button to select the "Cap/Wiper Clean", and then press the OK Button.  
 The following message appears.

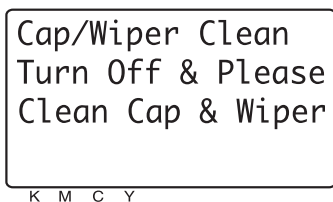

- (5) Turn off your printer.

- (6) Open the Front Cover by unlocking the Cover Locks.

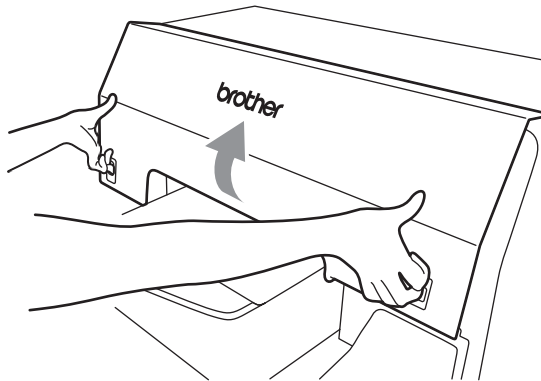

- (7) Pull out the Wiper Cleaner Cassette.

<Note>

- Do not tilt the Wiper Cleaner Cassette; ink may get on your hands or clothing.
- Do not touch the Clearance Sensor (the bar above the Wiper Cleaner Cassette); it may cause a malfunction.

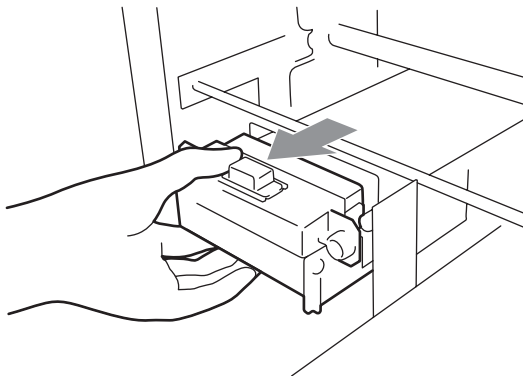

- (8) If the ink inside of the Wiper Cleaner Cassette is soiled with ink:  
Wear gloves and remove the ink with a dry cloth, and then clean with a cloth damped with water.

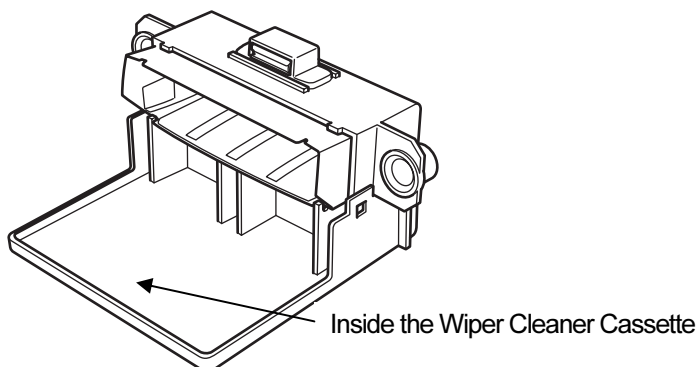

- (9) Push both sides of the Wiper Cleaner Cassette to open it.

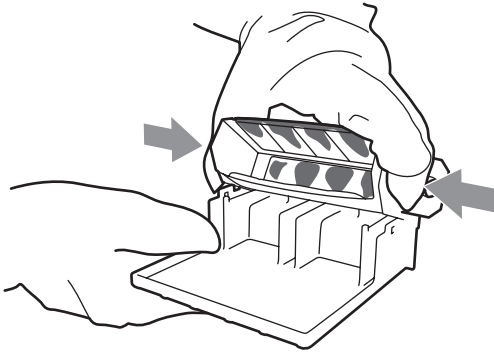

- (10) Carefully drop off the used Wiper Cleaner in a trash can/bag by turning it upside down.

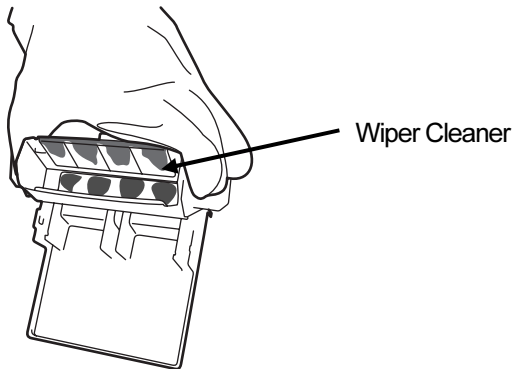

<Note>

*Dispose the used Wiper Cleaner in compliance with your local regulations.*

- (11) Insert the two projections of the Wiper Cleaner Cassette into the holes on the new Wiper Cleaner.

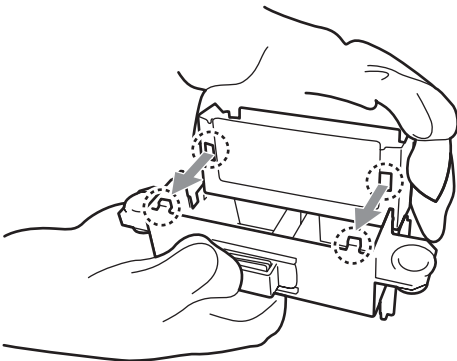

- (12) Close the Wiper Cleaner Cassette.

Make sure that the bottom of the Wiper Cleaner is set within the two projections on the Wiper Cleaner Cassette.

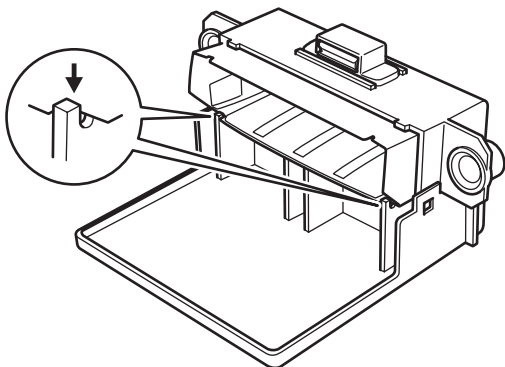

- (13) Open the Cap Cleaning Kit. It comes with the new Yellow Ink Cartridge.

The following items are included.

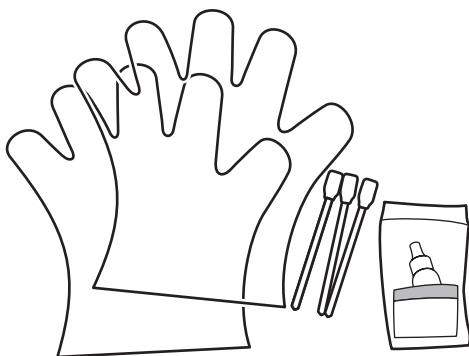

- (14) Wear the gloves, and wet both sides of a Clean Applicator with the Wash Liquid.

<Note>

*Use only the Wash Liquid included to wet the Clean Applicators; using other liquid will cause damage to the Print Heads.*

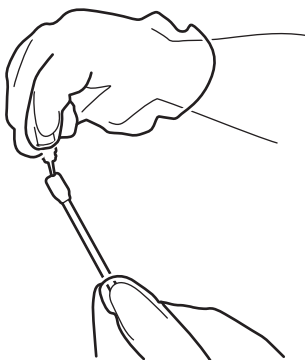

- (15) Use the one side of wet Clean Applicator to clean the front side of the Wiper Blade.

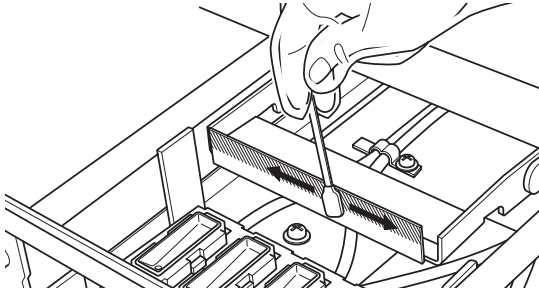

- (16) Use the other side of the wet Clean Applicator to clean the backside of the Wiper Blade.

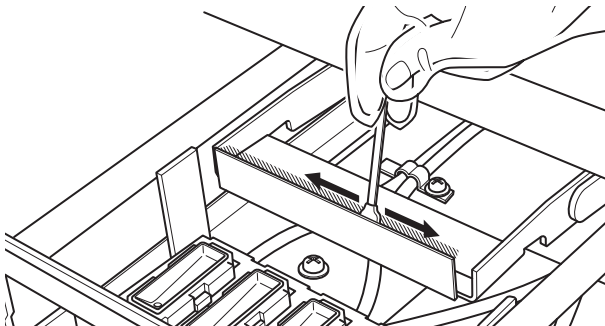

- (17) Wet other two Clean Applicators and use them to remove ink or dust from the Print Head Caps.  
Use one side of the Clean Applicator to clean one Print Head Cap.

<Note>

*Do not use the dry Clean Applicator; it cannot clean ink or dust. It may damage the Print Head Caps.*

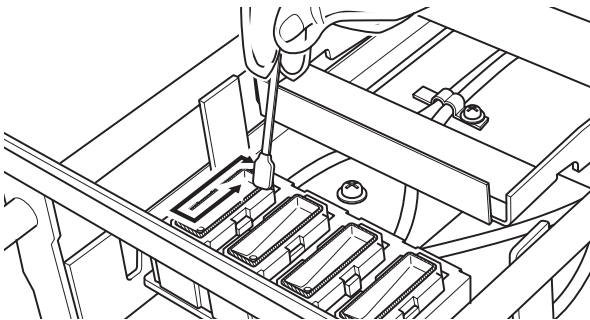

(18) Insert the Wiper Cleaner Cassette straight into your printer.

<Note>

Do not touch the Clearance Sensor (the bar above the Wiper Cleaner Cassette); it may cause a malfunction.

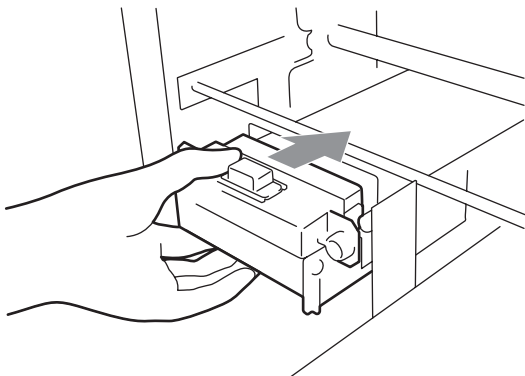

(19) Close the Front Cover, and then turn on your printer.

If your printer turns on without any problem, replacement of the Wiper Cleaner Cassette has been completed.

If there is problem (abnormal noise or error), turn off your printer, and check if the Wiper Cleaner and the Wiper Cleaner Cassette are correctly installed.

### 6-1-3. Replacing the Waste Ink Cartridge

When the message "WARNING WASTE INK FULL" is displayed, prepare the new Waste Ink Cartridge, and replace it when the message "ERROR WASTE INK FULL" is displayed.

<Note>

- Do not replace the Waste Ink Cartridge while printing or head cleaning. It may contaminate the inside of your printer, which may cause damages to your printer.
- Be careful not to get ink on your hands or clothing when you handle the Waste Ink Cartridge.

(1) Pull out the Waste Cartridge Tray.

The message "ERROR NO WASTE INK TRAY" is displayed.

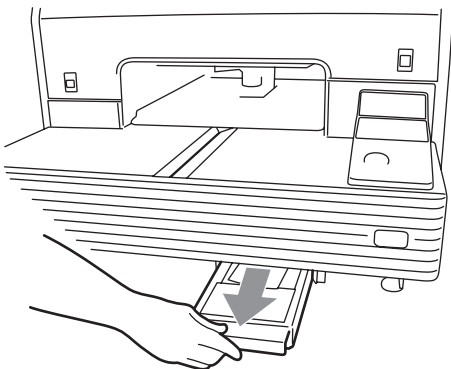

- (2) Remove the sticker on the used Waste Ink Cartridge, and use it to seal the hole on it.

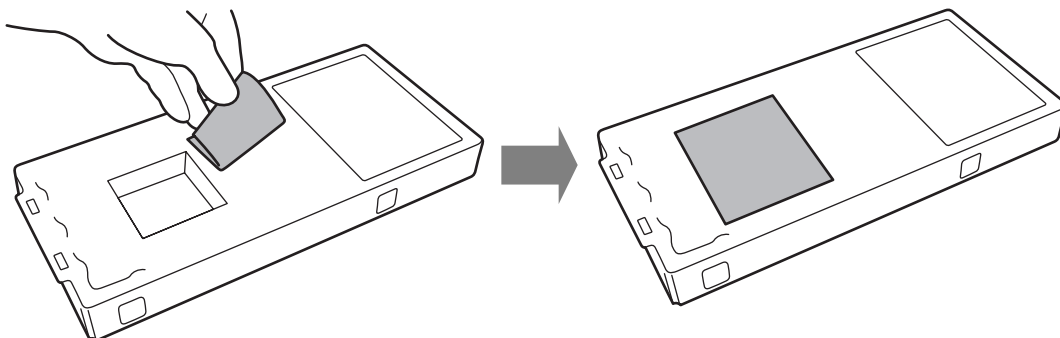

- (3) Remove the new Waste Ink Cartridge from its package.  
<Note> Save the package for later use.
- (4) Remove the used Waste Ink Cartridge from the Waste Cartridge Tray, and put it in the package, in which the new Waste Ink Cartridge came in.
- (5) Install the new Waste Ink Cartridge in the Waste Cartridge Tray.

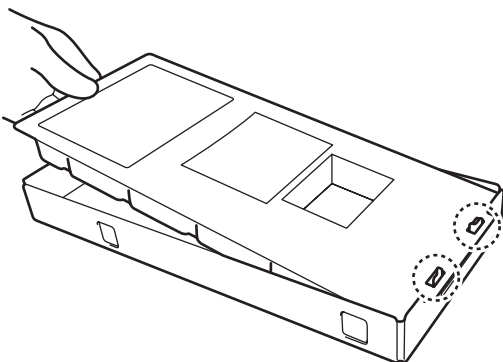

- (6) Install the Waste Cartridge Tray.

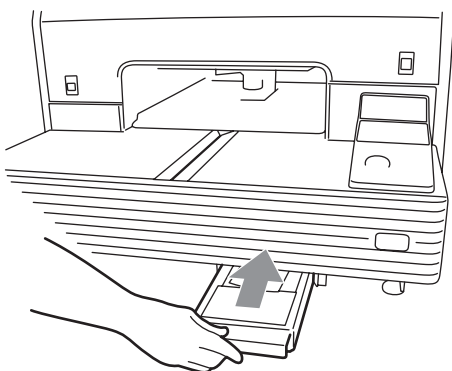

The replacement of the Waste Ink Cartridge has been completed.

<Note> Dispose the used Waste Ink Cartridge in compliance with your local regulations.

### 6-1-4. Replacing the Platen Sheet

The Platen Sheet gets soiled as you repeat printing. If this happens, please replace the Platen Sheet to avoid making smudge on a T-shirt.

- (1) Press the Platen Button to eject the Platen.
- (2) Remove the Platen Sheet and the adhesive tape from the Platen.

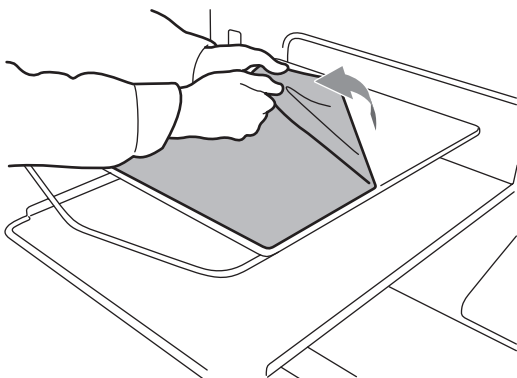

- (3) Clean the surfaces of the Platen using a soft cloth damped with mild detergent, and then wipe it using a soft and dry cloth.
- (4) Make sure the surface of the Platen is completely dry, and then put the new Platen Sheet on the Platen. It is easier if you peel off the release-coated paper little by little as you put the new Platen Sheet.

<Note>

*Put the Platen Sheet straight against the Platen without making creases.*

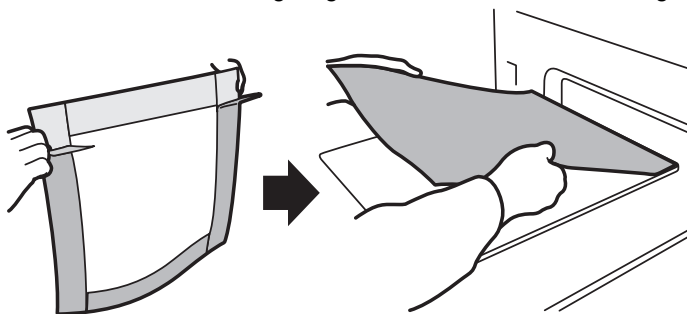

- (5) Press the Platen Button to install the Platen.



### 6-1-5. Required Maintenance for the Long Storage

If you are not going to use your printer for more than two weeks, clean the Print Head Caps before storage to prevent the ink clogging.

<Note>

*The Wash Liquid (SA6248001) is used for this cleaning. You can use the one in the Nozzle Cleaning Kit (included), the one that comes with the new Yellow Ink Cartridge, or you can purchase it. If you use the Wash Liquid in the Nozzle Cleaning Kit or the one that comes with the new Yellow Ink Cartridge, make sure you replace it with the new one.*



- (1) Turn on your printer.
- (2) Press the OK Button to open the Menu Display.
- (3) Select "Maintenance", and then press the OK Button.
- (4) Select "Cap/Wiper Cleaning", and then press the OK Button.  
The Platen moves.
- (5) Turn off your printer when the following display appears.

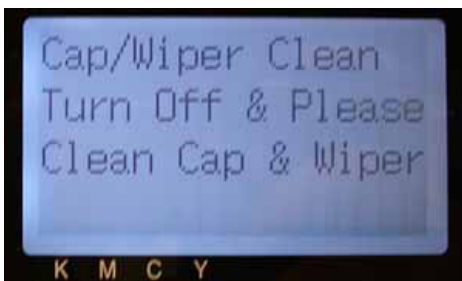

- (6) Open the Front Cover.

## 6. Maintenance

- (7) Fill all the Print Head Caps with the Wash Liquid.

*<Note> Be careful not to spill the Wash Liquid around the Print Head Caps.*

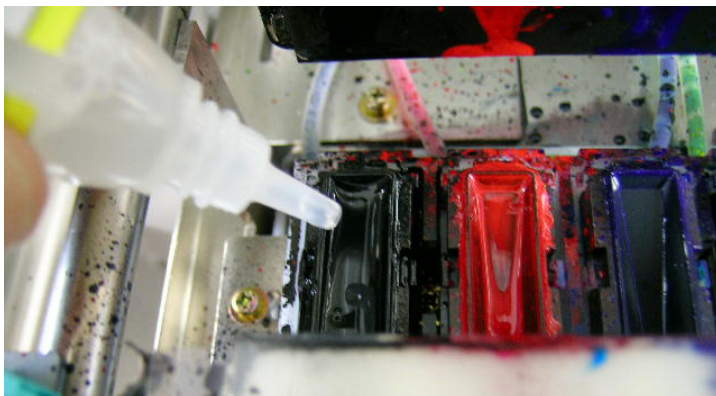

- (8) Close the Front Cover.

- (9) Turn on your printer once, and after the initializations, immediately turn it off for the storage.

---

## 6-2. Updating Your Printer Driver

Update your printer driver to keep your printer up-to-date.

- (1) Turn on your PC.
- (2) Insert the Updated CD.
- (3) Open your PC's "Control Panel".
- (4) For Windows XP user: double-click "Printers and Other Hardware".  
For Windows 2000 user: double-click "Printers and Faxes".
- (5) If you are using your printer with PC connection, open "Properties" of GT-541.  
If you are using your printer without PC connection, open "Properties" of Brother GT-541 FileOutput.

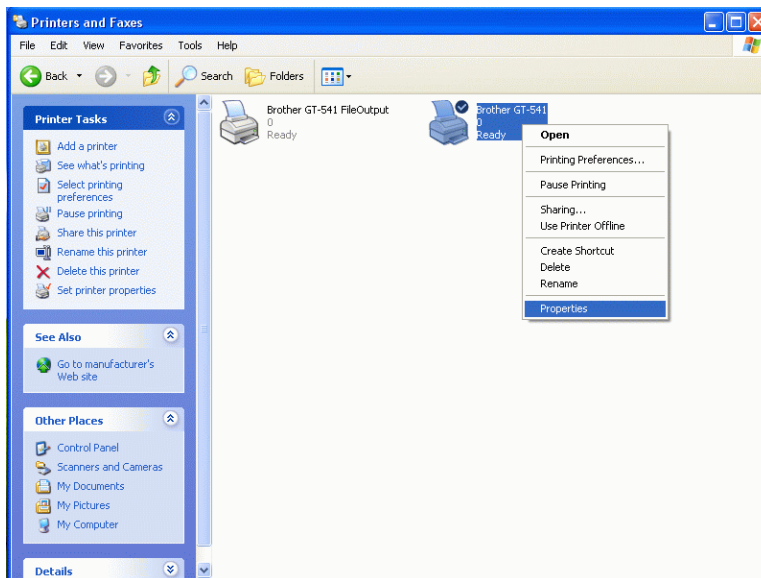

The Printer Properties dialog box appears.

- (6) Select "Advanced" tab, and then click "New Driver...".

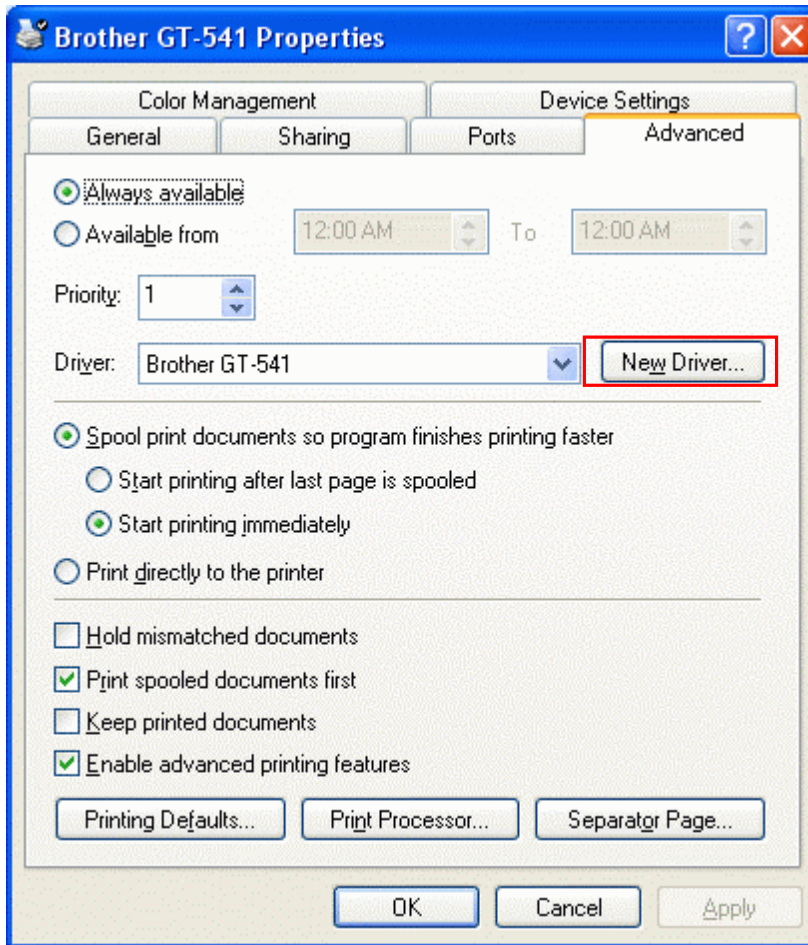

- (7) Click "Next".



- (8) Click "Have Disk...".

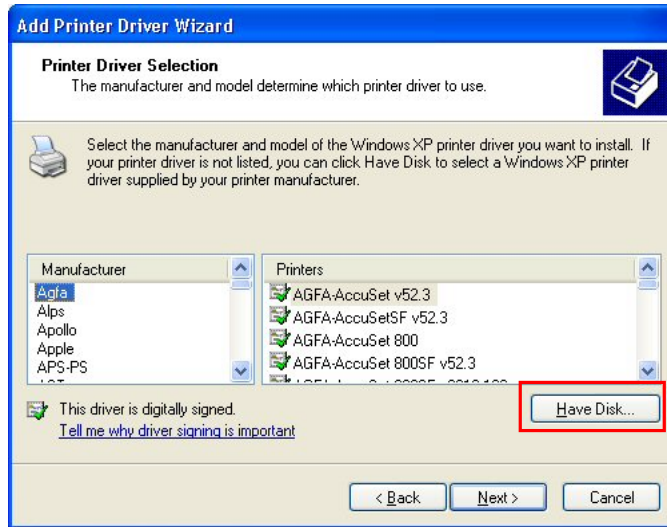

- (9) Click "Browse..." to select the CD-ROM drive, and then click "OK".

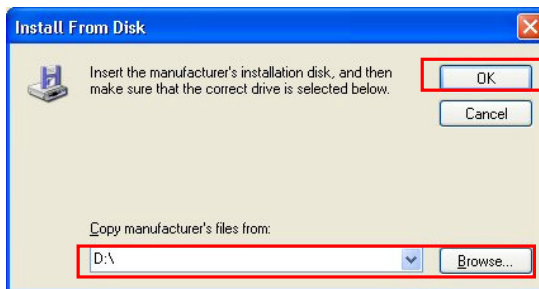

- (10) Click "Next".

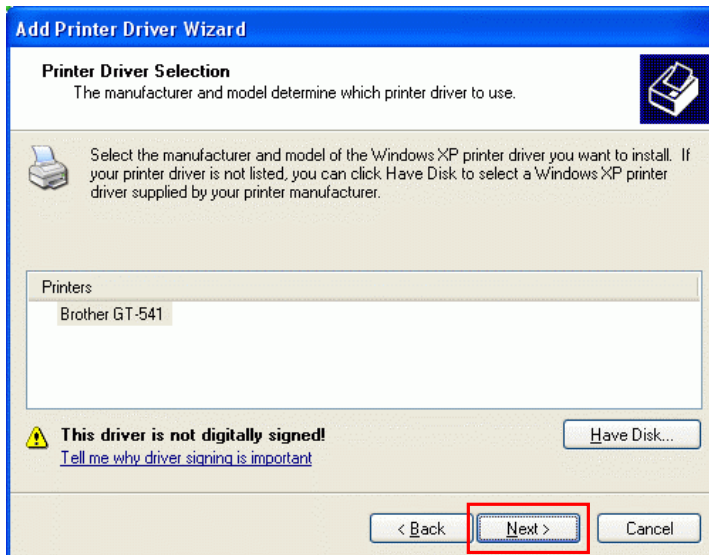

(11) Click "Finish".

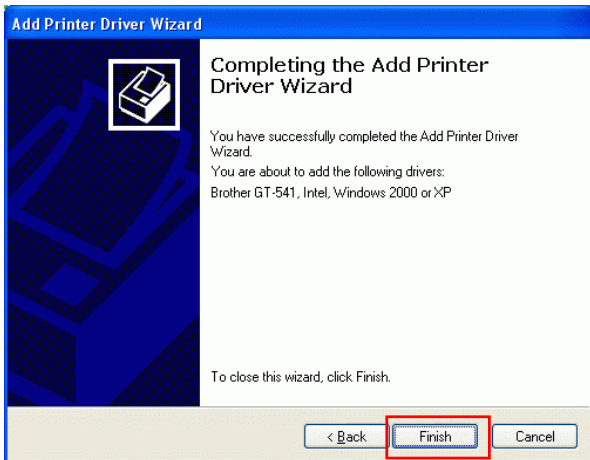

(12) For Windows XP user: click "Continue Anyway".



For Windows 2000 user: click "Yes".

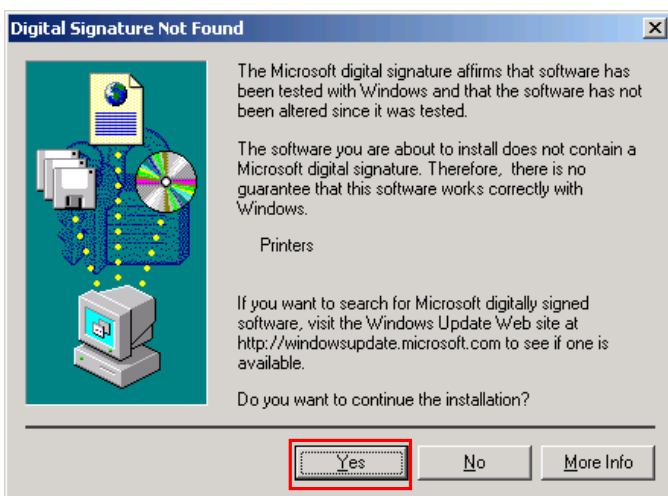

<Note>

*This software has proved to work sufficiently with Windows XP/2000. You do not have to stop the installation.*

(13) Restart your PC.

The printer driver has been updated.

## 7. Troubleshooting

### **WARNING**



Do not put your hands in the ink cartridge slot, otherwise the needle inside the slot may cause injury.

### **CAUTION**



Leave sufficient space at the front of the printer, and avoid placing items in front of it, otherwise the platen may hit them and be damaged, and if your hands get caught between the platen and the object, injury may result.



Release your hand from the platen while the printer is operating.  
If your hand gets caught between the platen or the T-shirt tray and the covers, injury may result.



Do not push nor pull the platen by hands quickly.  
It must be a cause of operation troubles or failures of printed circuit boards.



Do not put your hands inside the covers while the printer's power is turned on, otherwise your hands may touch against moving parts and this may result in injury.



Wait at least 1 minute after turning off the power switch before opening the front cover.  
Touching the heat sink on the head can result in burns.



Be careful not to get your fingers caught when closing the front cover, otherwise it may result in injury to your fingers.



Do not disassemble the ink cartridge or the waste ink cartridge.  
If the ink cartridge or waste ink cartridge is disassembled, it can no longer be used.



Take care not to let the ink, waste liquid or wash liquid come into contact with your eyes or onto your skin, otherwise inflammation can result.

Furthermore, do not drink the ink, waste liquid or wash liquid under any circumstances, as they can cause vomiting and diarrhoea.

Keep the ink, waste liquid and wash liquid out of the reach of children.



## 7-1. Solving Printer Problems

Use the table to solve printer problems.

Problem	Cause	Solution
Cannot send print data from the PC.	You have selected the wrong printer.	Confirm the selected printer, and select the correct one.
	The connection between GT-541 and the PC is loose.	Connect them securely. See "3-3. Preparing Your PC".
	Using the USB cable that does not meet the requirement.	Use the USB cable that meets the requirement. See "1-3-4. Other Requirements".
	Noise is disturbing the communication between GT-541 and the PC.	Disconnect the USB 2.0 cable once, and connect it again (see "3-3. Preparing Your PC"). If this does not solve the problem, restart GT-541.
	The PC is not working properly.	Restart the PC.
Pressing the Print Button does not start printing.	GT-541 is indicating the error.	Solve the problem, and try again.
	Auto Head Cleaning is in process.	Wait until the Head Cleaning finishes.
	The room temperature does not meet the requirements.	Adjust the room temperature. See "1-3-1. Environment".
	The printer has not received/read a data, or is now receiving/reading the data.	Confirm that the Print Button is turned on, and try again.
	The Print Heads are overheated and the message "Cooling Down" appears.	Wait until the message disappears.
GT-541 does not turn on.	There is no power distribution.	Check the power cable connections.
	The Front Cover is open or not closed properly.	Close the Front Cover properly.
An error occurred right after turning on GT-541.	An error occurred.	Restart GT-541. If the error is not cleared, please contact Brother Customer Service Hot Line.

Problem	Cause	Solution
<i>GT-541 cannot read data from CompactFlash.</i>	<i>No CompactFlash is inserted in the slot, or it is not inserted properly.</i>	<i>Insert CompactFlash properly.</i>
	<i>The CompactFlash is not supported.</i>	<i>Use the supported CompactFlash. See "1-3-4. Other Requirements".</i>
	<i>The CompactFlash is not FAT16 formatted.</i>	<i>Use the CompactFlash that is FAT16 formatted.</i>
	<i>The CompactFlash has poor quality.</i>	<i>Use the recommended CompactFlash. See "1-3-4. Other Requirements".</i>
	<i>Files are inside the folder created in CompactFlash.</i>	<i>Move files out of the folder (in root folder).</i>
<i>The file name of the data saved in a CompactFlash is not displayed properly.</i>	<i>The file name has been changed when saving it in the CompactFlash because it had more than 8 characters.</i>	<i>Rename the file with characters of 8 or less, and then save it again in the CompactFlash.</i>

### 7-1-1. How to Check the Error Logs

When you contact Brother Customer Service Hot Line to solve problems on your printer, we may be able to response rapidly with the error log, which is used by the representative to identify the type of error. The error log can be checked using your PC that the GT-541 printer driver is installed.

#### Procedure

- (1) Confirm that your PC is connected directly to your printer with a USB cable.
- (2) Select "Brother GT-Tools" on "Start" menu, and then "GT Error Log Checker".

The following dialog box appears.

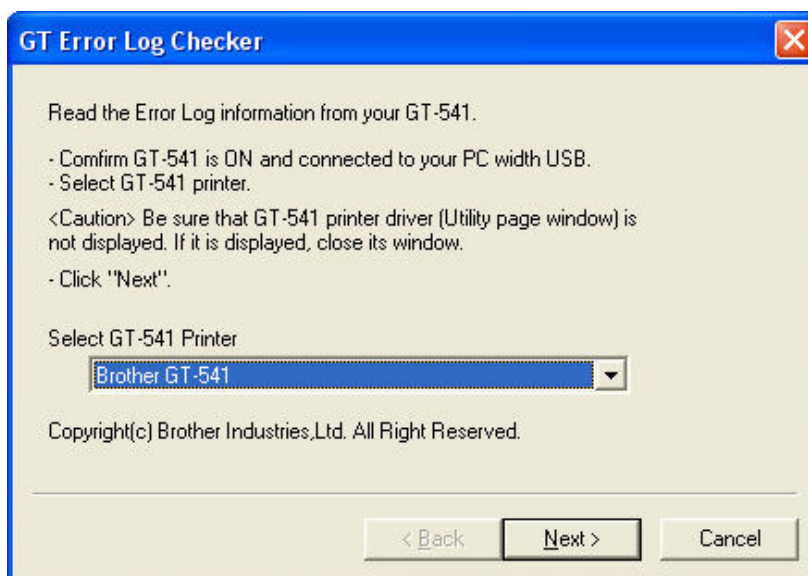

- (3) Read through the displayed information, select “GT-541” as the printer, and then click “Next”.  
The log data-reading begins.

<Note>

*It may take several minutes if a USB 1.1 cable is used.*

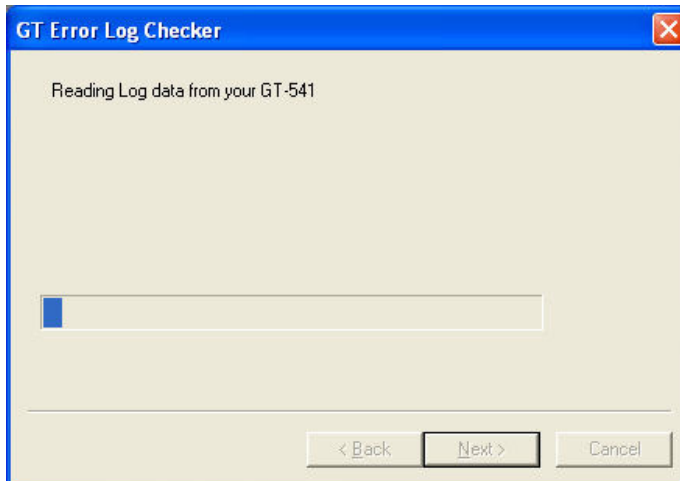

- (4) When the log data has been read successfully, they are listed in order of time the problems occurred.

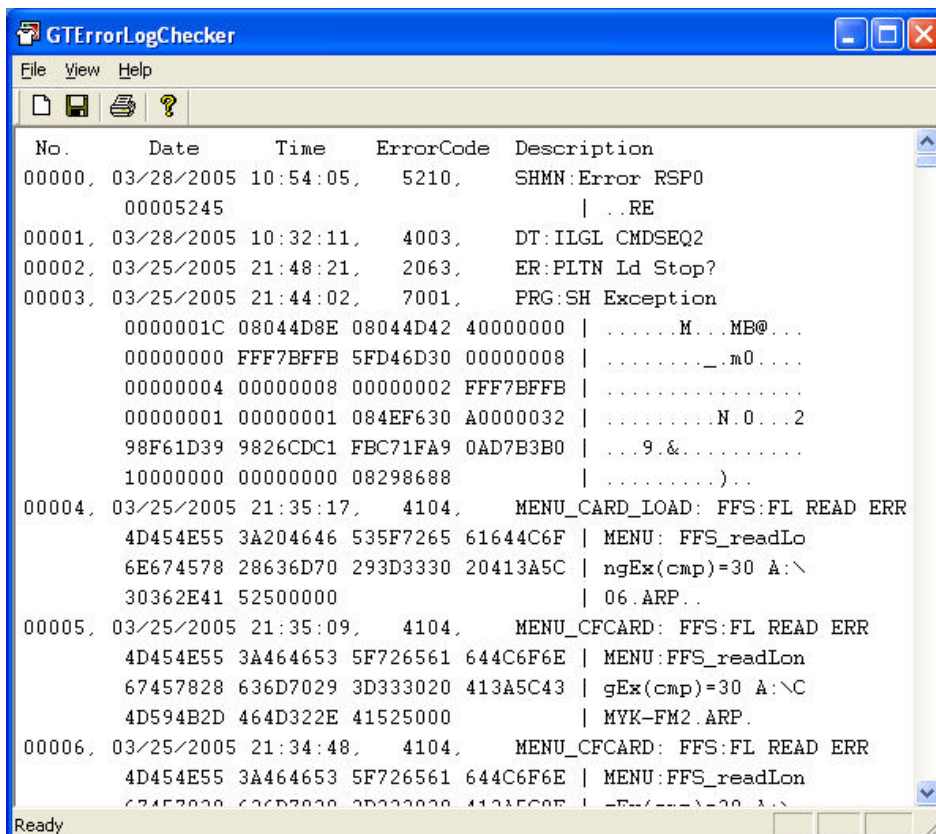

The error logs can be printed by selecting “Print” on “File” menu or saved as a text file by selecting “Save As...” on “File” menu.

## 7-2. Solving Print Quality Problems

Use the table to solve print quality problems.

<b>Problem</b>	<b>Cause</b>	<b>Solution</b>
<i>Print is faded.</i>	<i>The Ink Cartridge may be getting low on ink.</i>	<i>See “6-1-1. Replacing an Ink Cartridge”.</i>
	<i>The print condition is not appropriate.</i>	<i>See “4-3. Setting the Printer Driver Condition”.</i>
	<i>The graphic application’s settings are not appropriate.</i>	<i>See “4-2 Setting the Application’s Print Condition”.</i>
<i>Your print has horizontal stripes (banding).</i>	<i>The Print Heads need to be cleaned.</i>	<i>Press the Head Cleaning Button to clean the Print Heads. If repeating this 5 times does not solve the problem, see “7-2-2. Cleaning the Print Heads”.</i>
	<i>Printing on the T-shirt made with high absorbent material such as ceramic fiber.</i>	<i>Print with one-way print. See “7-2-4. Changing the Print Direction”.</i>
<i>The ink runs.</i>	<i>Too much ink is used.</i>	<i>See “4-3-6. Selecting the Ink Volume.”</i>
	<i>Using a T-shirt that is not made with 100% cotton.</i>	<i>Use a 100% cotton T-shirt, or adjust the ink volume.</i>
<i>The outlines of printed image are not clear, or texts and outlines are printed doubled.</i>	<i>The Platen height may not be appropriate.</i>	<i>See “4-5. Placing the T-shirt on the Platen”.</i>
<i>You notice ink smudges.</i>	<i>There are creases on the T-shirt.</i>	<i>Clear the creases.</i>
	<i>The Platen Sheet needs to be replaced.</i>	<i>See “6-1-4. Replacing the Platen Sheet.”</i>
<i>You notice ink smudges when printing an image that has yellow next to black.</i>	<i>The Yellow / Black Printing is not on.</i>	<i>See “4-3-7. Setting Yellow / Black Printing”.</i>

### 7-2-1. Procedure for Solving the Print Quality Problems

Follow the procedure below until the print quality problem is solved.

#### 1. Clean the Print Heads by pressing the Head Cleaning Button.

Cleaning the Print Heads can solve most print quality problems (see “7-2-2. Cleaning the Print Heads/ Using the Head Cleaning”). If the problem is not solved, go on to the next step.

<Note>

*Your printer automatically cleans its Print Heads every 24 prints; however more frequent Print Heads cleaning needs to be done depending on the environment. In this case, change the Auto Head Cleaning frequency (see “7-2-5. Changing the Auto Head Cleaning Setting”).*

#### 2. Check the Wiper Cleaner, and if it is soiled, replace it.

The Wiper Cleaner needs to be replaced when you replace the Yellow Ink Cartridge; however cleaning the Print Heads frequently may hasten its consumption.

- (1) Turn off your printer.
- (2) Open the Front Cover.
- (3) Pull out the Wiper Cleaner Cassette.

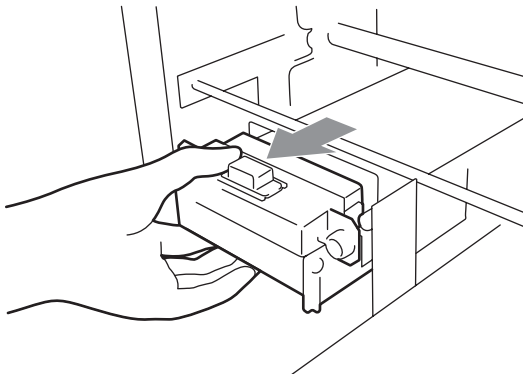

<Note>

*Do not tilt the Wiper Cleaner Cassette; ink may get on your hands or clothing.*

- (4) Check the Wiper Cleaner, and if it is heavily soiled, replace it using the Cap Cleaning Kit SA5774001 (see “6-1-2. Replacing the Wiper Cleaner”). If the Wiper Cleaner is not heavily soiled, go on to the next step.

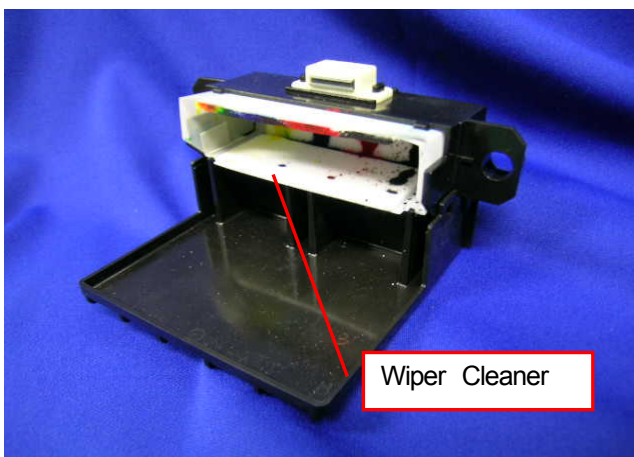

## 7. Troubleshooting

- (5) Check the Wiper Blade, and if it has been come off or it is coming off, replace it using the Wiper Replacing Kit SA4463001 (see “7-2-9. Replacing the Wiper Blade” for the details).

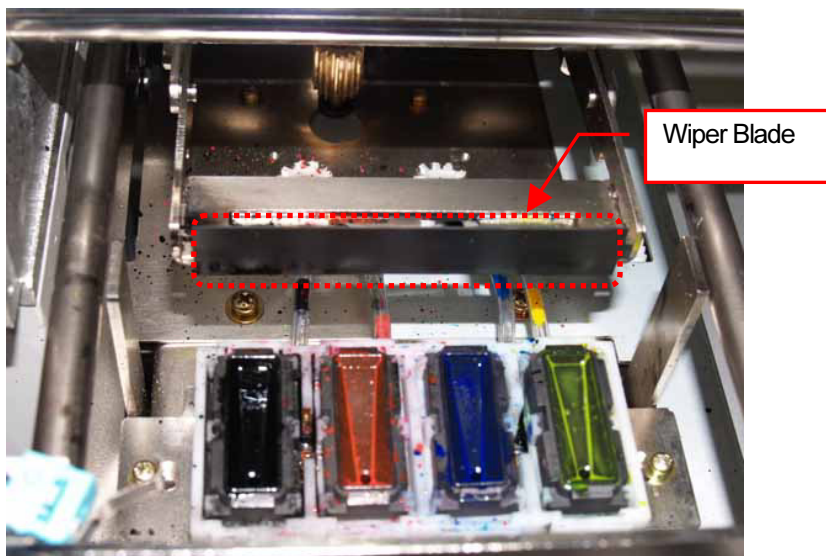

If the problem is not solved, go on to the next step.

### 3. Check the humidity.

If the humidity is too low (lower than 35 %), no ink jetting may occur. In this case, place the humidifier near your printer to maintain the humidity higher than 35 %.

### 4. Clean the Print Heads with the “Powerful” mode.

- (1) Print the Nozzle Check Pattern, and check which Print Head has the problem (see “7-2-3. Printing and Checking the Nozzle Check Pattern”).
  - (2) Clean the Print Head that has the problem with the “Powerful” mode (see “7-2-2. Cleaning the Print Heads”).
  - (3) Print the Nozzle Check Pattern and check if the problem is solved. If you still notice the problem, repeat steps (1) to (3) five times until the problem is solved.
- If the problem is not solved, go on to the next step.

### 5. Clean the Nozzle of the Print Head that has problem.

- (1) Clean the Print Head Nozzle using the Nozzle Cleaning Kit SA5885001 (see “7-2-6. Cleaning the Print Head Nozzle”).  
*<Note> Purchase the new one after use.*
- (2) Clean the Print Head with the “Initial” mode.  
*<Note> Make sure you always clean the Print Head with the “Initial” mode after the Print Head Nozzle cleaning.*

If the problem is not solved, go on to the next step.

### 6. Contact Brother Customer Service Hot Line.

You may be asked to replace the Print Head (SA5046001 PRINT HEAD) by yourself. See “7-2-7. Replacing the Print Heads” for the procedure.

## 7-2-2. Cleaning the Print Heads

Your printer automatically cleans its Print Heads every 24 prints (you can change the frequency; see “7-2-5. Changing the Auto Head Cleaning Setting”), or when your printer has not been used for more than two hours. The auto-cleaning starts when you press the Print Button in these situations. However, the auto-cleaning may not be enough and may cause print quality problems (e.g. stripes/ banding appears on the printed image), and the following operation may be needed.

### Using the Head Cleaning Button

- (1) Make sure your printer is not in the middle of any operation.
- (2) Press the Head Cleaning Button.  
The message “Head Cleaning...” appears and your printer starts cleaning the Print Heads.  
(Press the Stop Button to cancel cleaning.)  
The message changes to “Stand By” or “Ready” when the head cleaning has been completed.

### Normal/ Powerful/ Initial Head Cleaning

- (1) Make sure your printer is not in the middle of any operation.
- (2) Press the OK Button to display the Menu Display.

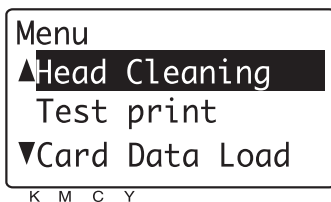

- (3) Press the Up/Down Button to select “Head Cleaning”, and then press the OK Button.
- (4) Press the Up/Down Button to select the mode (Normal/ Powerful/ Initial), and then press the OK Button.
- (5) Press the Up/Down Button to select which Print Head to clean (can select “All Colors” for Normal mode), and then press the OK Button.  
The message “Head Cleaning...” appears and your printer starts cleaning the Print Heads.  
The message changes to “Stand By” when the head cleaning has been completed.

<Note>

The “Initial” cleaning cannot be executed with the Waste Ink Cartridge full, and the message “WASTE INK FULL” appears. In this case, replace the Waste Ink Cartridge before the “Initial” cleaning (see “6-1-3. Replacing the Waste Ink Cartridge”).

### 7-2-3. Printing and Checking the Nozzle Check Pattern

You can identify which Print Head has the problem by checking the Nozzle Check Pattern.

- (1) Install the Platen 14 x 16 (see “4-4. Uninstalling / Installing the Platen”).
- (2) Set the Platen height to the “A” position (see “4-5. Placing the T-shirt on the Platen”).
- (3) Place a paper (A4 or letter size) on the Platen as shown below. You can use a T-shirt instead of the paper (see “4-5. Placing the T-shirt on the Platen”).

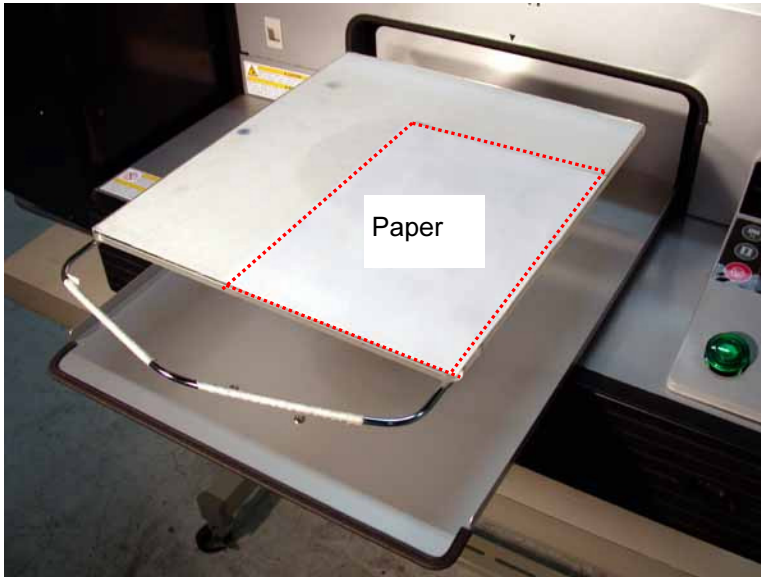

- (4) Press the OK Button to open the Menu Display.
  - (5) Press the Up/Down Button to select “Test Print”, and then press the OK Button.
  - (6) Press the Up/Down Button to select “Nozzle Check”, and then press the OK Button.
- The following message appears.



- (7) Press the OK Button to start printing the Nozzle Check Pattern.



- (8) Check the printed pattern to identify which Print Head has the problem.

If there is stripes (arrow 1) or line breaks (arrow 2), the Print Head of the color (in the following example: Black) has the problem. The Print Heads need to be cleaned (see “7-2-2. Cleaning the Print Heads”).

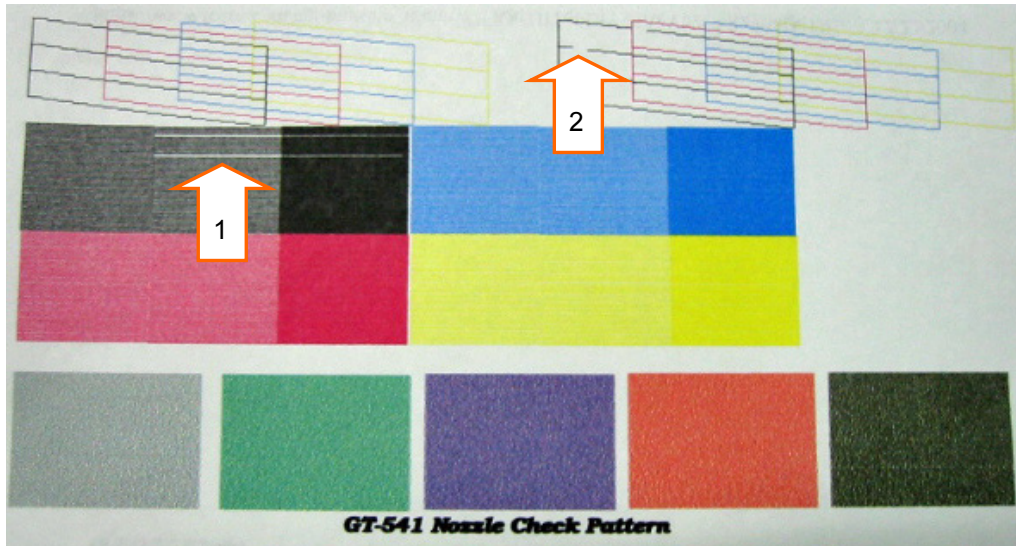

#### 7-2-4. Changing the Print Direction

When printing on the T-shirt made with high absorbent material such as ceramic fiber, horizontal stripes (changes their colors to 0.25 inches interval) may appear on the printed image. You can solve this problem using one-way print (Forward or Reverse print). Try printing with both “Forward” and “Reverse” and select the better one.

- (1) Send the print data, which you want to print changing the print direction, to your printer.
- (2) Press the OK Button to display the Menu Display.

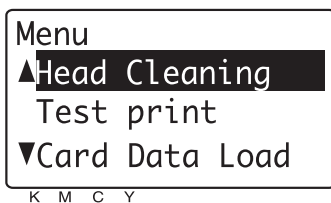

- (3) Press the Up/Down Button to select “Print Direction”, and then press the OK Button. Select “Forward”/ “Reverse”.

The print direction has been changed and returns to Job/ Status Display.

<Note>

The print direction setting returns to its default (Bi-Directional) when your printer receives the new print data or once your printer turns off.

### 7-2-5. Changing the Auto Head Cleaning Setting

Your printer automatically cleans its Print Heads every 24 prints when you press the Print Button; however more frequent Print Heads cleaning needs to be done depending on the environment. In this case, change the Auto Head Cleaning frequency as follows.

<Note>

*Cleaning the Print Heads frequently may hasten the Wiper Cleaner consumption.*

- (1) Press the OK Button to open the Menu Display.

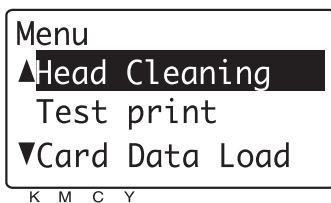

- (2) Press the Up/Down Button to select "Maintenance", and then press the OK Button.
- (3) Press the Up/Down Button to select "Auto Cleaning", and then press the OK Button.

The following display appears.

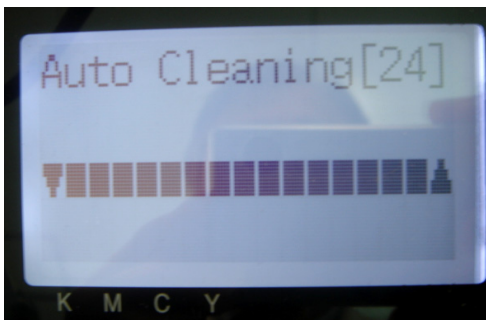

- (4) Press the Up/Down Button to select the frequency from 1 to 24, and then press the OK Button.  
The Auto Head Cleaning will be executed at every number of prints you have set.

### 7-2-6. Cleaning the Print Head Nozzle

Use the Nozzle Cleaning Kit (SA5885001) to clean the Head Nozzle.  
We recommend you to see the "Maintenance Video" in the Install CD.

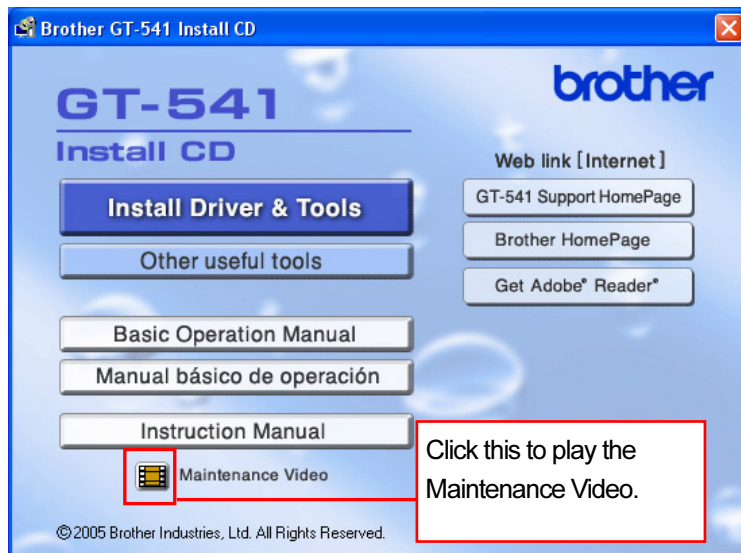

<Note>

*Cleaning the clean Print Head Nozzle may cause damage to it. The Print Head Nozzle should be cleaned only when it is needed as follows in "7-2-1. Procedure for Solving the Print Quality Problems".*

- (1) Make sure your printer is not in the middle of any operation.
- (2) Press the OK Button to display the Menu Display.
- (3) Press the Up/Down Button to select "Maintenance", and then press the OK Button.
- (4) Press the Up/Down Button to select "Nozzle Cleaning", and then press the OK Button.

The following message appears.

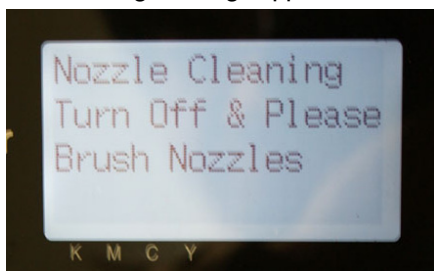

- (5) Turn off your printer.
- (6) Open the Front Cover as unlocking the Cover Locks.

## 7. Troubleshooting

- (7) Pull out the Wiper Cleaner Cassette.

<Note>

- Do not tilt the Wiper Cleaner Cassette; ink may get on your hands or clothing.
- Do not touch the Clearance Sensor (the bar above the Wiper Cleaner Cassette); it may cause a malfunction.

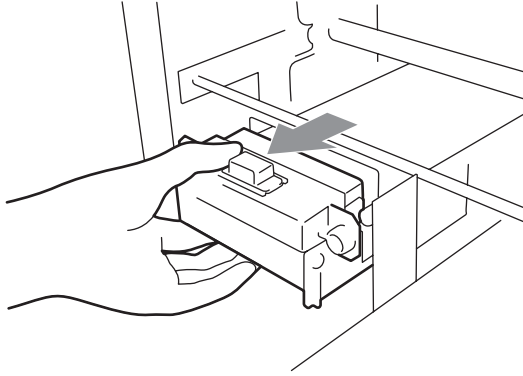

- (8) Wear the gloves and wet a Clean Applicator with the Wash Liquid (all are included in the Nozzle Cleaning Kit).



- (9) Use the wet Clean Applicator to wipe the Print Head Nozzle by moving it back and forth five times. Use one Clean Applicator wet with the Wash Liquid to clean the one Print Head Nozzle.



- (10) Insert the Wiper Cleaner Cassette straight into your printer.

*<Note>*

*Do not touch the Clearance Sensor (the bar above the Wiper Cleaner Cassette); it may cause a malfunction.*

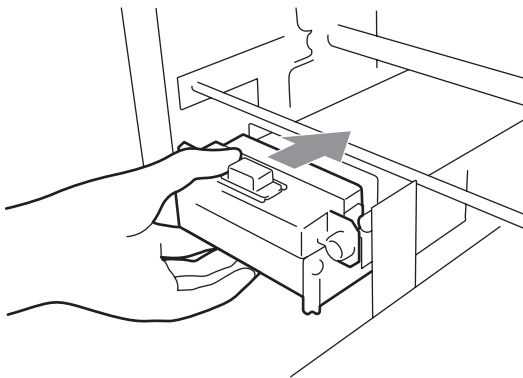

- (11) Close the Front Cover, and then turn on your printer.

## 7-2-7. Replacing the Print Heads

You can replace the Print Head by yourselves following the "Replacing the print head procedure". We also recommend you to see the maintenance video located on the install CD. If you have any questions please contact Brother Customer Service Hot Line.



<Note>

*Replacement of the Black Print Head is shown as an example in this section.*

- (1) Make sure your printer is not in the middle of any operation.
- (2) Press the OK Button to display the Menu Display.
- (3) Press the Up/Down Button to select "Maintenance", and then press the OK Button.
- (4) Press the Up/Down Button to select "Head Replacement", and then press the OK Button.
- (5) Press the Up/Down Button to select the color of Print Head to be replaced, and then press the OK Button.

The following message appears.



- (6) Remove the color's Ink Cartridge, and then press the OK Button.



The message "Set Filter Cartridge & Press OK" appears.

- (7) Insert the Filter Cartridge to the Ink Cartridge Slot, and then press the OK Button.



The ink draining begins. Wait until the message "Turn Off & Please Change [X] Head" appears.

- (8) Turn off your printer.

- (9) Open the Front Cover and pull out the Wiper Cleaner Cassette.  
You can find the Print Heads on the left.

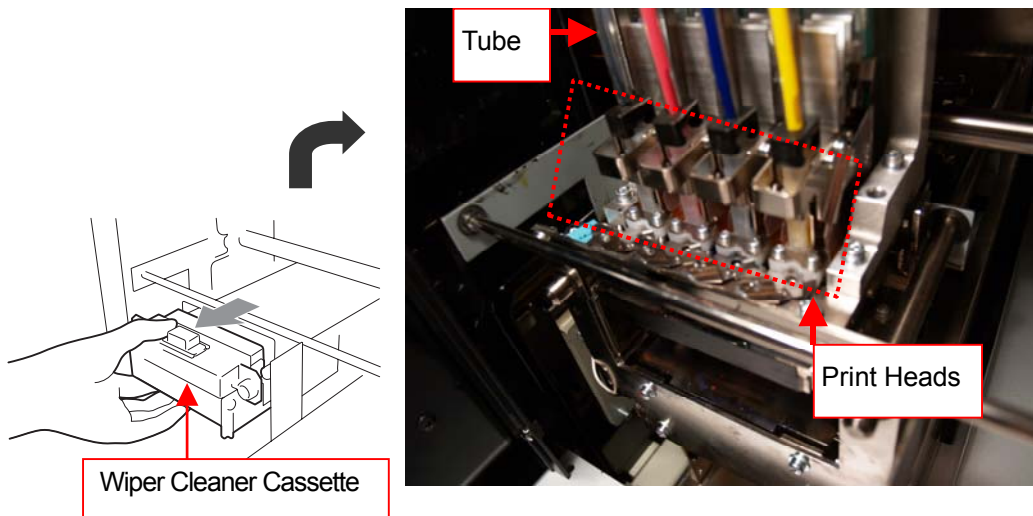

<Note>

Make sure the ink of the color, which Print Head is to be replaced, is removed from the tube.  
Remove the Wiper Cleaner Cassette before replacing Print Head. Otherwise the edge of the cassette may hit and seriously damage the Print Head.

- (10) Turn up the corresponding color of flat cable connector tab, and then disconnect the flat cable.

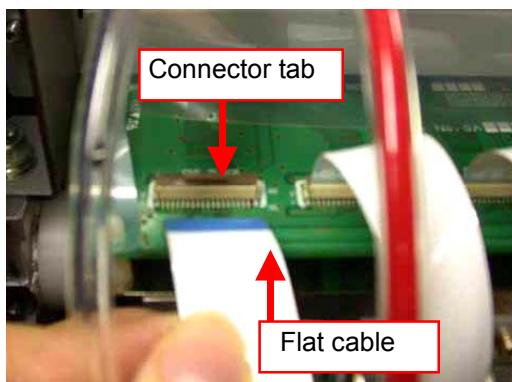
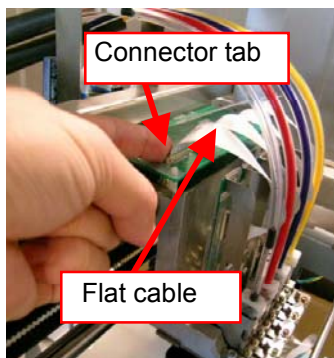



- (11) Wear the gloves included with the new Print Head, and then remove the tube fitting from the new Print Head.

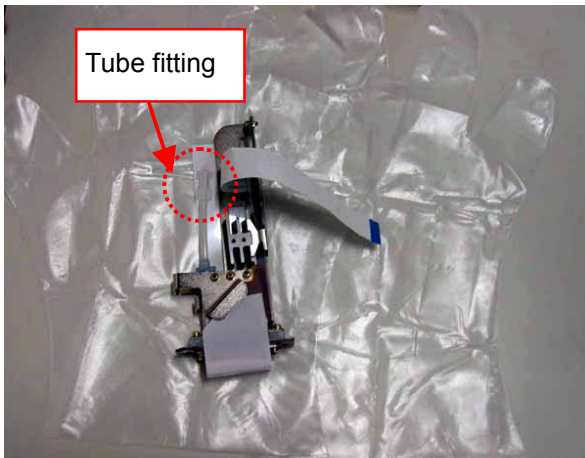

- (12) Rotate the tube connector 90 degrees as shown below.

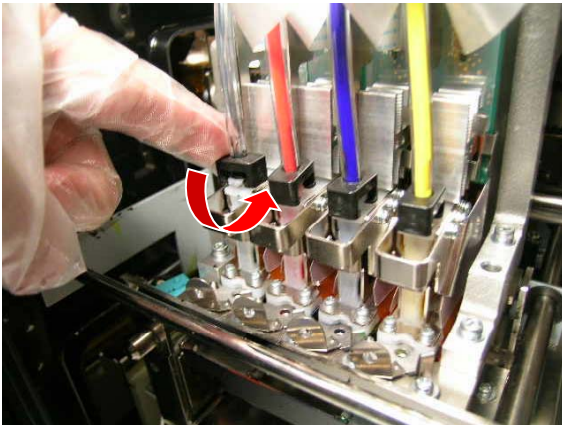

7. Troubleshooting

- (13) Disconnect the tube and put the tube fitting removed from the new Print Head to prevent the ink from dripping.



- (14) Turn the lever to the direction of the arrow to unlock the Print Head.

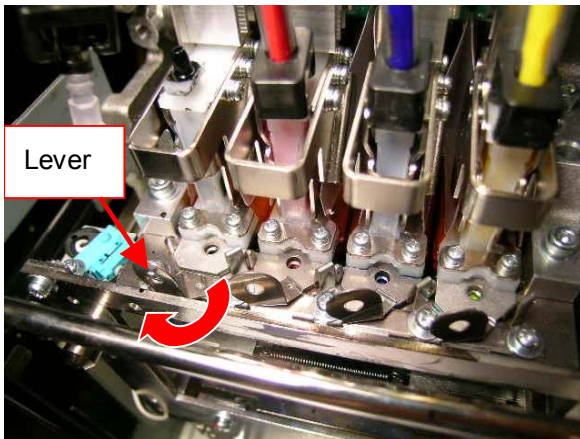

- (15) Remove the used Print Head by lifting up the knob.  
<Note> The gloves are removed for a better view.

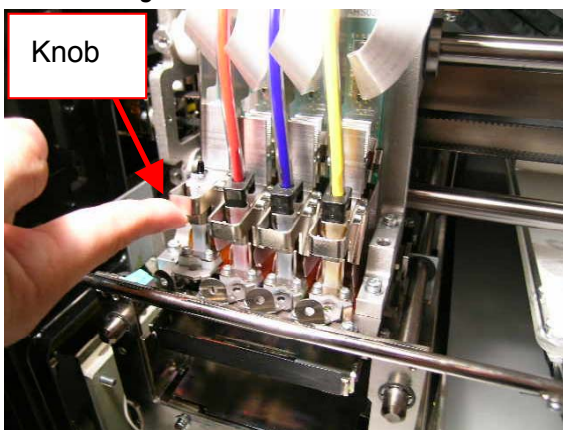

(16) Remove the Protective Tube from the new Print Head, and then install the new Print Head by holding the knob, and holding the flat cable with the other hand.

Make sure the V-shaped groove of the Print Head hits the pin.

<Note> The gloves are removed for a better view.

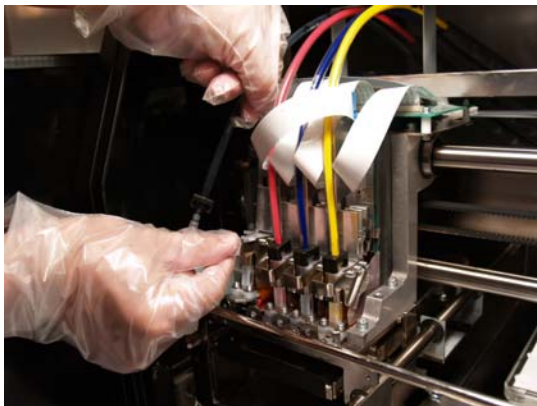
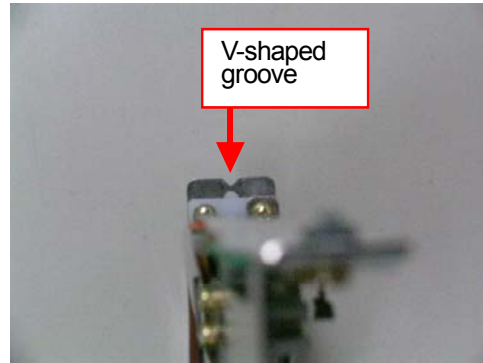
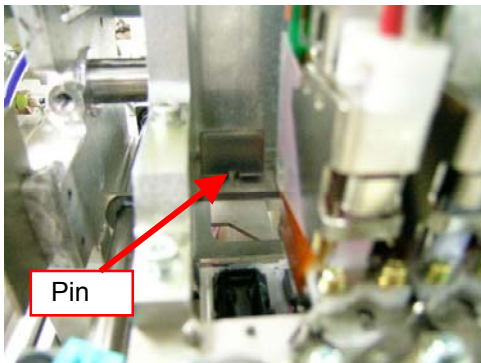
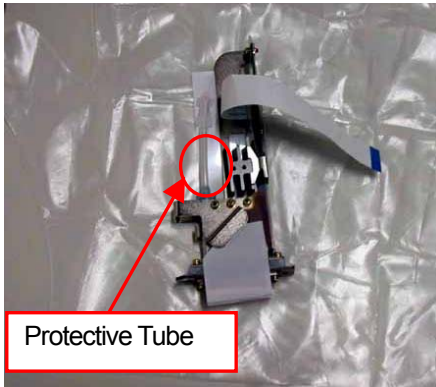

7. Troubleshooting

(17) Press down the Print Head knob securely.



(18) Turn the lever to the direction of the arrow to lock the Print Head.

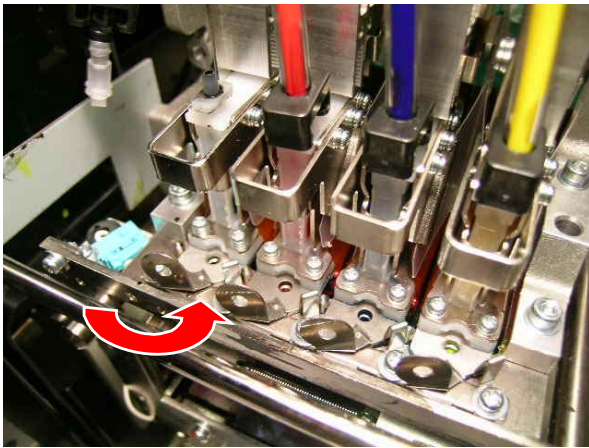

(19) Remove the Nozzle Protection Seal by pulling it up.

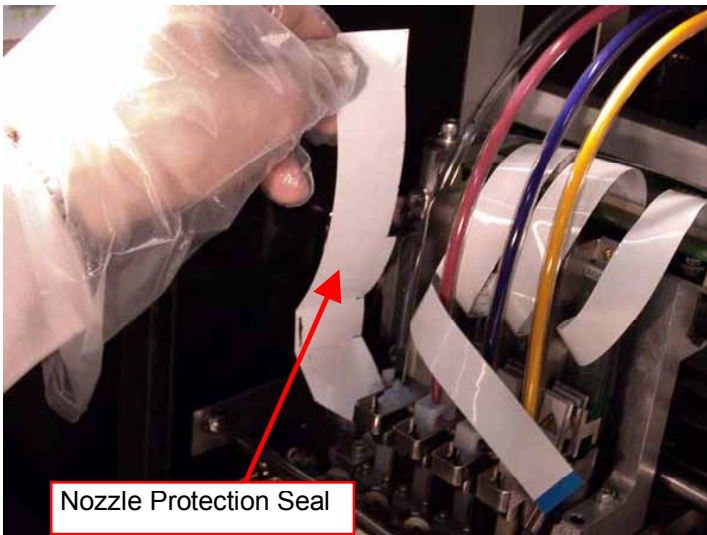

(20) Take off the gloves, insert the flat cable into the connector, and then turn down the connector tab to lock the cable.

<Note>

- Make sure the flat cable is inserted straight against the connector. If not, reconnect it correctly.
- The flat cable is very fragile. Be careful handling it.

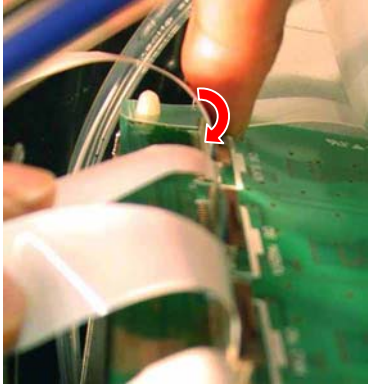

(21) Wear the gloves again, and then remove the tube fitting from the end of tube.



(22) Insert the tube into the new Print Head, and then rotate the tube connector 90 degrees to the direction of the arrow.

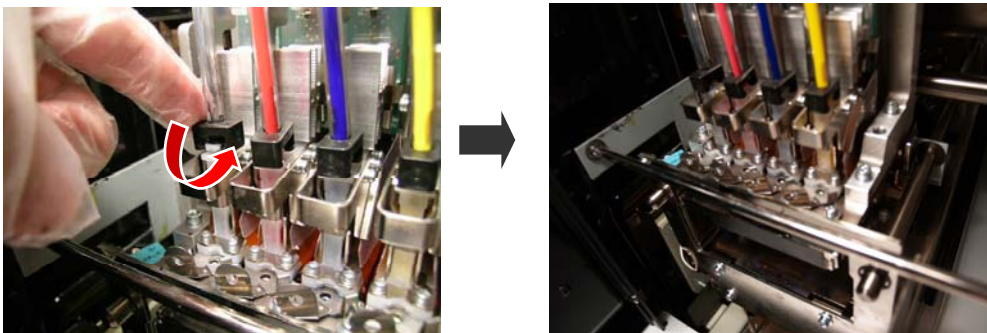

(23) Insert the Wiper Cleaner Cassette as it was and close the Front Cover.

(24) Remove the Filter Cartridge, and then install the removed Ink Cartridge back.

(25) Turn on your printer.

## 7. Troubleshooting

- (26) Press the Platen Button to eject the Platen.
- (27) Press the OK Button to open the Menu Display.
- (28) Press the Up/Down Button to select "Head Cleaning", and then press the OK Button.



- (29) Press the Up/Down Button to select "Initial" Cleaning mode, and then press the OK Button.
- (30) Press the Up/Down Button to select the color you have replaced the Print Head, and then press the OK Button.

The following message appears, and the initial cleaning starts.

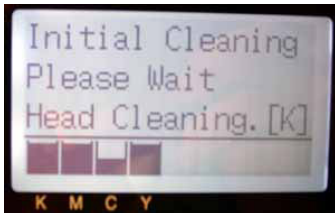

The display returns to the Print Head color-selecting display, when the initial cleaning has been completed.



- (31) Print and check the Nozzle Check Pattern (see "7-2-3. Printing and Checking the Nozzle Check Pattern").

If the problem is solved, go on to the next section to complete the adjustment after the Print Head replacement.

If you still see the problem, contact Brother Customer Service Hot Line again.

### **Adjustment after the Print Head replacement**

Adjust the Print Head alignment after you have replaced the Print Head. If it is not appropriate, the print image may be unclear.

- (1) Make sure your printer is connected to your PC.
- (2) Turn on your PC.
- (3) Open the GTFiringAdjustment in GT-Tools.

Follow the instruction displayed.

### 7-2-8. Cleaning the Carriage Shafts

If the error message “Fail: CRG Speed” or “Fail: CRG Stop 1” is displayed, clean the Carriage Shafts following the procedure below.

- (1) Turn off your printer.
- (2) Open the Front Cover.
- (3) Wipe the Carriage Shafts with a cloth soaked with alcohol.

<Note>

*Do not move the Print Heads.*

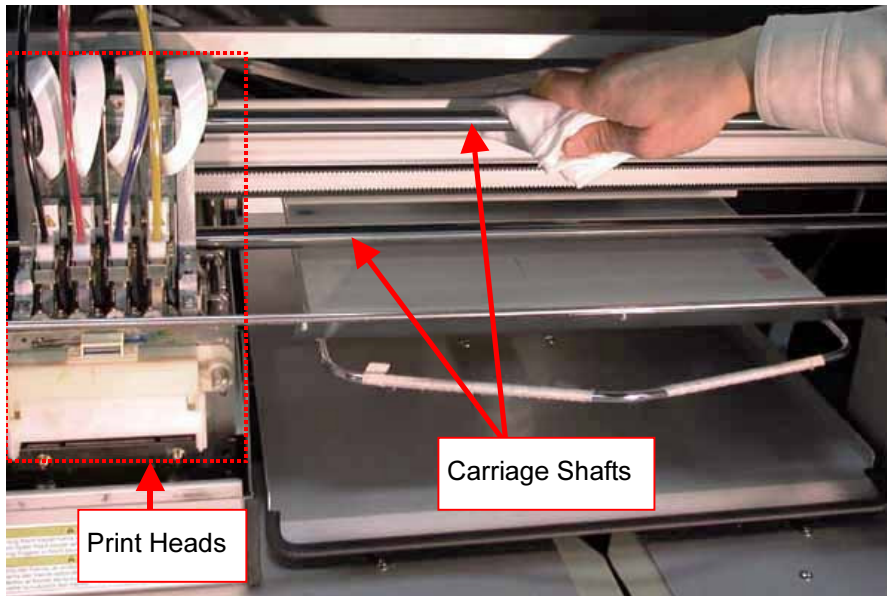

- (4) Soak a cloth with sewing oil and use it to apply the sewing oil on the Carriage Shafts.
- (5) Close the Front Cover.
- (6) Turn on your printer.

### 7-2-9. Replacing the Wiper Blade

The Wiper Blade needs to be replaced, if it has been come off or it is coming off, to solve the ink jetting problem. Use the Wiper Replacing Kit SA4463001 (sold separately) for the replacement.

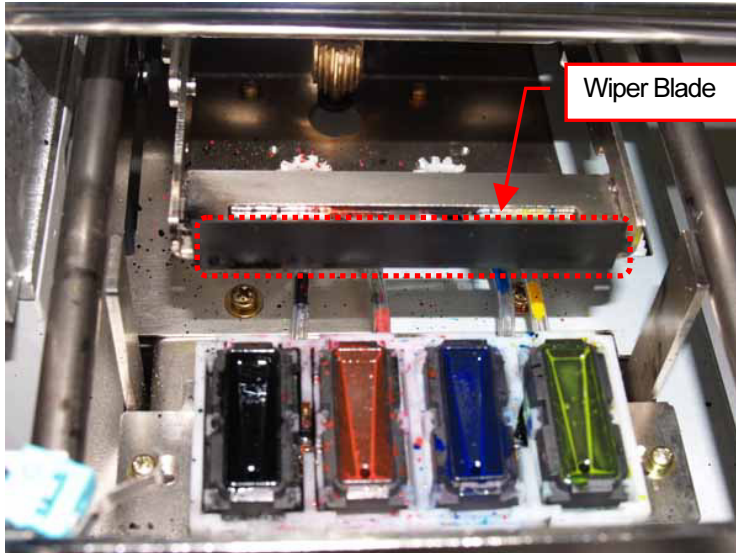

- (1) Turn on your printer if it is off.
- (2) Press the OK Button to open the Menu Display.

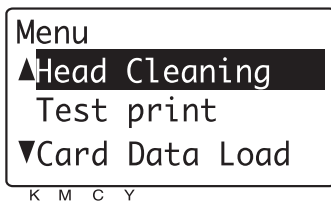

- (3) Press the Up/Down Button to select the "Maintenance", and then press the OK Button.
- (4) Press the Up/Down Button to select the "Cap/Wiper Clean", and then press the OK Button.  
The following message appears.

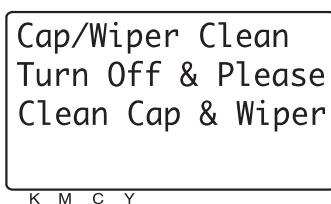

- (5) Turn off your printer.



- (6) Open the Front Cover by unlocking the Cover Locks.

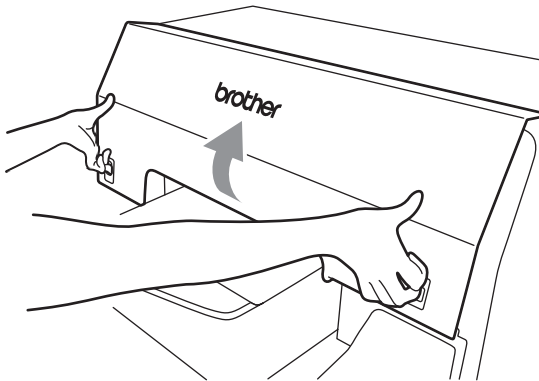

- (7) Pull out the Wiper Cleaner Cassette.

<Note>

- Do not tilt the Wiper Cleaner Cassette; ink may get on your hands or clothing.
- Do not touch the Clearance Sensor (the bar above the Wiper Cleaner Cassette); it may cause a malfunction.

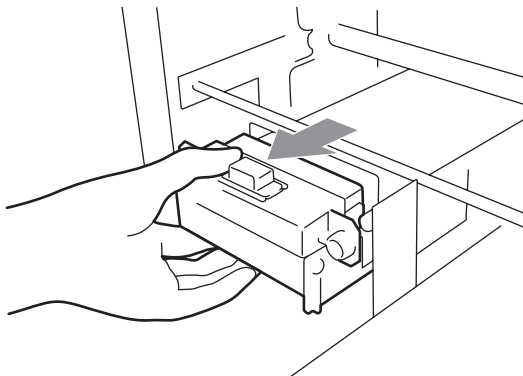

- (8) Open the Wiper Replacing Kit and wear the gloves.

7. Troubleshooting

- (9) Push the right Operation Arm about 5 mm (0.2 inches) to the right and pull out the Wiper Blade as holding its left.

<Note>

*Do not push the Operation Arm by force.*

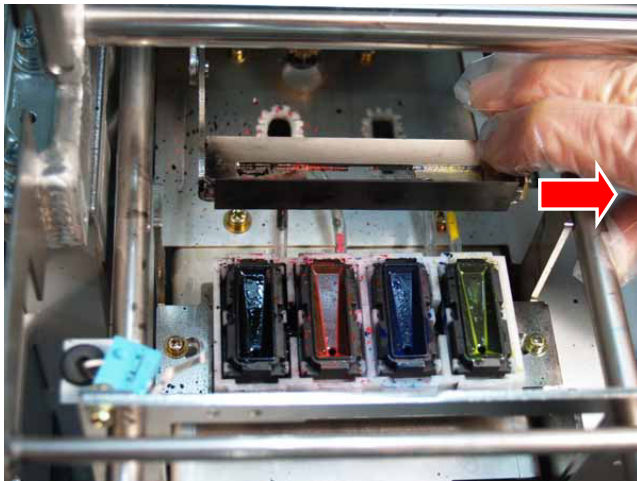
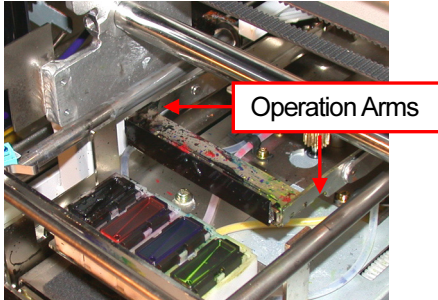

(10) Remove the Wiper Blade by pulling it to the left.

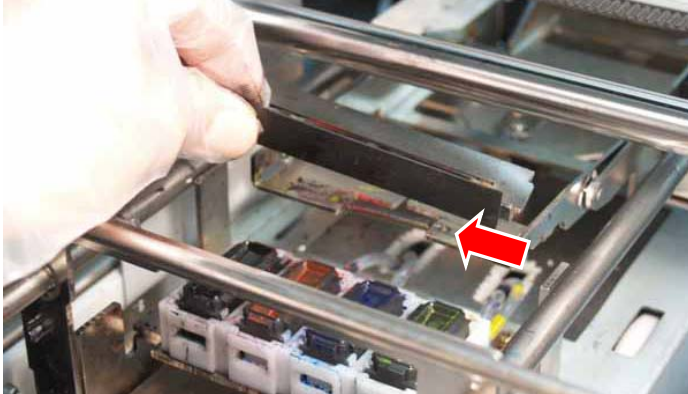

(11) Insert the left projection of the new Wiper Blade to the slit of the left Operation Arm.

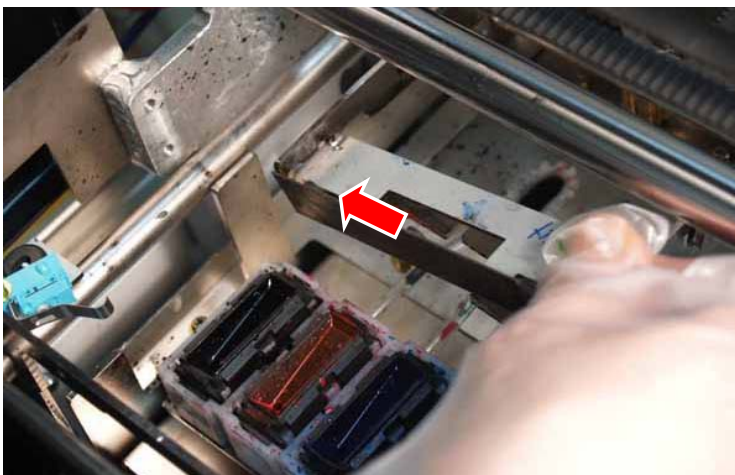
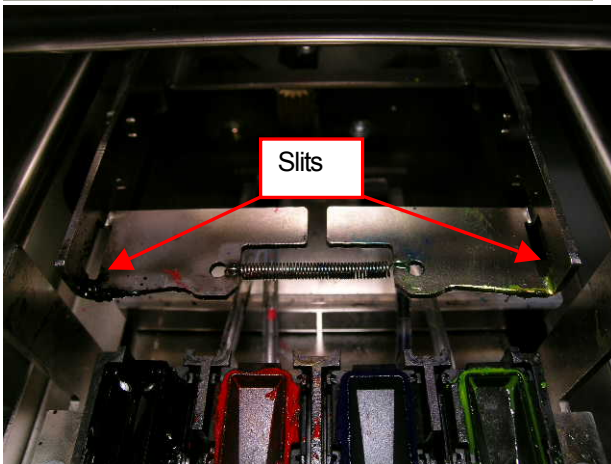
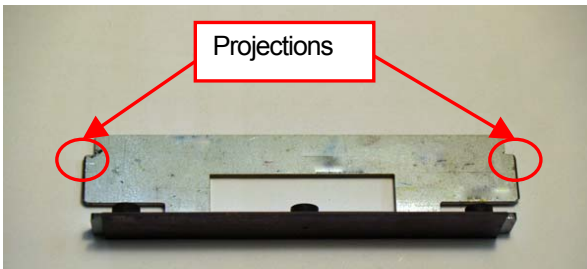

## 7. Troubleshooting

(12) Insert the right projection of the new Wiper Blade to the slit of the right Operation Arm by pushing the right Operation Arm about 5 mm (0.2 inches) to the right.

<Note>

- Do not push the Operation Arm by force.
- Do not push down the Wiper Blade and the Operation Arms by force. It may cause damage to them.

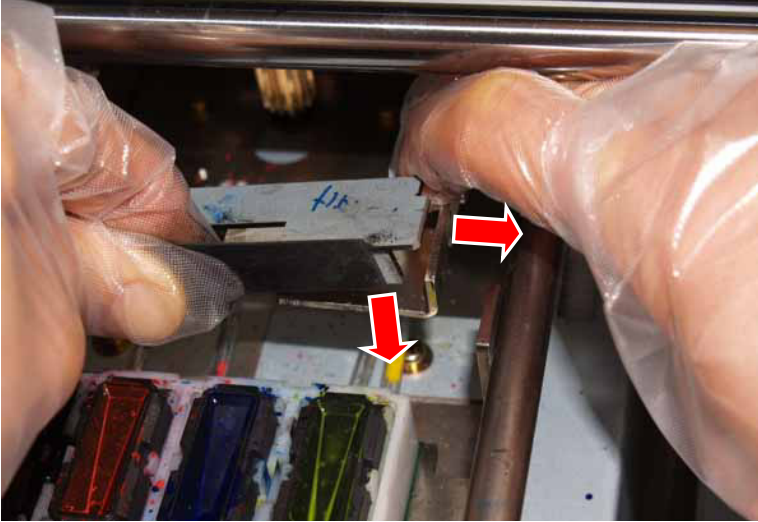

(13) Confirm that both projections of the Wiper Blade are inserted to the slits of the Operation Arms.



(14) Insert the Wiper Cleaner Cassette straight into your printer.

<Note>

*Do not touch the Clearance Sensor (the bar above the Wiper Cleaner Cassette); it may cause a malfunction.*

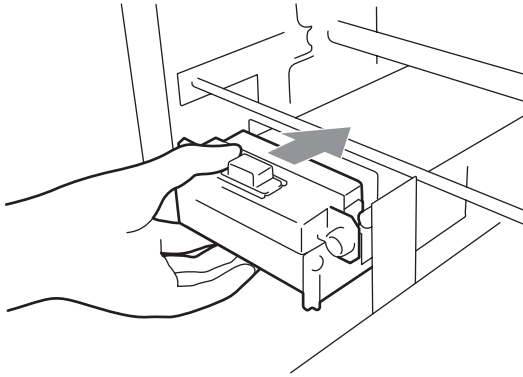

(15) Close the Front Cover, and then turn on your printer.

If your printer turns on without any problem, replacement of the Wiper Blade has been completed.

If there is problem (abnormal noise or error), turn off your printer, and check if the Wiper Blade, the Wiper Cleaner and the Wiper Cleaner Cassette are correctly installed.

### 7-3. Solving Application Problems

Problem	Cause	Solution
<p>The image sent from Adobe Illustrator 10 is printed 90 degree rotated.</p>	<p>The Print Setup or Document Setup is not appropriate.</p>	<p>In Adobe Illustrator 10 follow the instruction below, and then try to send the print data again:</p> <ol style="list-style-type: none"> <li>(1) Open "Print Setup" in the "File" menu.</li> <li>(2) Select GT-541 as the printer, and then click "OK".</li> <li>(3) Open "Document Setup" on "File" menu.</li> <li>(4) Check "Use Print Setup".</li> <li>(5) Confirm the "Orientation", "Width" and "Height".</li> </ol> <p>If they are not appropriate, correct them, and then click "OK".</p>
<p>The image sent from Adobe Illustrator CS is printed 90 degree rotated.</p>	<p>The Print Setup or Document Setup is not appropriate.</p>	<p>With Adobe Illustrator CS, landscape image may not be printed properly. Correct the setting following the instruction below, and then try to send the print data again:</p> <ol style="list-style-type: none"> <li>(1) Open "Print" in the "File" menu.</li> <li>(2) Confirm that the Media Size is "Defined by Driver".</li> <li>(3) Change the Media Orientation to the portrait.</li> <li>(4) If you are not changing the Platen size, skip to step (8). If you want to change the Platen Size, click "Setup...", and then click "Continue".</li> </ol> <p>Print window appears.</p> <ol style="list-style-type: none"> <li>(5) Click "Preference".</li> <li>(6) Change the Platen Size in the Printer Driver Window, and then click "OK".</li> <li>(7) Click "Print" in the Print window.</li> <li>(8) Confirm the preview, and then click "Print" to send the data to your printer.</li> </ol>

Problem	Cause	Solution
<i>The Platen Size setting changes to Platen 10 x 12 (this happens especially when printing the image smaller than 14 x 16 inches).</i>	—	<i>Check the Platen Size in the Printer Driver window before you send the print data to your printer.</i>
<i>The image sent from Adobe Illustrator cannot be printed on proper position, or it cannot be sent and result in errors.</i>	—	<i>See “4-2-4. Setting Adobe Illustrator 10 Print Condition”.</i>
<i>There are some Properties windows shown in Photoshop 6/7/CS. When the values of Printing Preferences in Windows are set beforehand and you modified the values from the printer driver Properties window of Photoshop, mismatching information appears among different dialog boxes.</i>	—	<i>The setting in the Properties of the Print window is applied.</i>

## 7-4. Error Messages

If an error message, that is not shown in the following table has appeared, write down the error number and the message, and then contact Brother Customer Service Hot Line.

Message	Status	Solution
WARNING WASTE INK FULL	The Waste Ink Cartridge is almost full.	Prepare the new Waste Ink Cartridge. We recommend you replace the Waste Ink Cartridge soon (you can still continue printing for a while).
Wp-Cleaner Life	The Wiper Cleaner needs to be replaced.	Replace the Wiper Cleaner. See "6-1-2. Replacing the Wiper Cleaner".
Wp-Blade Life	The Print Head Wiper Blade needs to be replaced.	Contact Brother Customer Service Hot Line.
K (M, C, or Y) Head Temp	The Print Head temperature is too high.	Wait until it cools down.
K (M, C, or Y) Head Life	The Print Head need to be replaced.	Contact Brother Customer Service Hot Line. Replace the Print Head (see "7-2-7. Replacing the Print Heads").
CR Motor Life	The Carriage Motor is worn.	Contact Brother Customer Service Hot Line.
Temp Low xxx °F	The room temperature is too low.	Raise the room temperature.
Temp High xxx °F	The room temperature is too high.	Drop the room temperature.
Battery Life	The battery ran out.	Contact Brother Customer Service Hot Line.
RTC not Adjusted	The internal clock has not been set.	Contact Brother Customer Service Hot Line.
NO INK COLOR	The Ink Cartridge of the COLOR is not installed.	Install the Ink Cartridge of the COLOR.
NO WASTE INK TRAY	The Waste Cartridge Tray is not installed.	Install the Waste Cartridge Tray.
EMPTY COLOR	The Ink Cartridge of the COLOR ran out of ink.	Replace the Ink Cartridge of the COLOR.
ERROR WASTE INK FULL	The Waste Ink Cartridge is full.	Replace the Waste Ink Cartridge.
WPC Removed	The Wiper Cleaner Cassette is not installed.	Install the Wiper Cleaner Cassette.



Message	Status	Solution
<i>OBSTACLE SENSED</i> <i>Check &amp; Press OK</i>	<i>GT-541 detected an obstacle on the Platen.</i>	<i>Remove the obstacle from the Platen, and then press the OK Button.</i>
<i>PC Comm. Error</i> <i>Send data again</i>	<i>GT-541 failed to receive the print data.</i>	<i>Check the cable connections of the PC and the printer, and try again.</i>
<i>PC Data Error</i> <i>Check &amp; Press OK</i>	<i>GT-541 received the data that is not supported.</i>	<i>Confirm the printer driver version and the connection between GT-541 and the PC, and then press the OK Button.</i>
<i>Blank Data</i> <i>Check &amp; Press OK</i>	<i>GT-541 received the blank data (the data with no image).</i>	<i>Check the print setting in the application. Confirm the print area and the image is not too big to print in a single page, and then press the OK Button.</i>
<i>Received NG Data</i> <i>Check &amp; Press OK</i>	<i>GT-541 received the data that is not supported.</i>	<i>Check the printer setting in the PC, and then press the OK Button.</i>
<i>Card Not Ready</i> <i>Push OK Button</i>	<i>The data in the CompactFlash cannot be read.</i>	<i>See "7-1. Solving Printer Problems".</i>
<i>FFS: FL DATA ERROR</i>		
<i>FFS: FL SIZE ERROR</i>		
<i>FFS: FL FIND ERR</i>		
<i>Fail: CRG Speed</i>	<i>The Carriage Shaft is soiled.</i>	<i>See "7-2-8. Cleaning the Carriage Shafts".</i>
<i>Fail: CRG STOP 1</i>		

## 8. Specifications

### 8-1. Mechanical Specification

<i>Dimensions</i>	<i>1183 (W) × 940 (D) × 610 (H) mm</i>	
<i>Weight (GT-541 and the included Platen)</i>	<i>Approx. 100 Kg</i>	
<i>Maximum print area</i>	<i>14 x 16 inches (355.6 x 406.4 mm)</i>	
<i>Print Resolution</i>	<i>600 x 600 dpi</i>	
<i>Power source</i>	<i>Single-phase 115 V (+/- 10%)</i>	
<i>Power supply frequency</i>	<i>60 Hz (+/- 1)</i>	
<i>Power consumptions</i>	<i>90 VA (average)</i>	
<i>Mechanical noise</i>	<i>Lower than 70 dB</i>	
<i>Temperature and Humidity</i>	<i>For operation:</i>	<i>Temperature: 50 °F to 95 °F (10 °C to 35 °C) Humidity: 20 % to 85 % (no condensation)</i>
	<i>For the best print result</i>	<i>Temperature: 59 °F to 86 °F (15 °C to 30 °C) Humidity: 35 % to 85 % (no condensation)</i>
	<i>For storing:</i>	<i>Temperature: 32 °F to 104 °F (0 °C to 40 °C) Humidity: 20 % to 85 % (no condensation)</i>

### 8-2. Software Specification

<i>Supported OS</i>	<i>Windows 2000 Professional SP4 Windows XP Professional SP2/ Home SP2</i>
<i>Supported interface</i>	<i>USB 1.1/ 2.0, CompactFlash</i>
<i>Operation-checked application</i>	<i>Adobe Photoshop 6.0/ 7.0/ CS Adobe Photoshop Elements 3 Adobe Illustrator 10/ CS CorelDRAW 10/ 11/ 12 Paint Shop Pro 9</i>
<i>Minimum system requirements</i>	<i>256 MB RAM (512 MB or more is recommended) 128 MB free disk space (256 MB or more is recommended) 1 GHz CPU</i>

**brother**®

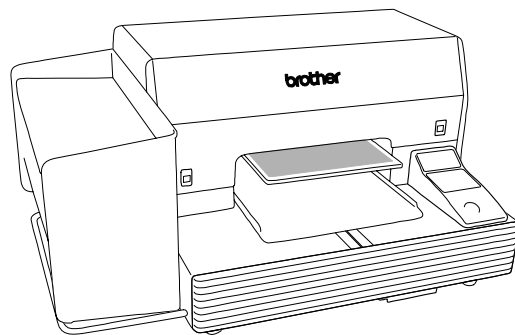

## INSTRUCTION MANUAL

**BROTHER INDUSTRIES, LTD.** <http://www.brother.com/>  
15-1, Naeshiro-cho, Mizuho-ku, Nagoya 467-8561, Japan. Phone: 81-52-824-2177

© 2005 Brother Industries, Ltd. All Rights Reserved.

GT-541  
SA6124-201  
2005.09. B (1)

## Free Manuals Download Website

<http://myh66.com>

<http://usermanuals.us>

<http://www.somanuals.com>

<http://www.4manuals.cc>

<http://www.manual-lib.com>

<http://www.404manual.com>

<http://www.luxmanual.com>

<http://aubethermostatmanual.com>

Golf course search by state

<http://golfingnear.com>

Email search by domain

<http://emailbydomain.com>

Auto manuals search

<http://auto.somanuals.com>

TV manuals search

<http://tv.somanuals.com>