

Start Here

▲ WARNING	WARNING indicates a potentially hazardous situation which, if not avoided, could result in death or serious injuries.
▲ CAUTION	CAUTION indicates a potentially hazardous situation which, if not avoided, may result in minor or moderate injuries.

1 Unpack the machine and check the components

- Note**
- The components included in the box may differ depending on your country.
 - We recommend that you save the original packaging.
 - If for any reason you must ship your machine, carefully repack the machine in the original packaging to avoid any damage during transit. The machine should be adequately insured with the carrier. For how to repack the machine, see *Packing and shipping the machine* in the *User's Guide*.
 - Illustrations in this Quick Setup Guide are based on the HL-5450DN.
 - The interface cable is not a standard accessory. Buy the appropriate interface cable for the connection you want to use (USB, parallel (HL-5440D only) or Network (HL-5450DN(T) only)).
- USB cable**
It is recommended to use a USB 2.0 (Type A/B) interface cable that is no longer than 2 meters (6 feet).
- Parallel cable (HL-5440D only)**
DO NOT use a parallel interface cable that is longer than 2 meters (6 feet). Use a shielded interface cable that is IEEE 1284-compliant.
- Network cable (HL-5450DN(T) only)**
Use a straight-through Category 5 (or greater) twisted-pair cable for 10BASE-T or 100BASE-TX Fast Ethernet Network.

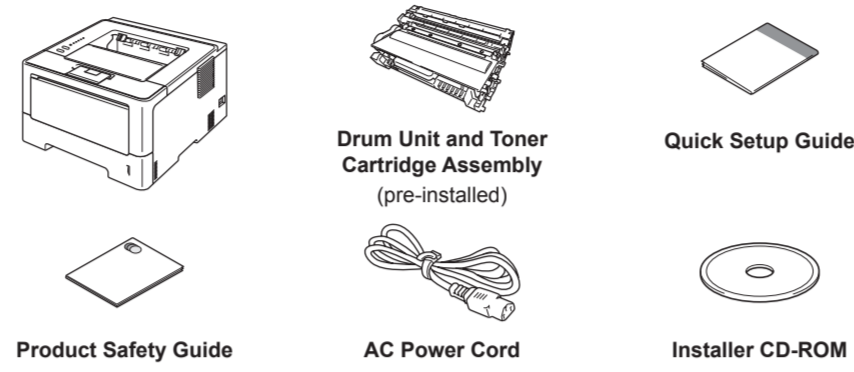

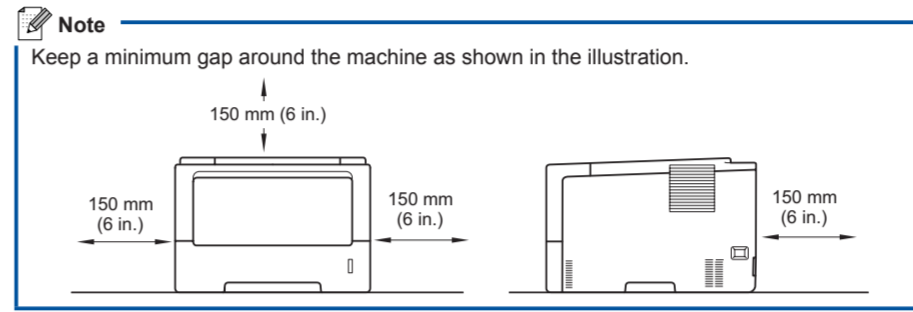

- WARNING**
- Plastic bags are used in the packing of your machine. Plastic bags are not toys. To avoid the danger of suffocation, keep these bags away from babies and children and dispose of them correctly.
 - If you use a Lower Tray, DO NOT carry the machine with the Lower Tray as you may be injured or cause damage to the machine because it is not attached to the Lower Tray.



2 Remove the packing material from the machine

- Important**
DO NOT plug in the AC power cord yet.

- Remove the packing tape from the outside of the machine.
- Open the MP tray , and remove the packing tape  from the MP tray support, then close the MP tray.

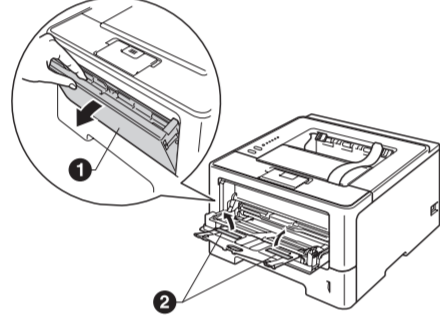

- Press the front cover release button and open the front cover. Remove the silica gel pack .

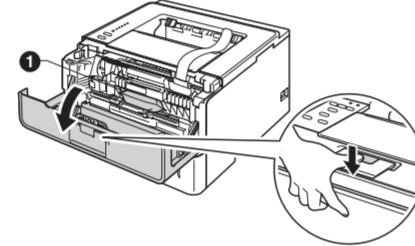

- CAUTION**
DO NOT eat the silica gel pack. Please throw away. If ingested, seek medical attention immediately.

- Take out the drum unit and toner cartridge assembly.

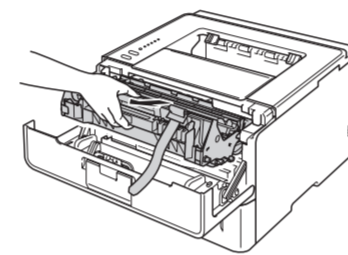

- Remove the orange protective material from the drum unit and toner cartridge assembly.

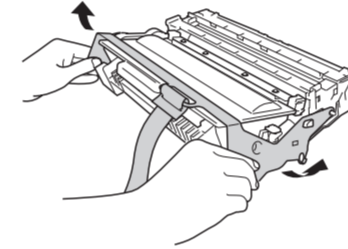

- Hold the drum unit and toner cartridge assembly level with both hands and gently shake it from side to side several times to distribute the toner evenly inside the cartridge.

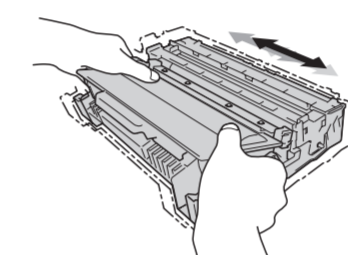

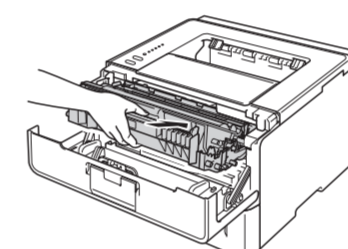

- Put the drum unit and toner cartridge assembly firmly back in the machine.
- Close the front cover of the machine.

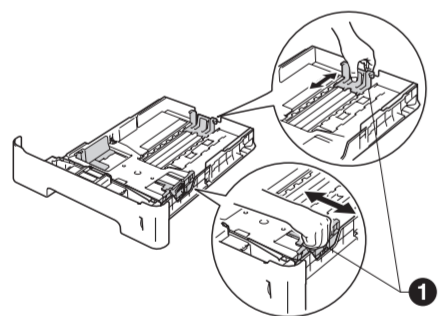

3 Load paper in the paper tray

- Pull the paper tray completely out of the machine.
- While pressing the green paper-guide release lever , slide the paper guides to fit the paper size you are loading in the tray. Make sure that the guides are firmly in the slots.



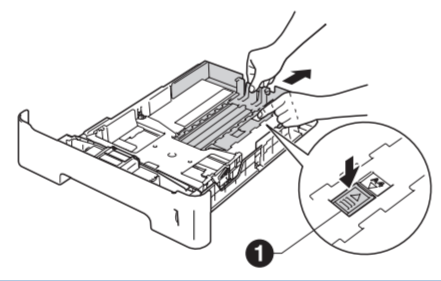

- Note**
For Legal or Folio size paper, press the release button  in the bottom of the paper tray and then pull out the back of the paper tray. (Legal or Folio size paper are not available in some regions.)

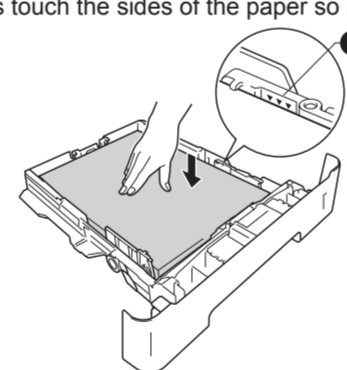

- Fan the stack of paper well to avoid paper jams and misfeeds.

- Put the paper in the tray and make sure:
 - The paper is below the maximum paper mark . Over filling the paper tray will cause paper jams.
 - The side to be printed on is face down.
 - The paper guides touch the sides of the paper so it will feed properly.



- Put the paper tray firmly back in the machine. Make sure that it is completely inserted into the machine.
- Lift up the support flap  to prevent paper from sliding off the face-down output tray.

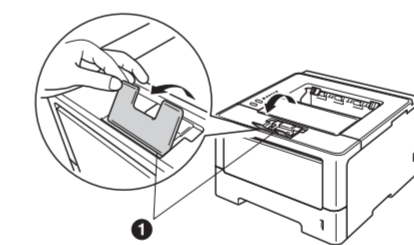

- For more information about recommended paper, see *Recommended paper and print media* in the *User's Guide*.

4 Print a test page

- Important**
DO NOT connect the interface cable yet.

- Connect the AC power cord to the machine and then connect it to an AC power outlet.

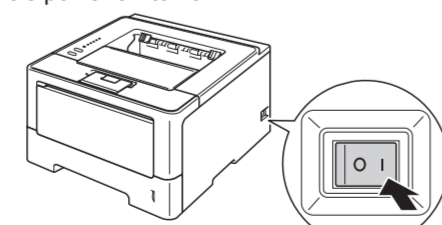

- Turn the machine's power switch on.

- After the machine has finished warming up, the **Ready** LED stops blinking and stays green.

- Press **Go**. The machine will print a test page. Check that the test page has printed correctly.

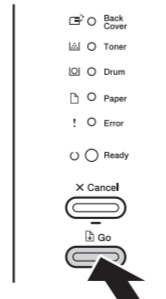































- Note**
This function will not be available after the first print job you send from your computer.





































Turn the sheet over to install the printer driver.

Printer LED Indications

Blinking:  or  or  ON:  or  or  OFF: 

	OFF	Sleep/ Deep Sleep	Warming Up/ Cooling Down ¹	Ready	Receiving Data/ Data Remaining ²
Back Cover					
Toner					
Drum					
Paper					
Error					
Ready					

	Toner Low ³	Replace Toner	Drum End Soon ³	Drum Stop	Drum Error ²
Back Cover					
Toner					
Drum					
Paper					
Error					
Ready					

	Front Cover Open	Back Cover Open ²	Jam Inside ²	No Paper	Jam Rear ²	Service Call Error ²
Back Cover						
Toner						
Drum						
Paper						
Error						
Ready						

- The LED will blink ON and OFF at 1 second intervals.
- The LED will blink ON and OFF at 0.5 second intervals.
- The yellow LED will blink in a pattern of ON for 2 seconds and then OFF for 3 seconds.

The machine continues printing until the LED indicates the replace toner message.

Options

The machine has the following optional accessories. You can expand the capabilities of the machine by adding these items. For more information about the optional Lower Tray Unit and compatible SO-DIMM Memory, visit us at <http://solutions.brother.com/>.

For installing the SO-DIMM Memory, see *Installing extra memory* in the *User's Guide*.

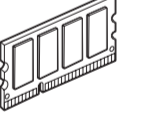
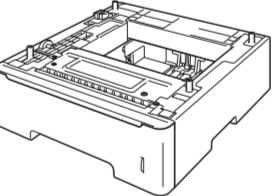
Lower Tray Unit for HL-5440D and HL-5450DN	SO-DIMM Memory (HL-5450DN(T) only)
LT-5400	You can increase the memory by installing one SO-DIMM (Small Outline Dual In-line Memory Module).
The lower paper tray unit can hold up to 500 sheets of paper. When the tray is installed, the machine expands total input capacity up to 800 sheets.	
	

Consumables

When the time comes to replace consumable items, an error will be indicated by the LEDs on the control panel. For more information about the consumables for your machine, visit us at <http://www.brother.com/original/> or contact your local Brother reseller.

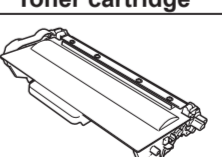
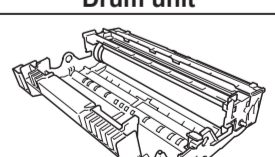
Toner cartridge	Drum unit
	

For replacing the consumable items, see *Replacing consumable items* in the *User's Guide*.

For Windows®

Before you install

Make sure that your computer is ON and you are logged on with Administrator rights.

Important

- If there are any programs running, close them.
- The screens may differ depending on your operating system.

Note

- For Windows Vista® and Windows® 7 users, when the **User Account Control** screen appears, click **Allow** or **Yes**.
- If you want to install the PS driver (BR-Script3 printer driver), choose **Custom Install** and then follow the on-screen instructions.
- Depending on your security settings, a Windows® Security or antivirus software window may appear when using the machine or its software. Please allow or permit the window to continue.
- XML Paper Specification Printer Driver**
The XML Paper Specification Printer Driver is the most suitable driver for Windows Vista® and Windows® 7 when printing from the applications that use the XML Paper Specification documents. Please download the latest driver by accessing the Brother Solutions Center at <http://solutions.brother.com/>.

5

For USB or Parallel (HL-5440D only) Interface Cable Users

- a.** Turn off the machine and make sure the USB or parallel interface cable is **NOT** connected to the machine. If you have already connected the cable, disconnect it.

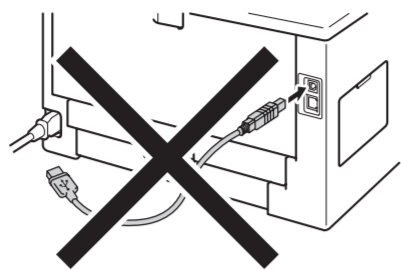

Install the printer driver

- b.** Put the installer CD-ROM into your CD-ROM drive. If prompted, select your model and language.

Note

If the Brother screen does not appear automatically, go to **My Computer (Computer)**, double-click the CD-ROM icon, and then double-click **start.exe**.

- c.** Click **Install Printer Driver**, and click **Yes** if you accept the license agreement.



- d.** Follow the on-screen instructions until this screen appears.



- e.** Connect the USB cable to the USB port marked with the symbol or the parallel cable to the parallel port on your machine, and then connect the cable to your computer.

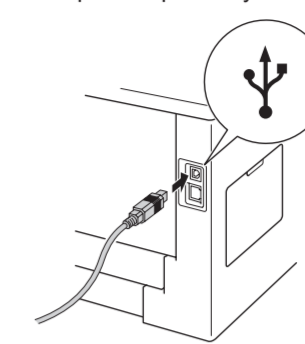

- f.** Turn the machine on, and follow the on-screen instructions to complete setup.

Finish

The installation is now complete.

5

For Wired Network Interface Cable Users (HL-5450DN(T) only)

Note

If you are going to connect the machine to your network, we recommend that you contact your system administrator prior to installation.

For Peer-to-Peer network users

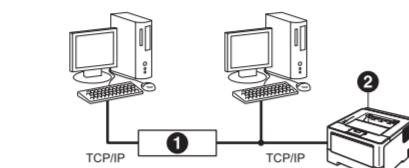

- 1 Router
- 2 Machine

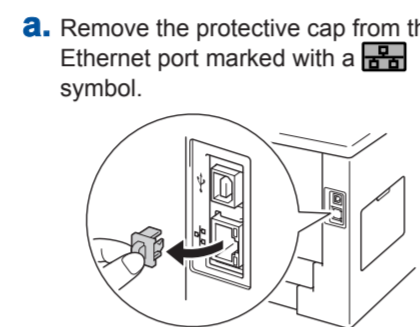

- a.** Remove the protective cap from the Ethernet port marked with a symbol.

- b.** Connect the network interface cable to the Ethernet port and then connect it to a free port on your hub.
c. Make sure your machine's power switch is on.

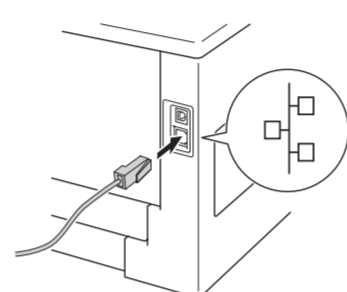

Install the printer driver

- d.** Put the installer CD-ROM into your CD-ROM drive. If prompted, select your model and language.

Note

If the Brother screen does not appear automatically, go to **My Computer (Computer)**, double-click the CD-ROM icon, and then double-click **start.exe**.

- e.** Click **Install Printer Driver**, and click **Yes** if you accept the license agreement.



- f.** Follow the on-screen instructions to complete setup.

Note

You can find your machine's IP Address and the node name by printing out the **Printer Settings Page**. See *Print the Printer Settings Page* below.

Finish

The installation is now complete.

For shared network users

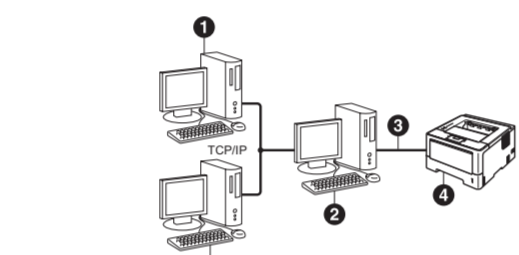

- 1 Client computer
- 2 Computer known as "Server" or "Print server"
- 3 TCP/IP or USB
- 4 Machine

Install the printer driver

- a.** Put the installer CD-ROM into your CD-ROM drive. If prompted, select your model and language.

Note

If the Brother screen does not appear automatically, go to **My Computer (Computer)**, double-click the CD-ROM icon, and then double-click **start.exe**.

- b.** Click **Install Printer Driver**, and click **Yes** if you accept the license agreement.

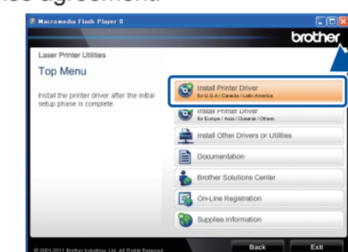

- c.** Follow the on-screen instructions until this screen appears. Choose your machine's queue, and then click **OK**.

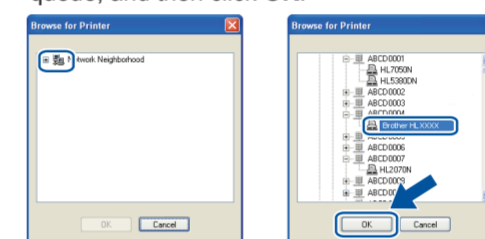

Note

Contact your administrator if you do not know the location or the name of the machine queue on the network.

- d.** Follow the on-screen instructions to complete setup.

Finish

The installation is now complete.

For Mac OS X

Before you install

Make sure your machine is connected to the power and your Macintosh is ON. You must be logged on with Administrator rights.

Important

- For users of Mac OS X 10.5.7 or lower, upgrade to Mac OS X 10.5.8 – 10.7.x. (For the latest drivers and information for the Mac OS X you are using, visit <http://solutions.brother.com/>.)

Note

- If you want to add the PS driver (BR-Script3 printer driver), please go to the Brother Solutions Center at <http://solutions.brother.com/> and visit FAQ's on your model page for instructions.

5

For USB Interface Cable Users

- a.** Connect the USB cable to the USB port marked with a on your machine, and then connect the cable to your Macintosh.
b. Make sure your machine's power switch is on.

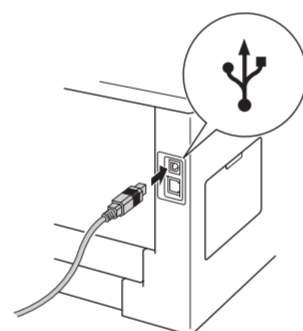

Install the printer driver

- c.** Put the installer CD-ROM into your CD-ROM drive.

- d.** Double-click the **Start Here OSX** icon. Follow the on-screen instructions.

Note

It may take a few minutes for the installation to complete.



- e.** Choose your machine from the list, and then click **OK**.

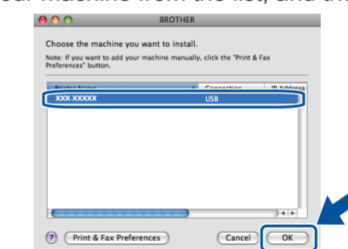

- f.** Click **Next**.

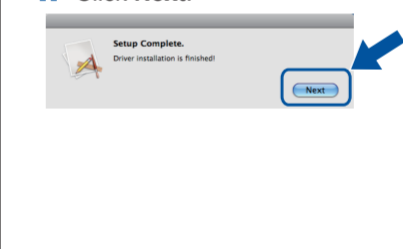

Note

When the **Brother Support** screen appears, make your selection and follow the on-screen instructions.

Finish

The installation is now complete.

5

For Wired Network Interface Cable Users (HL-5450DN(T) only)

- a.** Remove the protective cap from the Ethernet port marked with a symbol.
b. Connect the network interface cable to the Ethernet port and then connect it to a free port on your hub.
c. Make sure your machine's power switch is on.

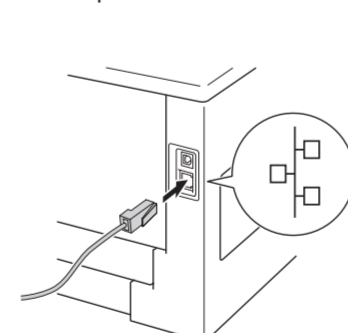
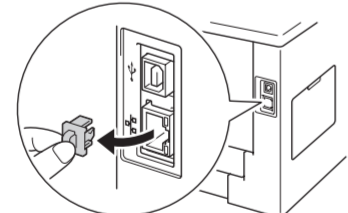

Install the printer driver

- d.** Put the installer CD-ROM into your CD-ROM drive.

- e.** Double-click the **Start Here OSX** icon. Follow the on-screen instructions.

Note

It may take a few minutes for the installation to complete.



- f.** Choose your machine from the list, and then click **OK**.

Note

- If there is more than one of the same model connected on your network, the MAC Address (Ethernet Address) will be displayed after the model name.
- You can find your machine's MAC Address (Ethernet Address) and IP Address by printing out the **Printer Settings Page**. See *Print the Printer Settings Page* below.

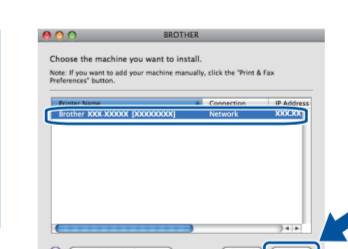

- g.** Click **Next**.

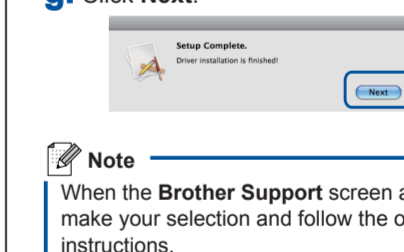

Note

When the **Brother Support** screen appears, make your selection and follow the on-screen instructions.

Finish

The installation is now complete.

For Network Users (HL-5450DN(T) only)

Web Based Management (web browser)

The Brother print server is equipped with a web server that allows you to monitor its status or change some of its configuration settings, using HTTP (Hyper Text Transfer Protocol).

Note

- We recommend Windows® Internet Explorer® 7.0/8.0 or Firefox® 3.6 for Windows® and Safari 4.0/5.0 for Macintosh. Please also make sure that JavaScript and Cookies are always enabled in whichever browser you use. To use a web browser, you will need to know the IP Address of the print server. The IP Address of the print server is listed on the **Printer Settings Page**.

- a.** Open your browser.
b. Type "<http://machine's IP address/>" into your browser's address bar (where "machine's IP address" is the IP address of the Brother machine or the print server name).
■ For example: <http://192.168.1.2/>

Note

If you have configured an optional login password, you must enter it when prompted to access the Web Based Management.

For more information, see *Web Based Management in the Network User's Guide*.

Reset the network settings to the factory default

You can reset the print server back to its default factory settings (resetting all information such as the password and IP address information).

- Turn off the machine.
- Make sure that the front cover is closed and the power cord is plugged in.
- Hold down **Go** as you turn on the power switch. Keep **Go** pressed down until all the LEDs light up and then **Ready** LED turns off.
- Release **Go**. Make sure that all the LEDs turn off.
- Press **Go** six times. Make sure that all the LEDs light up to indicate the print server has been reset to its factory default settings. The machine will restart.

Print the Printer Settings Page

The Printer Settings Page lists all the current printer settings, including network settings.

- Make sure that the front cover is closed and the power cord is plugged in.
- Turn on the machine and wait until the machine is in the Ready state.
- Press **Go** three times within 2 seconds. The machine will print the current printer settings page.

Note

For Network Users
If the **IP Address** on the Printer Settings Page shows **0.0.0.0**, wait for one minute and try again.

Brother CreativeCenter



Get inspired. If you're using Windows®, double-click the Brother CreativeCenter icon on your desktop to access our FREE web site with many ideas and resources for personal and professional use.



Mac users can access Brother CreativeCenter at this web address: <http://www.brother.com/creativecenter/>

Free Manuals Download Website

<http://myh66.com>

<http://usermanuals.us>

<http://www.somanuals.com>

<http://www.4manuals.cc>

<http://www.manual-lib.com>

<http://www.404manual.com>

<http://www.luxmanual.com>

<http://aubethermostatmanual.com>

Golf course search by state

<http://golfingnear.com>

Email search by domain

<http://emailbydomain.com>

Auto manuals search

<http://auto.somanuals.com>

TV manuals search

<http://tv.somanuals.com>