



Dell 27 Monitor - P2720D

User's Guide

Monitor Model: P2720D
Regulatory Model: P2720Dc



-  **NOTE:** A NOTE indicates important information that helps you make better use of your computer.
-  **CAUTION:** A CAUTION indicates potential damage to hardware or loss of data if instructions are not followed.
-  **WARNING:** A WARNING indicates a potential for property damage, personal injury, or death.

Copyright © 2019 Dell Inc. or its subsidiaries. All rights reserved. Dell, EMC, and other trademarks are trademarks of Dell Inc. or its subsidiaries. Other trademarks may be trademarks of their respective owners.

2019 – 11

Rev. A00

Contents

About your monitor	6
Package contents	6
Product features	8
Identifying parts and controls	9
Front view	9
Back view	10
Side view.	11
Bottom view	12
Monitor specifications	13
Resolution specifications	14
Supported video modes	14
Preset display modes	15
Electrical specifications.	15
Physical characteristics.	16
Environmental characteristics	17
Power management modes	18
Plug and play capability	24
LCD monitor quality and pixel policy	24
Maintenance guidelines	24
Cleaning your monitor.	24
Setting up the monitor	25
Attaching the stand	25



Connecting your monitor	27
Connecting the DP and USB 3.0 cable	27
Organizing cables	28
Removing the stand	29
Wall mounting (optional)	30
Operating your monitor	31
Power on the monitor	31
Using the control buttons	32
OSD controls	33
Using the On-Screen Display (OSD) menu	34
Accessing the OSD menu	34
Menu and Power button lock	45
OSD warning messages	47
Setting up your monitor	50
Setting the maximum resolution	50
If you have a Dell desktop or a Dell portable computer with internet access	50
If you have a non Dell desktop, portable computer, or graphics card	51
Using the tilt, swivel, and vertical extension	52
Tilt, Swivel.	52
Vertical Extension	52
Rotating the Monitor	53
Troubleshooting	55
Self-Test	55
Built-in diagnostics	56



Common problems 57
Product-specific problems 61
Appendix. 62
Safety Instructions. 62
FCC notices (U.S. Only) and other regulatory information 62
Contacting Dell. 63







About your monitor

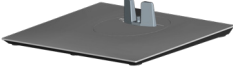

Package contents

Your monitor ships with the components shown below. Ensure that you have received all the components and see [Contacting Dell](#) for more information if something is missing.

NOTE: Some items may be optional and may not ship with your monitor. Some features or media may not be available in certain countries.

	Monitor
	Stand riser
	Stand base
	Power cable (varies by countries)



	<p>DP 1.2 cable</p>
	<p>USB 3.0 upstream cable (enables the USB ports on the monitor)</p>
	<ul style="list-style-type: none"> • Quick Setup Guide • Safety and Regulatory Information



Product features

The Dell P2720D monitor has an active matrix, Thin-Film Transistor (TFT), Liquid Crystal Display (LCD), anti-static, and LED backlight. The monitor features include:

- 68.47 cm (27.0 in.) viewable area display (measured diagonally). 2560 x 1440 resolution, with full-screen support for lower resolutions.
- Wide viewing angle to allow viewing from a sitting or standing position, or while moving from side-to-side.
- Color gamut of 99% sRGB.
- High Dynamic Contrast Ratio.
- Tilt, swivel, height, and rotate adjustment capabilities.
- Removable stand and Video Electronics Standards Association (VESA™) 100 mm mounting holes for flexible mounting solutions.
- Digital connectivity with DisplayPort and HDMI.
- Equipped with 1 USB upstream port and 4 USB downstream ports.
- Plug and play capability if supported by your system.
- On-Screen Display (OSD) adjustments for ease of set-up and screen optimization.
- Software and documentation media includes an Information File (INF), Image Color Matching File (ICM), and product documentation.
- Security lock slot.
- Stand lock.
- Capability to switch from wide aspect to standard aspect ratio while maintaining the image quality.
- 0.3 W standby power when in the sleep mode.
- Optimize eye comfort with a flicker-free screen.

⚠ WARNING: The possible long-term effects of blue light emission from the monitor may cause damage to the eyes, including eye fatigue, digital eye strain, and so on. ComfortView feature is designed to reduce the amount of blue light emitted from the monitor to optimize eye comfort.



Identifying parts and controls

Front view

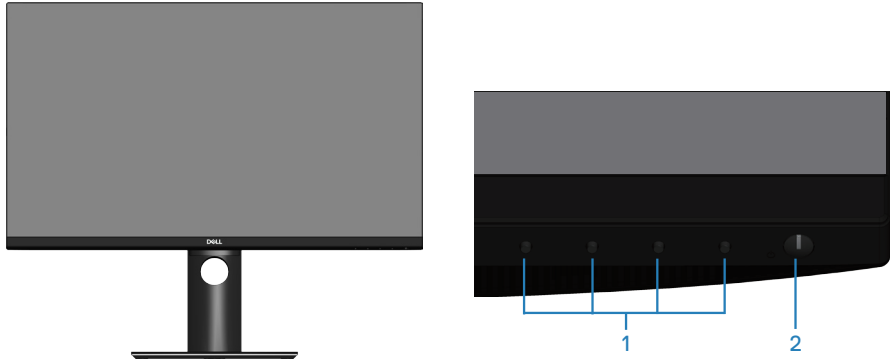

Control buttons

Label	Description	Use
1	Function buttons	Use the function buttons to adjust items in the OSD menu. (For more information, see Using the control buttons)
2	Power On/Off button	Use the power button to turn the monitor On and Off.



Back view

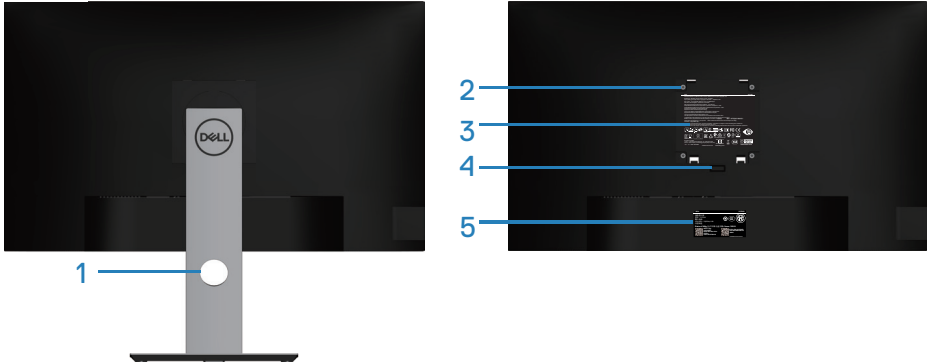



Back View with monitor stand

Label	Description	Use
1	Cable management slot	Use to organize cables by routing them through the slot.
2	VESA mounting holes (behind VESA cover)	VESA mounting holes (100 mm x 100 mm). Use for Wall mounting the monitor through a VESA-compatible wall mount kit.
3	Regulatory information label	Lists the regulatory approvals.
4	Stand release button	Releases stand from monitor.
5	Regulatory label (including Barcode serial number and Service Tag label)	Lists the regulatory approvals. Refer to this label if you need to contact Dell for technical support. The Service Tag is a unique alphanumeric identifier that enables Dell service technicians to identify the hardware components in your computer and access warranty information.

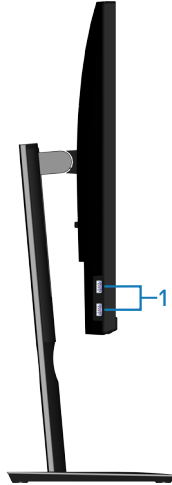

Side view



Label	Description	Use
1	USB 3.0 downstream port x 2	Connect your USB device.  NOTE: To use this port, you must connect the USB cable (shipped with your monitor) to the USB-upstream port on the monitor and to your computer.



Bottom view

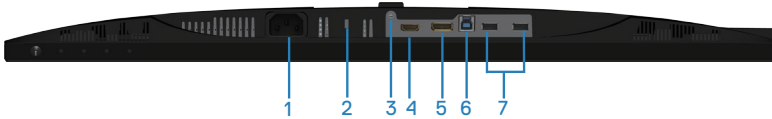

Bottom view without monitor stand

Label	Description	Use
1	Power connector	Connect the power cable (shipped with your monitor).
2	Security-lock slot	Secure your monitor using a security lock (purchased separately) to prevent unauthorized movement of your monitor.
3	Stand lock feature	To lock the stand to the monitor using a M3 x 6 mm screw (screw not included).
4	HDMI port	Connect your computer with HDMI cable.
5	DisplayPort	Connect your computer with DisplayPort cable (shipped with your monitor).
6	USB 3.0 upstream port	Connect the USB cable from this port to your computer to enable the USB ports on your monitor.
7	USB 2.0 downstream ports x 2	Connect your USB device.  NOTE: To use this port, you must connect the USB upstream cable (shipped with your monitor) between the monitor and the computer.



Monitor specifications

Model	P2720D
Screen type	Active matrix-TFT LCD
Panel type	In-Plane Switching Technology
Viewable image	
Diagonal	684.70 mm (27.0 in.)
Horizontal, Active Area	596.74 mm (23.49 in.)
Vertical, Active Area	335.66 mm (13.76 in.)
Area	200,301.75 mm ² (323.22 in. ²)
Pixel pitch	0.233 mm x 0.233 mm
Pixel per inch (PPI)	108
Viewing angle	
Horizontal	178° (typical)
Vertical	178° (typical)
Luminance output	350 cd/m ² (typical)
Contrast ratio	1000 to 1 (typical)
Faceplate coating	Anti-glare with 3H hardness, Haze 25%
Backlight	LED edgelight system
Response time (Gray to Gray)	
	8 ms (Normal)
	5 ms (Fast)
Color depth	1.67 billion colors
Color gamut	99% sRGB
Connectivity	1 x HDMI 1.4 1 x DP 1.2 1 x USB 3.0 upstream 2 x USB 3.0 port - Side 2 x USB 2.0 port - Bottom



Bezel width (edge of monitor to active area)	
Top	7.4 mm
Left/Right	7.4 mm
Bottom	21.1 mm
Adjustability	
Height adjustable stand	130 mm
Tilt	-5° to 21°
Swivel	-45° to 45°
Pivot	-90° to 90°
Dell display manager compatibility	Easy Arrange and other key features
Security	Security-lock slot (cable lock optional purchase)

Resolution specifications

Model	P2720D
Horizontal scan range	29 kHz to 113 kHz
Vertical scan range	49 Hz to 75 Hz (automatic)
Maximum preset resolution	2560 x 1440 at 60 Hz

Supported video modes

Model	P2720D
Video display capabilities (HDMI/DP)	480i, 480p, 576i, 576p, 720p, 1080i, 1080p, 1440p



Preset display modes

Display Mode	Horizontal Frequency (kHz)	Vertical Frequency (Hz)	Pixel Clock (MHz)	Sync Polarity (Horizontal / Vertical)
VESA, 720 x 400	31.5	70.1	28.3	-/+
VESA, 640 x 480	31.5	59.9	25.2	-/-
VESA, 640 x 480	37.5	75.0	31.5	-/-
VESA, 800 x 600	37.9	60.3	40.0	+/+
VESA, 800 x 600	46.9	75.0	49.5	+/+
VESA, 1024 x 768	48.4	60.0	65.0	-/-
VESA, 1024 x 768	60.0	75.0	78.8	+/+
VESA, 1152 x 864	67.5	75.0	108.0	+/+
VESA, 1280 x 768	47.8	59.9	79.5	-/+
VESA, 1280 x 1024	64.0	60.0	108.0	+/+
VESA, 1280 x 1024	79.9	75.0	135.0	+/+
VESA, 1600 x 1200	75.0	60.0	162.0	+/+
VESA, 1680 x 1050	65.3	60.0	146.3	-/+
VESA, 1920 x 1080	67.5	60.0	148.5	+/+
VESA, 1920 x 1200	74.6	59.9	193.3	-/+
VESA, 2048 x 1080	66.6	60.0	147.2	+/-
VESA, 2560 x 1440	88.8	60.0	241.5	+/-

Electrical specifications

Model	P2720D
Video input signals	HDMI 1.4, 600 mV for each differential line, 100 ohm input impedance per differential pair DP 1.2, 600 mV for each differential line, 100 ohm input impedance per differential pair
AC input voltage/frequency/current	100 VAC to 240 VAC / 50 Hz or 60 Hz \pm 3 Hz / 1.6 A (typical)
Inrush current	120 V: 30 A (Max.) at 0 °C (cold start) 240 V: 60 A (Max.) at 0 °C (cold start)



Physical characteristics

Model	P2720D
Signal cable type	<ul style="list-style-type: none"> • Digital: DP, 20 pins • Universal Serial Bus: USB, 9 pins
Dimensions (with stand)	
Height (extended)	525.3 mm (20.68 in.)
Height (compressed)	395.3 mm (15.56 in.)
Width	611.6 mm (24.08 in.)
Depth	185.0 mm (7.28 in.)
Dimensions (without stand)	
Height	364.1 mm (14.34 in.)
Width	611.6 mm (24.08 in.)
Depth	43.6 mm (1.72 in.)
Stand dimensions	
Height (extended)	418.4 mm (16.47 in.)
Height (compressed)	371.0 mm (14.61 in.)
Width	245.0 mm (9.65 in.)
Depth	185.0 mm (7.28 in.)
Weight	
Weight with packaging	9.13 kg (20.13 lb)
Weight with stand assembly and cables	6.87 kg (15.15 lb)
Weight without stand assembly (no cables)	4.57 kg (10.08 lb)
Weight of stand assembly	1.85 kg (4.08 lb)
Front-frame gloss	Black frame 2-4 gloss units



Environmental characteristics

Model	P2720D
Compliant Standards	
<ul style="list-style-type: none"> • ENERGY STAR certified monitor • EPEAT registered where applicable. EPEAT registration varies by country. See www.epeat.net for registration status by country. • TCO-certified display. • RoHS-compliant • BFR/PVC free monitor (excluding external cables) • Meets NFPA 99 leakage current requirements. • Arsenic-free glass and Mercury-free for the panel only • Energy Gauge shows the energy level being consumed by the monitor in real time. 	
Temperature	
Operating	0 °C to 40 °C (32 °F to 104 °F)
Non-operating	<ul style="list-style-type: none"> • Storage: -20 °C to 60 °C (-4 °F to 140 °F) • Shipping: -20 °C to 60 °C (-4 °F to 140 °F)
Humidity	
Operating	10% to 80% (non-condensing)
Non-operating	<ul style="list-style-type: none"> • Storage 10% to 90% (non-condensing) • Shipping 10% to 90% (non-condensing)
Altitude	
Operating (maximum)	5,000 m (16,400 ft)
Non-operating (maximum)	12,192 m (40,000 ft)
Thermal dissipation	<ul style="list-style-type: none"> • 188.10 BTU/hour (maximum) • 82.08 BTU/hour (typical)



Power management modes

If you have VESA's DPM compliance display card or software installed in your PC, the monitor can automatically reduce its power consumption when not in use. This is referred to as Power Save Mode*. If the computer detects input from the keyboard, mouse or other input devices, the monitor automatically resumes functioning. The following table shows the power consumption and signaling of this automatic power saving feature.

* Zero power consumption in off mode can only be achieved by disconnecting the power cable from the monitor.

VESA Modes	Horizontal Sync	Vertical Sync	Video	Power Indicator	Power Consumption
Normal operation	Active	Active	Active	White	55 W (maximum)** 24 W (typical)
Active-off mode	Inactive	Inactive	Blanked	White (Glowing)	Less than 0.3 W
Switch off	-	-	-	Off	Less than 0.3 W

Power Consumption P_{ON}	19 W
Total Energy Consumption (TEC)	60 kWh

** Maximum power consumption with max luminance, and USB active.

This document is informational only and reflects laboratory performance. Your product may perform differently, depending on the software, components and peripherals you ordered and shall have no obligation to update such information. Accordingly, the customer should not rely upon this information in making decisions about electrical tolerances or otherwise. No warranty as to accuracy or completeness is expressed or implied.



NOTE: This monitor is ENERGY STAR certified.

This product qualifies for ENERGY STAR in the factory default settings which can be restored by "Factory Reset" function in the OSD menu. Changing the factory default settings or enabling other features may increase power consumption that could exceed the ENERGY STAR specified limit.



 **NOTE:**

P_{ON}: Power consumption of On Mode as defined in Energy Star 8.0 version.

TEC: Total energy consumption in KWh as defined in Energy Star 8.0 version.



DisplayPort connector

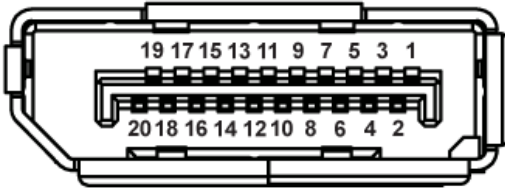

Pin Number	20-pin Side of the Connected Signal Cable
1	ML0 (p)
2	GND
3	ML0 (n)
4	ML1 (p)
5	GND
6	ML1 (n)
7	ML2 (p)
8	GND
9	ML2 (n)
10	ML3 (p)
11	GND
12	ML3 (n)
13	GND
14	GND
15	AUX (p)
16	GND
17	AUX (n)
18	Hot Plug Detect
19	Re-PWR
20	+3.3 V DP_PWR



Universal serial bus (USB) interface

This section gives you information about the USB ports that are available on the monitor.

NOTE: This monitor is Super-Speed USB 3.0 and High-Speed USB 2.0 compatible.

Transfer Speed	Data Rate	Power Consumption*
Super-speed	5 Gbps	4.5 W (Max, each port)
High speed	480 Mbps	4.5 W (Max, each port)
Full speed	12 Mbps	4.5 W (Max, each port)

Transfer Speed	Data Rate	Power Consumption*
High speed	480 Mbps	2.5 W (Max, each port)
Full speed	12 Mbps	2.5 W (Max, each port)
Low speed	1.5 Mbps	2.5 W (Max, each port)

USB 3.0 upstream connector

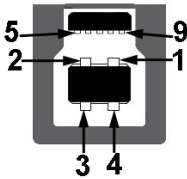

Pin Number	9-pin Side of the Connector
1	VCC
2	D-
3	D+
4	GND
5	SSTX-
6	SSTX+
7	GND



8	SSRX-
9	SSRX+

USB 3.0 downstream connector



Pin Number	9-pin Side of the Connector
1	VCC
2	D-
3	D+
4	GND
5	SSRX-
6	SSRX+
7	GND
8	SSTX-
9	SSTX+

USB 2.0 downstream connector

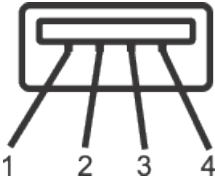

Pin Number	4-pin Side of the Connector
1	VCC
2	DMD
3	DPD
4	GND



USB ports

- 1 x USB 3.0 upstream - bottom
- 2 x USB 2.0 downstream - bottom
- 2 x USB 3.0 downstream - side



NOTE: USB 3.0 functionality requires a USB 3.0-capable computer.



NOTE: The monitor's USB interface works only when the monitor is On or in the power save mode. If you turn Off the monitor and then turn it On, the attached peripherals may take a few seconds to resume normal functionality.



Plug and play capability

You can install the monitor in any Plug and Play-compatible system. The monitor automatically provides the computer system with its Extended Display Identification Data (EDID) using Display Data Channel (DDC) protocols so the system can configure itself and optimize the monitor settings. Most monitor installations are automatic, you can select different settings if desired. For more information about changing the monitor settings, see [Operating your monitor](#).

LCD monitor quality and pixel policy

During the LCD Monitor manufacturing process, it is not uncommon for one or more pixels to become fixed in an unchanging state which are hard to see and do not affect the display quality or usability. For more information on Dell Monitor Quality and Pixel Policy, see Dell Support site at www.dell.com/support/monitors.

Maintenance guidelines

Cleaning your monitor

 **WARNING: Before cleaning the monitor, unplug the monitor power cable from the electrical outlet.**

 **CAUTION: Read and follow the [Safety Instructions](#) before cleaning the monitor.**

For best practices, follow the instructions in the list below while unpacking, cleaning or handling your monitor:

- To clean your screen, lightly dampen a soft, clean cloth with water. If possible, use a special screen-cleaning tissue or solution suitable for the anti-static coating. Do not use benzene, thinner, ammonia, abrasive cleaners or compressed air.
- Use a lightly-dampened cloth to clean the monitor. Avoid using detergent of any kind as some detergents leave a milky film on the monitor.
- If you notice white powder when you unpack your monitor, wipe it off with a cloth.
- Handle your monitor with care as the black-colored monitor may get scratched and show white scuff marks.
- To help maintain the best image quality on your monitor, use a dynamically changing screen saver and turn off your monitor when not in use.



Setting up the monitor

Attaching the stand

 **NOTE:** The stand is detached when the monitor is shipped from the factory.

 **NOTE:** This is applicable for a monitor with a stand. If you have purchased a third-party stand refer to the respective stand setup guide for the set up instructions.

To attach the monitor stand.

1. Follow the instructions on the flaps of carton to remove the stand from the top cushion that secures it.
2. Insert the stand base blocks fully into the stand slot.
3. Lift the screw handle and turn the screw clockwise.
4. After fully tightening the screw, fold the screw handle flat within the recess.

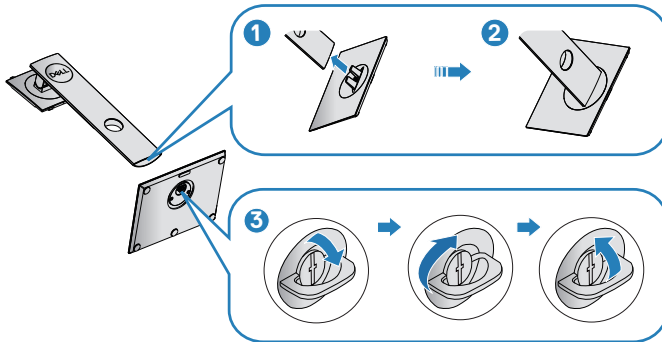

5. Lift the cover to expose the VESA area for stand assembly.



- 6.** Attach the stand assembly to the monitor.
- a.** Fit the two tabs on the upper part of the stand to the groove on the back of the monitor.
 - b.** Press the stand down till it snaps into place.

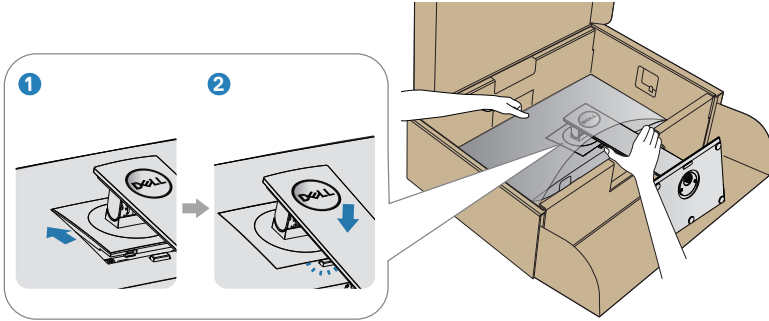

- 7.** Place the monitor upright.



Connecting your monitor

⚠ WARNING: Before you begin any of the procedures in this section, follow the [Safety Instructions](#).

✎ NOTE: Do not connect all cables to the computer at the same time. It is recommend to route the cables through the cable-management slot before you connect them to the monitor.

To connect your monitor to the computer:

1. Turn Off your computer and disconnect the power cable.
2. Connect the DP cable from your monitor to the computer.

Connecting the DP and USB 3.0 cable

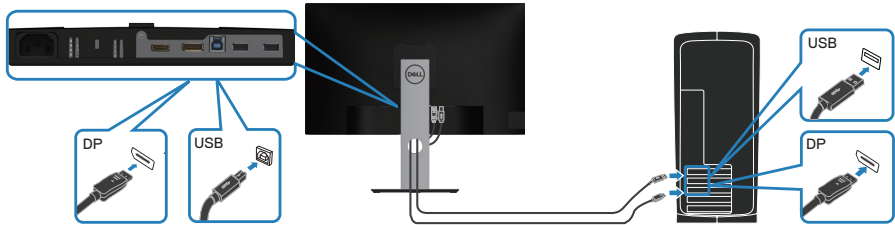

1. Connect the USB upstream cable (shipped with your monitor) to an appropriate USB 3.0 port on your computer. (See [Bottom view](#) for details.)
2. Connect the USB 3.0 peripherals to the downstream USB 3.0 ports on the monitor.
3. Connect the power cables from your computer and monitor into a wall outlet.



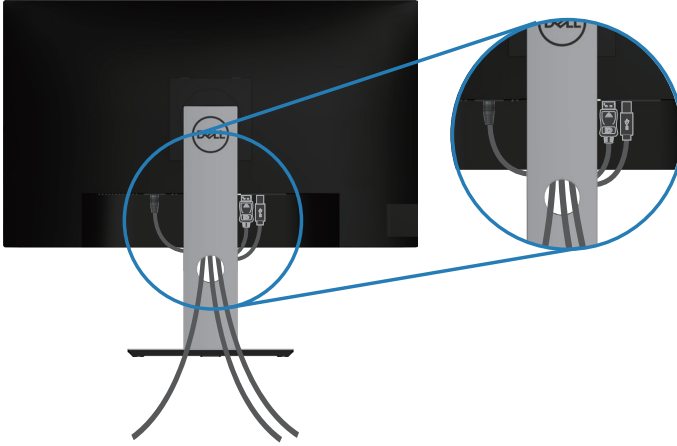

Organizing cables

Use the cable-management slot to route the cables connected to your monitor.



Removing the stand

-  **NOTE:** To prevent scratches on the screen when removing the stand, ensure that the monitor is placed on a soft and clean surface.
-  **NOTE:** The following procedure is applicable only for the stand that shipped with your monitor. If you are connecting a third-party stand, see the documentation that shipped with the stand.

To remove the stand:

1. Place the monitor on a soft cloth or cushion.
2. Press and hold the stand release button.
3. Lift the stand up and away from the monitor.

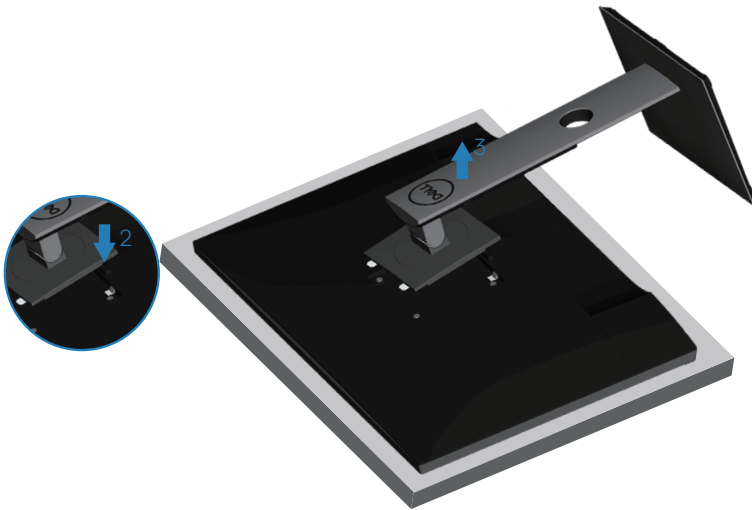

Wall mounting (optional)

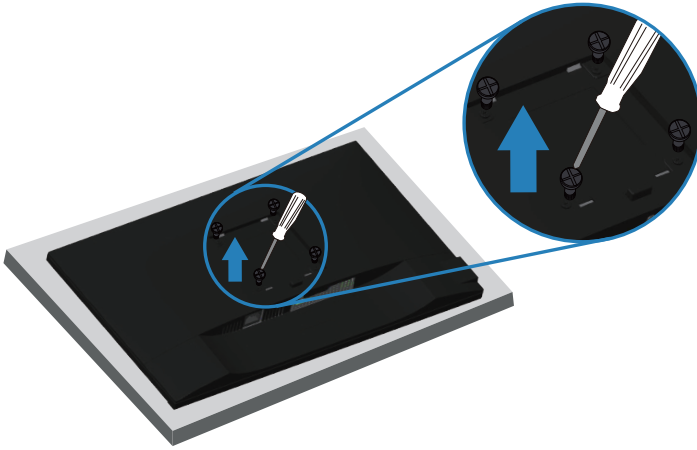

(Screw dimension: M4 x 10 mm).

See the documentation that shipped with the VESA-compatible wall mounting kit.

1. Lay the monitor on a soft cloth or cushion at the edge of the desk.
2. Remove the stand. See [Removing the stand](#) for details.
3. Remove the four screws that secure the panel to the monitor.
4. Attach the mounting bracket from the wall mounting kit to the monitor.
5. To mount the monitor on the wall, see the documentation that shipped with the wall mounting kit.

 **NOTE: For use only with UL or CSA or GS-listed wall mount bracket with minimum weight/load bearing capacity of 18.28 kg.**



Operating your monitor

Power on the monitor

Press the  button to turn on the monitor.

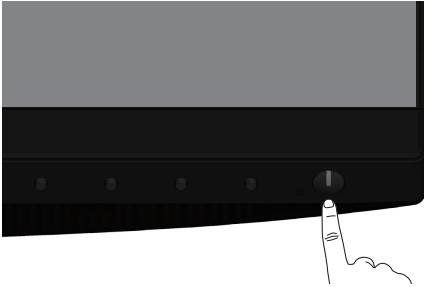

Language options

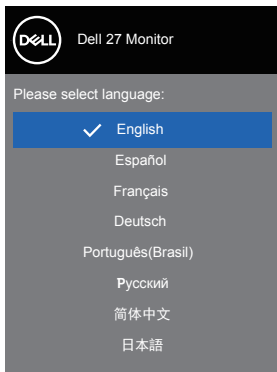



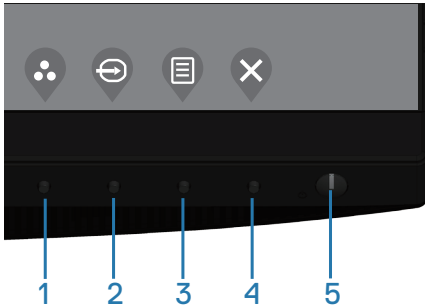

Using the control buttons

Use the control buttons at the front of the monitor to adjust the settings on your monitor.



Control buttons

The following table describes the control buttons





Control Buttons	Description
1  Shortcut key/Presets Modes	Use this button for choose from a list of preset modes.
2  Shortcut key/Input Source	Use the input source menu to select between the different video signals that may be connected to your monitor.
3  Menu	Use the Menu button at launch your on-screen display (OSD) and select the OSD menu. See Accessing the OSD menu.
4  Exit	Use this button to go back to the main menu or exit the OSD main menu.
5  Power On/Off button (with LED indicator)	Use the power button to turn the monitor on and off. Solid white light indicates the monitor is turned on. Blinking white light indicates it is in power-save mode.

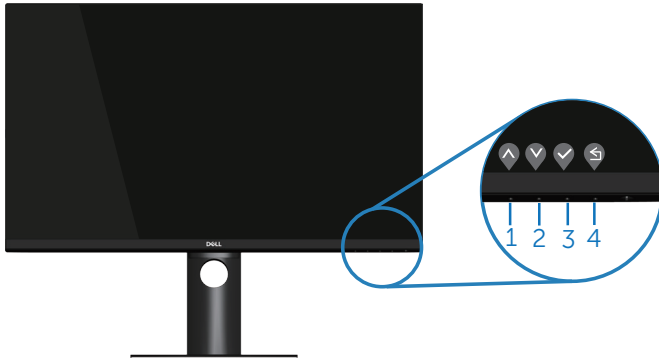

OSD controls

Use the buttons on the front of the monitor to adjust the image settings.





	Control Buttons	Description
1	 Up	Use the Up button to increase values or move up in a menu.
2	 Down	Use the Down button to decrease values or move down in a menu.
3	 OK	Use the OK button to confirm your selection in a menu.
4	 Back	Use the Back button to go back to the previous menu.















Using the On-Screen Display (OSD) menu

Accessing the OSD menu







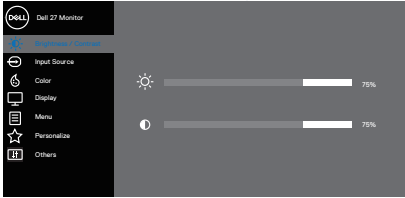

 **NOTE:** Any changes you make are automatically saved when you move to another menu, exit the OSD menu, or wait for the OSD menu to automatically close.

1. Press the  button to display the OSD main menu.



2. Press the  and  buttons to move between the setting options. As you move from one icon to another, the option is highlighted.
3. Press the , , or  button once to activate the highlighted option.
4. Press  and  button to select the desired parameter.
5. Press  and then use the  and  buttons, according to the indicators on the menu, to make your changes.
6. Select the  to return to previous menu or  to accept and return to previous menu.



Icon	Menu and Sub-menus	Description
	Brightness/ Contrast	<p>Use this menu to activate Brightness/Contrast adjustment.</p>  <p style="text-align: right;">     </p>
	Brightness	<p>Brightness adjusts the luminance of the backlight.</p> <p>Press the  button to increase the brightness and press the  button to decrease the brightness (min. 0 / max. 100).</p>
	Contrast	<p>Adjust the brightness first, and then adjust the contrast only if further adjustment is necessary.</p> <p>Press the  button to increase the contrast and press the  button to decrease the contrast (min. 0 / max. 100).</p> <p>The contrast function adjusts the degree of difference between darkness and lightness on the monitor screen.</p>





Input Source

Use the input source menu to select between the different video signals that may be connected to your monitor.

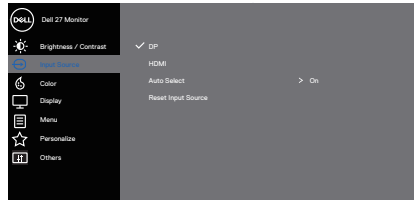

DP

Select DP input when you are using the DP connector. Push  to select the DP input source.

HDMI

Select HDMI input when you are using the HDMI connector. Push  to select the HDMI input source.

Auto Select

Select auto select to scan for available input signals.

Reset Input Source

Select this option to restore default Input Source.



Color

Use color to adjust the color setting mode.

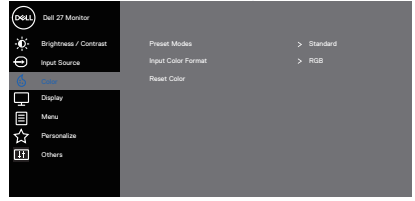

Preset Modes













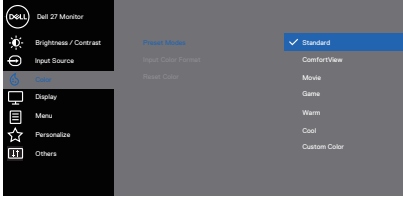

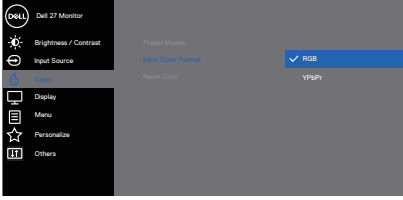

When you select **preset modes**, you can choose **Standard**, **Comfortview**, **Movie**, **Game**, **Warm**, **Cool**, or **Custom color** from the list.

- **Standard:** Loads the monitor's default color settings. This is the default preset mode.
- **ComfortView:** Decreases the level of blue light emitted from the screen to make viewing more comfortable for your eyes.













 **NOTE:** To reduce the risk of eye strain and neck/arm/back/shoulders pain from using the monitor for long periods of time, we suggest you to:

- Set the screen about 20 to 28 in. (50-70 cm) from your eyes.
- Blink frequently to moisten or rewet your eyes when working with the monitor.
- Take regular and frequent breaks for 20 minutes every two hours.
- Look away from your monitor and gaze at a distant object at 20 feet away for at least 20 seconds during the breaks.
- Perform stretches to relieve tension in the neck/arm/back/ shoulders during the breaks.
- **Movie:** Loads color settings ideal for movies.
- **Game:** Loads color settings ideal for most gaming applications.
- **Warm:** Increases the color temperature. The screen appears warmer with a red/yellow tint.
- **Cool:** Decreases the color temperature. The screen appears cooler with a blue tint.
- **Custom Color:** Allows you to manually adjust the color settings.

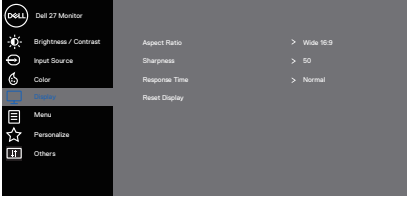

		<p>Press the  and  buttons to adjust the three colors (R, G, B) values and create your own preset color mode.</p>  <p style="text-align: right;">   </p>
	<p>Input Color Format</p>	<p>Allows you to set the video input mode to:</p> <ul style="list-style-type: none"> • RGB: Select this option if your monitor is connected to a computer or DVD player using the HDMI cable. • YPbPr: Select this option if your DVD player supports only YPbPr output.  <p style="text-align: right;">   </p>
	<p>Hue</p>	<p>This feature can shift the color of the video image to green or purple. This is used to adjust the desired flesh tone color. Use  or  to adjust the hue from 0 to 100.</p> <p>Press  to increase the green shade of the video image.</p> <p>Press  to increase the purple shade of the video image.</p> <p> NOTE: Hue adjustment is available only when you select Movie and Game mode.</p>



	<p>Saturation</p>	<p>This feature can adjust the color saturation of the video image. Use  or  to adjust the saturation from 0 to 100.</p> <p>Press  to increase the monochrome appearance of the video image.</p> <p>Press  to increase the colorful appearance of the video image.</p> <p> NOTE: Saturation adjustment is available only when you select Movie and Game mode.</p>
	<p>Reset Color</p>	<p>Allows your monitor color settings to the factory settings.</p>
	<p>Display</p>	<p>Use the display to adjust image.</p>  <p style="text-align: right;">   </p>
	<p>Aspect Ratio</p>	<p>Adjusts the image ratio to wide 16:9, 4:3 or 5:4</p>
	<p>Sharpness</p>	<p>This feature can make the image look sharper or softer. Use  or  to adjust the sharpness from 0 to 100.</p>
	<p>Response Time</p>	<p>User can select between fast or normal.</p>
	<p>Reset Display</p>	<p>Select this option to restore default display settings.</p>



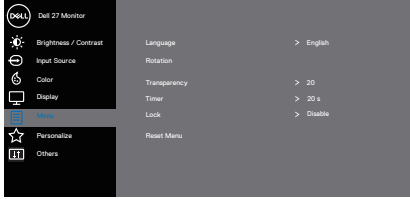

Menu	<p>Select this option to adjust the settings of the OSD, such as, the languages of the OSD, the amount of time the menu remains on screen and so on.</p>  <p style="text-align: right;">▲ ▼ ▶ ✕</p>
Language	<p>Language options set the OSD display to one of the eight languages (English, Spanish, French, German, Brazilian Portuguese, Russian, Simplified Chinese, or Japanese).</p>
Rotation	<p>Rotates the OSD by 90 degrees counter-clockwise. You can adjust the menu according to your display rotation.</p>
Transparency	<p>Select this option to change the menu transparency by pressing the ▲ and ▼ buttons from 0 to 100.</p>
Timer	<p>OSD hold time: sets the length of time the OSD will remain active after the last time you pressed a button. Use ▲ or ▼ to adjust the slider in 1 second increments, from 5 to 60 seconds.</p>
Lock	<p>Controls user access to adjustments. User can select one of the following: Menu Buttons, Power Button, Menu + Power Buttons, Disable. (For more information, see Menu and Power button lock).</p>
Reset Menu	<p>Reset all OSD settings to the factory preset values.</p>





Personalize

Select this option to adjust the settings of the personalization.

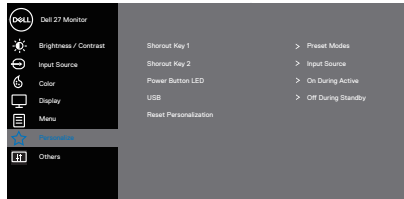

Shortcut Key 1

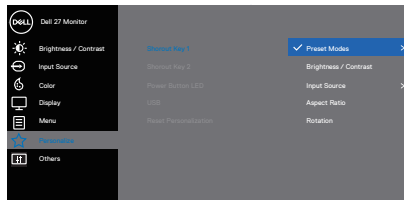

User can select one of the following: Preset Modes, Brightness/Contrast, Input Source, Aspect Ratio, Rotation to set the shortcut key 1.

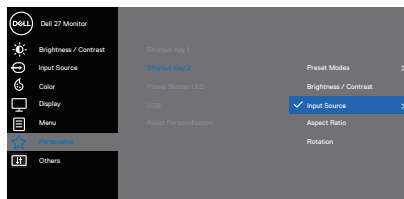

Shortcut Key 2

User can select one of the following: Preset Modes, Brightness/Contrast, Input Source, Aspect Ratio, Rotation to set the shortcut key 2.

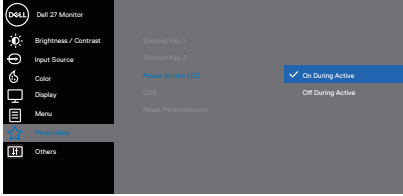

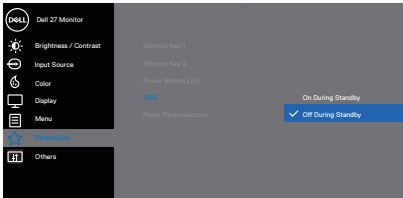
<p>Power Button LED</p>	<p>Allows you to set the power LED indicator On During Active or Off During Active to save energy.</p>  <p style="text-align: right;">▲ ▼ ✓ ↻</p>
<p>USB</p>	<p>Allows you to enable or disable USB function during monitor standby mode.</p> <p> NOTE: USB ON/OFF under standby mode is only available when USB upstream cable unplugged. This option will be grey out when USB upstream cable plug in.</p>  <p style="text-align: right;">▲ ▼ ✓ ↻</p>
<p>Reset Personalization</p>	<p>Reset all settings under the personalize menu to the default setting.</p>





Others

Select this option to adjust the OSD settings, such as the DDC/CI, LCD conditioning, and so on.

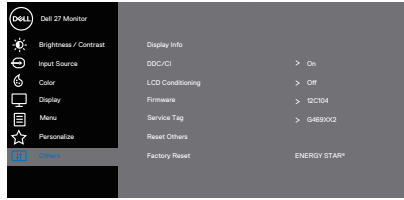

Display Info

Displays the monitor's current settings.

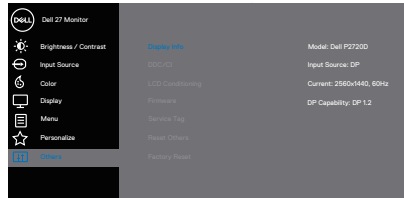

DDC/CI

DDC/CI (display data channel/command interface) allows your monitor parameters (brightness, color balance and etc.) to be adjustable via the software on your computer.

You can disable this feature by selecting off.

Enable this feature by selecting on for best user experience and optimum performance of your monitor.

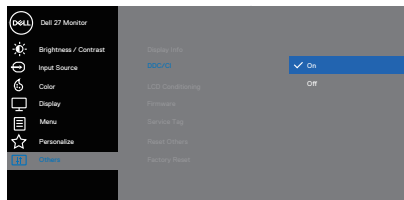

LCD Conditioning

Helps reduce minor cases of image retention. Depending on the degree of image retention, the program may take some time to run. To start LCD conditioning, select on.

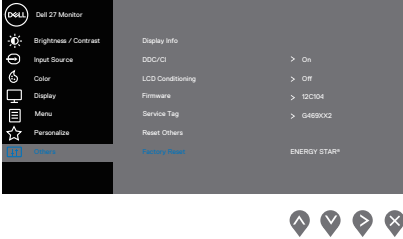

	<p>Firmware</p>	<p>Display the version of the firmware about the display.</p>
	<p>Service Tag</p>	<p>Display the service tag number of the display. The Service Tag is a unique alphanumeric identifier that allows Dell to identify the product specifications and access warranty information.</p> <p> NOTE: The Service Tag is also printed on a label located at the back of the cover.</p>
	<p>Reset Others</p>	<p>Reset all settings under the others setting menu to the factory preset values.</p>
	<p>Factory Reset</p>	<p>Restore all preset values to the factory default settings. These are also the settings for ENERGY STAR® tests.</p> 

 **NOTE: Your monitor has a built-in feature to automatically calibrate the brightness to compensate for LED aging.**



Menu and Power button lock

Controls user access to adjustments.

The default setting of Menu and Power buttons lock is Disable.

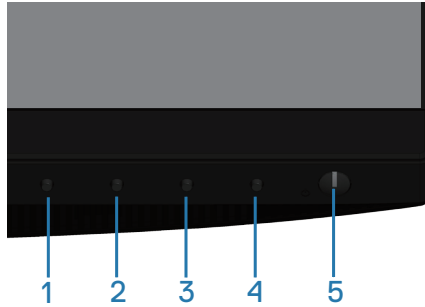



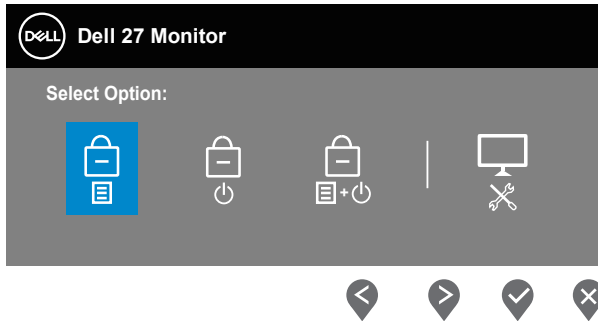

To enter the lock menu: Hold the Exit key (button 4) for 4 seconds to display the lock menu (when Menu and Power buttons unlocked), A lock menu appears and is shown on the bottom right corner of display screen.

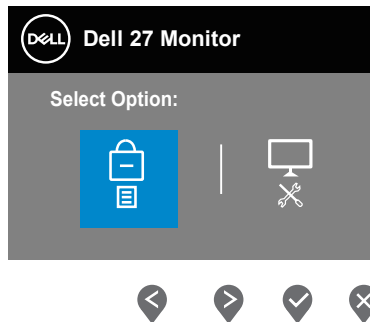

To enter the unlock menu: Hold the Exit key (button 4) for 4 seconds to display the lock menu (when Menu and Power buttons locked), A unlock menu appears and is shown on the bottom right corner of display screen.



There are three levels of lock.

	Menu	Description
1	Menu Buttons 	When “Menu Buttons” is selected, no user adjustments are allowed. All buttons are locked except Power button.
2	Power Button 	When “Power Button” is selected, user is now not able to turn off the display via Power button.
3	Menu + Power Buttons 	When “Menu + Power Buttons” is selected, no user adjustments are allowed and the Power button is locked.
4	Built-in Diagnostics 	See Built-in diagnostics for more information.

 **NOTE: To get into the Lock or Unlock menu – Press and hold the Exit key (button 4) for 4 seconds.**

The  icon will appear on center of display screen when in the following conditions which mean Menu and Power buttons is in lock state.

1. Press the Up key (button 1), Down key (button 2), Menu key (button 3) or Exit key (button 4) when in “Menu Buttons” lock state.
2. Press the Power key (button 5) when in “Power Button” lock state.
3. Press any button of the monitor when in “Menu + Power Buttons” lock state.

When Menu and Power buttons is in lock state, hold the Exit key (button 4) for 4 seconds to enter the unlock menu.

And then choose and apply to the unlock icon  to release the Menu and Power buttons lock.



OSD warning messages

When the monitor does not support a particular resolution mode, the following message is displayed:

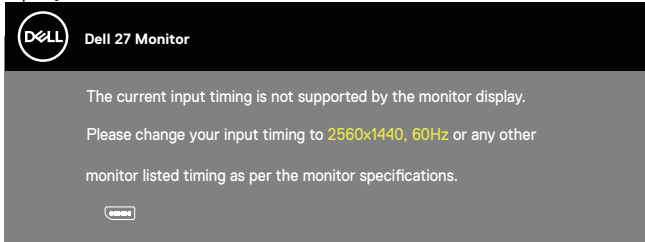

This means that the monitor cannot synchronize with the signal that it is receiving from the computer. See [Monitor specifications](#) for the Horizontal and Vertical frequency ranges addressable by this monitor. Recommended mode is 2560 x 1440.

Before the **DDC/CI** function is disabled, the following message is displayed:

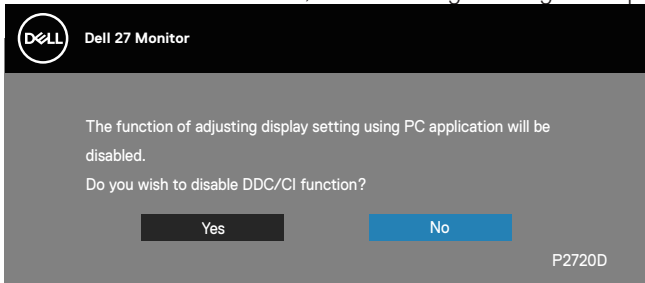

When the monitor enters the **Power Save Mode**, the following message appears:

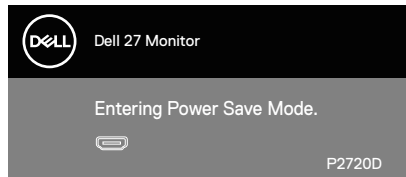

If you press any button other than the power button, the following messages will appear depending on the selected input:



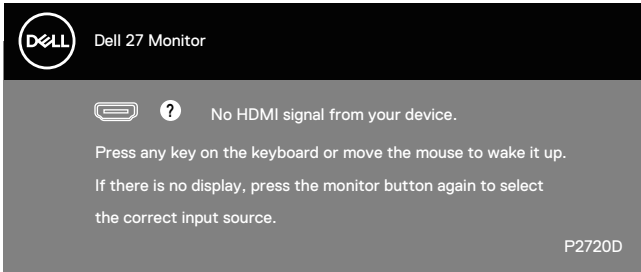

If HDMI or DP cable is not connected, a floating dialog box as shown below appears. The monitor will enter Power Save Mode after 4 minutes if left at this state.

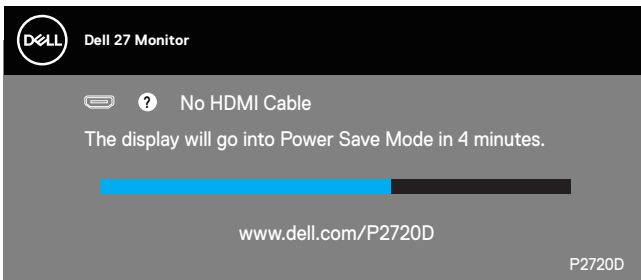

or

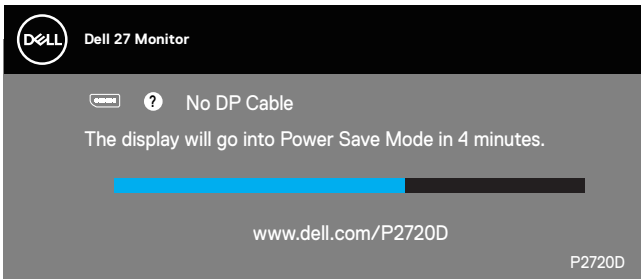

The OSD functions only in the normal operation mode. When any button is pressed in the Active-off mode, the following message will be displayed:



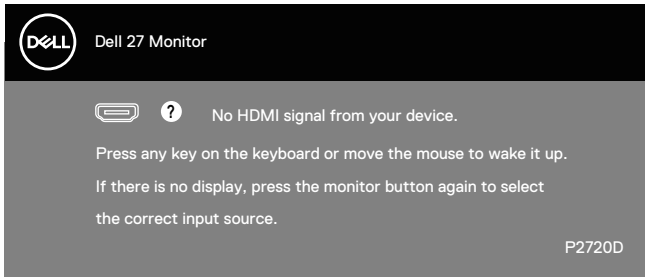

Activate the computer and the monitor to gain access to the OSD.

See [Troubleshooting](#) for more information.



Setting up your monitor

Setting the maximum resolution

To set the maximum resolution for the monitor:

In Windows 7, Windows 8, Windows 8.1 and Windows 10:

1. For Windows 8 and Windows 8.1 only, select the Desktop tile to switch to classic desktop.
2. Right-click on the desktop and click **Screen Resolution**.
3. Click the Dropdown list of the Screen Resolution and select **2560 x 1440**.
4. Click **OK**.

If you do not see **2560 x 1440** as an option, you may need to update your graphics driver. Depending on your computer, complete one of the following procedures:

If you have a Dell desktop or portable computer:

- Go to www.dell.com/support, enter your computer's Service Tag, and download the latest driver for your graphics card.

If you are using a non-Dell computer (portable or desktop):

- Go to the support site for your computer and download the latest graphic drivers.
- Go to your graphics card website and download the latest graphic drivers.

If you have a Dell desktop or a Dell portable computer with internet access

- Go to www.dell.com/support, enter your service tag, and download the latest driver for your graphics card.
5. After installing the drivers for your graphics adapter, attempt to set the resolution to **2560 x 1440** again.

 **NOTE: If you are unable to set the resolution to 2560 x 1440, please contact Dell to inquire about a graphics adapter that supports these resolutions.**



If you have a non Dell desktop, portable computer, or graphics card

In Windows 7, Windows 8, Windows 8.1 and Windows 10:

1. For Windows 8 and Windows 8.1 only, select the Desktop tile to switch to classic desktop.
2. Right-click on the desktop and click **Personalization**.
3. Click **Change Display Settings**.
4. Click **Advanced Settings**.
5. Identify your graphics controller supplier from the description at the top of the window (e.g. NVIDIA, ATI, Intel, and so on).
6. Refer to the graphic card provider website for updated driver (for example, www.ATI.com OR www.AMD.com).
7. After installing the drivers for your graphics adapter, attempt to set the resolution to **2560 x 1440** again.



Using the tilt, swivel, and vertical extension

NOTE: These values are applicable to the stand that was shipped with your monitor. To set up with any other stand, see the documentation that shipped with the stand.

Tilt, Swivel

With the stand attached to the monitor, you can tilt and swivel the monitor for the most comfortable viewing angle.

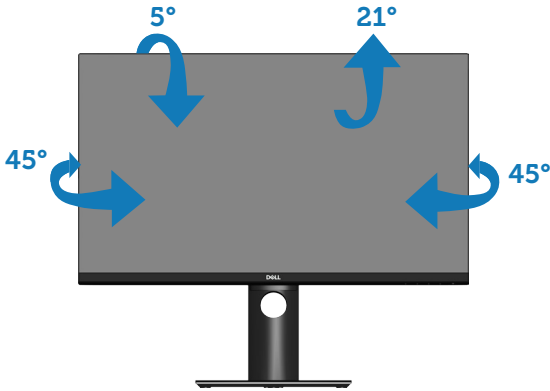

NOTE: The stand is detached when the monitor is shipped from the factory.

Vertical Extension

NOTE: The stand can be extended vertically up to 130 mm.

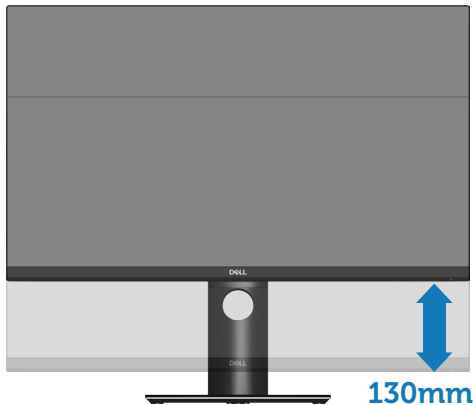

Rotating the Monitor

Before you rotate the monitor, your monitor should be fully vertically extended ([Vertical Extension](#)) and fully tilted up to avoid hitting the bottom edge of the monitor.

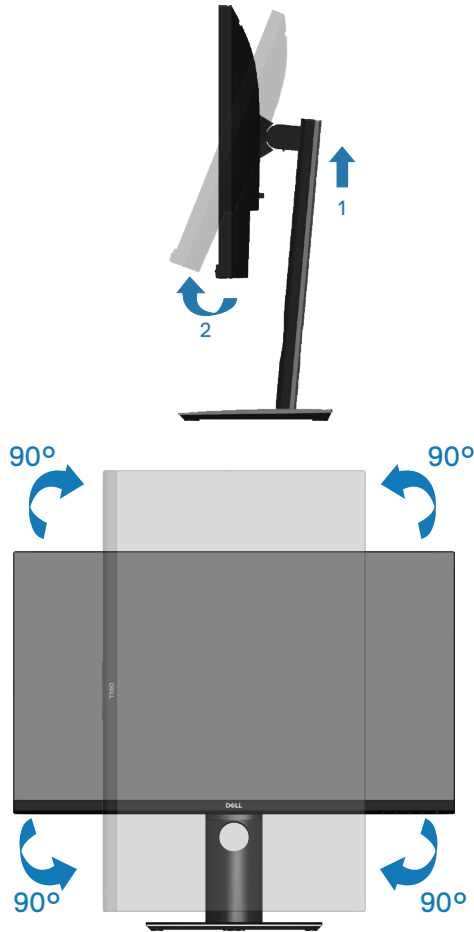

 **NOTE:** To use the Display Rotation function (Landscape versus Portrait view) with your Dell computer, you require an updated graphics driver that is not included with this monitor. To download the graphics driver, go to www.dell.com/support and see the Download section for Video Drivers for latest driver updates.



 **NOTE: When in the Portrait View Mode, you may experience performance degradation in graphic-intensive applications (3D Gaming and etc.).**

Adjusting the Rotation Display Settings of Your System

After you have rotated your monitor, you need to complete the procedure below to adjust the Rotation Display Settings of your system.

 **NOTE: If you are using the monitor with a non-Dell computer, you need to go the graphics driver website or your computer manufacturer website for information on rotating the ‘contents’ on your display.**

To adjust the Rotation Display Settings:

1. Right-click on the desktop and click **Properties**.
2. Select the **Settings** tab and click **Advanced**.
3. If you have an ATI graphics card, select the **Rotation** tab and set the preferred rotation.
4. If you have an nVidia graphics card, click the **nVidia** tab, in the left-hand column select **NVRotate**, and then select the preferred rotation.
5. If you have an Intel® graphics card, select the **Intel** graphics tab, click **Graphic Properties**, select the **Rotation** tab, and then set the preferred rotation.

 **NOTE: If you do not see the rotation option or it is not working correctly, go to www.dell.com/support and download the latest driver for your graphics card.**



Troubleshooting

⚠ WARNING: Before you begin any of the procedures in this section, follow the [Safety Instructions](#).

Self-Test

Your monitor provides a self-test feature that allows you to check if your monitor is functioning properly. If your monitor and computer are properly connected but the monitor screen remains dark, run the monitor self-test by performing the following steps:

1. Turn off both your computer and the monitor.
2. Disconnect all video cables from the monitor. This way, the computer doesn't have to be involved.
3. Turn on the monitor.

If the monitor is working correctly, it detects that there is no signal and one of the following message appears. While in self-test mode, the power LED remains white.

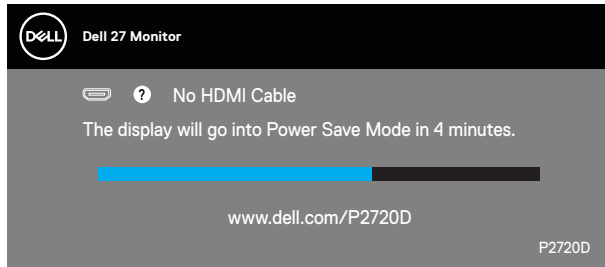

OR

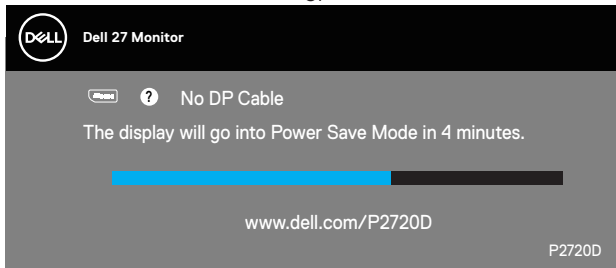

✎ NOTE: This box also appears during normal system operation, if the video cable is disconnected or damaged.



4. Turn Off your monitor and reconnect the video cable; then turn on your computer and the monitor.

If your monitor remains dark after you reconnect the cables, check your video controller and computer.

Built-in diagnostics

Your monitor has a built-in diagnostic tool that helps you determine if any screen abnormality you experience is an inherent problem with your monitor, or with your computer and video card.

 **NOTE: You can run the built-in diagnostics only when the video cable is unplugged and the monitor is in self-test mode.**

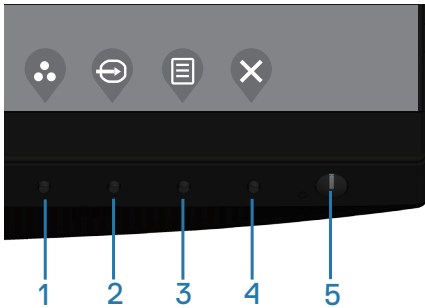

To run the built-in diagnostics:

1. Ensure that the screen is clean (no dust particles on the surface of the screen).
2. Unplug the video cable (s) from the back of the computer or monitor. The monitor then goes into the self-test mode.
3. Press and hold the Exit key (button 4) for 4 seconds to enter the OSD lock/unlock menu.



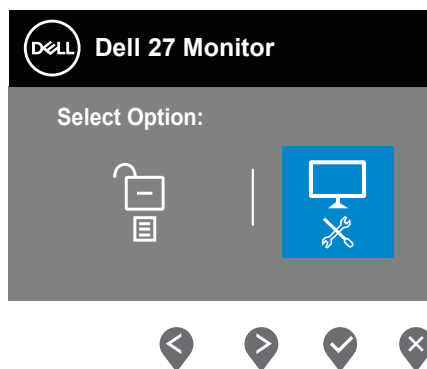
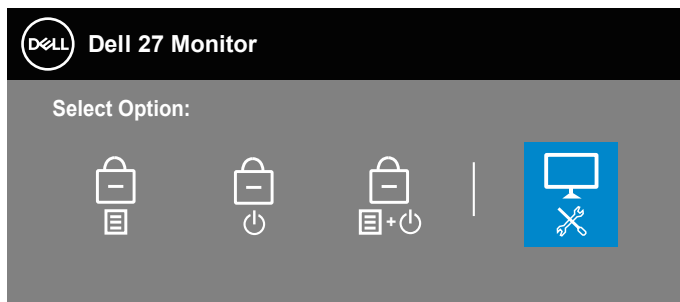

4. Select the  icon to enable the built-in diagnostics.
5. Carefully inspect the screen for abnormalities.
6. Press the Up key (button 1) on the back cover again. The color of the screen changes to grey.
7. Inspect the display for any abnormalities.
8. Repeat step 6 and 7 to inspect the display in red, green, blue, black, white and text pattern screens.

The test is complete when the text pattern screen appears. To exit, press the Up key (button 1) again.

If you do not detect any screen abnormalities upon using the built-in diagnostic tool, the monitor is functioning properly. Check the video card and computer.

Common problems



The following table contains general information about common monitor problems you might encounter and the possible solutions:

Common Symptoms	Possible Solutions
No Video/Power LED off	<ul style="list-style-type: none"> ● Ensure that the video cable connecting the monitor and the computer is properly connected and secure. ● Verify that the power outlet is functioning properly using any other electrical equipment. ● Ensure that the power button is pressed. ● Ensure that the correct input source is selected via the Input Source menu.
No Video/Power LED on	<ul style="list-style-type: none"> ● Increase brightness and contrast controls using the OSD. ● Perform monitor self-test feature check. ● Check for bent or broken pins in the video cable connector. ● Run the built-in diagnostics. ● Ensure that the correct input source is selected via the Input Source menu.
Poor Focus	<ul style="list-style-type: none"> ● Eliminate video extension cables. ● Reset the monitor to Factory Settings (Factory Reset). ● Change the video resolution to the correct aspect ratio.
Shaky/Jittery Video	<ul style="list-style-type: none"> ● Reset the monitor to Factory Settings (Factory Reset). ● Check environmental factors. ● Relocate the monitor and test in another room.
Missing Pixels	<ul style="list-style-type: none"> ● Cycle power On-Off. ● Pixel that is permanently Off is a natural defect that can occur in LCD technology. ● For more information on Dell Monitor Quality and Pixel Policy, see Dell Support site at: www.dell.com/support/monitors.



Stuck-on Pixels	<ul style="list-style-type: none"> ● Cycle power On-Off. ● Pixel that is permanently off is a natural defect that can occur in LCD technology. ● For more information on Dell Monitor Quality and Pixel Policy, see Dell Support site at: www.dell.com/support/monitors.
Brightness Problems	<ul style="list-style-type: none"> ● Reset the monitor to Factory Settings (Factory Reset). ● Adjust brightness & contrast controls via OSD.
Geometric Distortion	<ul style="list-style-type: none"> ● Reset the monitor to Factory Settings (Factory Reset). ● Adjust horizontal & vertical controls via OSD.
Horizontal/Vertical Lines	<ul style="list-style-type: none"> ● Reset the monitor to Factory Settings (Factory Reset). ● Perform monitor self-test feature check and determine if these lines are also in self-test mode. ● Check for bent or broken pins in the video cable connector. ● Run the built-in diagnostics.
Synchronization Problems	<ul style="list-style-type: none"> ● Reset the monitor to Factory Settings (Factory Reset). ● Perform monitor self-test feature check to determine if the scrambled screen appears in self-test mode. ● Check for bent or broken pins in the video cable connector. ● Restart the computer in the safe mode.
Safety Related Issues	<ul style="list-style-type: none"> ● Do not perform any troubleshooting steps. ● Contact Dell immediately.
Intermittent Problems	<ul style="list-style-type: none"> ● Ensure that the video cable connecting the monitor to the computer is connected properly and is secure. ● Reset the monitor to Factory Settings (Factory Reset). ● Perform monitor self-test feature check to determine if the intermittent problem occurs in self-test mode.
Missing Color	<ul style="list-style-type: none"> ● Perform monitor self-test feature check. ● Ensure that the video cable connecting the monitor to the computer is connected properly and is secure. ● Check for bent or broken pins in the video cable connector.



Wrong Color	<ul style="list-style-type: none"> • Change the Color Setting Mode in the Color Settings OSD to Graphics or Video depending on the application. • Try different Preset Modes in Color settings OSD. Adjust R/G/B value in Custom Color in Color settings OSD. • Change the Input Color Format to RGB or YPbPr in the Color settings OSD. • Run the built-in diagnostics.
Image retention from a static image left on the monitor for a long period of time	<ul style="list-style-type: none"> • Use the Power Management feature to turn off the monitor at all times when not in use (for more information, see Power management modes). • Alternatively, use a dynamically changing screensaver.
Video Ghosting or Overshooting	<ul style="list-style-type: none"> • Change the Response Time in the Display OSD to Fast or Normal depending on your application and usage.



Product-specific problems

Specific Symptoms	Possible Solutions
Screen image is too small	<ul style="list-style-type: none">• Check the Aspect Ratio setting in the Display settings OSD.• Reset the monitor to Factory Settings (Factory Reset).
Cannot adjust the monitor with the buttons on the bottom of the panel	<ul style="list-style-type: none">• Turn Off the monitor, unplug the power cord, plug it back, and then turn On the monitor.• Check if the OSD menu is locked. If yes, press and hold the menu button for 4 seconds to unlock.
No Input Signal when user controls are pressed	<ul style="list-style-type: none">• Check the signal source. Ensure the computer is not in standby or sleep mode by moving the mouse or pressing any key on the keyboard.• Check if the video cable is plugged in properly. Disconnect and reconnect the video cable if necessary.• Reset the computer or video player.
The picture does not fill the entire screen	<ul style="list-style-type: none">• Due to different video formats (aspect ratio) of DVDs, the monitor may display in full screen.• Run the built-in diagnostics.



Appendix

Safety Instructions

 **WARNING: Use of controls, adjustments, or procedures other than those specified in this documentation may result in exposure to shock, electrical hazards, and/or mechanical hazards.**

For information on safety instructions, see the **Safety Environment and Regulatory Information (SERI)**.

FCC notices (U.S. Only) and other regulatory information

For FCC notices and other regulatory information, see the regulatory compliance website located at www.dell.com/regulatory_compliance.

Please follow these safety instructions for best performance, and long life for your monitor:

1. The socket-outlet shall be installed near the equipment and shall be easily accessible.
2. The equipment can be installed on wall or ceiling mounting in horizontal position.
3. The monitor is equipped with a three-pronged grounded plug, a plug with a third (Grounding) pin.
4. Do not use this product near water.
5. Read these instructions carefully. Keep this document for future reference. Follow all warnings and instructions marked on product.
6. Excessive sound pressure from earphones and headphones can cause hearing loss. Adjustment of the equalizer to maximum increases the earphones and headphones output voltage and therefore the sound pressure level.



Contacting Dell

For customers in the United States, call 800-WWW-DELL (800-999-3355).

 **NOTE: If you do not have an active Internet connection, you can find contact information on your purchase invoice, packing slip, bill, or Dell product catalog.**

Dell provides several online and telephone-based support and service options. Availability varies by country and product, and some services may not be available in your area.

To get online Monitor support content:

1. Visit www.dell.com/support/monitors.

To contact Dell for sales, technical support, or customer service issues:

1. Visit www.dell.com/support.
2. Verify your country or region in the **Choose A Country/Region** drop-down menu at the bottom of the page.
3. Click **Contact Us** on the left side of the page.
4. Select the appropriate service or support link based on your need.
5. Choose the method of contacting Dell that is convenient for you.



Free Manuals Download Website

<http://myh66.com>

<http://usermanuals.us>

<http://www.somanuals.com>

<http://www.4manuals.cc>

<http://www.manual-lib.com>

<http://www.404manual.com>

<http://www.luxmanual.com>

<http://aubethermostatmanual.com>

Golf course search by state

<http://golfingnear.com>

Email search by domain

<http://emailbydomain.com>

Auto manuals search

<http://auto.somanuals.com>

TV manuals search

<http://tv.somanuals.com>