



Dell SD7000-S — Storage Designed for Scality RING Owner's Manual

Regulatory Model: B14S Series
Regulatory Type: B14S001



Notes, cautions, and warnings

-  **NOTE:** A NOTE indicates important information that helps you make better use of your computer.
-  **CAUTION:** A CAUTION indicates either potential damage to hardware or loss of data and tells you how to avoid the problem.
-  **WARNING:** A WARNING indicates a potential for property damage, personal injury, or death.

© 2016 Dell Inc. All rights reserved. This product is protected by U.S. and international copyright and intellectual property laws. Dell and the Dell logo are trademarks of Dell Inc. in the United States and/or other jurisdictions. All other marks and names mentioned herein may be trademarks of their respective companies.

2016 - 05

Rev. A01

Contents

1 About your system.....	8
Front-panel features and indicators.....	9
Back-panel features and indicators.....	11
Hard drive indicator codes.....	13
NIC indicator codes.....	15
Indicator codes for the redundant PSU.....	15
2 Documentation resources.....	18
3 Technical specifications.....	19
Physical specifications.....	19
Processor specifications.....	19
Expansion bus specifications.....	19
Memory specifications.....	20
Power specifications.....	20
RAID Controller specifications.....	20
Drives specifications.....	21
Connectors specifications (per server sled).....	21
Video specifications.....	21
Environmental specifications.....	21
Particulate contamination.....	23
Expanded Operating Temperature.....	23
4 Initial system setup and configuration.....	25
Setting up your system.....	25
iDRAC configuration.....	25
Options to set up iDRAC IP address.....	25
Log in to iDRAC.....	26
Options to install the operating system.....	26
Methods to download firmware and drivers.....	26
5 Pre-operating system management applications.....	28
Options to manage the pre-operating system applications.....	28
System Setup.....	28
System Setup details.....	28
System BIOS.....	29
iDRAC Settings utility.....	47
Device Settings.....	48

Dell Lifecycle Controller.....	48
Embedded system management.....	48
Boot Manager.....	49
Viewing Boot Manager.....	49
Boot Manager main menu.....	49
PXE boot.....	50
6 Installing and removing system components.....	51
Safety instructions.....	51
Before working inside your system.....	51
After working inside your system.....	51
Recommended tools.....	52
System cover.....	52
Removing the system cover.....	52
Installing the system cover.....	53
Server sleds.....	54
Removing the server sled.....	54
Installing the server sled.....	55
Expansion cards and expansion card riser.....	56
Expansion card installation guidelines.....	56
Removing the expansion-card riser module.....	57
Installing the expansion-card riser module.....	58
Removing an expansion card.....	59
Installing an expansion card.....	60
Installing the supercapacitor.....	61
Removing a riser card.....	62
Installing a riser card.....	63
Cooling shroud.....	64
Removing the cooling shroud.....	64
Installing the cooling shroud.....	65
System memory.....	65
General memory module installation guidelines.....	67
Mode-specific guidelines.....	67
Sample memory configurations.....	68
Removing memory modules.....	68
Installing memory modules.....	69
Processors and heat sinks.....	71
Removing a processor.....	71
Installing a processor.....	75
Hard Drives.....	77
Removing a 3.5-inch hard drive blank.....	78
Installing a 3.5-inch hard drive blank.....	78

Removing a 3.5-inch hot-swap hard drive.....	79
Installing a hot-swappable hard drive carrier.....	80
Removing a 3.5-inch hard drive from an hard drive carrier.....	81
Installing a 3.5-inch hard drive into an hard drive carrier.....	81
Removing a 2.5-inch hot-swap hard drive.....	82
Installing a 2.5-inch hot-swap hard drive.....	83
Installing a 2.5-inch hard drive into a 3.5-inch hard drive adapter.....	84
Removing a 2.5-inch hard drive from a 3.5-inch hard drive adapter.....	84
Installing a hard drive adapter into a hard drive carrier.....	85
Removing a hard drive adapter from a hard drive carrier.....	86
Removing a 2.5-inch hard drive from a hard drive carrier.....	86
System fans.....	87
Removing a system fan.....	87
Installing a system fan.....	88
Removing the fan cage.....	89
Installing the fan cage.....	90
Power supply units.....	90
Removing a redundant PSU.....	90
Installing a redundant PSU.....	91
System battery.....	92
Replacing the system battery.....	92
Power interposer board.....	94
Removing the interposer board.....	94
Installing the interposer board.....	95
Expander board.....	95
Removing the expander board.....	95
Installing the expander board.....	96
Paddle board.....	97
Removing the paddle board.....	97
Installing the paddle board.....	98
Hard drive cage and backplane.....	98
Removing the hard drive cage and backplane.....	98
Installing the hard drive cage and backplane.....	102
System board.....	103
Removing the system board.....	103
Installing the system board.....	106
Trusted Platform Module.....	107

7 Using system diagnostics..... 110

Dell Embedded System Diagnostics.....	110
When to use the Embedded System Diagnostics.....	110
Running the Embedded System Diagnostics from Boot Manager.....	110

Running the Embedded System Diagnostics from the Dell Lifecycle Controller.....	110
System diagnostic controls.....	111
8 Jumpers and connectors	112
System board jumper settings.....	112
System board connectors.....	113
Disabling a forgotten password.....	114
9 Troubleshooting your system.....	116
Safety first — for you and your system.....	116
Troubleshooting system startup failure.....	116
Troubleshooting external connections.....	116
Troubleshooting the video subsystem.....	116
Troubleshooting a USB device.....	117
Troubleshooting iDRAC Direct (USB XML configuration).....	118
Troubleshooting iDRAC Direct (Laptop connection).....	118
Troubleshooting a serial I/O device.....	119
Troubleshooting a NIC.....	119
Troubleshooting a wet system.....	120
Troubleshooting a damaged system.....	121
Troubleshooting server sleds.....	121
System messages.....	122
Warning messages.....	122
Diagnostic messages.....	122
Troubleshooting the system battery.....	122
Troubleshooting power supply units.....	123
Troubleshooting power source problems.....	123
Power supply unit problems.....	123
Troubleshooting cooling problems.....	123
Troubleshooting cooling fans.....	124
Troubleshooting system memory.....	125
Troubleshooting an internal USB key.....	126
Troubleshooting an SD card.....	126
Troubleshooting an optical drive.....	127
Troubleshooting a hard drive.....	128
Troubleshooting a storage controller.....	128
Troubleshooting expansion cards.....	129
Troubleshooting processors.....	130
10 Getting help.....	131
Contacting Dell.....	131
Locating Service Tag of your system.....	131

Documentation feedback.....	131
Quick resource locator.....	132

About your system

The Dell SD7000-S — Storage Designed for Scality RING is a 4U 90 hard drive, ultra-dense storage appliance purpose built for use with RING™ software from Scality. The system consists of the Dell SD7000-S, which is the chassis and up to two server sleds.

The Dell SD7000-S storage appliance benefits from all the features of the Intel Xeon EP E5-2600v3 product family as well as an extremely dense and energy efficient shared infrastructure chassis. The combination of Intel enhancements with the E5-2600v3 processors and the Dell SD7000-S ultra-dense chassis provides performance, efficiency, and flexibility in one dense package. It supports complete lifecycle management with the Dell™ OpenManage™ portfolio of systems management solutions, including leading remote management with iDRAC8 with Lifecycle Controller.

The storage server is shipped from Dell. The Scality RING™ software is installed and configured at the customer site by Scality or a Scality certified partner.

Key features:

System Configurations

The server systems are available in the following configurations:

Table 1.

System	Configuration
Single-node systems with one server sled	<ul style="list-style-type: none"> Up to 90 3.5-inch hot-swappable Serial Attached SCSI (SAS) HDDs, SATA HDDs, or SATA SSDs, or Up to 16 hot-swappable SATA or SAS SSDs
Dual-node systems with two server sleds	<ul style="list-style-type: none"> Up to 90 3.5-inch hot-swappable HDDs in a 4U form factor Up to 12 hot-swappable SATA or SAS SSDs

- A selection of high performance E5-2600v3 or v4 series processors up to 135 W Thermal Design Power (TDP).
- Systems management with support for iDRAC8 Edition.
- Redundant hot-plug power supply for added reliability.
- Serviceable nodes give the ability to service one node while the other is running. Both nodes work independently and control a maximum of 45 HDDs. In a single-node system, failure of a node, results in failure of the chassis.
 - Each sled has two boot drives and four PCIe Gen 3 slots.
- Up to 384 GB of memory with 12 DDR4 slots (32 GB DIMMs) per server node.

Front-panel features and indicators

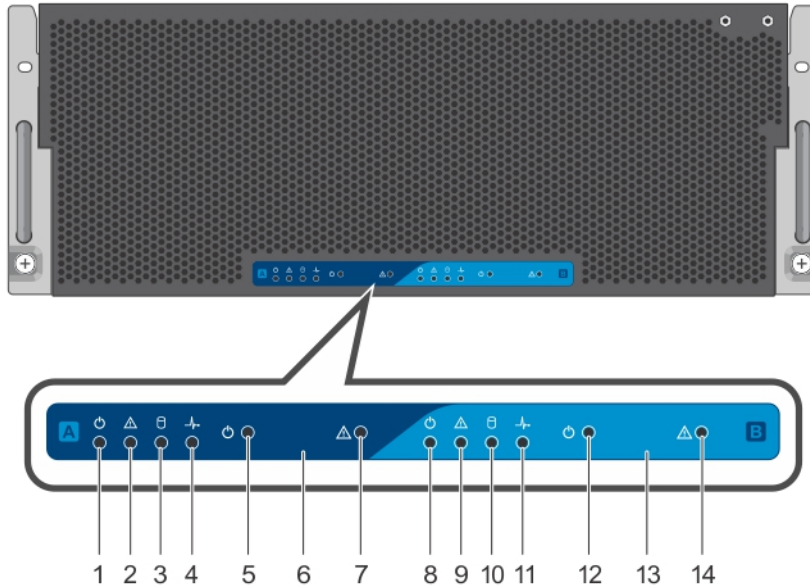

















Figure 1. Front panel features and indicators

Table 2. Front panel features and indicators

Item	Indicator, Button, or Connector	Icon	Description
1	Power indicators		The power indicator glows when the system is turned on.
2	ID indicator		When a system identification button is pressed, the ID indicator blinks blue to help locate a particular system within a rack.
3	Sled A hard drive fault status indicator		The indicator blinks amber if a hard drive experiences an issue.
4	System board status indicator		If the system is on, and in good health, the indicator glows solid blue. The indicator blinks amber if the system is in standby, and if any issue exists (for example, a failed fan or hard drive).
5	Power button		The power button controls the PSU output to the system.  NOTE: On ACPI-compliant operating systems (OSs), turning off the system using the power button causes the system to perform a graceful shutdown before power to the system is turned off.

Item	Indicator, Button, or Connector	Icon	Description
6	System identification button		<p>The identification button can be used to locate a particular system within a rack.</p> <p>Press to toggle the system ID on and off.</p> <p>If the system stops responding during POST, press and hold the system ID button for more than five seconds to enter BIOS progress mode.</p> <p>To reset iDRAC (if not disabled in F2 iDRAC setup), press and hold the button for more than 15 seconds.</p>
7	Sled A		Indicator, Button, or Connector for sled A (item 1 to 6)
8	Power indicator		The power indicator glows when the system is turned on.
9	ID indicator		When a system identification button is pressed, the ID indicator blinks blue to help locate a particular system within a rack.
10	Sled B hard drive fault status indicator		The indicator blinks amber if a hard drive experiences an issue.
11	System board status indicator		<p>If the system is on, and in good health, the indicator glows solid blue.</p> <p>The indicator blinks amber if the system is in standby, and if any issue exists (for example, a failed fan or hard drive).</p>
12	Power button		<p>The power button controls the PSU output to the system.</p> <p> NOTE: On ACPI-compliant OSs, turning off the system using the power button causes the system to perform a graceful shutdown before power to the system is turned off.</p>
13	System identification button		<p>The identification button can be used to locate a particular system within a rack.</p> <p>Press to toggle the system ID on and off.</p> <p>If the system stops responding during POST, press and hold the system ID button for more than five seconds to enter BIOS progress mode.</p> <p>To reset iDRAC (if not disabled in F2 iDRAC setup), press and hold the button for more than 15 seconds.</p>
14	Sled B		Indicator, Button, or Connector for (item 8 to 13)

Item	Indicator, Button, or Connector	Icon	Description
------	---------------------------------	------	-------------

 **NOTE:** Features of sled B are for dual-node systems only.

Back-panel features and indicators

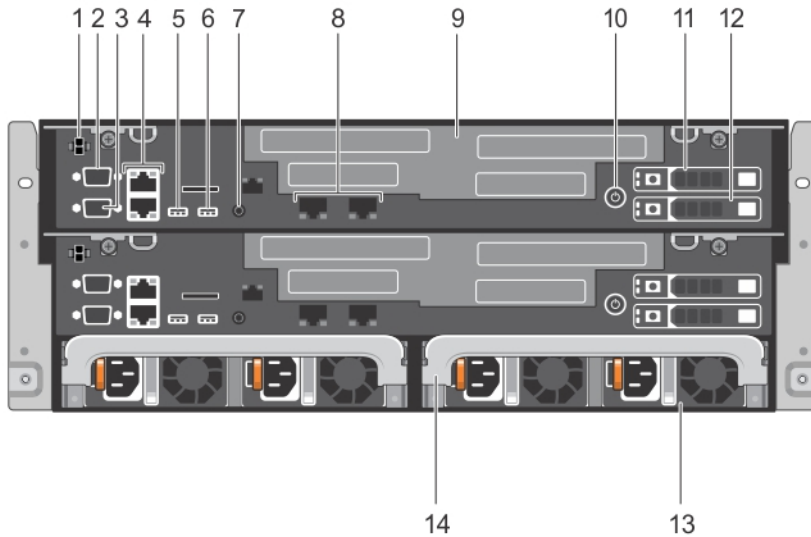











Figure 2. Back-panel features and indicators

Table 3. Back-panel features and indicators for a system without dual riser module

Item	Indicator, button, or connector	Icon	Description
1	Blade EN connector (optional)		This function is reserved
2	Serial connector		Enables you to connect a serial device to the system.
3	Video connector		Enables you to connect a VGA display to the system.
4	Ethernet connectors		Integrated 10/100/1000 Mbps NIC connector
5	USB connector		Enables you to connect USB devices to the system. This port is USB 2.0-compliant.
6	USB connector		Enables you to connect USB devices to the system. This port is USB 3.0-compliant.
7	System identification connector		Enables you to connect the optional system status indicator assembly through the optional cable management arm.
8	Ethernet connectors		Integrated 10/100/1000 Mbps NIC connector

Item	Indicator, button, or connector	Icon	Description
9	Expansion-card riser module		Contains risers
10	Power button		The power button controls the PSU output to the system.  NOTE: On ACPI-compliant OSs, turning off the system using the power button causes the system to perform a graceful shutdown before power to the system is turned off.
11	Boot hard drive A		2.5-inch boot hard drive
12	Boot hard drive B		2.5-inch boot hard drive
13	Power supply units		Four redundant power supply units (PSUs). From left to right: PSUs 1 and 2 are for sled B (upper sled); PSUs 3 and 4 are for sled A (lower sled).
14	PSU Handle		Holds expander board bracket in the chassis

 **NOTE:** Features of sled B are for dual-node systems only.

 **NOTE:** In a single-node system, a dummy sled is installed over sled B compartment and two dummy PSUs over the PSU slots.

Hard drive indicator codes

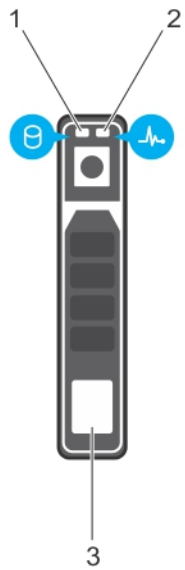



Figure 3. 2.5-inch hard drive indicator

1. hard drive activity indicator
2. hard drive status indicator
3. hard drive

 **NOTE:** If the hard drive is in Advanced Host Controller Interface (AHCI) mode, the status indicator (on the right side) does not function and remains off.

 **NOTE:** The function of the status indicator may vary depending on the hard drive type.

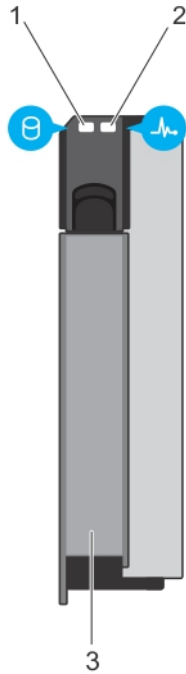

Figure 4. 3.5-inch hard drive indicator

1. hard drive activity indicator
2. hard drive status indicator
3. hard drive

NOTE: If the hard drive is in Advanced Host Controller Interface (AHCI) mode, the status indicator (on the right side) does not function and remains off.

Table 4. Hard drive indicator codes

Drive-status indicator pattern (RAID only)	Condition
Blinks green two times per second	Identifying drive or preparing for removal.
Off	Drive ready for insertion or removal.
	NOTE: The drive status indicator remains off until all hard drives are initialized after the system is turned on. Drives are not ready for insertion or removal during this time.
Blinks green, amber, and turns off	Predicted drive failure
Blinks amber four times per second	Drive failed
Blinks green slowly	Drive rebuilding
Steady green	Drive online
Blinks green three seconds, amber three seconds, and turns off six seconds	Rebuild ended

NIC indicator codes

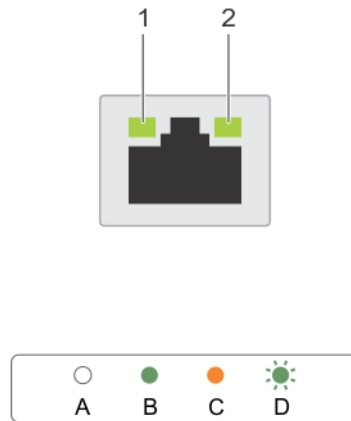

Figure 5. NIC indicators

1. link indicator
2. activity indicator

Table 5. NIC indicators

Convention	Status	Condition
A	Link and activity indicators are off	The NIC is not connected to the network.
B	Link indicator is green	The NIC is connected to a valid network at its maximum port speed (1 Gbps or 10 Gbps).
C	Link indicator is amber	The NIC is connected to a valid network at less than its maximum port speed.
D	Activity indicator is flashing green	Network data is being sent or received.

Indicator codes for the redundant PSU



Each AC PSU has an illuminated translucent handle that indicates whether power is present or a power fault has occurred.







Figure 6. AC PSU status indicator

1. AC PSU status indicator or handle

Table 6. AC PSU status indicators

Convention	Power indicator pattern	Condition
A	Green	A valid power source is connected to the PSU and the PSU is operational.
B	Flashing green	When the firmware of the PSU is being updated, the PSU handle flashes green.
C	Flashing green and turns off	When hot-adding a PSU, the PSU handle flashes green five times at 4 Hz rate and turns off. This indicates a PSU mismatch regarding efficiency, feature set, health status, and supported voltage. <ul style="list-style-type: none">  NOTE: Ensure that both the PSUs are of the same capacity.  CAUTION: For AC PSUs, use only PSUs with the Extended Power Performance (EPP) label on the back.  NOTE: Mixing PSUs from previous generations of Dell PowerEdge servers can result in a PSU mismatch condition or failure to turn on the system.
D	Flashing amber	Indicates a problem with the PSU.

Convention	Power indicator pattern	Condition
E	Not lit	<p data-bbox="943 247 1402 562">  CAUTION: When correcting a PSU mismatch, replace only the PSU with the flashing indicator. Swapping the PSU to make a matched pair can result in an error condition and unexpected system shutdown. To change from a high output configuration to a low output configuration or the other way, you must power down the system. </p> <p data-bbox="943 583 1402 804">  CAUTION: AC PSUs support both 220 V and 110 V input voltages except for Titanium PSUs, which support only 220 V. When two identical PSUs receive different input voltages, they can output different wattages, and trigger a mismatch. </p> <p data-bbox="943 825 1402 940">  CAUTION: If two PSUs are used, they must be of the same type and have the same maximum output power. </p> <p data-bbox="943 961 1402 1041">  CAUTION: Combining AC and DC PSUs is not supported and triggers a mismatch. </p> <p data-bbox="943 1066 1214 1092">Power is not connected.</p>

Documentation resources

For information about Dell documentation and Scality documentation, see the *Dell Storage Designed for Scality RING Support Matrix* available at Dell.com/sdscalityseriesmanuals.

Technical specifications

Physical specifications

Table 7. The Dell SD7000-S system supports the following physical specifications

Physical	Specifications
Height	173.8 mm (6.84 inch)
Width (with rack latches)	482.4 mm (18.99 inch)
Width (without rack latches)	448.0 mm (17.64 inch)
Depth (excludes bezel)	1098.4 mm (43.24 inch)
Total depth of system with cable management	1242.68 mm (CMA) arm attached
Weight (Maximum)	129.6 kg (285.72 lb)
Weight (empty)	57.1 kg (125.88 lb)

Processor specifications

Table 8. The Dell SD7000-S system supports the following processor specifications

Processor	
Processor type	Intel Xeon EP E5-2600 v3 or v4 product family

Expansion bus specifications

The system supports PCI Express Generation 3 cards. For a list of supported expansion cards, see the Expansion card installation guidelines section.

Table 9. The Dell SD7000-S system supports the following expansion bus specifications

Expansion slots using the expansion-card riser module	Specification
PCIE_G3_X8	(Slot 1) One half-height, half-length x8 link for processor 2
PCIE_G3_X16	(Slot 2) One full-height, half-length x16 link for processor 1
PCIE_G3_X8	(Slot 3) One full-height, half-length x8 link for processor 1

Expansion slots using the expansion-card riser module	Specification
PCIE_G3_X8	(Slot 4) One half-height, half-length x8 link for processor 1

Memory specifications

Table 10. The Dell SD7000-S system supports the following memory specifications

Memory	Specifications
Architecture	2133 MT/s DDR4 Registered DIMMs Support for advanced Error Correcting Code (ECC) or memory optimized operation
Memory module sockets	12 288-pin
Memory module capacities (RDIMMs)	16 GB dual-rank and 32 GB dual-rank
Minimum RAM	192 GB with dual processor per node
Maximum RAM	Up to 384 GB with dual processor per node

Power specifications

Table 11. The Dell SD7000-S system supports the following power specifications

Power	Specifications
AC power supply (per PSU)	
Wattage	<ul style="list-style-type: none"> 1100 W PSUs for support on Dual Nodes only 1600 W PSUs for support on Single Nodes only
Power rating per power supply unit	<ul style="list-style-type: none"> 1100 W (Platinum) AC (200–240 V, 50/60 Hz, 6.5 A) 1600 W (Gold) AC (200 – 240 V, 50/60 Hz, 10.0 A)
Heat dissipation	<ul style="list-style-type: none"> 4170 BTU/hr maximum (1100 W PSU) or 6060 BTU/hr maximum (1600W PSU)
 NOTE: This system is also designed to be connected to IT power systems with a phase to phase voltage not exceeding 230 V.	
Voltage	200-240 V AC, autoranging, 50/60 Hz

RAID Controller specifications

Table 12. The Dell SD7000-S system supports the following RAID controller specifications

Controller type	Specifications
RAID Controller	<ul style="list-style-type: none"> LSI 9361-8i

Drives specifications

Table 13. The Dell SD7000-S system supports the following drive specifications

Drives	Specifications
Hard Disk Drives (HDDs)	
Single-node systems with one server sled	<ul style="list-style-type: none">Up to 90 3.5-inch hot-swappable Serial Attached SCSI (SAS) HDDs, SATA HDDs, or SATA SSDs orUp to 16 hot-swappable SATA or SAS SSDs
Dual-node systems with two server sleds	<ul style="list-style-type: none">Up to 90 3.5-inch hot-swappable Serial Attached SCSI (SAS) HDDs, SATA HDDs, or SATA SSDs orUp to 12 hot-swappable SATA or SAS SSDs

Connectors specifications (per server sled)

Table 14. The Dell SD7000-S system supports the following controller specifications

Connectors (per server sled)	Specifications
Back	
NIC	Four 10/100/1000 Mbps
Serial	9-pin, DTE, 16550-compatible
USB	One 9-pin, USB 3.0-compliant One 4-pin, USB 2.0-compliant
Video	15-pin VGA
Internal	
USB	One 9-pin, USB 3.0-compliant

Video specifications

Table 15. The Dell SD7000-S system supports the following video specifications

Video	Specifications
Video type	Integrated Matrox® G200
Video memory	16 MB shared

Environmental specifications

 **NOTE:** For additional information about environmental measurements for specific system configurations, see [Dell.com/environmental_datasheets](https://www.dell.com/environmental_datasheets)

Table 16. The Dell SD7000-S system supports the following environmental specifications

Temperature

Storage	–40°C to 65°C (–40°F to 149°F)
Continuous operation (for altitude less than 950 m or 3117 ft)	10°C to 35°C (50°F to 95°F) with no direct sunlight on the equipment.
Maximum temperature gradient (Operating and Storage)	20°C/h (36°F/h)

Relative humidity (RH)

Storage	5% to 95% RH with 33°C (91°F) maximum dew point. Atmosphere must be non-condensing at all times.
Operating	10 percent to 80 percent RH with 29°C (84.2°F) maximum dew point.

Maximum vibration

Operating	0.26 Grms at 5 Hz to 350 Hz (all operation orientations).
Storage	1.88 Grms at 10 Hz to 500 Hz for 15 min (bottom side of shipment orientation only).

Maximum shock

Operating	Four shock pulses per axis (the positive and negative x, y, and z axes), 24 total shock pulses. 40 G, 2.3 ms for x and y axes. 36 G, 2.3 ms for z axe.
Storage	<ul style="list-style-type: none">• 71 G, 2 ms pulse shape is Half-Sine (bottom side of shipping orientation only).• 15 G, 165 in/sec pulse shape is Square-Wave (bottom side of shipping orientation only)

Maximum altitude

Operating	3048 m (10,000 ft).
Storage	12,000 m (39,370 ft).

Operating temperature de-rating

Up to 35°C (95°F)	Maximum temperature is reduced by 1°C/300 m (1°F/547 ft) above 950 m (3,117 ft).
35°C to 40°C (95°F to 104°F)	Maximum temperature is reduced by 1°C/175 m (1°F/319 ft) above 950 m (3,117 ft).
40°C to 45°C (104°F to 113°F)	Maximum temperature is reduced by 1°C/125 m (1°F/228 ft) above 950 m (3,117 ft).

Particulate contamination









 **NOTE:** This section defines the limits to help avoid IT equipment damage and/or failure from particulates and gaseous contamination. If it is determined that levels of particulates or gaseous pollution are beyond the limits specified below and are the reason for the damage and/or failures to your equipment, it may be necessary for you to re-mediate the environmental conditions that are causing the damage and/or failures. Re-mediation of environmental conditions will be the responsibility of a customer

Table 17. The Dell SD7000-S system supports the following particulate contamination specifications

<p>Air Filtration</p> <p> NOTE: Applies to data center environments only. Air filtration requirements do not apply to IT equipment designed to be used outside a data center, in environments such as an office or factory floor.</p>	<p>Data center air filtration as defined by ISO Class 8 per ISO 14644-1 with a 95 percent upper confidence limit.</p> <p> NOTE: Air entering the datacenter must have MERV11 or MERV13 filtration.</p>
<p>Conductive dust</p> <p> NOTE: Applies to data center and non-data center environments.</p>	<p>Air must be free of conductive dust, zinc whiskers, or other conductive particles.</p>
<p>Corrosive Dust</p> <p> NOTE: Applies to data center and non-data center environments.</p>	<ul style="list-style-type: none"> • Air must be free of corrosive dust. • Residual dust present in the air must have a deliquescent point less than 60 percent relative humidity.
<p>Gaseous contamination</p> <p> NOTE: Maximum corrosive contaminant levels measured at ≤ 50 percent relative humidity.</p>	
<p>Copper coupon corrosion rate</p>	<p><300 Å/month per Class G1 as defined by ANSI/ISA71.04-1985</p>
<p>Silver coupon corrosion rate</p>	<p><200 Å/month as defined by AHSRAE TC9.9.</p>

Expanded Operating Temperature

Table 18. The Dell SD7000-S system supports the following expanded operating temperature specifications

<p> NOTE: When operating in the expanded temperature range, system performance may be impacted.</p> <p> NOTE: When operating in the expanded temperature range, ambient temperature warnings may be reported on the LCD and in the System Event Log.</p>	
<p>< 10 percent of annual operating hours</p>	<p>5°C to 40°C at 5 percent to 85 percent RH with 26°C dew point.</p>

 **NOTE:** Outside the standard operating temperature (10°C to 35°C), the system can operate down to 5°C or up to 40°C for a maximum of 10 percent of its annual operating hours.

For temperatures between 35°C and 40°C, de-rate maximum allowable dry bulb temperature by 1°C per 175 m above 950 m (1°F per 319 ft).

< 1 percent of annual operating hours

–5°C to 45°C at 5 percent to 90 percent (RH) with 26°C dew point.

 **NOTE:** Outside the standard operating temperature (10°C to 35°C), the system can operate down to –5°C or up to 45°C for a maximum of 1 percent of its annual operating hours.

For temperatures between 40°C and 45°C, de-rate maximum allowable dry bulb temperature by 1°C per 125 m above 950 m (1°F per 319 ft).

Expanded operating temperature restrictions

- Processors of 55 W and 65 W are not supported.
- Do not perform a cold startup at less than 5°C.
- Allow processor performance degrade.
- Non-redundant PSUs are not supported.
- Non-Dell qualified peripheral cards and/or peripheral cards are not supported.
- Maximum altitude for the operating temperature must be 3050 m (10,000 ft).

Initial system setup and configuration

Setting up your system

Complete the following steps to set up your system:

1. Unpack the system.
2. Install the system into the rack. For more information about installing the system into the rack, see your system *Rack Installation Placemat* at [Dell.com/sdscalityseriesmanuals](https://www.dell.com/sdscalityseriesmanuals).
3. Connect the peripherals to the system.
4. Connect the system to its electrical outlet.
5. Turn the system on by pressing the power button or by using iDRAC.
6. Turn on the attached peripherals.

iDRAC configuration

The Integrated Dell Remote Access Controller (iDRAC) is designed to make system administrators more productive and improve the overall availability of Dell systems. iDRAC alerts administrators to system issues, helps them perform remote system management, and reduces the need for physical access to the system.

Options to set up iDRAC IP address

You must configure the initial network settings based on your network infrastructure to enable the communication to and from iDRAC. You can set up the IP address by using one of the following interfaces:

Interfaces	Document/Section
iDRAC Settings utility	See <i>Dell Integrated Dell Remote Access Controller User's Guide</i> at Dell.com/idracmanuals
Dell Deployment Toolkit	See <i>Dell Deployment Toolkit User's Guide</i> at Dell.com/openmanagemanuals
Dell Lifecycle Controller	See <i>Dell Lifecycle Controller User's Guide</i> at Dell.com/idracmanuals
Chassis or Server LCD panel	See the LCD panel section

You must use the default iDRAC IP address 192.168.0.120 to configure the initial network settings, including setting up DHCP or a static IP for iDRAC.

 **NOTE:** To access iDRAC, ensure that you install the iDRAC port card or connect the network cable to the Ethernet connector 1 on the system board.

 **NOTE:** Ensure that you change the default user name and password after setting up the iDRAC IP address.

Log in to iDRAC

You can log in to iDRAC as:

- iDRAC user
- Microsoft Active Directory user
- Lightweight Directory Access Protocol (LDAP) user

The default user name and password are `root` and `calvin`. You can also log in by using Single Sign-On or Smart Card.

 **NOTE:** You must have iDRAC credentials to log in to iDRAC.

For more information about logging in to iDRAC and iDRAC licenses, see the *Integrated Dell Remote Access Controller User's Guide* at Dell.com/idracmanuals.

Options to install the operating system

If the system is shipped without an operating system, install the supported operating system by using one of the following resources:

Table 19. Resources to install the operating system

Resources	Location
Dell Systems Management Tools and Documentation media	Dell.com/operatingsystemmanuals
Dell Lifecycle Controller	Dell.com/idracmanuals
Dell OpenManage Deployment Toolkit	Dell.com/openmanagemanuals
Dell certified VMware ESXi	Dell.com/virtualizationsolutions
Supported operating systems on Dell PowerEdge systems	Dell.com/ossupport
Installation and How-to videos for supported operating systems on Dell PowerEdge systems	Supported Operating Systems for Dell PowerEdge Systems

Methods to download firmware and drivers

You can download the firmware and drivers by using the following methods:

Table 20. Firmware and drivers

Methods	Location
From the Dell Support site	Dell.com/support/home
Using Dell Remote Access Controller Lifecycle Controller (iDRAC with LC)	Dell.com/idracmanuals
Using Dell Repository Manager (DRM)	Dell.com/openmanagemanuals

Methods	Location
Using Dell Server Update Utility (SUU)	Dell.com/openmanagemanuals
Using Dell OpenManage Deployment Toolkit (DTK)	Dell.com/openmanagemanuals

Pre-operating system management applications

You can manage basic settings and features of a system without booting to the operating system by using the system firmware.

Options to manage the pre-operating system applications

Your system has the following options to manage the pre-operating system applications:

- System Setup
- Boot Manager
- Dell Lifecycle Controller
- Preboot Execution Environment (PXE)

System Setup

By using the **System Setup** screen, you can configure the BIOS settings, iDRAC settings, and device settings of your system.

 **NOTE:** Help text for the selected field is displayed in the graphical browser by default. To view the help text in the text browser, press F1.

You can access system setup by using two methods:

- Standard graphical browser—The browser is enabled by default.
- Text browser—The browser is enabled by using Console Redirection.

System Setup details

The **System Setup Main Menu** screen details are explained as follows:

Option	Description
System BIOS	Enables you to configure BIOS settings.
iDRAC Settings	Enables you to configure iDRAC settings. The iDRAC settings utility is an interface to set up and configure the iDRAC parameters by using UEFI (Unified Extensible Firmware Interface). You can enable or disable various iDRAC parameters by using the iDRAC settings utility. For more information about this utility, see <i>Integrated Dell Remote Access Controller User's Guide</i> at Dell.com/idracmanuals .

Option	Description
Device Settings	Enables you to configure device settings.

System BIOS

You can use the **System BIOS** screen to edit specific functions such as boot order, system password, setup password, set the RAID mode, and enable or disable USB ports.

Viewing System BIOS

To view the **System BIOS** screen, perform the following steps:

1. Turn on, or restart your system.
2. Press F2 immediately after you see the following message:
F2 = System Setup

 **NOTE:** If your operating system begins to load before you press F2, wait for the system to finish booting, and then restart your system and try again.

3. On the **System Setup Main Menu** screen, click **System BIOS**.

System BIOS Settings details

The **System BIOS Settings** screen details are explained as follows:

Option	Description
System Information	Specifies information about the system such as the system model name, BIOS version, and Service Tag.
Memory Settings	Specifies information and options related to the installed memory.
Processor Settings	Specifies information and options related to the processor such as speed and cache size.
SATA Settings	Specifies options to enable or disable the integrated SATA controller and ports.
Boot Settings	Specifies options to specify the boot mode (BIOS or UEFI). Enables you to modify UEFI and BIOS boot settings.
Network Settings	Specifies options to change the network settings.
Integrated Devices	Specifies options to manage integrated device controllers and ports and specify related features and options.
Serial Communication	Specifies options to manage the serial ports and specify related features and options.
System Profile Settings	Specifies options to change the processor power management settings, memory frequency, and so on.
System Security	Specifies options to configure the system security settings, such as system password, setup password, Trusted Platform Module (TPM) security. It also manages the power and NMI buttons on the system.
Miscellaneous Settings	Specifies options to change the system date, time, and so on.

Boot Settings

You can use the **Boot Settings** screen to set the boot mode to either **BIOS** or **UEFI**. It also enables you to specify the boot order.

Viewing Boot Settings

To view the **Boot Settings** screen, perform the following steps:





1. Turn on, or restart your system.
2. Press F2 immediately after you see the following message:
F2 = System Setup

 **NOTE:** If your operating system begins to load before you press F2, wait for the system to finish booting, and then restart your system and try again.

3. On the **System Setup Main Menu** screen, click **System BIOS**.
4. On the **System BIOS** screen, click **Boot Settings**.

Boot Settings details

The **Boot Settings** screen details are explained as follows:

Option	Description
Boot Mode	<p>Enables you to set the boot mode of the system.</p> <p> CAUTION: Switching the boot mode may prevent the system from booting if the operating system is not installed in the same boot mode.</p> <p>If the operating system supports UEFI, you can set this option to UEFI. Setting this field to BIOS allows compatibility with non-UEFI operating systems. This option is set to BIOS by default.</p> <p> NOTE: Setting this field to UEFI disables the BIOS Boot Settings menu. Setting this field to BIOS disables the UEFI Boot Settings menu.</p>
Boot Sequence Retry	<p>Enables or disables the Boot Sequence Retry feature. If this option is set to Enabled and the system fails to boot, the system reattempts the boot sequence after 30 seconds. This option is set to Enabled by default.</p>
Hard-Disk Failover	<p>Specifies the hard drive that is booted in the event of a hard drive failure. The devices are selected in the Hard-Disk Drive Sequence on the Boot Option Setting menu. When this option is set to Disabled, only the first hard drive in the list is attempted to boot. When this option is set to Enabled, all hard drives are attempted to boot in the order selected in the Hard-Disk Drive Sequence. This option is not enabled for UEFI Boot Mode.</p>
Boot Option Settings	<p>Configures the boot sequence and the boot devices.</p>
BIOS Boot Settings	<p>Enables or disables BIOS boot options.</p> <p> NOTE: This option is enabled only if the boot mode is BIOS.</p>
UEFI Boot Settings	<p>Enables or disables UEFI Boot options. The Boot options include IPv4 PXE and IPv6 PXE. This option is set to IPv4 by default.</p> <p> NOTE: This option is enabled only if the boot mode is UEFI.</p>

Choosing the system boot mode

System Setup enables you to specify one of the following boot modes for installing your operating system:

- BIOS boot mode (the default) is the standard BIOS-level boot interface.
 - Unified Extensible Firmware Interface (UEFI) boot mode is an enhanced 64-bit boot interface. If you have configured your system to boot to UEFI mode, it replaces the system BIOS.
1. From the **System Setup Main Menu**, click **Boot Settings**, and select **Boot Mode**.
 2. Select the boot mode you want the system to boot into.

 **CAUTION: Switching the boot mode may prevent the system from booting if the operating system is not installed in the same boot mode.**

3. After the system boots in the specified boot mode, proceed to install your operating system from that mode.

 **NOTE:** Operating systems must be UEFI-compatible to be installed from the UEFI boot mode. DOS and 32-bit operating systems do not support UEFI and can only be installed from the BIOS boot mode.

 **NOTE:** For the latest information about supported operating systems, go to Dell.com/ossupport.

Changing the boot order

You may have to change the boot order if you want to boot from a USB key or an optical drive. The following instructions may vary if you have selected **BIOS** for **Boot Mode**.

1. On the **System Setup Main Menu** screen, click **System BIOS** → **Boot Settings**.
2. Click **Boot Option Settings** → **Boot Sequence**.
3. Use the arrow keys to select a boot device, and use the plus (+) and minus (-) sign keys to move the device down or up in the order.
4. Click **Exit**, and then click **Yes** to save the settings on exit.

System Security

You can use the **System Security** screen to perform specific functions such as setting the system password, setup password and disabling the power button.

Viewing System Security

To view the **System Security** screen, perform the following steps:

1. Turn on, or restart your system.
2. Press F2 immediately after you see the following message:



F2 = System Setup

 **NOTE:** If your operating system begins to load before you press F2, wait for the system to finish booting, and then restart your system and try again.

3. On the **System Setup Main Menu** screen, click **System BIOS**.
4. On the **System BIOS** screen, click **System Security**.

System Security Settings details

The **System Security Settings** screen details are explained as follows:

Option	Description
Intel AES-NI	Improves the speed of applications by performing encryption and decryption by using the Advanced Encryption Standard Instruction Set (AES-NI). This option is set to Enabled by default.
System Password	Sets the system password. This option is set to Enabled by default and is read-only if the password jumper is not installed in the system.
Setup Password	Sets the setup password. This option is read-only if the password jumper is not installed in the system.
Password Status	Locks the system password. This option is set to Unlocked by default.
TPM Security	 NOTE: The TPM menu is available only when the TPM module is installed. Enables you to control the reporting mode of the TPM. The TPM Security option is set to Off by default. You can only modify the TPM Status, TPM Activation, and Intel TXT fields if the TPM Status field is set to either On with Pre-boot Measurements or On without Pre-boot Measurements .
TPM Information	Changes the operational state of the TPM. This option is set to No Change by default.
TPM Status	Specifies the TPM status.
TPM Command	 CAUTION: Clearing the TPM results in the loss of all keys in the TPM. The loss of TPM keys may affect booting to the operating system. Clears all the contents of the TPM. The TPM Clear option is set to No by default.
Intel TXT	Enables or disables the Intel Trusted Execution Technology (TXT) option. To enable the Intel TXT option, virtualization technology and TPM Security must be enabled with Pre-boot measurements. This option is set to Off by default.
Power Button	Enables or disables the power button on the front of the system. This option is set to Enabled by default.
NMI Button	Enables or disables the NMI button on the front of the system. This option is set to Disabled by default.
AC Power Recovery	Sets how the system behaves after AC power is restored to the system. This option is set to Last by default.
AC Power Recovery Delay	Sets the time delay for the system to power up after AC power is restored to the system. This option is set to Immediate by default.
User Defined Delay (60s to 240s)	Sets the User Defined Delay option when the User Defined option for AC Power Recovery Delay is selected.
UEFI Variable Access	Provides varying degrees of securing UEFI variables. When set to Standard (the default), UEFI variables are accessible in the operating system per the UEFI specification. When set to Controlled , selected UEFI variables are protected in the environment and new UEFI boot entries are forced to be at the end of the current boot order.
Secure Boot	Enables Secure Boot, where the BIOS authenticates each pre-boot image by using the certificates in the Secure Boot Policy. Secure Boot is disabled by default.
Secure Boot Policy	When Secure Boot policy is set to Standard , the BIOS uses the system manufacturer's key and certificates to authenticate pre-boot images. When Secure

Option	Description
	Boot policy is set to Custom , the BIOS uses the user-defined key and certificates. Secure Boot policy is set to Standard by default.
Secure Boot Policy Summary	Specifies the list of certificates and hashes that secure boot uses to authenticate images.

Creating a system and setup password

Prerequisites

Ensure that the password jumper is enabled. The password jumper enables or disables the system password and setup password features. For more information, see the System board jumper settings section.

 **NOTE:** If the password jumper setting is disabled, the existing system password and setup password are deleted and you need not provide the system password to boot the system.

Steps

1. To enter System Setup, press F2 immediately after turning on or rebooting your system.
2. On the **System Setup Main Menu** screen, click **System BIOS** → **System Security**.
3. On the **System Security** screen, verify that **Password Status** is set to **Unlocked**.
4. In the **System Password** field, type your system password, and press Enter or Tab.
Use the following guidelines to assign the system password:
 - A password can have up to 32 characters.
 - The password can contain the numbers 0 through 9.
 - Only the following special characters are allowed: space, ("), (+), (.), (-), (.), (/), (:), (I), (\), (l), (').

A message prompts you to reenter the system password.

5. Reenter the system password, and click **OK**.
6. In the **Setup Password** field, type your setup password and press Enter or Tab.
A message prompts you to reenter the setup password.
7. Reenter the setup password, and click **OK**.
8. Press Esc to return to the System BIOS screen. Press Esc again.
A message prompts you to save the changes.

 **NOTE:** Password protection does not take effect until the system reboots.

Related Links

[System Security](#)

[System board jumper settings](#)

Using your system password to secure your system

If you have assigned a setup password, the system accepts your setup password as an alternate system password.

Steps

1. Turn on or reboot your system.
2. Type the system password and press Enter.

Next steps

When **Password Status** is set to **Locked**, type the system password and press Enter when prompted at reboot.

 **NOTE:** If an incorrect system password is typed, the system displays a message and prompts you to reenter your password. You have three attempts to type the correct password. After the third unsuccessful attempt, the system displays an error message that the system has stopped functioning and must be turned off. Even after you turn off and restart the system, the error message is displayed until the correct password is entered.

Deleting or changing system and setup password

Prerequisites

 **NOTE:** You cannot delete or change an existing system or setup password if the **Password Status** is set to **Locked**.

Steps

1. To enter System Setup, press F2 immediately after turning on or restarting your system.
2. On the **System Setup Main Menu** screen, click **System BIOS** → **System Security**.
3. On the **System Security** screen, ensure that **Password Status** is set to **Unlocked**.
4. In the **System Password** field, alter or delete the existing system password, and then press Enter or Tab.
5. In the **Setup Password** field, alter or delete the existing setup password, and then press Enter or Tab. If you change the system and setup password, a message prompts you to reenter the new password. If you delete the system and setup password, a message prompts you to confirm the deletion.
6. Press Esc to return to the **System BIOS** screen. Press Esc again, and a message prompts you to save the changes.

Operating with a setup password enabled

If **Setup Password** is set to **Enabled**, type the correct setup password before modifying the system setup options.

If you do not type the correct password in three attempts, the system displays the following message:

```
Invalid Password! Number of unsuccessful password attempts: <x> System Halted!  
Must power down.
```

Even after you turn off and restart the system, the error message is displayed until the correct password is typed. The following options are exceptions:

- If **System Password** is not set to **Enabled** and is not locked through the **Password Status** option, you can assign a system password. For more information, see the System Security Settings screen section.
- You cannot disable or change an existing system password.

 **NOTE:** You can use the password status option with the setup password option to protect the system password from unauthorized changes.

Related Links

[System Security Settings details](#)

System Information

You can use the **System Information** screen to view system properties such as Service Tag, system model name, and the BIOS version.

Viewing System Information

To view the **System Information** screen, perform the following steps:

1. Turn on, or restart your system.
2. Press F2 immediately after you see the following message:
F2 = System Setup



NOTE: If your operating system begins to load before you press F2, wait for the system to finish booting, and then restart your system and try again.

3. On the **System Setup Main Menu** screen, click **System BIOS**.
4. On the **System BIOS** screen, click **System Information**.

System Information details

The **System Information** screen details are explained as follows:

Option	Description
System Model Name	Specifies the system model name.
System BIOS Version	Specifies the BIOS version installed on the system.
System Management Engine Version	Specifies the current version of the Management Engine firmware.
System Service Tag	Specifies the system Service Tag.
System Manufacturer	Specifies the name of the system manufacturer.
System Manufacturer Contact Information	Specifies the contact information of the system manufacturer.
System CPLD Version	Specifies the current version of the system complex programmable logic device (CPLD) firmware.
UEFI Compliance Version	Specifies the UEFI compliance level of the system firmware.

Memory Settings

You can use the **Memory Settings** screen to view all the memory settings and enable or disable specific memory functions, such as system memory testing and node interleaving.

Viewing Memory Settings

To view the **Memory Settings** screen, perform the following steps:



1. Turn on, or restart your system.
2. Press F2 immediately after you see the following message:
F2 = System Setup

 **NOTE:** If your operating system begins to load before you press F2, wait for the system to finish booting, and then restart your system and try again.

3. On the **System Setup Main Menu** screen, click **System BIOS**.
4. On the **System BIOS** screen, click **Memory Settings**.

Memory Settings details

The **Memory Settings** screen details are explained as follows:

Option	Description
System Memory Size	Specifies the memory size in the system.
System Memory Type	Specifies the type of memory installed in the system.
System Memory Speed	Specifies the system memory speed.
System Memory Voltage	Specifies the system memory voltage.
Video Memory	Specifies the amount of video memory.
System Memory Testing	Specifies whether the system memory tests are run during system boot. Options are Enabled and Disabled . This option is set to Disabled by default.
Memory Operating Mode	<p>Specifies the memory operating mode. The options available are Optimizer Mode, Advanced ECC Mode, Mirror Mode, Spare Mode, Spare with Advanced ECC Mode, Dell Fault Resilient Mode and Dell NUMA Fault Resilient Mode. This option is set to Optimizer Mode by default.</p> <p> NOTE: The Memory Operating Mode option can have different default and available options based on the memory configuration of your system.</p> <p> NOTE: The Dell Fault Resilient Mode option establishes an area of memory that is fault resilient. This mode can be used by an operating system that supports the feature to load critical applications or enables the operating system kernel to maximize system availability.</p>
Node Interleaving	Specifies if Non-Uniform Memory architecture (NUMA) is supported. If this field is set to Enabled , memory interleaving is supported if a symmetric memory configuration is installed. If the field is set to Disabled , the system supports NUMA (asymmetric) memory configurations. This option is set to Disabled by default.

Option	Description
Snoop Mode	Specifies the Snoop Mode options. The Snoop Mode options available are Home Snoop , Early Snoop , and Cluster on Die . This option is set to Early Snoop by default. This field is available only when the Node Interleaving is set to Disabled .

Processor Settings

You can use the **Processor Settings** screen to view the processor settings, and perform specific functions such as enabling virtualization technology, hardware prefetcher, and logical processor idling.

Viewing Processor Settings

To view the **Processor Settings** screen, perform the following steps:

1. Turn on, or restart your system.
2. Press F2 immediately after you see the following message:
F2 = System Setup



 **NOTE:** If your operating system begins to load before you press F2, wait for the system to finish booting, and then restart your system and try again.

3. On the **System Setup Main Menu** screen, click **System BIOS**.
4. On the **System BIOS** screen, click **Processor Settings**.

Processor Settings details

The **Processor Settings** screen details are explained as follows:

Option	Description
Logical Processor	Enables or disables the logical processors and displays the number of logical processors. If this option is set to Enabled , the BIOS displays all the logical processors. If this option is set to Disabled , the BIOS displays only one logical processor per core. This option is set to Enabled by default.
QPI Speed	Enables you to control QuickPath Interconnect data rate settings.
Alternate RTID (Requestor Transaction ID) Setting	Modifies Requestor Transaction IDs, which are QPI resources. This option is set to Disabled by default.  NOTE: Enabling this option may negatively impact the overall system performance.
Virtualization Technology	Enables or disables the additional hardware capabilities provided for virtualization. This option is set to Enabled by default.
Address Translation Service (ATS)	Defines the Address Translation Cache (ATC) for devices to cache the DMA transactions. This option provides an interface between CPU and DMA Memory Management to a chipset's Address Translation and Protection Table to translate DMA addresses to host addresses. This option is set to Enabled by default.
Adjacent Cache Line Prefetch	Optimizes the system for applications that need high utilization of sequential memory access. This option is set to Enabled by default. You can disable this option for applications that need high utilization of random memory access.
Hardware Prefetcher	Enables or disables the hardware prefetcher. This option is set to Enabled by default.
DCU Streamer Prefetcher	Enables or disables the Data Cache Unit (DCU) streamer prefetcher. This option is set to Enabled by default.

Option	Description
DCU IP Prefetcher	Enables or disables the Data Cache Unit (DCU) IP prefetcher. This option is set to Enabled by default.
Execute Disable	Enables you to run the disable memory protection technology. This option is set to Enabled by default.
Logical Processor Idling	Enables you to improve the energy efficiency of a system. It uses the operating system core parking algorithm and parks some of the logical processors in the system which in turn allows the corresponding processor cores to transition into a lower power idle state. This option can only be enabled if the operating system supports it. It is set to Disabled by default.
Configurable TDP	Enables you to reconfigure the processor Thermal Design Power (TDP) levels during POST based on the power and thermal delivery capabilities of the system. TDP verifies the maximum heat the cooling system is needed to dissipate. This option is set to Nominal by default.  NOTE: This option is only available on certain stock keeping units (SKUs) of the processors.
X2Apic Mode	Enables or disables the X2Apic mode.
Dell Controlled Turbo	Controls the turbo engagement. Enable this option only when System Profile is set to Performance .  NOTE: Depending on the number of installed CPUs, there may be up to four processor listings.
Number of Cores per Processor	Controls the number of enabled cores in each processor. This option is set to All by default.
Processor 64-bit Support	Specifies if the processor(s) support 64-bit extensions.
Processor Core Speed	Specifies the maximum core frequency of the processor.
Processor 1	 NOTE: Depending on the number of CPUs, there may be up to four processors listed.

The following settings are displayed for each processor installed in the system:

Option	Description
Family-Model-Stepping	Specifies the family, model, and stepping of the processor as defined by Intel.
Brand	Specifies the brand name.
Level 2 Cache	Specifies the total L2 cache.
Level 3 Cache	Specifies the total L3 cache.
Number of Cores	Specifies the number of cores per processor.

SATA Settings

You can use the **SATA Settings** screen to view the SATA settings of SATA devices and enable RAID on your system.

Viewing SATA Settings

To view the **SATA Settings** screen, perform the following steps:

1. Turn on, or restart your system.
2. Press F2 immediately after you see the following message:

F2 = System Setup



NOTE: If your operating system begins to load before you press F2, wait for the system to finish booting, and then restart your system and try again.

3. On the **System Setup Main Menu** screen, click **System BIOS**.
4. On the **System BIOS** screen, click **SATA Settings**.

SATA Settings details

The **SATA Settings** screen details are explained as follows:

Option	Description
Embedded SATA	Enables the embedded SATA option to be set to Off , ATA , AHCI , or RAID modes. This option is set to AHCI by default.
Security Freeze Lock	Sends Security Freeze Lock command to the Embedded SATA drives during POST. This option is applicable only for ATA and AHCI modes.
Write Cache	Enables or disables the command for Embedded SATA drives during POST.
Port A	Sets the drive type of the selected device. For Embedded SATA settings in ATA mode, set this field to Auto to enable BIOS support. Set it to OFF to turn off BIOS support. For AHCI or RAID mode, BIOS support is always enabled.

Option	Description
Model	Specifies the drive model of the selected device.
Drive Type	Specifies the type of drive attached to the SATA port.
Capacity	Specifies the total capacity of the hard drive. This field is undefined for removable media devices such as optical drives.

Port B	Sets the drive type of the selected device. For Embedded SATA settings in ATA mode, set this field to Auto to enable BIOS support. Set it to OFF to turn off BIOS support. For AHCI or RAID mode, BIOS support is always enabled.
---------------	--

Option	Description
Model	Specifies the drive model of the selected device.
Drive Type	Specifies the type of drive attached to the SATA port.

Option	Description								
	<table border="0"> <thead> <tr> <th style="text-align: left;">Option</th> <th style="text-align: left;">Description</th> </tr> </thead> <tbody> <tr> <td>Capacity</td> <td>Specifies the total capacity of the hard drive. This field is undefined for removable media devices such as optical drives.</td> </tr> </tbody> </table>	Option	Description	Capacity	Specifies the total capacity of the hard drive. This field is undefined for removable media devices such as optical drives.				
Option	Description								
Capacity	Specifies the total capacity of the hard drive. This field is undefined for removable media devices such as optical drives.								
Port C	<p>Sets the drive type of the selected device. For Embedded SATA settings in ATA mode, set this field to Auto to enable BIOS support. Set it to OFF to turn off BIOS support.</p> <p>For AHCI or RAID mode, BIOS support is always enabled.</p> <table border="0"> <thead> <tr> <th style="text-align: left;">Option</th> <th style="text-align: left;">Description</th> </tr> </thead> <tbody> <tr> <td>Model</td> <td>Specifies the drive model of the selected device.</td> </tr> <tr> <td>Drive Type</td> <td>Specifies the type of drive attached to the SATA port.</td> </tr> <tr> <td>Capacity</td> <td>Specifies the total capacity of the hard drive. This field is undefined for removable media devices such as optical drives.</td> </tr> </tbody> </table>	Option	Description	Model	Specifies the drive model of the selected device.	Drive Type	Specifies the type of drive attached to the SATA port.	Capacity	Specifies the total capacity of the hard drive. This field is undefined for removable media devices such as optical drives.
Option	Description								
Model	Specifies the drive model of the selected device.								
Drive Type	Specifies the type of drive attached to the SATA port.								
Capacity	Specifies the total capacity of the hard drive. This field is undefined for removable media devices such as optical drives.								
Port D	<p>Sets the drive type of the selected device. For Embedded SATA settings in ATA mode, set this field to Auto to enable BIOS support. Set it to OFF to turn off BIOS support.</p> <p>For AHCI or RAID mode, BIOS support is always enabled.</p> <table border="0"> <thead> <tr> <th style="text-align: left;">Option</th> <th style="text-align: left;">Description</th> </tr> </thead> <tbody> <tr> <td>Model</td> <td>Specifies the drive model of the selected device.</td> </tr> <tr> <td>Drive Type</td> <td>Specifies the type of drive attached to the SATA port.</td> </tr> <tr> <td>Capacity</td> <td>Specifies the total capacity of the hard drive. This field is undefined for removable media devices such as optical drives.</td> </tr> </tbody> </table>	Option	Description	Model	Specifies the drive model of the selected device.	Drive Type	Specifies the type of drive attached to the SATA port.	Capacity	Specifies the total capacity of the hard drive. This field is undefined for removable media devices such as optical drives.
Option	Description								
Model	Specifies the drive model of the selected device.								
Drive Type	Specifies the type of drive attached to the SATA port.								
Capacity	Specifies the total capacity of the hard drive. This field is undefined for removable media devices such as optical drives.								
Port E	<p>Sets the drive type of the selected device. For Embedded SATA settings in ATA mode, set this field to Auto to enable BIOS support. Set it to OFF to turn off BIOS support.</p> <p>For AHCI or RAID mode, BIOS support is always enabled.</p> <table border="0"> <thead> <tr> <th style="text-align: left;">Option</th> <th style="text-align: left;">Description</th> </tr> </thead> <tbody> <tr> <td>Model</td> <td>Specifies the drive model of the selected device.</td> </tr> <tr> <td>Drive Type</td> <td>Specifies the type of drive attached to the SATA port.</td> </tr> <tr> <td>Capacity</td> <td>Specifies the total capacity of the hard drive. This field is undefined for removable media devices such as optical drives.</td> </tr> </tbody> </table>	Option	Description	Model	Specifies the drive model of the selected device.	Drive Type	Specifies the type of drive attached to the SATA port.	Capacity	Specifies the total capacity of the hard drive. This field is undefined for removable media devices such as optical drives.
Option	Description								
Model	Specifies the drive model of the selected device.								
Drive Type	Specifies the type of drive attached to the SATA port.								
Capacity	Specifies the total capacity of the hard drive. This field is undefined for removable media devices such as optical drives.								
Port F	<p>Sets the drive type of the selected device. For Embedded SATA settings in ATA mode, set this field to Auto to enable BIOS support. Set it to OFF to turn off BIOS support.</p>								

Option

Description

For **AHCI** or **RAID** mode, BIOS support is always enabled.

Option

Description

Model

Specifies the drive model of the selected device.

Drive Type

Specifies the type of drive attached to the SATA port.

Capacity

Specifies the total capacity of the hard drive. This field is undefined for removable media devices such as optical drives.

Port G

Sets the drive type of the selected device. For **Embedded SATA settings** in **ATA** mode, set this field to **Auto** to enable BIOS support. Set it to **OFF** to turn off BIOS support.

For **AHCI** or **RAID** mode, BIOS support is always enabled.

Option

Description

Model

Specifies the drive model of the selected device.

Drive Type

Specifies the type of drive attached to the SATA port.

Capacity

Specifies the total capacity of the hard drive. This field is undefined for removable media devices such as optical drives.

Port H

Sets the drive type of the selected device. For **Embedded SATA settings** in **ATA** mode, set this field to **Auto** to enable BIOS support. Set it to **OFF** to turn off BIOS support.

For **AHCI** or **RAID** mode, BIOS support is always enabled.

Option

Description

Model

Specifies the drive model of the selected device.

Drive Type

Specifies the type of drive attached to the SATA port.

Capacity

Specifies the total capacity of the hard drive. This field is undefined for removable media devices such as optical drives.

Port I

Sets the drive type of the selected device. For **Embedded SATA settings** in **ATA** mode, set this field to **Auto** to enable BIOS support. Set it to **OFF** to turn off BIOS support.

For **AHCI** or **RAID** mode, BIOS support is always enabled.

Option

Description

Model

Specifies the drive model of the selected device.

Drive Type

Specifies the type of drive attached to the SATA port.

Option	Description
Option	Description
Capacity	Specifies the total capacity of the hard drive. This field is undefined for removable media devices such as optical drives.
Port J	Sets the drive type of the selected device. For Embedded SATA settings in ATA mode, set this field to Auto to enable BIOS support. Set it to OFF to turn off BIOS support. For AHCI or RAID mode, BIOS support is always enabled.
Option	Description
Model	Specifies the drive model of the selected device.
Drive Type	Specifies the type of drive attached to the SATA port.
Capacity	Specifies the total capacity of the hard drive. This field is undefined for removable media devices such as optical drives.

Integrated Devices

You can use the **Integrated Devices** screen to view and configure the settings of all integrated devices including the video controller, integrated RAID controller, and the USB ports.

Viewing Integrated Devices

To view the **Integrated Devices** screen, perform the following steps:

1. Turn on, or restart your system.
2. Press F2 immediately after you see the following message:

F2 = System Setup





NOTE: If your operating system begins to load before you press F2, wait for the system to finish booting, and then restart your system and try again.

3. On the **System Setup Main Menu** screen, click **System BIOS**.
4. On the **System BIOS** screen, click **Integrated Devices**.

Integrated Devices details

The **Integrated Devices** screen details are explained as follows:

Option	Description
USB 3.0 Setting	Enables or disables the USB 3.0 support. Enable this option only if your operating system supports USB 3.0. If you disable this option, devices operate at USB 2.0 speed. USB 3.0 is enabled by default.
User Accessible USB Ports	Enables or disables the USB ports. Selecting Only Back Ports On disables the front USB ports, selecting All Ports Off disables all USB ports. The USB keyboard and mouse operate during boot process in certain operating systems. After the boot process is complete, the USB keyboard and mouse do not work if the ports are disabled.

Option	Description
	 NOTE: Selecting Only Back Ports On and All Ports Off disables the USB management port and also restricts access to iDRAC features.
Internal USB Port	Enables or disables the internal USB port. This option is set to Enabled by default.
Integrated RAID Controller	Enables or disables the integrated RAID controller. This option is set to Enabled by default.
Integrated Network Card 1	Enables or disables the integrated network card.
Embedded NIC1 and NIC2	 NOTE: The Embedded NIC1 and NIC2 options are only available on systems that do not have Integrated Network Card 1 .
	<p>Enables or disables the Embedded NIC1 and NIC2 options. If set to Disabled, the NIC may still be available for shared network access by the embedded management controller. The embedded NIC1 and NIC2 options are only available on systems that do not have Network Daughter Cards (NDCs). The Embedded NIC1 and NIC2 option is mutually exclusive with the Integrated Network Card 1 option. Configure the Embedded NIC1 and NIC2 option by using the NIC management utilities of the system.</p>
I/OAT DMA Engine	Enables or disables the I/OAT option. Enable only if the hardware and software support the feature.
Embedded Video Controller	Enables or disables the Embedded Video Controller option. This option is set to Enabled by default.
Current State of Embedded Video Controller	<p>Displays the current state of the embedded video controller. The Current State of Embedded Video Controller option is a read-only field. If the Embedded Video Controller is the only display capability in the system (that is, no add-in graphics card is installed), then the Embedded Video Controller is automatically used as the primary display even if the Embedded Video Controller setting is set to Disabled.</p>
SR-IOV Global Enable	Enables or disables the BIOS configuration of Single Root I/O Virtualization (SR-IOV) devices. This option is set to Disabled by default.
OS Watchdog Timer	<p>If your system stops responding, this watchdog timer aids in the recovery of your operating system. When this option is set to Enabled, the operating system initializes the timer. When this option is set to Disabled (the default), the timer does not have any effect on the system.</p>
Memory Mapped I/O above 4 GB	Enables or disables the support for PCIe devices that need large amounts of memory. This option is set to Enabled by default.
Slot Disablement	<p>Enables or disables the available PCIe slots on your system. The slot disablement feature controls the configuration of PCIe cards installed in the specified slot. Slots must be disabled only when the installed peripheral card prevents booting into the operating system or causes delays in system startup. If the slot is disabled, both the Option ROM and UEFI drivers are disabled.</p>

Serial Communication

You can use the **Serial Communication** screen to view the properties of the serial communication port.

Viewing Serial Communication

To view the **Serial Communication** screen, perform the following steps:

1. Turn on, or restart your system.
2. Press F2 immediately after you see the following message:

F2 = System Setup







NOTE: If your operating system begins to load before you press F2, wait for the system to finish booting, and then restart your system and try again.

3. On the **System Setup Main Menu** screen, click **System BIOS**.
4. On the **System BIOS** screen, click **Serial Communication**.

Serial Communication details

The **Serial Communication** screen details are explained as follows:

Option	Description
Serial Communication	Selects serial communication devices (Serial Device 1 and Serial Device 2) in BIOS. BIOS console redirection can also be enabled and the port address can be specified. This option is set to Auto by default.
Serial Port Address	Enables you to set the port address for serial devices. This option is set to Serial Device 1=COM2, Serial Device 2=COM1 by default.  NOTE: You can use only Serial Device 2 for the Serial Over LAN (SOL) feature. To use console redirection by SOL, configure the same port address for console redirection and the serial device.  NOTE: Every time the system boots, the BIOS syncs the serial MUX setting saved in iDRAC. The serial MUX setting can independently be changed in iDRAC. Loading the BIOS default settings from within the BIOS setup utility may not always revert the serial MUX setting to the default setting of Serial Device 1.
External Serial Connector	Enables you to associate the External Serial Connector to Serial Device 1, Serial Device 2, or the Remote Access Device by using this option.  NOTE: Only Serial Device 2 can be used for Serial Over LAN (SOL). To use console redirection by SOL, configure the same port address for console redirection and the serial device.  NOTE: Every time the system boots, the BIOS syncs the serial MUX setting saved in iDRAC. The serial MUX setting can independently be changed in iDRAC. Loading the BIOS default settings from within the BIOS setup utility may not always revert this setting to the default setting of Serial Device 1.
Failsafe Baud Rate	Specifies the failsafe baud rate for console redirection. The BIOS attempts to determine the baud rate automatically. This failsafe baud rate is used only if the attempt fails, and the value must not be changed. This option is set to 115200 by default.

Option	Description
Remote Terminal Type	Sets the remote console terminal type. This option is set to VT 100/VT 220 by default.
Redirection After Boot	Enables or disables the BIOS console redirection when the operating system is loaded. This option is set to Enabled by default.

System Profile Settings

You can use the **System Profile Settings** screen to enable specific system performance settings such as power management.

Viewing System Profile Settings

To view the **System Profile Settings** screen, perform the following steps:

1. Turn on, or restart your system.
2. Press F2 immediately after you see the following message:
F2 = System Setup



 **NOTE:** If your operating system begins to load before you press F2, wait for the system to finish booting, and then restart your system and try again.

3. On the **System Setup Main Menu** screen, click **System BIOS**.
4. On the **System BIOS** screen, click **System Profile Settings**.

System Profile Settings details

The **System Profile Settings** screen details are explained as follows:

Option	Description
System Profile	Sets the system profile. If you set the System Profile option to a mode other than Custom , the BIOS automatically sets the rest of the options. You can only change the rest of the options if the mode is set to Custom . This option is set to Performance Per Watt Optimized (DAPC) by default. DAPC is Dell Active Power Controller.  NOTE: All the parameters on the system profile setting screen are available only when the System Profile option is set to Custom .
CPU Power Management	Sets the CPU power management. This option is set to System DBPM (DAPC) by default. DBPM is Demand-Based Power Management.
Memory Frequency	Sets the speed of the system memory. You can select Maximum Performance , Maximum Reliability , or a specific speed.
Turbo Boost	Enables or disables the processor to operate in the turbo boost mode. This option is set to Enabled by default.
Energy Efficient Turbo	Enables or disables the Energy Efficient Turbo option. Energy Efficient Turbo (EET) is a mode of operation where a processor's core frequency is adjusted to be within the turbo range based on workload.
C1E	Enables or disables the processor to switch to a minimum performance state when it is idle. This option is set to Enabled by default.
C States	Enables or disables the processor to operate in all available power states. This option is set to Enabled by default.

Option	Description
Collaborative CPU Performance Control	Enables or disables the CPU power management option. When set to Enabled , the CPU power management is controlled by the OS DBPM and the System DBPM (DAPC). This option is set to Disabled by default.
Memory Patrol Scrub	Sets the memory patrol scrub frequency. This option is set to Standard by default.
Memory Refresh Rate	Sets the memory refresh rate to either 1x or 2x. This option is set to 1x by default.
Uncore Frequency	Enables you to select the Processor Uncore Frequency option. Dynamic mode enables the processor to optimize power resources across the cores and uncore during runtime. The optimization of the uncore frequency to either save power or optimize performance is influenced by the setting of the Energy Efficiency Policy option.
Energy Efficient Policy	Enables you to select the Energy Efficient Policy option. The CPU uses the setting to manipulate the internal behavior of the processor and determines whether to target higher performance or better power savings.
Number of Turbo Boost Enabled Cores for Processor 1	 NOTE: If there are two processors installed in the system, you see an entry for Number of Turbo Boost Enabled Cores for Processor 2 . Controls the number of turbo boost enabled cores for processor 1. The maximum number of cores is enabled by default.
Monitor/Mwait	Enables the Monitor/Mwait instructions in the processor. This option is set to Enabled for all system profiles, except Custom by default.  NOTE: This option can be disabled only if the C States option in the Custom mode is set to disabled .  NOTE: When C States is set to Enabled in the Custom mode, changing the Monitor/Mwait setting does not impact the system power or performance.

Miscellaneous Settings

You can use the **Miscellaneous Settings** screen to perform specific functions such as updating the asset tag and changing the system date and time.

Viewing Miscellaneous Settings

To view the **Miscellaneous Settings** screen, perform the following steps:



1. Turn on, or restart your system.
2. Press F2 immediately after you see the following message:
F2 = System Setup

 **NOTE:** If your operating system begins to load before you press F2, wait for the system to finish booting, and then restart your system and try again.

3. On the **System Setup Main Menu** screen, click **System BIOS**.
4. On the **System BIOS** screen, click **Miscellaneous Settings**.

Miscellaneous Settings details

The **Miscellaneous Settings** screen details are explained as follows:

Option	Description
System Time	Enables you to set the time on the system.
System Date	Enables you to set the date on the system.
Asset Tag	Specifies the asset tag and enables you to modify it for security and tracking purposes.
Keyboard NumLock	Enables you to set whether the system boots with the NumLock enabled or disabled. This option is set to On by default.  NOTE: This option does not apply to 84-key keyboards.
F1/F2 Prompt on Error	Enables or disables the F1/F2 prompt on error. This option is set to Enabled by default. The F1/F2 prompt also includes keyboard errors.
Load Legacy Video Option ROM	Enables you to determine whether the system BIOS loads the legacy video (INT 10H) option ROM from the video controller. Selecting Enabled in the operating system does not support UEFI video output standards. This field is available only for UEFI boot mode. You cannot set the option to Enabled if UEFI Secure Boot mode is enabled.
In-System Characterization	Enables or disables In-System Characterization . This option is set to Disabled by default. The two other options are Enabled and Enabled - No Reboot .  NOTE: The default setting for In-System Characterization is subject to change in future BIOS releases. When enabled, In-System Characterization (ISC) executes during POST upon detecting relevant change(s) in system configuration to optimize system power and performance. ISC takes about 20 seconds to execute, and system reset is needed for ISC results to be applied. The Enabled - No Reboot option executes ISC and continues without applying ISC results until the next time system reset occurs. The Enabled option executes ISC and forces an immediate system reset so that ISC results can be applied. It takes the system longer to be ready due to the forced system reset. When disabled, ISC does not execute.

iDRAC Settings utility

The iDRAC settings utility is an interface to set up and configure the iDRAC parameters by using UEFI. You can enable or disable various iDRAC parameters by using the iDRAC settings utility.

 **NOTE:** Accessing some of the features on the iDRAC settings utility needs the iDRAC Enterprise License upgrade.

For more information about using iDRAC, see *Dell Integrated Dell Remote Access Controller User's Guide* at Dell.com/idracmanuals.

Entering the iDRAC Settings utility

1. Turn on or restart the managed system.
2. Press F2 during Power-on Self-test (POST).

3. On the **System Setup Main Menu** page, click **iDRAC Settings**.
The **iDRAC Settings** screen is displayed.

Changing the thermal settings

The iDRAC settings utility enables you to select and customize the thermal control settings for your system.

1. Click **iDRAC Settings** → **Thermal**.
2. Under **SYSTEM THERMAL PROFILE** → **Thermal Profile**, select one of the following options:
 - Default Thermal Profile Settings
 - Maximum Performance (Performance Optimized)
 - Minimum Power (Performance per Watt Optimized)
3. Under **USER COOLING OPTIONS**, set the **Fan Speed Offset**, **Minimum Fan Speed**, and **Custom Minimum Fan Speed**.
4. Click **Back** → **Finish** → **Yes**.

Device Settings

Device Settings enables you to configure device parameters.

Dell Lifecycle Controller

Dell Lifecycle Controller (LC) provides advanced embedded systems management capabilities including system deployment, configuration, update, maintenance, and diagnosis. LC is delivered as part of the iDRAC out-of-band solution and Dell system embedded Unified Extensible Firmware Interface (UEFI) applications.

Embedded system management

The Dell Lifecycle Controller provides advanced embedded systems management throughout the system's lifecycle. The Dell Lifecycle Controller can be started during the boot sequence and can function independently of the operating system.

 **NOTE:** Certain platform configurations may not support the full set of features provided by the Dell Lifecycle Controller.

For more information about setting up the Dell Lifecycle Controller, configuring hardware and firmware, and deploying the operating system, see the Dell Lifecycle Controller documentation at [Dell.com/idracmanuals](https://www.dell.com/idracmanuals).

Boot Manager

The **Boot Manager** screen enables you to select boot options and diagnostic utilities.

Viewing Boot Manager

To enter **Boot Manager**:

1. Turn on, or restart your system.
2. Press F11 when you see the following message:

F11 = Boot Manager

If your operating system begins to load before you press F11, allow the system to complete the booting, and then restart your system and try again.

Boot Manager main menu

Menu item	Description
Continue Normal Boot	The system attempts to boot to devices starting with the first item in the boot order. If the boot attempt fails, the system continues with the next item in the boot order until the boot is successful or no more boot options are found.
One-shot Boot Menu	Enables you to access boot menu, where you can select a one-time boot device to boot from.
Launch System Setup	Enables you to access System Setup.
Launch Lifecycle Controller	Exits the Boot Manager and invokes the Dell Lifecycle Controller program.
System Utilities	Enables you to launch System Utilities menu such as System Diagnostics and UEFI shell.

One-shot BIOS boot menu

One-shot BIOS boot menu enables you to select a one-shot boot device to boot from the following options:

- Launch Diagnostics
- BIOS Update File Explorer
- Reboot System

System Utilities

System Utilities contains the following utilities that can be launched:







- Launch Diagnostics
- BIOS Update File Explorer
- Reboot System

PXE boot

The Preboot Execution Environment (PXE) is an industry standard client or interface that allows networked computers that are not yet loaded with an operating system to be configured and booted remotely by an administrator.

Installing and removing system components

Safety instructions

-  **WARNING:** Whenever you need to lift the system, get others to assist you. To avoid injury, do not attempt to lift the system by yourself.
-  **WARNING:** Opening or removing the system cover while the system is powered on may expose you to a risk of electric shock.
-  **CAUTION:** Do not operate the system without the cover for a duration exceeding five minutes.
-  **CAUTION:** Many repairs may only be done by a certified service technician. You should only perform troubleshooting and simple repairs as authorized in your product documentation, or as directed by the online or telephone service and support team. Damage due to servicing that is not authorized by Dell is not covered by your warranty. Read and follow the safety instructions that are shipped with your product.
-  **CAUTION:** Operating the system without the system cover can result in component damage.
-  **NOTE:** Dell recommends that you always use a static mat and static strap while working on components inside the system.
-  **NOTE:** To ensure proper operation and cooling, all bays in the system and system fans must be populated always with either a component or with a blank.

Related Links

[Removing the system cover](#)

Before working inside your system

Prerequisites

Follow the safety guidelines listed in the Safety instructions section.

Steps

1. Turn off the system, including any attached peripherals.
2. Disconnect the system from the electrical outlet and disconnect the peripherals.
3. Remove the system cover.

After working inside your system

Prerequisites

Follow the safety guidelines listed in the Safety instructions section.

Steps

1. Install the system cover.
2. Reconnect the peripherals and connect the system to the electrical outlet.
3. Turn on the system, including any attached peripherals.

Related Links

[Installing the system cover](#)

Recommended tools

You need the following tools to perform the removal and installation procedures:

- Phillips #2 screwdriver
- Wrist grounding strap connected to the ground

System cover

The system cover protects the components inside the system and helps in maintaining air flow inside the system. Removing the system cover actuates the intrusion switch which aids in maintaining system security.

Removing the system cover

Prerequisites

1. Follow the safety guidelines listed in safety instructions section.
2. Turn off the system, including any attached peripherals.
3. Disconnect the system from the electrical outlet and peripherals.

Steps

1. Loosen the screw from the system cover.
2. Slide the four release latches as indicated by the directional arrows on the latches.
3. Hold the cover on both sides, and lift the cover away from the system.

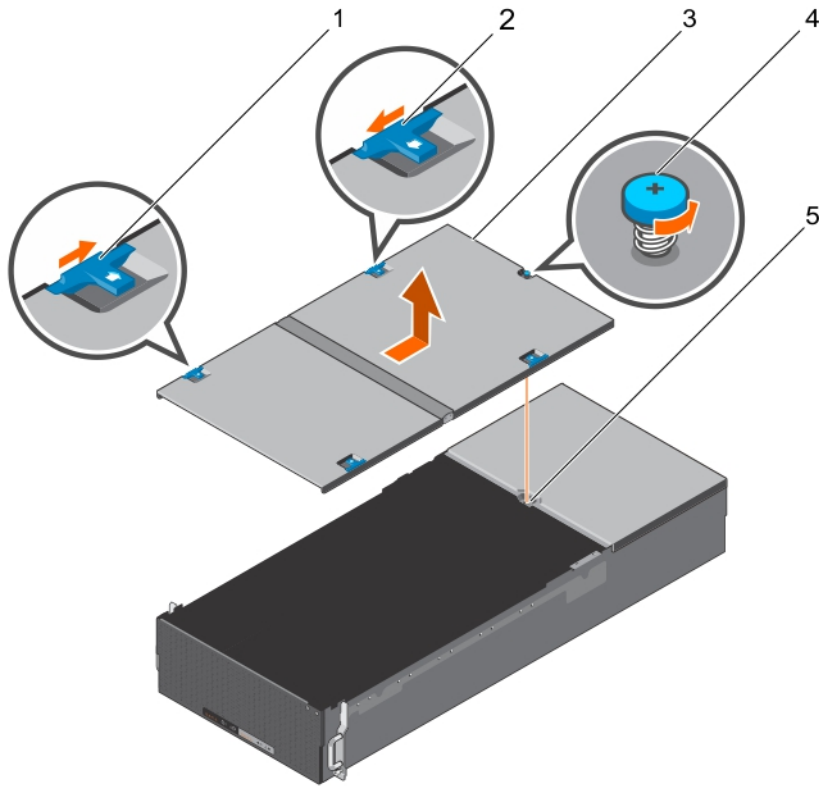

Figure 7. Removing and installing the system cover

- | | |
|------------------------|------------------------|
| 1. release latch 1 (2) | 2. release latch 2 (2) |
| 3. system cover | 4. screw |
| 5. screw guide | |

Installing the system cover

Prerequisites

Follow the safety guidelines listed in safety instructions section.

Steps

1. Align the slots of the system cover with the tabs on the chassis.
2. Slide back the four release latches until they lock into place.
3. Tighten the screw to secure the system cover.

Next steps

Follow the procedure listed in the After working inside your system section.

Related Links

[Safety instructions](#)

[After working inside your system](#)

Server sleds

A dummy sled is installed over the sled B compartment for the single-node system.

Removing the server sled

Prerequisites

 **CAUTION:** Many repairs may only be done by a certified service technician. You should only perform troubleshooting and simple repairs as authorized in your product documentation, or as directed by the online or telephone service and support team. Damage due to servicing that is not authorized by Dell is not covered by your warranty. Read and follow the safety instructions that came with the product.

1. Follow the safety guidelines listed in safety instructions section.
2. Follow the procedure listed in the Before working inside your system section.

 **CAUTION:** Never operate your system with the cooling shroud removed. The system may get overheated quickly, resulting in shutdown of the system and loss of data.

 **CAUTION:** The replacement service time for server sleds when the system is operating is two minutes.

Steps

1. Loosen the two screws locking the server sled.
2. Pull the lever outward to release the server sled.
3. Pull the server sled sway from the system.

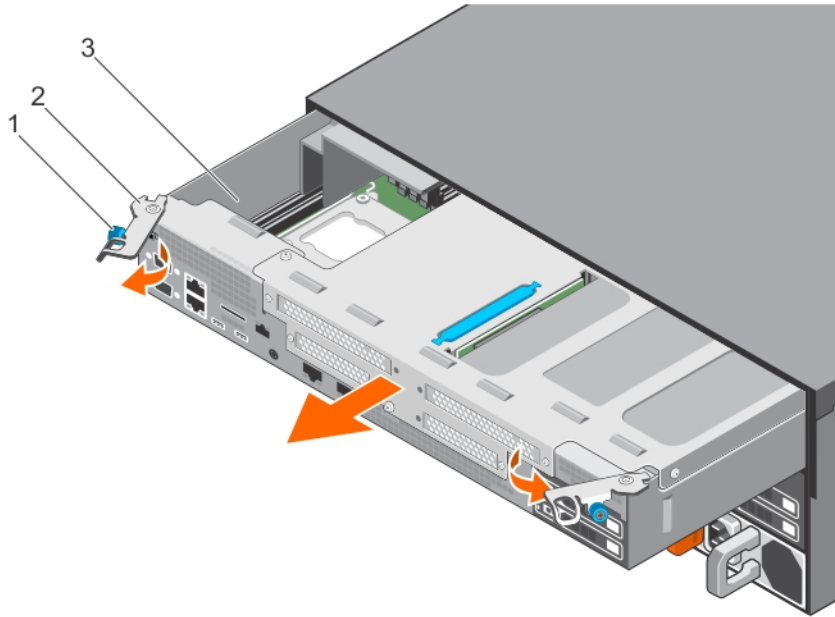

Figure 8. Removing and installing the server sled

1. lever (2)
2. screw (2)
3. server sled

Related Links

[Safety instructions](#)

[Before working inside your system](#)

Installing the server sled

Prerequisites

⚠ CAUTION: Many repairs may only be done by a certified service technician. You should only perform troubleshooting and simple repairs as authorized in your product documentation, or as directed by the online or telephone service and support team. Damage due to servicing that is not authorized by Dell is not covered by your warranty. Read and follow the safety instructions that came with the product.

1. Follow the Safety Guidelines listed in safety instructions section.
2. Follow the procedure listed in the Before working inside your system section.

Steps

1. Install the server sled into the system.

🔧 NOTE: Pay attention not to damage the airmax connectors during installation.

2. Push the lever inward to put the server sled into place.
3. Tighten the two screws to secure the server sled.

Next steps

Follow the procedure listed in the After working inside your system section.

Related Links

[Safety instructions](#)

[Before working inside your system](#)

[After working inside your system](#)

Expansion cards and expansion card riser

An expansion card in the computer is an add-on card that can be inserted into an expansion slot on the computer system board or riser card to add enhanced functionality to the system through the expansion bus.

 **NOTE:** A System Event Log (SEL) event is logged if an expansion card riser is unsupported or missing. It does not prevent your system from turning on and no BIOS POST message or F1/F2 pause is displayed.

Expansion card installation guidelines

 **NOTE:** Only supported cards from Dell can be installed in the system.

Your system supports Generation 3 cards.

Table 21. Expansion card riser configurations for Dell SD7500–S systems

Expansion-card riser module	PCIe slot on the expansion-card riser module	Processor connection	Height	Length	Link width	Slot width
PCIE_G3_X8	1	Processor 2	Half height	Half length	x8	x8
PCIE_G3_X16	2	Processor 1	Full height	Half length	x16	x16
PCIE_G3_X8	3	Processor 1	Full height	Half length	x8	x8
PCIE_G3_X8	4	Processor 1	Full height	Half length	x8	x8

 **NOTE:** The PCIE_G3_X8 and PCIE_G3_X16 are the two different types of risers supported on Dell SD7500–S systems. You can install an expansion card on the system board only using expansion-card riser module.

 **NOTE:** The expansion cards are not hot-swappable.

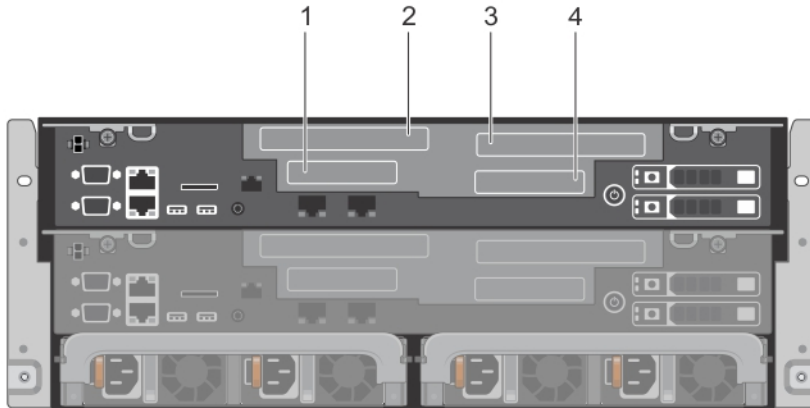

Figure 9. Expansion card slot allocation

- | | |
|-----------|-----------|
| 1. slot 1 | 2. slot 2 |
| 3. slot 3 | 4. slot 4 |

The following table provides a guide for installing expansion cards to ensure proper cooling and mechanical fit. The expansion cards with the highest priority must be installed first using the slot priority indicated. All other expansion cards must be installed in card priority and slot priority order.

Table 22. Expansion card installation priority

Card priority	Card type	Slot priority	Maximum allowed
1	RAID	4	1
2	10 Gb NICs	2.1	2

Removing the expansion-card riser module

Prerequisites

CAUTION: Many repairs may only be done by a certified service technician. You should only perform troubleshooting and simple repairs as authorized in your product documentation, or as directed by the online or telephone service and support team. Damage due to servicing that is not authorized by Dell is not covered by your warranty. Read and follow the safety instructions that came with the product.

1. Follow the safety guidelines listed in safety instructions section.
2. Follow the procedure listed in the Before working inside your system section.
3. Remove the server sled.

Steps

Remove the five screws and lift the expansion-card riser module from the riser connector on the system board.

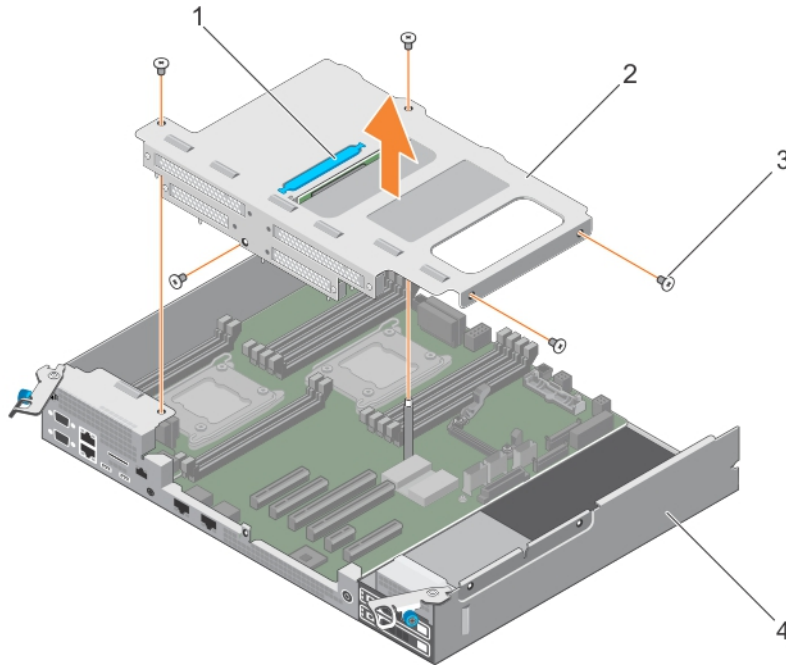

Figure 10. Removing and installing the expansion-card riser module

- | | |
|--------------|--------------------------------|
| 1. puller | 2. expansion-card riser module |
| 3. screw (5) | |

Next steps

1. Install the expansion card, if applicable.
2. Install the expansion-card riser module.
3. Follow the procedure listed in the After working inside your system section.

Related Links

- [Safety instructions](#)
- [Before working inside your system](#)
- [After working inside your system](#)

Installing the expansion-card riser module

Prerequisites

⚠ CAUTION: Many repairs may only be done by a certified service technician. You should only perform troubleshooting and simple repairs as authorized in your product documentation, or as directed by the online or telephone service and support team. Damage due to servicing that is not authorized by Dell is not covered by your warranty. Read and follow the safety instructions that came with the product.

1. Follow the safety guidelines listed in safety instructions section.

Steps

1. If applicable, reinstall the expansion card into the expansion-card riser module.
2. Align the guides on the expansion-card riser module with the holes on the server sled.

3. Lower the expansion-card riser module until it is fully seated.
4. Secure the expansion-card riser module with the five screws.

Next steps

Follow the procedure listed in the After working inside your system section.

Related Links

[Safety instructions](#)

[After working inside your system](#)

Removing an expansion card

Prerequisites



CAUTION: Many repairs may only be done by a certified service technician. You should only perform troubleshooting and simple repairs as authorized in your product documentation, or as directed by the online or telephone service and support team. Damage due to servicing that is not authorized by Dell is not covered by your warranty. Read and follow the safety instructions that came with the product.

1. Follow the safety guidelines listed in Safety Instructions section.
2. Follow the procedure listed in the Before working inside your system section.
3. Remove the expansion-card riser module.

Steps

1. Remove the screw securing the expansion card and remove the expansion card from the riser card.
2. If you are removing the expansion card permanently, install a metal filler bracket over the empty expansion slot.



NOTE: You must install a filler bracket over an empty expansion slot to maintain Federal Communications Commission (FCC) certification of the system. The brackets also keep dust and dirt out of the system and aid in proper cooling and airflow inside the system.

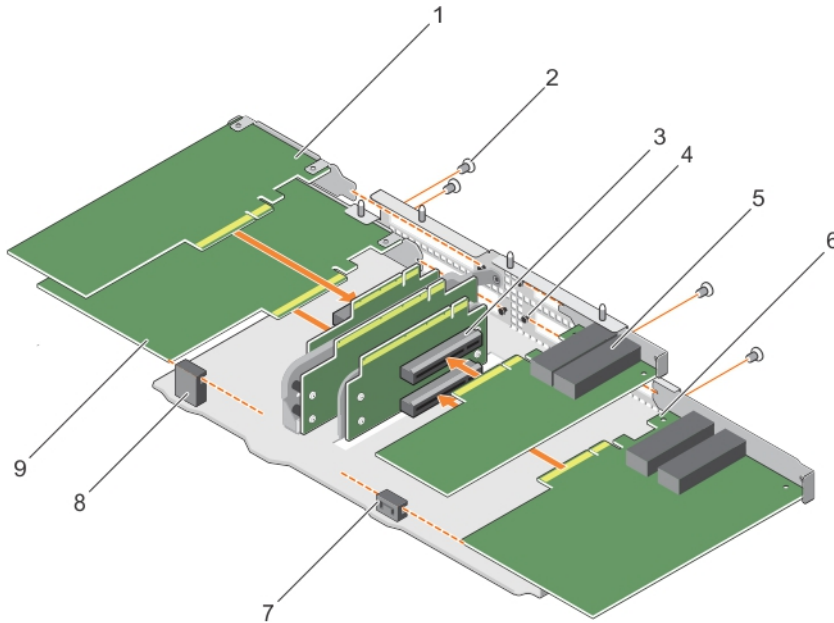

Figure 11. Removing and installing the expansion card

- | | |
|---------------------|--------------------------------|
| 1. NIC card | 2. screws (4) |
| 3. card slot | 4. expansion card riser module |
| 5. NIC card | 6. RAID card |
| 7. RAID card guides | 8. NIC card guides |
| 9. NIC card | |

NOTE: For information about the expansion card priority and slot priority order, see [Table 3. Back-panel features and indicators for a system without dual riser module.](#)

Next steps

Follow the procedure listed in the After working inside your system section.

Related Links

- [Safety instructions](#)
- [Before working inside your system](#)
- [After working inside your system](#)

Installing an expansion card

Prerequisites

NOTE: Only supported cards from Dell can be installed in the system.

CAUTION: Many repairs may only be done by a certified service technician. You should only perform troubleshooting and simple repairs as authorized in your product documentation, or as directed by the online or telephone service and support team. Damage due to servicing that is not authorized by Dell is not covered by your warranty. Read and follow the safety instructions that came with the product.

1. Follow the safety guidelines listed in safety instructions section.
2. Follow the procedure listed in the Before working inside your system section.

3. Remove the expansion-card riser module.

Steps

1. Insert the expansion card into the riser card until the card is fully seated.
2. Secure the expansion card with the screw.

Next steps

1. Install the expansion-card riser module on the system board.
2. Follow the procedure listed in the After working inside your system section.

Related Links

[Safety instructions](#)

[Before working inside your system](#)

[After working inside your system](#)

Installing the supercapacitor

Prerequisites

 **NOTE:** Only supported cards from Dell can be installed in the system.

 **CAUTION:** Many repairs may only be done by a certified service technician. You should only perform troubleshooting and simple repairs as authorized in your product documentation, or as directed by the online or telephone service and support team. Damage due to servicing that is not authorized by Dell is not covered by your warranty. Read and follow the safety instructions that came with the product.

1. Follow the safety guidelines listed in safety instructions section.
2. Follow the procedure listed in the Before working inside your system section.
3. Remove the expansion-card riser module.
4. Remove the expansion card.

Steps

Follow the illustrations below to install the supercapacitor.

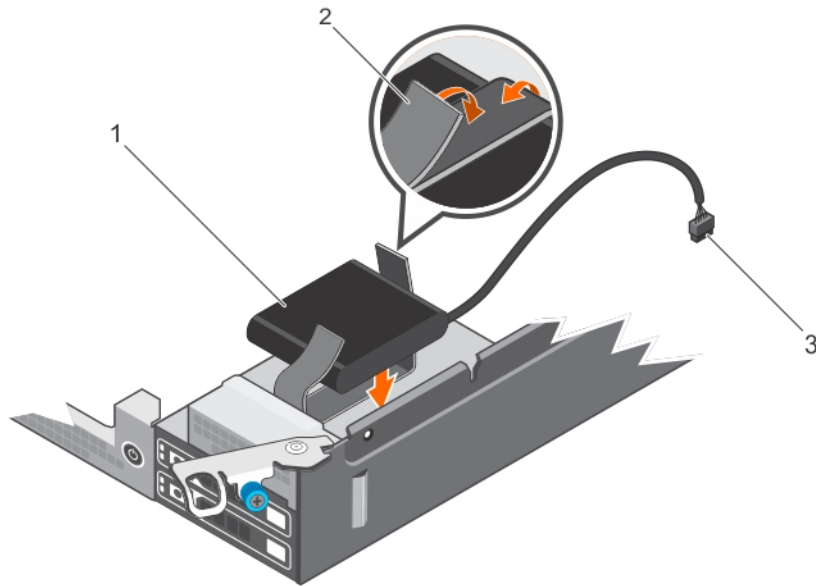

Figure 12. Installing the supercapacitor

- | | |
|----------------------------------|-----------------|
| 1. LSI 49571-15 supercapacitor 1 | 2. fastener (2) |
| 3. extender cable | |

Next steps

1. Install the expansion card to the expansion-card riser module.
2. Install the expansion-card riser module on the system board.
3. Follow the procedure listed in the After working inside your system section.

Related Links

- [Safety instructions](#)
- [Before working inside your system](#)
- [After working inside your system](#)

Removing a riser card

Prerequisites

⚠ CAUTION: Many repairs may only be done by a certified service technician. You should only perform troubleshooting and simple repairs as authorized in your product documentation, or as directed by the online or telephone service and support team. Damage due to servicing that is not authorized by Dell is not covered by your warranty. Read and follow the safety instructions that came with the product.

1. Follow the safety guidelines listed in safety instructions section.
2. Follow the procedure listed in the Before working inside your system section.
3. Remove the expansion-card riser module.
4. Remove the expansion card.

Steps

Remove the screws securing the riser card and lift the card away from the riser module.

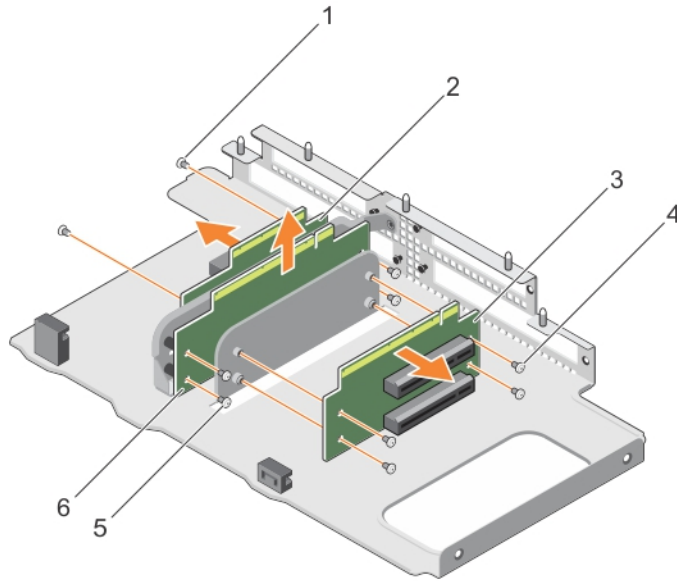

Figure 13. Removing and installing the riser card

- | | |
|--------------------------------|---------------|
| 1. screw (10) | 2. riser card |
| 3. expansion-card riser module | |

Next steps

Follow the procedure listed in the After working inside your system section.

Related Links

- [Safety instructions](#)
- [Before working inside your system](#)
- [After working inside your system](#)

Installing a riser card

Prerequisites

 **NOTE:** Only supported cards from Dell can be installed in the system.

 **CAUTION:** Many repairs may only be done by a certified service technician. You should only perform troubleshooting and simple repairs as authorized in your product documentation, or as directed by the online or telephone service and support team. Damage due to servicing that is not authorized by Dell is not covered by your warranty. Read and follow the safety instructions that came with the product.

1. Follow the safety guidelines listed in Safety instructions section.
2. Follow the procedure listed in the Before working inside your system section.
3. Remove the expansion-card riser module.

Steps

1. Insert the riser card into the expansion-card riser module until the card is fully seated.
2. Secure the card with the screws.

Next steps

1. Install the expansion cards.
2. Install the expansion-card riser module on the system board.
3. Follow the procedure listed in the After working inside your system section.

Related Links

[Safety instructions](#)

[Before working inside your system](#)

[After working inside your system](#)

Cooling shroud

The cooling shroud has aerodynamically placed openings that direct the airflow across the entire system. The airflow passes through all the critical parts of the system, where the vacuum pulls air across the entire surface area of the heat sink, thus allowing increased cooling.

Removing the cooling shroud

Prerequisites

 **CAUTION: Many repairs may only be done by a certified service technician. You should only perform troubleshooting and simple repairs as authorized in your product documentation, or as directed by the online or telephone service and support team. Damage due to servicing that is not authorized by Dell is not covered by your warranty. Read and follow the safety instructions that came with the product.**

1. Follow the safety guidelines listed in safety instructions section.
2. Follow the procedure listed in the Before working inside your system section.
3. Remove the expansion-card riser module.
4. Remove the CPU2 power cable.

 **CAUTION: Never operate your system with the cooling shroud removed. The system may get overheated quickly, resulting in shutdown of the system and loss of data.**

Steps

- Remove the three screws and lift the shroud away from the system board.

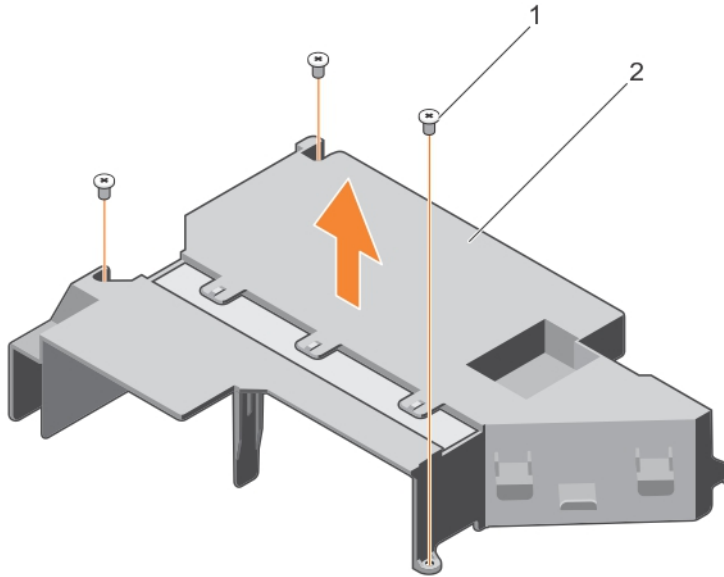

Figure 14. Removing and installing the cooling shroud.

1. screw (3)
2. cooling shroud

Installing the cooling shroud

Prerequisites

CAUTION: Many repairs may only be done by a certified service technician. You should only perform troubleshooting and simple repairs as authorized in your product documentation, or as directed by the online or telephone service and support team. Damage due to servicing that is not authorized by Dell is not covered by your warranty. Read and follow the safety instructions that came with the product.

1. Follow the safety guidelines listed in safety instructions section.
2. Follow the procedure listed in the Before working inside your system section.

Steps

Place the shroud in place on the system board and secure the three screws.

Next steps

1. Connect the CPU2 power cable.
2. Install the expansion-card riser module.
3. Follow the procedure listed in the After working inside your system section.

System memory

Your system supports DDR4 registered DIMMs (RDIMMs). It supports DDR4 voltage specifications.

NOTE: MT/s indicates DIMM speed in MegaTransfers per second.

Memory bus operating frequency is 2133 and 2400 MT/s based on:

- System profile selected — Performance Optimized.

- Maximum supported DIMM frequency of the processors

Your system contains 12 memory sockets split into four sets— two sets of 4 sockets and two sets of 2 sockets each. DIMMs in sockets A1 to A8 are assigned to processor 1 and DIMMs in sockets B1 to B4 are assigned to processor 2. Each 4-socket set is organized into two channels and each 2-socket set is organized into one channel. In each channel of the 4-socket set, the release levers of the first socket are marked white and those of the second socket are marked black. In the 2-socket set, each release lever is marked white.

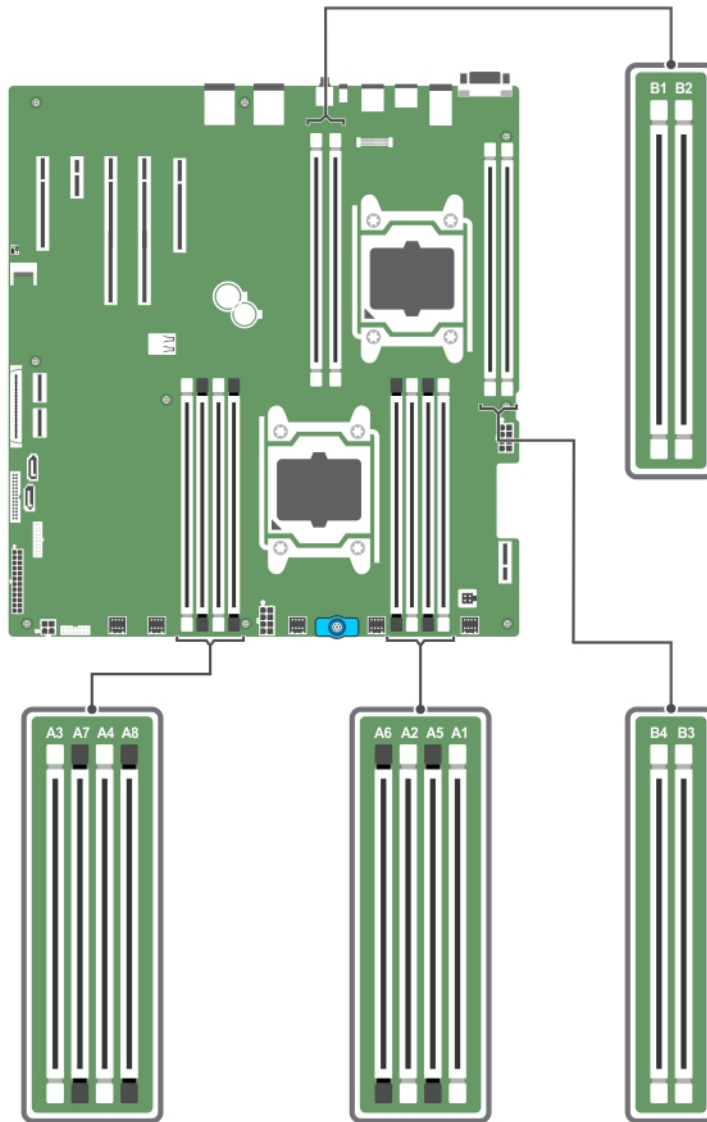

Figure 15. Memory socket locations

Memory channels are organized as follows:

Processor 1

- channel 0: slots A1 and A5

- channel 1: slots A2 and A6
- channel 2: slots A3 and A7
- channel 3: slots A4 and A8

Processor 2

- channel 0: slots B1
- channel 1: slots B2
- channel 2: slots B3
- channel 3: slots B4

Table 23. Memory populations and operating frequencies for the supported configurations

DIMM Type	DIMMs Populated/Channel	Operating Frequency (in MT/s)	Maximum DIMM Rank/Channel
1.2 V			
RDIMM	1	2133 and 2400	Dual rank

General memory module installation guidelines

 **NOTE:** Memory configurations that fail to observe these guidelines can prevent your system from booting, stop responding during memory configuration, or operating with reduced memory.

The system supports Flexible Memory Configuration, enabling the system to be configured and run in any valid chipset architectural configuration. The following are the recommended guidelines for installing memory modules:

- Up to three dual- or single-rank RDIMMs can be populated per channel.
- If memory modules with different speeds are installed, they will operate at the speed of the slowest installed memory module(s) or slower depending on system DIMM configuration.
- Populate memory module sockets only if a processor is installed. For single-processor systems, sockets A1 to A12 are available. For dual-processor systems, sockets A1 to A12 and sockets B1 to B12 are available.
- Populate all the sockets with white release tabs first, followed by the black release tabs, and then the green release tabs.
- Populate the sockets by highest rank count in the following order—first in sockets with white release levers, then black, and then green. For example, if you want to mix single-rank and dual-rank memory modules, populate dual-rank memory modules in the sockets with white release tabs and single-rank memory modules in the sockets with black release tabs.
- When mixing memory modules with different capacities, populate the sockets with memory modules with highest capacity first.
- In a dual-processor configuration, the memory configuration for each processor should be identical. For example, if you populate socket A1 for processor 1, then populate socket B1 for processor 2, and so on.
- Memory modules of different capacities can be mixed provided other memory population rules are followed.
- Populate four memory modules per processor (one DIMM per channel) at a time to maximize performance.

Mode-specific guidelines

Four memory channels are allocated to each processor. The allowable configurations depend on the memory mode selected.

Sample memory configurations

The following tables show sample memory configurations for dual processor configurations that follow the appropriate memory guidelines.



 **NOTE:** 2R in the following tables indicate dual-rank DIMMs.

Table 24. Memory configurations — dual processor

System Capacity (in GB)	DIMM Size (in GB)	Number of DIMMs	DIMM Rank, Organization, and Frequency	DIMM Slot Population
192	16	12	2R, x8, 2133 and 2400 MT/s	A1, A2, A3, A4, A5, A6, A7, A8, B1, B2, B3, B4
256	32	8	2R, x8, 2133 and 2400 MT/s	A1, A2, A3, A4, B1, B2, B3, B4
384	32	12	2R, x8, 2133 and 2400 MT/s	A1, A2, A3, A4, A5, A6, A7, A8, B1, B2, B3, B4

Removing memory modules

Prerequisites

 **CAUTION:** Many repairs may only be done by a certified service technician. You should only perform troubleshooting and simple repairs as authorized in your product documentation, or as directed by the online or telephone service and support team. Damage due to servicing that is not authorized by Dell is not covered by your warranty. Read and follow the safety instructions that are shipped with your product.

1. Follow the safety guidelines listed in the Safety instructions section.
2. Follow the procedure listed in the Before working inside your system section.
3. Remove the cooling shroud.

 **WARNING:** The memory modules are hot to touch for some time after the system has been powered down. Allow the memory modules to cool before handling them. Handle the memory modules by the card edges and avoid touching the components or metallic contacts on the memory module.

 **CAUTION:** To ensure proper system cooling, memory module blanks must be installed in any memory socket that is not occupied. Remove memory module blanks only if you intend to install memory modules in those sockets.

Steps

1. Locate the appropriate memory module socket.

 **CAUTION:** Handle each memory module only by the card edges, ensuring not to touch the middle of the memory module or metallic contacts.

2. To release the memory module from the socket, simultaneously press the ejectors on both ends of the memory module socket.
3. Lift and remove the memory module from the system.

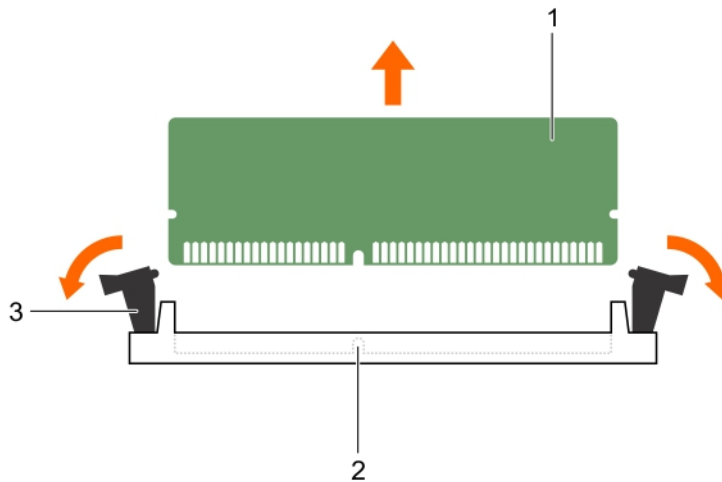

Figure 16. Removing the memory module

1. memory module
2. memory module socket
3. memory module socket ejector (2)

Next steps

1. If you are removing the memory module permanently, install a memory-module blank.
2. Install the memory module.
3. Install the cooling shroud.
4. Follow the procedure listed in the After working inside your system section.

Related Links

[Safety instructions](#)

[Before working inside your system](#)

Installing memory modules

Prerequisites

⚠ CAUTION: Many repairs may only be done by a certified service technician. You should only perform troubleshooting and simple repairs as authorized in your product documentation, or as directed by the online or telephone service and support team. Damage due to servicing that is not authorized by Dell is not covered by your warranty. Read and follow the safety instructions that are shipped with your product.

1. Follow the safety guidelines listed in the Safety instructions section.
2. Follow the procedure listed in the Before working inside your system section.

⚠ WARNING: The memory modules are hot to touch for some time after the system has been powered down. Allow the memory modules to cool before handling them. Handle the memory modules by the card edges and avoid touching the components or metallic contacts on the memory module.

Steps

1. Locate the appropriate memory module socket.

CAUTION: Handle each memory module only by the card edges, ensuring not to touch the middle of the memory module or metallic contacts.

2. Align the edge connector of the memory module with the alignment key of the memory module socket, and insert the memory module in the socket.

CAUTION: Do not apply pressure at the center of the memory module; apply pressure at both ends of the memory module evenly.

NOTE: The memory module socket has an alignment key that enables you to install the memory module in the socket in only one orientation.

3. Press the memory module with your thumbs until the socket levers firmly click into place. When the memory module is properly seated in the socket, the levers on the memory module socket align with the levers on the other sockets that have memory modules installed.

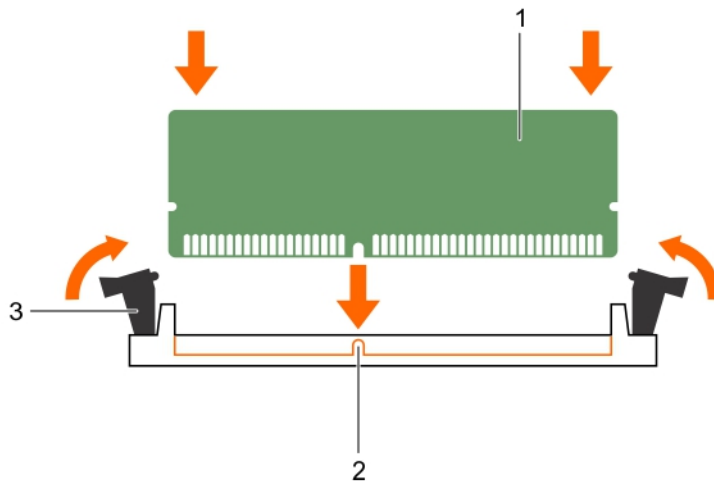

Figure 17. Installing the memory module

- | | |
|-------------------------------------|------------------|
| 1. memory module | 2. alignment key |
| 3. memory module socket ejector (2) | |

Next steps

1. Follow the procedure listed in the After working inside your system section.
2. Press F2 to enter System Setup, and check the **System Memory** setting. The system should have already changed the value to reflect the installed memory.
3. If the value is incorrect, one or more of the memory modules may not be installed properly. Ensure that the memory module is firmly seated in the memory module socket.
4. Run the system memory test in system diagnostics.

Related Links

[Safety instructions](#)

[Before working inside your system](#)

[After working inside your system](#)

Processors and heat sinks

Use the following procedure when:

- Removing and installing a heat sink
- Installing an additional processor
- Replacing a processor

 **NOTE:** To ensure proper system cooling, you must install a processor blank in any empty processor socket.

Removing a processor

Prerequisites

 **WARNING:** The heat sink and processor are hot to the touch for some time after the system has been powered down. Allow the heat sink and processor to cool before handling them.

 **CAUTION:** Many repairs may only be done by a certified service technician. You should only perform troubleshooting and simple repairs as authorized in your product documentation, or as directed by the online or telephone service and support team. Damage due to servicing that is not authorized by Dell is not covered by your warranty. Read and follow the safety instructions that came with the product.

 **CAUTION:** Never remove the heat sink from a processor unless you intend to remove the processor. The heat sink is necessary to maintain proper thermal conditions.

1. Keep the #2 Phillips screwdriver handy.
2. Before upgrading your system, download the latest system BIOS version from [Dell.com/support](https://www.dell.com/support) and follow the instructions included in the compressed download file to install the update on your system.

 **NOTE:** You can update the system BIOS using the Lifecycle Controller. For more information about Dell Lifecycle controller, see [Dell.com/idracmanuals](https://www.dell.com/idracmanuals).

3. Follow the procedure listed in the Before working inside your system section.
4. Remove the server sled.
5. Remove the cooling shroud.

Steps

1. Loosen one of the screws that secures the heat sink to the system board.

 **NOTE:** Wait 30 seconds for the heat sink to loosen from the processor.

2. Remove the screw diagonally opposite the screw you first removed.
3. Repeat the procedure for the remaining two screws.
4. Remove the heat sink.

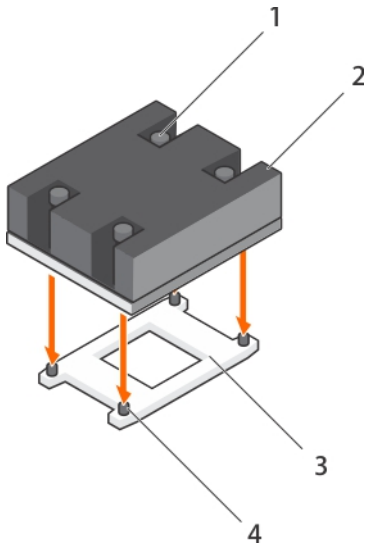

Figure 18. Removing and installing a processor heat sink.

- | | |
|----------------------|--------------|
| 1. captive screw (4) | 2. heat sink |
| 3. processor socket | 4. slot (4) |

⚠ CAUTION: The processor is held in its socket under strong pressure. Be aware that the release lever can spring up suddenly if not firmly grasped.

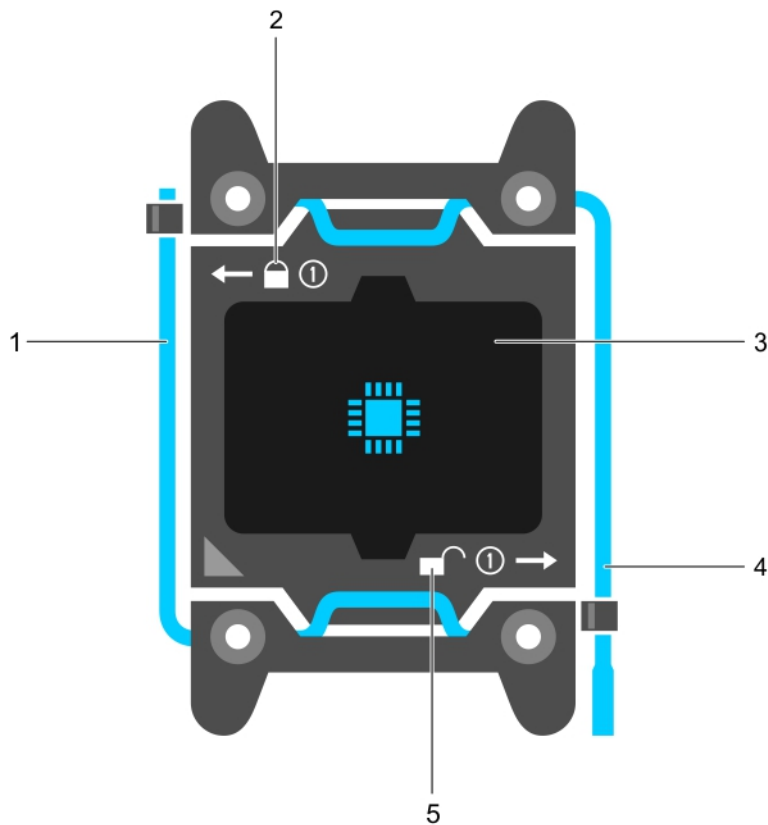



Figure 19. Processor shield opening and closing lever sequence

- | | |
|-------------------------------------|------------------------------------|
| 1. close first socket release lever | 2. lock icon |
| 3. processor | 4. open first socket release lever |
| 5. unlock icon | |
5. Position your thumb firmly over the processor open first socket-release lever near the unlock icon  and release the lever from the locked position by pushing down and out from under the tab.
 6. Similarly, position your thumb firmly over the processor close first socket-release lever near the lock icon  and release the lever from the locked position by pushing down and out from under the tab. Rotate the lever 90 degrees upward.
 7. Lower the open first socket-release lever to lift the processor shield.

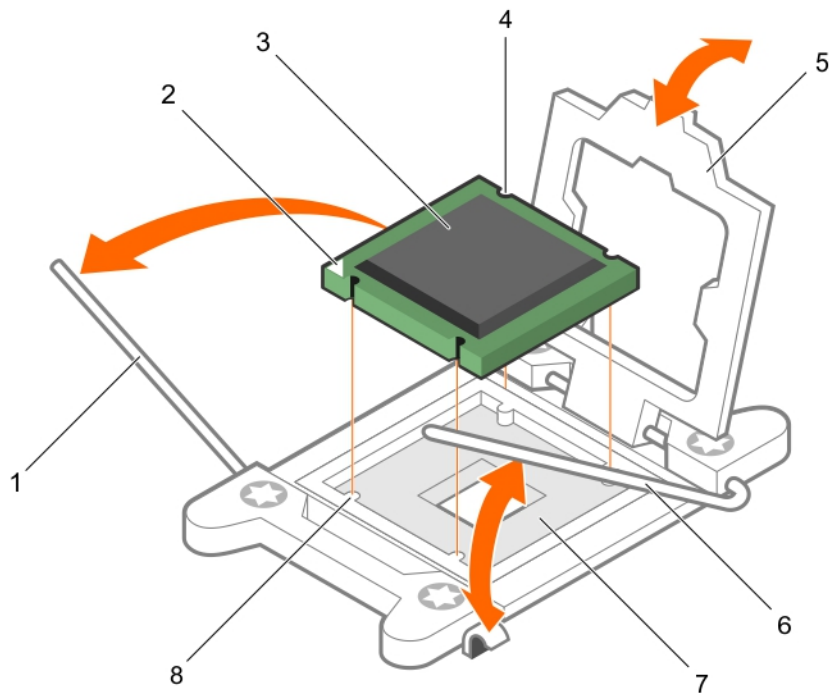

Figure 20. Removing and installing a processor.

- | | |
|-------------------------------------|------------------------------------|
| 1. close first socket release lever | 2. pin-1 indicator of processor |
| 3. processor | 4. slot (4) |
| 5. processor shield | 6. open first socket-release lever |
| 7. socket | 8. socket keys (4) |
8. Hold the tab on the processor shield and rotate the processor shield upward until the open first socket-release lever lifts up.
 9. Lift the processor out of the socket and leave the open first socket-release lever up so that the socket is ready for the new processor.



⚠ CAUTION: The socket pins are fragile and can be permanently damaged. Be careful not to bend the pins in the socket when removing the processor out of the socket.

🔧 NOTE: If you are permanently removing the processor, you must install a socket protective cap in the vacant socket to protect the socket pins and keep the socket free of dust.

🔧 NOTE: After removing the processor, place it in an antistatic container for reuse, return, or temporary storage. Do not touch the bottom of the processor. Touch only the side edges of the processor.

Installing a processor

Prerequisites

-  **WARNING:** The heat sink and processor are hot to the touch for some time after the system has been powered down. Allow the heat sink and processor to cool before handling them.
-  **CAUTION:** Never remove the heat sink from a processor unless you intend to remove the processor. The heat sink is necessary to maintain proper thermal conditions.
-  **CAUTION:** Many repairs may only be done by a certified service technician. You should only perform troubleshooting and simple repairs as authorized in your product documentation, or as directed by the online or telephone service and support team. Damage due to servicing that is not authorized by Dell is not covered by your warranty. Read and follow the safety instructions that came with the product.



1. Keep the #2 Phillips screwdriver handy.
2. Before upgrading your system, download the latest system BIOS version from Dell.com/support and follow the instructions included in the compressed download file to install the update on your system.

 **NOTE:** You can update the system BIOS using the Lifecycle Controller. For more information about Dell Lifecycle controller, see Dell.com/idracmanuals.

3. Follow the procedure listed in the Before working inside your system section.
4. Remove the server sled.
5. Remove the cooling shroud.

 **NOTE:** If you are installing a single processor, it must be installed in socket CPU1.

Steps

1. Remove the heat sink.
2. Unpack the new processor.
 -  **NOTE:** If the processor has previously been used in a system, remove any remaining thermal grease from the processor using a lint-free cloth.
3. Locate the processor socket.
4. If applicable, remove the socket protective cap.
5. Position your thumb firmly over the open first socket-release lever near the unlock icon  and release the lever from the locked position by pushing down and in from under the tab.
6. Similarly, release the close first socket-release lever near the lock icon  from the locked position. Rotate the lever 90 degrees upward.
7. Hold the tab near the lock symbol on the processor shield and rotate it upward and out of the way.
8. To install the processor in the socket:

 **CAUTION:** Positioning the processor incorrectly can permanently damage the system board or the processor. Be careful not to bend the pins in the socket.



 **CAUTION:** While removing or reinstalling the processor, wipe your hands of any contaminants. Contaminants on the processor pins such as thermal grease or oil can damage the processor.

- a. Align the processor with the socket keys on the socket.

△ CAUTION: Do not use force to seat the processor. When the processor is positioned correctly, it engages easily into the socket.

- b. Align the pin-1 indicator of the processor with the triangle on the socket.
- c. Place the processor on the socket such that the slots on the processor aligns with the socket keys on the socket.

△ CAUTION: Do not use force to seat the processor. When the processor is positioned correctly, it engages easily into the socket.

- d. Close the processor shield.
 - e. Rotate the close first socket-release lever near the lock icon  until it is locked in position.
 - f. Similarly, rotate the open first socket-release lever near the unlock icon  to the unlocked position.
9. To install the heat sink:
- a. If applicable, remove the existing thermal grease from the heat sink using a clean lint-free cloth.
 - b. Apply thermal grease on the top of the processor. Use the thermal grease syringe included with your processor kit to apply the grease in a thin spiral on the top of the processor as shown in the figure.

△ CAUTION: Applying too much thermal grease can result in excess grease coming in contact with and contaminating the processor socket.

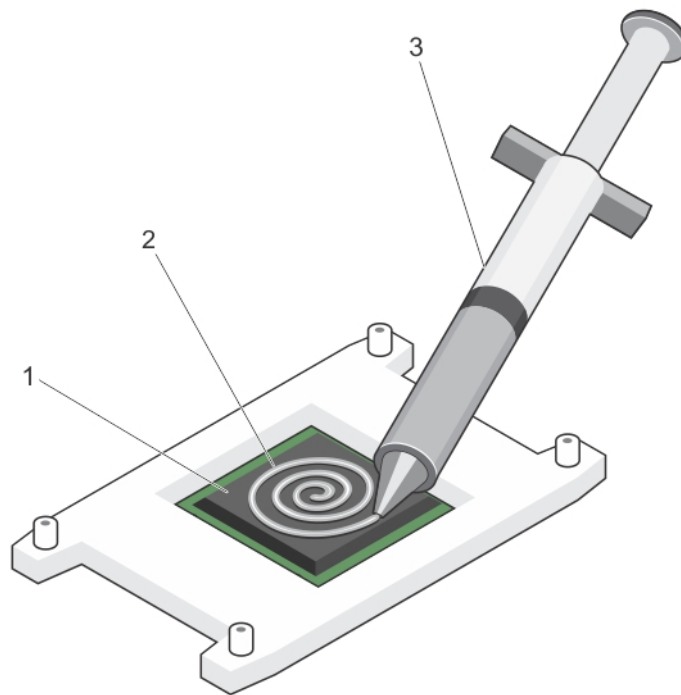



Figure 21. Applying thermal grease on the top of the processor.

1. processor

2. thermal grease

3. thermal grease syringe

 **NOTE:** The thermal grease is intended for one-time use only. Dispose of the syringe after you use it.

- c. Place the heat sink onto the processor.
- d. Tighten the four screws to secure the heat sink to the system board.

 **NOTE:** Tighten the screws diagonally opposite to each other. Do not over-tighten the heat sink retention screws when installing the heat sink. To prevent over-tightening, tighten the retention screw until resistance is felt, and stop once the screw is seated. The screw tension should be no more than 6 in-lb (6.9 kg-cm).

Next steps

1. Install the cooling shroud.
2. Install the server sled.
3. Follow the procedure listed in the After working inside your system section.
4. While booting, press **F2** to start the System Setup and check that the processor information matches the new system configuration.
5. Run the system diagnostics to verify that the new processor operates correctly.

Hard Drives

Table 25. System supports the following hard drives

Single-node systems with one server sled	<ul style="list-style-type: none">• Up to 90 3.5-inch hot-swappable Serial Attached SCSI (SAS) HDDs, SATA HDDs, or SATA SSDs or• Up to 16 hot-swappable SATA or SAS SSDs
Dual-node systems with two server sleds	<ul style="list-style-type: none">• Up to 90 3.5-inch hot-swappable Serial Attached SCSI (SAS) HDDs, SATA HDDs, or SATA SSDs or• Up to 12 hot-swappable SATA or SAS SSDs

 **NOTE:** SSD/SAS/SATA hard drives can be mixed in a system.

The hot-swappable hard drives connect to the system board through the Hard drive backplane. Hot-swappable hard drives are supplied in hot-swappable hard drive carriers that fit in the hard drive slots.

 **CAUTION:** Before attempting to remove or install a hard drive while the system is running, see the documentation for the storage controller card to ensure that the host adapter is configured correctly to support hot-swap hard drive removal and insertion.

 **CAUTION:** Do not turn off or reboot your system while the hard drive is being formatted. Doing so can cause a hard drive failure.

 **NOTE:** Use only hard drives that have been tested and approved for use with the hard drive backplane.

When you format a hard drive, allow enough time for the formatting to be completed. Be aware that high-capacity hard drives can take a number of hours to format.

Removing a 3.5-inch hard drive blank

Prerequisites

△ **CAUTION:** Many repairs may only be done by a certified service technician. You should only perform troubleshooting and simple repairs as authorized in your product documentation, or as directed by the online or telephone service and support team. Damage due to servicing that is not authorized by Dell is not covered by your warranty. Read and follow the safety instructions that came with the product.

△ **CAUTION:** To maintain proper system cooling, all empty hard drive slots must have drive blanks installed.

Follow the safety guidelines listed in Safety instructions section.

Steps

Press the release button and slide the blank out of the hard drive slot.

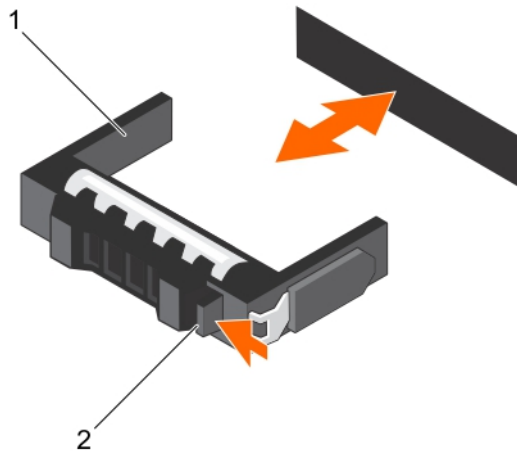

Figure 22. Removing and installing a 3.5-inch hot-swappable hard drive blank

1. hard drive blank

2. release button

Related Links

[Safety instructions](#)

Installing a 3.5-inch hard drive blank

Prerequisites

△ **CAUTION:** Many repairs may only be done by a certified service technician. You should only perform troubleshooting and simple repairs as authorized in your product documentation, or as directed by the online or telephone service and support team. Damage due to servicing that is not authorized by Dell is not covered by your warranty. Read and follow the safety instructions that came with the product.

Follow the safety guidelines listed in Safety instructions section.

Steps

Insert the hard drive blank into the hard drive slot until the release button clicks into place.

Related Links

[Safety instructions](#)

Removing a 3.5-inch hot-swap hard drive

Prerequisites

 **CAUTION: Many repairs may only be done by a certified service technician. You should only perform troubleshooting and simple repairs as authorized in your product documentation, or as directed by the online or telephone service and support team. Damage due to servicing that is not authorized by Dell is not covered by your warranty. Read and follow the safety instructions that came with the product.**

1. Follow the safety guidelines listed in safety instructions section.
2. Using the management software, prepare the hard drive for removal. For more information, see the documentation for the storage controller.

If the hard drive is online, the green activity/fault indicator flashes when the hard drive is turned off. You can remove the hard-drive when the hard drive indicators turn off.

3. Remove the system cover.

 **CAUTION: To prevent data loss, ensure that your operating system supports hot-swap drive installation. See the documentation supplied with your operating system.**

Steps

1. Press the release button to open the hard drive carrier release handle.
2. Slide the hard drive carrier out of the hard drive slot.

 **CAUTION: To maintain proper system cooling, all empty hard-drive slots must have hard-drive blanks installed.**

3. If you are not replacing the hard drive immediately, insert a hard drive blank in the empty hard drive slot.

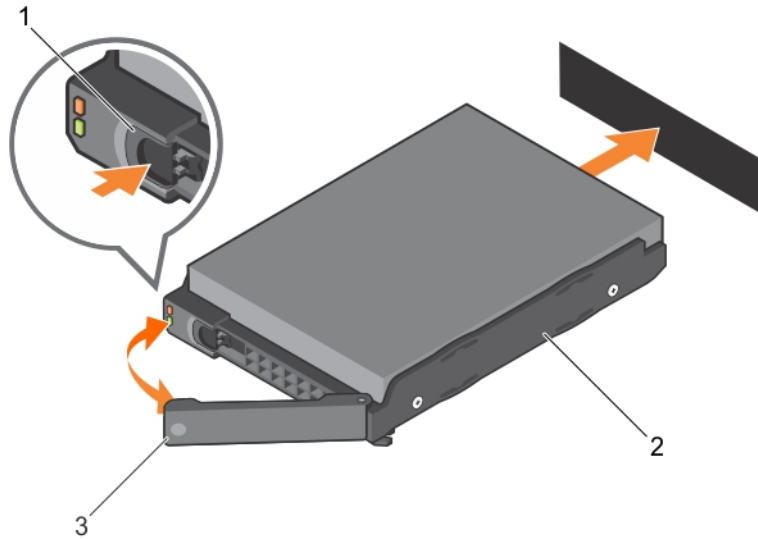

Figure 23. Removing and installing a 3.5-inch hot-swap hard drive

- | | |
|------------------------------|------------------------|
| 1. release button | 2. 3.5-inch hard drive |
| 3. hard drive carrier handle | |

Related Links

[Safety instructions](#)

Installing a hot-swappable hard drive carrier

Prerequisites

- △ **CAUTION:** Many repairs may only be done by a certified service technician. You should only perform troubleshooting and simple repairs as authorized in your product documentation, or as directed by the online or telephone service and support team. Damage due to servicing that is not authorized by Dell is not covered by your warranty. Read and follow the safety instructions that are shipped with your product.
- △ **CAUTION:** Use only hard drives that have been tested and approved for use with the hard drive backplane.
- △ **CAUTION:** Combining SAS and SATA hard drives in the same RAID volume is not supported.
- △ **CAUTION:** When installing a hard drive, ensure that the adjacent drives are fully installed. Inserting a hard drive carrier and attempting to lock its handle next to a partially installed carrier can damage the partially installed carrier's shield spring and make it unusable.
- △ **CAUTION:** To prevent data loss, ensure that your operating system supports hot-swap drive installation. See the documentation supplied with your operating system.
- △ **CAUTION:** When a replacement hot swappable hard drive is installed and the system is powered on, the hard drive automatically begins to rebuild. Make absolutely sure that the replacement hard drive is blank or contains data that you wish to have over-written. Any data on the replacement hard drive is immediately lost after the hard drive is installed.

Steps

1. If a hard drive blank is installed in the hard drive slot, remove it.
2. Install a hard drive in the hard drive carrier.

3. Press the release button on the front of the hard drive carrier and open the hard drive carrier handle.
4. Insert the hard drive carrier into the hard drive slot until the carrier comes in contact with the backplane.
5. Close the hard drive carrier handle to lock the hard drive in place.

Removing a 3.5-inch hard drive from an hard drive carrier

Prerequisites

1. Keep the #2 Phillips screwdriver ready.
2. Remove the HDD carrier from the system.

Steps

1. Remove the screws from the slide rails on the HDD carrier.
2. Lift the HDD out of the HDD carrier.

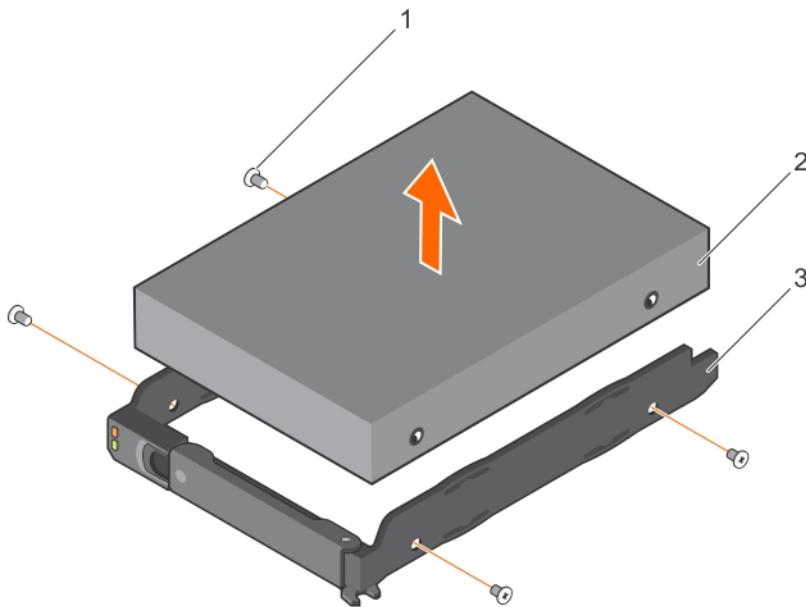

Figure 24. Removing a 3.5-inch hard drive from an hard drive carrier and installing a 3.5-inch hard drive into an hard drive carrier

1. screw (4)
2. 3.5-inch hard drive
3. hard drive carrier

Installing a 3.5-inch hard drive into an hard drive carrier

Prerequisites

△ CAUTION: Many repairs may only be done by a certified service technician. You should only perform troubleshooting and simple repairs as authorized in your product documentation, or as directed by the online or telephone service and support team. Damage due to servicing that is not authorized by Dell is not covered by your warranty. Read and follow the safety instructions that came with the product.

Steps

1. Insert the hard drive into the hard drive carrier with the connector end of the hard drive toward the back.
2. Align the screw holes on the hard drive with the set of screw holes on the hard drive carrier.
When aligned correctly, the back of the hard drive is flush with the back of the hard drive carrier.
3. Attach the screws to secure the hard drive to the hard drive carrier.

Removing a 2.5-inch hot-swap hard drive

Prerequisites

 **CAUTION: Many repairs may only be done by a certified service technician. You should only perform troubleshooting and simple repairs as authorized in your product documentation, or as directed by the online or telephone service and support team. Damage due to servicing that is not authorized by Dell is not covered by your warranty. Read and follow the safety instructions that came with the product.**

1. Using the management software, prepare the hard drive for removal. For more information, see the documentation for the storage controller.
If the hard drive is online, the green activity/fault indicator flashes as the drive is turned off. You can remove the hard drive when the hard drive indicators turn off.
2. Remove the system cover.

 **CAUTION: To prevent data loss, ensure that your operating system supports hot-swap drive installation. See the documentation supplied with your operating system.**

Steps

1. Press the release button to open the hard drive carrier release handle.
2. Slide the hard drive carrier out of the hard drive slot.

 **CAUTION: To maintain proper system cooling, all empty hard drive slots must have hard drive blanks installed.**

3. If you are not replacing the hard drive immediately, insert an hard drive blank in the empty hard drive slot.

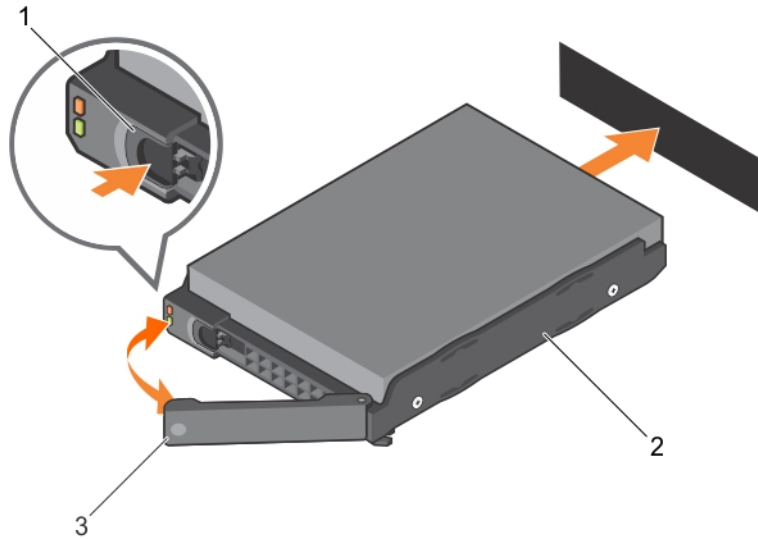

Figure 25. Removing and installing a 2.5-inch hot-swap hard drive

- | | |
|------------------------------|-----------------------|
| 1. release button | 2. hard drive carrier |
| 3. hard drive carrier handle | |

Installing a 2.5-inch hot-swap hard drive

Prerequisites

- △ **CAUTION:** Many repairs may only be done by a certified service technician. You should only perform troubleshooting and simple repairs as authorized in your product documentation, or as directed by the online or telephone service and support team. Damage due to servicing that is not authorized by Dell is not covered by your warranty. Read and follow the safety instructions that came with the product.
- △ **CAUTION:** Use only hard drives that have been tested and approved for use with the hard drive backplane.
- △ **CAUTION:** Combining SAS and SATA hard drives in the same RAID volume is not supported.
- △ **CAUTION:** When installing an hard drive, ensure that the adjacent drives are fully installed. Inserting an hard drive carrier and attempting to lock its handle next to a partially installed carrier can damage the partially installed carrier's shield spring and make it unusable.
- △ **CAUTION:** To prevent data loss, ensure that your operating system supports hot-swap drive installation. See the documentation supplied with your operating system.
- △ **CAUTION:** When a replacement hot-swappable hard drive is installed and the system is powered on, the hard drive automatically begins to rebuild. Make absolutely sure that the replacement hard drive is blank or contains data that you wish to have over-written. Any data on the replacement hard drive is immediately lost after the hard drive is installed.

Steps

1. If a hard drive blank is installed in the hard drive slot, remove it.
2. Install a hard drive in the hard drive carrier.
3. Press the release button on the front of the hard drive carrier and open the hard drive carrier handle.
4. Insert the hard drive carrier into the hard drive slot until the carrier comes in contact with the backplane.

5. Close the hard drive carrier handle to lock the hard drive in place.

Installing a 2.5-inch hard drive into a 3.5-inch hard drive adapter

Prerequisites

△ CAUTION: Many repairs may only be done by a certified service technician. You should only perform troubleshooting and simple repairs as authorized in your product documentation, or as directed by the online or telephone service and support team. Damage due to servicing that is not authorized by Dell is not covered by your warranty. Read and follow the safety instructions that came with the product.

1. Keep the #2 Phillips screwdriver ready.

Steps

1. Align the screw holes on the 2.5-inch hard drive with the screw holes on the 3.5-inch hard drive adapter.
2. Install the screws to secure the hard drive to the hard drive adapter.

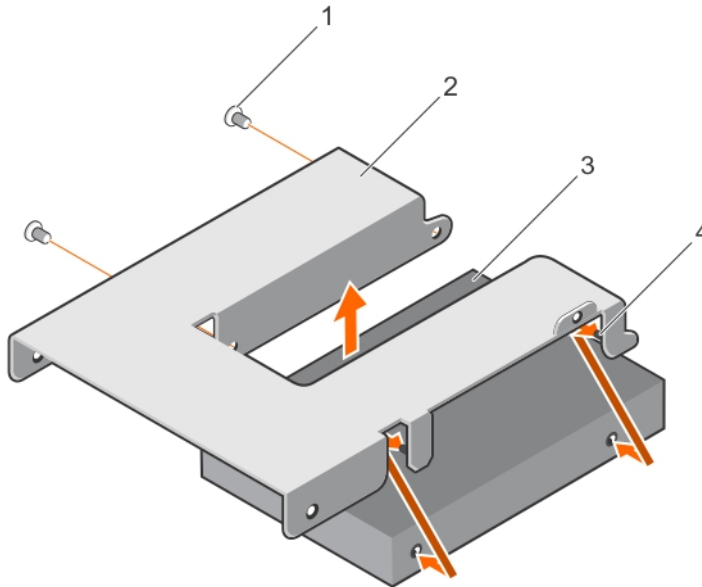

Figure 26. Removing and Installing a 2.5-inch hard drive into a 3.5-inch hard drive adapter

1. screw (2)
2. 3.5-inch hard drive adapter
3. 2.5-inch hard drive

Removing a 2.5-inch hard drive from a 3.5-inch hard drive adapter

Prerequisites

△ CAUTION: Many repairs may only be done by a certified service technician. You should only perform troubleshooting and simple repairs as authorized in your product documentation, or as directed by the online or telephone service and support team. Damage due to servicing that is not authorized by Dell is not covered by your warranty. Read and follow the safety instructions that came with the product.

1. Keep the #2 Phillips screwdriver ready.

 **NOTE:** A 2.5-inch hard drive is installed in a 3.5-inch hard drive adapter, which is then installed in the 3.5-inch hard drive carrier.

Steps

1. Remove the screws from the side of the 3.5-inch hard drive adapter.
2. Remove the hard drive from the hard drive adapter.

Installing a hard drive adapter into a hard drive carrier

Prerequisites

 **CAUTION:** Many repairs may only be done by a certified service technician. You should only perform troubleshooting and simple repairs as authorized in your product documentation, or as directed by the online or telephone service and support team. Damage due to servicing that is not authorized by Dell is not covered by your warranty. Read and follow the safety instructions that came with the product.

1. Keep the #2 Phillips screwdriver ready.

Steps

1. Insert the hard drive adapter into the hard drive carrier with the connector end of the hard drive toward the back of the hard drive carrier.
2. Align the screw holes on the hard drive with the holes on the hard drive carrier.
3. Install the screws to secure the hard drive to the hard drive carrier.

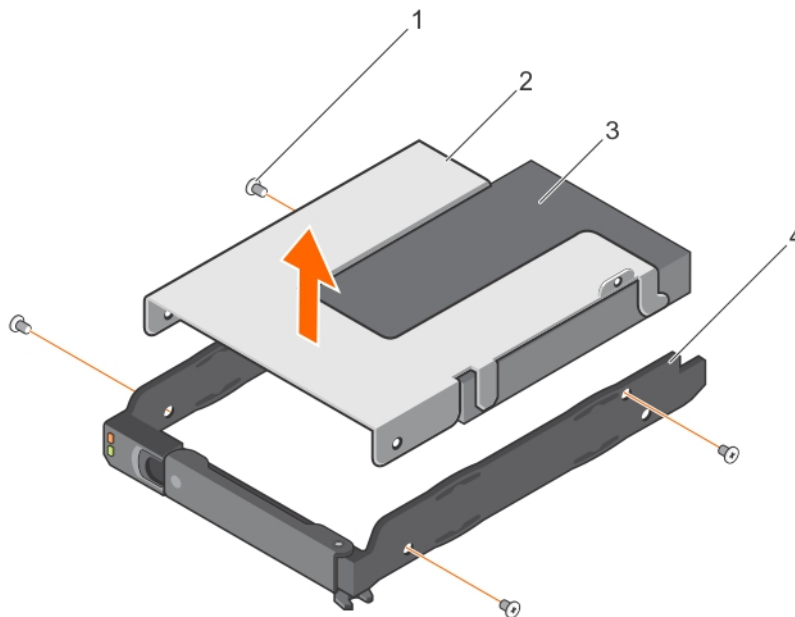

Figure 27. Removing and installing an hard drive adapter into a 3.5-inch hard drive carrier

- | | |
|------------------------|--------------------------------|
| 1. screw (4) | 2. hard drive adapter |
| 3. 2.5-inch hard drive | 4. 3.5-inch hard drive carrier |

Removing a hard drive adapter from a hard drive carrier

Prerequisites

1. Follow the safety guidelines listed in Safety instructions section.
2. Keep the #2 Phillips screwdriver ready.

Steps

1. Remove the screws from the slide rails on the hard drive carrier.
2. Lift the hard drive adapter out of the hard drive carrier.

Related Links

[Safety instructions](#)

Removing a 2.5-inch hard drive from a hard drive carrier

Prerequisites

1. Keep the #2 Phillips screwdriver ready.
2. Remove the hard drive carrier from the system.

Steps

1. Remove the screws from the slide rails on the hard drive carrier.
2. Lift the hard drive out of the hard drive carrier.

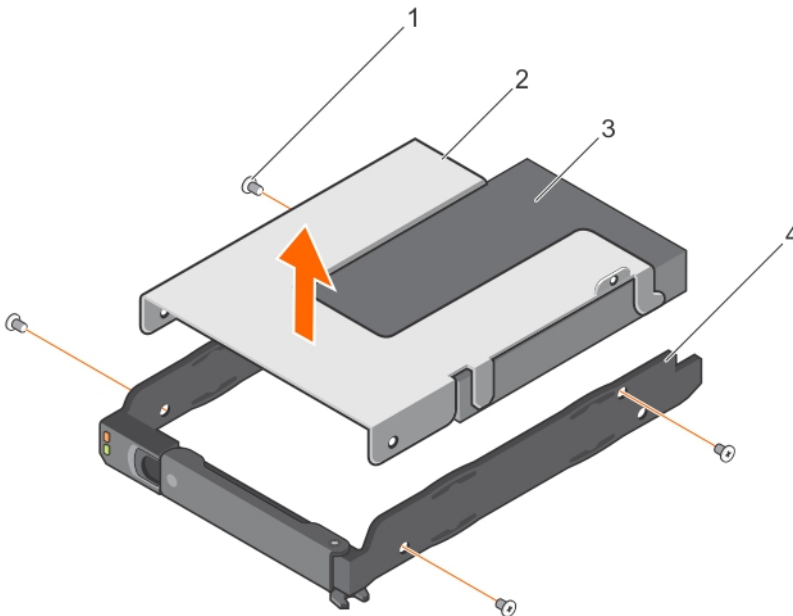

Figure 28. Removing a 2.5-inch hard drive from a hard drive carrier

- | | |
|------------------------|-----------------------|
| 1. screws (4) | 2. hard drive adapter |
| 3. 2.5-inch hard drive | 4. hard drive carrier |

System fans

Your system supports up to six system fans in a redundant PSU configuration.

Related Links

[Safety instructions](#)

Removing a system fan

Prerequisites

 **CAUTION:** Many repairs may only be done by a certified service technician. You should only perform troubleshooting and simple repairs as authorized in your product documentation, or as directed by the online or telephone service and support team. Damage due to servicing that is not authorized by Dell is not covered by your warranty. Read and follow the safety instructions that came with the product.

 **NOTE:** The procedure for removing each fan is identical.

 **CAUTION:** The replacement service time for the system fans when the system is operating is two minutes.

1. Follow the safety guidelines listed in Safety instructions section.
2. Follow the procedure listed in the Before working inside your system section.
3. Remove the system cover.

Steps

1. Pull the two handles inward and lift the fan out of the system fan cage.
2. Lift the fan out of the system fan cage.

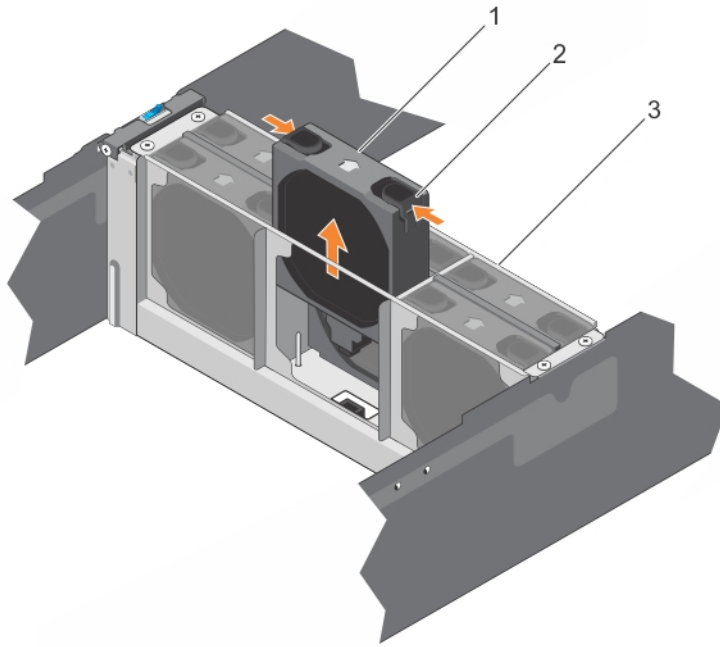

Figure 29. Removing a system fan

1. handle (2)
2. system fan
3. fan cage

Installing a system fan

Prerequisites

⚠ CAUTION: Many repairs may only be done by a certified service technician. You should only perform troubleshooting and simple repairs as authorized in your product documentation, or as directed by the online or telephone service and support team. Damage due to servicing that is not authorized by Dell is not covered by your warranty. Read and follow the safety instructions that came with the product.

1. Follow the safety guidelines listed in Safety instructions section.
2. Remove the system cover.

Steps

Lower the fan into the system fan bracket.

Next steps

1. Install the system cover.
2. Follow the procedure listed in the After working inside your system section.

Related Links

[Safety instructions](#)

[After working inside your system](#)

Removing the fan cage

Prerequisites

CAUTION: Many repairs may only be done by a certified service technician. You should only perform troubleshooting and simple repairs as authorized in your product documentation, or as directed by the online or telephone service and support team. Damage due to servicing that is not authorized by Dell is not covered by your warranty. Read and follow the safety instructions that came with the product.

1. Follow the safety guidelines listed in Safety instructions section.
2. Follow the procedure listed in the After working inside your system section.
3. Turn off the system.
4. Remove the system cover.
5. Remove the system fans.

Steps

1. Remove the four screws from the fan cage.
2. Lift the fan cage out of the chassis.

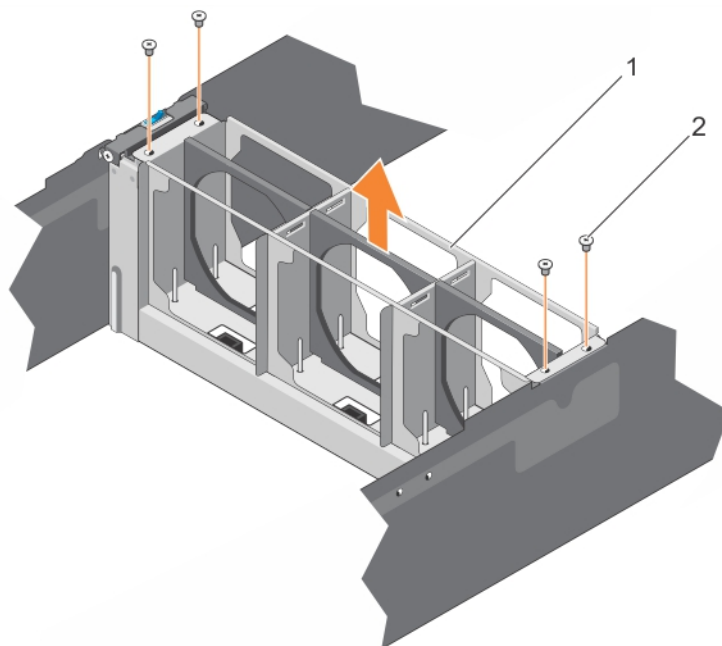

Figure 30. Removing the fan cage

1. fan cage

2. screw (4)

Related Links

[Safety instructions](#)

[After working inside your system](#)

Installing the fan cage

Prerequisites

 **CAUTION:** Many repairs may only be done by a certified service technician. You should only perform troubleshooting and simple repairs as authorized in your product documentation, or as directed by the online or telephone service and support team. Damage due to servicing that is not authorized by Dell is not covered by your warranty. Read and follow the safety instructions that came with the product.

1. Follow the safety guidelines listed in Safety instructions section.
2. Turn off the system.
3. Remove the system cover.

Steps

1. Lower the fan cage into the chassis.
2. Secure the fan cage with the four screws.

Next steps

1. Install the system fan.
2. Install the system cover.
3. Follow the procedure listed in the After working inside your system section..

Related Links

[Safety instructions](#)

[After working inside your system](#)

Power supply units

Your system supports two 1100 W (dual-node systems) or 1600 W (single-node systems) AC redundant PSUs.

When two identical PSUs are installed, the PSU configuration is redundant (1 + 1) for each server sled. In redundant mode, power is supplied to the system equally from both PSUs to maximize efficiency.

 **NOTE:** If two PSUs are used, they must be of the same type and must have the same maximum output power.

 **NOTE:** For AC PSUs, use only PSUs with the Extended Power Performance (EPP) label on the back. Mixing PSUs from earlier generations of Dell servers can result in a PSU mismatch condition or failure to turn on.

Removing a redundant PSU

Prerequisites

 **CAUTION:** Many repairs may only be done by a certified service technician. You should only perform troubleshooting and simple repairs as authorized in your product documentation, or as directed by the online or telephone service and support team. Damage due to servicing that is not authorized by Dell is not covered by your warranty. Read and follow the safety instructions that came with the product.

CAUTION: The system requires one PSU for normal operation. On power-redundant systems, remove and replace only one PSU at a time in a system that is powered on.

CAUTION: The replacement service time for redundant PSUs when the system is operating is two minutes.

1. Follow the safety guidelines listed in Safety instructions section.
2. Disconnect the power cable from the power source.
3. Disconnect the power cable from the PSU and remove the straps that bundle and secure the system cables.

NOTE: You may have to unlatch and lift the optional cable management arm if it interferes with PSU removal. For information about the cable management arm, see the system's rack documentation.

Steps

Press the release latch and pull the PSU straight out to release it from the chassis.

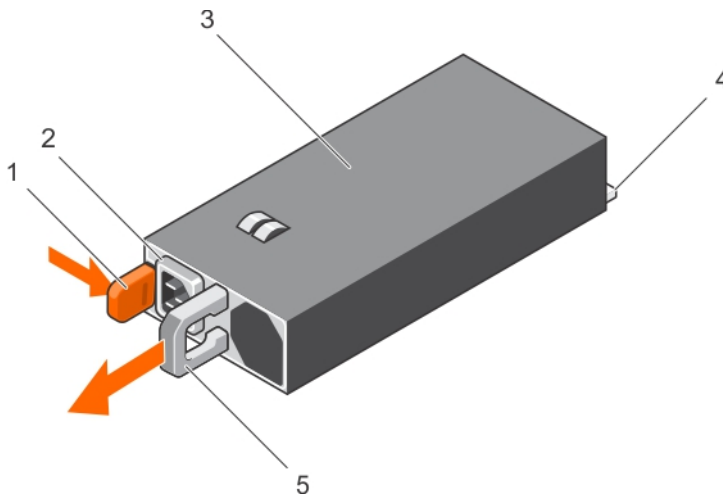

Figure 31. Removing and installing a redundant PSU

- | | |
|------------------|------------------|
| 1. release latch | 2. PSU connector |
| 3. redundant PSU | 4. connector |
| 5. PSU handle | |

Related Links

[Safety instructions](#)





Installing a redundant PSU

Prerequisites

CAUTION: Many repairs may only be done by a certified service technician. You should only perform troubleshooting and simple repairs as authorized in your product documentation, or as directed by the online or telephone service and support team. Damage due to servicing that is not authorized by Dell is not covered by your warranty. Read and follow the safety instructions that came with the product.

Follow the safety guidelines listed in Safety instructions section.

Steps

1. Verify that both PSUs are the same type and have the same maximum output power.
 -  **NOTE:** The maximum output power (shown in Watts) is listed on the PSU label.
2. Slide the new PSU into the chassis until the PSU is fully seated and the release latch snaps into place.
 -  **NOTE:** If you unlatched the cable management arm in step 3 of the previous procedure, relatch it. For information about the cable management arm, see the system's rack documentation.
3. Connect the power cable to the PSU and plug the cable into a power outlet.
 -  **CAUTION: When connecting the power cable, secure the cable with the strap.**
 -  **NOTE:** When installing, hot-swapping, or hot-adding a new PSU in a system with two PSUs, allow several seconds for the system to recognize the PSU and determine its status. The PSU status indicator turns green to signify that the PSU is functioning properly.

Related Links



[Safety instructions](#)

System battery

The system board battery is used for low-level system functions like powering the real-time clock and storing the computer's BIOS settings.

Replacing the system battery

Prerequisites

-  **WARNING:** There is a danger of a new battery exploding if it is incorrectly installed. Replace the battery only with the same or equivalent type recommended by the manufacturer. See your safety information for additional information.
 -  **CAUTION:** Many repairs may only be done by a certified service technician. You should only perform troubleshooting and simple repairs as authorized in your product documentation, or as directed by the online or telephone service and support team. Damage due to servicing that is not authorized by Dell is not covered by your warranty. Read and follow the safety instructions that came with the product.
1. Follow the procedure listed in the Before working inside your system section.
 2. Remove the server sled.
 3. Remove the expansion-card riser module.

Steps

1. Locate the battery socket. For more information, see the System board connectors section.
 -  **CAUTION: To avoid damage to the battery connector, you must firmly support the connector while installing or removing a battery.**
2. To eject the battery, press firmly on the edge of the positive side of the battery in the direction of the arrow as shown in the following figure.

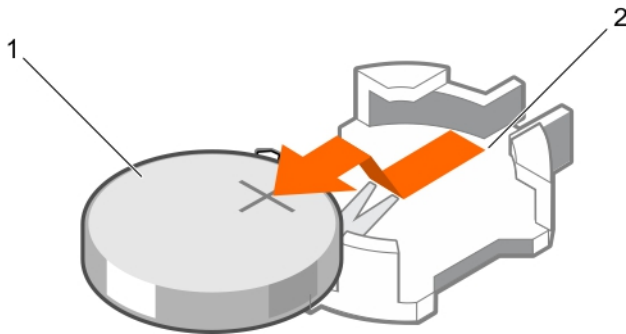

Figure 32. Replacing the system battery

- | | | | |
|----|--|----|----------------|
| 1. | positive side of the battery connector | 2. | system battery |
| 3. | negative side of the battery connector | | |
3. To install a new system battery, hold the battery with the positive facing up and slide it under the securing tabs.
 4. Press the battery into the connector until it snaps into place.

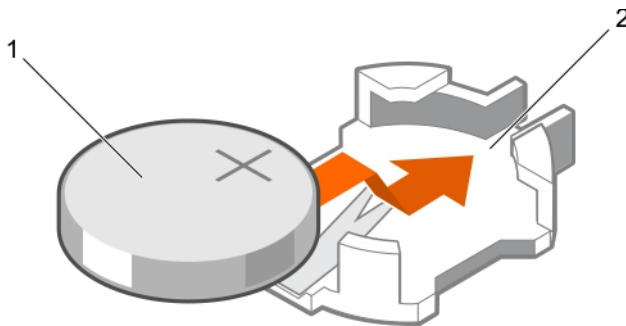

Figure 33. Installing the system battery

- | | | | |
|----|----------------|----|--|
| 1. | system battery | 2. | positive side of the battery connector |
|----|----------------|----|--|

Next steps

1. Install the expansion-card riser module.
2. Install the server sled.
3. Follow the procedure listed in the After working inside your system section.
4. While booting, press F2 to start the System Setup and ensure the battery is operating properly.
5. Enter the correct time and date in the System Setup Time and Date fields.
6. Exit the System Setup.

Related Links

[Before working inside your system](#)

[After working inside your system](#)

Power interposer board

The power interposer board is a board that connects the redundant power supplies to the system board. The power interposer board (PIB) is only supported in systems with redundant power supplies.

Removing the interposer board

Prerequisites

 **NOTE:** Many repairs may only be done by a certified service technician. You should only perform troubleshooting and simple repairs as authorized in your product documentation, or as directed by the online or telephone service and support team. Damage due to servicing that is not authorized by Dell is not covered by your warranty. Read and follow the safety instructions that came with the product.

1. Follow the safety guidelines listed in Safety instructions section.
2. Follow the procedure listed in the Before working inside your system section.
3. Remove the PSUs from the system.
4. Remove the server sleds.
5. Remove the system cover.
6. Remove the system fans and fan cage.

Steps

1. Disconnect all cables from the interposer board.
2. Pull the latch upward and lift the interposer board out of the chassis.

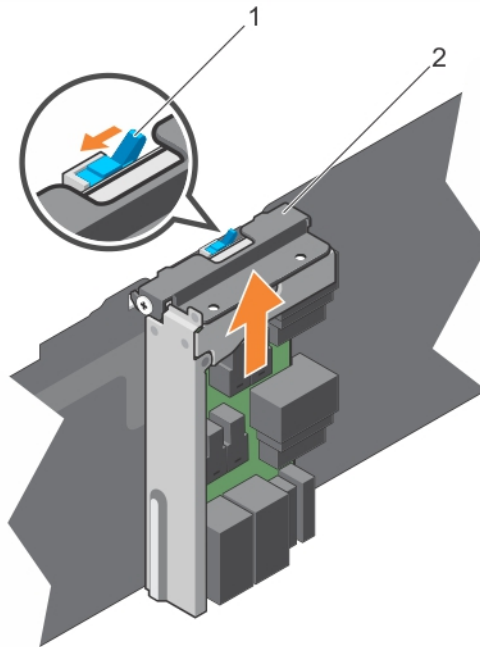

Figure 34. Removing and installing the power interposer board

1. latch

2. interposer board

Related Links

[Safety instructions](#)

[Before working inside your system](#)

Installing the interposer board

Prerequisites

 **NOTE:** Many repairs may only be done by a certified service technician. You should only perform troubleshooting and simple repairs as authorized in your product documentation, or as directed by the online or telephone service and support team. Damage due to servicing that is not authorized by Dell is not covered by your warranty. Read and follow the safety instructions that came with the product.

Follow the safety guidelines listed in Safety instructions section.

Steps

1. Install the interposer board into the chassis.
2. Push the latch downward to secure the interposer board to the chassis.
3. Reconnect all cables to the interposer board.

Next steps

1. Install the system fans and fan cage.
2. Install the system cover.
3. Install the server sleds.
4. Follow the procedure listed in the After working inside your system section.

Related Links

[Safety instructions](#)

[After working inside your system](#)

Expander board

Removing the expander board

Prerequisites

 **CAUTION:** Many repairs may only be done by a certified service technician. You should only perform troubleshooting and simple repairs as authorized in your product documentation, or as directed by the online or telephone service and support team. Damage due to servicing that is not authorized by Dell is not covered by your warranty. Read and follow the safety instructions that came with the product.

1. Follow the safety guidelines listed in Safety instructions section.
2. Follow the procedure listed in the Before working inside your system section.
3. Remove the PSUs from the system.
4. Remove the system cover.

Steps

1. Remove the PSUs.
2. Loosen the two screws, and then open and pull the handle to remove the expander board bracket from the chassis.

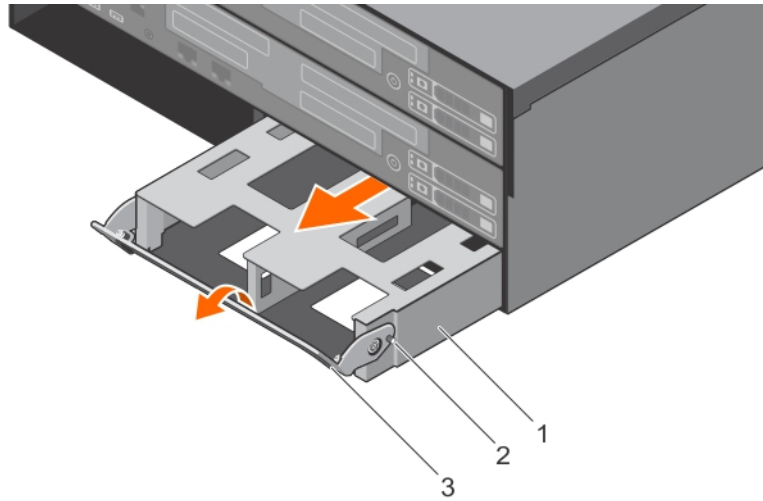

Figure 35. Removing and installing the expander board bracket.

1. expander board bracket
 2. screw (3)
 3. handle (2)
3. Remove the six screws securing the expander board.
 4. Remove the expander board from the expander board bracket.

Figure 36. Removing and installing the expander board from the expander board bracket.

1. screw (6)

Installing the expander board

Prerequisites

⚠ CAUTION: Many repairs may only be done by a certified service technician. You should only perform troubleshooting and simple repairs as authorized in your product documentation, or as directed by the online or telephone service and support team. Damage due to servicing that is not authorized by Dell is not covered by your warranty. Read and follow the safety instructions that came with the product.

Follow the safety guidelines listed in Safety instructions section.

Steps

1. Install the expander board into the chassis.
2. Secure the expander board with the six screws.
3. Push the handle to install the expander board bracket into the chassis and secure the bracket with the two screws.
4. Install the PSUs.

Next steps

1. Install the system cover.
2. Follow the procedure listed in the After working inside your system section.

Related Links

- [Safety instructions](#)
- [After working inside your system](#)

Paddle board

Removing the paddle board

Prerequisites

⚠ CAUTION: Many repairs may only be done by a certified service technician. You should only perform troubleshooting and simple repairs as authorized in your product documentation, or as directed by the online or telephone service and support team. Damage due to servicing that is not authorized by Dell is not covered by your warranty. Read and follow the safety instructions that came with the product.

1. Follow the safety guidelines listed in Safety instructions section.
2. Follow the procedure listed in the Before working inside your system section.
3. Remove the server sled.

Steps

1. Disconnect all cables from the paddle board.
2. Remove the two screws on the paddle board and lift it away from the server sled.

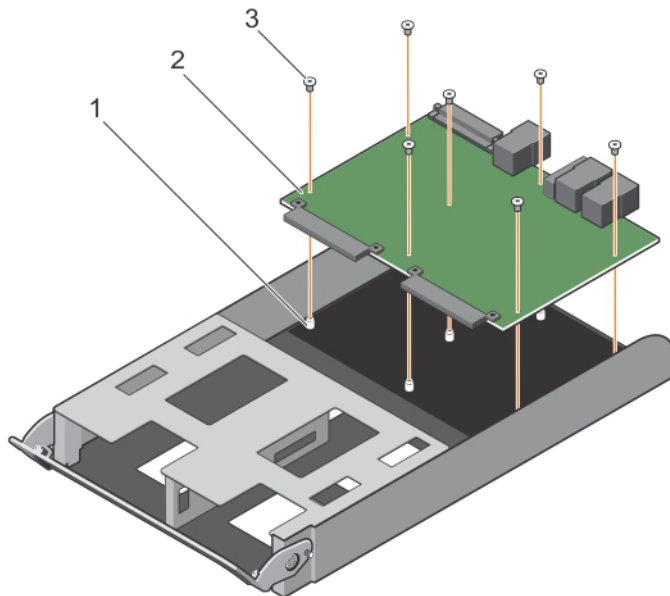

Figure 37. Removing and installing the paddle board.

1. screw hole (7)
2. paddle board

3. screw (7)

Related Links

[Safety instructions](#)

[Before working inside your system](#)

Installing the paddle board

Prerequisites

 **CAUTION:** Many repairs may only be done by a certified service technician. You should only perform troubleshooting and simple repairs as authorized in your product documentation, or as directed by the online or telephone service and support team. Damage due to servicing that is not authorized by Dell is not covered by your warranty. Read and follow the safety instructions that came with the product.

Follow the safety guidelines listed in Safety instructions section.

Steps

1. Install the paddle board into the server sled.
2. Tighten the two screws that secure the paddle board to the server sled.

Next steps

1. Reconnect all cables to the paddle board.
2. Follow the procedure listed in the After working inside your system section.

Related Links

[Safety instructions](#)

[After working inside your system](#)

Hard drive cage and backplane

The Dell SD7000–S chassis supports 3.5-inch (x90) SAS/SATA backplane.

Removing the hard drive cage and backplane

Prerequisites

 **CAUTION:** Many repairs may only be done by a certified service technician. You should only perform troubleshooting and simple repairs as authorized in your product documentation, or as directed by the online or telephone service and support team. Damage due to servicing that is not authorized by Dell is not covered by your warranty. Read and follow the safety instructions that came with the product.

 **CAUTION:** To prevent damage to the drives and backplane, you must remove the hard drives from the system before removing the backplane.

 **CAUTION:** You must note the number of each hard drive and temporarily label them before removal so that you can replace them in the same locations.

1. Follow the safety guidelines listed in Safety instructions section.
2. Follow the procedure listed in the Before working inside your system section.
3. Turn off the system.
4. Remove the system cover.

5. Remove all hard drives.
6. Remove all system fans and the fan cage.
7. Remove all PSUs.
8. Remove all server sleds.
9. Remove all expander boards.
10. Disconnect all cables from the backplane.

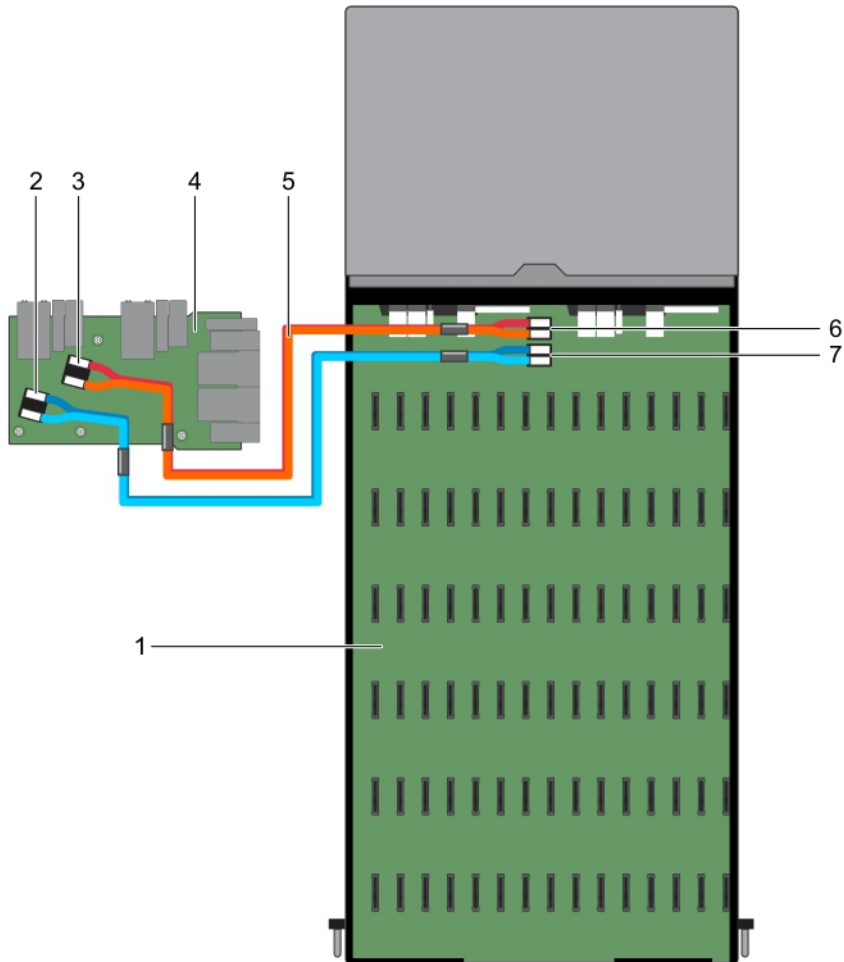

Figure 38. Cabling diagram for the backplane

- | | |
|---|---|
| 1. hard drive backplane | 2. SAS_A and SAS_B connectors on the backplane |
| 3. SAS_C and SAS_D connectors on the backplane | 4. interposer board |
| 5. mini-SAS HD cable (2) | 6. SAS_A and SAS_B connectors on the interposer board |
| 7. SAS_C and SAS_D connectors on the interposer board | |

11. Remove the interposer board.

Steps

1. Remove the 24 screws securing the hard drive cage to the chassis.

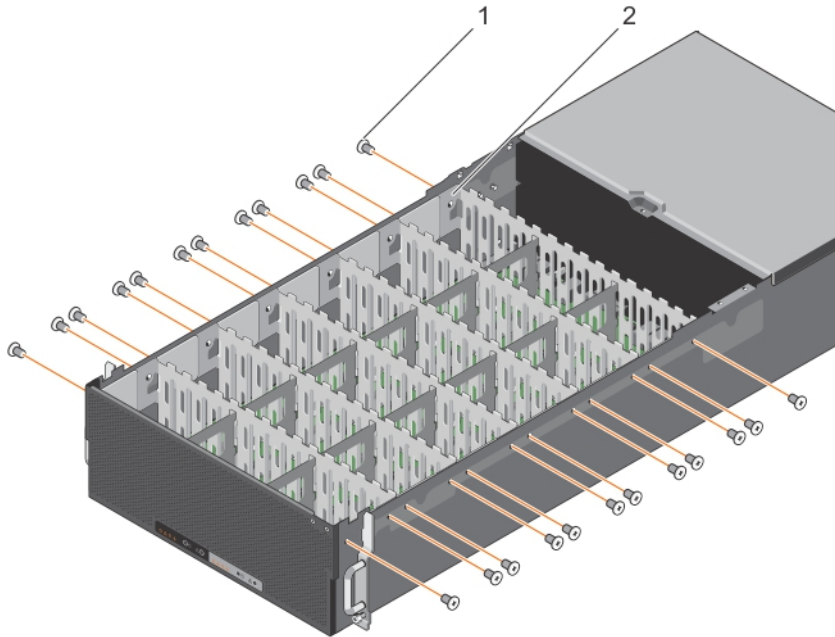

Figure 39. Removing and Installing the hard drive cage

1. screw (24)
2. hard drive cage
2. Loosen the 18 screws and lift the hard drive cage out of the chassis.

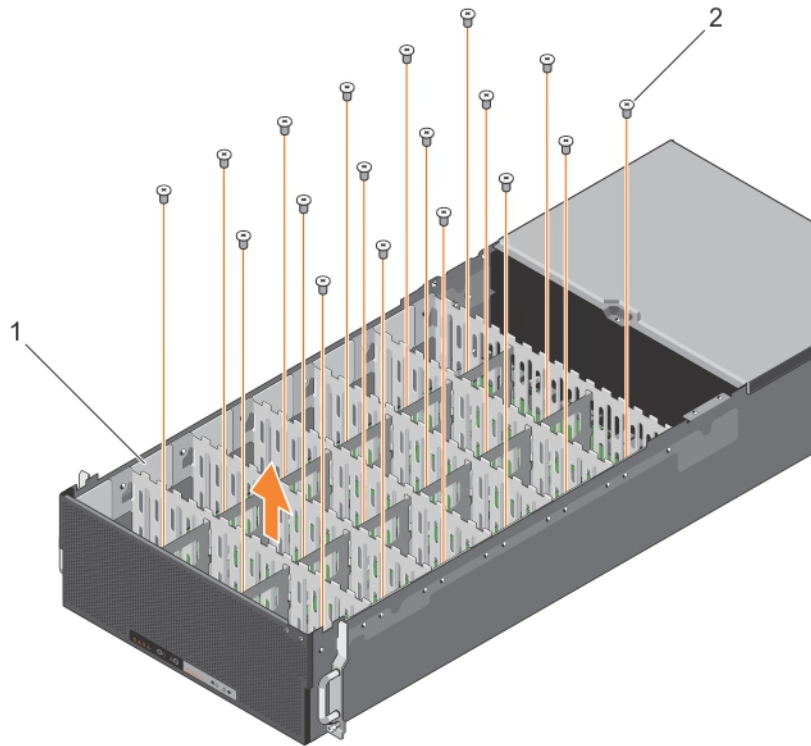

Figure 40. Removing and Installing the hard drive cage

1. hard drive cage
2. screw (18)
3. Remove the 26 screws from the backplane.
4. Remove the two standoffs from the backplane.
5. Slide the backplane to unlock the guide pins.
6. Lift the backplane out of the chassis.

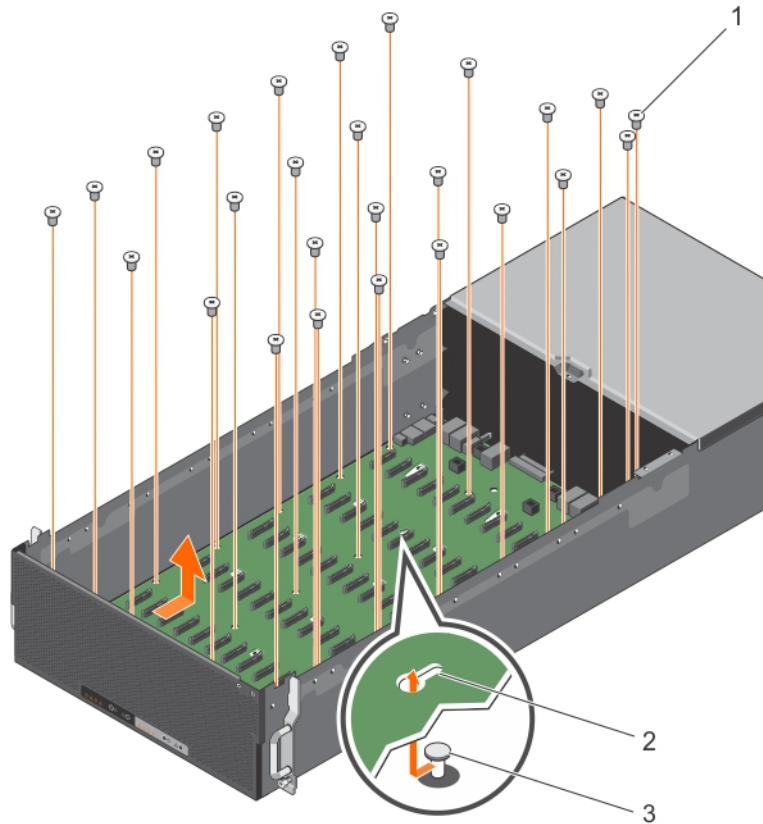

Figure 41. Removing and Installing the backplane

- 1. screw (26)
- 2. guide pin(4)
- 3. standoff (2)

Related Links

- [Safety instructions](#)
- [Before working inside your system](#)

Installing the hard drive cage and backplane

Prerequisites

⚠ CAUTION: Many repairs may only be done by a certified service technician. You should only perform troubleshooting and simple repairs as authorized in your product documentation, or as directed by the online or telephone service and support team. Damage due to servicing that is not authorized by Dell is not covered by your warranty. Read and follow the safety instructions that came with the product.

1. Follow the safety guidelines listed in Safety instructions section.
2. Follow the procedure listed in the Before working inside your system section.
3. Turn off the system.
4. Remove the system cover.
5. Remove all hard drives.

Take note of the hard drive allocation so that you can re-install the hard drives in their original locations.

6. Remove all system fans and the fan cage.
7. Remove all PSUs.
8. Remove all server sleds.
9. Remove all expander boards.
10. Remove the interposer board.

Steps

1. Use the hooks on the chassis as guides to align the hard drive backplane.
2. Slide the backplane to lock the guide pins.
3. Secure the two standoffs to the backplane.
4. Secure the backplane with the 26 screws.
5. Place the HDD cage inside the chassis and secure it with the 18 screws.
6. Secure the HDD cage to the chassis with the 24 screws.

Next steps

1. Install the interposer board.
2. Connect all cables to the backplane.
3. Install all expander boards.
4. Install the fan cage and all system fans.
5. Install all server sleds.
6. Install the hard drives in their original locations.
Begin with slot number 44 in the descending order.
7. Install all PSUs.
8. Install the system cover.
9. Follow the procedure listed in the After working inside your system section.

Related Links

[Safety instructions](#)

[Before working inside your system](#)

[After working inside your system](#)

System board

Removing the system board

Prerequisites



CAUTION: Many repairs may only be done by a certified service technician. You should only perform troubleshooting and simple repairs as authorized in your product documentation, or as directed by the online or telephone service and support team. Damage due to servicing that is not authorized by Dell is not covered by your warranty. Read and follow the safety instructions that came with the product.

1. Follow the safety guidelines listed in Safety instructions section.
2. Follow the procedure listed in the Before working inside your system section.
3. Remove the server sled.

4. Remove or disconnect the following components:
 - a. cooling shroud
 - b. memory modules
 - c. sled cables
 - d. expansion cards
 - e. riser card
 - f. expansion-card riser module
 - g. heat sink and processor

Steps

1. Disconnect all other cables from the system board.

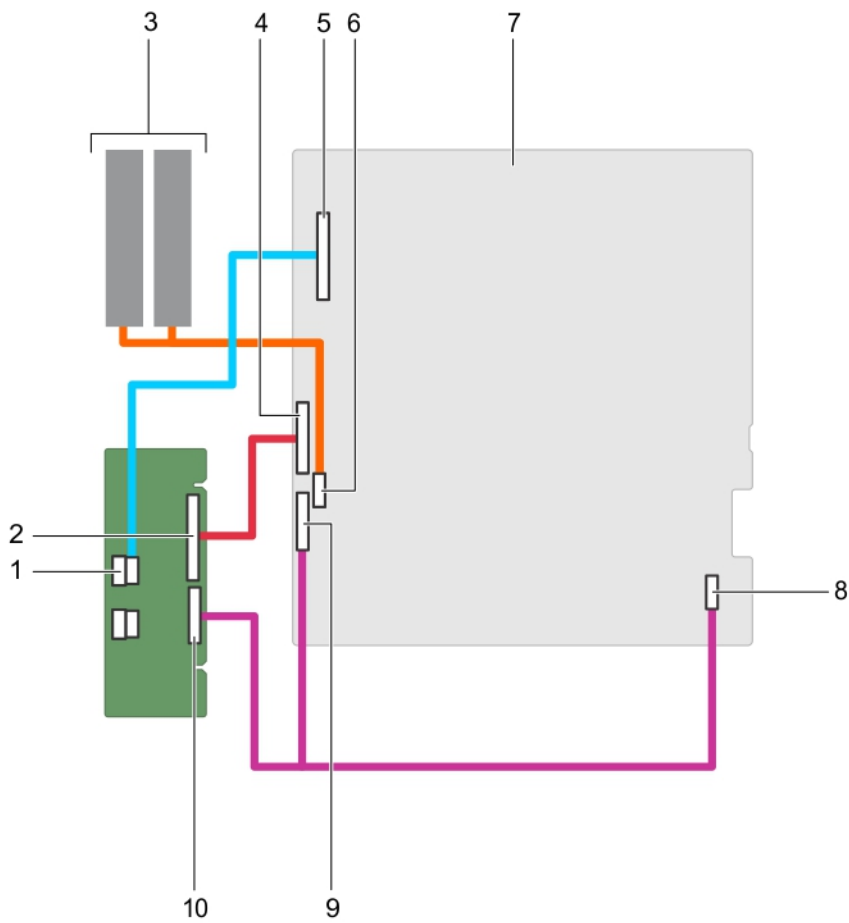

Figure 42. Cabling diagram

- | | |
|---------------------------|---|
| 1. mini SAS HDD connector | 2. 60-pin FBI cable connector |
| 3. server sleds | 4. FBI cable connector |
| 5. hard drive | 6. SATA 7P cable connector |
| 7. system board | 8. 18-pin power cable and 4-pin power cable connector |

9. signal cable connector
 10. 30-pin signal cable connector
2. Remove the six screws on the system board and lift the system board away from the server sled.

NOTE: To prevent damage to the system board, ensure that you hold the system board by its edges only.

CAUTION:

Do not lift the system board assembly by holding a memory module, processor, or other components.

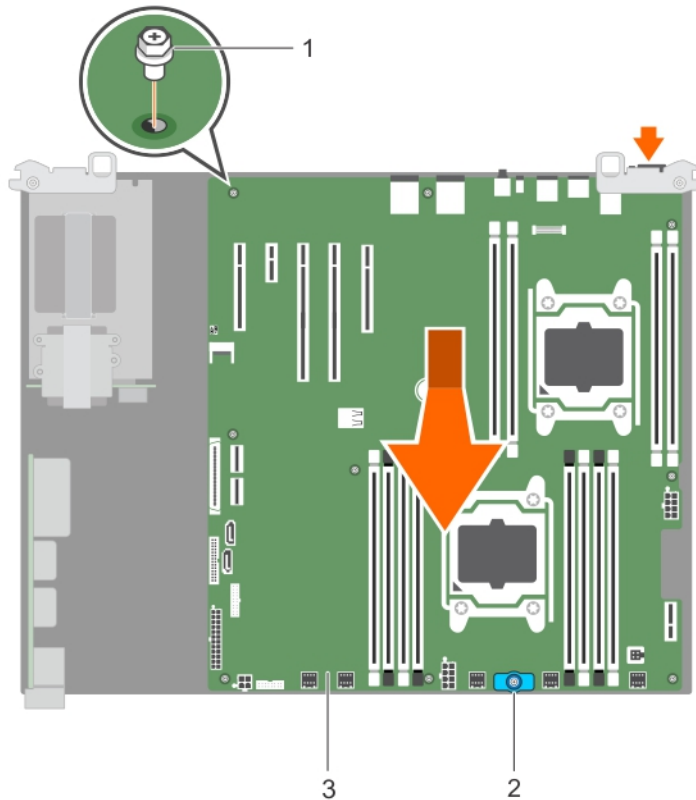

Figure 43. Removing and installing the system board.

1. screw (6)
2. board handle
3. system board

Related Links

- [Safety instructions](#)
- [Before working inside your system](#)

Installing the system board

Prerequisites



CAUTION: Many repairs may only be done by a certified service technician. You should only perform troubleshooting and simple repairs as authorized in your product documentation, or as directed by the online or telephone service and support team. Damage due to servicing that is not authorized by Dell is not covered by your warranty. Read and follow the safety instructions that came with the product.

1. Follow the safety guidelines listed in Safety instructions section.
2. Unpack the new system board assembly.

Steps

1. Hold the system board by its edges and lower the system board into the chassis.
2. Tighten the six screws that secure the system board to the server sled.

Next steps

1. Install the Trusted Platform Module (TPM).
2. Replace the following components:
 - a. cooling shroud
 - b. memory modules
 - c. sled cables
 - d. expansion cards
 - e. riser card
 - f. expansion-card riser module
 - g. heat sink and processor
3. Reconnect all cables to the system board.



NOTE: Ensure that the cables inside the system are routed along the chassis wall .

4. Follow the procedure listed in the After working inside your system section.
5. Ensure that you:
 - a. Use the Easy Restore feature to restore the service tag.
 - b. Update the BIOS and iDRAC versions.
 - c. Re-enable the Trusted Platform Module (TPM).

Related Links

[Safety instructions](#)

[After working inside your system](#)

Restoring the Service Tag by using the Easy Restore feature

The Easy Restore feature enables you to restore your system's Service Tag, license, UEFI configuration, and the system configuration data after replacing the system board. All data is automatically backed up in a backup flash device. If BIOS detects a new system board and the Service Tag in the backup flash device, BIOS prompts the user to restore the backup information.

1. Turn on the system.

If BIOS detects a new system board, and if the Service Tag is present in the backup flash device, BIOS displays the Service Tag, the status of the license, and the **UEFI Diagnostics** version.

2. Perform one of the following steps:

- Press **Y** to restore the Service Tag, license, and diagnostics information.
- Press **N** to navigate to the Dell Lifecycle Controller based restore options.
- Press F10 to restore data from a previously created **Hardware Server Profile**.

After the restore process is complete, BIOS prompts to restore the system configuration data.

3. Perform one of the following steps:

- Press **Y** to restore the system configuration data.
- Press **N** to use the default configuration settings.

After the restore process is complete, the system restarts.

Entering the system Service Tag by using System Setup

If Easy Restore fails to restore the Service Tag, use System Setup to enter the Service Tag.

1. Turn on the system.
2. Press F2 to enter System Setup.
3. Click **Service Tag Settings**.
4. Enter the Service Tag.



NOTE: You can enter the Service Tag only when the **Service Tag** field is empty. Ensure that you enter the correct Service Tag. After the Service Tag is entered, it cannot be updated or changed.

5. Click **Ok**.
6. Import your new or existing iDRAC Enterprise license.

For more information, see the *Integrated Dell Remote Access Controller User's Guide* at Dell.com/idracmanuals.

Trusted Platform Module

The Trusted Platform Module (TPM) is used to generate/store keys, protect/authenticate passwords, and create/store digital certificates. TPM can also be used to enable the BitLocker HDD encryption feature in Windows Server.



CAUTION: Do not attempt to remove the Trusted Platform Module (TPM) from the system board. Once the TPM is installed, it is cryptographically bound to that specific system board. Any attempt to remove an installed TPM breaks the cryptographic binding, and it cannot be re-installed or installed on another system board.

Installing the TPM

Prerequisites

1. Follow the safety guidelines listed in Safety instructions section.
2. Follow the procedure listed in the Before working inside your system section.



CAUTION: Do not remove an installed TPM. Any attempt to remove an installed TPM from the system board may damage the TPM.

Steps

1. Align the edge connectors on the TPM with the slot on the TPM connector.
2. Insert the TPM into the TPM connector such that the plastic bolt aligns with the slot on the system board.
3. Press the plastic bolt until the bolt snaps into place.

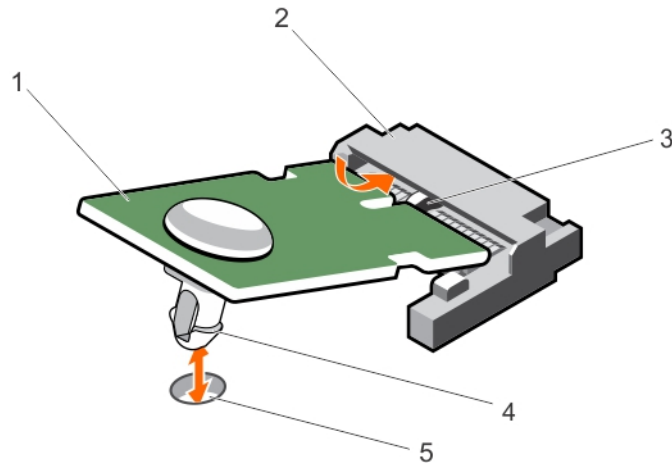

Figure 44. Installing the TPM

- | | |
|------------------------------|------------------|
| 1. TPM | 2. TPM connector |
| 3. slot on the TPM connector | 4. plastic bolt |
| 5. slot on the system board | |

Next steps

Follow the procedure listed in the After working inside your system section.

Related Links

[Safety instructions](#)

[Before working inside your system](#)

[After working inside your system](#)

Re-enabling the TPM for BitLocker users

Initialize the TPM.

For more information about initializing the TPM, see <http://technet.microsoft.com/en-us/library/cc753140.aspx>.

The **TPM Status** changes to **Enabled, Activated**.

Re-enabling the TPM for TXT users

1. While booting your system, press **F2** to enter System Setup.
2. In the **System Setup Main Menu**, click **System BIOS** → **System Security Settings**.
3. In the **TPM Security** option, select **On with Pre-boot Measurements**.
4. In the **TPM Command** option, select **Activate**.
5. Save the settings.
6. Restart your system.
7. Enter System Setup again.
8. In the **System Setup Main Menu**, click **System BIOS** → **System Security Settings**.
9. In the **Intel TXT** option, select **On**.

Using system diagnostics

If you experience a problem with your system, run the system diagnostics before contacting Dell for technical assistance. The purpose of running system diagnostics is to test your system hardware without requiring additional equipment or risking data loss. If you are unable to fix the problem yourself, service and support personnel can use the diagnostics results to help you solve the problem.

Dell Embedded System Diagnostics

 **NOTE:** The Dell Embedded System Diagnostics is also known as Enhanced Pre-boot System Assessment (ePSA) diagnostics.

The Embedded System Diagnostics provides a set of options for particular device groups or devices allowing you to:

- Run tests automatically or in an interactive mode
- Repeat tests
- Display or save test results
- Run thorough tests to introduce additional test options to provide extra information about the failed device(s)
- View status messages that inform you if tests are completed successfully
- View error messages that inform you of problems encountered during testing

When to use the Embedded System Diagnostics

If a major component or device in the system does not operate properly, running the embedded system diagnostics may indicate component failure.

Running the Embedded System Diagnostics from Boot Manager

Prerequisites

Run the Embedded System Diagnostics (ePSA) if your system does not boot.

Steps

1. When the system is booting, press F11.
2. Use the up arrow and down arrow keys to select **System Utilities** → **Launch Diagnostics**.
The **ePSA Pre-boot System Assessment** window is displayed, listing all devices detected in the system. The diagnostics starts executing the tests on all the detected devices.

Running the Embedded System Diagnostics from the Dell Lifecycle Controller

1. As the system boots, press F11.
2. Select **Hardware Diagnostics** → **Run Hardware Diagnostics**.

The **ePSA Pre-boot System Assessment** window is displayed, listing all devices detected in the system. The diagnostics starts executing the tests on all the detected devices.

System diagnostic controls

Menu	Description
Configuration	Displays the configuration and status information of all detected devices.
Results	Displays the results of all tests that are run.
System health	Provides the current overview of the system performance.
Event log	Displays a time-stamped log of the results of all tests run on the system. This is displayed if at least one event description is recorded.

For information about embedded system diagnostics, see the *ePSA Diagnostics Guide (Notebooks, Desktops and Servers)* available at Dell.com/support/home.





Jumpers and connectors

This topic provides specific information about the system jumpers. It also provides some basic information about jumpers and switches and describes the connectors on the various boards in the system. Jumpers on the system board help to disable system and setup passwords. You must know the connectors on the system board to install components and cables correctly.

System board jumper settings

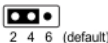
For information about resetting the password jumper to disable a password, see [Disabling a Forgotten Password](#).

Table 26. System board jumper settings

Jumper	Setting	Description
PWRD_EN	 (default)	The password reset feature is enabled (pins 2–4).
		The password reset feature is disabled (pins 4–6). The iDRAC local access is unlocked at the next AC power cycle.
NVRAM_CLR	 (default)	The configuration settings are retained at the next system boot (pins 3–5).
		The configuration settings are cleared at system boot (pins 1–3).

System board connectors

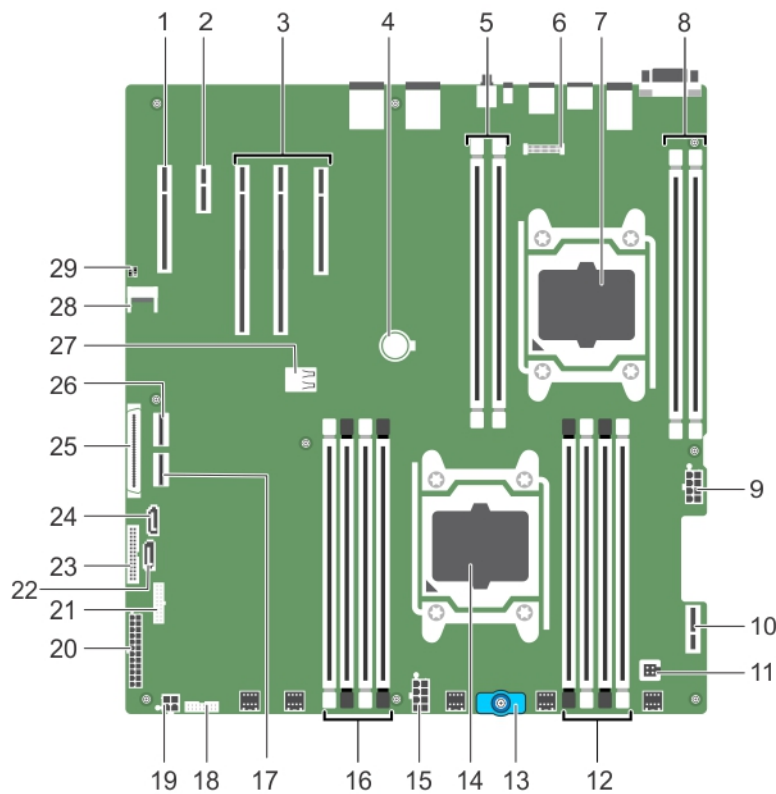



Figure 45. System board connectors and jumpers

Table 27. System board connectors and jumpers

Item	Connector	Description
1	SLOT3 PCIE_G3_X16(CPU1) (2)	Expansion-card riser connector (2)
		 NOTE: The PCIE_G3_X8 and PCIE_G3_X16 are the two different types of risers supported on DSS 7500 systems. You can install a riser card on the system board only using expansion-card riser module. Form more information about the installation guidelines, see Expansion card installation guidelines.
2	SLOT1 PCIE_G3_X8(CPU2)	Expansion-card riser connector
3	PCIe Card Slot	PCIe card connector 3, PCIe card connector 2, and PCIe card connector 1.
4	BATTERY	Battery connector
5	B1, B2	Memory module socket

Item	Connector	Description
7	CPU2	Processor socket 2
8	B3, B4	Memory module socket
9	PWR_CONN_C(P3)	8-pin power connector
11	INTRUSION	Intrusion switch connector
12	A1, A5, A2, A6	Memory module socket
13	Board Handle	Used to assist pull out the system board for replacement/service
14	CPU1	Processor socket 1
15	PWR_CONN_B(P2)	8-pin power connector
16	A3, A7, A4, A8	Memory module socket
17	SW_RAID_B	Software RAID connector B (reserved)
18	BP_SIG	Backplane signal connector (reserved)
19	BP3	Hard drive backplane power connector
20	SYS_PWR_CONN (P1)	24-pin power connector
21	FP_USB	Front-panel USB connector (reserved)
22	SATA_HDD	SATA boot drive B
23	PIB_CONN	Hot/cool-interposer board connector
24	SATA_HDD	SATA boot drive A
25	CTRL_PNL	Control panel interface connector (reserved)
26	SW_RAID_A	Software RAID connector A
27	INT_USB_3.0	Internal USB connector
28	TPM_MODULE	Trusted platform module connector
29	J_PSWD_NVRAM	For more information, see System board jumper settings.

Disabling a forgotten password

The software security features of the system include a system password and a setup password. The password jumper enables these password features or disables them and clears any password(s) currently in use.

Prerequisites

 **CAUTION:** Many repairs may only be done by a certified service technician. You should only perform troubleshooting and simple repairs as authorized in your product documentation, or as directed by the online or telephone service and support team. Damage due to servicing that is not authorized by Dell is not covered by your warranty. Read and follow the safety instructions that are shipped with your product.

Steps

1. Turn off the system, including any attached peripherals, and disconnect the system from the electrical outlet.
2. Remove the system cover.
3. Move the jumper on the system board jumper from pins 4 and 6 to pins 2 and 4.
4. Install the system cover.

The existing passwords are not disabled (erased) until the system boots with the jumper on pins 2 and 4. However, before you assign a new system and/or setup password, you must move the jumper back to pins 4 and 6.





NOTE: If you assign a new system and/or setup password with the jumper on pins 2 and 4, the system disables the new password(s) the next time it boots.

5. Reconnect the system to its electrical outlet and turn the system on, including any attached peripherals.
6. Turn off the system, including any attached peripherals, and disconnect the system from the electrical outlet.
7. Remove the system cover.
8. Move the jumper on the system board jumper from pins 2 and 4 to pins 4 and 6.
9. Install the system cover.
10. Reconnect the system to its electrical outlet and turn the system on, including any attached peripherals.
11. Assign a new system and/or setup password.

Troubleshooting your system

Safety first — for you and your system

 **CAUTION:** Many repairs may only be done by a certified service technician. You should only perform troubleshooting and simple repairs as authorized in your product documentation, or as directed by the online or telephone service and support team. Damage due to servicing that is not authorized by Dell is not covered by your warranty. Read and follow the safety instructions that are shipped with your product.

 **NOTE:** Solution validation was performed by using the factory shipped hardware configuration.

Troubleshooting system startup failure

If you boot the system to the BIOS boot mode after installing an operating system from the UEFI Boot Manager, the system stops responding. To avoid this issue, you must boot to the same boot mode in which you installed the operating system.

For all other startup issues, note the system messages that appear on the screen.

Troubleshooting external connections

Before troubleshooting any external devices, ensure that all external cables are securely attached to the external connectors on your system before troubleshooting any external devices.

Troubleshooting the video subsystem

Prerequisites

 **NOTE:** Ensure the **Local Server Video Enabled** option is selected in the iDRAC Graphical User Interface (GUI), under **Virtual Console**. If this option is not selected, local video is disabled.

Steps

1. Check the cable connections (power and display) to the monitor.
2. Check the video interface cabling from the system to the monitor.
3. Run the appropriate diagnostic test.

If the tests run successfully, the problem is not related to video hardware.

Next steps

If the tests fail, see the Getting help section.

Related Links

[Getting help](#)

Troubleshooting a USB device

Prerequisites

 **NOTE:** Follow steps 1 to 6 to troubleshoot a USB keyboard or mouse. For other USB devices, go to step 7.

Steps

1. Disconnect the keyboard and/or mouse cables from the system and reconnect them.
2. If the problem persists, connect the keyboard and/or mouse to another USB port on the system.
3. If the problem is resolved, restart the system, enter System Setup, and check if the non-functioning USB ports are enabled.

 **NOTE:** Older operating systems may not support USB 3.0.

4. Check if USB 3.0 is enabled in System Setup. If enabled, disable it and see if the issue is resolved.
5. In **iDRAC Settings Utility**, ensure that **USB Management Port Mode** is configured as **Automatic** or **Standard OS Use**.
6. If the problem is not resolved, replace the keyboard and/or mouse with a known working keyboard or mouse.
If the problem is not resolved, proceed to step 7 to troubleshoot other USB devices attached to the system.
7. Turn off all attached USB devices, and disconnect them from the system.
8. Restart the system.
9. If your keyboard is functioning, enter System Setup, verify that all USB ports are enabled on the **Integrated Devices** screen. If your keyboard is not functioning, use remote access to enable or disable the USB options.
10. Check if USB 3.0 is enabled in System Setup. If it is enabled, disable it and restart your system.
11. If the system is not accessible, reset the NVRAM_CLR jumper inside your system and restore the BIOS to the default settings. See the System board jumper setting section
12. In the **iDRAC Settings Utility**, ensure that **USB Management Port Mode** is configured as **Automatic** or **Standard OS Use**.
13. Reconnect and turn on each USB device one at a time.
14. If a USB device causes the same problem, turn off the device, replace the USB cable with a known good cable, and turn on the device.

Next steps

If all troubleshooting fails, see the Getting help section.

Related Links

[Getting help](#)

Troubleshooting iDRAC Direct (USB XML configuration)

For information about USB storage device and server configuration, see the Integrated Dell Remote Access Controller User's Guide at Dell.com/idracmanuals.

Steps

1. Ensure that your USB storage device is connected to the front USB Management Port, identified by  icon.
2. Ensure that your USB storage device is configured with an NTFS or an FAT32 file system with only one partition.
3. Verify that the USB storage device is configured correctly. For more information about configuring the USB storage device, see the Integrated Dell Remote Access Controller User's Guide at Dell.com/idracmanuals.
4. In the **iDRAC Settings Utility**, ensure that **USB Management Port Mode** is configured as **Automatic** or **iDRAC Direct Only**.
5. Ensure that the **iDRAC Managed: USB XML Configuration** option is either **Enabled** or **Enabled only when the server has default credential settings**.
6. Remove and reinsert the USB storage device.
7. If import operation does not work, try with a different USB storage device.

Next steps

If all troubleshooting fails, see the Getting help section.

Related Links

[Getting help](#)

Troubleshooting iDRAC Direct (Laptop connection)

For information about USB laptop connection and server configuration, see the *Integrated Dell Remote Access Controller User's Guide* at Dell.com/idracmanuals.

Steps

1. Ensure that your laptop is connected to the front USB Management Port, identified by  icon with a USB Type A/A cable.
2. On the **iDRAC Settings Utility** screen, ensure that **USB Management Port Mode** is configured as **Automatic** or **iDRAC Direct Only**.
3. If the laptop is running Windows operating system, ensure that the iDRAC Virtual USB NIC device driver is installed.
4. If the driver is installed, ensure that you are not connected to any network through WiFi or cabled ethernet, as iDRAC Direct uses a non-routable address.

Next steps

If all troubleshooting fails, see the Getting help section.

Related Links

[Getting help](#)

Troubleshooting a serial I/O device

Steps

1. Turn off the system and any peripheral devices connected to the serial port.
2. Swap the serial interface cable with a known working cable, and turn on the system and the serial device.
If the problem is resolved, replace the interface cable with a known working cable.
3. Turn off the system and the serial device, and swap the serial device with a compatible device.
4. Turn on the system and the serial device.

Next steps

If the problem persists, see the Getting help section.

Related Links

[Getting help](#)

Troubleshooting a NIC

Steps

1. Run the appropriate diagnostic test. For more information, see the Using system diagnostics section for the available diagnostic tests.
2. Restart the system and check for any system messages pertaining to the NIC controller.
3. Check the appropriate indicator on the NIC connector:
 - If the link indicator does not glow, the cable connected might be disengaged.
 - If the activity indicator does not glow, the network driver files might be damaged or missing. Install or replace the drivers as necessary. For more information, see the NIC documentation.
 - If the problem persists, use another connector on the switch or hub.
4. Ensure that the appropriate drivers are installed and the protocols are bound. For more information, see the NIC documentation.
5. Enter System Setup and confirm that the NIC ports are enabled on the **Integrated Devices** screen.
6. Ensure that all the NICs, hubs, and switches on the network are set to the same data transmission speed and duplex. For more information, see the documentation for each network device.
7. Ensure that all network cables are of the proper type and do not exceed the maximum length.

Next steps

If the problem persists, see the Getting help section.

Related Links

[Using system diagnostics](#)

[Getting help](#)

Troubleshooting a wet system

Prerequisites

 **CAUTION:** Many repairs may only be done by a certified service technician. You should only perform troubleshooting and simple repairs as authorized in your product documentation, or as directed by the online or telephone service and support team. Damage due to servicing that is not authorized by Dell is not covered by your warranty. Read and follow the safety instructions that are shipped with your product.

Steps

1. Turn off the system and attached peripherals, and disconnect the system from the electrical outlet.
2. Remove the system cover.
3. Remove the following components (if installed) from the system:
 - power supply unit(s)
 - optical drive
 - hard drives
 - hard drive backplane
 - USB memory key
 - hard drive tray
 - cooling shroud
 - expansion card risers (if installed)
 - expansion cards
 - cooling fan assembly (if installed)
 - cooling fans
 - memory modules
 - processor(s) and heat sink(s)
 - system board
4. Let the system dry thoroughly for at least 24 hours.
5. Reinstall the components you removed in step 3 except the expansion cards.
6. Install the system cover.
7. Turn on the system and attached peripherals.
If the problem persists, see the Getting help section.
8. If the system starts properly, shut down the system, and reinstall all the expansion cards that you removed.
9. Run the appropriate diagnostic test. For more information, see the Using system diagnostics section.

Next steps

If the tests fail, see the Getting help section.

Related Links

[Getting help](#)

[Using system diagnostics](#)

Troubleshooting a damaged system

Prerequisites



CAUTION: Many repairs may only be done by a certified service technician. You should only perform troubleshooting and simple repairs as authorized in your product documentation, or as directed by the online or telephone service and support team. Damage due to servicing that is not authorized by Dell is not covered by your warranty. Read and follow the safety instructions that are shipped with your product.

Steps

1. Turn off the system and attached peripherals, and disconnect the system from the electrical outlet.
2. Remove the system cover.
3. Ensure that the following components are properly installed:
 - cooling shroud
 - expansion card risers (if installed)
 - expansion cards
 - power supply unit(s)
 - cooling fan assembly (if installed)
 - cooling fans
 - processor(s) and heat sink(s)
 - memory modules
 - hard drive carriers/cage
 - hard drive backplane
4. Ensure that all cables are properly connected.
5. Install the system cover.
6. Run the appropriate diagnostic test. For more information, see the Using system diagnostics section.

Next steps

If the problem persists, see the Getting help section.

Related Links

[Using system diagnostics](#)

[Getting help](#)

Troubleshooting server sleds

If you encounter an issue when turning on a server sled, ensure that its related PSUs are installed properly.

When you are facing the back panel, from left to right: PSUs 1 and 2 are for sled B (upper sled); PSUs 3 and 4 are for sled A (lower sled).



NOTE: Features of sled B are for dual-node systems only.

If the issue persists, see Getting help.

System messages

For a list of event and error messages generated by the system firmware and agents that monitor system components, see the Dell Event and Error Messages Reference Guide at Dell.com/idracmanuals.

Warning messages

A warning message alerts you to a possible issue and prompts you to respond before the system continues a task. For example, before you format an HDD, a message warns you that you may lose all data on the HDD. Warning messages usually interrupt the task and require you to respond by typing y (yes) or n (no).

 **NOTE:** Warning messages are generated by either the application or the operating system. For more information, see the documentation that accompanied the operating system or application.

Diagnostic messages

The system diagnostic utilities may issue messages if you run diagnostic tests on your system. See Using system diagnostics for more information about system diagnostics.

Troubleshooting the system battery

Prerequisites

 **CAUTION:** Many repairs may only be done by a certified service technician. You should only perform troubleshooting and simple repairs as authorized in your product documentation, or as directed by the online or telephone service and support team. Damage due to servicing that is not authorized by Dell is not covered by your warranty. Read and follow the safety instructions that are shipped with your product.

 **NOTE:** If the system is turned off for long periods of time (for weeks or months), the NVRAM may lose its system configuration information. This situation is caused by a defective battery.

 **NOTE:** Some software may cause the system time to speed up or slow down. If the system seems to operate normally except for the time set in System Setup, the problem may be caused by a software, rather than by a defective battery.

Steps

1. Re-enter the time and date in System Setup.
2. Turn off the system, and disconnect it from the electrical outlet for at least an hour.
3. Reconnect the system to the electrical outlet, and turn on the system.
4. Enter System Setup.

If the date and time displayed in System Setup are not correct, check the System Error Log (SEL) for system battery messages.

Next steps

If the problem persists, see the Getting help section.

Related Links

[Getting help](#)

Troubleshooting power supply units

 **CAUTION:** Many repairs may only be done by a certified service technician. You should only perform troubleshooting and simple repairs as authorized in your product documentation, or as directed by the online or telephone service and support team. Damage due to servicing that is not authorized by Dell is not covered by your warranty. Read and follow the safety instructions that are shipped with your product.

Troubleshooting power source problems

1. Press the power button to ensure that your system is turned on. If the power indicator does not glow when the power button is pressed, press the power button firmly.
2. Plug in another working power supply unit to ensure that the system board is not faulty.
3. Ensure that no loose connections exist.
For example, loose power cables.
4. Ensure that the power source meets applicable standards.
5. Ensure that there are no short circuits.
6. Have a qualified electrician check the line voltage to ensure that it meets the needed specifications.

Power supply unit problems

1. Ensure that no loose connections exist.
For example, loose power cables.
2. Ensure that the power supply handle or LED indicates that the power supply is working properly.
For more information about power supply indicators, see the Power indicator codes section.
3. If you have recently upgraded your system, ensure that the power supply unit (PSU) has enough power to support the new system.
4. If you have a redundant power supply configuration, ensure that both the PSUs are of the same type and wattage.
You may have to upgrade to a higher wattage PSU.
5. Ensure that you use only PSUs with the Extended Power Performance (EPP) label on the back.
6. Reseat the PSU.

 **NOTE:** After installing a PSU, allow several seconds for the system to recognize the PSU and determine if it is working properly.

If the problem persists, see the Getting help section.

Troubleshooting cooling problems

 **CAUTION:** Many repairs may only be done by a certified service technician. You should only perform troubleshooting and simple repairs as authorized in your product documentation, or as directed by the online or telephone service and support team. Damage due to servicing that is not authorized by Dell is not covered by your warranty. Read and follow the safety instructions that are shipped with your product.

Ensure that the following conditions exist:

- System cover, cooling shroud, EMI filler panel, memory module blank, or back filler bracket is not removed.
- Ambient temperature is not higher than the system specific ambient temperature.
- External airflow is not obstructed.
- A cooling fan is not removed or has not failed.
- The expansion card installation guidelines have been followed.

Additional cooling can be added by one of the following methods:

From the iDRAC web GUI:

1. Click **Hardware** → **Fans** → **Setup**.
2. From the **Fan Speed Offset** drop-down list, select the cooling level required or set the minimum fan speed to a custom value.

From F2 System Setup:

1. Select **iDRAC Settings** → **Thermal**, and set a higher fan speed from the fan speed offset or minimum fan speed.

From RACADM commands:

1. Run the command `racadm help system.thermalsettings`

For more information, see the Integrated Dell Remote Access User's Guide at Dell.com/idracmanuals.

Troubleshooting cooling fans

Prerequisites

 **CAUTION:** Many repairs may only be done by a certified service technician. You should only perform troubleshooting and simple repairs as authorized in your product documentation, or as directed by the online or telephone service and support team. Damage due to servicing that is not authorized by Dell is not covered by your warranty. Read and follow the safety instructions that are shipped with your product.

 **NOTE:** The fan number is referenced by the systems management software. In the event of a problem with a particular fan, you can easily identify and replace it by noting down the fan numbers on the cooling fan assembly.

1. Follow the safety guidelines listed in safety instructions section.
2. Follow the procedure listed in the Before working inside your system section.

Steps

1. Remove the system cover.
2. Reseat the fan or the fan's power cable.
3. Install the system cover.
4. Restart the system.

Next steps

If the problem persists, see the Getting help section.

Related Links

[Getting help](#)

Troubleshooting system memory

Prerequisites



CAUTION: Many repairs may only be done by a certified service technician. You should only perform troubleshooting and simple repairs as authorized in your product documentation, or as directed by the online or telephone service and support team. Damage due to servicing that is not authorized by Dell is not covered by your warranty. Read and follow the safety instructions that are shipped with your product.

Steps

1. If the system is operational, run the appropriate system diagnostic test. See the Using system diagnostics section for the available diagnostic tests.
If the diagnostic tests indicate a fault, follow the corrective actions provided by the diagnostic tests.
2. If the system is not operational, turn off the system and attached peripherals, and unplug the system from the power source. Wait at least for 10 seconds, and then reconnect the system to the power source.
3. Turn on the system and attached peripherals, and note the messages on the screen.
If an error message is displayed indicating a fault with a specific memory module, go to step 12.
4. Enter System Setup, and check the system memory setting. Make any changes to the memory settings, if needed.
If the memory settings match the installed memory but the problem still persists, go to step 12.
5. Turn off the system and attached peripherals, and disconnect the system from the electrical outlet.
6. Remove the system cover.
7. Check the memory channels and ensure that they are populated correctly.
 **NOTE:** See the system event log or system messages for the location of the failed memory module. Reinstall the memory device.
8. Reseat the memory modules in their sockets.
9. Install the system cover.
10. Enter System Setup and check the system memory setting.
If the problem is not resolved, proceed with step 11.
11. Remove the system cover.
12. If a diagnostic test or error message indicates a specific memory module as faulty, swap or replace the module with a known working memory module.
13. To troubleshoot an unspecified faulty memory module, replace the memory module in the first DIMM socket with a module of the same type and capacity.
If an error message is displayed on the screen, this may indicate a problem with the installed DIMM type(s), incorrect DIMM installation, or defective DIMM(s). Follow the on-screen instructions to resolve the problem.
14. Install the system cover.
15. As the system boots, observe any error message that is displayed and the diagnostic indicators on the front of the system.
16. If the memory problem persists, repeat step 12 through step 15 for each memory module installed.

Next steps

If the problem persists, see the Getting help section.

Related Links

[Getting help](#)

[Using system diagnostics](#)

Troubleshooting an internal USB key

Prerequisites

 **CAUTION:** Many repairs may only be done by a certified service technician. You should only perform troubleshooting and simple repairs as authorized in your product documentation, or as directed by the online or telephone service and support team. Damage due to servicing that is not authorized by Dell is not covered by your warranty. Read and follow the safety instructions that are shipped with your product.

Steps

1. Enter System Setup and ensure that the **USB key port** is enabled on the **Integrated Devices** screen.
2. Turn off the system and attached peripherals, and disconnect the system from the electrical outlet.
3. Remove the system cover.
4. Locate the USB key and reseal it.
5. Install the system cover.
6. Turn on the system and attached peripherals, and check if the USB key is functioning.
7. If the problem is not resolved, repeat step 2 and step 3.
8. Insert a known working USB key.
9. Install the system cover.

Next steps

If the problem persists, see the Getting help section.

Related Links

[Getting help](#)

Troubleshooting an SD card

Prerequisites

 **CAUTION:** Many repairs may only be done by a certified service technician. You should only perform troubleshooting and simple repairs as authorized in your product documentation, or as directed by the online or telephone service and support team. Damage due to servicing that is not authorized by Dell is not covered by your warranty. Read and follow the safety instructions that are shipped with your product.

 **NOTE:** Certain SD cards have a physical write-protect switch on the card. If the write-protect switch is turned on, the SD card is not writable.

Steps

1. Enter System Setup, and ensure that the **Internal SD Card Port** is enabled.
2. Turn off the system, including any attached peripherals, and disconnect the system from the electrical outlet.
3. Remove the system cover.

 **NOTE:** When an SD card failure occurs, the internal dual SD module controller notifies the system. On the next restart, the system displays a message indicating the failure. If redundancy is enabled at the time of SD card failure, a critical alert will be logged and chassis health will degrade.

4. Replace the failed SD card with a new SD card.
5. Install the system cover.
6. Reconnect the system to its electrical outlet and turn on the system, including any attached peripherals.
7. Enter System Setup, and ensure that the **Internal SD Card Port** and **Internal SD Card Redundancy** modes are set to the needed modes.
Verify that the correct SD slot is set as **Primary SD Card**.
8. Check if the SD card is functioning properly.
9. If the **Internal SD Card Redundancy** option is set to **Enabled** at the time of the SD card failure, the system prompts you to perform a rebuild.

 **NOTE:** The rebuild is always sourced from the primary SD card to the secondary SD card.

Troubleshooting an optical drive

Prerequisites

 **CAUTION:** Many repairs may only be done by a certified service technician. You should only perform troubleshooting and simple repairs as authorized in your product documentation, or as directed by the online or telephone service and support team. Damage due to servicing that is not authorized by Dell is not covered by your warranty. Read and follow the safety instructions that are shipped with your product.

Steps

1. Try using a different CD or DVD.
2. If the problem is not resolved, enter System Setup and ensure that the integrated SATA controller and the drive's SATA port are enabled.
3. Run the appropriate diagnostic test.
4. Turn off the system and attached peripherals, and disconnect the system from the electrical outlet.
5. If installed, remove the bezel.
6. Remove the system cover.
7. Ensure that the interface cable is securely connected to the optical drive and to the controller.
8. Ensure that a power cable is properly connected to the drive.
9. Install the system cover.

Next steps



If the problem persists, see the Getting help section.

Related Links

[Getting help](#)

Troubleshooting a hard drive

Prerequisites

-  **CAUTION:** This troubleshooting procedure can erase data stored on the hard drive. Before you proceed, back up all files on the hard drive.
-  **CAUTION:** Many repairs may only be done by a certified service technician. You should only perform troubleshooting and simple repairs as authorized in your product documentation, or as directed by the online or telephone service and support team. Damage due to servicing that is not authorized by Dell is not covered by your warranty. Read and follow the safety instructions that are shipped with your product.

Steps

1. Run the appropriate diagnostic test. See the Using system diagnostics section.
Depending on the results of the diagnostics test, proceed as needed through the following steps.
2. If your system has a RAID controller and your hard drives are configured in a RAID array, perform the following steps:
 - a. Restart the system and press F10 during system startup to run the Dell Lifecycle Controller, and then run the Hardware Configuration wizard to check the RAID configuration.
See the Dell Lifecycle Controller documentation or online help for information about RAID configuration.
 - b. Ensure that the hard drives are configured correctly for the RAID array.
 - c. Take the hard drive offline and reseal the drive.
 - d. Exit the configuration utility and allow the system to boot to the operating system.
3. Ensure that the needed device drivers for your controller card are installed and are configured correctly. See the operating system documentation for more information.
4. Restart the system and enter the System Setup.
5. Verify that the controller is enabled and the drives are displayed in the System Setup.

Next steps

If the problem persists, see the Getting help section.

Related Links

[Getting help](#)

Troubleshooting a storage controller

-  **CAUTION:** Many repairs may only be done by a certified service technician. You should only perform troubleshooting and simple repairs as authorized in your product documentation, or as directed by the online or telephone service and support team. Damage due to servicing that is not authorized by Dell is not covered by your warranty. Read and follow the safety instructions that are shipped with your product.

 **NOTE:** When troubleshooting a SAS or PERC controller, see the documentation for your operating system and the controller.

1. Run the appropriate diagnostic test. See the Using system diagnostics section.
2. Turn off the system and attached peripherals, and disconnect the system from the electrical outlet.
3. Remove the system cover.

4. Verify that the installed expansion cards are compliant with the expansion card installation guidelines.
5. Ensure that each expansion card is firmly seated in its connector.
6. Install the system cover.
7. Reconnect the system to the electrical outlet, and turn on the system and attached peripherals.
8. If the problem is not resolved, turn off the system and attached peripherals, and disconnect the system from the electrical outlet.
9. Remove the system cover.
10. Remove all expansion cards installed in the system.
11. Install the system cover.
12. Reconnect the system to the electrical outlet, and turn on the system and attached peripherals.
13. Run the appropriate diagnostic test. See the Using system diagnostics section. If the tests fail, see the Getting help section.
14. For each expansion card you removed in step 10, perform the following steps:
 - a. Turn off the system and attached peripherals, and disconnect the system from the electrical outlet.
 - b. Remove the system cover.
 - c. Reinstall one of the expansion cards.
 - d. Install the system cover.
 - e. Run the appropriate diagnostic test. See the Using system diagnostics section.

If the problem persists, see the Getting help section.

Related Links

[Getting help](#)

Troubleshooting expansion cards

Prerequisites



CAUTION: Many repairs may only be done by a certified service technician. You should only perform troubleshooting and simple repairs as authorized in your product documentation, or as directed by the online or telephone service and support team. Damage due to servicing that is not authorized by Dell is not covered by your warranty. Read and follow the safety instructions that are shipped with your product.



NOTE: When troubleshooting an expansion card, you also have to see the documentation for your operating system and the expansion card.

Steps

1. Run the appropriate diagnostic test. See the Using system diagnostics section.
2. Turn off the system and attached peripherals, and disconnect the system from the electrical outlet.
3. Remove the system cover.
4. Ensure that each expansion card is firmly seated in its connector.
5. Install the system cover.
6. Turn on the system and attached peripherals.
7. If the problem is not resolved, turn off the system and attached peripherals, and disconnect the system from the electrical outlet.
8. Remove the system cover.

9. Remove all expansion cards installed in the system.
10. Install the system cover.
11. Run the appropriate diagnostic test. See the Using system diagnostics section.
If the tests fail, see the Getting help section.
12. For each expansion card you removed in step 8, perform the following steps:
 - a. Turn off the system and attached peripherals, and disconnect the system from the electrical outlet.
 - b. Remove the system cover.
 - c. Reinstall one of the expansion cards.
 - d. Install the system cover.
 - e. Run the appropriate diagnostic test. See the Using system diagnostics section.

Next steps

If the problem persists, see the Getting help section.

Related Links

[Getting help](#)

Troubleshooting processors

Prerequisites



CAUTION: Many repairs may only be done by a certified service technician. You should only perform troubleshooting and simple repairs as authorized in your product documentation, or as directed by the online or telephone service and support team. Damage due to servicing that is not authorized by Dell is not covered by your warranty. Read and follow the safety instructions that are shipped with your product.

Steps

1. Run the appropriate diagnostics test. See the Using system diagnostics section.
2. Turn off the system and attached peripherals, and disconnect the system from the electrical outlet.
3. Remove the system cover.
4. Ensure that the processor and heat sink are properly installed.
5. Install the system cover.
6. Run the appropriate diagnostic test. See the Using system diagnostics section.
7. If the problem persists, see the Getting help section.

Related Links

[Getting help](#)

Getting help

Contacting Dell

Dell provides several online and telephone-based support and service options. If you do not have an active internet connection, you can find contact information on your purchase invoice, packing slip, bill, or Dell product catalog. Availability varies by country and product, and some services may not be available in your area. To contact Dell for sales, technical assistance, or customer-service issues:

1. Go to **Dell.com/support**.
2. Select your country from the drop-down menu on the bottom right corner of the page.
3. For customized support:
 - a. Enter your system Service Tag in the **Enter your Service Tag** field.
 - b. Click **Submit**.
The support page that lists the various support categories is displayed.
4. For general support:
 - a. Select your product category.
 - b. Select your product segment.
 - c. Select your product.
The support page that lists the various support categories is displayed.
5. For contact details of Dell Global Technical Support:
 - a. Click [Global Technical Support](#).
 - b. The **Technical Support** page is displayed with details to call, chat, or e-mail the Dell Global Technical Support team.

Locating Service Tag of your system

Your system is identified by a unique Express Service Code and Service Tag number. The Express Service Code and Service Tag are found on the front of the system by pulling out the information tag. Alternatively, the information may be on a sticker on the chassis of the system. This information is used by Dell to route support calls to the appropriate personnel.

Documentation feedback

You can rate the documentation or write your feedback on any of our Dell documentation pages and click **Send Feedback** to send your feedback.

Quick resource locator

Use the Quick Resource Locator (QRL) to get immediate access to system information and how-to videos. This can be done by visiting Dell.com/QRL. To try out the QR code, scan the following image by using your smartphone or tablet.



Free Manuals Download Website

<http://myh66.com>

<http://usermanuals.us>

<http://www.somanuals.com>

<http://www.4manuals.cc>

<http://www.manual-lib.com>

<http://www.404manual.com>

<http://www.luxmanual.com>

<http://aubethermostatmanual.com>

Golf course search by state

<http://golfingnear.com>

Email search by domain

<http://emailbydomain.com>

Auto manuals search

<http://auto.somanuals.com>

TV manuals search

<http://tv.somanuals.com>