

See the **extended user guide** – for more information about using your frame, visit www.kodak.com/go/digitalframesupport. See the frame package for package contents.

Front View

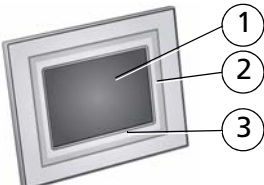

Kodak EasyShare P520 digital frame

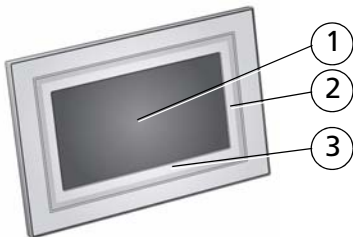

Kodak EasyShare P720/P725/P820 digital frames

- 1 LCD screen
- 2 Quick Touch Border (right side, tap only)
- 3 Quick Touch Border (bottom, tap/slide)

To use the Quick Touch Borders,
see page 5.

Back/Side View

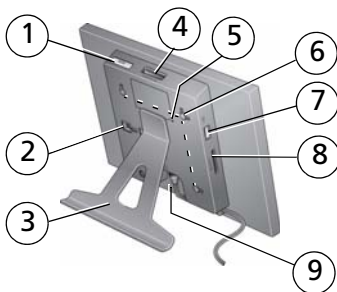

P520/P720/P725 digital frames

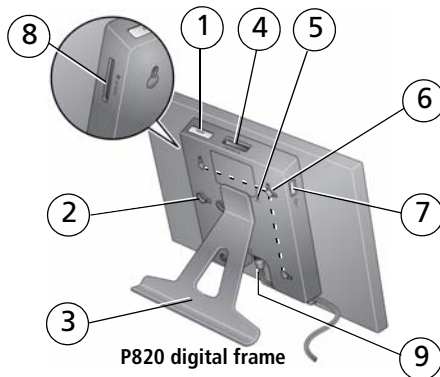

P820 digital frame

- 1 On/Off button
- 2 Stand attachment slot
- 3 Frame stand (see [page 3](#))
- 4 Memory card slot - SD, MS, xD, MMC
- 5 Reset button
- 6 Wall mounting holes, 3 (see [page 10](#))
- 7 USB connector (to camera/USB device)
- 8 Memory card slot - SD/SDHC
- 9 Power connector



1

Getting started

Setting up your picture frame

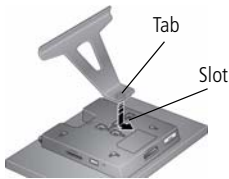
Attaching the frame stand



- Make sure the tab on the stand is secure in the slot on the back of the frame.
- Your frame displays pictures in landscape  orientation. To change to portrait , see [page 9](#).

Attaching the power cable



CAUTION:

Do not use this power cable with other devices, including digital cameras.

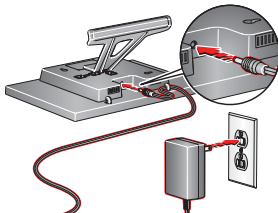

Your power cable may look different from the one pictured. Use the plug that accommodates your type of power outlet.

Turning on your frame

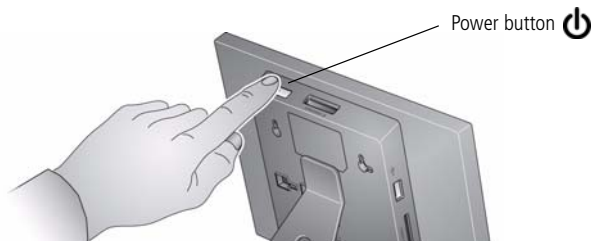

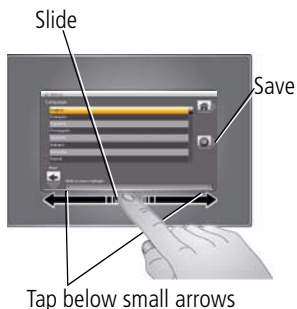

Setting your language

The language screen appears the first time you turn on your frame.



- Slide, or tap below small arrows, to highlight your language, then tap Save.

To change the language at a later time:

- Tap  (Home) →  (Settings), then highlight Language.

The language screen appears.

Highlight your language, then tap Save.

To use the Quick Touch Borders, see [page 5](#).

Using your frame's Quick Touch Borders

Touch tips

Tap and slide on the Quick Touch Borders* only.

- **Tap** a border to display the icons. Tap  (Close) to dismiss them.
- **Tap** next to or below a button to select it.
- **Slide** to highlight menus, pictures, videos, options. ** Tap OK to select them.
- **Don't hover**, borders can be sensitive.

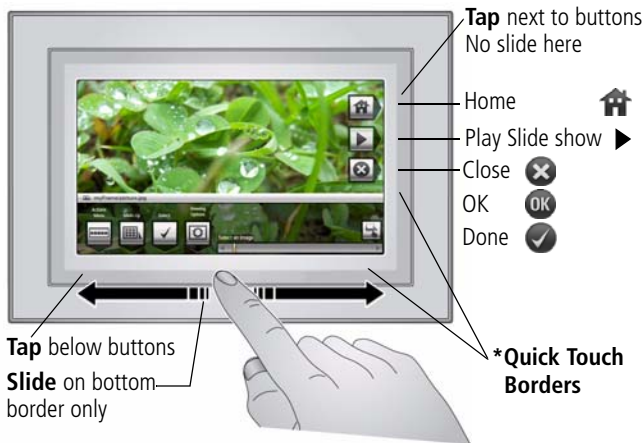

Slide to scroll:

- Scroll through images—Like turning the pages of a book, slide left ← to go forward, slide right → to go back. For faster scrolling through larger numbers of pictures, touch and hold (3 seconds), then slide to the end of the border.
- Scroll through menus—Slide right → to scroll down, slide left ← to scroll up.

** **Tap below small arrows at the ends of the scroll bar** to move the highlight one picture, menu, or item at a time.

Important: The screen is not touch-sensitive. Do not touch it.

Only use your finger to touch the borders. Sharp or metal objects may damage the border or screen

Enjoying your pictures immediately!



- **To view your pictures or play a slide show,** insert a memory card, or connect a camera or other USB device (see [page 8](#)).

If you are at the Home screen, see [page 12](#) to start your slide show.

To change the slide show order, see [page 13](#).

Inserting a memory card

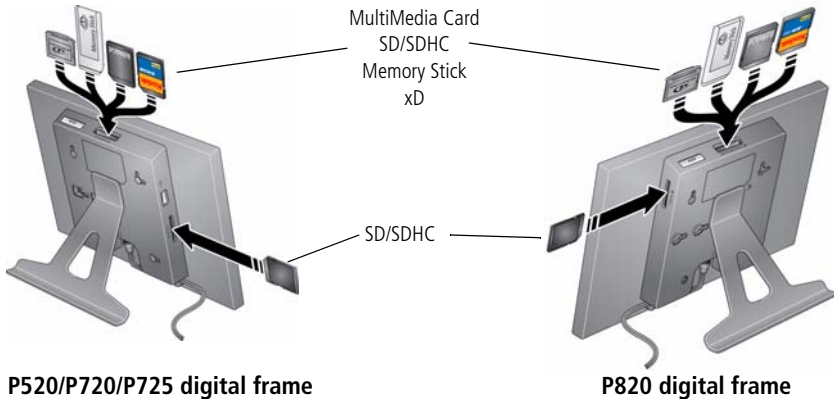

- To insert a card, push the card firmly into the slot until it stops.
- To remove a card from:
 - top card slot, push in the card to release it.
 - side card slot, pull out the card.

IMPORTANT: Do not insert a micro or mini memory card without an adapter.

Connecting a digital camera or other USB device

USB devices include a camera, flash drive, card reader, etc. (sold separately)

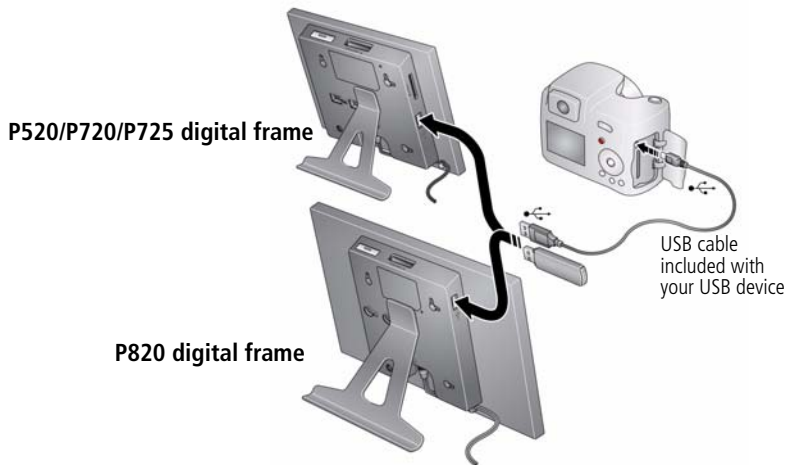



Turning off your frame



- **Standby mode**—Press the power button .
- **Power off**—Unplug the power cable.

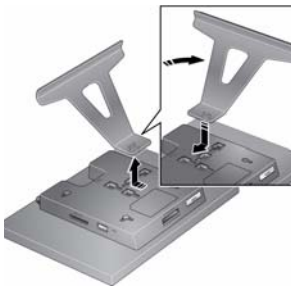

Changing your frame orientation

Your frame is set up to display pictures in landscape  orientation. You can turn the stand to change it to portrait  but you must also change the setting.



Change the stand position: Remove the stand, turn it 90 °, and replace as shown.

Change the setting:

- 1 Tap  (Home) →  (Settings).
- 2 Slide to highlight Set viewing options, then tap OK. Slide to highlight Frame orientation, then tap OK. Slide to highlight Portrait, then tap OK.
- 3 Tap  (Back) to exit.

Mounting your frame on the wall

Use wall-anchoring hardware (not included) to mount your frame securely to your wall.

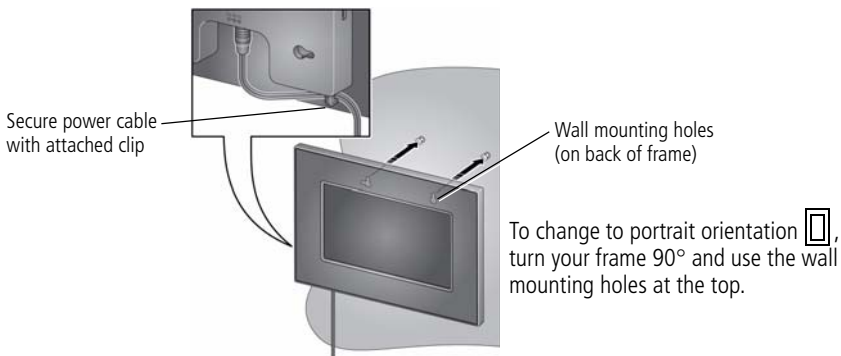

2

Doing more with your frame

Accessing your pictures

Tap Home to access pictures from your memory card and all connected devices (see [page 8](#)). Use the Quick Touch Borders to make your selections (see [page 5](#)).



- 1 Tap  (Home).

All connected sources and the Settings icon are displayed.

- 2 Slide to highlight a picture source, then:
 - Tap  (Play Slide show) to start a slide show.
 - OR
 - Tap OK to view thumbnails.

Picture source icons:



Memory card—appears when you insert a card ([page 7](#)). The label and icon indicate the type of card.



Camera—appears when you connect a digital camera via USB cable ([page 8](#)).



USB drive—appears when you insert a USB card reader or flash drive ([page 8](#)).



Settings—customize your frame settings. For example: set slide show options like durations and transitions; set screen brightness, clock, and timer. See the extended user guide at www.kodak.com/go/digitalframesupport.

Viewing your pictures

Playing a slide show

There are three ways to start a slide show on your frame:

- Insert a memory card or USB device, then turn on the frame.
- Turn on the frame, then insert a card or connect a USB device—a new slide show starts automatically, replacing a currently running slide show or single view picture.
- Highlight a picture in thumbnails view or highlight a picture source on the Home screen, then tap ► (Play Slide show).

NOTE: A slide show plays continuously until you stop it or turn off the frame.

If a slide show is running and the screen icons are unavailable, tap the touch border. Tap ⊗ (Close) to hide the icons.

Viewing thumbnails

There are two ways to view your pictures as thumbnails:



- Tap  (Home). Slide to highlight a picture source (see [page 11](#)), then tap OK.

OR





- From a slide show or single view, tap  (Thumbnails).

NOTE: If the screen icons are unavailable, tap the touch border.

There are 3 ways to navigate through the thumbnails:

- Tap below the arrows at the ends of the scroll bar to move the highlight one picture at a time.
- Slide your finger left/right along the bottom touch border.
- Touch and hold until the screen changes (about 3 seconds) to move even faster through a large number of thumbnails.

Viewing a single picture

- **To view a single**, full-screen picture, highlight it in thumbnails view, then tap OK. To turn off the buttons and other screen text, tap  (Close).
- **To magnify** a picture up to 8X, tap  (Actions), tap  (Zoom), then tap the plus (+) button. To view other parts of the magnified picture, tap the arrows. To return to 1X size, tap the minus (-) button; for P520 frame, continue tapping (+).
NOTE: Depending on picture size, full magnification may be less than 8X.
- **To rotate** a picture, tap  (Actions), then tap  (Rotate).

Viewing pictures by date or filename

By default, the pictures on your frame are arranged and played by date, starting with the oldest. You can change the arrangement or order, by date, or alphabetically by filename.

To change the sort order:

- 1 For P720/P725 or P820 frames—display thumbnails (see [page 12](#)), then tap 

(Slide show options).

For P520 digital frame—tap  (Home), then  (Settings).

- 2 Highlight Sort, then tap Select.
- 3 Select a sort order, as follows. Then tap OK or Save.
 - Filename, A - Z
 - Filename, Z - A
 - Date, oldest to newest (default)
 - Date, newest to oldest

Copying pictures

Copy pictures from your current viewing location to other connected devices ([page 8](#)).



CAUTION:



Removing a card or disconnecting a device while copying may damage your card, pictures, or device.



- 1 Highlight a picture to copy:
In thumbnails view, slide your finger along the slider area to find a picture; or, display a picture in single view.
- 2 Tap  (Actions).



Connected devices

- 3 Tap  (Copy).
Your connected devices appear.
- 4 Tap the device you want to copy to, then tap OK.
The picture is copied.
- 5 Tap  (Close) to close the menu.
To copy multiple pictures, [see page 16](#).



Deleting pictures



CAUTION:

Removing a card or disconnecting a device while deleting may damage your card, pictures, or device.



- 1 Highlight a picture in thumbnails view or display a picture in single view.
- 2 Tap  (Actions).
- 3 Tap  (Delete), then tap Yes to confirm.
The highlighted or displayed picture is deleted.
- 4 Tap  (Close) to close the menu.
To delete multiple pictures, [see page 16](#).

Selecting multiple pictures

Use the multi-select feature to:

- copy or delete two or more pictures
- play a slide show of selected pictures

Selecting individual pictures

- 1 In thumbnails view, touch and slide to highlight a picture, then tap  (Select).
A check mark appears on the selected picture.
- 2 Continue selecting pictures.

To remove a check mark, highlight a picture, then tap Unselect.

Tip: To remove all check marks at once, tap Select All, then tap Unselect All.

Selecting/Unselecting all



Select/Unselect All

Select all

- Tap  (Select All) from thumbnails view (or your current location).

Unselect all

- To remove all check marks, tap Unselect All.



Copying from your computer

Use Kodak EasyShare digital display software to drag and drop pictures easily from your computer to a memory card (or other removable USB device). Insert the card into your frame and play a slide show right away (see [page 8](#)).

The CD that was packaged with your frame contains two applications that work well independently, but also work together for the best experience with your frame:



CD packaged
with your frame.

- Kodak EasyShare digital display software  — manage your frame, organize your pictures and videos, and copy between your frame and computer.
- Kodak EasyShare software  — organize, edit, and share your pictures.

Installing Kodak EasyShare digital display software

- Insert the CD into your computer and follow the on-screen instructions to install the software.

NOTE: Click Typical to install EasyShare digital display software and to update a previous version of EasyShare software. If you do not have a previous version of EasyShare software on your computer, you can click Custom and choose both applications for a new installation.

The software icons appear on your desktop when the installation is complete.

When prompted, take a few minutes to electronically register your frame and software for exclusive tips and offers. To register later, visit www.kodak.com/go/register.

Copying with EasyShare digital display software

- 1 On your computer's desktop, double-click  (Kodak EasyShare digital display software) to start using the software.
- 2 Insert a memory card into your computer or card reader. Or insert a removable USB device into the computer's USB port.
- 3 Click Drag & Drop Zone to see the card or USB device.
- 4 In Pictures & Videos, click the folder or location on your computer that contains the pictures you want to copy.
- 5 In the Viewer pane, select the pictures, then drag and drop them to the card or USB device in the Drag & Drop Zone.
- 6 Remove the card from your computer and insert it into your frame card slot or a connected card reader.

A slide show begins.

NOTE: To maintain the slide show order during playback, see [page 13](#) and select Filename, A - Z.

For more information on the features included in EasyShare digital display software, click the Help button in the software.

Customizing your frame

For a custom look, remove the adhesive matte (included) from its liner, align it carefully, then attach it to your frame.

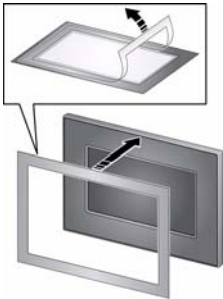

You can reapply the matte to your frame several times. When you are not using the matte, reapply it to the liner and store in a plastic bag to keep the adhesive backing clean.

Maintaining your frame and mattes

IMPORTANT: *Always disconnect the power before cleaning. Do not use water, cleaning solutions, or other adhesives on the frame or any of its parts.*

Gently wipe the frame, LCD, or matte with a clean, dry cloth (included). For fingerprints on the frame, apply light pressure.

Resetting factory defaults

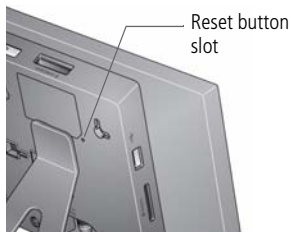

- 1 Make sure the power cable is connected and the frame is turned on.
- 2 Insert a small sharp object into the reset button slot and press the recessed reset button.

When the reset is successful, the set language screen appears.

All settings return to the original factory defaults.

- 3 Reset your language. See [page 4](#).

Learning more about your frame

www.kodak.com/go/digitalframes

Frame accessories, including decorative faceplates and custom mattes

www.kodak.com/go/digitalframesupport

Extended user guide

Interactive troubleshooting and repairs

Interactive tutorials

FAQs

Downloads

Product registration

3

Solving frame problems

For step-by-step product support, visit www.kodak.com/go/digitalframesupport and select Interactive Troubleshooting & Repairs.

| If... | Try one or more of the following |
|---|---|
| Frame does not turn on. | <ul style="list-style-type: none">■ Make sure the power cable that was included with your frame is connected securely (see page 3).■ Unplug the power cable from the frame. Wait 5 seconds, then reconnect the cable.■ Press and hold the power button for 1 second. |
| Nothing happens when a memory card, camera, or USB device is connected. NOTE: A large picture file or images on a large capacity card may take longer to appear. | <ul style="list-style-type: none">■ Insert a certified SD/MMC/MS/xD card with images into the designated card slot, then push to seat it (see page 7). In the top card slot, make sure the card is seated flush with the case.■ Make sure the USB cable that was included with your camera or USB device is connected securely (see page 8).■ Make sure the file format of your pictures is supported. See the extended user guide at www.kodak.com/go/digitalframesupport. |
| Touch border doesn't work. | <ul style="list-style-type: none">■ Use your finger to make your selections on the Quick Touch Borders (see page 5).■ Unplug the power cable from the frame. Wait 5 seconds, then reconnect the cable. Press and hold the power button for 1 second. |
| Frame freezes up. | <ul style="list-style-type: none">■ Unplug the power cable from the frame. Wait 5 seconds, then reconnect the cable. Press and hold the power button for 1 second.■ Use a paper clip or other slim object to press the recessed reset button on the back of the frame (see page 20). |

4 Appendix

Important safety instructions



CAUTION:

Do not disassemble this product; there are no user-serviceable parts inside. Refer servicing to qualified service personnel. Do not expose this product to liquid, moisture, or extreme temperatures. The use of controls, adjustments, or procedures other than those specified herein may result in exposure to shock and/or electrical or mechanical hazards. If the LCD breaks, do not touch the glass or liquid. Contact Kodak customer support.

- The use of an accessory that is not recommended by Kodak may cause fire, electric shock, or injury. For approved accessories, visit www.kodak/go/accessories.
- Digital frame battery (internal and non-removable) may include perchlorate material. Special handling may apply in California.
- Use only the AC adapter supplied with your frame to avoid damage to the frame.
- P820 frames—Use only a Leader Electronics Inc. AC adapter, model MU18-2120150-A1, 12-volt, 1.5 amp. In Europe, use only a Pihong AC adapter, model PSA 18R-120P. Use of other AC adapters may damage the frame and void your warranties.
- When displayed with the stand extended, the frame rests at a 68 - 90 degree angle.
- Do not place frame near naked flame sources such as lighted candles or heaters.

Free software and firmware upgrades

Download the latest versions of the software and the frame firmware (the software that runs on the frame). See www.kodak.com/go/digitalframedownloads.

Additional care and maintenance

- **Gently** wipe the frame, LCD, or matte with a clean, dry cloth (included). For fingerprints on the frame, apply light pressure. Do not use cleaning solutions unless designed specifically for LCD screens. Do not allow chemicals, such as suntan lotion, to contact painted surfaces.

- Service agreements are available in some countries. Contact a dealer of Kodak products for more information.
- For digital frame disposal or recycling information, contact your local authorities. In the US, visit the Electronics Industry Alliance at www.eiae.org or visit www.kodak.com/go/digitalframesupport.

Limited warranty

Kodak warrants Kodak consumer electronic products and accessories (“Products”), excluding batteries, to be free from malfunctions and defects in both materials and workmanship for one year from the date of purchase. Retain the original dated sales receipt. Proof of the date of purchase will be required with any request for warranty repair.

Limited warranty coverage

Warranty service is only available from within the country where the Products were originally purchased. You may be required to ship Products, at your expense, to the authorized service facility for the country where the Products were purchased. Kodak will repair or replace Products if they fail to function properly during the warranty period, subject to any conditions and/or limitations stated herein. Warranty service will include all labor as well as any necessary adjustments and/or replacement parts. If Kodak is unable to repair or replace a Product, Kodak will, at its option, refund the purchase price paid for the Product provided the Product has been returned to Kodak along with proof of the purchase price paid. Repair, replacement, or refund of the purchase price are the sole remedies under the warranty. If replacement parts are used in making repairs, those parts may be remanufactured, or may contain remanufactured materials. If it is necessary to replace the entire Product, it may be replaced with a remanufactured Product. Remanufactured Products, parts and materials are warranted for the remaining warranty term of the original Product, or 90 days after the date of repair or replacement, whichever is longer.

Limitations

This warranty does not cover circumstances beyond Kodak’s control. This warranty does not apply when failure is due to shipping damage, accident, alteration, modification, unauthorized service, misuse, abuse, use with incompatible accessories or attachments, failure to follow Kodak’s operation, maintenance or repacking instructions, failure to use items supplied by Kodak (such as adapters and cables), or claims made after the duration of this warranty. Kodak makes no other express or implied warranty for this product, and disclaims the implied warranties of merchantability and fitness for a particular purpose. In the event that the exclusion of any implied warranty is ineffective under the law, the duration of the implied warranty will be one year from the purchase date or such longer period as required by law. The option of repair, replacement, or refund is Kodak’s

Appendix

only obligation. Kodak will not be responsible for any special, consequential or incidental damages resulting from the sale, purchase, or use of this product regardless of the cause. Liability for any special, consequential or incidental damages (including but not limited to loss of revenue or profit, downtime costs, loss of the use of the equipment, cost of substitute equipment, facilities or services, or claims of your customers for such damages resulting from the purchase, use, or failure of the Product), regardless of cause or for breach of any written or implied warranty is expressly disclaimed.

Your rights

Some states or jurisdictions do not allow exclusion or limitation of incidental or consequential damages, so the above limitation or exclusion may not apply to you. Some states or jurisdictions do not allow limitations on how long an implied warranty lasts, so the above limitation may not apply to you. This warranty gives you specific rights, and you may have other rights which vary from state to state or by jurisdiction.

Outside the United States and Canada

In countries other than the United States and Canada, the terms and conditions of this warranty may be different. Unless a specific Kodak warranty is communicated to the purchaser in writing by a Kodak company, no warranty or liability exists beyond any minimum requirements imposed by law, even though defect, damage, or loss may be by negligence or other act.

FCC compliance and advisory



Kodak EasyShare P520/P720/P725/P820 digital frame

This equipment has been tested and found to comply with the limits for a Class B digital device, pursuant to Part 15 of the FCC Rules. These limits are designed to provide reasonable protection against harmful interference in a residential installation.

This equipment generates, uses, and can radiate radio frequency energy and, if not installed or used in accordance with the instructions, may cause harmful interference to radio communications. However, there is no guarantee that interference will not occur in a particular installation.

If this equipment does cause harmful interference to radio or television reception, which can be determined by turning the equipment off and on, the user is encouraged to try to correct the interference by one or more of the following measures: 1) reorient or relocate the receiving antenna; 2) increase the separation between the equipment and the receiver; 3) connect the equipment to an outlet on a circuit different from that to which the receiver is connected; 4) consult the dealer or an experienced radio/TV technician for additional suggestions.

Any changes or modifications not expressly approved by the party responsible for compliance could void the user's authority to operate the equipment. Where shielded interface cables have been provided with the product or specified additional components or accessories elsewhere defined to be used with the installation of the product, they must be used in order to ensure compliance with FCC regulation.

FCC and Industry Canada

This device complies with Industry Canada RSS-210 and FCC Rules. Operation is subject to the following two conditions: (1) this device may not cause harmful interference, and (2) this device must accept any interference received, including interference that may cause undesired operation.

FCC et Industrie Canada

Cet appareil est conforme à la norme RSS-210 d'Industrie Canada et aux réglementations de la FCC. Son utilisation est soumise aux deux conditions suivantes : (1) cet appareil ne doit pas provoquer d'interférences nuisibles, et (2) cet appareil doit supporter les interférences reçues, y compris celles susceptibles de nuire à son bon fonctionnement.

CE

Hereby, Eastman Kodak Company declares that this Kodak product is in compliance with the essential requirements and other relevant provisions of Directive 1999/5/EC.

Canadian DOC statement

DOC Class B Compliance—This Class B digital apparatus complies with Canadian ICES-003.

Observation des normes-classe B—Cet appareil numérique de la classe B est conforme à la norme NMB-003 du Canada.

Waste Electrical and Electronic Equipment labeling



EU: It is the final user's responsibility to discard this equipment into an approved, segregated collection scheme to enable its suitable treatment/disposal and to improve human/environmental protection. For more information, see your retailer, local authority, or www.kodak.com/go/recycle.

Australian C-Tick



China RoHS

环保使用期限 (EPUP)

在中国大陆，该值表示产品中存在的任何危险物质不得释放，以免危及人身健康、财产或环境的时间期限（以年计）。该值根据操作说明中所规定的产品正常使用而定。

Environmental Protection Use Period (EPUP)

In China, this number indicates the time period (in years) within which any hazardous substances present in the product are not expected to be released such that there is risk to human health, property, or the environment. This value is assigned based on normal use of the product as described in the operating instructions.

Product Disclosure Table

有毒有害物质或元素名称及含量标识表
table of hazardous substances' name and concentration

| 部件名称 Component name | 有毒有害物质或元素 hazardous substances' name | | | | | |
|---|---|-----------|-----------|---------------|---------------|------------------|
| | 铅 (Pb) | 汞 (Hg) | 镉 (Cd) | 六价铬 (Cr6+) | 多溴联苯 (PBB) | 多溴二苯 醚 (PBDE) |
| 数码相架电路板元件 (Digital Photo Frame circuit board components) | X | O | O | O | O | O |
| 控制器 (Controller) | X | O | O | O | O | O |
| 交流变压器电路板元件 (AC Adapter circuit board components) | X | O | O | O | O | O |

O: 表示该有毒有害物质在该部件所有均质材料中的含量均在SJ/T 11363-2006规定的限量要求以下。
 X: 表示该有毒有害物质至少在该部件的某一均质材料中的含量超出SJ/T 11363-2006规定的限量要求。
 O: indicates hazardous substance concentration lower than MCV
 X: indicates hazardous substance concentration higher than MCV



USB 数据线

Russian GOST-R



Eastman Kodak Company
Rochester, New York 14650

Цифровая фоторамка изготовлена в Китае; остальные элементы –
в соответствии с маркировкой

Licensing

Supply of this product does not convey a license nor imply any right to distribute content created with this product in revenue-generating broadcast systems (terrestrial, satellite, cable and/or other distribution channels), streaming applications (via Internet, intranets and/or other networks), other content distribution systems (pay-audio or audio-on-demand applications and the like) or on physical media (compact discs, digital versatile discs, semiconductor chips, hard drives, memory cards and the like). An independent license for such use is required. For details, please visit <http://mp3licensing.com>.

Kodak

Eastman Kodak Company

Rochester, New York 14650

© Eastman Kodak Company, 2008

Kodak and EasyShare are trademarks of Eastman Kodak Company.

4F8179_en

www.kodak.com/goldigitalframesupport



Free Manuals Download Website

<http://myh66.com>

<http://usermanuals.us>

<http://www.somanuals.com>

<http://www.4manuals.cc>

<http://www.manual-lib.com>

<http://www.404manual.com>

<http://www.luxmanual.com>

<http://aubethermostatmanual.com>

Golf course search by state

<http://golfingnear.com>

Email search by domain

<http://emailbydomain.com>

Auto manuals search

<http://auto.somanuals.com>

TV manuals search

<http://tv.somanuals.com>