

interfire

**MONO CHANNEL CLASS "D"
AUTOMOTIVE AMPLIFIER**

D900.1 / D1700.1 / D3000.1

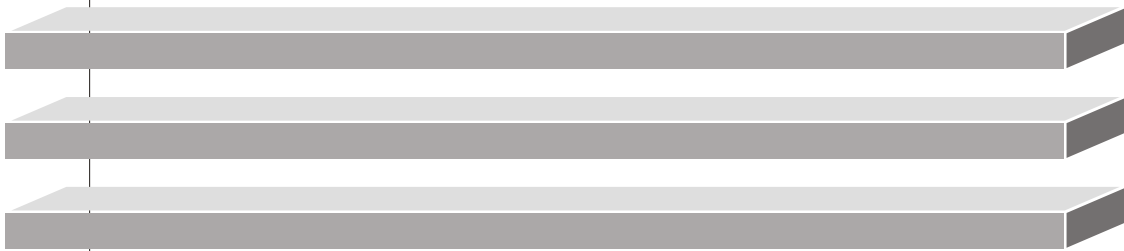

INSTRUCTION MANUAL



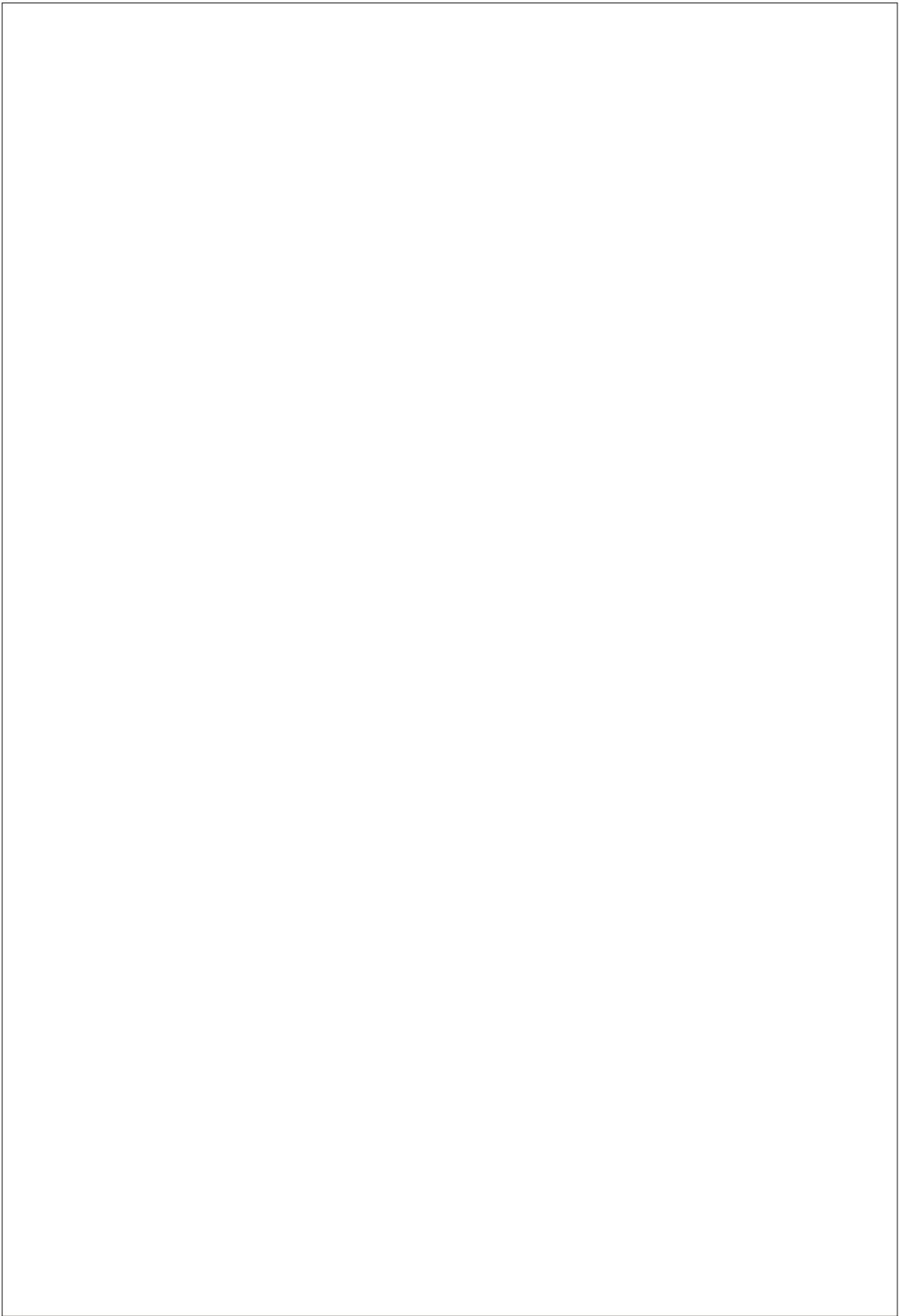

CONGRATULATIONS ON YOUR PURCHASE

Your new high fidelity mono block amplifier is designed to deliver maximum enjoyment and one year of trouble free service. Please take a few moments to read this manual thoroughly. It will explain the features and operation of your unit and help insure trouble free installation.

FEATURES

- Class "D" Technology
- 1 Ohm Stable
- Spec Audiophile Grade Components
- High Efficiency PWM Power Supply
 - Multi-stranded power toroid
 - Toroidal core
 - MOSFET transistors
- Oversized Capacitor Banks
- Discrete Mount Power and speaker terminals
- Variable Low Pass Electronic Crossover 50Hz - 250Hz
- Built in power bridging module
- Circuit / Thermal / Overload Protection
- Remote Level Control

IMPORTANT

PLEASE READ ALL INSTRUCTIONS BEFORE INSTALLATION!

The quality of installation may affect the performance and reliability of your product. If you have any doubts or questions regarding installation, you may wish to contact your authorized dealer. Remember to heed all wire and fuse requirements suggested in this manual. Warranty may be void if proper installation technique is not used (refer to warranty section in the rear of the manual)

INSTALLATION

MOUNTING:

1. After reading precaution, decide where you are going to install the unit. Also, see Fig.1.
2. Once the location has been determined, place the amplifier into position. Using a felt tip pen or pencil mark the four holes to be drilled for mounting. NEVER use the amplifier as a template for drilling. It is very easy to damage the amplifier surface in this manner.
3. Remove amplifier. Drill four 3.5 m/m holes into mounting surface. If you want to mount the amplifier to MDF or wood panel, drill four 3.0m/m diameter holes into mounting surface.
4. If possible, test the system to ensure it is operating correctly before final mounting of the amplifier.
5. Mount the amplifier using the supplied 4 self tapping screws.

INSTALLATION DIAGRAM

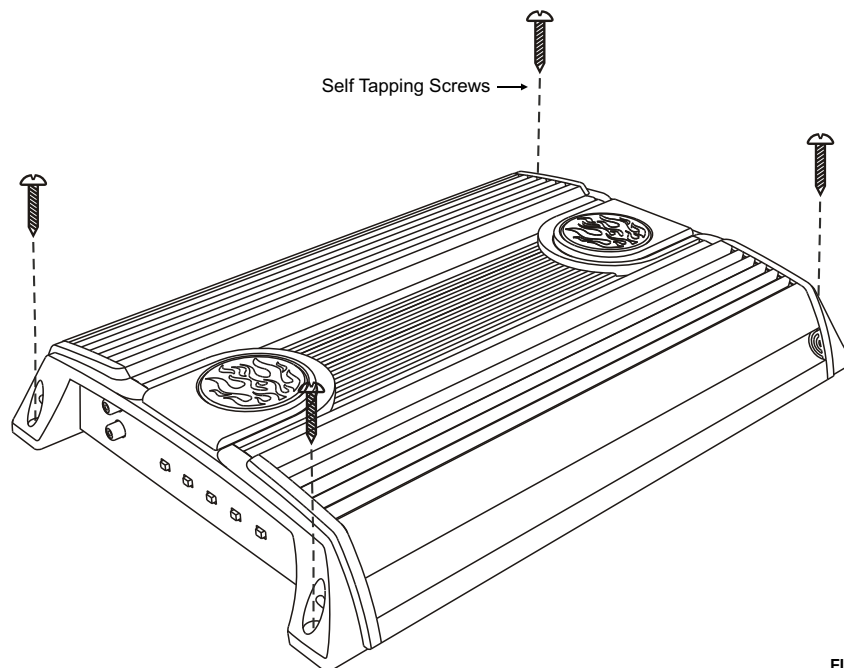

SPEAKER WIRING

The Class "D" amplifier is a SINGLE CHANNEL dedicated subwoofer amplifier. Unlike other amplifiers, the Class "D" operates as a single channel and cannot be bridged. Don't be fooled by the outputs. Two outputs are used strictly for convenience and are paralleled internally on the amplifier. This means that if both outputs are used with one driver each, the amplifier sees the same load as if the same drivers are connected to only one output terminal. See diagram below.

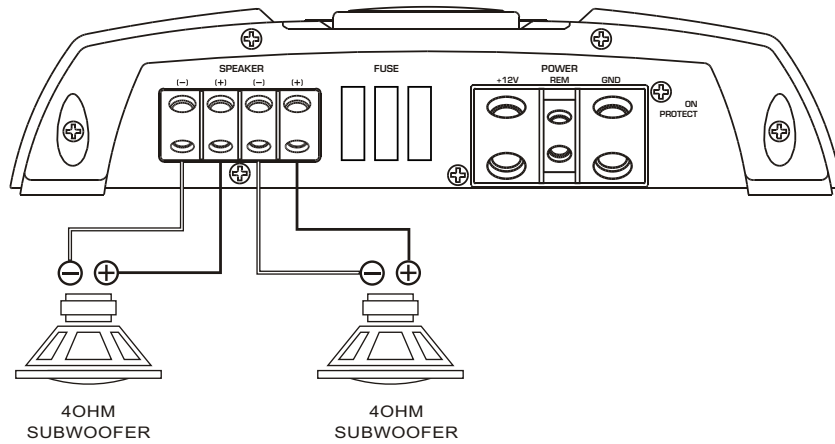
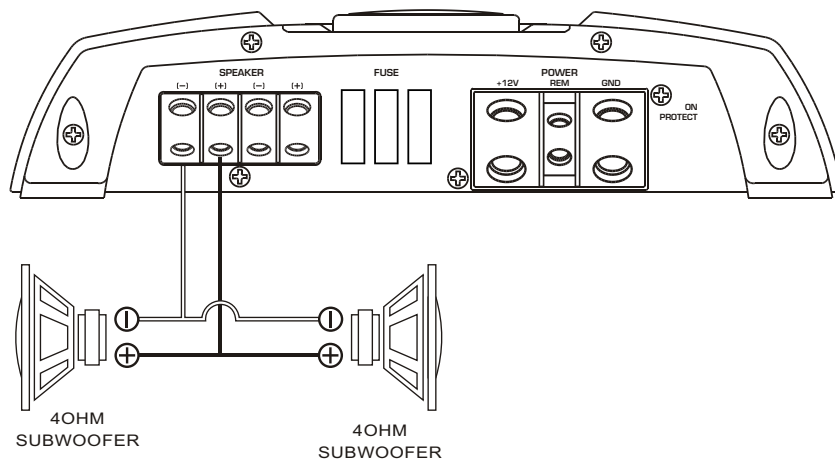

In both diagrams, the amplifier sees a 2 ohm load.

MONO BRIDGED

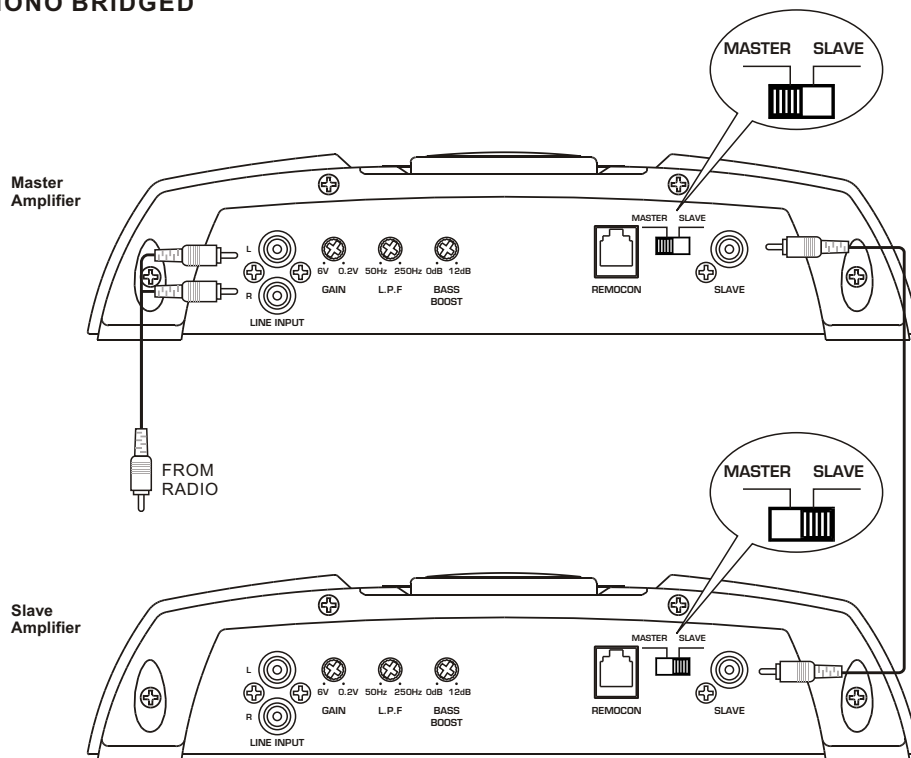

WIRING SUBWOOFERS (DUAL AMPS)

When using dual amplifiers to power one subwoofer, the Positive terminal of the Subwoofers voice coil is connected to the positive terminal of the MASTER Amplifier and the Negative terminal of the Subwoofers voice coil is connected to Positive terminal on the SLAVE Amplifier. This procedure will allow the total power of both amplifiers to be added together and act like a single powerful amplifier. Please check that your subwoofer power handling capabilities are not exceeded when hooking two amplifiers to it.

CAUTION

Always check your speaker load with a multi-meter before hooking up to the amplifier. These digital amplifiers are only 1 ohm stable. Any Impedance (load) smaller than 1 ohm will damage the amplifier. Such Damage is not covered under warranty either, so pay strict attention to what connections are made to the amplifier.

MONO BRIDGED

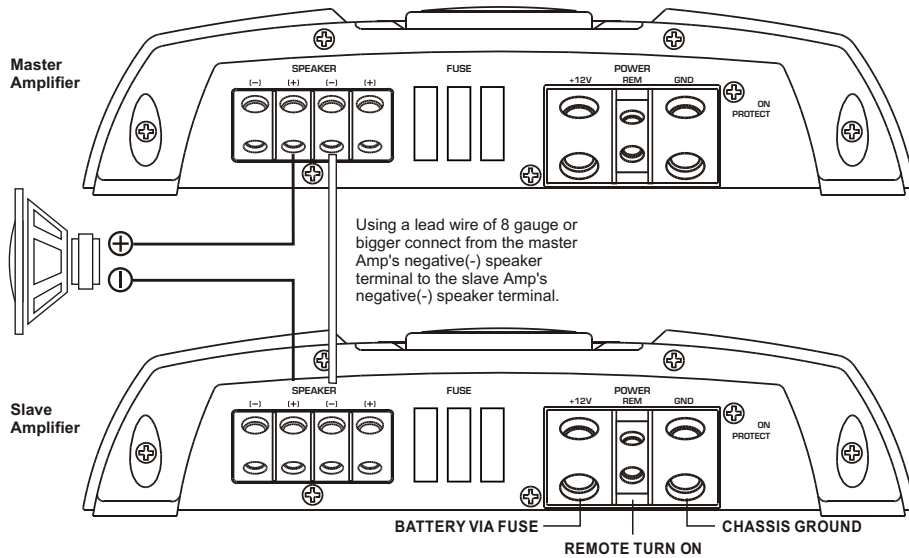

(OPTION) TWOAMPLIFIER/ ONESUBWOOFER (SINGLEVOICE COIL)CONFIGURATION

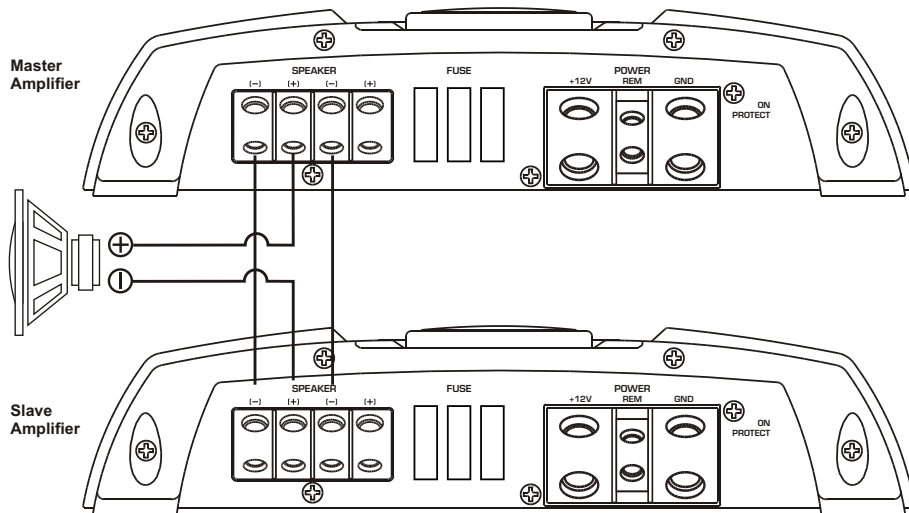

Recommend : Competition Only

MONO BRIDGED

(OPTION) FOUR AMPLIFIER/ ONE SUBWOOFER (DUAL VOICE COIL) CONFIGURATION

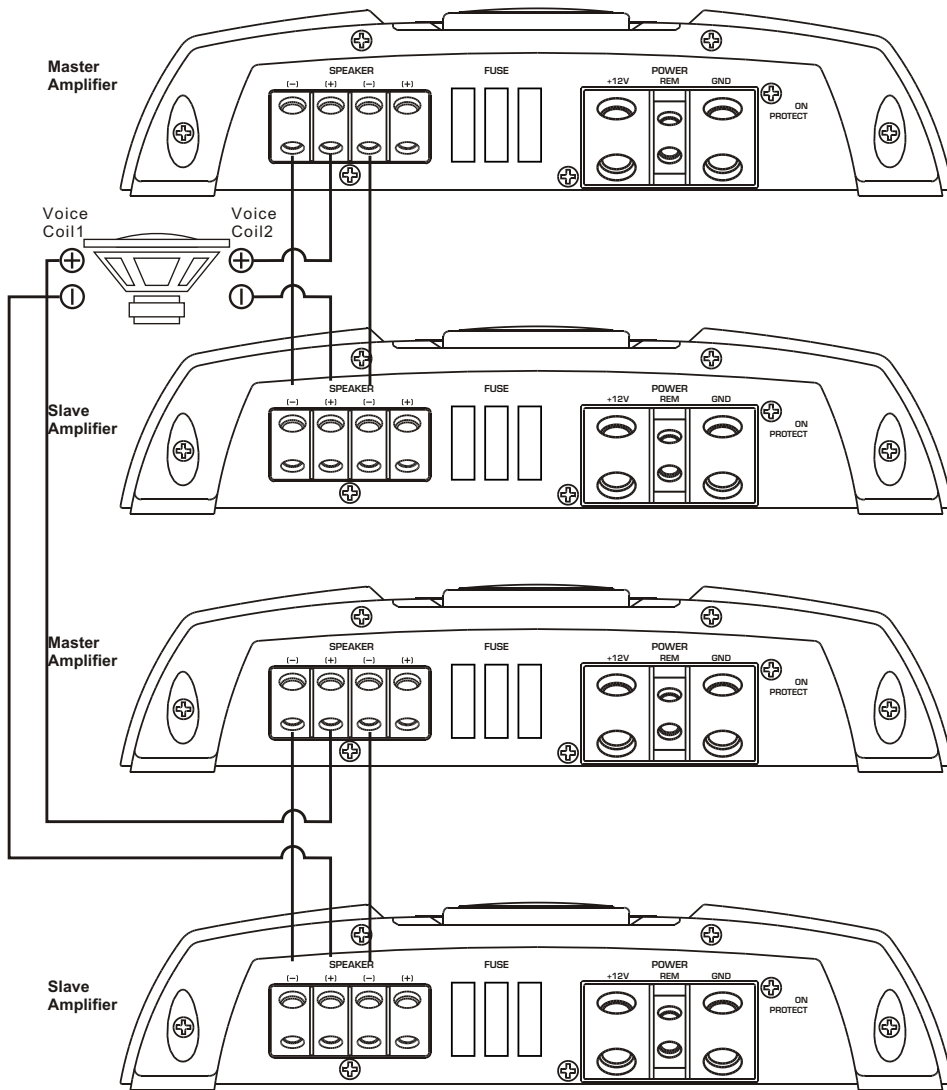

POWER SUPPLY CONNECTIONS

The Class "D" amplifier is designed to work within 10 to 16 volts DC. Before any wires are connected, the vehicle's electrical system should be checked for correct voltage supply with the help of a voltmeter. First check the voltage at the battery terminals with the ignition in the off position. The voltmeter should read no less than 12 volts. Next, check the battery with the engine running between 1500 and 2000 rpm. The voltmeter should now read between 13.5 and 14.5 volts. If your vehicle's electrical system is not up to these specifications, we recommend having it checked by an automotive mechanic before further installation.

RECOMMENDED POWERWIRE

The proper wire size is very important for an amplifier of this power level. Because the Class "D" amplifier is capable of drawing in excess of 90 amperes, 4 gauge wire is recommended for lengths up to twenty feet. If a longer length is needed, a larger gauge wire may be necessary.

POWER

Amplifier power wire should be wired directly to the battery using the wire requirements listed above. Start at the amplifier and run the power wire through the vehicle to the battery. The use of grommets is recommended when passing the power wire through any metal wall. Avoid sharp corners or sharp body parts that may easily cut through the insulation on the wire. Avoid running the power wire over engine components and near heater cores. Use an inline fuse to eliminate the risk of a fire caused by a short in your power wire. Connect the fuse holder as close to the battery positive as possible. For most applications, an 80 ampere Maxi fuse or comparable ANL wafer fuse can be used. Now connect the wire to the battery, but remember to leave the fuse out until all other wire connections are made.

GROUND

When grounding your amplifier, locate a metal area close to the amplifier that is a good source of ground (preferably the floor). Once again, investigate the area you wish to use for electrical wires, vacuum lines, and brake or fuel lines. Using either a wire brush or sandpaper eliminate unwanted paint to supply a better contact for your ground. Use the same gauge wire for ground as you did for the power. Terminate the ground wire using the correct size ring terminal and attach it to the bare metal using a nut and bolt. It is important for this connection to be solid. To complete the job, spread silicon over the screw and bare metal to prevent rust and possible water leaks.

REMOTE TURN-ON

In between the power and ground is a remote turn-on terminal. This terminal must be connected to a switched +12 volt source. Typically, remote turn-on leads are provided at the source unit that will turn on and off the amplifier in correspondence with the source. If a radio does not have a remote turn-on, then a power antenna wire may be used. Yet, if neither of these leads are available at the source, a switched +12 volt supply must be supplied. Run a minimum of 18-gauge wire from the amplifier location to the source of the switched +12 volt lead. If possible, route this wire on the same side of the vehicle as your power wire. Connect the source remote output wire to the REM terminal on the amplifier using a 3mm screw key. Cut the remote wire to length. Strip approximately 1/2 inch of insulation from the end of the wire and insert into the terminal. Tighten the screw securely.

OPERATION

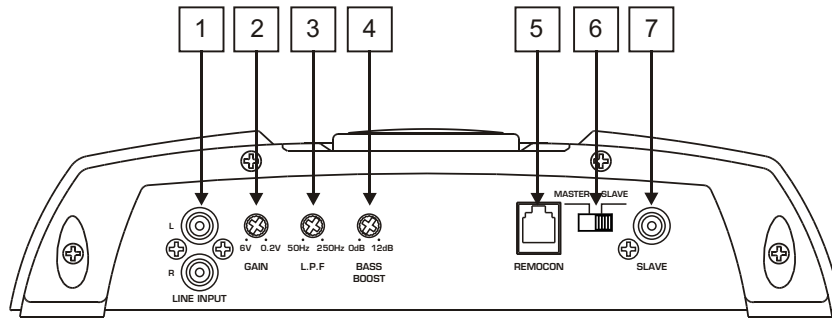

1. RCA Input Jacks
2. Input Level Control
3. Low Pass Frequency
4. Bass Boost
5. Remote Control Jack
6. Master/Slave Switch
7. Slave Input Jack

Control and Crossover

1. RCA Input Jacks - Low level-high impedance inputs. Use high quality RCA cables designed for mobile applications.
2. Input Level Control - Adjust the input level for the marked channels. Turn clockwise to increase the level, counterclockwise to decrease. Amplifiers will run cooler and produce less system noise at lower level settings.
3. Low Pass Frequency - Adjust the crossover frequency by turning clockwise to set to a higher frequency, counterclockwise to set to a lower frequency.
4. Bass Boost - Adjust the sub boost level of the selected frequency output from 0dB to 12dB.
5. Remote Control Jack - For connecting the remote control module to the amplifier.
6. Master/Slave Switch - Select the remote level control or the on-board level control as the master control.
7. Slave Input Jack - Used to connect to another amplifier when bridging 2 amps together. The Slave mode bypasses normal input jacks and controls.

FRONT/REAR PANEL

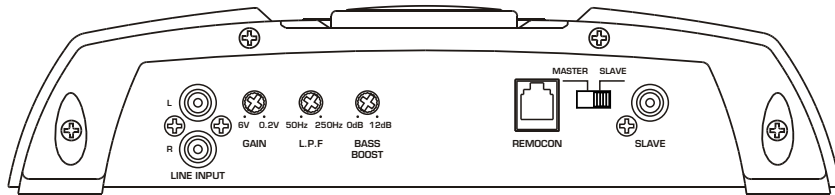

D900.1, D1700.1, D3000.1

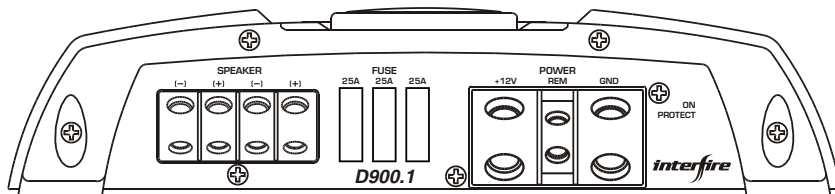

D900.1

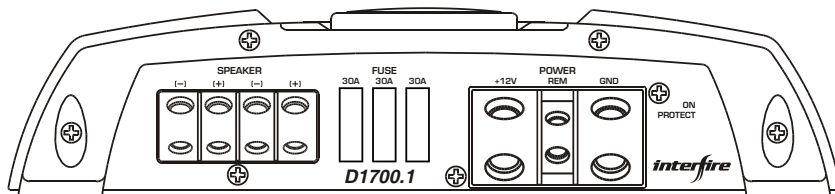

D1700.1

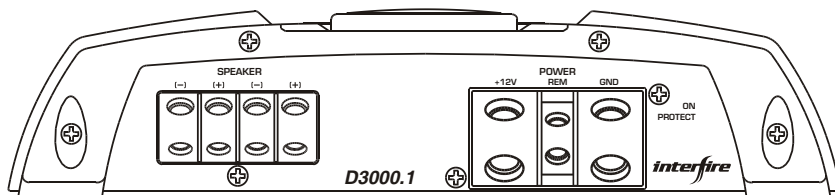

D3000.1

TROUBLE SHOOTING GUIDE.

This section provides you with a catalog of amplifier symptoms and their probable causes and solutions. Before you consult this listing, make sure the vehicle's electrical system is working properly by verifying that other electrical items (e.g. headlights, windows, etc.) still function correctly.

SYMPTOM	PROBABLE CAUSE	SOLUTION
No Audio	Low or N.C Remote Turn-on connections Blown Fuse Power wires not connected Blown or non speakers connected	Check remote turn-on voltage at amp and head unit Replace with new fast-blow fuse Check butt splices or solder joints Check ground and battery connections Use VOM or DVM to measure speaker coil impedance; check speaker wiring connections
Distorted Audio	Input Sensitivity not set properly or damaged speaker cones Low turn-on voltage	See adjustment procedure and check each step; Inspect each speaker for damage and repair or replace suspected component Refer to head unit owner's manual
Audio Level Low	Mute circuit on head unit is on.	Check electrical system for low voltage; Check ground connection
Audio Lacks	Speakers wired with wrong polarity, causing cancellation of bass frequencies	Check polarity of wires from amplifiers to each speaker as defined by the system design Check battery voltage at amplifier during operation
External Fuse Blowing	Incorrect wiring or short circuit	Refer to electrical installation and check each installation step
Whining noise on audio with engine running	Amplifier is picking up alternator noise	Install an in-line noise filter on the head unit's power wire; Check alternator routing diodes or voltage regulator for proper operation. Check all grounds , battery voltage, and RCA cables
Ticking noise on audio with engine running	Amplifier is picking up radiated spark noise	Check RCA audio cable; Install an in-line noise filter on the head unit's power wire. Check spark plug wires.

SPECIFICATION

AMPLIFIER	D900.1	D1700.1	D3000.1
RMS POWER / 1 ohm @ 1% T.H.D	900W x 1	1700W x 1	3000W x 1
2 ohms @ 0.05% T.H.D	650W x 1	1000W x 1	2000W x 1
4 ohms @ 0.05% T.H.D	350W x 1	500W x 1	1000W x 1
Efficiency / Typical @ 4 ohms	90%	90%	90%
MIN RATE @ 1 ohm	79%	79%	79%
Bandwidth ±1dB	10Hz ~ 250Hz	10Hz ~ 250Hz	10Hz ~ 250Hz
Signal ToNoise Ratio ('A' WTD)	>100dB	>100dB	>100dB
Damping Factor	150	150	150
Input Sensitivity	200mV ~ 6V	200mV ~ 6V	200mV ~ 6V
Input Impedance	20K Ohms	20K Ohms	20K Ohms
Circuit Breaker	75Amp	90 Amp	EXTERNAL
Dimensions (W x H x D) mm	257 x 56 x 320	257 x 56 x 350	257 x 56 x 420
Crossover Selector Switch			
Variable Low Pass Filter	Variable 50 ~ 250Hz	Variable 50 ~ 250Hz	Variable 50 ~ 250Hz
X-Over Slope	24dB	24dB	24dB
Variable Subsonic Filter	20 ~ 50Hz @ 24dB	20 ~ 50Hz @ 24dB	20 ~ 50Hz @ 24dB

NOTE : Specifications & design subject to change without notice for improvements.

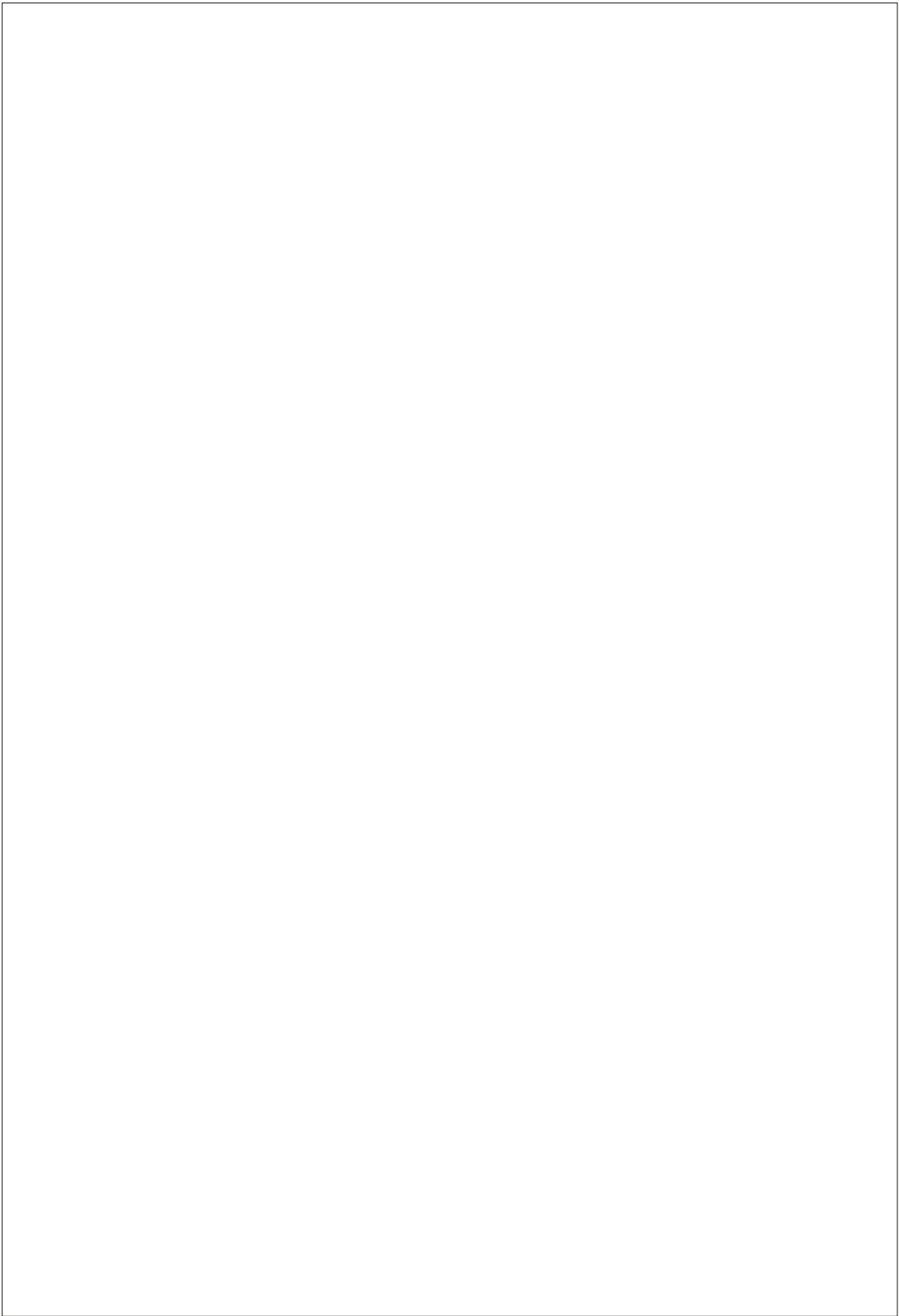

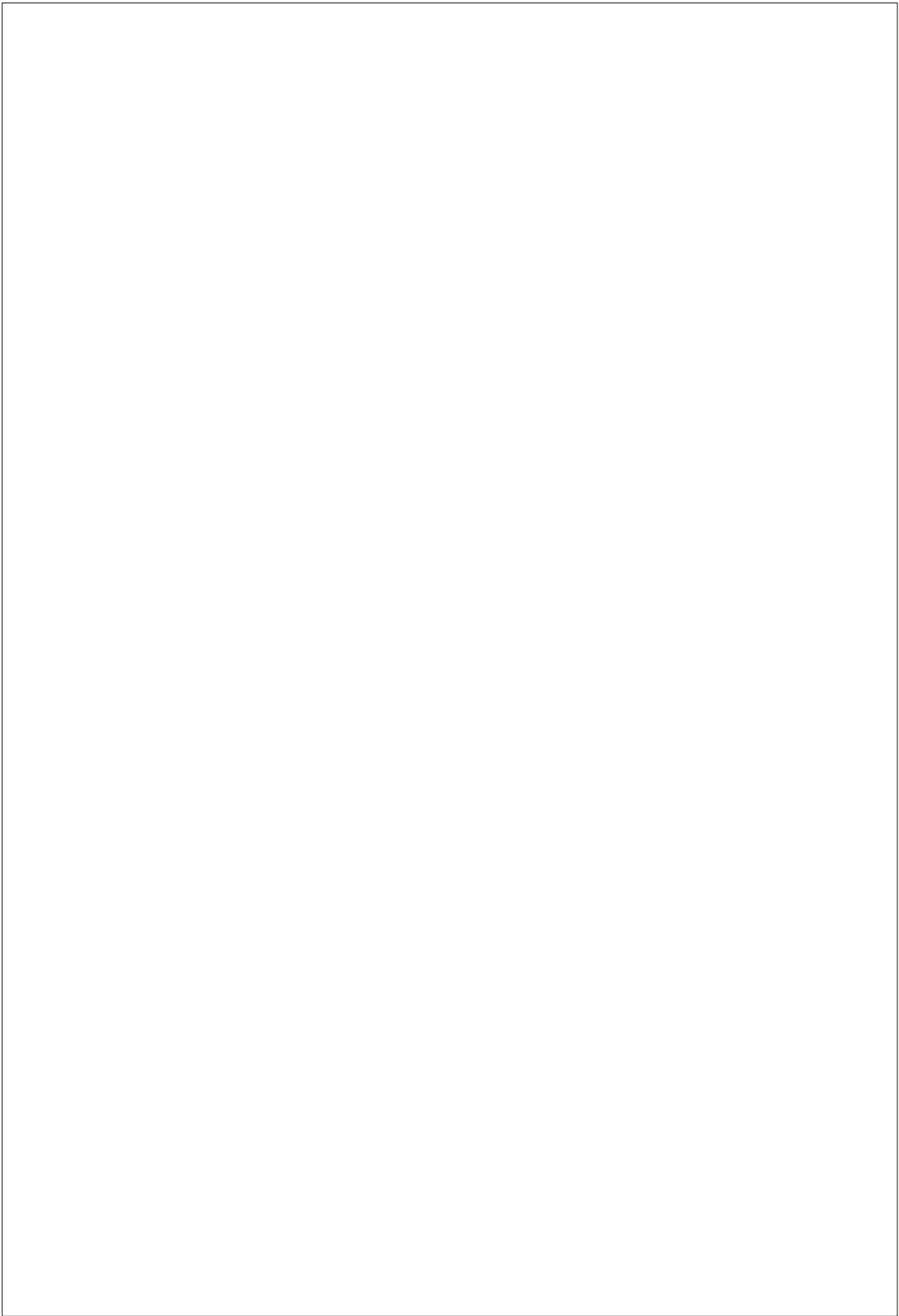

interfire

Interfire Audio, Inc.
Santa Fe Springs, CA 90670
www.interfireaudio.com

Printed in Korea

Free Manuals Download Website

<http://myh66.com>

<http://usermanuals.us>

<http://www.somanuals.com>

<http://www.4manuals.cc>

<http://www.manual-lib.com>

<http://www.404manual.com>

<http://www.luxmanual.com>

<http://aubethermostatmanual.com>

Golf course search by state

<http://golfingnear.com>

Email search by domain

<http://emailbydomain.com>

Auto manuals search

<http://auto.somanuals.com>

TV manuals search

<http://tv.somanuals.com>