



JBL SIS Products Group

*8500 Balboa Boulevard
Northridge, CA 91329
250 Crossways Park Drive
Woodbury, NY 11797
800-336-4JBL*

Manufactured under license from Dolby Laboratories. "Dolby," "Pro Logic," "Surround EX," and the double-D symbol are trademarks of Dolby Laboratories.

Manufactured under license from Lucasfilm Ltd. U.S. Patent Nos. 5,043,970; 5,189,703; and/or 5,222,059. European Patent No. 0323830. Other U.S. and foreign patents pending. Lucasfilm and THX are trademarks or registered trademarks of Lucasfilm Ltd. Surround EX is a trademark of Dolby Laboratories. Used under authorization.

Manufactured under license from Digital Theater Systems, Inc. U.S. Patent Nos. 5,451,942; 5,956,674; 5,974,380; 5,978,762 and other worldwide patents issued and pending. "DTS," "DTS-ES Extended Surround," and "Neo:6" are trademarks of Digital Theater Systems, Inc. © 1996, 2000 Digital Theater Systems, Inc. All rights reserved.

"Lexicon," "LOGIC7," and the L7 logo are registered trademarks of Harman International Industries, Inc. U.S. Patent Nos. D454,553; D454,860; 5,796,844; 5,870,480 and other worldwide patents issued and pending.

© 2003 Harman international Industries, Incorporated, All rights reserved.

This document should not be construed as a commitment on the part of JBL Synthesis. The information it contains is subject to change without notice. JBL Synthesis assumes no responsibility for errors that may appear within this document.

DOCUMENTATION CONVENTIONS

This document contains general safety, installation, and operation instructions for the SDP-5 Digital Controller. It is important to read this user guide before attempting to use this product. Pay particular attention to safety instructions.

The following symbols are used in this document:



Appears on the component to indicate the presence of uninsulated, dangerous voltage inside the enclosure – voltage that may be sufficient to constitute a risk of shock.



Appears on the component to indicate important operating and maintenance instructions in the accompanying literature.

WARNING

Calls attention to a procedure, practice, condition or the like that, if not correctly performed or adhered to, could result in injury or death.

CAUTION

Calls attention to a procedure, practice, condition or the like that, if not correctly performed or adhered to, could result in damage or destruction to part or all of the product.

Note: Calls attention to information that is essential to hi

SETUP ▶ INPUTS ▶ DVD1 ▶ DVD1 INPUT SETUP

Represents a menu path. The menu items in gray boxes must be selected with the remote control Menu ▶ arrow to access the menu or menu item in the black box. For instance, the SETUP, INPUTS, and DVD1 menu items must be selected to open the DVD1 INPUT SETUP menu.

The DVD1 INPUT SETUP menu is used here as an example, and will continue to be used as an example throughout this document. Whenever it appears, any other INPUT SETUP menu may be substituted. Likewise, whenever the DVD1 input appears as a step in a menu path, any other input may be substituted.

- This document uses the term dts(-ES) to indicate that dts-ES encoding may or may not be present in the input source.

Introduction

Documentation Conventions	ii
US Important Safety Instructions	v
DE Wichtige Sicherheitshinweise	v
ES Instrucciones de seguridad importantes	vi
FR Instructions importantes relatives à la sécurité.	vi
IT Importanti norme di sicurezza.	vii
PT Instruções importantes de segurança.	vii
DK Vigtig information om sikkerhed.	viii
FI Tärkeitä turvallisuusohjeita	viii
NO Viktig informasjon om sikkerhet.	ix
SE Viktiga säkerhetsföreskrifter	ix
US Unpacking and Inspection	x
DE Auspacken und Überprüfung	x
ES Desembalaje e inspección	x
FR Contenu de l’emballage et inspection.	x
IT Disimballaggio ed ispezione	x
PT Retirando a embalagem e inspeccionando	x

Section 1: Getting Started

About the SDP-5.	1-2
<i>Highlights • Product Registration</i>	
Installation Considerations.	1-4
Remote Control Battery Installation	1-5

Section 2: Basic Operation

Front Panel Overview	2-2
Rear Panel Overview	2-5
Remote Control Overview	2-9
<i>Operation Considerations • MAIN MENU • Menu Navigation • Menu Item Selection • Command Bank Activation • Command Matrix</i>	
Understanding the Zones	2-17
Two-Line Status	2-18
STATUS Menus	2-18
<i>2CH STATUS • DOLBY D STATUS • dts(-ES) STATUS • 5.1a BYPASS STATUS • 2CH BYPASS STATUS • DIGITAL STATUS</i>	
STATUS Menu Parameter Descriptions	2-23
<i>STATUS Menu Level Meters</i>	

Section 3: SETUP

SETUP	3-2
INPUT SETUP	3-3
<i>Changing Input Names (NAME) • Assigning Audio & Video Input Connectors • Selecting Preferred Listening Modes • Configuring Advanced Zone Settings</i>	
SPEAKER SETUP.	3-26
<i>Custom Speaker Setups • THX Speaker Setups • Measuring Speaker Distances • Calibrating Output Levels</i>	

. . . Section 3: SETUP continues on page iv

Section 3: SETUP (continued from page iii)

REAR PANEL CONFIG	3-45
DISPLAY SETUP	3-47
<i>On-Screen Display Setup • Front Panel Display Setup</i>	
VOLUME CONTROL SETUP	3-53
TRIGGER SETUP	3-54
LOCK OPTIONS	3-56

Section 4: AUDIO CONTROLS

AUDIO CONTROLS	4-2
--------------------------	-----

Section 5: MODE ADJUST

MODE ADJUST	5-2
Listening Mode Activation	5-2
<i>Preferred Listening Mode Selection Parameters • Mode ▲ and ▼ Buttons • Mode Family Selection Buttons</i>	
Listening Mode Descriptions	5-3
<i>L7 FILM • L7 TV • L7 MUSIC • L7 MUSIC SURR • DOLBY PLII + THX • DOLBY PLII MOVIE • DOLBY PLII MUSIC • DOLBY PRO LOGIC • dts NEO:6 FILM • dts NEO:6 MUSIC • NIGHTCLUB • CONCERT HALL • CHURCH • CATHEDRAL • PANORAMA • PANORAMA CALIBRATION • PARTY • 2-CHANNEL • MONO LOGIC • MONO SURROUND • MONO • 5.1 L7 FILM • 5.1 L7 TV • 5.1 L7 MUSIC • 5.1 THX, 5.1 THX ULTRA2, & 5.1 THX SurEX • 5.1 THX MUSIC • DOLBY DIGITAL & DOLBY DIGITAL EX • 5.1 2-CHANNEL • 5.1 MONO LOGIC • 5.1 MONO SURR • 5.1 MONO • dts-ES Decoding • dts(-ES) L7 FILM • dts(-ES) L7 MUSIC • dts THX ULTRA2 & dts-ES THX • dts THX MUSIC • dts(-ES) • dts(-ES) 2-CHAN • 5.1a BYPASS • 2CH BYPASS</i>	
Listening Mode Menu Option & Parameter Descriptions	5-28

Section 6: Troubleshooting & Maintenance

Troubleshooting	6-2
Routine Maintenance	6-4
Restoring Factory-Default Settings	6-5

Appendix

Specifications	A-2
Declaration of Conformity	A-4
Menu Tree	A-4
Installation Worksheet	A-14

Index**Limited Warranty Inside Back Cover**

ENGLISH

IMPORTANT SAFETY INSTRUCTIONS

- Save these instructions for later use.
- Follow all instructions and warnings marked on the unit.
- Always use with the correct line voltage. Refer to the manufacturer's operating instructions for power requirements. Be advised that different operating voltages may require the use of a different line cord and/or attachment plug.
- Do not install the unit in an unventilated rack, or directly above heat-producing equipment such as power amplifiers. Observe the maximum ambient operating temperature listed in the product specification.
- Slots and openings on the case are provided for ventilation; to ensure reliable operation and prevent it from overheating, these openings must not be blocked or covered. Never push objects of any kind through any of the ventilation slots. Never spill liquid of any kind on the unit.
- Never attach audio power amplifier outputs directly to any of the unit's connectors.
- To prevent shock or fire hazard, do not expose the unit to rain or moisture, or operate it where it will be exposed to water.
- Do not attempt to operate the unit if it has been dropped, damaged, exposed to liquids, or if it exhibits a distinct change in performance indicating the need for service.
- This unit should only be opened by qualified service personnel. Removing covers will expose you to hazardous voltages.



This triangle, which appears on your component, alerts you to the presence of uninsulated, dangerous voltage inside the enclosure...voltage that may be sufficient to constitute a risk of shock.



This triangle, which appears on your component, alerts you to important operating and maintenance instructions in this accompanying literature.

DE

DEUTSCH
WICHTIGE SICHERHEITSHINWEISE

- Bewahren Sie diese Anleitungen zur späteren Benutzung auf.
- Befolgen Sie alle Anleitungen und alle Warnhinweise auf dem Gerät
- Betreiben Sie das Gerät immer mit der korrekten Netzspannung. Angaben über den Strombedarf entnehmen Sie bitte den Betriebsanweisungen des Herstellers. Bei unterschiedlichen Betriebsspannungen kann die Verwendung anderer Netzkabel und/oder Anschlußstecker erforderlich werden.
- Bauen Sie das Gerät nie in ein unbelüftetes Rack oder direkt über Wärme erzeugenden Geräten wie Verstärkern ein. Beachten Sie die in der Produktspezifikation aufgeführte maximale Umgebungstemperatur für den Betrieb.
- Schlitze und Öffnungen in der Box dienen der Belüftung, damit das Gerät zuverlässig läuft und sich nicht überhitzt. Diese Öffnungen dürfen nicht abgedeckt oder blockiert werden. Auch dürfen keine Gegenstände in sie hineingesteckt werden. Verschütten Sie niemals Flüssigkeiten, gleich welcher Art, auf das Gerät.
- Schließen Sie niemals Stromausgänge des Audioverstärkers direkt an das Gerät an.
- Zur Vermeidung von elektrischen Schlägen oder Brandgefahr darf das Gerät weder Regen noch Feuchtigkeit ausgesetzt oder an Orten betrieben werden, wo es mit Wasser in Berührung kommen kann.
- Versuchen Sie nie, das Gerät zu betreiben, wenn es fallen gelassen, beschädigt oder Flüssigkeiten ausgesetzt wurde oder wenn ein deutlicher Leistungsunterschied zu verzeichnen ist, der darauf hinweist, dass es gewartet werden muss.
- Dieser Apparat sollte nur von qualifizierten Fachleuten geöffnet werden. Das Abnehmen von Abdeckungen setzt Sie gefährlichen Spannungen aus.



Dieses Dreieck, welches auf Ihrem Bauteil angebracht ist, warnt Sie vor dem Vorhandensein nicht isolierter gefährlicher Spannung im Gerät. Diese Spannung kann so hoch sein, dass das Risiko eines Stromschlags besteht.



Dieses Dreieck, welches auf Ihrem Bauteil angebracht ist, macht Sie auf wichtige Betriebs- und Wartungshinweise in diesen Hinweisen aufmerksam.

ES

ESPAÑOL

ES

INSTRUCCIONES DE SEGURIDAD IMPORTANTES

- Guarde estas instrucciones para futuras referencias.
- Siga todas las instrucciones y tenga en cuenta las advertencias que aparecen en la unidad y en las instrucciones de funcionamiento.
- Utilice siempre la tensión de línea correcta. Consulte las instrucciones del fabricante, donde se especifican los requisitos de alimentación. Tenga en cuenta que unas tensiones operativas diferentes pueden precisar de la utilización de diferentes cables de alimentación y/o enchufes.
- No instale la unidad en un rack sin ventilación, o directamente sobre equipos que generen calor, como amplificadores de potencia. Tenga en cuenta la temperatura operativa ambiental máxima que se detalla en las especificaciones del producto.
- Las ranuras y aberturas del equipo son para su ventilación - para garantizar un funcionamiento fiable y evitar que la unidad se sobrecaliente, no bloquee, cubra o inserte objetos en las aberturas. No derrame nunca líquidos de ningún tipo sobre la unidad.
- Nunca conecte directamente salidas de amplificadores de potencia de audio a ninguno de los conectores de la unidad.
- Para evitar descargas eléctricas o incendios, no exponga la unidad a la humedad o la lluvia, ni la utilice donde pueda estar expuesta al agua.
- No intente utilizar la unidad si ésta ha caído, se ha dañado, ha estado expuesta a líquidos, o si muestra un cambio importante en sus prestaciones, lo cual indicaría la necesidad de una reparación.
- Das esta unidad deberá ser abierta únicamente por personal calificado. Si usted quita las coberturas se expondrá a voltajes peligrosos.



Este triángulo, que aparece en su componente, alerta de la presencia de una tensión peligrosa no aislada en el interior del equipo - una tensión que puede ser suficiente como para constituir un riesgo de descarga eléctrica.



Este triángulo, que aparece en su equipo, le alerta de instrucciones operativas y de mantenimiento importantes en los documentos que acompañan al producto.

FR

FRANÇAIS

FR

INSTRUCTIONS IMPORTANTES RELATIVES
À LA SÉCURITÉ

- Conservez ces instructions pour pouvoir vous y référer ultérieurement.
- Suivez toutes ces instructions et tenez compte de tous les avertissements indiqués sur l'appareil et dans la documentation fournie avec l'appareil.
- Utilisez toujours la tension secteur correcte. Consultez les instructions du fabricant précisant les caractéristiques d'alimentation à respecter. Attention, le type de cordon secteur et/ou de prise secteur peut varier selon des tensions en vigueur dans l'installation.
- N'installez pas l'appareil dans un rack mal ventilé ou directement au-dessus d'un appareil dégageant de la chaleur comme un amplificateur de puissance. Respectez la température maximale de fonctionnement précisée dans les caractéristiques techniques.
- Les ouvertures dans le boîtier assurent la bonne ventilation de l'appareil, évitent toute surchauffe et assurent le bon fonctionnement du système. Veillez à ne pas obstruer, couvrir ou insérer d'objets dans ces ouvertures. Veillez à ne pas renverser de liquide sur l'appareil.
- Ne reliez jamais directement les sorties audio des amplificateurs de puissance aux connecteurs de l'appareil.
- Afin d'éviter tout risque d'électrocution ou d'incendie, n'exposez pas l'appareil à la pluie ou à l'humidité; ne l'utilisez pas dans des endroits exposés aux projections de liquides.
- N'essayez pas d'utiliser l'appareil si celui-ci est tombé, a été endommagé, exposé à des projections de liquides ou si vous constatez des dysfonctionnements nécessitant l'intervention d'un technicien spécialisé.
- Cet appareil ne doit être ouvert que par un personnel de service qualifié. En enlevant les couvercles vous vous exposez à des tensions électriques dangereuses.



Le symbole de la foudre dans un triangle sert à alerter l'utilisateur sur la présence à l'intérieur de l'appareil de tensions non isolées susceptibles de constituer un risque d'électrocution.



Le point d'exclamation dans un triangle sert à alerter l'utilisateur sur la présence de nombreuses instructions de maintenance dans le manuel fourni avec l'appareil.

IT

ITALIANO

IMPORTANTI NORME DI SICUREZZA

IT

- Conservare le presenti norme per l'utilizzo futuro.
- Seguire sempre tutte le istruzioni e gli avvertimenti segnati sull'unità e nelle istruzioni operative.
- Utilizzare sempre la corretta tensione di alimentazione. Fare riferimento al manuale del costruttore per le caratteristiche di alimentazione. Tensioni di rete diverse necessitano anche di un diverso cavo con spine differenti.
- Non installare l'unità in un rack poco ventilato, o direttamente sopra apparecchiature che producono calore, come amplificatori di potenza. Controllare la massima temperatura ambientale di esercizio sulle specifiche tecniche del prodotto.
- Fori ed aperture nei pannelli sono necessari per garantire un corretta ventilazione e prevenire surriscaldamenti. Queste aperture non devono essere coperte o ostruite. Non inserire oggetti di alcun tipo nei fori di ventilazione. Evitare il contatto con liquidi di qualsiasi genere.
- Evitare di collegare le uscite di un amplificatore di potenza direttamente a qualsiasi connettore dell'unità.
- Per evitare il rischio di scosse elettriche non esporre il prodotto a pioggia o umidità. Evitare l'uso dove possa essere esposto all'acqua.
- Non tentare di utilizzare il prodotto se è caduto, se è stato a contatto con liquidi, o mostra chiari segni di danneggiamento o cambio di prestazioni che indicano la necessità di assistenza tecnica.
- Ogni intervento sull'unità va eseguito esclusivamente da personale qualificato. La rimozione della copertura comporta l'esposizione al pericolo di folgorazione.



Il presente triangolo impresso sul componente avverte la presenza di tensioni pericolose non isolate all'interno della copertura – tali tensioni rappresentano un pericolo di folgorazione.



Il presente triangolo impresso sul componente avverte l'utente della presenza nella documentazione allegata di importanti istruzioni relative al funzionamento ed alla manutenzione.

PT

PORTUGUESE

INSTRUÇÕES IMPORTANTES DE SEGURANÇA

PT

- Guarde essas instruções para uso posterior.
- Siga todas as instruções e fique atento aos avisos marcados na unidade e nas instruções de operação.
- Sempre use com a voltagem correta. Veja no manual de instruções do fabricante qual a alimentação necessária. Lembre-se que voltagens de operação diferentes podem precisar de um cabo ou plug diferentes.
- Não instale a unidade em um suporte sem ventilação ou diretamente acima de equipamentos que produzam calor, como transformadores. Observe a temperatura ambiente máxima de operação indicada na especificação do produto.
- O revestimento da unidade é provido de fendas e aberturas para ventilação – para assegurar uma operação confiável e evitar que a unidade se superaqueça. Não bloqueie, cubra ou insira objetos nas aberturas. Nunca derrube líquido de qualquer espécie na unidade.
- Nunca ligue saídas de amplificadores de áudio diretamente a qualquer dos conectores da unidade.
- Para evitar danos de choque ou fogo, não exponha a unidade à chuva ou umidade, ou opere-a onde haja exposição à água.
- Não tente operar a unidade se ela for derrubada, danificada, exposta a líquidos ou apresente uma mudança de performance notável, indicando a necessidade de manutenção.
- Esta unidade só deveria ser aberta através de pessoal de serviço qualificado. Removendo coberturas o exporão a voltagens perigosas.



Esse triângulo que aparece no seu console, alerta para a presença de voltagem perigosa e não isolada no recinto – voltagem que pode ser suficiente para constituir um risco de choque.



Esse triângulo que aparece no seu console alerta para instruções importantes de operação e manutenção neste manual.



DANSK



VIGTIG INFORMATION OM SIKKERHED

- Gem denne vejledning til senere brug.
- Følg alle anvisninger og advarsler på apparatet.
- Apparatet skal altid tilsluttes den korrekte spænding. Der henvises til brugsanvisningen, der indeholder specifikationer for strømforsyning. Der gøres opmærksom på, at ved varierende driftsspændinger kan det blive nødvendigt at bruge andre lednings- og/eller stiktyper.
- Apparatet må ikke monteres i et kabinet uden ventilation eller lige over andet udstyr, der udvikler varme, f.eks. forstærkere. Den maksimale omgivelsestemperatur ved drift, der står opført i specifikationerne, skal overholdes.
- Der er ventilationsåbninger i kabinettet. For at sikre apparatets drift og hindre overophedning må disse åbninger ikke blokeres eller tildækkes. Stik aldrig noget ind igennem ventilationsåbningerne, og pas på aldrig at spilde nogen form for væske på apparatet.
- Udgangsstik fra audioforstærkere må aldrig sættes direkte i apparatet.
- Apparatet må ikke udsættes for regn eller fugt og må ikke bruges i nærheden af vand for at undgå risiko for elektrisk stød og brand.
- Apparatet må aldrig bruges, hvis det er blevet stødt, beskadiget eller vådt, eller hvis ændringer i ydelsen tyder på, at det trænger til eftersyn.
- Dette apparat må kun åbnes af fagfolk. Hvis dækslet tages af, udsættes man for livsfarlig højspænding.



Denne mærkat på komponenten advarer om uisoleret, farlig spænding i apparatet - høj nok til at give elektrisk stød.



Denne mærkat på komponenten advarer om vigtig driftsog vedligeholdelsesinformation i den tilhørende litteratur.



SUOMI



TÄRKEITÄ TURVALLISUUSOHJEITA

- Säilytä nämä ohjeet tulevaa käyttöä varten.
- Seuraa kaikkia yksikköön merkittyjä ohjeita ja varoituksia.
- Käytä aina oikeaa verkkojännitettä. Tehovaatimukset selviävät valmistajan käyttöohjeista. Huomaa, että eri käyttöjännitteet saattavat vaatia toisenlaisen verkkojohdon ja/tai -pistokkeen käytön.
- Älä asenna yksikköä telineeseen jossa ei ole tuuletusta, tai välittömästi lämpöä tuottavien laitteiden, esim. tehovahvistimien, yläpuolelle. Ympäristön lämpötila käytössä ei saa ylittää tuotespesifikaation maksimilämpötilaa.
- Kotelo on varustettu tuuletusreiillä ja -aukoilla. Luotettavan toiminnan varmistamiseksi ja ylläpitämisen välttämiseksi näitä aukkoja ei saa sulkea tai peittää. Mitään esineitä ei saa työntää tuuletusaukoihin. Mitään nesteitä ei saa kaataa yksikköön.
- Älä kytke audiotehovahvistimen lähtöjä suoraan mihinkään yksikön liittimeen.
- Sähköiskun ja palovaaran välttämiseksi yksikkö ei saa olla sateessa tai kosteassa, eikä sitä saa käyttää märässä ympäristössä.
- Älä käytä yksikköä jos se on pudonnut, vaurioitunut, kostunut, tai jos sen suorituskyky on huomattavasti muuttunut, mikä vaatii huoltoa.
- Yksikön saa avata vain laitteeseen perehtynyt huoltohenkilö. Kansien poisto altistaa sinut vaarallisille jännitteille.



Tämä kolmio, joka esiintyy komponentissasi, varoittaa sinua eristämättömän vaarallisen jännitteen esiintymisestä yksikön sisällä. Tämä jännite saattaa olla riittävän korkea aiheuttamaan sähköiskuvaaran.



Tämä kolmio, joka esiintyy komponentissasi, kertoo sinulle, että tässä tuotedokumentoinnissa esiintyy tärkeitä käyttö- ja ylläpito-ohjeita.



NORSK



VIKTIG INFORMASJON OM SIKKERHET

- Ta vare på denne veiledningen for senere bruk.
- Følg alle anvisningene og advarslene som er angitt på apparatet.
- Apparatet skal alltid anvendes med korrekt spenning. Produktbeskrivelsen inneholder spesifikasjoner for strømkrav. Vær oppmerksom på at det ved ulike driftsspenninger kan være nødvendig å bruke en annen ledning- og/eller støpseltype.
- Apparatet skal ikke monteres i skap uten ventilasjon, eller direkte over varmeproduserende utstyr, som for eksempel kraftforstærkere. Den maksimale romtemperaturen som står oppgitt i produktbeskrivelsen, skal overholdes.
- Apparatet er utstyrt med ventilasjonsåpninger. For at apparatet skal være pålitelig i bruk og ikke veropphetes, må disse åpningene ikke blokkeres eller tildekkes. Stikk aldri noe inn i ventilasjonsåpningene, og pass på at det aldri søles noen form for væske på apparatet.
- Utgangsplugger fra audioforstærkere skal aldri koples direkte til apparatet.
- Unngå brannfare og elektrisk støt ved å sørge for at apparatet ikke utsettes for regn eller fuktighet og ikke anvendes i nærheten av vann.
- Apparatet skal ikke brukes hvis det har blitt utsatt for støt, er skadet eller blitt vått, eller hvis endringer i ytelsen tyder på at det trenger service.
- Dette apparatet skal kun åpnes av fagfolk. Hvis dekslet fjernes, utsettes man for livsfarlig høyspenning.



Komponenten er merket med denne trekanten, som er en advarsel om at det finnes isolert, farlig spenning inne i kabinettet - høy nok til å utgjøre en fare for elektrisk støt.



Komponenten er merket med denne trekanten, som betyr at den tilhørende litteraturen inneholder viktige opplysninger om drift og ved.



SVENSKA



VIKTIGA SÄKERHETSFORESKRIFTER

- Spara dessa föreskrifter för framtida bruk.
- Följ alla anvisningar och varningar som anges på enheten.
- Använd alltid rätt nätspänning. Se tillverkarens bruksanvisningar för information om effektkrav. Märkväl, att andra matningsspänningar eventuellt kräver att en annan typs nätsladd och/eller kontakt används.
- Installera inte enheten i ett oventilerat stativ, eller direkt ovanför utrustningar som avger värme, t ex effektförstärkare. Se till att omgivningens temperatur vid drift inte överskrider det angivna värdet i produktspecifikationen.
- Behållaren är försedd med hål och öppningar för ventilering. För att garantera tillförlitlig funktion och förhindra överhettning får dessa öppningar inte blockeras eller täckas. Inga föremål får skuffas in genom ventilationshålen. Inga vätskor får spillas på enheten.
- Anslut aldrig audioeffektförstärkarutgångar direkt till någon av enhetens kontakter.
- För att undvika elstöt eller brandfara får enheten inte utsättas för regn eller fukt, eller användas på ställen där den blir våt.
- Använd inte enheten om den har fallit i golvet, skadats, blivit våt, eller om dess prestanda förändrats märkbart, vilket kräver service.
- Enheten får öppnas endast av behörig servicepersonal. Farliga spänningar blir tillgängliga när locken tas bort.



Denna triangel, som visas på din komponent, varnar dig om en isolerad farlig spänning inne i enheten. Denna spänning är eventuellt så hög att fara för elstöt föreligger.



Denna triangel, som visas på din komponent, anger att viktiga bruksanvisningar och serviceanvisningar ingår i dokumentationen i fråga.

US Unpacking and Inspection

After unpacking the unit, save all packing materials in case the unit ever needs to be shipped. Thoroughly inspect the modules and packing materials for signs of damage. Report any damage to the carrier at once; report equipment malfunction to the dealer.

DE Auspacken und Überprüfung

Bewahren Sie nach dem Auspacken des Geräts das Verpackungsmaterial für den Fall auf, dass Sie das Gerät wieder versenden müssen. Überprüfen Sie die Module und die Verpackung sorgfältig auf Anzeichen von Beschädigung. Etwaige Schäden sind dem Transporteur unverzüglich anzuzeigen; Funktionsstörungen sind dem zuständigen Händler zu melden.

ES Desembalaje e inspección

Después de desembalar la unidad, guarde todos los materiales de embalaje por si alguna vez transportar la unidad. Inspeccione con atención los módulos y los materiales de embalaje para comprobar que no muestren desperfectos. Informe inmediatamente de cualquier desperfecto al transportista; informe de cualquier problema de funcionamiento del equipo a su distribuidor.

FR Contenu de l'emballage et inspection

Après avoir ouvert l'emballage, conservez-le pour tout retour. Inspectez avec soin les modules et les matériaux d'emballage pour tout signe de dommage. Veuillez rapporter immédiatement les dommages auprès du transporteur. Les dysfonctionnements du matériel doivent être signalés à votre revendeur.

IT Disimballaggio ed ispezione

Dopo aver disimballato l'unità, salvi tutto il materiale d'imballaggio, in caso Lei abbia bisogno di spedire l'unità. Ispezioni attentamente i moduli ed il materiale d'imballaggio per vedere se riportano segni di danno. Riporti subito ogni segno di danno al corriere; riferisca il malfunzionamento dell'attrezzatura al suo rivenditore.

PT Retirando a embalagem e inspecionando

Depois de desembalar a unidade, guarde a embalagem caso precise enviar a unidade para manutenção. Inspeccione cuidadosamente o módulo e a embalagem procurando sinais de dano. Avise à loja qualquer tipo de dano ou mal funcionamento do equipamento.

1

Getting Started

About the SDP-5.	1-2
<i>Highlights • Product Registration</i>	
Installation Considerations.	1-4
Remote Control Battery Installation	1-5

ABOUT THE SDP-5

Thank you for purchasing the SDP-5 Digital Controller, an 8-channel audio and video control center with independent zone monitoring that provides control of audio and video source selection in two zones at the same time. The SDP-5 includes eight configurable inputs, each of which can be assigned to its eight digital audio, eight analog audio, five composite video, five S-video, or three component video input connectors. The analog connectors can be configured for up to two 5.1-channel sources.

Inside and out, the SDP-5 is designed for possible future developments. The rear panel houses one RS-232 connector capable of performing configuration downloads and flash memory software upgrades and another capable of supporting future developments. The rear panel also includes two removable access panels to accommodate connectors for emerging technologies.

More than just an audio and video control center, the SDP-5 offers the latest version of the critically acclaimed LOGIC7® decoding, which creates a 7.1-channel output signal from stereo, 5.1-, and 6.1-channel sources. Unlike other decoders, LOGIC7 decoding is compatible with all input sources and requires no special encoding. Because the improvement it provides is clearly audible, LOGIC7 is widely regarded as the finest available.

In addition to LOGIC7, the SDP-5 offers Dolby Digital Surround EX, Dolby Pro Logic II, Dolby Pro Logic, dts 96/24, dts NEO:6, dts-ES, THX Ultra2, and THX Surround EX decoding. THX Ultra2 Certification guarantees that the SDP-5 meets the highest THX specifications.

With four floating-point SHARC™ digital signal processing (DSP) engines, the SDP-5 boasts enormous processing power. These powerful processors perform custom processing such as LOGIC7 decoding, bass enhancement, dialog enhancement, auto azimuth, 5-speaker enhancement, bass management, high-precision digital crossovers, and audio controls. These features are available at sample rates up to 96kHz, with 24-bit resolution to retain top performance from all sources. In addition, a fifth DSP engine is dedicated to decoding multi-channel compressed audio sources.

The SDP-5 is one of the most advanced audio and video control centers available. High-precision 24-bit/96kHz A/D converters can be used to convert stereo analog audio input signals to digital signals, allowing the SDP-5 to provide the benefits of precise digital signal processing without sacrificing signal integrity. Alternatively, stereo analog signals can bypass A/D conversion and internal processing, following a pure signal path directly to the output connectors.

Digital audio input signals are processed through a two-stage phase lock loop for extremely low intrinsic jitter and high rejection. Auto azimuth technology corrects timing and level imbalances in stereo sources, ensuring exceptionally accurate playback of surround-encoded sources. A digital audio pass-through output is available for recording digital signals with a CD recorder or a similar component.

Complementing its audio performance, the SDP-5 features two broadcast-quality video switchers. A wide-bandwidth component video switcher accepts analog component or RGB video signals, while a composite and S-video switcher accepts high-quality NTSC, PAL, or SECAM video signals. The component video switcher can pass High-Definition TV (HDTV) signals, as well as Standard-Definition TV signals. Both switchers are designed to pass video signals without alteration or degradation.

Built to professional standards, the SDP-5 is designed to serve as the control center in any high-quality home theater. Even the most demanding enthusiast will be impressed with its unique combination of power, performance, flexibility, and technological sophistication. With extensive expansion capabilities, the SDP-5 represents a solid investment that will retain its value in the face of rapidly emerging technologies.

HIGHLIGHTS

- 8 channels
- 8 configurable inputs
- 2 independent zones
- 4 S/PDIF coaxial and 4 S/PDIF optical (Toslink) digital audio input connectors
- 24-bit/192kHz D/A converters for all audio channels
- Up to two 5.1-channel analog audio input connectors
- Analog bypass option for stereo audio input connectors
- Auto switching between digital and analog audio input connectors
- 3 component video input connectors with full HDTV compatibility
- 5 S-video input connectors
- 5 composite video input connectors
- Four 32-bit DSP engines
- Separate DSP engine for decoding compressed audio sources
- Broadcast-quality video switching
- LOGIC7 decoding
- Dolby Digital Surround EX, Dolby Pro Logic II, and Dolby Pro Logic decoding
- dts 96/24, dts-ES (discrete and matrix), and dts NEO:6 decoding
- THX Ultra2 and THX Surround EX decoding
- THX Ultra2 Certification
- Flash memory software upgrade capabilities
- 2 internal expansion slots for future possibilities
- Digital audio output connector
- RS-232 control
- Rear panel IR input connector
- 2 trigger output connectors
- 19-inch rack-mount kit

INSTALLATION CONSIDERATIONS

The SDP-5 requires special care during installation to ensure optimal performance. Pay particular attention to the bulleted items that begin below and to other precautions that appear throughout this user guide.

Do . . .

- Install the SDP-5 on a solid, flat, level surface such as a table or shelf or in a standard 19-inch equipment rack using the enclosed rack-mount kit.
- Select a dry, well-ventilated location out of direct sunlight.

Do Not . . .

- Install the SDP-5 on a surface that is unstable or unable to support all four of its feet, unless it is installed in an equipment rack.
- Stack the SDP-5 directly above heat-producing equipment such as power amplifiers or other components that generate heat during use.
- Expose the SDP-5 to high temperatures, humidity, steam, smoke, dampness, or excessive dust. Avoid installing the SDP-5 near radiators and other heat-producing appliances.
- Install the SDP-5 near unshielded TV or FM antennas, cable TV decoders, and other RF-emitting devices that might cause interference.

Do Not . . .

- Place the SDP-5 on a thick rug or carpet or cover the SDP-5 with a cloth, as this might prevent proper cooling.
- Place the SDP-5 on a windowsill or in another location in which it will be exposed to direct sunlight.
- Obstruct the front panel IR receiver window shown on page 2-3. The remote control must be in line of sight with the IR receiver for proper operation. Refer to page 2-9 for more information about remote control operation considerations.

CAUTION

Before moving the SDP-5, make sure it is powered off with the rear panel power switch. Then, make sure the power cord is unplugged from the wall outlet.

REMOTE CONTROL BATTERY INSTALLATION

The remote control requires two AA batteries that should be replaced as needed. It is recommended to use Alkaline batteries, which last longer without leaking. When the batteries are low on power, the remote control enters a low-voltage condition that prevents it from operating the SDP-5. When this occurs, follow the instructions below to replace the batteries. Normal operation will resume when the new batteries are installed.

To replace the remote control batteries:

1. Locate the battery compartment on the back of the remote control. Then, remove the battery compartment cover as shown in the figure below (left). To do this, press the tab attached to the cover. When the tab is pressed, pull the cover away from the remote control.
2. Remove old batteries inserted in the compartment (if applicable).
3. Insert two AA batteries in the compartment as shown in the figure below (center). Make sure the batteries are correctly inserted observing the proper polarity.
4. When new batteries have been installed, close the battery compartment cover as shown in the figure below (right). To do this, align the cover with the guide on the back of the remote control. When the cover is aligned, press the cover until it "snaps" into place.
5. Dispose of the old batteries (if applicable).

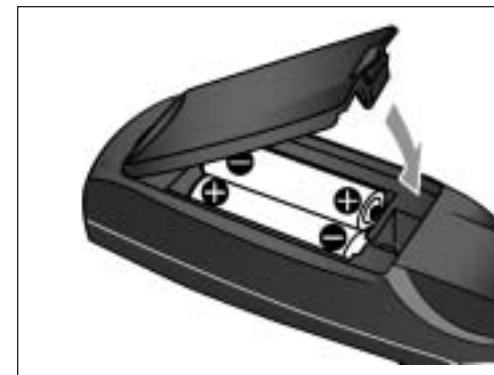
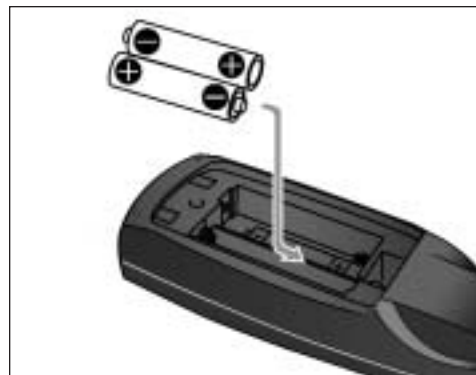
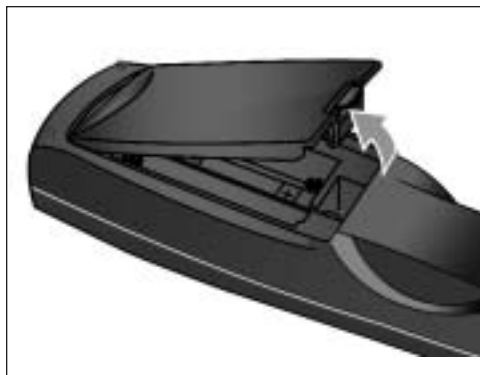

2

Basic Operation

Front Panel Overview	2-2
Rear Panel Overview	2-5
Remote Control Overview	2-9
<i>Operation Considerations • MAIN MENU • Menu Navigation • Menu Item Selection • Command Bank Activation • Command Matrix</i>	
Understanding the Zones	2-17
Two-Line Status	2-18
STATUS Menus	2-18
<i>2CH STATUS • DOLBY D STATUS • dts(-ES) STATUS • 5.1a BYPASS STATUS • 2CH BYPASS STATUS • DIGITAL STATUS</i>	
STATUS Menu Parameter Descriptions	2-23
<i>STATUS Menu Level Meters</i>	

FRONT PANEL OVERVIEW

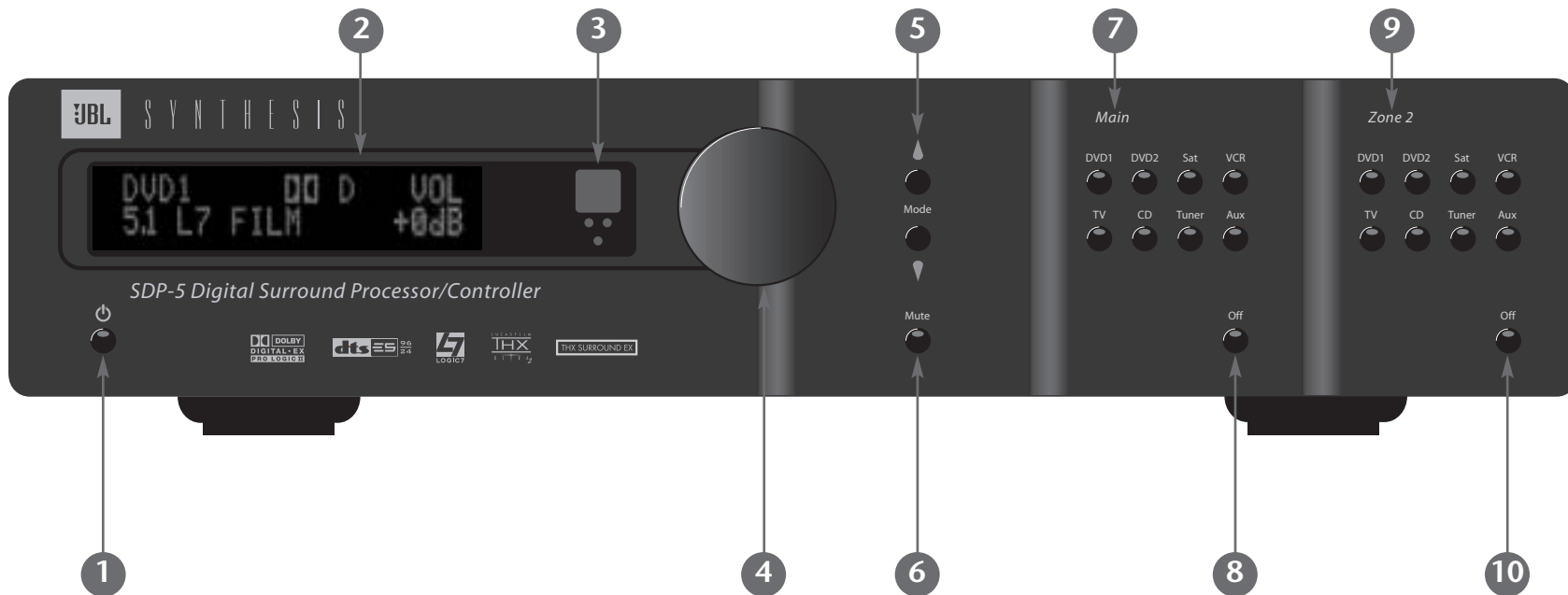

1. Standby Button

Activates and deactivates standby mode when the SDP-5 is powered on with the rear panel power switch (2-5). The standby button performs no function when the SDP-5 is powered off with the rear panel power switch.

When standby mode is activated, pressing the standby button deactivates standby mode and activates the SDP-5, including all zones that were activated during the previous operating session. When standby mode is deactivated, pressing the

standby button activates standby mode and deactivates the SDP-5. The red standby button LED lights to indicate that standby mode is activated.

2. Front Panel Display

Indicates the current input, listening mode, input source, and volume level as shown above. This 2 x 20 character display can also be used to view messages and menus, one line at a time. Refer to the Menu Navigation section that begins on page 2-9 for more information.

3. IR Receiver

Receives infrared commands from the SDP-5 remote control (2-9). There are three LEDs located in this area as shown at the right. An amber LED blinks when a remote control command is received. A red LED lights when the A/D converters are overloading. And, a blue LED lights when the SDP-5 is powered on and activated – even if the FRONT PANEL DISPLAY menu STATUS parameter is set to ALWAYS OFF (3-52).

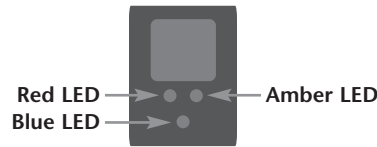

4. Volume Knob

Adjusts volume level in the Main Zone or Zone 2.

Note:

When SDP-5 output levels have been properly calibrated (3-39), the +0dB volume level setting corresponds to THX reference levels (75dB).

To use the volume knob to adjust Main Zone volume level:

Rotate the volume knob clockwise to increase or counterclockwise to decrease volume level in 1dB increments. The horizontal bar graph (2-10) shown at the right appears on the on-screen and front panel displays. This graph illustrates the position at which the current Main Zone volume level falls within the –80 to +12dB volume range.



To use the volume knob to adjust Zone 2 volume level:

1. Press and hold the front panel Zone 2 input selection button that corresponds with the current input source. For instance, if the current input source is using the DVD1 input, press and hold the Zone 2 DVD1 input selection button.
2. While holding the selected Zone 2 input selection button, rotate the volume knob clockwise to increase or counterclockwise to decrease volume level in 1dB increments. The horizontal bar graph (2-10) shown at the right appears on the on-screen and front panel displays. This graph illustrates the position at which the current Zone 2 volume level falls within the –80 to +12dB volume range.
3. Release the selected Zone 2 input selection button when Zone 2 volume level has been set.



Note:

Remote control input selection buttons cannot be used to select Zone 2 volume level adjustment, even if the Zone 2 command bank is activated.

5. Mode ▲ and ▼ Buttons

Scroll to the previous (▲) and the next (▼) available listening mode. Scrolling occurs in the order shown on the MODE ADJUST menu (5-2). Refer to the Listening Mode Activation section that begins on page 5-2 for more information.

... Front Panel Overview continues on page 2-4

Front Panel Overview (continued from page 2-3)

6. Mute Button

Mutes Main Zone volume level and restores Main Zone volume to its original level. Pressing the Mute button the first time lowers Main Zone volume level. The message "MUTE ON" appears on the on-screen and front panel displays. Pressing the Mute button again restores Main Zone volume to its original level. Refer to page 3-53 for information about using the MUTE LEVEL parameter to set mute levels.

The amber Mute button LED lights whenever mute is activated, whether activated automatically or manually. For instance, the SDP-5 briefly activates mute when changing input sources or listening modes.

7. Main Zone Input Selection Buttons

Selects the input in the Main Zone. When an input is selected, a blue LED lights on the corresponding input selection button. When the Main Zone is deactivated, pressing a Main Zone input selection button activates the Main Zone and selects the corresponding input. Zone 2 remains deactivated until a Zone 2 input is selected.

8. Main Zone Off Button

Deactivates the Main Zone.

9. Zone 2 Input Selection Buttons

Selects the input in Zone 2. When an input is selected, an amber LED lights on the corresponding input selection button. When Zone 2 is deactivated, pressing a Zone 2 input selection button activates Zone 2 and selects the corresponding input. The Main Zone remains deactivated until a Main Zone input is selected.

10. Zone 2 Off Button

Deactivates Zone 2.

REAR PANEL OVERVIEW

Note:

The numbered items that begin below correspond to the rear panel illustration on the next page.

1. Power Switch

Connects power to the AC input connector and disconnects power from the AC input connector. The \bigcirc represents the "off" position and the | represents the "on" position. When the SDP-5 is powered on, the front panel standby button or remote control On button can be used to activate and deactivate standby mode. When the SDP-5 is powered off, standby mode is not available.

2. AC Input Connector

Provides power to the SDP-5 through the supplied power cord (3 wire, 10 amp, IEC 320).

3. Digital Audio Input Connectors (S/PDIF)

Provide digital audio input in the Main Zone. Four S/PDIF coaxial and four S/PDIF optical (Toslink) input connectors are available. These connectors are compatible with PCM (44.1, 48, 88.2, and 96kHz), Dolby Digital, and dts(-ES) sources. These connectors are not compatible with MPEG (MP3) sources.

4. Digital Audio Output Connector (S/PDIF)

Provides digital audio output in Zone 2. One S/PDIF coaxial connector is available.

5. Analog Audio Input Connectors

Provide analog audio input in the Main Zone and Zone 2. Eight stereo analog audio input connectors labeled 1 to 8 are available. The connectors labeled 3, 4, and 5 and 6, 7, and 8 can be configured as 5.1-channel connectors. When a 5.1-channel analog audio source is present in the Main Zone, input signals are sent to the Main Zone audio output connectors as indicated below. When a 5.1-channel analog source is present in the Main Zone and the INPUT SETUP menu ZONE2 IN parameter is set to DMIX, only the (L) and (R) input signals are sent to the Zone 2 audio output connectors. Refer to page 3-45 for more information.

Input Connector	Output Connector
(L)	Front L
(R)	Front R
(C)	Center
(SUB)	Subwoofer
(LS)	Side L and Rear L
(RS)	Side R and Rear R

6. Main Zone Audio Output Connectors

Provide analog audio output in the Main Zone. Eight connectors labeled Front L/R, Center, Subwoofer, Side L/R, and Rear L/R are available.

... Rear Panel Overview continues on page 2-6

Rear Panel Overview (continued from page 2-5)

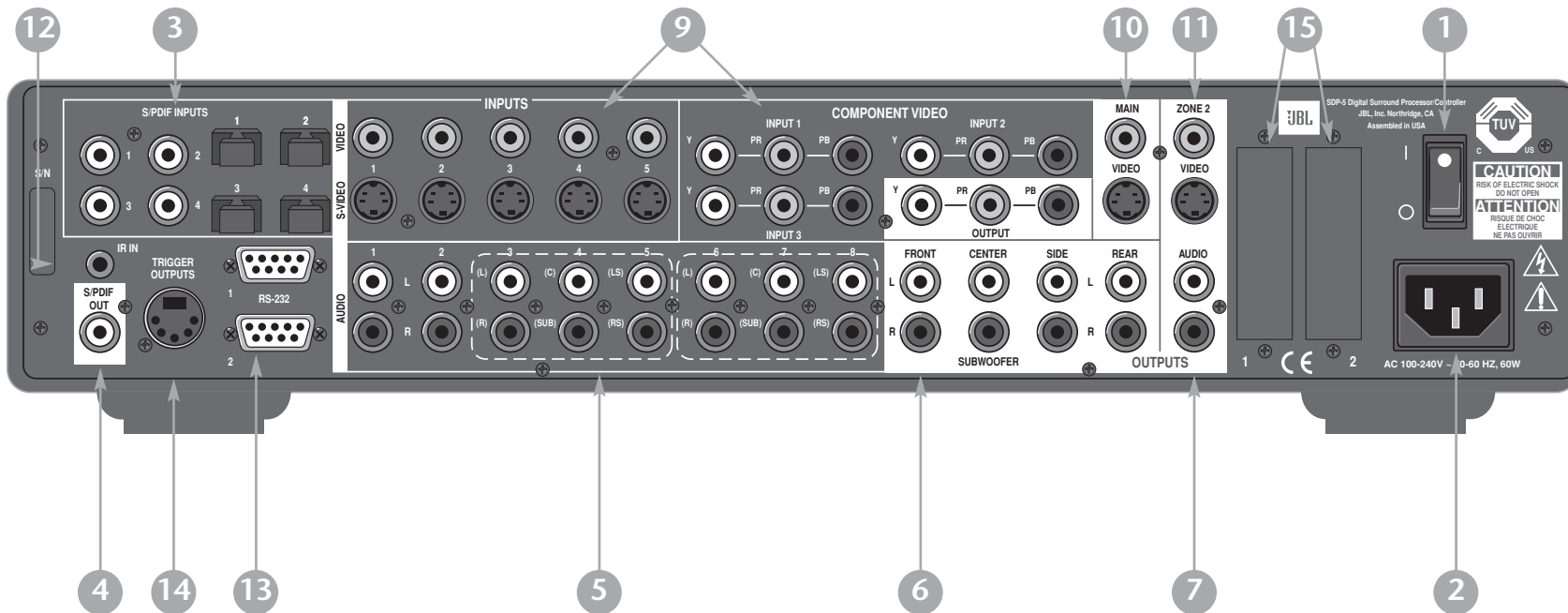

CAUTION Never make or break connections to the SDP-5 unless the SDP-5 and all associated components are powered off.

7. Zone 2 Audio Output Connectors

Provide analog audio output in Zone 2. Two connectors labeled Audio are available. Alternatively, these connectors can be used to connect a recording device. When the Zone 2 audio output connectors are sent to a recording device, it is recommended to set the VOLUME CONTROL SETUP menu ZONE PWR ON parameter to +0dB to achieve appropriate

recording levels. The Zone 2 audio output connectors provide variable output levels. Adjusting Zone 2 volume level will affect the recording.

9. Video Input Connectors

Provide video input in the Main Zone and Zone 2. Five composite video connectors labeled Video 1 to 5, five S-video connectors labeled S-Video 1 to 5, and three component video connectors labeled 1 to 3 are available. **The component video connectors are not available for Zone 2.**

10. Main Zone Video Output Connectors

Provide video output in the Main Zone. One composite video connector, one S-video connector, and one component video connector are available.

11. Zone 2 Video Output Connectors

Provide video output in Zone 2. One composite video connector and one S-video connector are available. Alternatively, these connectors can be used to connect a video recording device.

Note:

- Composite video output connectors are available when a composite or S-video source is present.
 - S-video output connectors are available when an S-video source is present.
 - Component video output connectors are available when a component video source is present.
-

12. IR IN Connector

Accepts input of IR signals from infrared distribution equipment. One 3.5mm jack that accepts a stereo plug (Tip/Ring connection) or mono plug (Tip/Sleeve connection) is available.

13. RS-232 Connectors

The RS-232 connector labeled 1 provides serial control. It is capable of performing configuration downloads and flash memory software upgrades. The RS-232 connector labeled 2 is capable of supporting future developments.

14. Trigger Output Connectors

Provide 12V DC output to control connected components. Two trigger output connectors are available on a 5-pin DIN connector. The connector labeled PWR – the power trigger output connector – is not configurable. It is activated when the SDP-5 is activated, and deactivated when the SDP-5 is deactivated. The trigger output connector labeled 1 can be configured for remote or program operation. Refer to page 3-54 for more information.

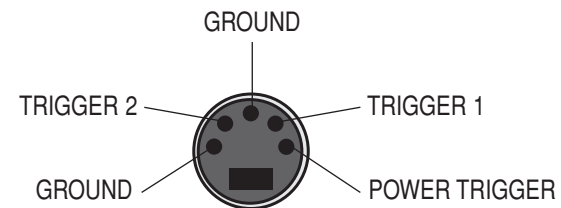

Note:

The default trigger configuration shown on page 3-55 includes settings designed for use in JBL Synthesis systems with switching transducers for listening modes.

15. Removable Access Panels

Accommodate connectors for emerging technologies.

REMOTE CONTROL OVERVIEW

The SDP-5 remote control provides full operation of the SDP-5, performing commands such as menu navigation that are not available from the front panel. The command matrix that begins on page 2-13 indicates the commands remote control buttons perform when each command bank is active. The numbered items in the matrix correspond with the remote control illustrations on pages 2-13 to 2-16.

OPERATION CONSIDERATIONS

The bulleted items that begin below describe factors that can improve or impede remote control operation. It is recommended to observe these items as well as the battery installation instructions on page 1-5 before operating the remote control.

Please note the following before operating the SDP-5 remote control:

- The remote control must be in line-of-sight with the front panel IR receiver (2-3). Eliminate obstructions between the remote control and the IR receiver. The remote control might become unreliable if strong sunlight or fluorescent light is shining on the IR receiver.
- For optimal performance, position the remote control at a 30 degree angle no more than 17 feet (5m) from the SDP-5. If the SDP-5 is placed inside a glass cabinet, smoked glass will reduce the remote control range.
- Remote controllers for different components can interfere with one another. It is recommended to avoid using remote controls for different components at the same time.
- The remote control batteries should be replaced as needed. Refer to page 1-5 for battery installation instructions.

MAIN MENU

The MAIN MENU shown at the right represents the beginning of the menu structure. It can be used to open the three main menu branches: MODE ADJUST, AUDIO CONTROLS, and SETUP. Refer to Sections 5, 4, and 3 for information about these menu branches.



Refer to the Menu Navigation table on the next page for instructions to open and close the MAIN MENU.

MENU NAVIGATION

The remote control Menu arrows must be used to navigate the extensive menu structure shown in the Appendix (A-4 to A-13). The table on the next page indicates the navigation functions remote control Menu arrows perform when the Main Zone command bank is activated.

MENU ITEM SELECTION

The remote control Menu arrows must be used to select menu items.

To select a menu item on the open menu:

1. Press the remote control Menu ▲ and ▼ arrows to highlight the desired menu item.
2. When the desired menu item is highlighted, press the Menu ► arrow to select the highlighted item. If an option is selected, another menu will open. If a parameter is selected, a parameter drop-down menu will open.

Arrow	Navigation Function(s)
▶	<ul style="list-style-type: none"> When a menu is open, pressing the Menu ▶ arrow selects the highlighted menu item, which opens another menu, opens a parameter drop-down menu, or selects the highlighted parameter setting. When no menus are open, pressing the Menu ▶ arrow opens the MAIN MENU (2-9).
◀	<ul style="list-style-type: none"> When a menu is open, pressing the Menu ◀ arrow closes the menu and, in most cases, opens the previous menu. Subsequent presses continue to close the current menu and open the previous menu until the MAIN MENU (2-9) is closed. When the MAIN MENU is closed, the menu structure is also closed. When no menus are open, pressing the Menu ◀ arrow performs no function. When a parameter drop-down menu (next page) is open, pressing the Menu ◀ arrow selects the current setting and closes the drop-down menu.
▲ ▼	<ul style="list-style-type: none"> When a menu is open, pressing the Menu ▲ and ▼ arrows scrolls upward (▲) and downward (▼) through the complete list of menu items. The highlighted menu item appears on the front panel display. All menu items appear on the on-screen display. A scroll bar appears on the right side of the on-screen display when menu items exceed the on-screen display top and bottom margins. The cursor automatically wraps to the next menu item when the first or last menu item is passed.

Menu Options

Selecting a menu option opens another menu within the menu structure. For instance, selecting the MAIN MENU SETUP option opens the SETUP menu as shown below.

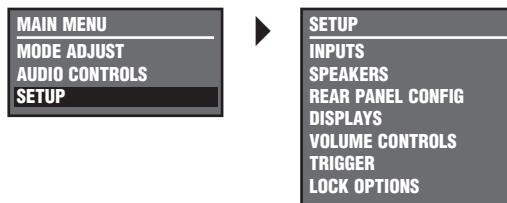

Menu Parameters

Selecting a menu parameter opens a drop-down menu or horizontal bar graph that can be used to select the desired setting.

Parameter Drop-Down Menus

Selecting some menu parameters opens a drop-down menu that contains a list of available parameter settings. For instance, selecting the DISPLAY SETUP menu CUSTOM NAME parameter (3-48) opens the drop-down menu shown below, which can be used to select the ON or OFF setting.

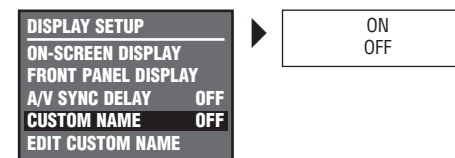

To select the desired setting on a parameter drop-down menu:

1. When the drop-down menu opens, press the remote control Menu \blacktriangle and \blacktriangledown arrows to scroll upward and downward through the complete list of available settings. The current setting appears beneath the parameter name on the on-screen and front panel displays.
2. When the desired setting appears beneath the parameter name, press the Menu \blacktriangleleft arrow to select the setting and close the drop-down menu.

Horizontal Bar Graphs

Selecting some menu parameters opens a horizontal bar graph, which indicates the position at which the current parameter setting falls within the entire parameter range. The current setting appears at the right of the parameter name on the on-screen and front panel displays.

For instance, selecting the DISPLAY SETUP menu A/V SYNC DELAY parameter opens the horizontal bar graph shown below, which can be used to adjust the amount of audio delay.

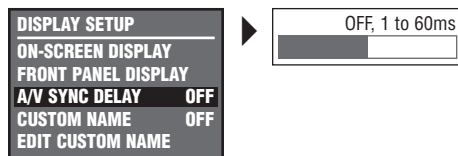
**To adjust a parameter setting with a horizontal bar graph:**

1. When the horizontal bar graph appears, press the remote control Menu \blacktriangle and \blacktriangledown arrows to increase and decrease the setting in designated increments. The current setting appears at the right of the parameter name on the on-screen and front panel displays.
2. When the desired adjustments have been made, press the Menu \blacktriangleleft arrow to select the setting and close the horizontal bar graph.

Note:

Menu item selection instructions differ for certain menus. These instances are noted throughout this user guide.

COMMAND BANK ACTIVATION

Remote control buttons perform different commands depending on whether the Main Zone, Zone 2, or Shift command bank is activated. The Main Zone command bank does not need to be activated. It remains activated unless the Zone 2 or Shift command bank is activated. Pressing and holding the remote control Zone 2 button activates the Zone 2 command bank, and pressing and holding the remote control Shift button activates the Shift command bank.

The Zone 2 and Shift buttons themselves do not send commands to the SDP-5. When pressed and held, these buttons activate the associated command bank. For instance, pressing the remote control Off button deactivates the SDP-5. Pressing and holding the Zone 2 button while pressing the Off button deactivates Zone 2. And, pressing and holding the Shift button while pressing the Off button deactivates the Main Zone.

To activate the Zone 2 or Shift command bank:

1. Press and hold the remote control Zone 2 button to activate the Zone 2 command bank or press and hold the Shift button to activate the Shift command bank.
2. While holding the selected button, press the desired remote control button to send the associated command to the SDP-5. The command matrix that begins on the next page describes the commands remote control buttons perform when each command bank is active.
3. Release the Zone 2 or Shift button to deactivate the associated command bank.

The ON-SCREEN DISPLAY menu REMOTE STATE parameter (3-51) controls the remote control command bank indicator that appears on the on-screen display. When the REMOTE STATE parameter is set to ON, a command bank indicator appears in the top-right corner of the on-screen display to indicate the last command bank from which the SDP-5 received a command. When the REMOTE STATE parameter is set to OFF, no command bank indicator appears on the on-screen display.

A "Z" appears when a command from the Zone 2 command bank was received last. An "S" appears when a command from the Shift command bank was received last. No letter appears when a command from the Main Zone command bank was received last.

COMMAND MATRIX

The command matrix that begins on the next page describes the commands remote control buttons perform when each command bank is active. The numbers in the SDP-5 remote control illustrations that also begin on the next page correspond to the numbered items in the matrix.



Button	Main Zone	Zone 2	Shift
1	Deactivates standby mode and activates the SDP-5.	Reserved for future possibilities.	Reserved for future possibilities.
2	Activates standby mode and deactivates the SDP-5.	Deactivates Zone 2.	Deactivates the Main Zone.
3	Toggles the FRONT PANEL DISPLAY menu STATUS parameter between ALWAYS OFF and its current setting (3-52).	Centers the AUDIO CONTROLS menu ZONE2 BALANCE parameter (4-6).	Centers the AUDIO CONTROLS menu Main Zone BALANCE and FADER parameters (4-6).
4	Toggles the ON-SCREEN DISPLAY menu BACKGROUND parameter between ON and OFF (3-51).	Sets the AUDIO CONTROLS menu BASS, TREBLE, and TILT EQ parameters to +0.0dB (4-2 and 4-4).	Deactivates the trigger output connector labeled 1 when the connector is configured for remote operation (3-54).
5	Toggles the ON-SCREEN DISPLAY menu STATUS parameter between ALWAYS OFF and its current setting (3-49).	Reserved for future possibilities.	Activates the trigger output connector labeled 1 when the connector configured for remote operation (3-54).
6	Displays the Main Zone two-line status for 2 seconds (2-18).	Displays the Zone 2 two-line status for 2 seconds (2-18).	Toggles between opening and closing the STATUS menu for the current input source (2-18).
7	Activates an additional bank of commands that control the Main Zone. Refer to the previous page for more information.		
8	Activates a bank of commands that control Zone 2. Refer to the previous page for more information.		

The numbers in the SDP-5 remote control illustration shown at the left correspond to the numbered items in the matrix above.



Button	Main Zone	Zone 2	Shift
9 ▲ ▼	Scroll upward (▲) and downward (▼) through menu items (2-10).	Increase (▲) and decrease (▼) the output level of the Main Zone audio output connector labeled Subwoofer as applied to the activated listening mode (2-7).	Adjust the AUDIO CONTROLS menu Main Zone FADER parameter forward (▲) and backward (▼) (4-6).
10 ◀	Closes the current menu (2-10).	Adjusts the AUDIO CONTROLS menu ZONE2 BALANCE parameter left (4-6).	Adjusts the AUDIO CONTROLS menu Main Zone BALANCE parameter left (4-6).
11 ▶	Opens the menu structure and selects the highlighted menu item (2-10).	Adjusts the AUDIO CONTROLS menu ZONE2 BALANCE parameter right (4-6).	Adjusts the AUDIO CONTROLS menu Main Zone BALANCE parameter right (4-6).
12 Light	Activates the remote control backlight, making remote control buttons more visible in the dark.		
13 Mode	Scrolls to the previous (▲) and the next (▼) available Main Zone listening mode (5-3).	Sets Zone 2 volume level to -15dB (▲) or -30dB (▼).	Sets Main Zone volume level to -15dB (▲) or -30dB (▼).
14 Volume	Increases (▲) and decreases (▼) Main Zone volume level in 1dB increments.	Increases (▲) and decreases (▼) Zone 2 volume level in 1dB increments.	Increases (▲) and decreases (▼) Main Zone volume level in 3dB increments.
15 Mute	Toggles between lowering Main Zone volume level and restoring Main Zone volume to its original level (3-53).	Toggles between fully muting Zone 2 volume level and restoring Zone 2 volume to its original level.	Toggles between fully muting Main Zone volume level and restoring Main Zone volume to its original level.









The numbers in the SDP-5 remote control illustration shown at the left correspond to the numbered items in the matrix above.



Button	Main Zone	Zone 2	Shift
16 DVD1	Selects the DVD1 input for the Main Zone.	Selects the DVD1 input for Zone 2.	Increases the AUDIO CONTROLS menu BASS parameter in 0.5dB increments (4-2).
DVD2	Selects the DVD2 input for the Main Zone.	Selects the DVD2 input for Zone 2.	Increases the AUDIO CONTROLS menu TREBLE parameter in 0.5dB increments (4-2).
Sat	Selects the Sat input for the Main Zone.	Selects the Sat input for Zone 2.	Increases the AUDIO CONTROLS menu TILT EQ parameter in 0.2dB increments (4-4).
VCR	Selects the VCR input for the Main Zone.	Selects the VCR input for Zone 2.	Sets the AUDIO CONTROLS menu LOUDNESS parameter to ON (4-4).
TV	Selects the TV input for the Main Zone.	Selects the TV input for Zone 2.	Decreases the AUDIO CONTROLS menu BASS parameter in 0.5dB increments (4-2).
CD	Selects the CD input for the Main Zone.	Selects the CD input for Zone 2.	Decreases the AUDIO CONTROLS menu TREBLE parameter in 0.5dB increments (4-2).
Tuner	Selects the Tuner input for the Main Zone.	Selects the Tuner input for Zone 2.	Decreases the AUDIO CONTROLS menu TILT EQ parameter in 0.2dB increments (4-4).
Aux	Selects the Aux input for the Main Zone.	Selects the Aux input for Zone 2.	Sets the AUDIO CONTROLS menu LOUDNESS parameter to OFF (4-4).

The numbers in the SDP-5 remote control illustration shown at the left correspond to the numbered items in the matrix above.



Button	Main Zone	Zone 2	Shift	
17 	Selects the LOGIC7 Film mode family for the current input source (5-3).	Reserved for future possibilities.	Selects the PANORAMA listening mode (5-11).	
		Selects the Dolby mode family for the current input source (5-3).	Reserved for future possibilities.	Refer to the next page.
		Selects the dts(-ES) mode family for the current input source (5-3).	Reserved for future possibilities.	Refer to the next page.
		Selects the THX mode family for the current input source (5-3).	Reserved for future possibilities.	Refer to the next page.
		Selects the LOGIC7 Music mode family for the current input source (5-3).	Reserved for future possibilities.	Selects the L7 MUSIC SURR listening mode (5-5).
		Selects the LOGIC7 TV mode family for the current input source (5-3).	Reserved for future possibilities.	Selects the MONO LOGIC listening mode (5-14) for 2-channel input sources and the 5.1 MONO LOGIC listening mode (5-20) for 5.1-channel input sources.
18 	Toggles between 7- and 5-channel playback. Refer to page 3-34 for more information.	Reserved for future possibilities.	Adjusts the MAIN ADV menu INPUT SELECT parameter, cycling through the ANALOG, DIGITAL, and AUTO settings (3-18).	
19 	Toggles between the activated listening mode and the 2-CHANNEL listening mode (5-13).	Reserved for future possibilities.	Toggles the MAIN ADV menu 2-CH ANLG BYP parameter between ON and OFF (3-20).	

The numbers in the SDP-5 remote control illustration shown at the left correspond to the numbered items in the matrix above.

Shift-DOLBY

- When the Shift command bank is activated, pressing the remote control DOLBY button while a 5.1-channel Dolby Digital input source is present activates the DOLBY DIGITAL EX or DOLBY DIGITAL listening mode. Subsequent presses toggle the EX DECODING parameter, cycling through the AUTO, ON, and OFF settings.

Shift-dts

- When the Shift command bank is activated, pressing the remote control dts button while a dts(-ES) input source is present toggles the ES DECODING parameter, cycling through the AUTO, ON, and OFF settings.

Shift-THX

- When the Shift command bank is activated, pressing the remote control THX button while a 5.1-channel Dolby Digital input source is present activates the 5.1 THX, 5.1 THX ULTRA2, or 5.1 THX SurEX listening mode. Refer to page 5-17 for more information.

UNDERSTANDING THE ZONES

The SDP-5 features two zones of operation, called the Main Zone and Zone 2. The Main Zone controls audio and video sources in the primary listening space. Zone 2 controls audio and video sources in the secondary listening space.

The Main Zone and Zone 2 have separate digital audio receivers and dedicated analog input source selectors that allow for independent input selection in each zone. For instance, the SDP-5 can play a DVD in the Main Zone and a CD in Zone 2 at the same time.

The following are exceptions to independent zone operation:

1. The same Dolby Digital or dts(-ES) input source can be selected for the Main Zone and Zone 2 at the same time. However, different Dolby Digital or dts(-ES) input sources cannot be present in both zones at the same time.
2. Zone 2 can provide a 2-channel downmix of Main Zone multi-channel audio when all of the following conditions are met:
 - The same input must be selected in the Main Zone and Zone 2.
 - A Dolby Digital or dts(-ES) input source must be present in the Main Zone.
 - The INPUT SETUP menu ZONE2 IN parameter must be set to DMIX (3-24).
3. The Zone 2 audio output connectors are not available when the 5.1a BYPASS listening mode is activated in the Main Zone and the ZONE2 IN parameter is set to ANLG. However, it is possible to have a 5.1-channel analog input source present in the Main Zone and a digital input source present in Zone 2.

TWO-LINE STATUS

The two-line status provides information about the zone from which the SDP-5 last detected a change in status. The Main Zone two-line status appears when the SDP-5 detects a Main Zone change, and the Zone 2 two-line status appears when the SDP-5 detects a Zone 2 change.

The ON-SCREEN DISPLAY menu STATUS (3-49) parameter can be used to control the length of time for which the two-line status appears on the on-screen display. The ON-SCREEN DISPLAY menu POSITION parameter (3-50) can be used to control the position of the two-line status on the on-screen display.

Note:

When the display device is connected to a component video output connector and the MAIN ADV menu COMPONENT OSD parameter (3-23) is set to OFF, the display device does not show the on-screen display, including the two-line status.

Main Zone Two-Line Status

The Main Zone two-line status shown at the right indicates the current input, listening mode, input source, and volume level selected in the Main Zone. It appears on the on-screen and front panel displays when the SDP-5 detects a Main Zone change.



Zone 2 Two-Line Status

The Zone 2 two-line status shown at the right indicates the current input, input source, and volume level selected in Zone 2. It appears on the on-screen and front panel displays when the SDP-5 detects a Zone 2 change.



STATUS MENUS

When the Shift command bank is activated, pressing the remote control Stat button opens the STATUS menu for the current input source, which contains parameters that provide information about the current input source and listening mode. STATUS menus are available for 2-channel, Dolby Digital, dts(-ES), and analog input sources.

Unlike most other menus, STATUS menus cannot be opened through the selection of menu options. Rather, the remote control Shift, Stat command must be performed.

To open and navigate the STATUS menu for the current input source:

1. Press and hold the remote control Shift button.
2. While holding the Shift button, press the remote control Stat button. The first page of the STATUS menu for the current input source will appear on the on-screen and front panel displays.

If the STATUS menu includes a second page, the PG1 indicator appears in the top-right corner of the menu. While the Shift command bank is activated, press the Stat button to open the second page. If the STATUS menu does not include a second page, pressing the Stat button closes the menu. If this occurs, begin again with step 1.

- When the desired STATUS menu page has been opened, release the Shift button to deactivate the Shift command bank. Then, press the remote control Menu \blacktriangle and \blacktriangledown arrows to scroll upward and downward through the complete list of parameters available on the current page. **When the Shift command bank is activated, the Menu arrows cannot be used to scroll through STATUS menu parameters.**

Note:

STATUS menu parameters provide information about the current input source and listening mode. These parameters cannot be adjusted.

- Press the Stat button or the Menu \blacktriangleleft arrow to close the STATUS menu. If the second page of the STATUS menu opens, press the Stat button or the Menu \blacktriangleleft arrow again to close the STATUS menu.

All STATUS menus are shown at the right. STATUS menu descriptions begin on the next page. The table beneath each description lists the default and possible settings for each parameter. STATUS menu parameter descriptions begin on page 2-22. STATUS menu level meters are described on page 2-23.

STATUS menus

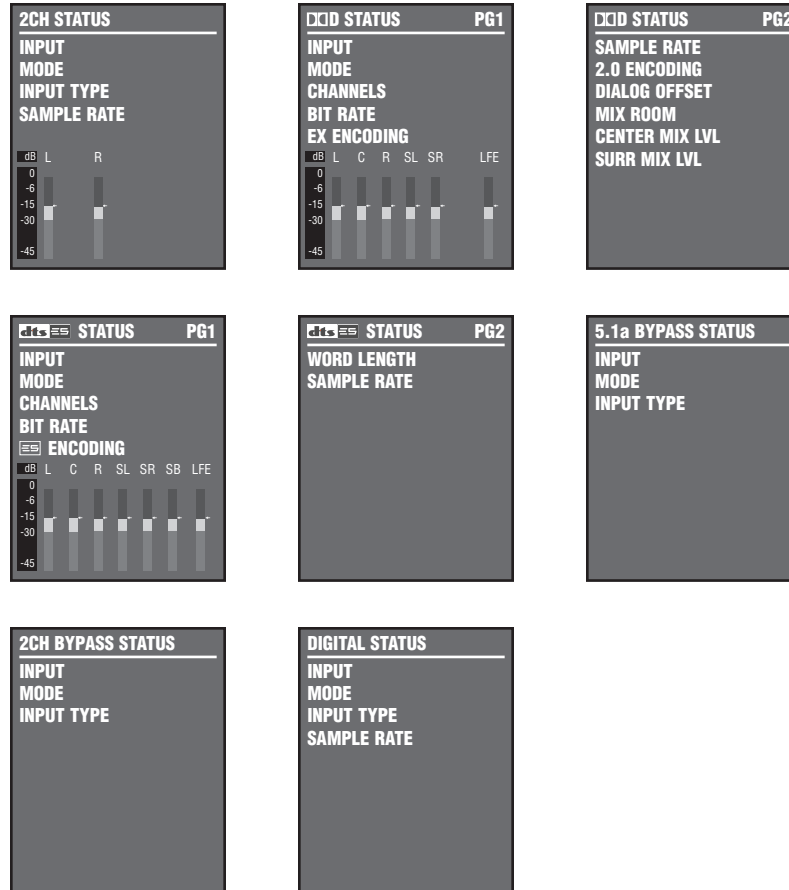

2CH STATUS

- Provides information about 2-channel input sources.
- Features L and R level meters (2-23).

Parameter	Possible Settings
INPUT	The selected input
MODE	The activated listening mode
INPUT TYPE	ANLG, PCM
SAMPLE RATE	44.1kHz, 48kHz, 88.2kHz, 96kHz

STATUS menu parameter descriptions begin on page 2-22.

DOLBY D STATUS

- Provides information about Dolby Digital input sources.
- Features L, C, R, SL, SR, and SUB level meters (2-23).

Parameter	Possible Settings
INPUT	The selected input
MODE	The activated listening mode
CHANNELS	3/2.1, 3/2, 3/1, 2/2, 2/1, 2/0, 1/0
BIT RATE	32 to 640kbps
EX ENCODING	ON, OFF
SAMPLE RATE	48kHz
2.0 ENCODING	MATRIX, NONE
DIALOG OFFSET	-27 to +4dB
MIX ROOM	SMALL, LARGE
CENTER MIX LVL	-3.0dB, -4.5dB, -6.0dB
SURR MIX LVL	+0.0dB, -3.0dB, -6.0dB

STATUS menu parameter descriptions begin on page 2-22.

dts(-ES) STATUS

- Provides information about dts(-ES) input sources.
- Features L, C, R, SL, SR, SB, and SUB level meters (2-23). The SB level meter appears when a 6.1-channel input source is present, or when a 5.1-channel input source is present and the ES DECODING parameter (5-30) is set to ON.

Parameter	Possible Settings
INPUT	The selected input
MODE	The activated listening mode
CHANNELS	3/3.1, 3/2.1
BIT RATE	754.5 to 1509.7kbps
ES ENCODING	DISCRETE, MATRIX, OFF
WORD LENGTH	16bits, 20bits, 24bits
SAMPLE RATE	44.1kHz, 48kHz, 88.2kHz, 96kHz

STATUS menu parameter descriptions begin on page 2-22.

5.1a BYPASS STATUS

- Provides information about 5.1-channel analog input sources.

Parameter	Possible Settings
INPUT	The selected input
MODE	5.1a BYPASS
INPUT TYPE	BYPASS

STATUS menu parameter descriptions begin on page 2-22.

2CH BYPASS STATUS

- Provides information about 2-channel analog input sources when the MAIN ADV menu 2-CH ANLG BYP parameter is set to ON.

Parameter	Possible Settings
INPUT	The selected input
MODE	2CH BYPASS
INPUT TYPE	BYPASS

STATUS menu parameter descriptions begin on page 2-22.

DIGITAL STATUS

- Provides information about digital input sources for which a sample rate is detected, but no audio is present in the input signal.

Parameter	Possible Settings
INPUT	The selected input
MODE	The activated listening mode
INPUT TYPE	---
SAMPLE RATE	44.1kHz, 48kHz, 88.2kHz, 96kHz

STATUS menu parameter descriptions begin on page 2-22.

STATUS MENU PARAMETER DESCRIPTIONS**2.0 ENCODING**

MATRIX, NONE

Indicates whether or not a matrix-encoded source is detected. When the parameter setting is MATRIX, a matrix-encoded source is detected. When the parameter setting is NONE, a matrix-encoded source is not detected. The SDP-5 cannot automatically detect matrix encoding in non-flagged input sources.

BIT RATE

32 to 640 kbps or 754 to 1509.7kbps

Indicates the rate at which the input signal is encoded. A higher bit rate indicates that less compression was used during the encoding process. Possible settings for Dolby Digital sources range from 32 to 640 kbps. Possible settings for dts(-ES) sources range from 754 to 1509.7kbps.

CENTER MIX LVL

-3.0dB, -4.5dB, -6.0dB

Indicates the relative level of the center channel that was used during the mixing process.

CHANNELS

3/3.1, 3/2.1, 3/2, 3/1, 2/2, 2/1, 2/0, 1/0

Indicates the number of channels present in the input source. The first digit indicates the number of front channels present. The digit after the slash indicates the number of surround channels present. The digit after the decimal point indicates the presence of LFE (low frequency effects) information. For instance, if the parameter setting is 3/2.1, an input source with three front channels, two surround channels, and LFE information is present. LFE information is sent to the Main Zone audio output connector labeled Subwoofer.

Possible settings for Dolby Digital input sources include 3/2.1, 3/2, 3/1, 2/2, 2/1, 2/0, and 1/0. Current settings for dts(-ES) input sources include 3/3.1 and 3/2.1.

DIALOG OFFSET

-27 to +4dB

Indicates the dialog normalization value applied to the input signal. Dolby Digital input sources reproduce dialog at 27 decibels below full-scale (-27dBFS). When the dialog normalization value of the incoming signal is higher or lower, the DIALOG OFFSET parameter indicates the amount of adjustment the SDP-5 makes to normalize dialog to -27dBFS.

ES ENCODING

DISCRETE, MATRIX, OFF

Indicates whether or not a dts-ES-encoded source is detected. When the parameter setting is DISCRETE, a discrete 6.1-channel dts-ES source is detected. When the parameter setting is MATRIX, a 5.1-channel dts-ES source with a surround-encoded back channel is detected. When the parameter setting is NONE, a standard dts source with no dts-ES encoding is detected.

EX ENCODING

ON, OFF

Indicates whether or not a Dolby Digital Surround EX-encoded source is detected. When the parameter setting is MATRIX, a 5.1-channel Dolby Digital source recorded with Dolby Digital Surround EX is detected. When the parameter setting is NONE, a standard 5.1-channel Dolby Digital source recorded without Dolby Digital Surround EX-encoding is detected. The SDP-5 cannot automatically detect Dolby Digital Surround EX encoding in non-flagged input sources. Refer to page 5-19 for more information.

INPUT

Indicates the selected input (i.e. DVD1).

INPUT TYPE

ANLG, BYP, PCM, ---

Indicates the input source that is present. When the parameter setting is ANLG, a 2-channel analog audio source is present and the MAIN ADV menu 2-CH ANLG BYP parameter (3-20) is set to OFF. When the parameter setting is BYP (Bypass), a 2-channel analog audio source is present and the 2-CH ANLG BYP parameter is set to ON. When the parameter setting is PCM, a 2-channel digital audio source is present. When the parameter setting is ---, an unknown digital audio source is present.

MIX ROOM

SMALL, LARGE

Indicates the size of the mixing room that was used during the mixing process. When the parameter setting is LARGE, it is recommended to set the RE-EQUALIZATION parameter to ON for THX listening modes.

MODE

Indicates the activated listening mode (i.e. L7 FILM).

SAMPLE RATE

44.1kHz, 48kHz, 88.2kHz, 96kHz

Indicates the sample rate of the input source that is present.

SURR MIX LVL

+0.0dB, -3.0dB, -6.0dB

Indicates the relative surround channel level that was used during the mixing process.

WORD LENGTH

16bits, 20bits, 24bits

Indicates the word length of the audio data present in the input signal.

STATUS MENU LEVEL METERS

Most STATUS menus contain level meters that indicate fluctuating input levels in the front left (L), center (C), front right (R), surround left (SL), surround right (SR), surround back (SB), and subwoofer (SUB) channels. These level meters indicate input levels for both analog and digital input sources. For instance, the level meters indicate digital audio input levels when a digital audio source is present.

Different combinations of level meters appear on each STATUS menu, depending on the source that is present. The SB level meter appears when a 6.1-channel source is present, or when a 5.1-channel source is present and the ES DECODING parameter (5-30) is set to ON.

Level meters appear in combinations of green, yellow, and red when the on-screen display is configured for a blue-screen background. Green indicates low levels, yellow indicates normal levels, and red indicates high levels and the onset of overload. Level meters appear in white when the on-screen display is not configured for a blue-screen background.

3

SETUP

SETUP	3-2
INPUT SETUP	3-3
<i>Changing Input Names (NAME) • Assigning Audio & Video Input Connectors • Selecting Preferred Listening Modes • Configuring Advanced Zone Settings</i>	
SPEAKER SETUP	3-26
<i>Custom Speaker Setups • THX Speaker Setups • Measuring Speaker Distances • Calibrating Output Levels</i>	
REAR PANEL CONFIG	3-45
DISPLAY SETUP	3-47
<i>On-Screen Display Setup • Front Panel Display Setup</i>	
VOLUME CONTROL SETUP	3-53
TRIGGER SETUP	3-54
LOCK OPTIONS	3-56

SETUP

Selecting the MAIN MENU SETUP option opens the SETUP menu as shown below. SETUP menu option descriptions begin below and continue throughout this section.

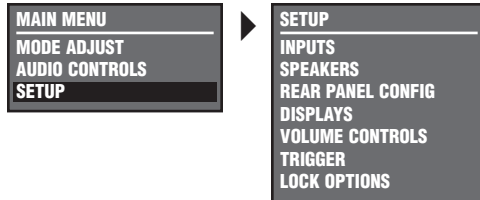

INPUTS

SETUP ▶ INPUTS

Prompts the selection of the desired input (i.e. DVD1). Selecting an input opens the corresponding INPUT SETUP menu, which can be used to change input names, assign audio and video input connectors, select preferred listening modes, and configure advanced Main Zone and Zone 2 input settings. Refer to the next page for more information.

SPEAKERS

SETUP ▶ SPEAKERS

Opens the SPEAKER SETUP menu, which can be used to configure the Main Zone audio output connectors for the desired speaker setup, set speaker distances, and calibrate output levels. Refer to page 3-26 for more information.

REAR PANEL CONFIG

SETUP ▶ REAR PANEL CONFIG

Opens the REAR PANEL CONFIG menu, which can be used to configure the analog audio input connectors as eight stereo connectors, one 5.1-channel and five stereo connectors, or two stereo and two 5.1-channel connectors. Refer to page 3-45 for more information.

DISPLAYS

SETUP ▶ DISPLAYS

Opens the DISPLAY SETUP menu, which can be used to customize the on-screen and front panel displays, restore audio/video synchronization, and activate and create a custom unit name. Refer to page 3-47 for more information.

VOLUME CONTROLS

SETUP ▶ VOLUME CONTROLS

Opens the VOLUME CONTROL SETUP menu, which can be used to configure Main Zone and Zone 2 volume levels. Refer to page 3-53 for more information.

TRIGGER

SETUP ▶ TRIGGER

Opens the TRIGGER SETUP menu, which can be used to configure the trigger output connector labeled 1. Refer to page 3-54 for more information.

LOCK OPTIONS

SETUP ▶ **LOCK OPTIONS**

Opens the LOCK OPTIONS menu, which can be used to lock and unlock settings in the MODE ADJUST, AUDIO CONTROLS, and SETUP menu branches. Refer to page 3-56 for more information.

INPUT SETUP

SETUP ▶ **INPUTS** ▶ **(INPUT)** ▶ **INPUT SETUP**

Selecting the SETUP menu INPUTS option prompts the selection of the desired input (i.e. DVD1) as shown below. Selecting an input opens the corresponding INPUT SETUP menu shown at the right, which can be used to change input names, assign audio and video input connectors, select preferred listening modes, and configure advanced Main Zone and Zone 2 input settings.

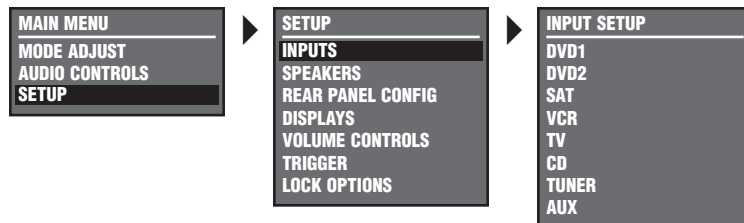

All INPUT SETUP menus are shown at the right. The parameters on the left side of the INPUT SETUP menus are identical regardless of which input is selected. The parameter settings on the right side are adjustable. Default parameter settings differ from input to input. The INPUT SETUP menus to the right indicate factory-default parameter settings for each input.

DVD1 INPUT SETUP	
NAME	DVD1
DIGITAL IN	COAX-1
ANALOG IN	NONE
ANLG IN LVL	+0dB
VIDEO IN	S-VIDEO-1
COMPONENT IN	1
2-CH	<input checked="" type="checkbox"/> FILM
DOD	5.1 <input checked="" type="checkbox"/> FILM
<input checked="" type="checkbox"/> ES <input checked="" type="checkbox"/> ES	<input checked="" type="checkbox"/> FILM
MAIN ADVANCED	
ZONE2 IN	DIGITAL

VCR INPUT SETUP	
NAME	VCR
DIGITAL IN	NONE
ANALOG IN	ANALOG-2
ANLG IN LVL	+0dB
VIDEO IN	S-VIDEO-4
COMPONENT IN	NONE
2-CH	<input checked="" type="checkbox"/> FILM
DOD	5.1 <input checked="" type="checkbox"/> FILM
<input checked="" type="checkbox"/> ES <input checked="" type="checkbox"/> ES	<input checked="" type="checkbox"/> FILM
MAIN ADVANCED	
ZONE2 IN	ANLG

TUNER INPUT SETUP	
NAME	TUNER
DIGITAL IN	NONE
ANALOG IN	ANALOG-4
ANLG IN LVL	+0dB
VIDEO IN	NONE
COMPONENT IN	NONE
2-CH	<input checked="" type="checkbox"/> MUSIC
DOD	5.1 <input checked="" type="checkbox"/> MUSIC
<input checked="" type="checkbox"/> ES <input checked="" type="checkbox"/> ES	<input checked="" type="checkbox"/> MUSIC
MAIN ADVANCED	
ZONE2 IN	ANLG

DVD2 INPUT SETUP	
NAME	DVD2
DIGITAL IN	COAX-2
ANALOG IN	NONE
ANLG IN LVL	+0dB
VIDEO IN	S-VIDEO-2
COMPONENT IN	2
2-CH	<input checked="" type="checkbox"/> FILM
DOD	5.1 <input checked="" type="checkbox"/> FILM
<input checked="" type="checkbox"/> ES <input checked="" type="checkbox"/> ES	<input checked="" type="checkbox"/> FILM
MAIN ADVANCED	
ZONE2 IN	DIGITAL

TV INPUT SETUP	
NAME	TV
DIGITAL IN	OPTICAL-2
ANALOG IN	ANALOG-3
ANLG IN LVL	+0dB
VIDEO IN	S-VIDEO-5
COMPONENT IN	NONE
2-CH	<input checked="" type="checkbox"/> TV
DOD	5.1 <input checked="" type="checkbox"/> TV
<input checked="" type="checkbox"/> ES <input checked="" type="checkbox"/> ES	<input checked="" type="checkbox"/> FILM
MAIN ADVANCED	
ZONE2 IN	ANLG

AUX INPUT SETUP	
NAME	AUX
DIGITAL IN	OPTICAL-3
ANALOG IN	NONE
ANLG IN LVL	+0dB
VIDEO IN	COMPOSITE-2
COMPONENT IN	NONE
2-CH	<input checked="" type="checkbox"/> MUSIC
DOD	5.1 <input checked="" type="checkbox"/> MUSIC
<input checked="" type="checkbox"/> ES <input checked="" type="checkbox"/> ES	<input checked="" type="checkbox"/> MUSIC
MAIN ADVANCED	
ZONE2 IN	DIGITAL

SAT INPUT SETUP	
NAME	SAT
DIGITAL IN	OPTICAL-1
ANALOG IN	ANALOG-1
ANLG IN LVL	+0dB
VIDEO IN	S-VIDEO-3
COMPONENT IN	3
2-CH	<input checked="" type="checkbox"/> TV
DOD	5.1 <input checked="" type="checkbox"/> TV
<input checked="" type="checkbox"/> ES <input checked="" type="checkbox"/> ES	<input checked="" type="checkbox"/> FILM
MAIN ADVANCED	
ZONE2 IN	ANLG

CD INPUT SETUP	
NAME	CD
DIGITAL IN	COAX-3
ANALOG IN	NONE
ANLG IN LVL	+0dB
VIDEO IN	COMPOSITE-1
COMPONENT IN	NONE
2-CH	<input checked="" type="checkbox"/> MUSIC
DOD	5.1 <input checked="" type="checkbox"/> MUSIC
<input checked="" type="checkbox"/> ES <input checked="" type="checkbox"/> ES	<input checked="" type="checkbox"/> MUSIC
MAIN ADVANCED	
ZONE2 IN	DIGITAL

CHANGING INPUT NAMES (NAME)

SETUP ▶ **INPUTS** ▶ **DVD1** ▶ **NAME**

Selecting the INPUT SETUP menu NAME parameter opens the INPUT NAME menu shown below, which can be used to customize or restore the factory-default name of the selected input. Factory-default input names correspond to front panel and remote control input selection button labels.

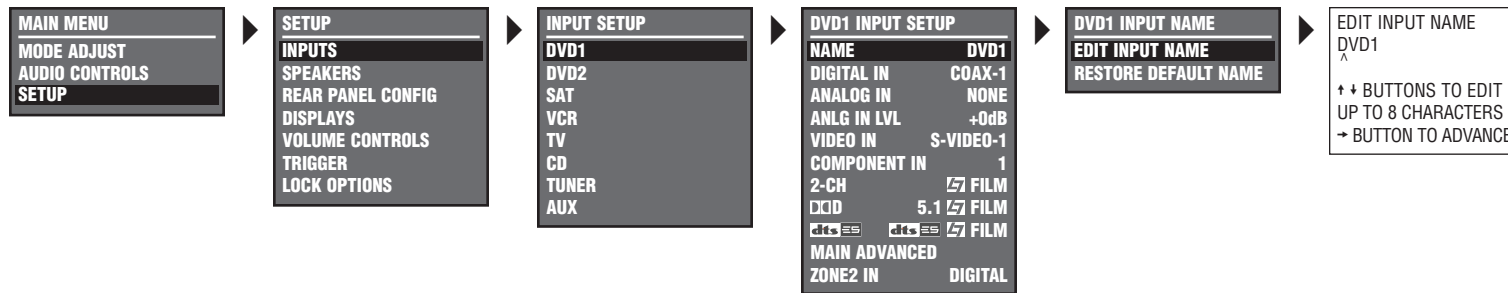

The DVD1 INPUT SETUP menu is shown here as an example, and will continue to be shown as an example throughout this section. Whenever it appears, any other INPUT SETUP menu may be substituted. Likewise, whenever the DVD1 input appears as a step in a menu path, any other input may be substituted.

EDIT INPUT NAME

SETUP ▶ **INPUTS** ▶ **DVD1** ▶ **NAME** ▶ **EDIT INPUT NAME**

Opens the EDIT INPUT NAME drop-down menu shown above, which can be used to customize the name of the selected input.

To customize the name of the selected input:

1. Follow the EDIT INPUT NAME menu path to open the EDIT INPUT NAME drop-down menu.
2. When the EDIT INPUT NAME drop-down menu opens, press the remote control Menu **▲** and **▼** arrows to change the character above the cursor (^).

3. When the desired character has been selected, press the Menu **▶** arrow to advance to the next character space. Press the Menu **◀** arrow to return to the previous character space. The cursor will automatically wrap to the first character space when the last character space is passed.
4. Repeat steps 2 and 3 to enter the desired input name.
5. When the desired input name has been entered, press the Menu **◀** arrow to close the EDIT INPUT NAME drop-down menu and return to the INPUT NAME menu.

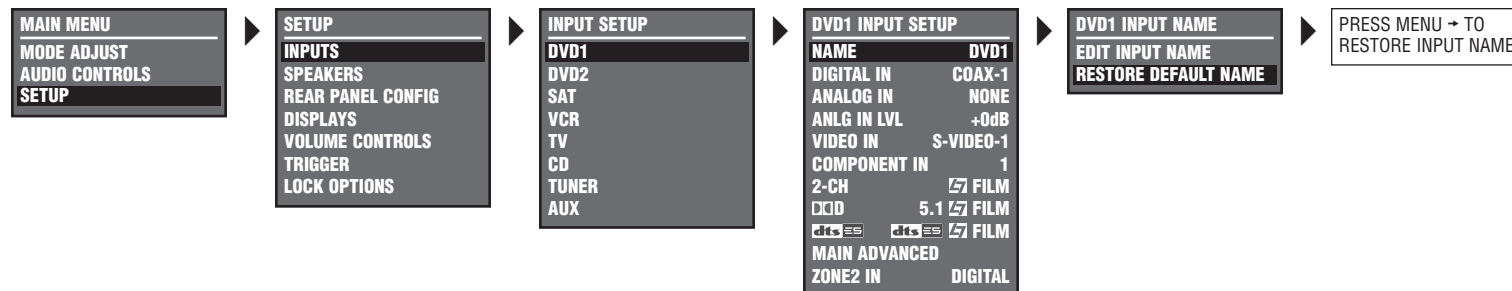

The DVD1 INPUT SETUP menu is shown here as an example, and will continue to be shown as an example throughout this section. Whenever it appears, any other INPUT SETUP menu may be substituted. Likewise, whenever the DVD1 input appears as a step in a menu path, any other input may be substituted.

The custom input name appears on the on-screen and front panel displays. Both the custom and factory-default input names appear on the input selection menu that opens when the SETUP menu INPUTS option is selected. The custom input name appears against the left margin of the on-screen display, and the factory-default input name appears in parentheses against the right margin of the on-screen display.

RESTORE DEFAULT NAME

SETUP ▶ **INPUTS** ▶ **DVD1** ▶ **NAME** ▶ **RESTORE DEFAULT NAME**

Restores the factory-default name of the selected input. Factory-default input names correspond to front panel and remote control input selection button labels.

To restore the factory-default name of the selected input:

1. Follow the RESTORE DEFAULT NAME menu path to open the INPUT NAME menu.
2. When the INPUT NAME menu opens, press the remote control Menu **▲** and **▼** arrows to highlight the RESTORE DEFAULT NAME option.
3. When the RESTORE DEFAULT NAME option is highlighted, press the Menu **▶** arrow to select this option. The message "PRESS MENU → TO RESTORE INPUT NAME" appears on the on-screen and front panel displays.
4. When this message opens, press the Menu **▶** arrow to restore the factory-default name of the selected input and close the message. (Press the Menu **◀** arrow to close the message without restoring the factory-default name of the selected input.)

ASSIGNING AUDIO & VIDEO INPUT CONNECTORS

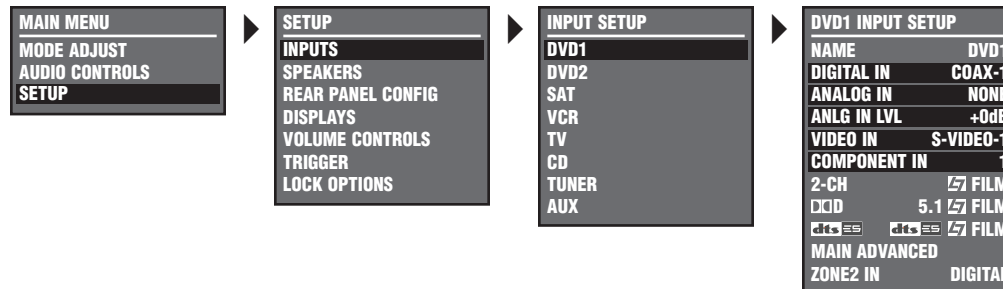

The DVD1 INPUT SETUP menu is shown here as an example, and will continue to be shown as an example throughout this section. Whenever it appears, any other INPUT SETUP menu may be substituted. Likewise, whenever the DVD1 input appears as a step in a menu path, any other input may be substituted.

The SDP-5 has eight configurable inputs, each of which can be assigned to its eight digital audio, eight analog audio, five composite video, five S-video, or three component video input connectors. The table below lists the INPUT SETUP menu parameters that can be used to assign audio and video input connectors. The ANLG IN LVL parameter can be used to adjust analog audio input levels for the selected input. These parameters are highlighted on the INPUT SETUP menu shown above.

Parameter	Possible Settings
DIGITAL IN	COAX-1 to 4, OPTICAL-1 to 4, NONE
ANALOG IN	ANALOG-1 to 8, 5.1 ANLG (3-5) or (6-8), NONE
ANLG IN LVL	AUTO, -18 to +12dB
VIDEO IN	COMPOSITE-1 to 5, S-VIDEO-1 to 5, NONE
COMPONENT IN	COMPONENT 1 to 3, NONE

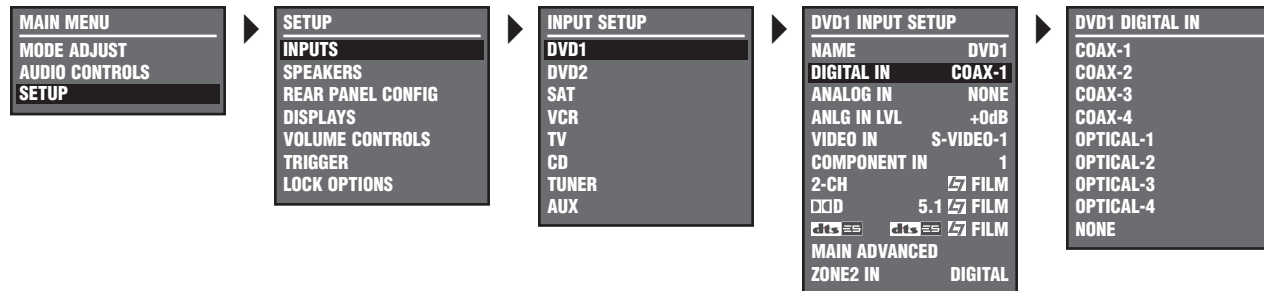

The DVD1 INPUT SETUP menu is shown here as an example, and will continue to be shown as an example throughout this section. Whenever it appears, any other INPUT SETUP menu may be substituted. Likewise, whenever the DVD1 input appears as a step in a menu path, any other input may be substituted.

DIGITAL IN COAX-1 to 4, OPTICAL-1 to 4, NONE

SETUP ▶ **INPUTS** ▶ **DVD1** ▶ **DIGITAL IN**

Opens the DIGITAL IN menu shown above, which can be used to assign a digital audio input connector for the selected input. The SDP-5 has eight configurable inputs, each of which can be assigned to any of its eight digital audio input connectors.

Note:

The digital audio input connectors are compatible with PCM (44.1, 48, 88.2, and 96kHz), Dolby Digital, and dts(-ES) sources. The digital audio input connectors are not compatible with MPEG (MP3) sources.

Please note the following:

- When no digital audio input connector is assigned, the SDP-5 will automatically set the MAIN ADV menu INPUT SELECT parameter to ANALOG (3-18).
- A digital audio input connector must be assigned when no analog audio input connector is assigned. Refer to the next page for information about assigning an analog audio input connector.

... Assigning Audio & Video Input Connectors continues on page 3-8

Assigning Audio & Video Input Connectors (continued from page 3-7)

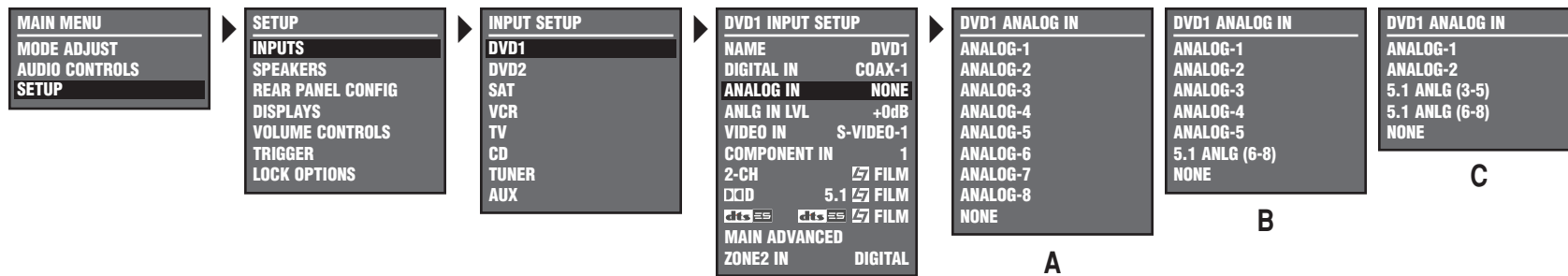

The DVD1 INPUT SETUP menu is shown here as an example, and will continue to be shown as an example throughout this section. Whenever it appears, any other INPUT SETUP menu may be substituted. Likewise, whenever the DVD1 input appears as a step in a menu path, any other input may be substituted.

ANALOG IN ANALOG-1 to 8, 5.1 ANLG (3-5) or (6-8), NONE

SETUP ▶ INPUTS ▶ DVD1 ▶ ANALOG IN

Opens the ANALOG IN menu shown above, which can be used to assign an analog audio input connector for the selected input. The SDP-5 has eight configurable inputs, each of which can be assigned to any of its eight analog audio input connectors.

The appearance of the ANALOG IN menu depends on the configuration of the analog audio input connectors.

- The ANALOG IN menu labeled A (above) appears when the REAR PANEL CONFIG menu 8 STEREO INPUTS option (3-45) is selected.
- The ANALOG IN menu labeled B (above) appears when the REAR PANEL CONFIG menu 5 ST. & (1) 5.1 ANLG option (3-45) is selected.

- The ANALOG IN menu labeled C (above) appears when the REAR PANEL CONFIG menu 2 ST. & (2) 5.1 ANLG (3-46) option is selected.

Please note the following:

- When no analog audio input connector is assigned, the SDP-5 will automatically set the MAIN ADV menu INPUT SELECT parameter to DIGITAL (3-18).
- An analog audio input connector must be assigned when no digital audio input connector is assigned. Refer to the previous page for information about assigning a digital audio input connector.

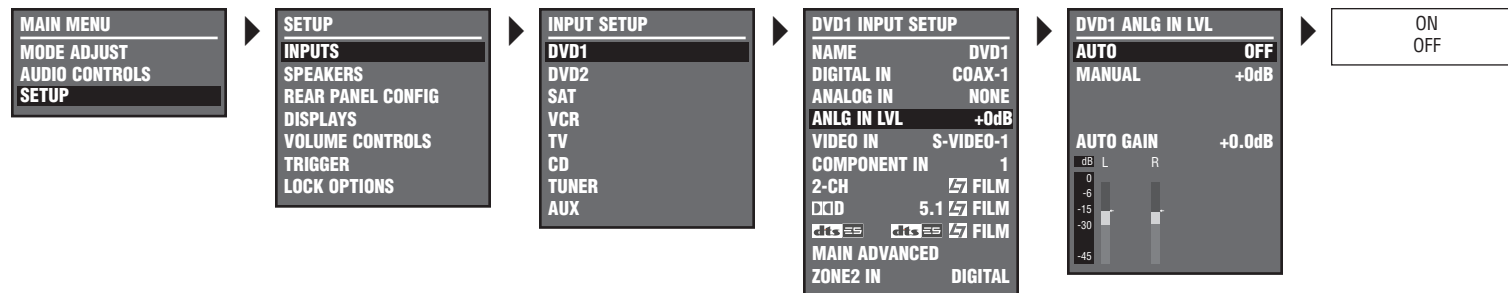

The DVD1 INPUT SETUP menu is shown here as an example, and will continue to be shown as an example throughout this section. Whenever it appears, any other INPUT SETUP menu may be substituted. Likewise, whenever the DVD1 input appears as a step in a menu path, any other input may be substituted.

ANLG IN LVL

SETUP ▶ **INPUTS** ▶ **DVD1** ▶ **ANLG IN LVL**

Opens the ANLG IN LVL menu shown above, which can be used to adjust 2-channel analog audio input levels for the selected input. Despite attempts at standardization, analog audio sources have a wide range of levels. To compensate for this, the SDP-5 allows independent input level adjustment for each of its stereo analog audio input connectors. **Input level adjustment is not available for either of the 5.1-channel analog audio input connectors.**

Note:

Adjustments made on the ANLG IN LVL menu are applied to the stereo analog audio input connector assigned for the selected input. When another stereo analog audio input connector is assigned, these adjustments are automatically applied to the new connector.

AUTO

ON, OFF

SETUP ▶ **INPUTS** ▶ **DVD1** ▶ **ANLG IN LVL** ▶ **AUTO**

Provides automatic adjustment of 2-channel analog audio input levels. When set to ON, the SDP-5 automatically monitors and optimizes input levels. When the input signal is too high, the SDP-5 quickly decreases input levels to avoid overload. When the input signal is too low, the SDP-5 slowly increases input levels to maximize the signal-to-noise ratio and dynamic range.

When the AUTO parameter is set to OFF, the SDP-5 does not provide automatic adjustment of 2-channel analog audio input levels. Rather, input levels must be adjusted with the ANLG IN LVL MANUAL parameter (next page).

... Assigning Audio & Video Input Connectors continues on page 3-10

Assigning Audio & Video Input Connectors (continued from page 3-9)

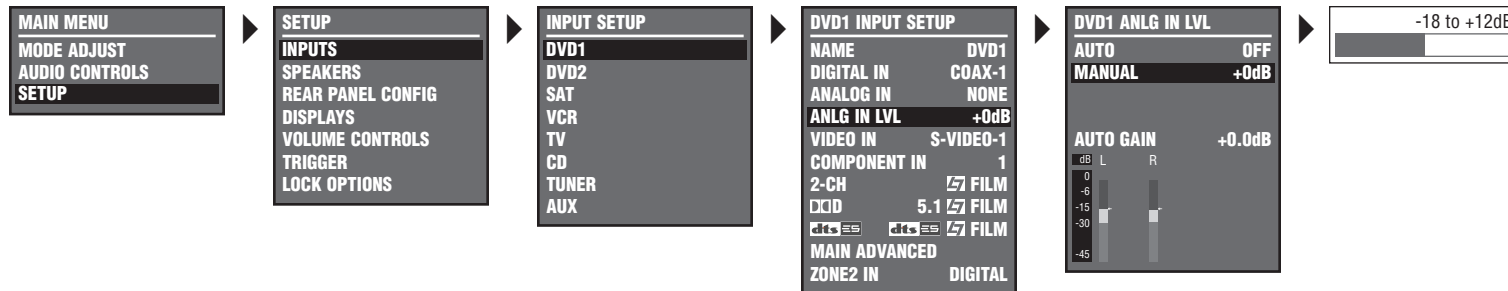

The DVD1 INPUT SETUP menu is shown here as an example, and will continue to be shown as an example throughout this section. Whenever it appears, any other INPUT SETUP menu may be substituted. Likewise, whenever the DVD1 input appears as a step in a menu path, any other input may be substituted.

MANUAL

-18 to +12dB

SETUP ▶ INPUTS ▶ DVD1 ▶ ANLG IN LVL ▶ MANUAL

Provides manual adjustment of 2-channel analog audio input levels. When manual adjustments are made, the SDP-5 automatically sets the ANLG IN LVL menu AUTO parameter to OFF and deactivates automatic input level adjustment. Manual input level adjustments are retained when the AUTO parameter is set to ON.

Note:

When the AUTO parameter is set to ON, the SDP-5 will not make adjustments that exceed the ANLG IN LVL menu MANUAL parameter setting.

AUTO GAIN

SETUP ▶ INPUTS ▶ DVD1 ▶ ANLG IN LVL ▶ AUTO GAIN

Indicates the current amount of input level adjustment for the selected stereo analog audio input connector. When the ANLG IN LVL menu AUTO parameter is set to ON, the AUTO GAIN parameter indicates the amount of automatic input level adjustment. When the AUTO parameter is set to OFF, the AUTO GAIN parameter indicates the amount of manual input level adjustment. (In other words, the AUTO GAIN parameter reflects the setting of the ANLG IN LVL menu MANUAL parameter.)

When the AUTO parameter is set to ON, the AUTO GAIN parameter continues to indicate the amount of manual input level adjustment until automatic adjustments have been made.

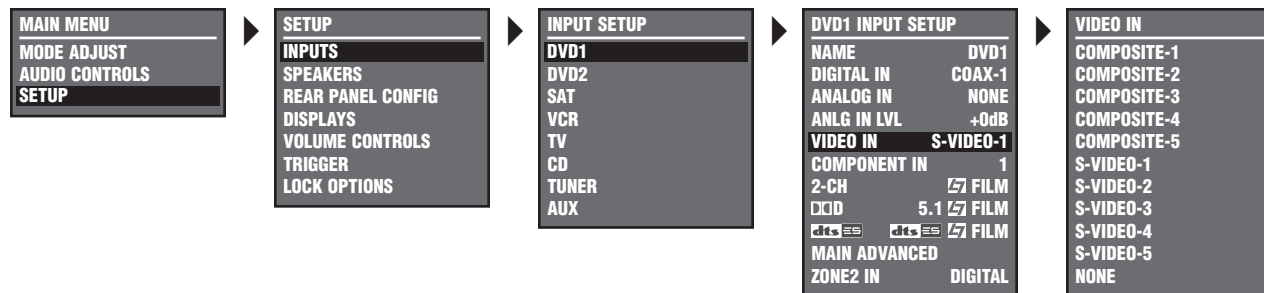

The DVD1 INPUT SETUP menu is shown here as an example, and will continue to be shown as an example throughout this section. Whenever it appears, any other INPUT SETUP menu may be substituted. Likewise, whenever the DVD1 input appears as a step in a menu path, any other input may be substituted.

LEVEL METERS

SETUP ▶ **INPUTS** ▶ **DVD1** ▶ **ANLG IN LVL**

Indicate fluctuating input levels in the front left (L) and front right (R) channels for the selected input. These level meters are also included on the STATUS menus, allowing them to indicate input levels for both analog and digital audio input sources. However, ANLG IN LVL menu input level adjustments only affect 2-channel analog audio input sources.

Level meters appear in combinations of green, yellow, and red when the on-screen display is configured for a blue-screen background. Green indicates low levels, yellow indicates normal levels, and red indicates the onset of overload. Level meters appear in white when the on-screen display is not configured for a blue-screen background.

VIDEO IN

COMPOSITE-1 to 5, S-VIDEO-1 to 5, NONE

SETUP ▶ **INPUTS** ▶ **DVD1** ▶ **VIDEO IN**

Opens the VIDEO IN menu shown above, which can be used to assign a composite or S-video input connector for the selected input. The SDP-5 has eight configurable inputs, each of which can be assigned to any of its five composite or five S-video input connectors.

Please note the following:

- Composite video output connectors are available when a composite or S-video source is present.
- S-video output connectors are available when an S-video source is present.
- Component video output connectors are available when a component video source is present.

. . . Assigning Audio & Video Input Connectors continues on page 3-12

Assigning Audio & Video Input Connectors (continued from page 3-11)

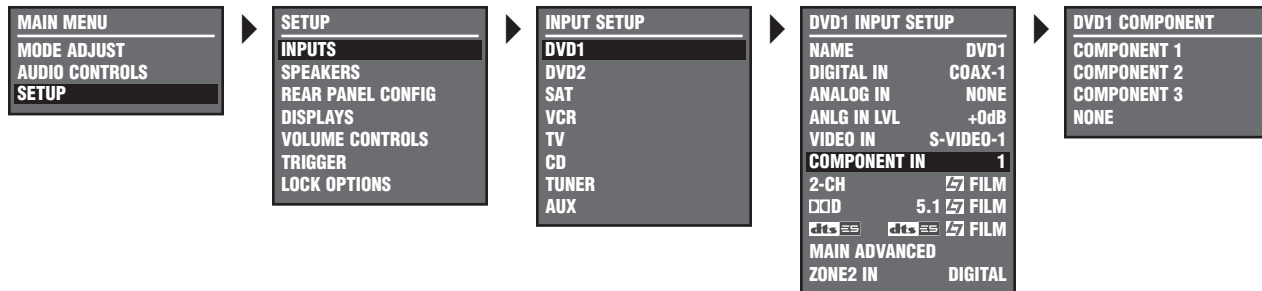

The DVD1 INPUT SETUP menu is shown here as an example, and will continue to be shown as an example throughout this section. Whenever it appears, any other INPUT SETUP menu may be substituted. Likewise, whenever the DVD1 input appears as a step in a menu path, any other input may be substituted.

COMPONENT IN COMPONENT 1 to 3, NONE

SETUP ▶ **INPUTS** ▶ **DVD1** ▶ **COMPONENT IN**

Opens the COMPONENT menu shown above, which can be used to assign a component video input connector for the selected input. The SDP-5 has eight configurable inputs, each of which can be assigned to any of its 3 component video input connectors.

Please note the following:

- Composite video output connectors are available when a composite or S-video source is present.
- S-video output connectors are available when an S-video source is present.
- Component video output connectors are available when a component video source is present.

SELECTING PREFERRED LISTENING MODES

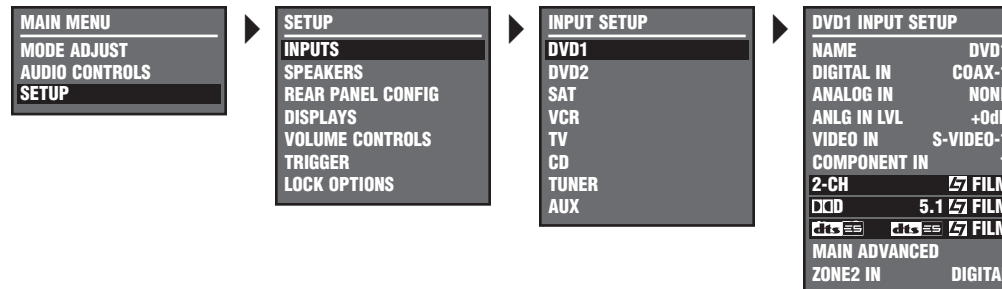

The DVD1 INPUT SETUP menu is shown here as an example, and will continue to be shown as an example throughout this section. Whenever it appears, any other INPUT SETUP menu may be substituted. Likewise, whenever the DVD1 input appears as a step in a menu path, any other input may be substituted.

The INPUT SETUP menus include three preferred listening mode selection parameters labeled 2-CH, DOLBY D, and dts-ES. These parameters can be used to select a preferred listening mode for 2-channel, Dolby Digital, and dts(-ES) input sources. The SDP-5 automatically activates the selected listening mode whenever a new input is selected or a new input source is present.

For example, the preferred listening mode selection parameters on the DVD1 and CD INPUT SETUP menus are set as shown at the right.

- If the DVD1 input is selected and a 2-channel source is present, the SDP-5 activates the L7 FILM listening mode. If a Dolby Digital source becomes present, the SDP-5 automatically activates the 5.1 L7 FILM listening mode.
- If the DVD1 input is selected and a dts(-ES) source is present, the SDP-5 activates the dts(-ES) L7 FILM listening mode. If the CD input is selected and a 2-channel source is present, the SDP-5 automatically activates the L7 MUSIC listening mode.

DVD1 INPUT SETUP	
NAME	DVD1
DIGITAL IN	COAX-1
ANALOG IN	NONE
ANLG IN LVL	+0dB
VIDEO IN	S-VIDEO-1
COMPONENT IN	1
2-CH	L7 FILM
DOD	5.1 L7 FILM
dts-ES	dts-ES L7 FILM
MAIN ADVANCED	
ZONE2 IN	DIGITAL

CD INPUT SETUP	
NAME	CD
DIGITAL IN	COAX-3
ANALOG IN	NONE
ANLG IN LVL	+0dB
VIDEO IN	COMPOSITE-1
COMPONENT IN	NONE
2-CH	L7 MUSIC
DOD	5.1 L7 MUSIC
dts-ES	dts-ES L7 MUSIC
MAIN ADVANCED	
ZONE2 IN	DIGITAL

... Selecting Preferred Listening Modes continues on page 3-14

Selecting Preferred Listening Modes (continued from page 3-13)

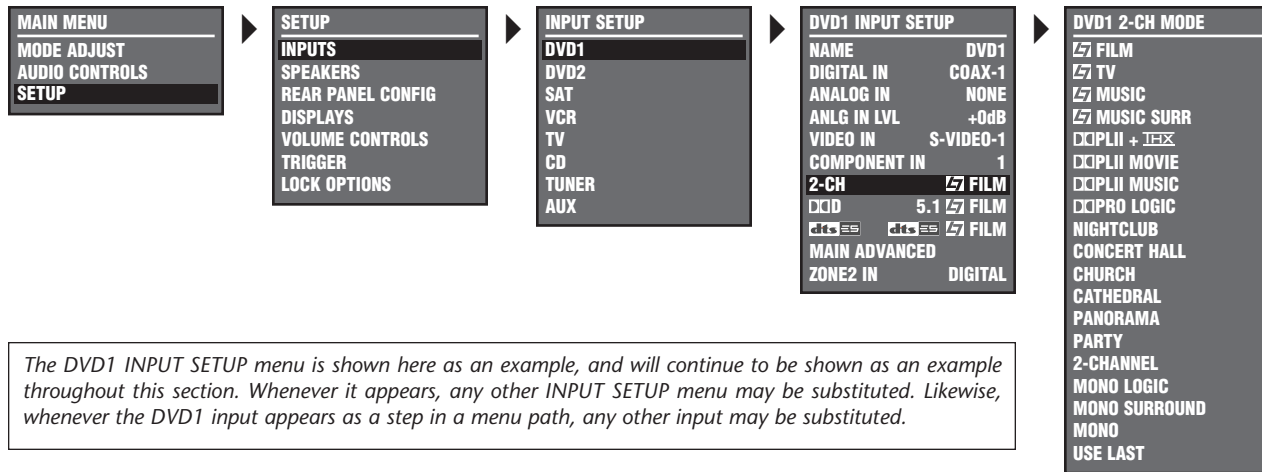

2-CH

SETUP ▶ INPUTS ▶ DVD1 ▶ 2-CH

Opens the 2-CH MODE menu shown above, which can be used to select a preferred listening mode for 2-channel input sources. The SDP-5 automatically activates the selected listening mode whenever a new input is selected or a new 2-channel source is present. When set to USE LAST, the SDP-5 activates the listening mode that was activated the last time a 2-channel source was present whenever a new input is selected or a new 2-channel source is present.

When the 2-CH parameter is set to USE LAST:

- The SDP-5 will not automatically activate the 2-CHANNEL listening mode if the remote control 2 CH button was used to activate the 2-CHANNEL listening mode the last time a 2-channel source was present. Instead, it will activate the 2-channel listening mode (i.e. L7 FILM) that was activated prior to the 2-CHANNEL listening mode.
- The SDP-5 will automatically activate a dts NEO:6 listening mode if a dts NEO:6 listening mode was activated the last time a 2-channel source was present. However, the dts NEO:6 listening modes cannot be selected as the preferred listening mode for 2-channel sources.
- The SDP-5 will not automatically activate a dts NEO:6 listening mode unless a 44.1 or 48kHz PCM digital source is present. The dts NEO:6 listening modes are not available with 88.2 or 96kHz, Dolby Digital, or analog sources.

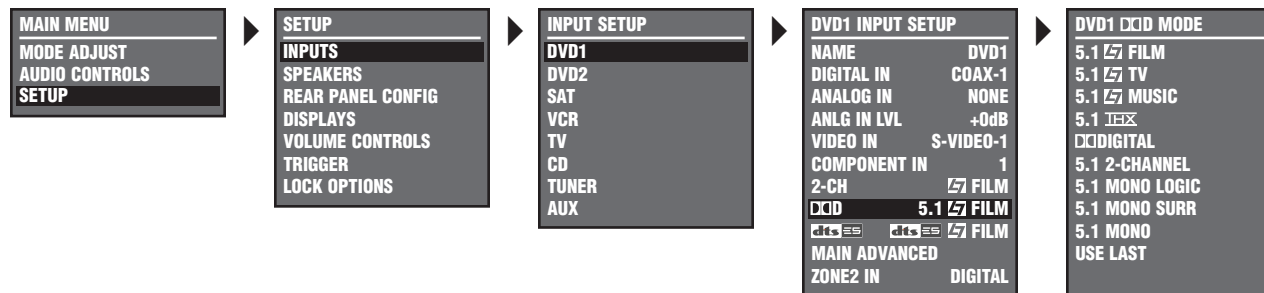

The DVD1 INPUT SETUP menu is shown here as an example, and will continue to be shown as an example throughout this section. Whenever it appears, any other INPUT SETUP menu may be substituted. Likewise, whenever the DVD1 input appears as a step in a menu path, any other input may be substituted.

DOLBY D

SETUP ▶ **INPUTS** ▶ **DVD1** ▶ **DDD**

Opens the DOLBY D MODE menu shown above, which can be used to select a preferred listening mode for Dolby Digital input sources. The SDP-5 automatically activates the selected listening mode whenever a new input is selected or a new Dolby Digital source is present. When set to USE LAST, the SDP-5 activates the listening mode that was activated the last time a Dolby Digital source was present whenever a new input is selected or a new Dolby Digital source is present.

When the DOLBY D parameter is set to USE LAST:

- The SDP-5 will automatically activate the 5.1 THX MUSIC listening mode if this listening mode was activated the last time a Dolby Digital source was present. However, the 5.1 THX MUSIC listening mode cannot be selected as the preferred listening mode for Dolby Digital sources.

... Selecting Preferred Listening Modes continues on page 3-16

Selecting Preferred Listening Modes (continued from page 3-15)

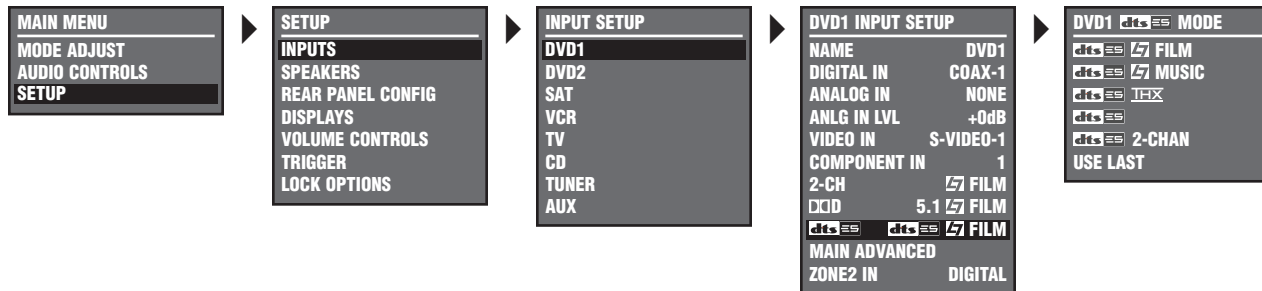

The DVD1 INPUT SETUP menu is shown here as an example, and will continue to be shown as an example throughout this section. Whenever it appears, any other INPUT SETUP menu may be substituted. Likewise, whenever the DVD1 input appears as a step in a menu path, any other input may be substituted.

dts-ES

SETUP ▶ **INPUTS** ▶ **DVD1** ▶ **dts-ES**

Opens the dts-ES MODE menu shown above, which can be used to select a preferred listening mode for dts(-ES) input sources. The SDP-5 automatically activates the selected listening mode whenever a new input is selected or a new dts(-ES) source is present. When set to USE LAST, the SDP-5 activates the listening mode that was activated the last time a dts(-ES) source was present whenever a new input is selected or a new dts(-ES) source is present.

When the dts-ES parameter is set to USE LAST:

- The SDP-5 will automatically activate the dts THX MUSIC listening mode if this listening mode was activated the last time a dts(-ES) source was present. However, the dts THX MUSIC listening mode cannot be selected as the preferred listening mode for dts(-ES) sources.

CONFIGURING ADVANCED ZONE SETTINGS

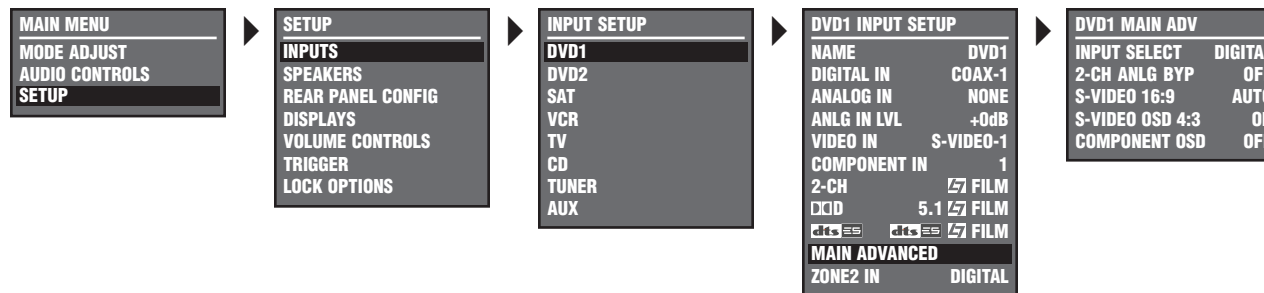

The DVD1 INPUT SETUP menu is shown here as an example, and will continue to be shown as an example throughout this section. Whenever it appears, any other INPUT SETUP menu may be substituted. Likewise, whenever the DVD1 input appears as a step in a menu path, any other input may be substituted.

MAIN ADVANCED

SETUP ▶ **INPUTS** ▶ **DVD1** ▶ **MAIN ADVANCED**

Selecting the INPUT SETUP menu MAIN ADVANCED option opens the MAIN ADV menu shown above. The parameters on the left side of this menu are identical regardless of which input is selected. The settings on the right side are adjustable. Default parameter settings differ from input to input. The MAIN ADV menus shown at the right indicate default parameter settings for each input.

... MAIN ADVANCED continues on page 3-18

DVD1 MAIN ADV	
INPUT SELECT	DIGITAL
2-CH ANLG BYP	OFF
S-VIDEO 16:9	AUTO
S-VIDEO OSD 4:3	ON
COMPONENT OSD	OFF

VCR MAIN ADV	
INPUT SELECT	ANALOG
2-CH ANLG BYP	OFF
S-VIDEO 16:9	AUTO
S-VIDEO OSD 4:3	ON
COMPONENT OSD	OFF

TUNER MAIN ADV	
INPUT SELECT	ANALOG
2-CH ANLG BYP	OFF
S-VIDEO 16:9	AUTO
S-VIDEO OSD 4:3	ON
COMPONENT OSD	OFF

DVD2 MAIN ADV	
INPUT SELECT	DIGITAL
2-CH ANLG BYP	OFF
S-VIDEO 16:9	AUTO
S-VIDEO OSD 4:3	ON
COMPONENT OSD	OFF

TV MAIN ADV	
INPUT SELECT	AUTO
2-CH ANLG BYP	OFF
S-VIDEO 16:9	AUTO
S-VIDEO OSD 4:3	ON
COMPONENT OSD	OFF

AUX MAIN ADV	
INPUT SELECT	DIGITAL
2-CH ANLG BYP	OFF
S-VIDEO 16:9	AUTO
S-VIDEO OSD 4:3	ON
COMPONENT OSD	OFF

SAT MAIN ADV	
INPUT SELECT	AUTO
2-CH ANLG BYP	OFF
S-VIDEO 16:9	AUTO
S-VIDEO OSD 4:3	ON
COMPONENT OSD	OFF

CD MAIN ADV	
INPUT SELECT	DIGITAL
2-CH ANLG BYP	OFF
S-VIDEO 16:9	AUTO
S-VIDEO OSD 4:3	ON
COMPONENT OSD	OFF

MAIN ADVANCED (continued from page 3-17)

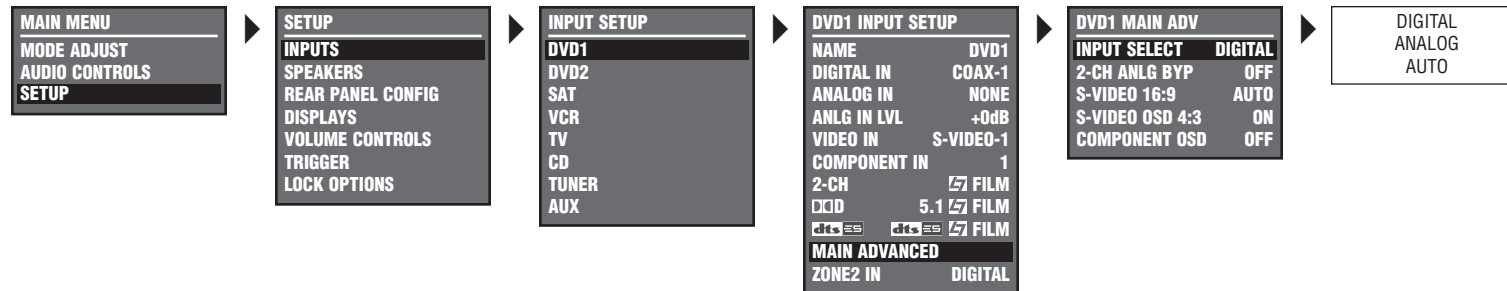

The DVD1 INPUT SETUP menu is shown here as an example, and will continue to be shown as an example throughout this section. Whenever it appears, any other INPUT SETUP menu may be substituted. Likewise, whenever the DVD1 input appears as a step in a menu path, any other input may be substituted.

INPUT SELECT

DIGITAL, ANALOG, AUTO

SETUP ▶ **INPUTS** ▶ **DVD1** ▶ **MAIN ADVANCED** ▶ **INPUT SELECT**

Controls the interaction of the digital and analog audio input connectors assigned for the selected Main Zone input. The INPUT SETUP menu can be used to assign one digital and one analog audio input connector for the selected input. Refer to pages 3-7 and 3-8 for more information.

When the Shift command bank is activated, the remote control 7/5 button can be used to adjust the INPUT SELECT parameter, cycling through the DIGITAL, ANALOG, and AUTO settings.

The table shown on the next page describes INPUT SELECT parameter settings.

Note:

When the INPUT SELECT parameter is set to AUTO, the SDP-5 will not select the assigned analog audio input connector when a valid digital audio input source is present. Some DVD and CD players output digital signals (data) when the player is paused or stopped or when the player is powered on and the disc drawer is empty. When this occurs, the SDP-5 automatically selects the assigned digital audio input connector.

INPUT SELECT Parameter Settings

The table below describes INPUT SELECT parameter settings.

DIGITAL	ANALOG	AUTO
<p>The SDP-5 automatically sets the INPUT SELECT parameter to DIGITAL when the ANALOG IN parameter is set to NONE.</p> <ul style="list-style-type: none"> The SDP-5 sends the assigned digital audio input connector to the Main Zone audio output connectors. The SDP-5 ignores the assigned analog audio input connector. The digital audio input connectors are compatible with PCM (44.1, 48, 88.2, and 96kHz), Dolby Digital, and dts(-ES) sources. If an incompatible digital audio source (i.e. MPEG or MP3) is present, the SDP-5 automatically selects the assigned analog audio input connector. The DIGITAL IN parameter (3-7) can be used to assign a digital audio input connector for the selected input. 	<p>The SDP-5 automatically sets the INPUT SELECT parameter to ANALOG when the DIGITAL IN parameter is set to NONE.</p> <ul style="list-style-type: none"> The SDP-5 sends the assigned analog audio input connector to the Main Zone audio output connectors. The SDP-5 ignores the assigned digital audio input connector. The ANALOG IN parameter (3-8) can be used to assign an analog audio input connector for the selected input. 	<p>The SDP-5 automatically sets the INPUT SELECT parameter to AUTO when both digital and analog audio input connectors are assigned.</p> <ul style="list-style-type: none"> The SDP-5 toggles between sending the assigned digital and analog audio input connectors to the Main Zone audio output connectors based on the input source that is present. For example: <ul style="list-style-type: none"> When a 2-channel PCM, Dolby Digital, or dts(-ES) source is present, the SDP-5 automatically selects the assigned digital audio input connector. When an SACD source is present, the SDP-5 automatically selects the assigned analog audio input connector. The AUTO setting is recommended for components that generate both digital and analog signals, such as DVD/SACD players.

... MAIN ADVANCED continues on page 3-20

MAIN ADVANCED (continued from page 3-19)

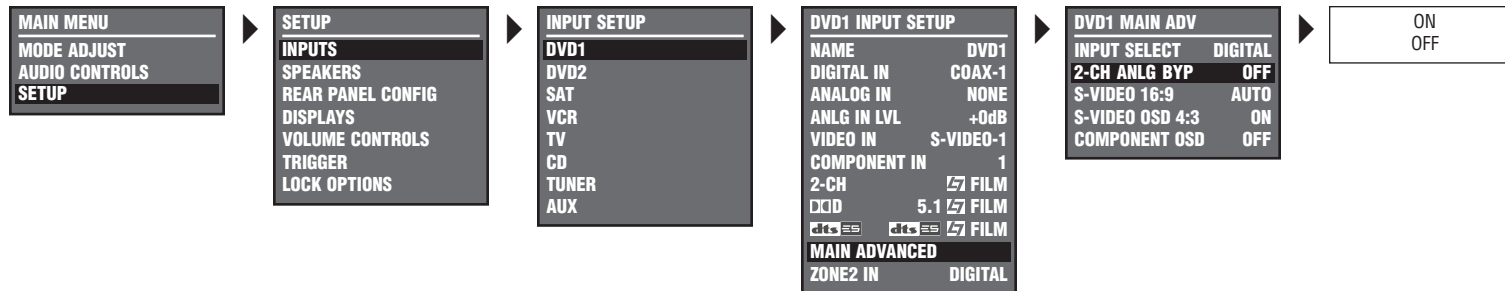

The DVD1 INPUT SETUP menu is shown here as an example, and will continue to be shown as an example throughout this section. Whenever it appears, any other INPUT SETUP menu may be substituted. Likewise, whenever the DVD1 input appears as a step in a menu path, any other input may be substituted.

2-CH ANLG BYP

ON, OFF

SETUP ▶ **INPUTS** ▶ **DVD1** ▶ **MAIN ADVANCED** ▶ **2-CH ANLG BYP**

Allows 2-channel analog audio input sources to bypass A/D conversion and internal processing. When set to ON, the SDP-5 passes analog audio input signals to the corresponding Main Zone audio output connectors. When a 5.1-channel analog audio source is present, the SDP-5 passes only (L) and (R) analog audio input signals to the Main Zone audio output connectors labeled Front L/R. When set to OFF, all analog audio input signals are sent through A/D conversion and internal processing before passing to the Main Zone audio output connectors.

Note:

When the Shift command bank is activated, pressing the remote control 2 CH button toggles the 2-CH ANLG BYP parameter setting ON and OFF.

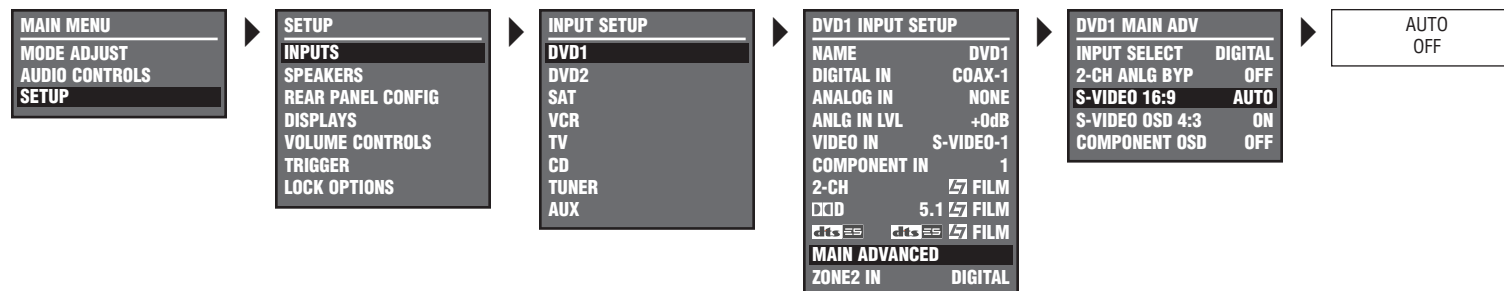

The DVD1 INPUT SETUP menu is shown here as an example, and will continue to be shown as an example throughout this section. Whenever it appears, any other INPUT SETUP menu may be substituted. Likewise, whenever the DVD1 input appears as a step in a menu path, any other input may be substituted.

S-VIDEO 16:9

AUTO, OFF

SETUP ▶ **INPUTS** ▶ **DVD1** ▶ **MAIN ADVANCED** ▶ **S-VIDEO 16:9**

Controls the passage of anamorphic trigger signals present in some video sources. When set to AUTO, the SDP-5 allows anamorphic video input signals to pass through the S-video switcher, enabling compatible display devices to automatically switch between anamorphic and non-anamorphic display modes. When set to OFF, the SDP-5 prevents anamorphic video input signals from passing through the S-video switcher, preventing compatible display devices from automatically switching between anamorphic and non-anamorphic display modes.

... MAIN ADVANCED continues on page 3-22

MAIN ADVANCED (continued from page 3-21)

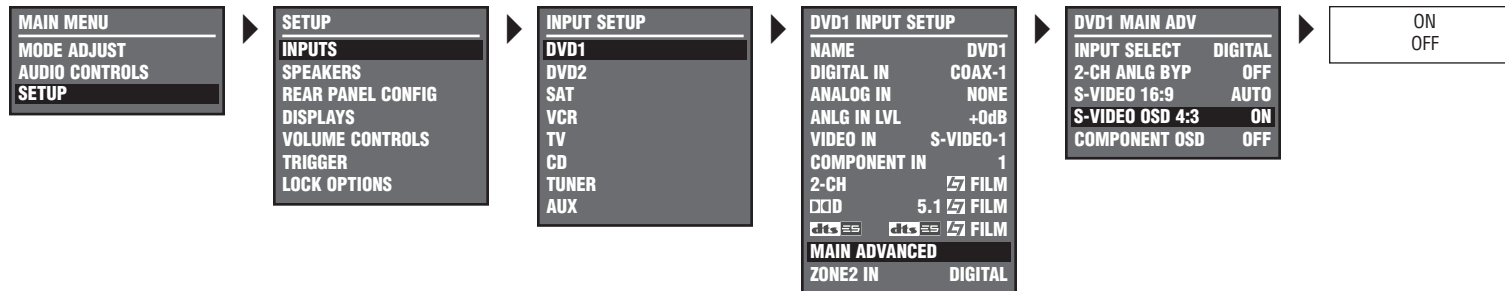

The DVD1 INPUT SETUP menu is shown here as an example, and will continue to be shown as an example throughout this section. Whenever it appears, any other INPUT SETUP menu may be substituted. Likewise, whenever the DVD1 input appears as a step in a menu path, any other input may be substituted.

S-VIDEO OSD 4:3

ON, OFF

SETUP ▶ **INPUTS** ▶ **DVD1** ▶ **MAIN ADVANCED** ▶ **S-VIDEO OSD 4:3**

Controls the appearance of the on-screen display when the display device is connected to an S-video output connector. When set to ON, the display device shows the on-screen display in a 4:3 aspect ratio* regardless of the incoming signal. When set to OFF, the display device shows the on-screen display in the same aspect ratio as the input signal.

* Aspect ratio refers to the size of the picture on the display device screen or to the size of the display device screen. A 4:3 aspect ratio is almost square. A 16:9 aspect ratio, often referred to as "widescreen," is almost twice as wide as high.

Note:

The on-screen display appears horizontally stretched across the display device screen when all of the following conditions are met:

- The S-VIDEO OSD (4:3) parameter is set to OFF.
- An anamorphic video input signal is present.
- A 16:9 display device (widescreen) is connected to an S-video output connector.

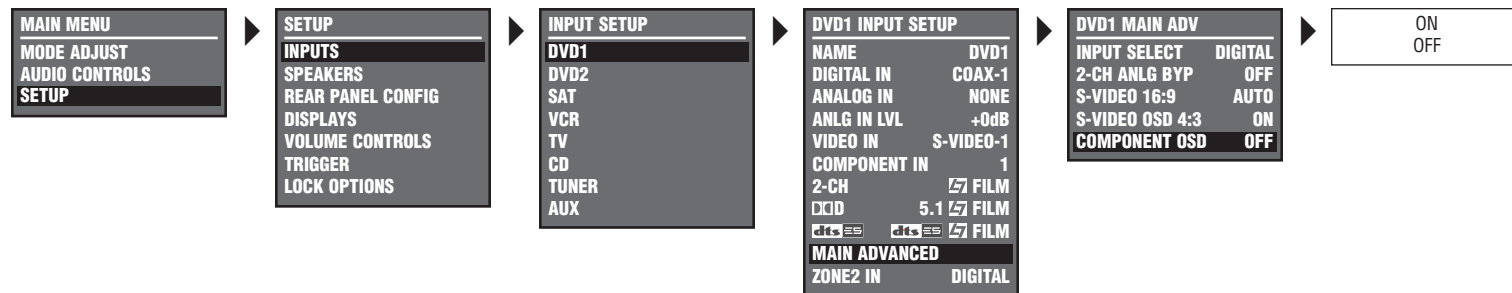

The DVD1 INPUT SETUP menu is shown here as an example, and will continue to be shown as an example throughout this section. Whenever it appears, any other INPUT SETUP menu may be substituted. Likewise, whenever the DVD1 input appears as a step in a menu path, any other input may be substituted.

COMPONENT OSD

ON, OFF

SETUP ▶ INPUTS ▶ DVD1 ▶ MAIN ADVANCED ▶ COMPONENT OSD

Controls the appearance of the on-screen display when the display device is connected to the component video output connector. When set to ON, the display device shows the on-screen display as a 480i video signal on a full blue-screen background. To minimize viewing distractions, the two-line status does not appear on the on-screen display. When set to OFF, the display device does not show the on-screen display, including the two-line status (2-18).

Note:

When the ON-SCREEN DISPLAY menu BACKGROUND parameter (3-51) is set to OFF, the display device using the component video output connector will not show the on-screen display.

ZONE2 IN

DIGITAL, ANLG, DMIX

SETUP ▶ **INPUTS** ▶ **DVD1** ▶ **ZONE2 IN**

Controls the interaction of the digital and analog audio input connectors assigned to the selected Zone 2 input. The INPUT SETUP menu can be used to assign one digital and one analog audio input connector for the selected input. Refer to pages 3-7 and 3-8 for more information.

The table shown on the next page describes ZONE2 IN parameter settings.

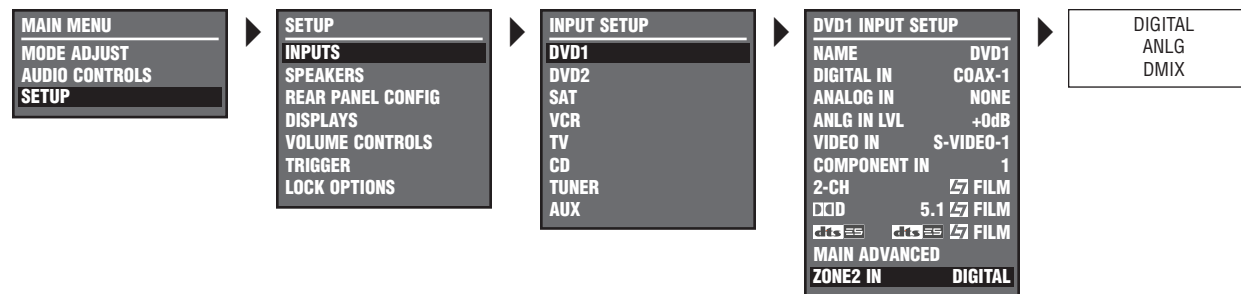

The DVD1 INPUT SETUP menu is shown here as an example, and will continue to be shown as an example throughout this section. Whenever it appears, any other INPUT SETUP menu may be substituted. Likewise, whenever the DVD1 input appears as a step in a menu path, any other input may be substituted.

CAUTION When the ZONE2 IN parameter is set to DIGITAL or ANLG, the SDP-5 recognizes some dts-encoded input sources as audio signals (not data signals) and outputs loud digital noise from the Zone 2 audio output connectors.

ZONE2 IN Parameter Settings

The table below describes ZONE2 IN parameter settings.

DIGITAL	ANLG (Analog)	DMIX (Downmix)
<p>The SDP-5 automatically sets the ZONE2 IN parameter to DIGITAL when the ANALOG IN parameter is set to NONE.</p> <ul style="list-style-type: none"> The SDP-5 sends the assigned digital audio input connector to the Zone 2 audio output connectors. The SDP-5 ignores the assigned analog audio input connector. Independent zone monitoring is available. The DIGITAL IN parameter (3-7) can be used to assign a digital audio input connector for the selected input. 	<p>The SDP-5 automatically sets the ZONE2 IN parameter to ANLG when the DIGITAL IN parameter is set to NONE.</p> <ul style="list-style-type: none"> The SDP-5 sends the assigned analog audio input connector to the Zone 2 audio output connectors. The SDP-5 ignores the assigned digital audio input connector. Independent zone monitoring is available. The ANALOG IN parameter (3-8) can be used to assign an analog audio input connector for the selected input. 	<p>Set the ZONE2 IN parameter to DMIX to send a downmixed version of Main Zone audio to the Zone 2 audio output connectors. Downmixes can be generated for Dolby Digital and dts(-ES) sources.</p> <ul style="list-style-type: none"> To generate a downmix, the same input must be selected in the Main Zone and Zone 2. Otherwise, the Zone 2 audio output connectors will mute. Main Zone listening mode activation affects the Zone 2 audio output connectors. For instance, when the MONO listening mode is activated in the Main Zone, the Zone 2 audio output connectors will generate mono output signals. Downmixes cannot be generated when the 5.1a BYPASS listening mode is activated in the Main Zone. However, when the ZONE2 IN parameter is set to DMIX, the signals from the Main Zone audio output connectors labeled Front L/R are sent to Zone 2. Signals from other Main Zone audio output connectors are ignored. Independent zone monitoring is NOT available. It is recommended to set the ZONE2 IN parameter to DMIX when recording from a DVD player without built-in Dolby Digital or dts-ES decoding to a VCR or PVR (i.e. Tivo® or Replay TV®). The SDP-5 automatically uses LOGIC7 encoding to downmix multi-channel input sources (except 5.1-channel analog sources) to LOGIC7-encoded stereo output signals for listening and recording. LOGIC7-encoded downmixes are compatible with matrix decoders, but will sound best when played back through a LOGIC7 listening mode.

SPEAKER SETUP

SETUP ▶ **SPEAKERS** ▶ **SPEAKER SETUP**

Selecting the SETUP menu SPEAKERS option opens the SPEAKER SETUP menu shown below, which can be used to configure the Main Zone audio output connectors for the desired speaker setup, set speaker distances, and calibrate output levels. The SDP-5 has eight Main Zone audio output connectors labeled Front L/R, Center, Subwoofer, Side L/R, and Rear L/R.

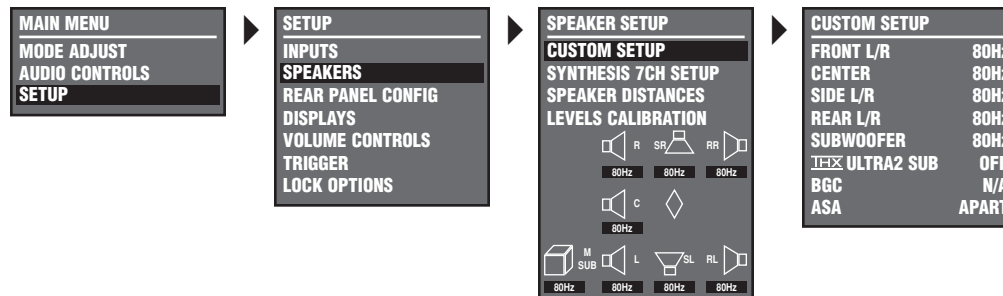

CUSTOM SPEAKER SETUPS

SETUP ▶ **SPEAKERS** ▶ **CUSTOM SETUP**

Selecting the SPEAKER SETUP menu CUSTOM SETUP option opens the CUSTOM SETUP menu shown above, which can be used to configure the Main Zone audio output connectors for a custom speaker setup. The CUSTOM SETUP menu allows the selection of independent crossover points for each Main Zone audio output connector. Refer to the the paragraph below for more information about determining crossover points.

Determining Crossover Points

The CUSTOM SETUP menu shown above can be used to assign independent crossover points for each Main Zone audio output connector. Crossover points can be selected in 10Hz increments

within a 30 to 120Hz range. With the exception of THX 80Hz, all crossover points activate a 24dB-per-octave filter. The graphs on the next page indicate the frequency response of these crossover points.

The THX 80Hz crossover point activates a 12dB-per-octave filter for the Main Zone audio output connectors labeled Front L/R, Center, Side L/R, and Rear L/R, and a 24dB-per-octave filter for the Main Zone audio output connector labeled Subwoofer.

For each Main Zone audio output connector, select the crossover point closest to the low-frequency rating of the associated speaker. For the output connector labeled Subwoofer, select the crossover point equal to the lowest crossover point of the other speakers.

In general, low frequencies will be redirected from speakers with the highest crossover points to speakers with the lowest crossover points. Low-frequency signals lower than the lowest crossover point will be redirected to the subwoofer. If the lowest crossover point is FULL, low-frequency signals, excluding LFE information, will not be redirected to the subwoofer.

Highpass Filter

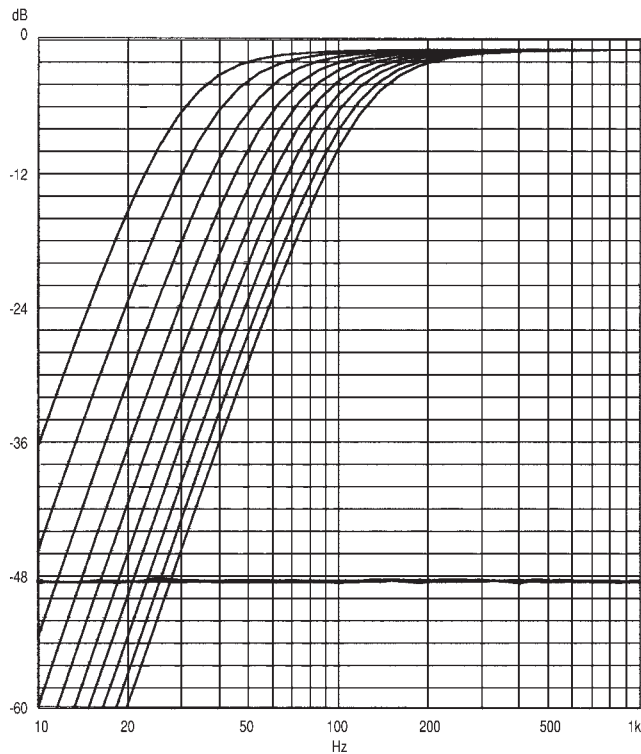

Highpass filters attenuate low frequencies at 24dB per octave. The curves in the graph above indicate the frequency response of each crossover setting. From left to right, the curves represent crossover settings from 30 to 120Hz. The graph above does not show the THX 80Hz crossover point, which is 12dB per octave.

Lowpass Filter

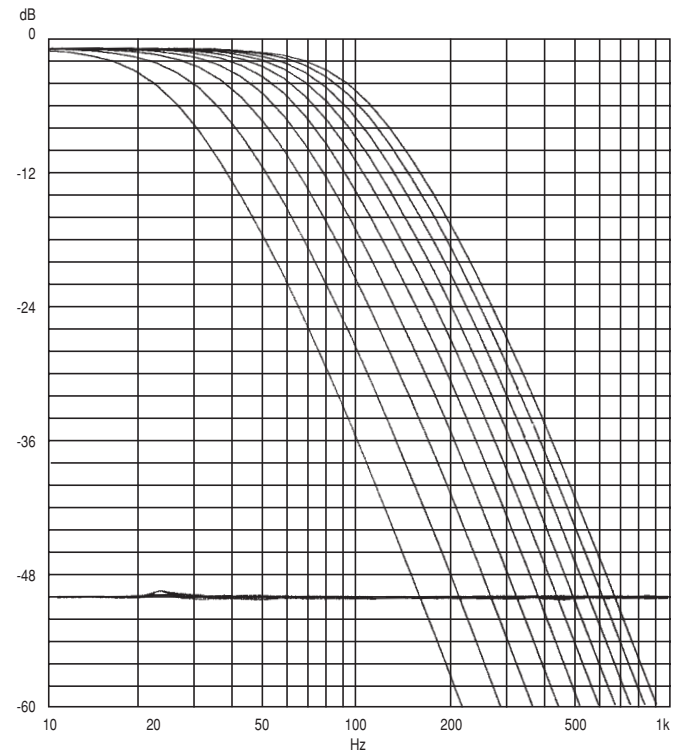

Lowpass filters attenuate high frequencies at 24dB per octave. The curves in the graph above indicate the frequency response of each crossover setting. From left to right, the curves represent crossover settings from 30 to 120Hz.

... Custom Speaker Setups continues on page 3-28

Custom Speaker Setups (continued from page 3-27)

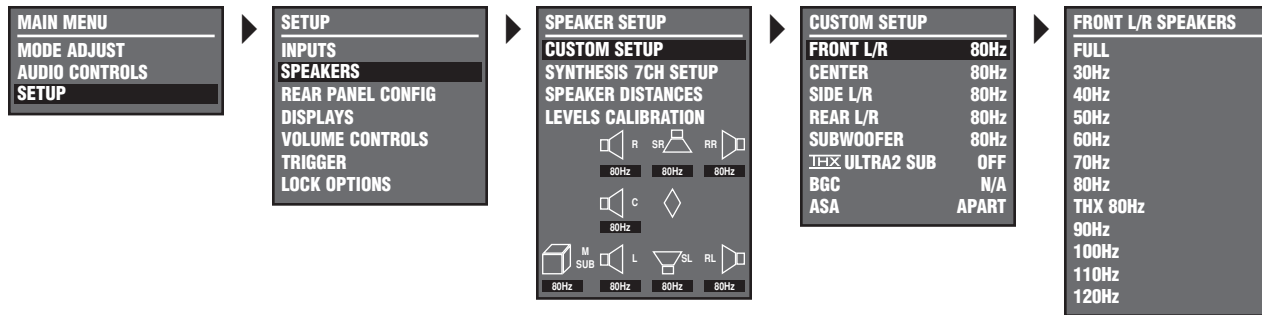

Parameter	Default Setting	Possible Settings
FRONT L/R	80Hz	FULL, 30 to 120Hz, THX 80Hz
CENTER	80Hz	FULL, 30 to 120Hz, THX 80Hz, NONE
SIDE L/R	80Hz	FULL, 30 to 120Hz, THX 80Hz, NONE
REAR L/R	80Hz	FULL, 30 to 120Hz, THX 80Hz, NONE
SUBWOOFER	80Hz	FULL, 30 to 120Hz, THX 80Hz, NONE
THX ULTRA2 SUB	OFF	ON, OFF
BGC	N/A	ON, OFF
ASA	APART	TOGETHER, CLOSE, APART

FRONT L/R

FULL, 30Hz to 120Hz, THX 80Hz

SETUP ▶ **SPEAKERS** ▶ **CUSTOM SETUP** ▶ **FRONT L/R**

Opens the FRONT L/R SPEAKERS menu shown above, which can be used to select a crossover point for the Main Zone audio output connectors labeled Front L/R. When set to FULL, the SDP-5 sends a full-range audio output signal to these connectors. Otherwise, the SDP-5 activates a crossover point at the selected setting. Choose the setting closest to the low-frequency rating of the associated speakers.

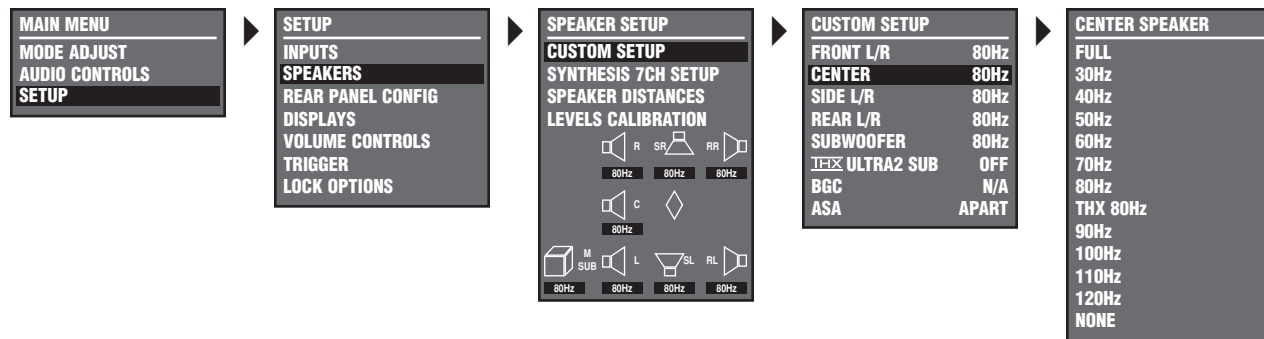
**CENTER**

FULL, 30Hz to 120Hz, THX 80Hz, NONE

SETUP ▶ **SPEAKERS** ▶ **CUSTOM SETUP** ▶ **CENTER**

Opens the CENTER SPEAKER menu shown above, which can be used to select a crossover point for the Main Zone audio output connector labeled Center. When set to FULL, the SDP-5 sends a full-range audio output signal to this connector. Otherwise, the SDP-5 activates a crossover point at the selected setting. Choose the setting closest to the low-frequency rating of the associated speaker. When set to NONE, the SDP-5 redirects center channel signals to the Main Zone audio output connectors labeled Front L/R.

Note:

When the CENTER parameter is set to NONE, center channel signals will not be redirected if the 5.1a BYPASS listening mode is activated. To redirect center channel signals, configure the speaker setup with the associated DVD-A/SACD player.

... Custom Speaker Setups continues on page 3-30

Custom Speaker Setups (continued from page 3-29)

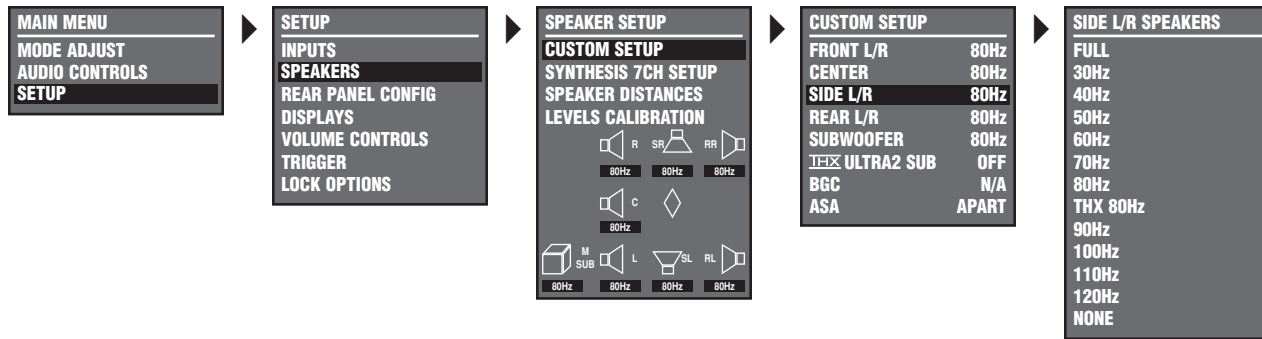

SIDE L/R FULL, 30Hz to 120Hz, THX 80Hz, NONE

SETUP ▶ **SPEAKERS** ▶ **CUSTOM SETUP** ▶ **SIDE L/R**

Opens the SIDE L/R SPEAKERS menu shown above, which can be used to select a crossover point for the Main Zone audio output connectors labeled Side L/R. When set to FULL, the SDP-5 sends a full-range audio output signal to these connectors. Otherwise, the SDP-5 activates a crossover point at the selected setting. Choose the setting closest to the low-frequency rating of the associated speakers.

When set to NONE, the SDP-5 redirects side channel signals to the Main Zone audio output connectors labeled Rear L/R. If the CUSTOM SETUP menu REAR L/R parameter is also set to NONE, the SDP-5 redirects surround channel signals to the Main Zone audio output connectors labeled Front L/R.

Note:

When the SIDE L/R parameter is set to NONE, Dolby Digital Surround EX, THX Ultra2, THX Surround EX, and dts-ES decoding are not available.

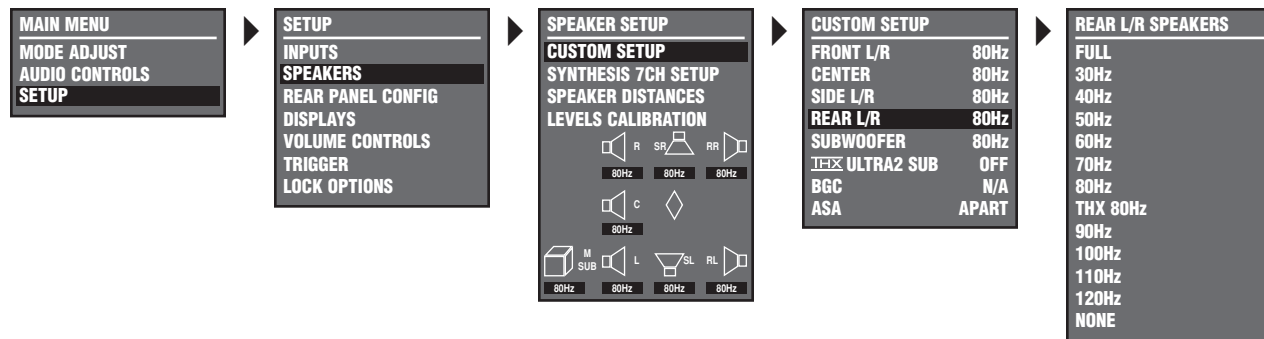

REAR L/R FULL, 30Hz to 120Hz, THX 80Hz, NONE

SETUP ▶ **SPEAKERS** ▶ **CUSTOM SETUP** ▶ **REAR L/R**

Opens the REAR L/R SPEAKERS menu shown above, which can be used to select a crossover point for the Main Zone audio output connectors labeled Rear L/R. When set to FULL, the SDP-5 sends a full-range audio output signal to these connectors. Otherwise, the SDP-5 activates a crossover point at the selected setting. Choose the setting closest to the low-frequency rating of the associated speakers.

When set to NONE, the SDP-5 redirects rear channel signals to the Main Zone audio output connectors labeled Side L/R. If the CUSTOM SETUP menu SIDE L/R parameter is also set to NONE, the SDP-5 redirects surround channel signals to the Main Zone audio output connectors labeled Front L/R.

Note:

When the REAR L/R parameter is set to NONE:

- *Dolby Digital Surround EX, THX Ultra2, THX Surround EX, and dts-ES decoding are not available.*
 - *The ASA parameter is not available.*
-

... Custom Speaker Setups continues on page 3-32

Custom Speaker Setups (continued from page 3-31)

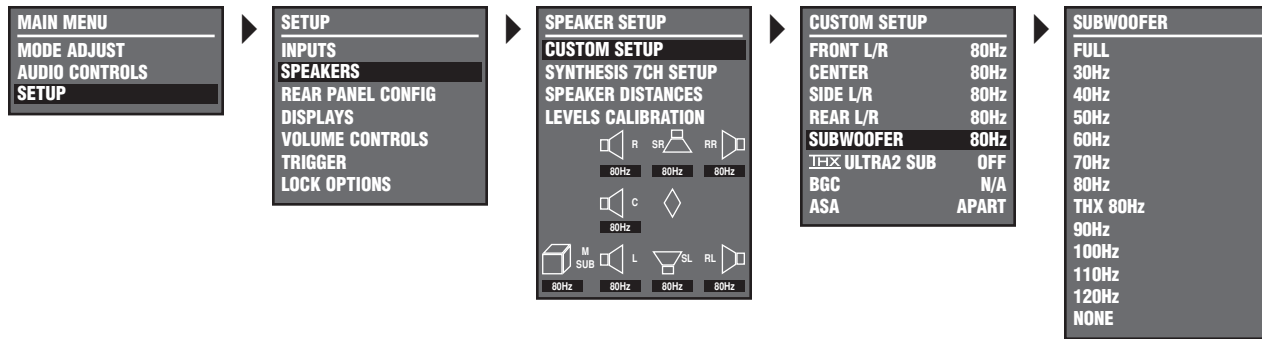

SUBWOOFER FULL, 30Hz to 120Hz, THX 80Hz, NONE

SETUP ▶ **SPEAKERS** ▶ **CUSTOM SETUP** ▶ **SUBWOOFER**

Opens the SUBWOOFER menu shown above, which can be used to select a crossover point for the Main Zone audio output connector labeled Subwoofer. When set to FULL, the SDP-5 sends a full-range audio output signal to this connector. Otherwise, the SDP-5 activates a crossover point at the selected setting. Choose the setting equal to the lowest setting of the other speakers.

Note:

When the SUBWOOFER parameter is set to NONE, subwoofer signals will not be redirected if the 5.1a BYPASS listening mode is activated. To redirect subwoofer signals, configure the speaker setup with the associated DVD-A/SACD player.

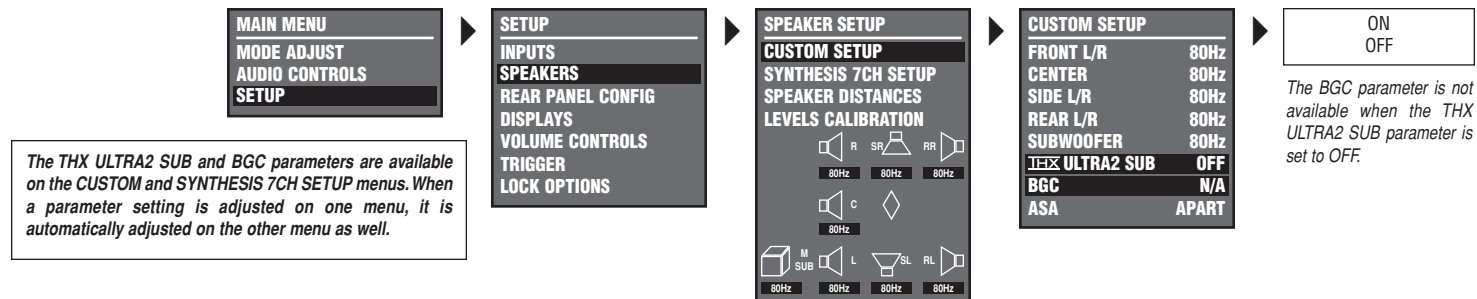
**THX ULTRA2 SUB**

ON, OFF

SETUP ▶ **SPEAKERS** ▶ **CUSTOM SETUP** or **SYNTHESIS 7CH SETUP** ▶
THX ULTRA2 SUB

Indicates whether or not the subwoofer connected to the Main Zone audio output connector labeled Subwoofer is Ultra2 certified. Select the ON setting if the connected subwoofer is Ultra2 certified and the OFF setting if the connected subwoofer is not Ultra2 certified. When set to ON, the CUSTOM and SYNTHESIS 7CH SETUP menu BGC parameter (next column) can be used to adjust boundary gain compensation. When set to OFF, the BGC parameter is not available (N/A).

BGC (Boundary Gain Compensation)

ON, OFF

SETUP ▶ **SPEAKERS** ▶ **CUSTOM SETUP** or **SYNTHESIS 7CH SETUP** ▶ **BGC**

Adjusts boundary gain compensation when the CUSTOM and SYNTHESIS 7CH SETUP menu THX ULTRA2 SUB parameter is set to ON. When the BGC parameter is set to ON, a highpass 55Hz filter is applied to all Main Zone listening modes and audio output connectors. When set to OFF, no filter is applied to Main Zone listening modes and audio output connectors. When the parameter setting is N/A, the THX ULTRA2 SUB parameter is set to OFF and boundary gain compensation cannot be adjusted.

Note:

BGC compensates for increased bass energy that is caused by the proximity of the speakers to the listening room walls.

... Custom Speaker Setups continues on page 3-34

Custom Speaker Setups (continued from page 3-33)

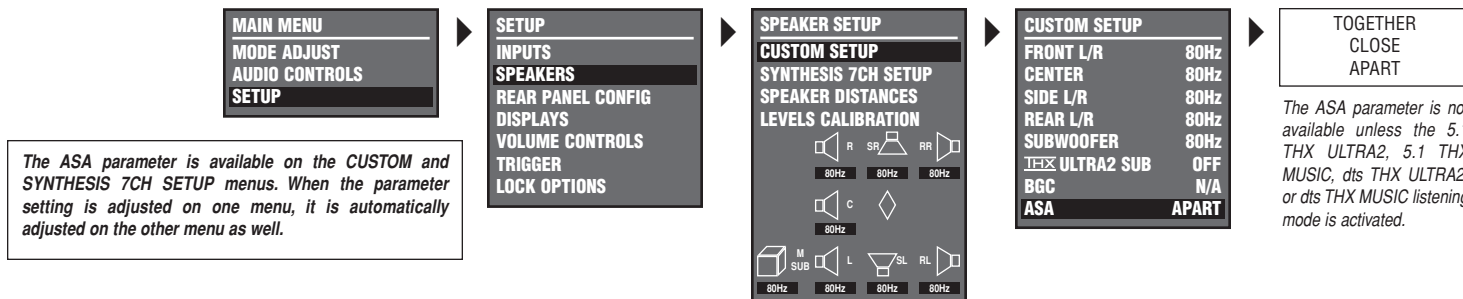

ASA (Advanced Speaker Array) TOGETHER, CLOSE, APART

SETUP ▶ **SPEAKERS** ▶ **CUSTOM SETUP** or **SYNTHESIS 7CH SETUP** ▶ **ASA**

A proprietary THX technology that processes signals sent to the rear speakers, optimizing the listening experience for THX Ultra2 listening modes. To maximize the effectiveness of ASA processing, it is recommended to configure a 7-channel speaker setup in which the rear speakers are placed close together facing the center of the listening space. **The ASA parameter is not available unless the 5.1 THX ULTRA2, 5.1 THX MUSIC, dts THX ULTRA2, or dts THX MUSIC listening mode is activated.**

Select the TOGETHER setting if the distance between the rear speakers is less than 1 foot (0.3m). Select the CLOSE setting if the distance between the rear speakers is greater than 1 foot (0.3m), but less than 4 feet (1.2m). Select the APART setting if the distance between the rear speakers is greater than 4 feet (1.2m).

Note:

ASA processing is only available when both side and rear speakers are present.

When the remote control 7/5 button is used to toggle between 7- and 5-channel playback:

- ASA processing is not available during 5-channel playback.
- The SDP-5 automatically switches between the 5.1 THX ULTRA2 and 5.1 THX or dts THX ULTRA2 and dts THX listening modes.

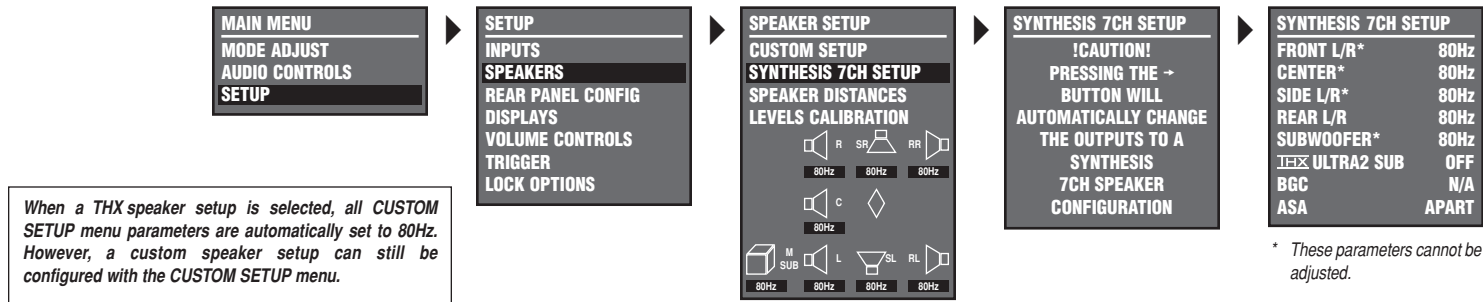

SYNTHESIS 7-CHANNEL SPEAKER SETUPS

SETUP ▶ SPEAKERS ▶ SYNTHESIS 7CH SETUP

When the SPEAKER SETUP menu SYNTHESIS 7CH SETUP option is selected, the SYNTHESIS 7CH SETUP message shown above appears on the on-screen and front panel displays. When this message appears, press the remote control ▶ arrow to open the SYNTHESIS 7CH SETUP menu and configure the Main Zone audio output connectors for a JBL Synthesis 7-channel speaker setup or press the ◀ arrow to close the message without configuring the Main Zone audio output connectors for a JBL Synthesis 7-channel speaker setup.

When the SYNTHESIS 7CH SETUP menu opens, the Main Zone audio output connectors are configured for a JBL Synthesis 7-channel speaker setup. The SDP-5 ignores all CUSTOM SETUP menu parameter settings and applies an 80Hz crossover point with 24dB per-octave filter to all output connectors. This configuration is applied to all inputs and listening modes.

Note:

- A JBL Synthesis 7-channel speaker setup includes THX-certified loudspeakers. Use the CUSTOM SETUP menu to configure a custom speaker setup for systems that do not include THX-certified loudspeakers.
- A JBL Synthesis 7-channel speaker setup is not required to activate THX listening modes.

Parameter	Default Setting	Possible Setting(s)
FRONT L/R*	80Hz	80Hz
CENTER*	80Hz	80Hz
SIDE L/R*	80Hz	80Hz
REAR L/R	80Hz	80Hz, NONE
SUBWOOFER*	80Hz	80Hz
THX ULTRA2 SUB	OFF	ON, OFF
BGC	N/A	ON, OFF
ASA	APART	TOGETHER, CLOSE, APART

* These parameters cannot be adjusted.

... Synthesis 7-Channel Speaker Setups continues on page 3-36

JBL Synthesis 7-Channel Speaker Setups (continued from page 3-35)

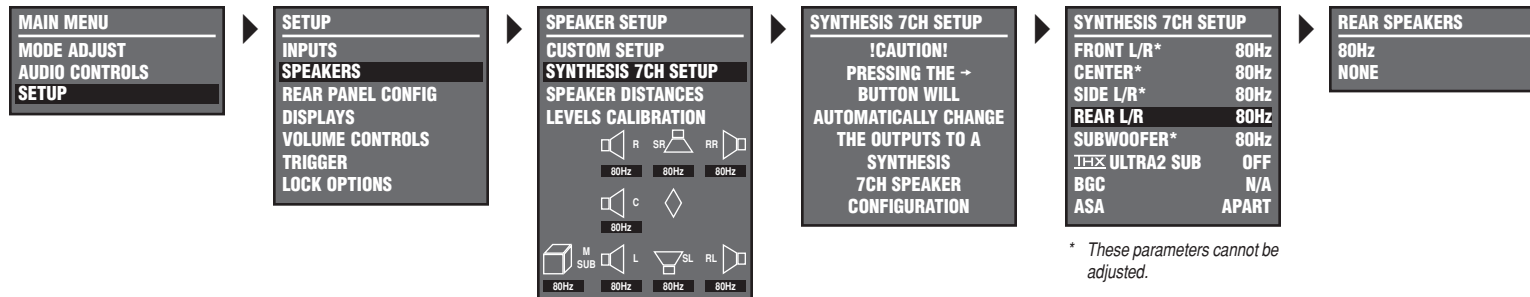

* These parameters cannot be adjusted.

REAR L/R

THX 80Hz, NONE

SETUP ▶ **SPEAKERS** ▶ **SYNTHESIS 7CH SETUP** ▶ **REAR L/R**

Opens the REAR SPEAKERS menu shown above, which can be used to activate and deactivate the Main Zone audio output connectors labeled Rear L/R. When set to 80Hz, the SDP-5 activates these connectors and configures all Main Zone audio output connectors for a JBL Synthesis 7-Channel speaker setup. When set to NONE, the SDP-5 deactivates these connectors and configures the other Main Zone audio output connectors for a JBL Synthesis 5-Channel speaker setup.

The SYNTHESIS 7CH SETUP menu THX ULTRA2 SUB, BGC, and ASA parameters are identical to the CUSTOM SETUP menu THX ULTRA2 SUB, BGC, and ASA parameters. When one of these parameter settings is adjusted on one menu, it is automatically adjusted on the other menu at the same time. Refer to pages 3-33 and 3-34 for these parameter descriptions.

Note:

When the REAR L/R parameter is set to NONE:

- Dolby Digital Surround EX, THX Ultra2, THX Surround EX, and dts-ES decoding are not available.
- The ASA parameter is not available.

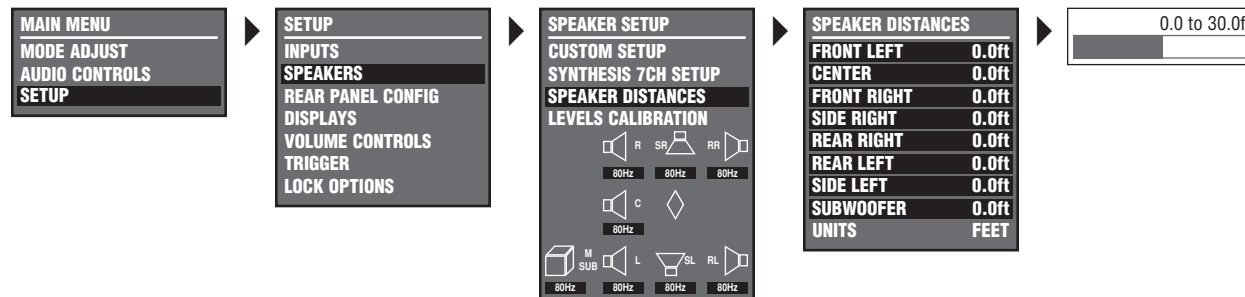

MEASURING SPEAKER DISTANCES

SETUP ▶ SPEAKERS ▶ SPEAKER DISTANCES

Selecting the SPEAKER SETUP menu SPEAKER DISTANCES option opens the SPEAKER DISTANCES menu shown above, which can be used to set the distance between the listening position and the speakers connected to the Main Zone audio output connectors. The SDP-5 features a speaker distance control that allows distances to be entered for each speaker. This helps ensure accurate signal arrival time at the listening position, but is not a substitute for proper speaker placement.

To determine the appropriate setting for each speaker, measure the distance between the listening position and the front baffle of the speaker. Then, set the corresponding SPEAKER DISTANCES menu parameter to the closest available setting.

Note:

When the system includes a calibrated JBL Digital Equalizer, speaker distance parameters should remain at their factory-default settings (0.0ft). The digital equalizer will perform arrival time correction.

Parameter	Default Setting	Possible Settings
FRONT LEFT	0.0ft	0 to 30ft or 0 to 12m
CENTER	0.0ft	0 to 30ft or 0 to 12m
FRONT RIGHT	0.0ft	0 to 30ft or 0 to 12m
SIDE RIGHT	0.0ft	0 to 30ft or 0 to 12m
REAR RIGHT	0.0ft	0 to 30ft or 0 to 12m
REAR LEFT	0.0ft	0 to 30ft or 0 to 12m
SIDE LEFT	0.0ft	0 to 30ft or 0 to 12m
SUBWOOFER	0.0ft	0 to 30ft or 0 to 12m
UNITS	FEET	FEET, METERS

... Measuring Speaker Distances continues on page 3-38

Measuring Speaker Distances (continued from page 3-37)

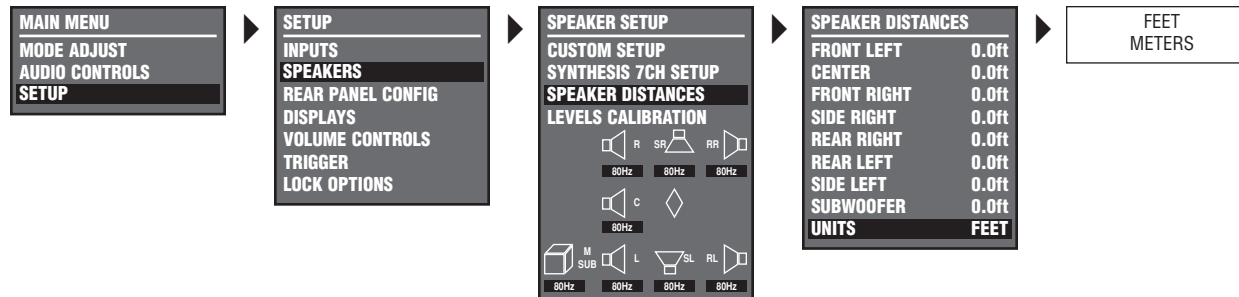

FRONT LEFT & RIGHT 0.0 to 30.0ft or 0.0 to 12.0m

SETUP ▶ **SPEAKERS** ▶ **SPEAKER DISTANCES** ▶ **FRONT LEFT** OR **FRONT RIGHT**

Set the speaker distance for the speakers connected to the Main Zone audio output connectors labeled Front L/R.

REAR LEFT & RIGHT 0.0 to 30.0ft or 0.0 to 12.0m

SETUP ▶ **SPEAKERS** ▶ **SPEAKER DISTANCES** ▶ **REAR LEFT** OR **REAR RIGHT**

Set the speaker distance for the speakers connected to the Main Zone audio output connectors labeled Rear L/R.

CENTER 0.0 to 30.0ft or 0.0 to 12.0m

SETUP ▶ **SPEAKERS** ▶ **SPEAKER DISTANCES** ▶ **CENTER**

Sets the speaker distance for the speaker connected to the Main Zone audio output connector labeled Center.

SUBWOOFER 0.0 to 30.0ft or 0.0 to 12.0m

SETUP ▶ **SPEAKERS** ▶ **SPEAKER DISTANCES** ▶ **SUBWOOFER**

Sets the speaker distance for the subwoofer connected to the Main Zone audio output connector labeled Subwoofer.

SIDE LEFT & RIGHT 0.0 to 30.0ft or 0.0 to 12.0m

SETUP ▶ **SPEAKERS** ▶ **SPEAKER DISTANCES** ▶ **SIDE LEFT** OR **SIDE RIGHT**

Set the speaker distance for the speakers connected to the Main Zone audio output connectors labeled Side L/R.

UNITS FEET, METERS

SETUP ▶ **SPEAKERS** ▶ **SPEAKER DISTANCES** ▶ **UNITS**

Defines the unit of measurement in which the SDP-5 measures speaker distances. When set to FEET, the SDP-5 measures speaker distances in feet. When set to METERS, the SDP-5 measures speaker distances in meters. When the UNITS parameter setting is toggled, the SDP-5 converts the current speaker distance to the closest available value in the selected unit of measurement.

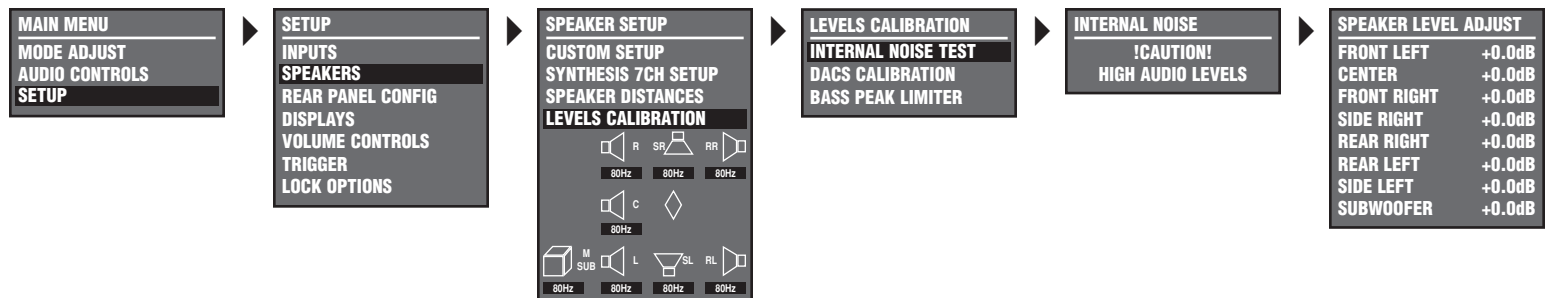

CALIBRATING OUTPUT LEVELS

SETUP ▶ **SPEAKERS** ▶ **LEVELS CALIBRATION**

Selecting the SPEAKER SETUP menu LEVELS CALIBRATION option opens the LEVELS CALIBRATION menu shown above, which can be used to calibrate output levels for the Main Zone audio output connectors. Calibration ensures that output levels correspond to THX reference levels (75dB) for input sources such as DVDs.

Please note the following to ensure accurate output level calibration:

- It is recommended to use a Sound Pressure Level (SPL) meter to calibrate output levels. An SPL meter is a device that measures the relative loudness of the speakers to ensure accurate output level calibration. SPL meters are available at Radio Shack (catalog number 33-2050).
- Before output level calibration begins, eliminate extraneous noises in the listening space, such as conversations, air conditioners, and sounds that filter in through open doors and windows.

- Before output level calibration begins, remove objects (as well as people) that obstruct the line-of-sight path between the SPL meter and the speaker being measured.
- Output levels should be calibrated from the primary listening position, placing the SPL meter at the approximate spot where the listener's head will be during listening.

INTERNAL NOISE TEST

SETUP ▶ **SPEAKERS** ▶ **LEVELS CALIBRATION** ▶ **INTERNAL NOISE TEST**

Opens the INTERNAL NOISE message shown above, which indicates that the internal noise test produces loud calibration test signals. When this message appears, press the Menu ▶ arrow to open the SPEAKER LEVEL ADJUST menu shown above and conduct the internal noise test or press the Menu ◀ arrow to close the message without conducting the internal noise test. When the SPEAKER LEVEL ADJUST menu opens, the internal noise test automatically begins.

. . . *Internal Noise Test continues on page 3-40*

Internal Noise Test (continued from page 3-39)**Note:**

The SDP-5 automatically sets volume level to +0dB when the internal noise test begins. It is recommended to avoid adjusting master volume level while the test is in progress to achieve a 75dB THX reference level (a 75dB SPL meter reading).

Note:

Main Zone audio output connectors for which the corresponding CUSTOM or SYNTHESIS 7CH SETUP menu parameter is set to NONE cannot be adjusted during the internal noise test. These output connectors can be adjusted during the external noise test, but there is no need to do so.

When the internal noise test is conducted, a calibration test signal travels to the Main Zone audio output connectors in the order listed on the SPEAKER LEVEL ADJUST menu. As the calibration test signal travels, the cursor automatically scrolls downward through SPEAKER LEVEL ADJUST menu parameters, highlighting each speaker parameter as the corresponding output connector is tested. Each output connector is tested for about 4 seconds.

The SPEAKER LEVEL ADJUST menu can be used to manually adjust output levels while the internal noise test is conducted. Refer to page 3-42 for more information.

Please note the following:

- When the internal noise test is conducted, it is possible to select a SPEAKER LEVEL ADJUST menu parameter just as the SDP-5 is about to automatically scroll to the next parameter, causing the SDP-5 to send the calibration noise to both speakers. If this occurs, reselect the desired speaker.

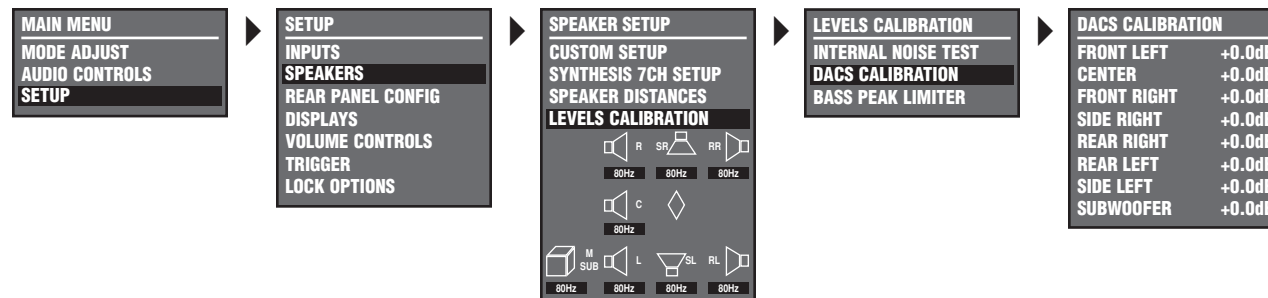

DACS CALIBRATION

SETUP ▶ **SPEAKERS** ▶ **LEVELS CALIBRATION** ▶ **DACS CALIBRATION**

Opens the DACS CALIBRATION menu shown above, which can be used to adjust output levels while DACS calibration is conducted. DACS calibration requires an external calibration source, such as an audio calibration disc or, in JBL Synthesis systems, the DACS® (JBL Digital Acoustical Calibration System). An audio calibration disc can be used with the DACS.

To optimize systems that include DACS and a JBL Digital Equalizer:

1. Connect the DACS Signal Generator left and right output connectors labeled EVP-1 to the SDP-5 analog audio input connectors labeled 1. These connectors are active in the TAPE input.
2. Set the master volume level to 0dB.

This will provide the correct signal path and reference output level.

When DACS calibration is conducted, the SDP-5 activates a listening mode based on the Main Zone input source that is present. The table in the next column indicates the listening mode that is activated for each input source. When a listening mode is activated during DACS calibration, it retains its factory-default settings, ignoring custom settings that might have been selected on the corresponding listening mode menu. Custom settings will be restored after DACS calibration is complete.

2-Channel Sources	Dolby Digital Sources	dts(-ES) Sources
DOLBY PLII MOVIE	DOLBY DIGITAL*	dts(-ES)*

* These listening mode names differ depending on the input source, the speaker configuration, and certain parameter settings.

SPEAKER LEVEL ADJUST & DACS CALIBRATION Menus

Conducting the internal noise test opens the SPEAKER LEVEL ADJUST menu shown on page 3-39. Conducting DACS calibration opens the DACS CALIBRATION menu shown on the previous page. Both menus can be used to adjust output levels for the Main Zone audio output connectors.

Parameter	Default Setting	Possible Settings
FRONT LEFT	0.0dB	-18.0 to +12.0dB
CENTER	0.0dB	-18.0 to +12.0dB
FRONT RIGHT	0.0dB	-18.0 to +12.0dB
SIDE RIGHT	0.0dB	-18.0 to +12.0dB
REAR RIGHT	0.0dB	-18.0 to +12.0dB
REAR LEFT	0.0dB	-18.0 to +12.0dB
SIDE LEFT	0.0dB	-18.0 to +12.0dB
SUBWOOFER	0.0dB	-18.0 to +12.0dB

To manually adjust output levels while the internal noise test or DACS calibration is conducted:

1. When the internal noise test is conducted, set the SPL meter to "C" weighting and "SLOW" response. When DACS calibration is conducted, set the SPL meter according to the DACS Installers Manual or audio calibration disc instructions. If no setting is specified, set the SPL meter to "C" weighting and "SLOW" response.
2. Press the remote control ▲ and ▼ arrows to highlight the desired SPEAKER LEVEL ADJUST or DACS CALIBRATION menu parameter.

3. When the desired parameter is highlighted, press the ► arrow to select this parameter. A horizontal bar graph will open on the on-screen and front panel displays.
4. When the horizontal bar graph opens, follow the instructions on page 2-11 to adjust the selected parameter. When the SPL meter is set to "C" weighting and "SLOW" response, output levels should be adjusted to achieve a 75dB SPL meter reading from the primary listening position. When the SPL meter is not set to "C" weighting and "SLOW" response, output levels should be adjusted to achieve the appropriate SPL meter reading from the primary listening position.
5. When the desired adjustments have been made, press the ◀ arrow to close the horizontal bar graph and return to the SPEAKER LEVEL ADJUST or DACS CALIBRATION menu. When the internal noise test is conducted, the internal noise test will continue, and automatic scrolling will resume.

FRONT LEFT & RIGHT -18.0 to +12.0dB

SETUP ► SPEAKERS ► LEVELS CALIBRATION ► (TEST) ► FRONT LEFT OR FRONT RIGHT

Set the output levels for the speakers connected to the Main Zone audio output connectors labeled Front L/R.

CENTER -18.0 to +12.0dB

SETUP ► SPEAKERS ► LEVELS CALIBRATION ► (TEST) ► CENTER

Sets the output level for the speaker connected to the Main Zone audio output connector labeled Center.

SIDE LEFT & RIGHT

-18.0 to +12.0dB

SETUP ▶ **SPEAKERS** ▶ **LEVELS CALIBRATION** ▶ **(TEST)** ▶ **SIDE LEFT OR SIDE RIGHT**

Set the output levels for the speakers connected to the Main Zone audio output connectors labeled Side L/R.

REAR LEFT & RIGHT

-18.0 to +12.0dB

SETUP ▶ **SPEAKERS** ▶ **LEVELS CALIBRATION** ▶ **(TEST)** ▶ **REAR LEFT OR REAR RIGHT**

Set the output levels for the speakers connected to the Main Zone audio output connectors labeled Rear L/R.

SUBWOOFER

-18.0 to +12.0dB

SETUP ▶ **SPEAKERS** ▶ **LEVELS CALIBRATION** ▶ **(TEST)** ▶ **SUBWOOFER**

Sets the output level for the subwoofer connected to the Main Zone audio output connector labeled Subwoofer.

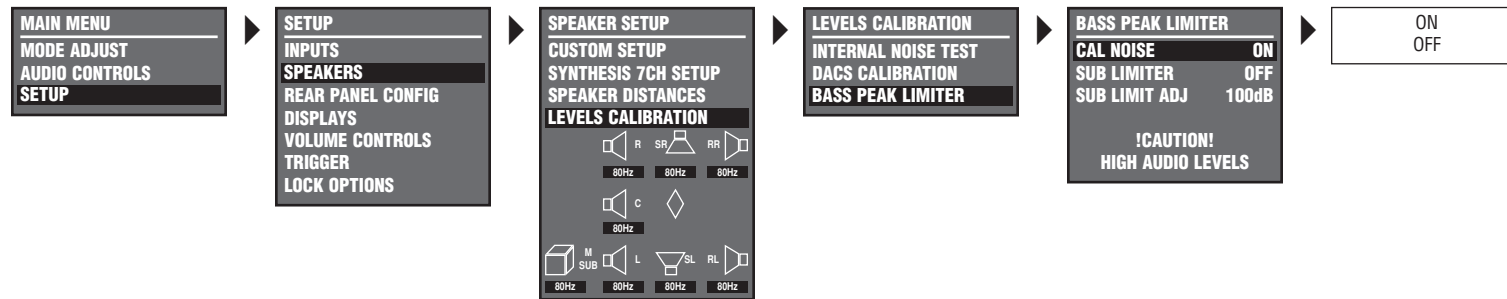

BASS PEAK LIMITER

SETUP ▶ **SPEAKERS** ▶ **LEVELS CALIBRATION** ▶ **BASS PEAK LIMITER**

Opens the BASS PEAK LIMITER menu shown above, which can be used to set amplitude limits for all speakers to which low frequencies are redirected, including the subwoofer.

The SDP-5 is equipped with an internal limiter that prevents low-frequency output signals from exceeding a designated level. This is essential for Dolby Digital and dts(-ES) input sources that produce low-frequency peaks at much higher levels than 2-channel sources. In home theaters, the subwoofer and its associated amplifier might not be able to reproduce these levels without overloading.

Parameter	Default Setting	Possible Settings
CAL NOISE	ON	ON, OFF
SUB LIMITER	OFF	ON, OFF
SUB LIMIT ADJ	100dB	75 to 120dB

CAL NOISE

ON, OFF

SETUP ▶ **SPEAKERS** ▶ **LEVELS CALIBRATION** ▶ **BASS PEAK LIMITER** ▶ **CAL NOISE**

Determines whether the bass peak limiter is set with an internal or external source. When set to ON, the SDP-5 activates an internal calibration noise signal to set the limiter. When set to OFF, the SDP-5 deactivates the internal calibration noise test signal. An external calibration source such as an audio calibration disc is required to generate a noise signal to set the bass peak limiter.

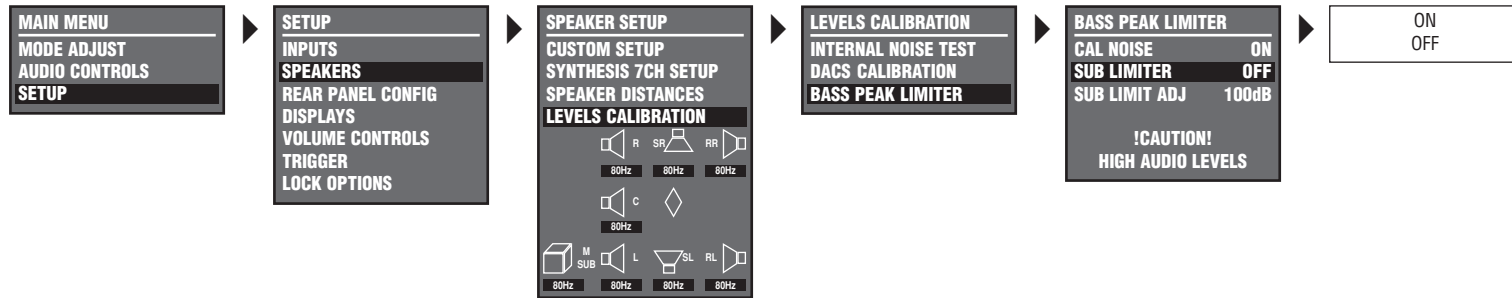

SUB LIMITER

ON, OFF



Limits output signals for the Main Zone audio output connector labeled Subwoofer, as well as other Main Zone audio output connectors to which low-frequency signals are redirected. When set to ON, the SDP-5 restricts output signals to the level specified in the BASS PEAK LIMITER menu SUB LIMIT ADJ parameter. When set to OFF, the SDP-5 does not restrict output levels, regardless of the SUB LIMIT ADJ parameter setting.

SUB LIMIT ADJ

75 to 120dB



Specifies the output level restriction placed on the Main Zone audio output connector labeled Subwoofer, as well as other Main Zone audio output connectors to which low-frequency signals are redirected. This restriction is applied when the BASS PEAK LIMITER menu SUB LIMITER parameter is set to ON. When the SUB LIMIT ADJ parameter is selected, it is automatically set to 75dB.

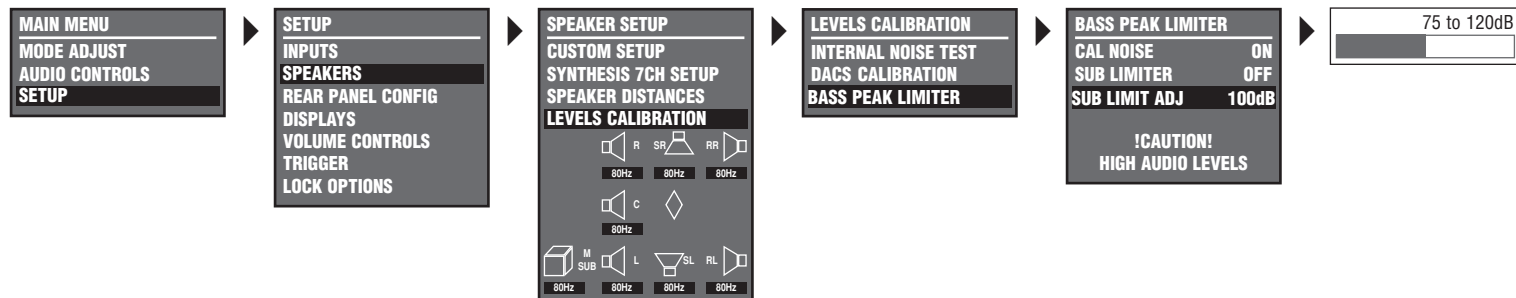

REAR PANEL CONFIG

SETUP ▶ REAR PANEL CONFIG

Selecting the SETUP menu REAR PANEL CONFIG option opens the REAR PANEL CONFIG menu shown below, which can be used to configure the analog audio input connectors as eight stereo connectors, one 5.1-channel and five stereo connectors, or two stereo and two 5.1-channel connectors.

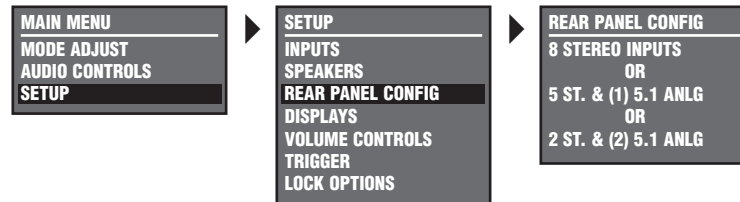

8 STEREO INPUTS

SETUP ▶ REAR PANEL CONFIG ▶ 8 STEREO INPUTS

Configures the analog audio input connectors as eight stereo connectors, which is the factory-default configuration.

When the analog audio input connectors are configured as eight stereo connectors:

- All connectors are configured as stereo connectors.
- Neither of the 5.1-channel connectors is available. Sources that were assigned to the 5.1-channel connector labeled 3, 4, and 5 are reassigned to the stereo connectors labeled 3, 4, and 5. Sources that were assigned to the 5.1-channel connector labeled 6, 7, and 8 are reassigned to the stereo connectors labeled 6, 7, and 8.

5 ST. & (1) 5.1 ANLG

SETUP ▶ REAR PANEL CONFIG ▶ 5 ST. & (1) 5.1 ANLG

Configures the analog audio input connectors as one 5.1-channel and five stereo connectors.

When the analog audio input connectors are configured as one 5.1-channel and five stereo connectors:

- The connectors labeled 1, 2, 3, 4, and 5 are configured as stereo connectors.
- The connectors labeled 6, 7, and 8 are configured as a 5.1-channel connector. This connector is sent to the Main Zone audio output connectors as indicated in the table at the bottom of the next column.

5 ST. & (1) 5.1 ANLG *(continued from page 3-45)***SETUP** ▶ **REAR PANEL CONFIG** ▶ **5 ST. & (1) 5.1 ANLG**

When the analog audio input connectors are configured as one 5.1-channel and five stereo connectors:

- Two-channel sources that were assigned to the stereo connectors labeled 6, 7, and 8 are reassigned to the 5.1-channel connector labeled 6, 7, and 8. The 5.1-channel connectors should only be used with 5.1-channel analog sources such as DVD-As and SACDs.

2 ST. & (2) 5.1 ANLG**SETUP** ▶ **REAR PANEL CONFIG** ▶ **2 ST. & (2) 5.1 ANLG**

Configures the analog audio input connectors as two stereo and two 5.1-channel connectors.

When the analog audio input connectors are configured as two stereo and two 5.1-channel connectors:

- The connectors labeled 1 and 2 are configured as stereo connectors.
- The connectors labeled 3, 4, and 5 are configured as a 5.1-channel connector, and the connectors labeled 6, 7, and 8 are configured as a 5.1-channel connector. These connectors are sent to the Main Zone audio output connectors as indicated in the table at the bottom of this column.
- Two-channel sources that were assigned to the stereo connectors labeled 3, 4, and 5 are reassigned to the 5.1-channel connector labeled 3, 4, and 5. Two-channel sources that were assigned to the stereo connectors labeled 6, 7, and 8 are reassigned to the 5.1-channel connector labeled

6, 7, and 8. The 5.1-channel connectors should only be used with 5.1-channel analog sources such as DVD-As and SACDs.

The 5.1-channel analog audio input connectors are sent to the Main Zone analog audio output connectors as shown in the table below.

Input Connector	Output Connector
(L)	Front L
(R)	Front R
(C)	Center
(SUB)	Subwoofer
(LS)	Side L and Rear L
(RS)	Side R and Rear R

DISPLAY SETUP

SETUP ▶ **DISPLAYS**

Selecting the SETUP menu DISPLAYS option opens the DISPLAY SETUP menu shown below, which can be used to customize the on-screen and front panel displays, restore audio/video synchronization, and activate and create a custom unit name.

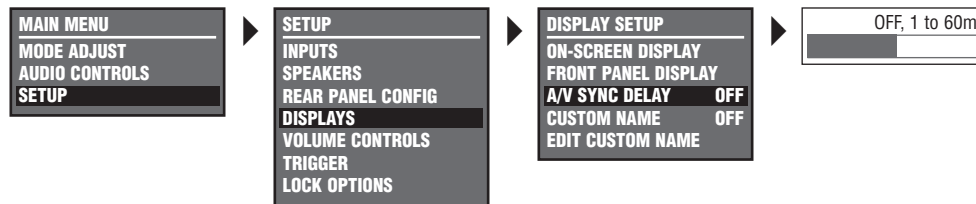

Parameter	Default Setting	Possible Settings
ON-SCREEN DISPLAY	Refer to page 3-49	
FRONT PANEL DISPLAY	Refer to page 3-52	
A/V SYNC DELAY	OFF	OFF, 1 to 60ms
CUSTOM NAME	OFF	ON, OFF
EDIT CUSTOM NAME	N/A	N/A

A/V SYNC DELAY

OFF, 1 to 60ms

SETUP ▶ **DISPLAYS** ▶ **A/V SYNC DELAY**

Restores audio/video synchronization when using products such as video processors that introduce a video signal delay. This parameter can be used to set an audio signal delay to compensate for the video signal delay.

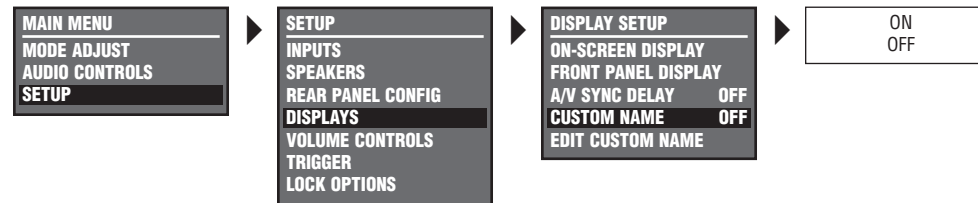

CUSTOM NAME

ON, OFF

SETUP ▶ **DISPLAYS** ▶ **CUSTOM NAME**

Activates the display of a custom unit name, which appears when the SDP-5 is activated. When set to ON, the custom name scrolls across the on-screen and front panel displays when the SDP-5 is activated. When set to OFF, the custom name does not appear when the SDP-5 is activated. The custom name can be entered in the DISPLAY SETUP menu EDIT CUSTOM NAME parameter.

EDIT CUSTOM NAME

SETUP ▶ **DISPLAYS** ▶ **EDIT CUSTOM NAME**

Opens the EDIT CUSTOM NAME menu shown below, which can be used to create a custom unit name. When the CUSTOM parameter is set to ON, the custom unit name appears on the on-screen and front panel displays when the SDP-5 is activated.

To customize the name of the SDP-5:

1. Follow the EDIT CUSTOM NAME menu path to open the EDIT CUSTOM NAME drop-down menu shown below.
2. When the EDIT CUSTOM NAME drop-down menu opens, press the remote control Menu ▲ and ▼ arrows to change the character above the cursor (^).
3. When the desired character has been selected, press the Menu ▶ arrow to advance to the next character space. Press the Menu ◀ arrow to return to the previous character space. The cursor will automatically wrap to the first character space when the last character space is passed.
4. Repeat steps 2 and 3 to enter the desired custom unit name.
5. When the desired custom unit name has been entered, press the Menu ◀ arrow to close the EDIT CUSTOM NAME drop-down menu and return to the DISPLAY SETUP menu.

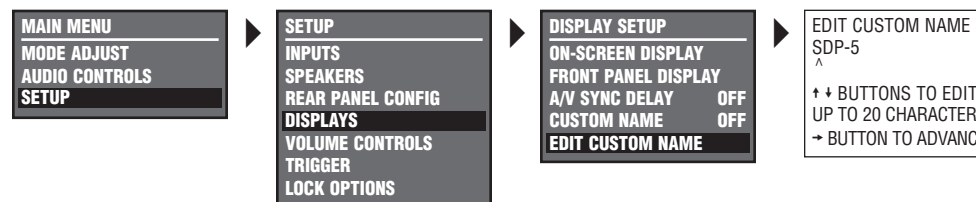

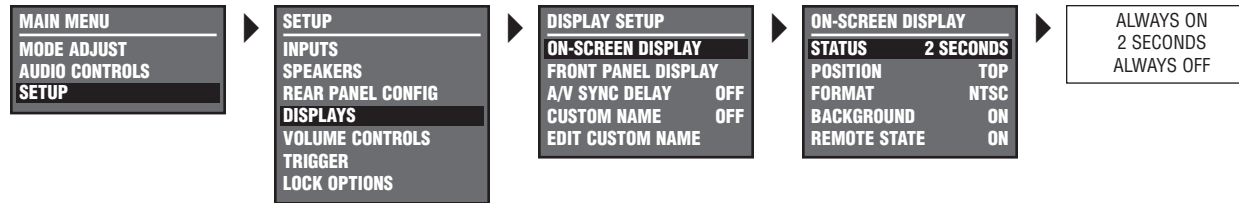

ON-SCREEN DISPLAY SETUP

SETUP ▶ **DISPLAYS** ▶ **ON-SCREEN DISPLAY**

Selecting the DISPLAY SETUP menu ON-SCREEN DISPLAY option opens the ON-SCREEN DISPLAY menu shown above, which can be used to customize the on-screen display.

Parameter	Default Setting	Possible Settings
STATUS	2 SECONDS	ALWAYS ON, 2 SECONDS, ALWAYS OFF
POSITION	TOP	TOP, CENTER, BOTTOM
FORMAT	NTSC	SECAM, PAL, NTSC
BACKGROUND	ON	ON, OFF
REMOTE STATE	ON	ON, OFF

STATUS

ALWAYS ON, 2 SECONDS, ALWAYS OFF

SETUP ▶ **DISPLAYS** ▶ **ON-SCREEN DISPLAY** ▶ **STATUS**

Activates and deactivates the on-screen display sent to the Main Zone video output connector. When set to ALWAYS ON, the on-screen display remains on at all times. When set to 2 SECONDS, the on-screen display appears for 2 seconds whenever the input source changes or the SDP-5 receives a command. When set to ALWAYS OFF, the on-screen display remains off at all times. It will not reappear until the ON-SCREEN DISPLAY menu STATUS parameter is set to ALWAYS ON or 2 SECONDS.

Note:

When the ON-SCREEN DISPLAY menu STATUS parameter is set to ALWAYS OFF, the on-screen display immediately disappears. Press the remote control OSD button or use the front panel display as a guide to reset the parameter to ALWAYS ON or 2 SECONDS.

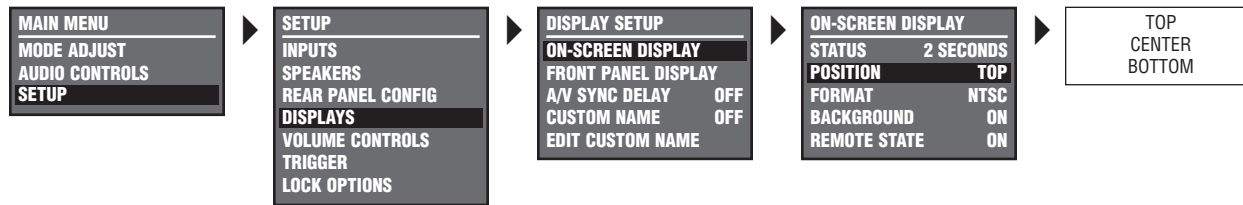
**POSITION**

TOP, CENTER, BOTTOM

SETUP ▶ **DISPLAYS** ▶ **ON-SCREEN DISPLAY** ▶ **POSITION**

Controls the vertical position of the two-line status on the display device screen. When set to TOP, the two-line status appears near the top of the display device screen. When set to CENTER, the two-line status is centered on the display device screen. When set to BOTTOM, the two-line status appears near the bottom of the display device screen. Refer to page 2-18 for more information about the two-line status.

FORMAT

SECAM, PAL, NTSC

SETUP ▶ **DISPLAYS** ▶ **ON-SCREEN DISPLAY** ▶ **FORMAT**

Controls the compatibility between the video input connectors, the video switcher, and the display device. Select the setting that is compatible with the source components and display device.

Note:

The FORMAT parameter affects the composite and S-video output connectors. It does not affect the component video output connector.

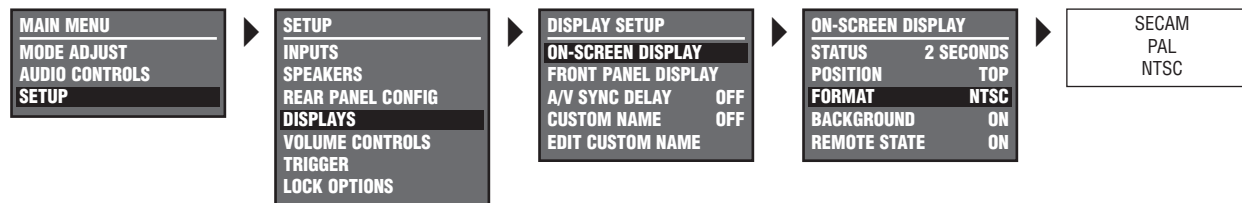

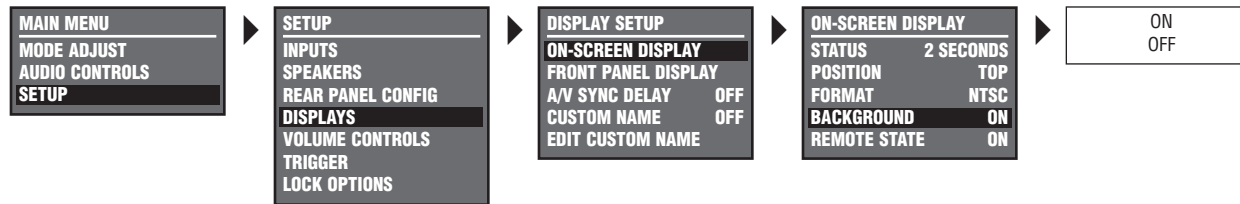

BACKGROUND

ON, OFF

SETUP ▶ DISPLAYS ▶ ON-SCREEN DISPLAY ▶ BACKGROUND

Activates and deactivates the menu background. When set to ON, on-screen display menus appear over a solid blue or gray background (depending on the display device). When set to OFF, on-screen display menus appear over the video input signal.

Note:

When the BACKGROUND parameter is set to OFF, the on-screen display will disappear if the display device is using the component video output connector.

REMOTE STATE

ON, OFF

SETUP ▶ DISPLAYS ▶ ON-SCREEN DISPLAY ▶ REMOTE STATE

Controls the remote control command bank indicator that appears on the on-screen display. When set to ON, a command bank indicator appears in the top-right corner of the on-screen display to indicate the last command bank from which the SDP-5 received a command. When set to OFF, no command bank indicator appears on the on-screen display.

A "Z" appears when a command from the Zone 2 command bank was received last. An "S" appears when a command from the Shift command bank was received last. No letter appears when a command from the Main Zone command bank was received last.

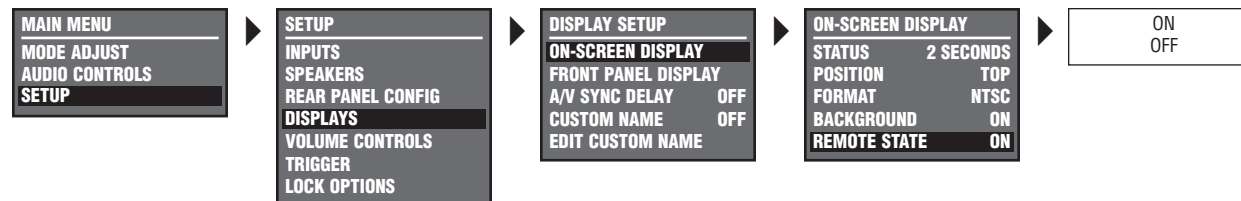

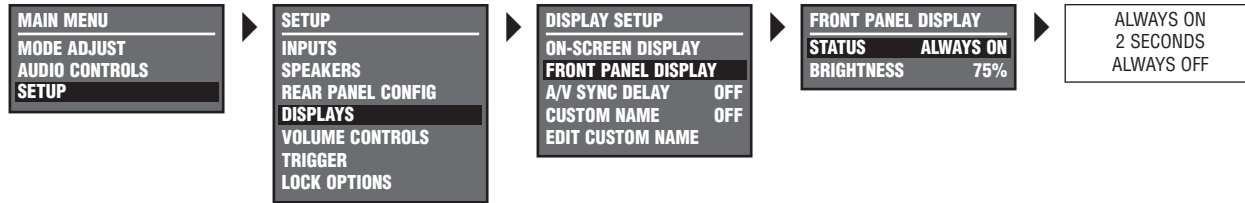

FRONT PANEL DISPLAY SETUP

SETUP ▶ DISPLAYS ▶ FRONT PANEL DISPLAY

Opens the FRONT PANEL DISPLAY menu shown above, which can be used to customize the front panel display.

Parameter	Default Setting	Possible Settings
STATUS	ALWAYS ON	ALWAYS ON, 2 SECONDS, ALWAYS OFF
BRIGHTNESS	75%	100%, 75%, 50%, 25%

whenever the input source changes or the SDP-5 receives a command. When set to ALWAYS OFF, the front panel display remains off at all times.

Note:

When the FRONT PANEL DISPLAY menu STATUS parameter is set to ALWAYS OFF, the front panel display immediately disappears. Press the remote control FP button or use the on-screen display as a guide to reset the parameter to ALWAYS ON or 2 SECONDS.

STATUS ALWAYS ON, 2 SECONDS, ALWAYS OFF

SETUP ▶ DISPLAYS ▶ FRONT PANEL DISPLAY ▶ STATUS

Activates and deactivates the front panel display. When set to ALWAYS ON, the front panel display remains on at all times. When set to 2 SECONDS, the front panel display appears for 2 seconds

BRIGHTNESS 100%, 75%, 50%, 25%

SETUP ▶ DISPLAYS ▶ FRONT PANEL DISPLAY ▶ BRIGHTNESS

Controls the brightness of front panel display characters. When a setting is selected, front panel display illumination automatically adjusts to the selected brightness.

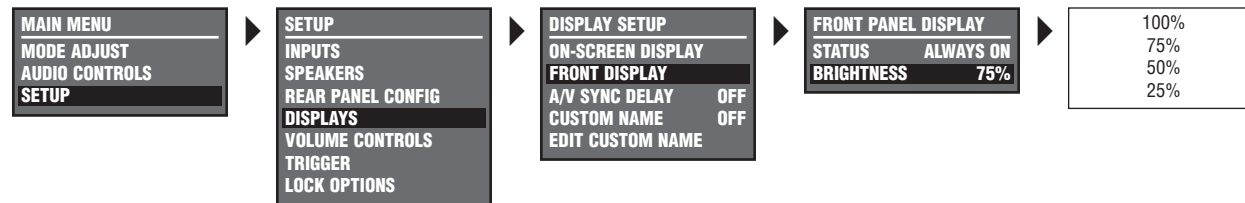

VOLUME CONTROL SETUP

SETUP ▶ **VOLUME CONTROLS**

Selecting the SETUP menu VOLUME CONTROLS option opens the VOLUME CONTROL SETUP menu shown below, which can be used to configure Main Zone and Zone 2 volume levels.

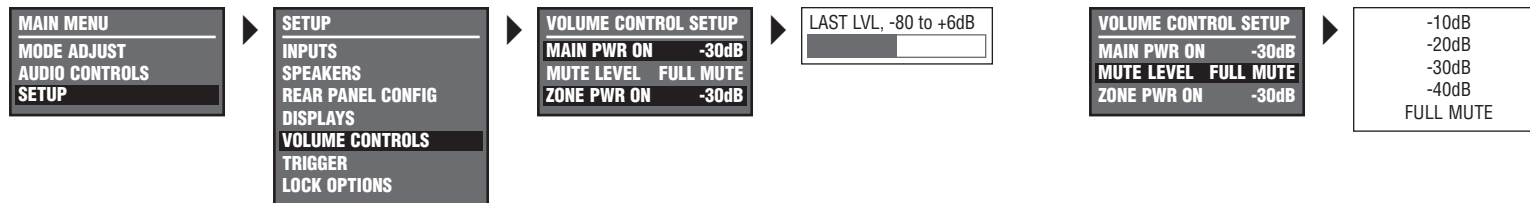

Parameter	Default Setting	Possible Settings
MAIN PWR ON	-30dB	LAST LVL, -80 to +6dB
MUTE LEVEL	FULL MUTE	FULL MUTE, -40dB, -30dB, -20dB, -10dB
ZONE PWR ON	-30dB	LAST LVL, -80 to +6dB

MAIN PWR ON LAST LVL, -80 to +6dB

SETUP ▶ **VOLUME CONTROLS** ▶ **MAIN PWR ON**

Sets the Main Zone volume level that will be selected whenever the Main Zone is activated. When set to LAST LVL, the Main Zone will activate at the last volume level that was selected in that zone during the previous operating session.

MUTE LEVEL FULL MUTE, -40dB, -30dB, -20dB, -10dB

SETUP ▶ **VOLUME CONTROLS** ▶ **MUTE LEVEL**

Sets the amount of attenuation that occurs in the Main Zone whenever the front panel or remote control Mute button is pressed. When set to FULL MUTE, Main Zone volume level will be fully attenuated whenever the front panel or remote control Mute button is pressed. Otherwise, Main Zone volume level will be attenuated to the selected level.

ZONE PWR ON LAST LVL, -80 to +6dB

SETUP ▶ **VOLUME CONTROLS** ▶ **ZONE PWR ON**

Sets the Zone 2 volume level that will be selected whenever Zone 2 is activated. When set to LAST LVL, Zone 2 will activate at the last volume level that was selected in that zone during the previous operating session.

TRIGGER SETUP

SETUP ▶ **TRIGGER**

Selecting the SETUP menu TRIGGER option opens the TRIGGER SETUP menu shown at the right, which can be used to configure the trigger output connector labeled 1. The SDP-5 rear panel houses two 12V DC trigger output connectors. The connector labeled PWR – the power trigger output connector – is not configurable. It is activated when the SDP-5 is activated, and deactivated when the SDP-5 is deactivated. The trigger output connector labeled 1 can be configured for remote or program operation.

Parameter	Default Setting	Possible Settings
REMOTE ONLY	OFF	ON, OFF
Program Operation	N/A	ON, OFF

All TRIGGER SETUP menu parameters – except the REMOTE ONLY parameter – are considered program operation parameters.

REMOTE ONLY

SETUP ▶ **TRIGGER** ▶ **REMOTE ONLY**

Configures the trigger output connector labeled 1 for remote operation. When set to ON, this connector is configured for remote operation. When the Zone 2 command bank is activated, it can be activated and deactivated with the remote control Mode ▲ and ▼ buttons (2-14). The SDP-5 ignores all other TRIGGER SETUP menu parameter settings. When set to OFF, the trigger output connector labeled 1 is not configured for remote operation. It can be configured for program operation. Refer to the next page for more information about configuring the trigger output connector labeled 1 for program operation.

MAIN MENU
MODE ADJUST
AUDIO CONTROLS
SETUP

SETUP
INPUTS
SPEAKERS
REAR PANEL CONFIG
DISPLAYS
VOLUME CONTROLS
TRIGGER
LOCK OPTIONS

TRIGGER SETUP
REMOTE ONLY OFF
DVD1 OFF
DVD2 OFF
SAT OFF
VCR OFF
TV OFF
CD OFF
TUNER OFF
AUX OFF
ZONE2 INPUTS OFF
5.1 FILM ON
5.1 TV ON
5.1 MUSIC ON
5.1 MUSIC SURR ON
DOLBY + THX ON
DOLBY MOVIE ON
DOLBY MUSIC ON
DOLBY LOGIC ON
DTS FILM ON
DTS MUSIC ON
NIGHTCLUB ON
CONCERT HALL ON
CHURCH ON
CATHEDRAL ON
PANORAMA ON
PARTY ON
2-CHANNEL OFF
MONO LOGIC ON
MONO SURROUND ON
MONO ON
5.1 5.1 FILM ON
5.1 5.1 TV ON
5.1 5.1 MUSIC ON
5.1 THX SurEX ON
5.1 THX MUSIC ON
DIGITAL EX ON
5.1 2-CHANNEL OFF
5.1 MONO LOGIC ON
5.1 MONO SURR ON
5.1 MONO ON
DTS 5.1 FILM ON
DTS 5.1 MUSIC ON
DTS THX ON
DTS THX MUSIC ON
DTS ON
DTS 5.1 2-CHAN OFF
5.1a BYPASS ON
2CH BYPASS OFF

ON
OFF

* TRIGGER SETUP menu listening mode names are fixed, meaning these names do not change when certain encoding is present. For instance, the 5.1 THX SurEX listening mode label appears whether THX Ultra2, THX Surround EX, or no encoding is engaged.

ON, OFF

Program Operation Parameters ON, OFF

SETUP ▶ TRIGGER ▶ (PROGRAM OPERATION PARAMETER)

Configure the trigger output connector labeled 1 for program operation. All TRIGGER SETUP menu parameters – except the REMOTE ONLY parameter – are considered program operation parameters. The connector can be associated with multiple inputs and listening modes at the same time.

When the REMOTE ONLY parameter is set to OFF and program operation parameters are set to ON, the trigger output connector labeled 1 is associated with the corresponding Main Zone input, Main Zone listening modes, or Zone 2 inputs. (The connector cannot be associated with individual Zone 2 inputs; rather, it can be associated with the Zone 2 inputs as a group.) When configured for program operation, the connector is activated when the corresponding inputs and listening modes are selected and deactivated when the corresponding inputs and listening modes are deselected.

Note:

When the CUSTOM menu RESET MODE option is selected to restore the factory-default version of the selected listening mode, the corresponding TRIGGER SETUP menu listening mode parameter is automatically set to OFF.

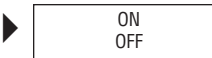
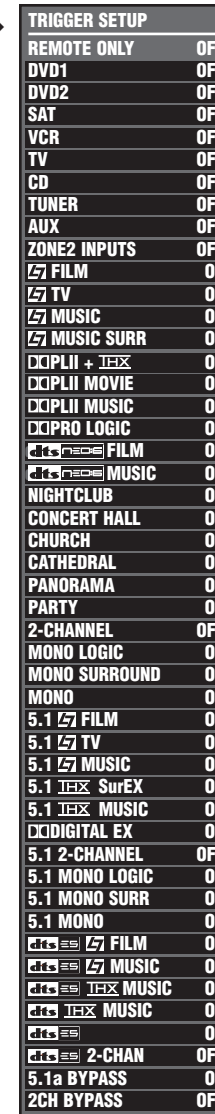
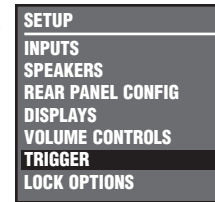
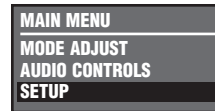

* TRIGGER SETUP menu listening mode names are fixed, meaning these names do not change when certain encoding is present. For instance, the 5.1 THX SurEX listening mode label appears whether THX Ultra2, THX Surround EX, or no encoding is engaged.

LOCK OPTIONS

SETUP ▶ **LOCK OPTIONS**

Selecting the SETUP menu LOCK OPTIONS option opens the LOCK OPTIONS menu shown below, which can be used to lock and unlock settings in the MODE ADJUST, AUDIO CONTROLS, and SETUP menu branches.

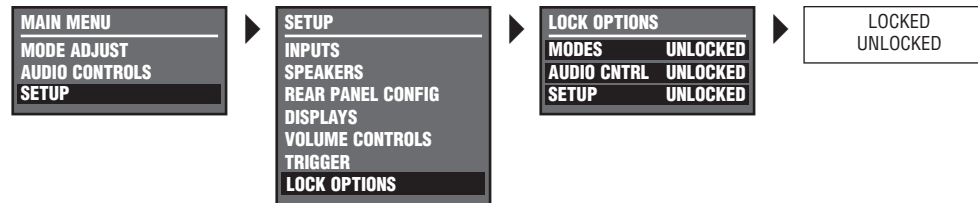

Parameter	Default Setting	Possible Settings
MODES	UNLOCKED	LOCKED, UNLOCKED
AUDIO CNTRL	UNLOCKED	LOCKED, UNLOCKED
SETUP	UNLOCKED	LOCKED, UNLOCKED

MODES

LOCKED, UNLOCKED

SETUP ▶ **LOCK OPTIONS** ▶ **MODES**

Controls MODE ADJUST menu branch settings, which include all listening mode menu settings. When set to LOCKED, these settings cannot be adjusted. When set to UNLOCKED, these settings can be adjusted.

AUDIO CNTRL

LOCKED, UNLOCKED

SETUP ▶ **LOCK OPTIONS** ▶ **AUDIO CNTRL**

Controls AUDIO CONTROLS menu branch settings. When set to LOCKED, these settings cannot be adjusted. When set to UNLOCKED, these settings can be adjusted.

SETUP

LOCKED, UNLOCKED

SETUP ▶ **LOCK OPTIONS** ▶ **SETUP**

Controls SETUP menu branch settings. When set to LOCKED, these settings cannot be adjusted. When set to UNLOCKED, these settings can be adjusted.

4

AUDIO CONTROLS

AUDIO CONTROLS 4-2

AUDIO CONTROLS

Selecting the MAIN MENU AUDIO CONTROLS option opens the AUDIO CONTROLS menu shown below, which can be used to customize the Main Zone audio output connectors and control the balance of the Zone 2 audio output connectors. The BASS, TREBLE, TILT EQ, LOUDNESS, BALANCE, and FADER parameters affect the Main Zone audio output connectors. These parameter settings affect all inputs and listening modes selected in the Main Zone, except the 5.1a BYPASS and 2CH BYPASS listening modes. The ZONE2 BALANCE parameter controls the balance of the Zone 2 audio output connectors. This parameter setting affects all inputs selected in Zone 2.

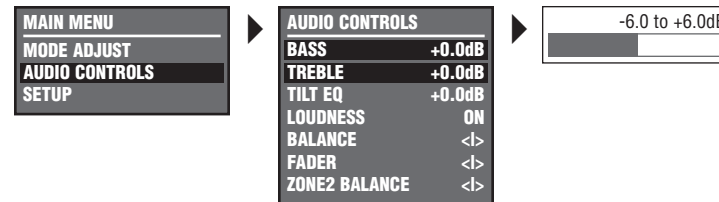

Parameter	Default Value	Possible Settings
BASS	+0.0dB	-6.0 to +6.0dB
TREBLE	+0.0dB	-6.0 to +6.0dB
TILT EQ	+0.0dB	-3.0 to +3.0dB
LOUDNESS	ON	ON, OFF
BALANCE	< >	L< to < > to >R
FADER	< >	B< to < > to >F
ZONE2 BALANCE	< >	L< to < > to >R

AUDIO CONTROLS menu parameter descriptions begin in the next column.

Note:

When the Zone 2 command bank is activated, pressing the remote control Blue button sets the BASS, TREBLE, and TILT EQ parameters to +0.0dB.

BASS

-6.0 to +6.0dB



Controls the amount of low-frequency boost or cut applied to the Main Zone audio output connectors labeled Front L/R, Center, and Subwoofer. The graph shown on the left of the next page illustrates the frequency response of BASS parameter settings.

TREBLE

-6.0 to +6.0dB

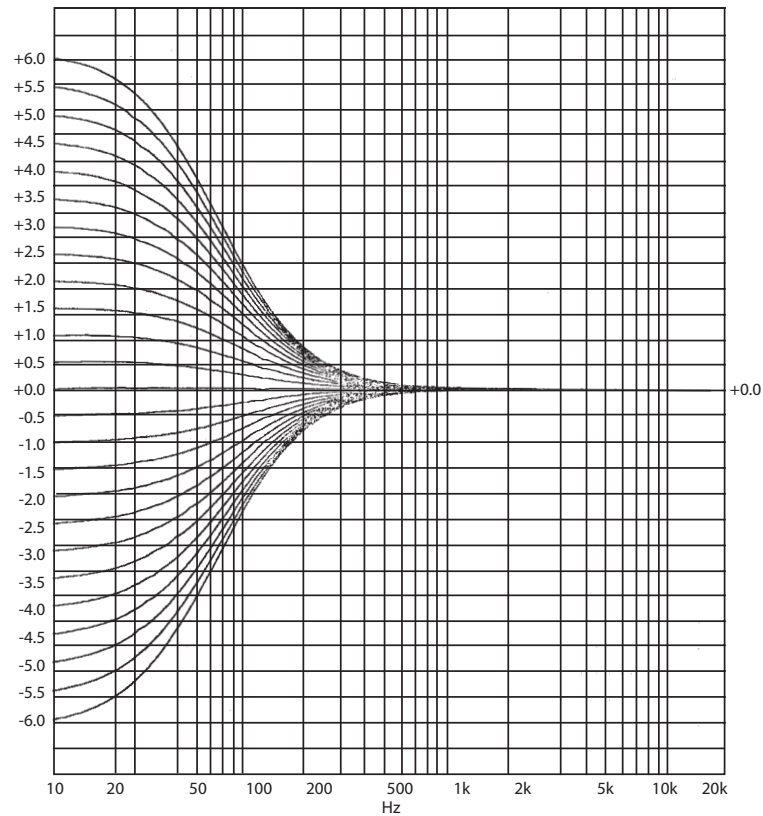

Controls the amount of boost or cut applied to the Main Zone audio output connectors labeled Front L/R and Center. The graph shown on the right of the next page illustrates the frequency response of TREBLE parameter settings.

BASS Parameter Settings

The BASS parameter (previous page) controls the amount of low-frequency boost or cut applied to the Main Zone audio output connectors labeled Front L/R, Center, and Subwoofer.

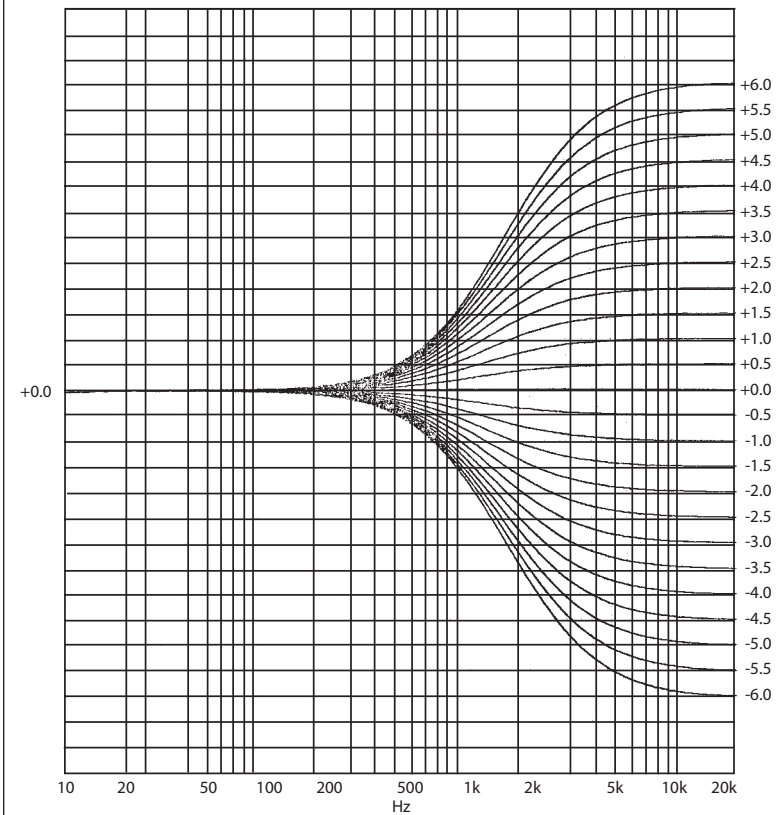
TREBLE Parameter Settings

The TREBLE parameter (previous page) controls the amount of boost or cut applied to the Main Zone audio output connectors labeled Front L/R and Center.

... AUDIO CONTROLS continues on page 4-4

AUDIO CONTROLS (continued from page 4-3)

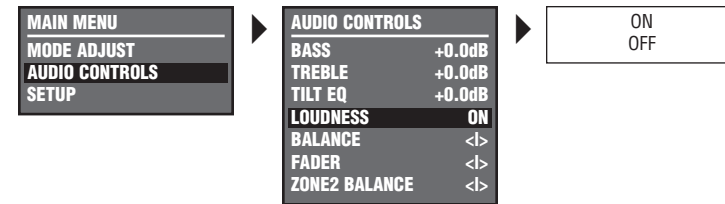
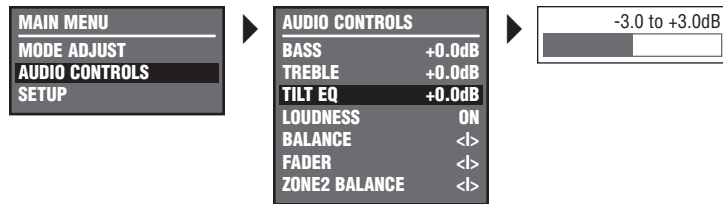

TILT EQ

-3.0 to +3.0dB

AUDIO CONTROLS ▶ **TILT EQ**

Controls the amount of tilt equalization applied to the Main Zone audio output connectors labeled Front L/R, Center, and Subwoofer. This parameter setting affects the entire frequency spectrum with a hinge point at 1kHz. As the setting is increased, frequencies higher than 1kHz are boosted, while frequencies lower than 1kHz are simultaneously cut. As the setting is decreased, frequencies higher than 1kHz are cut, while frequencies lower than 1kHz are simultaneously boosted. The graph shown on the left of the next page illustrates the frequency response of TILT EQ parameter settings.

Note:

When the Zone 2 command bank is activated, pressing the remote control Blue button sets the BASS, TREBLE, and TILT EQ parameters to +0.0dB.

LOUDNESS

ON, OFF

AUDIO CONTROLS ▶ **LOUDNESS**

Controls the amount of low-frequency boost that is automatically applied to the Main Zone audio output connectors labeled Front L/R, Center, and Subwoofer. When set to ON, loudness compensation is automatically applied based on volume level. As volume level increases, the amount of boost automatically decreases. The loudness contour is optimized for sources calibrated to THX reference levels. When set to OFF, no loudness compensation is applied. The graph shown on the right of the next page illustrates the frequency response that is automatically applied when the LOUDNESS parameter is set to ON and Main Zone volume level is adjusted.

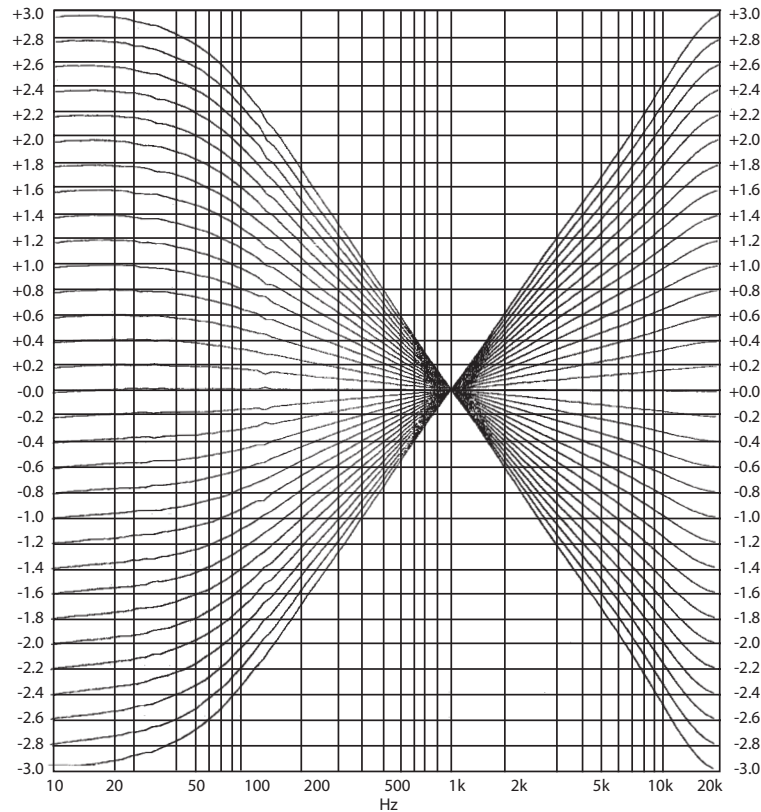
TILT EQ Parameter Settings

The TILT EQ parameter (previous page) controls the amount of tilt equalization applied to the Main Zone audio output connectors labeled Front L/R, Center, and Subwoofer.

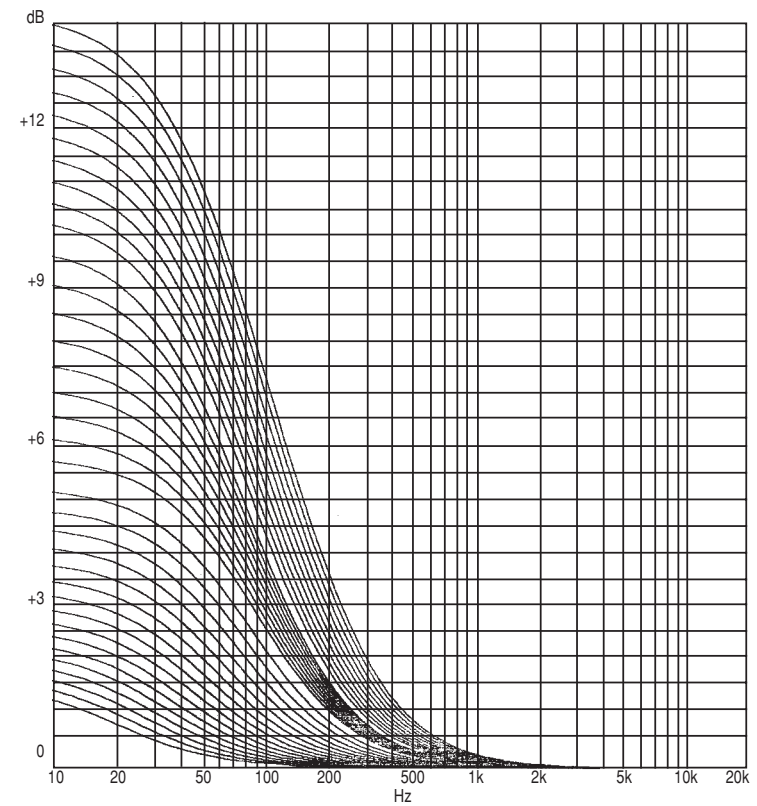
LOUDNESS Parameter Settings

The LOUDNESS parameter (previous page) controls the amount of low-frequency boost that is automatically applied to the Main Zone audio output connectors labeled Front L/R, Center, and Subwoofer.

... AUDIO CONTROLS continues on page 4-6

AUDIO CONTROLS (continued from page 4-5)

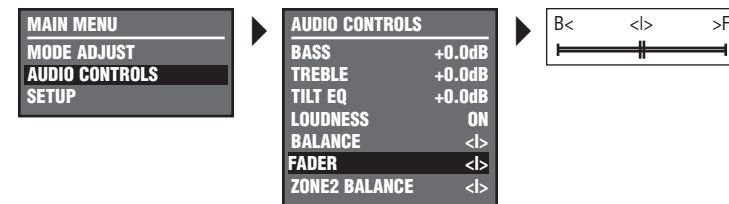
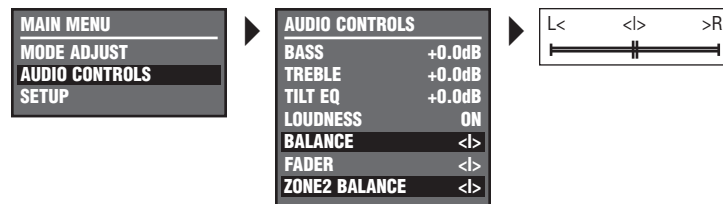

BALANCE

L< to <|> to >R

AUDIO CONTROLS ▶ **BALANCE**

Controls the left-to-right balance of the Main Zone audio output connectors.

FADER

B< to <|> to >F

AUDIO CONTROLS ▶ **FADER**

Controls the back-to-front balance of the Main Zone audio output connectors.

Note:

When the Shift command bank is activated, pressing the remote control FP button centers the Main Zone BALANCE and FADER parameters.

ZONE2 BALANCE

L< to <|> to >R

AUDIO CONTROLS ▶ **ZONE2 BALANCE**

Controls the left-to-right balance of the Zone 2 audio output connectors.

Note:

When the Zone 2 command bank is activated, pressing the remote control FP button centers the ZONE2 BALANCE parameter.

5

MODE ADJUST

MODE ADJUST	5-2
Listening Mode Activation	5-2
<i>Preferred Listening Mode Selection Parameters • Mode ▲ and ▼ Buttons • Mode Family Selection Buttons</i>	
Listening Mode Descriptions	5-3
<i>L7 FILM • L7 TV • L7 MUSIC • L7 MUSIC SURR • DOLBY PLII + THX • DOLBY PLII MOVIE • DOLBY PLII MUSIC • DOLBY PRO LOGIC • dts NEO:6 FILM • dts NEO:6 MUSIC • NIGHTCLUB • CONCERT HALL • CHURCH • CATHEDRAL • PANORAMA • PANORAMA CALIBRATION • PARTY • 2-CHANNEL • MONO LOGIC • MONO SURROUND • MONO • 5.1 L7 FILM • 5.1 L7 TV • 5.1 L7 MUSIC • 5.1 THX, 5.1 THX ULTRA2, & 5.1 THX SurEX • 5.1 THX MUSIC • DOLBY DIGITAL & DOLBY DIGITAL EX • 5.1 2-CHANNEL • 5.1 MONO LOGIC • 5.1 MONO SURR • 5.1 MONO • dts-ES DECODING • dts(-ES) L7 FILM • dts(-ES) L7 MUSIC • dts THX ULTRA2 & dts-ES THX • dts THX Music • dts(-ES) • dts(-ES) 2-CHAN • 5.1a BYPASS • 2CH BYPASS</i>	
Listening Mode Menu Option & Parameter Descriptions	5-28



* These listening mode names differ depending on the input source, the speaker configuration, and certain parameter settings. Refer to the Listening Mode Descriptions section that begins on the next page for more information.

MODE ADJUST

Selecting the MAIN MENU MODE ADJUST option opens the MODE ADJUST menu shown at the left, which can be used to select a listening mode for adjustment. When the MODE ADJUST menu opens, the currently activated Main Zone listening mode is highlighted.

Selecting a listening mode does not activate that listening mode for the current Main Zone input source. Rather, selecting a listening mode opens the corresponding listening mode menu, which can be used to customize the activated listening mode. These adjustments are applied when that listening mode is selected with one of the methods described in the Listening Mode Activation section that begins below.

LISTENING MODE ACTIVATION

Listening modes are available for 2-channel, Dolby Digital, dts(-ES), and analog input sources. The SDP-5 allows listening mode selection for all Main Zone sources. In some cases, the SDP-5 automatically activates a listening mode in response to certain commands. For this reason, it is important to understand the three methods through which listening mode activation occurs.

Listening modes can be activated with:

- the INPUT SETUP menu preferred listening mode selection parameters (3-13)
- the front panel or remote control Mode ▲ and ▼ buttons (2-3, 2-14)
- the remote control mode family selection buttons (2-16)

PREFERRED LISTENING MODE SELECTION PARAMETERS

The INPUT SETUP menus include three preferred listening mode selection parameters labeled 2-CH, DOLBY D, and dts-ES. These parameters can be used to select a preferred listening mode for 2-channel, Dolby Digital, and dts(-ES) input sources. The SDP-5 automatically activates the selected listening mode whenever a new input is selected or a new input source is present. Refer to page 3-13 for more information.







MODE ▲ AND ▼ BUTTONS

The front panel and remote control Mode ▲ and ▼ buttons can be used to audition listening modes with the current Main Zone input source. Pressing these buttons scrolls upward (▲) and downward (▼) through listening modes available for the current Main Zone source. Listening modes are scrolled in the order that appears on the MODE ADJUST menu (5-2).

For example, if a 2-channel input source is present, the Mode ▲ and ▼ buttons scroll through available 2-channel listening modes. The selected listening mode appears in the bottom-left corner of the Main Zone two-line status (2-20).

MODE FAMILY SELECTION BUTTONS

The remote control mode family selection buttons can be used to activate the LOGIC7 Film, Dolby, dts(-ES), THX, LOGIC7 Music, or LOGIC7 TV listening mode that is appropriate for the Main Zone input source. For instance, if the L7 button is pressed while a 2-channel source is present, the L7 FILM listening mode is activated. The table at the top of the next column indicates the listening modes associated with each mode family selection button.

Button	2-Channel Sources	Dolby Digital Sources	dts(-ES) Sources
	L7 FILM	5.1 L7 FILM	dts(-ES) L7 FILM
	DOLBY PLII MOVIE	DOLBY DIGITAL*	MODE SELECTION NOT AVAILABLE**
	dts NEO:6 FILM	MODE SELECTION NOT AVAILABLE**	dts(-ES)
	DOLBY PLII + THX	5.1 THX*	dts-ES THX
	L7 MUSIC	5.1 L7 MUSIC	dts(-ES) L7 MUSIC
	L7 TV	5.1 L7 TV	MODE SELECTION NOT AVAILABLE**

* These listening mode names differ depending on the input source, the speaker configuration, and certain parameter settings.

** The "MODE SELECTION NOT AVAILABLE" message appears on the on-screen and front panel displays when no listening mode is available for the Main Zone input source that is present.

LISTENING MODE DESCRIPTIONS

Listening mode descriptions begin on the next page. The table beneath each description lists the default and possible settings for each listening mode menu parameter. All listening mode menus are shown in the Appendix, beginning on page A-10. Listening mode menu option and parameter descriptions begin on page 5-28.

L7 FILM

MODE ADJUST ▶ **L7 FILM**

- A proprietary listening mode.
- Designed for enhanced playback of 2-channel stereo or matrix-encoded film sources.
- Derives seven channels from 2-channel input sources, as well as full-frequency stereo surround channels that realistically increase the perceived width, length, and sense of envelopment of the listening space.
- Provides remarkable improvement compared to other decoders.
- Recommended for 2-channel film sources.

Option/ Parameter	Default Setting	Possible Settings
AUTO AZIMUTH	ON	ON, OFF
VOCAL ENHANCE	+0.0dB	+6.0dB, +3.0dB, +0.0dB
RE-EQUALIZER	ON	ON, OFF
SOUND STAGE	REAR	FRONT, NEUTRAL, REAR
5 SPKR ENHANCE	OFF	ON, OFF
BASS ENHANCE	OFF	ON, OFF
SURR ROLLOFF	15.3kHz	500Hz to 20.0kHz, OFF
REAR DLY OFFSET	15ms	OFF, 1 to 30ms
OUTPUT LEVELS		
CUSTOM		

Listening mode menu option and parameter descriptions begin on page 5-28.

L7 TV

MODE ADJUST ▶ **L7 TV**

- A proprietary listening mode.
- Based on the L7 FILM listening mode, but specifically tailored for broadcast sources.
- Designed for playback of 2-channel stereo or matrix-encoded broadcast sources.
- Recommended for 2-channel broadcast sources.

Option/ Parameter	Default Setting	Possible Settings
AUTO AZIMUTH	ON	ON, OFF
VOCAL ENHANCE	+0.0dB	+6.0dB, +3.0dB, +0.0dB
FRONT STEERING	FILM	OFF, MSURR, MUSIC, FILM
RE-EQUALIZER	OFF	ON, OFF
SOUND STAGE	REAR	FRONT, NEUTRAL, REAR
5 SPKR ENHANCE	OFF	ON, OFF
BASS ENHANCE	OFF	ON, OFF
SURR ROLLOFF	15.3kHz	500Hz to 20.0kHz, OFF
REAR DLY OFFSET	15ms	OFF, 1 to 30ms
OUTPUT LEVELS		
CUSTOM		

Listening mode menu option and parameter descriptions begin on page 5-28.

L7 MUSIC

MODE ADJUST ▶ L7 MUSIC

- A proprietary listening mode.
- Designed for playback of 2-channel stereo or matrix-encoded music sources.
- Recommended for 2-channel music sources.

Option/ Parameter	Default Setting	Possible Settings
VOCAL ENHANCE	+0.0dB	+6.0dB, +3.0dB, +0.0dB
FRONT STEERING	MUSIC	OFF, MSURR, MUSIC, FILM
SOUND STAGE	NEUTRAL	FRONT, NEUTRAL, REAR
5 SPKR ENHANCE	OFF	ON, OFF
BASS ENHANCE	OFF	ON, OFF
SURR ROLLOFF	15.3kHz	500Hz to 20.0kHz, OFF
REAR DLY OFFSET	15ms	OFF, 1 to 30ms
OUTPUT LEVELS		
CUSTOM		

Listening mode menu option and parameter descriptions begin on page 5-28.

L7 MUSIC SURR

MODE ADJUST ▶ L7 MUSIC SURR

- A proprietary listening mode.
- Designed for playback of 2-channel stereo music sources recorded in real spaces and for playback of recordings that contain added reverb.
- Extracts ambient sounds from the input source and sends these sounds to all speakers. Ambient sounds are heard from all directions, creating a realistic playback presentation that simulates what listeners experience in real spaces.
- Recommended for classical music sources, which are often recorded in real spaces with added reverb to enhance the stereo mix.

Option/ Parameter	Default Setting	Possible Settings
VOCAL ENHANCE	+0.0dB	+6.0dB, +3.0dB, +0.0dB
FRONT STEERING	MSURR	OFF, MSURR, MUSIC, FILM
SOUND STAGE	NEUTRAL	FRONT, NEUTRAL, REAR
5 SPKR ENHANCE	OFF	ON, OFF
BASS ENHANCE	OFF	ON, OFF
SURR ROLLOFF	15.3kHz	500Hz to 20.0kHz, OFF
REAR DLY OFFSET	15ms	OFF, 1 to 30ms
OUTPUT LEVELS		
CUSTOM		

Listening mode menu option and parameter descriptions begin on page 5-28.

DOLBY PLII + THX

MODE ADJUST ▶ **DOLBY PLII + THX**

- Designed for playback of Dolby Surround-encoded sources.
- Uses Dolby Pro Logic II decoding to derive five channels from Dolby Surround-encoded sources.
- Applies THX re-equalization to simulate high-frequency rolloffs that occur in movie theaters. Most films are mixed for movie theaters, and might sound too bright when played back in home theaters without re-equalization.
- Applies THX timbre matching to minimize timbre differences between the front and surround channels, which results in smoother sound movements between them.
- Recommended for home theaters with THX-certified loudspeakers.

Option/ Parameter	Default Setting	Possible Settings
RE-EQUALIZER	ON	ON, OFF
OUTPUT LEVELS		
CUSTOM		

Listening mode menu option and parameter descriptions begin on page 5-28.

DOLBY PLII MOVIE

MODE ADJUST ▶ **DOLBY PLII MOVIE**

- Similar to the DOLBY PRO LOGIC listening mode, but uses full-frequency stereo surround channels to realistically increase the perceived width of the listening space.
- Designed for playback of Dolby Surround-encoded sources.
- Decodes five channels from Dolby Surround-encoded sources.
- Provides impressive enhancement compared to Dolby Pro Logic decoding.
- Appropriate for Dolby Surround-encoded film sources.

Option/ Parameter	Default Setting	Possible Settings
OUTPUT LEVELS		
CUSTOM		

Listening mode menu option and parameter descriptions begin on page 5-28.

DOLBY PLII MUSIC**MODE ADJUST** ▶ **DOLBY PLII MUSIC**

- Similar to the DOLBY PLII MOVIE listening mode.
- Designed for playback of stereo music sources.

Option/ Parameter	Default Setting	Possible Settings
PANORAMA	OFF	ON, OFF
CTR WIDTH	3	MIN, 1 to 6, MAX
DIMENSION	NEUTRAL	FRONT, NEUTRAL, REAR
SURROUND DLY	10ms	0 to 15ms
OUTPUT LEVELS		
CUSTOM		

Listening mode menu parameter descriptions begin on page 5-28.

DOLBY PRO LOGIC**MODE ADJUST** ▶ **DOLBY PRO LOGIC**

- Designed for playback of Dolby Surround-encoded sources.
- Decodes four channels from Dolby Surround-encoded sources.
- Uses a mono surround channel with a high-frequency rolloff above 7kHz.
- Available for comparison purposes, particularly with the L7 FILM, DOLBY PLII MOVIE, and dts NEO:6 FILM listening modes.

**Option/
Parameter**

 OUTPUT LEVELS

 CUSTOM

Listening mode menu parameter descriptions begin on page 5-28.

dts NEO:6 FILM**MODE ADJUST** > **dts NEO:6 FILM**

- Designed for playback of matrix-encoded digital stereo film sources.
- Derives six channels when both side and rear speakers are present (rear channels will be in parallel). Derives five channels when only side or rear speakers are present. The subwoofer channel is generated through bass management in the SDP-5.

**Option/
Parameter**

OUTPUT LEVELS

CUSTOM

*Listening mode menu option and parameter descriptions begin on page 5-28.***dts NEO:6 MUSIC****MODE ADJUST** > **dts NEO:6 MUSIC**

- Designed for playback of matrix-encoded digital stereo music sources.
- Derives six channels when both side and rear speakers are present (rear channels will be in parallel). Derives five channels when only side or rear speakers are present. The subwoofer channel is generated through bass management in the SDP-5.

**Option/
Parameter**

OUTPUT LEVELS

CUSTOM

*Listening mode menu option and parameter descriptions begin on page 5-28.***Please note the following about dts NEO:6 listening mode activation:**

- The dts NEO:6 listening modes cannot be assigned as the preferred listening mode for 2-channel sources. However, when the 2-CH parameter is set to USE LAST, the SDP-5 will automatically activate a dts NEO:6 listening mode if a dts NEO:6 listening mode was activated the last time a 2-channel source was present.
- The SDP-5 will not automatically activate the dts NEO:6 listening modes unless a 44.1 or 48kHz PCM digital source is present. The dts NEO:6 listening modes are not available with 88.2 or 96kHz, Dolby Digital, or analog sources.
- The dts NEO:6 MUSIC listening mode can be activated with the front panel or remote control Mode ▲ and ▼ buttons. The dts NEO:6 FILM listening mode can also be activated with the remote control dts button when a 2-channel input source is present.

NIGHTCLUB**MODE ADJUST** ▶ **NIGHTCLUB**

- Designed for playback of “dry” music sources that benefit from the addition of room reflections, especially music sources that lack ambience in the recording.
- Generates early reflections to simulate small, intimate listening spaces.
- Sends early reflections to the front, side, and rear channels.
- Unlike other room simulation listening modes, this mode uses a proprietary reverb algorithm that is relied upon by a majority of recording engineers to add ambience to recordings.

Option/ Parameter	Default Setting	Possible Settings
CENTER DEPTH	11	0 to 18
SPEECH DETECT	ON	ON, OFF
SIZE	5m	4 to 20m
LIVENESS	196ms	30ms to 20.2s
PRE-DELAY	5ms	OFF, 1 to 100ms
ROLLOFF	9.0kHz	500Hz to 20.0kHz, OFF
EFFECT LVL	+3dB	-12 to +6dB
OUTPUT LEVELS		
CUSTOM		

Listening mode menu option and parameter descriptions begin on page 5-28.

CONCERT HALL**MODE ADJUST** ▶ **CONCERT HALL**

- Generates early reflections to simulate large listening spaces.
- Sends early reflections to the front, side, and rear channels.
- Unlike other room simulation listening modes, this mode uses a proprietary reverb algorithm that is relied upon by a majority of recording engineers to add ambience to recordings.

Option/ Parameter	Default Setting	Possible Settings
CENTER DEPTH	12	0 to 18
SPEECH DETECT	ON	ON, OFF
SIZE	20m	4 to 20m
LIVENESS	1.72s	30ms to 20.2s
PRE-DELAY	OFF	OFF, 1 to 100ms
ROLLOFF	2.4kHz	500Hz to 20.0kHz, OFF
EFFECT LVL	-2dB	-12 to +6dB
OUTPUT LEVELS		
CUSTOM		

Listening mode menu option and parameter descriptions begin on page 5-28.

CHURCH

MODE ADJUST ▶ **CHURCH**

- Uses a reverb algorithm to emphasize the rich, smooth, reverberant decay characteristic of small and medium listening spaces with long reverberation time relative to their size, such as churches and chambers.
- Unlike other room simulation listening modes, this mode uses a proprietary reverb algorithm that is relied upon by a majority of recording engineers to add ambience to recordings.

Option/ Parameter	Default Setting	Possible Settings
CENTER DEPTH	5	0 to 18
SPEECH DETECT	ON	ON, OFF
SIZE	20m	4 to 30m
MID RT	1.56s	24ms to 24.3s
BASS RT	1.87s	5ms to 48.6s
PRE-DELAY	24ms	OFF, 1 to 100ms
ROLLOFF	2.4kHz	500Hz to 20.0kHz, OFF
EFFECT LVL	-3dB	-12 to +6dB
OUTPUT LEVELS		
CUSTOM		

Listening mode menu option and parameter descriptions begin on page 5-28.

CATHEDRAL

MODE ADJUST ▶ **CATHEDRAL**

- Similar to the CHURCH listening mode.
- Uses a reverb algorithm to emphasize the rich, smooth, reverberant decay characteristic of large listening spaces with long reverberation time relative to their size, such as cathedrals.
- Unlike other room simulation listening modes, this mode uses a proprietary reverb algorithm that is relied upon by a majority of recording engineers to add ambience to recordings.

Option/ Parameter	Default Setting	Possible Settings
CENTER DEPTH	12	0 to 18
SPEECH DETECT	ON	ON, OFF
SIZE	30m	4 to 30m
MID RT	3.72s	24ms to 24.3s
BASS RT	4.47s	5ms to 48.6s
PRE-DELAY	23ms	OFF, 1 to 100ms
ROLLOFF	3.1kHz	500Hz to 20.0kHz, OFF
EFFECT LVL	-8dB	-12 to +6dB
OUTPUT LEVELS		
CUSTOM		

Listening mode menu option and parameter descriptions begin on page 5-28.

PANORAMA

MODE ADJUST ▶ PANORAMA

- Designed for playback of stereo and matrix-encoded sources.
- Uses proprietary JBL Synthesis algorithms to move the stereo image outward from the front speakers, producing a wider stereo field with greater depth.
- Depends on proper location of the listening position and front speakers. When the front speakers are positioned close to either side of the display device, the effect is produced over a wider area than when the front speakers are positioned at a large angle from the display device.

Option/ Parameter	Default Setting	Possible Settings
EFFECT LVL	+4dB	-12 to +6dB
BASS CONTENT	STEREO	BINAURAL, MONO, STEREO
LOW FREQ WIDTH	+0	-25 to +25
SURR ROLLOFF	3.1kHz	500Hz to 20.0kHz, OFF
REAR DLY OFFSET	15ms	OFF, 1 to 30ms
INPUT BALANCE	< >	L< to < > to >R
CALIBRATION	Refer to the next page	
OUTPUT LEVELS		
CUSTOM		

Listening mode menu option and parameter descriptions begin on page 5-28.

PANORAMA CALIBRATION

MODE ADJUST ▶ PANORAMA ▶ CALIBRATION

- The PANORAMA listening mode must be calibrated to take full advantage of its effects.
- For best results, it is recommended to center the primary listening position between the front left and right speakers as shown in the illustration centered at the top of page 5-13. Otherwise, the PANORAMA listening mode will be calibrated with various results.

Option/ Parameter	Default Setting	Possible Settings
SOURCE	LEFT & RIGHT	RIGHT, LEFT & RIGHT, LEFT
SPEAKER ANGLE	30deg	10 to 90deg
LISTENER POS	+0	-127 to +127

Calibration parameter descriptions begin on the next page.

To calibrate the PANORAMA listening mode:

1. Remove all obstructions between the speakers and the primary listening position.
2. Make sure the distances between the speakers and the primary listening position are properly measured. Then, enter these distances on the SPEAKER DISTANCES menu.
3. Sit in the primary listening position. If the primary listening position is not centered between the front left and right speakers, set the LISTENER POS parameter to compensate for the difference. Refer to the LISTENER POS parameter description on the next page for assistance.

... Panorama Calibration continues on page 5-12

PANORAMA Calibration (continued from page 5-11)

MODE ADJUST ▶ **PANORAMA** ▶ **CALIBRATION**

To calibrate the PANORAMA listening mode: (continued)

3. Set the SOURCE parameter (next page) to RIGHT.
4. Begin playback of the calibration source. It is recommended to use a familiar stereo source.
5. When playback of the calibration source is in progress, set the SPEAKER ANGLE parameter (next column) so the sound is not heard in the left ear.
6. Set the SOURCE parameter to LEFT.
7. When playback of the calibration source is in progress, set the SPEAKER ANGLE parameter so the sound is not heard in the right ear.
8. Set the SOURCE parameter to LEFT & RIGHT to confirm the SPEAKER ANGLE and LISTENER POS parameter settings. When the PANORAMA listening mode is properly calibrated, the sound should be perceived to come from all around the primary listening position. If this does not occur, begin again with step 1.

SOURCE RIGHT, LEFT & RIGHT, LEFT

Controls the perceived direction of the calibration source signal. When set to RIGHT, the sound is perceived to come from the right of the primary listening position. When set to LEFT, the sound is perceived to come from the left of the primary listening position. When set to LEFT & RIGHT, the sound is perceived to come from all around the primary listening position.

Note:

The SOURCE parameter controls the perceived direction of the sound, although both the front left and right speakers generate the calibration source signal.

SPEAKER ANGLE 10 to 90deg

Compensates for a wide or narrow speaker angle relative to the primary listening position. Select the setting closest to the angle between the front left and right speakers and the primary listening position.

LISTENER POS -127 to +127

Compensates for primary listening positions that are not centered between the front left and right speakers. Each increment within the -127 to +127 parameter range represents about one-third of an inch. Refer to the illustrations at the top of the next page for more information about the LISTENER POS parameter range.

Note:

The LISTENER POS parameter range might extend past the location of the front left and right speakers.

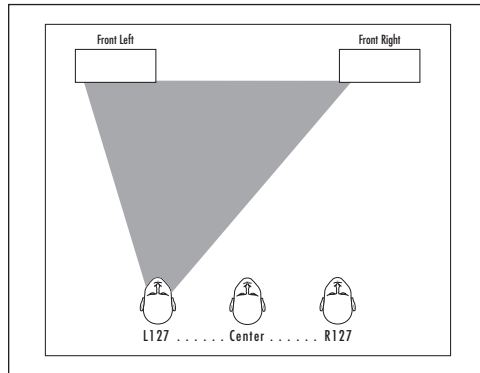
LISTENER POS Parameter Settings

Negative settings (-127 to -1) compensate for primary listening positions located to the left of the center between the front left and right speakers.

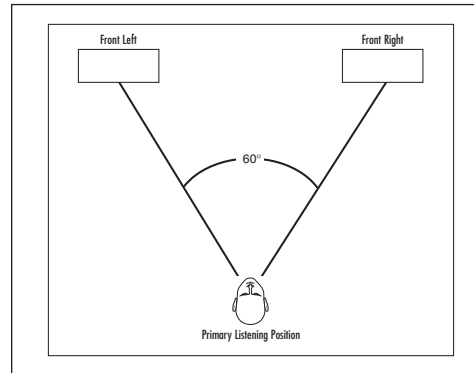

The +0 setting indicates a primary listening position centered between the front left and right speakers.

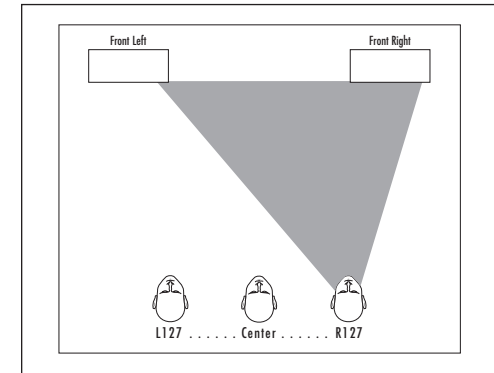

Positive settings (+1 to +127) compensate for primary listening positions located to the right of the center between the front left and right speakers.

PARTY**MODE ADJUST ▶ PARTY**

- Designed for playback of stereo sources.
- Sends stereo sources to all channels.
- Recommended for background music.

**Option/
Parameter**

OUTPUT LEVELS

CUSTOM

Listening mode menu option and parameter descriptions begin on page 5-28.

2-CHANNEL**MODE ADJUST ▶ 2-CHANNEL**

- Designed for playback of stereo sources.
- Sends stereo sources to the front and subwoofer channels.
- Recommended for audio purists and comparison purposes with other listening modes.

**Option/
Parameter****Default
Setting****Possible
Settings**

SUB LEVEL

+0dB

OFF, -30 to +12dB

CUSTOM

Listening mode menu option and parameter descriptions begin on page 5-28.

MONO LOGIC

MODE ADJUST ▶ **MONO LOGIC**

- Designed for playback of mono sources.
- Uses proprietary JBL Synthesis reverb algorithms to realistically expand mono sources to use all channels, dramatically increasing the perceived width and sense of envelopment of the listening space.

Option/ Parameter	Default Setting	Possible Settings
EFFECT LVL	-9dB	-12 to +6dB
ACADEMY FILTER	ON	ON, OFF
SURR ROLLOFF	3.1kHz	500Hz to 20.0kHz, OFF
OUTPUT LEVELS		
CUSTOM		

Listening mode menu option and parameter descriptions begin on page 5-28.

MONO SURROUND

MODE ADJUST ▶ **MONO SURROUND**

- Designed for playback of mono sources.
- Sends mono sources to all channels.

Option/ Parameter
OUTPUT LEVELS
CUSTOM

Listening mode menu option and parameter descriptions begin on page 5-28.

MONO

MODE ADJUST ▶ **MONO**

- Designed for playback of mono sources.
- Sends mono sources to the center channel.

Option/ Parameter	Default Setting	Possible Settings
SUB LEVEL	+0dB	OFF, -30 to +12dB
CUSTOM		

Listening mode menu option and parameter descriptions begin on page 5-28.

5.1 L7 FILM

MODE ADJUST ▶ 5.1 L7 FILM

- A proprietary listening mode.
- Designed for playback of 5.1-channel Dolby Digital-encoded film sources.
- Derives seven channels from 5.1-channel input sources. When both side and rear speakers are present, the 5.1 L7 FILM listening mode also increases the perceived length and sense of envelopment of the listening space.
- Provides remarkable improvement compared to other decoders.
- Recommended for 5.1-channel Dolby Digital-encoded film sources.

Option/ Parameter	Default Setting	Possible Settings
VOCAL ENHANCE	+0.0dB	+6.0dB, +3.0dB, +0.0dB
5 SPKR ENHANCE	OFF	ON, OFF
BASS ENHANCE	OFF	ON, OFF
RE-EQUALIZER	ON	ON, OFF
REAR DLY OFFSET	15ms	OFF, 1 to 30ms
COMPRESSION	OFF	AUTO, ON, OFF
LFE MIX	+0.0dB	-10.0 to +0.0dB
OUTPUT LEVELS		
CUSTOM		

Listening mode menu option and parameter descriptions begin on page 5-28.

5.1 L7 TV

MODE ADJUST ▶ 5.1 L7 TV

- A proprietary listening mode.
- Based on the 5.1 L7 FILM listening mode, but specifically tailored for broadcast sources.
- Designed for playback of 5.1-channel Dolby Digital-encoded broadcast sources.
- Recommended for 5.1-channel Dolby Digital-encoded broadcast sources.

Option/ Parameter	Default Setting	Possible Settings
VOCAL ENHANCE	+0.0dB	+6.0dB, +3.0dB, +0.0dB
5 SPKR ENHANCE	OFF	ON, OFF
BASS ENHANCE	OFF	ON, OFF
RE-EQUALIZER	OFF	ON, OFF
REAR DLY OFFSET	15ms	OFF, 1 to 30ms
COMPRESSION	OFF	AUTO, ON, OFF
LFE MIX	+0.0dB	-10.0 to +0.0dB
OUTPUT LEVELS		
CUSTOM		

Listening mode menu option and parameter descriptions begin on page 5-28.

5.1 L7 MUSIC

MODE ADJUST ▶ **5.1 L7 MUSIC**

- A proprietary listening mode.
- Based on the 5.1 L7 FILM listening mode, but specifically tailored for music sources.
- Designed for playback of 5.1-channel Dolby Digital-encoded music sources.
- Recommended for 5.1-channel Dolby Digital-encoded music sources.

Option/ Parameter	Default Setting	Possible Settings
VOCAL ENHANCE	+0.0dB	+6.0dB, +3.0dB, +0.0dB
5 SPKR ENHANCE	OFF	ON, OFF
BASS ENHANCE	OFF	ON, OFF
RE-EQUALIZER	OFF	ON, OFF
REAR DLY OFFSET	15ms	OFF, 1 to 30ms
COMPRESSION	OFF	AUTO, ON, OFF
LFE MIX	+0.0dB	-10.0 to +0.0dB
OUTPUT LEVELS		
CUSTOM		

Listening mode menu option and parameter descriptions begin on page 5-28.

5.1 THX, 5.1 THX ULTRA2, & 5.1 THX SurEX

MODE ADJUST ▶ **5.1 THX** OR **5.1 THX ULTRA2** OR **5.1 THX SurEX**

- Designed for playback of 5.1-channel Dolby Digital film sources.
- Listening mode name differs depending on the encoding present in the input source, the SURROUND EX parameter setting, and the speaker setup. The table on the next page indicates the conditions in which THX Surround EX and THX Ultra2 decoding are engaged.
- Allows 7-channel playback of 5.1-channel Dolby Digital sources without Surround EX encoding.
- Applies THX re-equalization to simulate high-frequency rolloffs that occur in movie theaters. Most films are mixed for movie theaters, and might sound too bright when played back in home theaters without re-equalization.
- Applies THX timbre matching to minimize timbre differences between the front and surround channels, which results in smoother sound movements between them.
- When the 5.1 THX ULTRA2 listening mode is activated, ASA processing is applied to signals sent to the rear speakers. Refer to the ASA parameter description on page 3-34 for more information.
- When the 5.1 THX ULTRA2 listening mode is activated, adaptive de-correlation increases the perceived width of the listening space. De-correlation of the mono surround channel increases the perceived width of the surround field in home theaters.
- When the 5.1 THX SurEX listening mode is activated, matrix decoding derives three surround channels from 5.1-channel Dolby Digital sources.
- Recommended for home theaters with THX-certified loudspeakers.

Option/ Parameter	Default Setting	Possible Settings
RE-EQUALIZER	ON	ON, OFF
SURROUND EX	AUTO	AUTO, ON, OFF
COMPRESSION	OFF	AUTO, ON, OFF
LFE MIX	+0.0dB	-10.0 to +0.0dB
OUTPUT LEVELS		
CUSTOM		

Listening mode menu option and parameter descriptions begin on page 5-28.

The table below indicates the conditions in which THX Surround EX and THX Ultra2 decoding are engaged.

- THX Surround EX decoding is engaged when the SURROUND EX parameter is set to ON, or the SURROUND EX parameter is set to AUTO and a flagged 5.1-channel Dolby Digital source with THX Surround EX encoding is detected.
- THX Ultra2 decoding is engaged when the SURROUND EX parameter is set to OFF, or the SURROUND EX parameter is set to AUTO and a non-flagged 5.1-channel Dolby Digital source with or without THX Surround EX encoding is detected.

- Listening mode name differs depending on the encoding present in the input source, the SURROUND EX parameter setting, and the speaker setup.
 - The 5.1 THX ULTRA2 listening mode is available when THX Ultra2 decoding is engaged.
 - The 5.1 THX SurEX listening mode is available when THX Surround EX decoding is engaged.
 - The 5.1 THX listening mode is available when neither THX Ultra2 nor Surround EX decoding is engaged.
 - The 5.1 THX ULTRA2 and 5.1 THX SurEX listening modes cannot be activated unless side and rear speakers are present.

Note:

The SDP-5 cannot automatically detect THX Surround EX encoding in non-flagged 5.1-channel Dolby Digital sources. A non-flagged source does not include information in the input signal that identifies THX Surround EX encoding.

Parameter Setting \ Input Source	5.1-Channel Dolby Digital	5.1-Channel Surround EX-Encoded Dolby Digital (Flagged)	5.1-Channel Surround EX-Encoded Dolby Digital (Non-Flagged)
SURROUND EX: AUTO	5.1 THX ULTRA2	5.1 THX SurEX	5.1 THX ULTRA2
SURROUND EX: ON	5.1 THX SurEX	5.1 THX SurEX	5.1 THX SurEX
SURROUND EX: OFF	5.1 THX ULTRA2	5.1 THX ULTRA2	5.1 THX ULTRA2

5.1 THX MUSIC

MODE ADJUST ▶ **5.1 THX MUSIC**

- Designed for playback of 5.1-channel Dolby Digital music sources.
- The 5.1 THX MUSIC listening mode cannot be activated unless side and rear speakers are present.
- ASA processing is applied to signals sent to the rear speakers. Refer to the ASA parameter description on page 3-34 for more information.
- Recommended for home theaters with THX-certified loudspeakers.

Option/ Parameter	Default Setting	Possible Settings
COMPRESSION	OFF	AUTO, ON, OFF
LFE MIX	+0.0dB	-10.0 to +0.0dB
OUTPUT LEVELS		
CUSTOM		

Listening mode menu option and parameter descriptions begin on page 5-28.

Note:

The 5.1 THX MUSIC listening mode can only be activated with the front panel or remote control Mode ▲ and ▼ buttons.

DOLBY DIGITAL & DOLBY DIGITAL EX

MODE ADJUST ▶ **DOLBY DIGITAL OR DOLBY DIGITAL EX**

- Designed for playback of 5.1-channel Dolby Digital sources. The DOLBY DIGITAL EX listening mode is recommended for Dolby Digital sources recorded with Dolby Digital Surround EX. This listening mode can also be used with 5.1-channel Dolby Digital sources with mixed results.
- Listening mode name differs depending on the encoding present in the input source, the EX DECODING parameter setting, and the speaker setup. The table on the next page indicates the conditions in which Dolby Digital Surround EX decoding is engaged.
- Decodes 5.1 discrete channels from 5.1-channel Dolby Digital sources. The five main channels are full frequency. The .1 channel, often referred to as LFE information, has a limited frequency range of 120Hz.
- When the DOLBY DIGITAL EX listening mode is activated, matrix decoding derives a surround back channel from the other surround channels.

Option/ Parameter	Default Setting	Possible Settings
EX DECODING	AUTO	AUTO, ON, OFF
COMPRESSION	OFF	AUTO, ON, OFF
LFE MIX	+0.0dB	-10.0 to +0.0dB
OUTPUT LEVELS		
CUSTOM		

Listening mode menu option and parameter descriptions begin on page 5-28.

The table below indicates the conditions in which Dolby Digital Surround EX decoding is engaged.

- Dolby Digital Surround EX decoding is engaged when the EX DECODING parameter is set to ON, or the EX DECODING parameter is set to AUTO and a flagged 5.1-channel Dolby Digital source recorded with Dolby Digital Surround EX is detected.
- Dolby Digital Surround EX decoding is not engaged when the EX DECODING parameter is set to OFF, or the EX DECODING parameter is set to AUTO and a non-flagged 5.1-channel Dolby Digital source recorded without or without Dolby Digital Surround EX is detected.
- Listening mode name differs depending on the encoding present in the input source, the EX DECODING parameter setting, and the speaker setup.
 - The DOLBY DIGITAL EX listening mode is available when Dolby Digital Surround EX decoding is engaged.
 - The DOLBY DIGITAL listening mode is available when Dolby Digital Surround EX decoding is not engaged.
 - The DOLBY DIGITAL EX listening mode cannot be activated unless both side and rear speakers are present.

Note:

The SDP-5 cannot automatically detect Dolby Digital Surround EX encoding in non-flagged 5.1-channel Dolby Digital sources. A non-flagged source does not include information in the input signal that identifies Dolby Digital Surround EX encoding.

Parameter Setting \ Input Source	5.1-Channel Dolby Digital	5.1-Channel Dolby Digital EX (Flagged)	5.1-Channel Dolby Digital EX (Non-Flagged)
EX DECODING: AUTO	DOLBY DIGITAL	DOLBY DIGITAL EX	DOLBY DIGITAL
EX DECODING: ON	DOLBY DIGITAL EX	DOLBY DIGITAL EX	DOLBY DIGITAL EX
EX DECODING: OFF	DOLBY DIGITAL	DOLBY DIGITAL	DOLBY DIGITAL

5.1 2-CHANNEL

MODE ADJUST ▶ 5.1 2-CHANNEL

- Designed for converting 5.1-channel Dolby Digital-encoded input sources into 2-channel LOGIC7-encoded output signals.
- Sends downmixed 5.1-channel Dolby Digital input signals to the front speakers and subwoofer.
- Recommended for recording purposes.

Option/ Parameter	Default Setting	Possible Settings
CENTER MIX	+0dB	-25 to +5dB
SURROUND MIX	+0dB	-5 to +5dB
CNTR DLY SAMPLES	+0	-127 to +127
MASTER LEVEL	+0dB	-5 to +5dB
COMPRESSION	OFF	AUTO, ON, OFF
LFE MIX	+0.0dB	-20.0 to +0.0dB
SUB LEVEL	+0dB	OFF, -30 to +12dB
CUSTOM		

Listening mode menu option and parameter descriptions begin on page 5-28.

5.1 MONO LOGIC

MODE ADJUST ▶ 5.1 MONO LOGIC

- Designed for playback of Dolby Digital-encoded mono sources.
- Uses proprietary JBL Synthesis reverb algorithms to realistically expand mono sources to use all channels, dramatically increasing the perceived width and sense of envelopment of the listening space.

Option/ Parameter	Default Setting	Possible Settings
EFFECT LVL	-9dB	-12 to +6dB
ACADEMY FILTER	ON	ON, OFF
SURR ROLLOFF	3.1kHz	500Hz to 20.0kHz, OFF
OUTPUT LEVELS		
CUSTOM		

Listening mode menu option and parameter descriptions begin on page 5-28.

Note:

When a 1.0 Dolby Digital input source is present, the SDP-5 automatically activates the 5.1 MONO LOGIC listening mode.

5.1 MONO SURR

MODE ADJUST ▶ 5.1 MONO SURR

- Designed for playback of Dolby Digital-encoded mono sources.
- Sends mono signals to all channels.

Option/ Parameter

OUTPUT LEVELS

CUSTOM

Listening mode menu option and parameter descriptions begin on page 5-28.

5.1 MONO

MODE ADJUST ▶ 5.1 MONO

- Designed for playback of Dolby Digital-encoded mono sources.
- Sends a mono signal to the center channel.

Option/ Parameter

Default Setting

Possible Settings

SUB LEVEL

+0dB

OFF, -30 to +12dB

CUSTOM

Listening mode menu option and parameter descriptions begin on page 5-28.

dts-ES DECODING

The table below indicates the conditions in which dts-ES decoding is engaged.

- dts-ES decoding is engaged when the ES DECODING parameter is set to ON, or the ES DECODING parameter is set to AUTO and a 5.1-channel matrix-encoded or 6.1-channel discrete-encoded dts-ES source is detected.
- dts-ES decoding is not engaged when the ES DECODING parameter is set to OFF, or the ES DECODING parameter is set to AUTO and a 5.1-channel dts source is detected.
- Listening mode names differ depending on the encoding present in the input source, the ES DECODING parameter setting, and the speaker setup.
 - dts-ES listening modes are available when dts-ES decoding is engaged.
 - dts listening modes are available when dts-ES decoding is not engaged.
 - dts-ES listening modes cannot be activated unless both side and rear speakers are present.

Note:

The table below is not applicable to the dts-ES THX, dts THX ULTRA2, and dts THX MUSIC listening modes.

Parameter Setting \ Input Source	5.1-Channel dts	5.1-Channel Matrix-Encoded dts-ES	6.1-Channel Discrete-Encoded dts-ES
ES DECODING: AUTO	dts	dts-ES	dts-ES
ES DECODING: ON	dts-ES	dts-ES	dts-ES
ES DECODING: OFF	dts	dts	dts

dts(-ES) L7 FILM**MODE ADJUST** ▶ **dts ES L7 FILM**

- A proprietary listening mode.
- Designed for playback of 5.1- and 6.1-channel dts(-ES) film sources.
- Uses an advanced matrix to derive seven channels from 5.1 and 6.1-channel dts(-ES) sources. When both side and rear speakers are present, the dts(-ES) L7 FILM listening mode also increases the perceived length and sense of envelopment of the listening space.
- Provides remarkable improvement compared to other decoders.
- Recommended for 5.1- and 6.1-channel dts(-ES) film sources.

Option/ Parameter	Default Setting	Possible Settings
VOCAL ENHANCE	+0.0dB	+6.0dB, +3.0dB, +0.0dB
5 SPKR ENHANCE	OFF	ON, OFF
BASS ENHANCE	OFF	ON, OFF
RE-EQUALIZER	ON	ON, OFF
REAR DLY OFFSET	15ms	OFF, 1 to 30ms
LFE MIX	+0.0dB	-10.0 to +0.0dB
ES DECODING	OFF	AUTO, ON, OFF
OUTPUT LEVELS		
CUSTOM		

Listening mode menu option and parameter descriptions begin on page 5-28.

dts(-ES) L7 MUSIC**MODE ADJUST** ▶ **dts ES L7 MUSIC**

- A proprietary listening mode.
- Designed for playback of 5.1- and 6.1-channel dts(-ES) music sources.
- Based on the dts(-ES) L7 FILM listening mode, but specifically tailored for music sources.
- Recommended for 5.1- and 6.1-channel dts(-ES) music sources.

Option/ Parameter	Default Setting	Possible Settings
VOCAL ENHANCE	+0.0dB	+6.0dB, +3.0dB, +0.0dB
5 SPKR ENHANCE	OFF	ON, OFF
BASS ENHANCE	OFF	ON, OFF
REAR DLY OFFSET	15ms	OFF, 1 to 30ms
LFE MIX	+0.0dB	-10.0 to +0.0dB
ES DECODING	OFF	AUTO, ON, OFF
OUTPUT LEVELS		
CUSTOM		

Listening mode menu option and parameter descriptions begin on page 5-28.

dts THX ULTRA2 & dts-ES THX



- Designed for playback of 5.1-channel dts, 5.1-channel matrix-encoded dts-ES, and 6.1-channel discrete-encoded dts-ES film sources.
- Listening mode name differs depending on the encoding present in the input source, the ES DECODING parameter setting, and the speaker setup. The table below indicates the conditions in which THX Ultra2 and dts-ES decoding are engaged.
- Allows 7-channel playback of 5.1-channel dts sources without dts-ES encoding.
- Applies THX re-equalization to simulate high-frequency rolloffs that occur in movie theaters. Most films are mixed for movie theaters, and might sound too bright when played back in home theaters without re-equalization.
- Applies THX timbre matching to minimize timbre differences between the front and surround channels, which results in smoother sound movements between them.

- When the dts THX ULTRA2 listening mode is activated, ASA processing is applied to signals sent to the rear speakers. Refer to the ASA parameter description on page 3-34 for more information.
- When the dts THX ULTRA2 listening mode is activated, adaptive de-correlation increases the perceived width of the listening space. De-correlation of the mono surround channel increases the perceived width of the surround field in home theaters.
- Recommended for home theaters with THX-certified loudspeakers.

Option/ Parameter	Default Setting	Possible Settings
RE-EQUALIZER	ON	ON, OFF
LFE MIX	+0.0dB	-10.0 to +0.0dB
ES DECODING	AUTO	AUTO, ON, OFF
OUTPUT LEVELS		
CUSTOM		

Listening mode menu option and parameter descriptions begin on page 5-28.

Parameter Setting \ Input Source	5.1-Channel dts	5.1-Channel Matrix-Encoded dts-ES	6.1-Channel Discrete-Encoded dts-ES
ES DECODING: AUTO	dts THX ULTRA2	dts-ES THX	dts-ES THX
ES DECODING: ON	dts-ES THX	dts-ES THX	dts-ES THX
ES DECODING: OFF	dts THX ULTRA2	dts THX ULTRA2	dts THX ULTRA2

The table at the bottom of the previous page indicates the conditions in which THX Ultra2 and dts-ES decoding are engaged.

- THX Ultra2 decoding is engaged when the ES DECODING parameter is set to OFF, or the ES DECODING parameter is set to AUTO and a 5.1-channel dts source is detected.
- dts-ES decoding is engaged when the ES DECODING parameter is set to ON, or the ES DECODING parameter is set to AUTO and a 5.1-channel matrix-encoded or 6.1-channel discrete-encoded dts-ES source is detected.
- Listening mode name differs depending on the encoding present in the input source, the ES DECODING parameter setting, and the speaker setup.
 - The dts THX ULTRA2 listening mode is available when THX Ultra2 decoding is engaged.
 - The dts-ES THX listening mode is available when dts-ES decoding is engaged.
 - The dts THX ULTRA2 and dts(-ES) THX listening modes cannot be activated unless side and rear speakers are present.

dts THX MUSIC

MODE ADJUST ▶ 

- Designed for playback of 5.1-channel dts music sources.
- The dts THX MUSIC listening mode cannot be activated unless side and rear speakers are present.
- ASA processing is applied to signals sent to the rear speakers. Refer to the ASA parameter description on page 3-34 for more information.
- Recommended for home theaters with THX-certified loudspeakers.

Option/ Parameter	Default Setting	Possible Settings
LFE MIX	+0.0dB	-10.0 to +0.0dB
OUTPUT LEVELS		
CUSTOM		

Listening mode menu option and parameter descriptions begin on page 5-28.

Note:

The dts THX MUSIC listening mode can only be activated with the front panel or remote control Mode ▲ and ▼ buttons.

dts(-ES)



- Designed for playback of 5.1- and 6.1-channel dts(-ES) sources.
- Decodes 5.1 matrix or 6.1 discrete channels from dts(-ES) sources. The six main channels are full-frequency. The .1 channel, often referred to as LFE information, has a limited frequency range of 120Hz.
- Appropriate for dts(-ES) film sources.

Option/ Parameter	Default Setting	Possible Settings
LFE MIX	+0.0dB	-10.0 to +0.0dB
ES DECODING	AUTO	AUTO, ON, OFF
OUTPUT LEVELS		
CUSTOM		

Listening mode menu option and parameter descriptions begin on page 5-28.

dts(-ES) 2-CHAN



- Designed for converting 5.1- or 6.1-channel dts(-ES) sources into 2-channel LOGIC7-encoded output signals.
- Sends downmixed 5.1- or 6.1-channel dts(-ES) input signals to the front speakers and subwoofer.
- Recommended for recording purposes.

Option/ Parameter	Default Setting	Possible Settings
CENTER MIX	+0dB	-25 to +5dB
SURROUND MIX	+0dB	-5 to +5dB
CNTR DLY SAMPLES	+0	-127 to +127
MASTER LEVEL	+0dB	-5 to +5dB
LFE MIX	+0.0dB	-20.0 to +0.0dB
ES DECODING	AUTO	AUTO, ON, OFF
SUB LEVEL	+0dB	OFF, -30 to +12dB
CUSTOM		

Listening mode menu option and parameter descriptions begin on page 5-28.

5.1a BYPASS

MODE ADJUST ▶ 5.1a BYPASS

- Designed for playback of 5.1-channel analog sources, such as DVD-A or SACD players.
- The 5.1-channel analog input connectors are sent directly to the Main Zone volume control and audio output connectors as shown on page 3-46. These signals receive no internal processing.
- When both side and rear speakers are present, surround channel signals are sent in parallel to the side and rear speakers. To configure a 5-channel speaker setup, set the OUTPUT LEVELS menu SIDE L/R or REAR L/R parameter to OFF to deactivate the associated surround speakers.
- The 5.1a BYPASS listening mode is automatically activated whenever one of the 5.1-channel analog audio input connectors is assigned to the selected input.
- The 5.1a BYPASS listening mode is the only listening mode available for 5.1-channel analog sources.

Option/ Parameter

OUTPUT LEVELS

CUSTOM

Listening mode menu option and parameter descriptions begin on page 5-28.

Note:

Speaker crossover settings, speaker distances, and audio (tone) controls are not available when the 5.1a BYPASS listening mode is activated.

2CH BYPASS

MODE ADJUST ▶ 2CH BYPASS

- Designed for playback of 2-channel analog sources.
- Analog audio input signals are sent to the Main Zone audio output connectors labeled Front L/R. These input signals receive no internal processing.
- The 2CH BYPASS listening mode is automatically activated when a 2-channel analog audio source is present and the MAIN ADV menu 2-CH ANLG BYP parameter is set to ON.
- The 2CH BYPASS listening mode is not available when the MAIN ADV menu INPUT SELECT parameter is set to AUTO and a digital audio source is present.
- No parameters are available for the 2CH BYPASS listening mode.

Note:

Speaker crossover settings, speaker distances, and audio (tone) controls are not available when the 2CH BYPASS listening mode is activated.

LISTENING MODE MENU OPTION & PARAMETER DESCRIPTIONS

5 SPKR ENHANCE ON, OFF

Simulates 7-channel playback in 5-channel speaker configurations. When set to ON, the SDP-5 provides an increased sense of spaciousness and envelopment through the surround speakers. This enhancement is most noticeable when the surround speakers are positioned to the side of the primary listening position, or when the primary listening position is located against the rear wall. The effectiveness of this parameter varies within the listening space. For best results, it is recommended to position the surround speakers to the left and right sides of the primary listening position.

ACADEMY FILTER ON, OFF

When set to ON, restores the proper tonal balance of older mono film sources that have much narrower frequency responses than more recent mono film sources.

AUTO AZIMUTH ON, OFF

Maximizes matrix steering accuracy. When set to ON, the SDP-5 continually monitors the 2-channel input signal and automatically adjusts the relative level and time offset of the input channels to ensure that signals are sent to the appropriate channels with maximum separation. When set to OFF, the accuracy of the selected listening mode varies among sources. It is recommended to set this parameter to ON for film and broadcast sources and to OFF for music sources.

BASS CONTENT BINAURL, MONO, STEREO

Adjusts the bass content of binaural, mono, and stereo recordings. When set to BINAURL, the SDP-5 activates low-frequency compensation. Select this setting for true binaural sources recorded with dummy head microphones. Select the MONO setting for sources recorded with mono bass. Select the STEREO setting for sources recorded with stereo bass.

BASS ENHANCE ON, OFF

Enhances stereo bass, which results in low-frequency reproduction that is less localizable and more realistic in the listening space. The effectiveness of the BASS ENHANCE parameter varies depending on room acoustics and the ability of the surround speakers to reproduce low frequencies. It is recommended to use front, side, or rear speakers that are capable of reproducing frequencies of 40Hz or lower.

Note:

When the BASS ENHANCE parameter is set to ON, most listening spaces have a 2 to 3dB reduction in low-frequency energy. It is recommended to use the AUDIO CONTROLS menu BASS parameter to compensate for this reduction.

CAUTION

When set to ON, the BASS ENHANCE parameter might damage speakers that are not capable of producing low frequencies below 80Hz.

BASS RT

5ms to 48.6s

Works with the MID RT and SIZE parameters to adjust the amount of time required for low-frequency information to decay below 60dB in level. The BASS RT parameter setting should match the MID RT parameter setting for more natural effects in smaller listening spaces.

CAUTION

Setting the BASS RT, MID RT, and SIZE parameters to a high value may produce undesirable or damaging audio.

CALIBRATION

Opens the PANORAMA listening mode CALIBRATION menu, which can be used to calibrate the PANORAMA listening mode. Refer to page 5-11 for more information.

CENTER

OFF, -30 to +12dB

MODE ADJUST ▶ **(Listening Mode)** ▶ **OUTPUT LEVELS** ▶ **CENTER**

Controls the output level of the Main Zone audio output connector labeled Center.

CENTER DEPTH

0 to 18

Adjusts the amount of processing applied to the center channel, changing the perceived distance of the center speaker. Higher settings increase and lower settings decrease the perceived distance of the center speaker from the listening position.

CENTER MIX

-25 to +5dB

Indicates the relative center channel level for downmixing. It is recommended to set this parameter to +0dB for film sources and -5dB for music sources.

CNTR DLY SAMPLES

-127 to +127

Controls the relative time offset of the center channel. It is recommended to set this parameter to +0 unless the center channel is not properly timed and the value of the error is known.

COMPRESSION

AUTO, ON, OFF

Reduces wide volume level changes and increases dialog intelligibility at lower listening levels for Dolby Digital input sources. When set to ON, full compression is applied regardless of volume level. When set to OFF, compression is not applied. It is recommended to set this parameter to AUTO or ON for Dolby Digital input sources that are listened to at lower volume levels, especially for night time viewing to avoid disturbing others.

CTR WIDTH

MIN, 1 to 6, MAX

Adjusts the center image. When set to MIN, the center image is heard from just the center speaker. When set to MAX, the center image is heard from just the front left and right speakers as a "phantom" center image. When set on the 1 to 6 scale, the center image is heard in various combinations of the front and center speakers.

CUSTOM

MODE ADJUST ▶ **(Listening Mode)** ▶ **CUSTOM**

Opens the CUSTOM menu, which can be used to compare custom and factory-default versions of the selected listening mode and to restore the factory default version of the selected listening mode.

... *Listening Mode Menu Option & Parameter Descriptions continues on page 5-30*

Listening Mode Menu Option & Parameter Descriptions

(continued from page 5-29)

CUSTOM VS PRESET

MODE ADJUST ▶ **(Listening Mode)** ▶ **CUSTOM** ▶ **CUSTOM VS PRESET**

Allows comparison listening to the custom and factory-default versions of the selected listening mode. When PRESET is selected, the listening mode is heard in its factory-default condition – as if all parameters had been restored to their factory-default settings. No parameter settings are affected when this option is selected. The listening mode will revert to its modified condition when the CUSTOM VS PRESET option is closed.

When CUSTOM is selected, the listening mode is heard in its custom condition – with all of its current parameter settings. The CUSTOM option is available even when no parameter settings have been adjusted. However, the PRESET and CUSTOM options will sound identical until adjustments are made.

To toggle between the factory-default and modified versions of the selected listening mode:

1. Follow the CUSTOM VS PRESET menu path to open the CUSTOM VS PRESET drop-down menu.
2. When the CUSTOM VS PRESET drop-down menu opens, press the Menu ▲ and ▼ arrows to toggle between the PRESET (factory-default) and CUSTOM (customized) versions of the selected listening mode.
3. When finished, press the Menu ◀ arrow to close the CUSTOM VS PRESET menu.
4. Press the Menu ◀ arrow to close the CUSTOM menu and return to the listening mode menu.

DIMENSION

FRONT, NEUTRAL, REAR

Controls the relative balance of the sound field, which can be useful with certain recordings to achieve a more suitable balance among all speakers. When set to FRONT, the sound field is balanced toward the front of the listening space. When set to NEUTRAL, the sound field is balanced at the center of the listening space. When set to REAR, the sound field is balanced toward the rear of the listening space.

EFFECT LVL

-12 to +6dB

Adjusts the amount of effect applied to the listening mode.

ES DECODING

AUTO, ON, OFF

Controls the dts-ES decoding feature, which can be used to extract a rear channel from dts sources.

- When set to ON, dts-ES decoding is engaged for all dts(-ES) sources.
- When set to OFF, dts-ES decoding is not engaged for all dts(-ES) sources.
- When set to AUTO, dts-ES decoding is engaged when a 5.1-channel matrix-encoded or 6.1-channel discrete-encoded dts-ES source is detected. dts-ES decoding is not engaged when a 5.1-channel dts source is detected.

dts-ES listening modes are available when dts-ES decoding is engaged. dts listening modes are available when dts-ES decoding is not engaged. dts-ES decoding cannot be engaged unless both side and rear speakers are present. Refer to page 5-22 for more information.

When the Shift command bank is activated, pressing the remote control dts button while a dts(-ES) input source is present toggles the ES DECODING parameter, cycling through the AUTO, ON, and OFF settings.

Note:

The dts(-ES) STATUS menu includes the SB level meter when:

- The ES DECODING parameter is set to ON and a 5.1-channel dts source is present.
 - The ES DECODING parameter is set to AUTO and a 5.1-channel matrix-encoded or 6.1-channel discrete-encoded dts-ES source is present.
-

EX DECODING

AUTO, ON, OFF

Controls the Dolby Digital Surround EX decoding feature, which can be used to extract a rear channel from 5.1-channel Dolby Digital sources.

- When set to ON, Dolby Digital Surround EX decoding is engaged for all 5.1-channel Dolby Digital sources.
- When set to OFF, Dolby Digital Surround EX decoding is not engaged for all 5.1-channel Dolby Digital sources.
- When set to AUTO, Dolby Digital Surround EX decoding is engaged when a flagged 5.1-channel Dolby Digital source recorded with Surround EX is detected. Dolby Digital Surround EX decoding is not engaged when a non-flagged 5.1-channel Dolby Digital source recorded with or without Surround EX is detected.
- The SDP-5 cannot automatically detect Dolby Digital Surround EX encoding in non-flagged 5.1-channel Dolby Digital sources. A non-flagged source does not include information in the input signal that identifies Dolby Digital Surround EX encoding.

The DOLBY DIGITAL EX listening mode is available when Dolby Digital Surround EX decoding is engaged. The DOLBY DIGITAL listening mode is available when Dolby Digital Surround EX decoding is not engaged. Dolby Digital Surround EX decoding cannot be engaged unless both side and rear speakers are present. Refer to page 5-18 for more information.

When the Shift command bank is activated, pressing the remote control DOLBY button while a 5.1-channel Dolby Digital input source is present activates the DOLBY DIGITAL EX or DOLBY DIGITAL listening mode. Subsequent presses toggle the EX DECODING parameter, cycling through the AUTO, ON, and OFF settings.

FRONT STEERING

OFF, MSURR, MUSIC, FILM

Adjusts front steering between the front left, front right, and center speakers. When set to FILM, maximum front steering is applied to the center channel. When set to MUSIC, moderate front steering is applied. When set to MSURR, minimum front steering is applied. When set to OFF, no front steering is applied. It is recommended to set this parameter to FILM for film and broadcast sources and to MUSIC, MSURR, or OFF for music sources.

INPUT BALANCE

L< to <|> to >R

Controls the balance of the selected stereo analog audio input connectors, compensating for audio input sources with audible channel imbalance.

... Listening Mode Menu Option & Parameter Descriptions continues on page 5-32

Listening Mode Menu Option & Parameter Descriptions

(continued from page 5-31)

LFE MIX -20.0 or -10.0 to +0.0dB

Controls the output level of LFE information – the .1 channel in a 5.1- or 6.1-channel input source – that is sent to the Main Zone audio output labeled Subwoofer. Low frequencies from up to seven other channels might be combined with the LFE information to create the subwoofer output signal, which significantly increases subwoofer output levels. Careful adjustment of this parameter allows achievement of proper tonal balance and reduces the risk of subwoofer overload. When the speaker setup does not include a subwoofer, LFE information is mixed into speakers for which the corresponding CUSTOM SETUP menu parameter is set to FULL or to the lowest crossover points.

LISTENER POS -127 to +127

Refer to page 5-12.

LIVENESS 30ms to 20.2s

Depends on the SIZE parameter setting. The LIVENESS parameter adjusts the amount of effect recirculation. Higher settings mimic more reflective surfaces and increase decay time.

LOW FREQ WIDTH -25 to +25dB

Applies low-frequency spatial correction to the input signal. This correction is applied to un-correlated input signals below 60Hz.

MASTER LEVEL -5 to +5dB

Adjusts the output level of 2-channel LOGIC7-encoded sources.

MID RT 24ms to 24.3s

Works with the BASS RT and SIZE parameters to adjust the amount of time required for mid-frequency information to decay below 60dB in level.

CAUTION Setting the BASS RT, MID RT, or SIZE parameters to a high value may produce undesirable or damaging audio.

OUTPUT LEVELS

MODE ADJUST ▶ **(Listening Mode)** ▶ **OUTPUT LEVELS**

Opens the OUTPUT LEVELS menu, which can be used to adjust output levels for the Main Zone audio output connectors labeled Center, Subwoofer, Side L/R, and Rear L/R. The OUTPUT LEVELS option does not appear on listening mode menus when the listening mode does not accommodate multi-channel output signals. Instead, an output-specific parameter appears. For instance, the Mono listening mode menu includes a SUB LEVEL parameter.

Option/ Parameter	Default Setting	Possible Settings
CENTER	+0dB	OFF, -30 to +12dB
SIDE L/R	+0dB	OFF, -30 to +12dB
REAR L/R	+0dB	OFF, -30 to +12dB
SUBWOOFER	+0dB	OFF, -30 to +12dB

PANORAMA ON, OFF

When set to ON, extends the front stereo image to include surround channel signals, which creates a “wraparound” effect with side wall imaging.

Note:

The DOLBY PLII MUSIC listening mode PANORAMA parameter should not be confused with the separate PANORAMA listening mode (5-11).

PRE-DELAY OFF, 1 to 100ms

Adjusts delay time between the direct sound and the onset of reverberation. Higher settings make the simulated space sound larger. Because some pre-delay is inherent in all source material, it is recommended to begin with the parameter set to OFF, then make adjustments accordingly.

RE-EQUALIZER ON, OFF

Simulates high-frequency rolloffs that occur in movie theaters. When set to ON, the SDP-5 applies a high-frequency filter. When set to OFF, the SDP-5 does not apply a high-frequency filter. It is recommended to set this parameter to ON for film sources, as many films are mixed for movie theaters and might sound too bright when played back in home theaters without re-equalization.

REAR DLY OFFSET OFF, 1 to 30ms

Increases the perceived depth of the listening space by delaying the arrival time of rear speaker signals. It is recommended to increase the setting when using side and rear speakers that are located close together or when a greater sense of depth is desired in the listening space.

REAR L/R OFF, -30 to +12dB

MODE ADJUST ▶ **(Listening Mode)** **OUTPUT LEVELS** ▶ **REAR L/R**

Controls the output level of the Main Zone audio output connector labeled Rear L/R.

RESET MODE

MODE ADJUST ▶ **(Listening Mode)** ▶ **CUSTOM** ▶ **RESET MODE**

Restores the factory-default version of the selected listening mode, restoring all listening mode menu parameters to their factory-default settings.

To restore the factory-default version of the selected listening mode:

1. Follow the RESET MODE menu path. The “PRESS RIGHT → TO RESTORE MODE” drop-down message.
2. When the drop-down message opens, press the Menu ▶ arrow to restore the factory-default version of the selected listening mode and close the message. Press the Menu ◀ arrow to close the message without restoring the factory-default version of the selected listening mode.

... Listening Mode Menu Option & Parameter Descriptions continues on page 5-34

Listening Mode Menu Option & Parameter Descriptions

(continued from page 5-33)

RESET MODE (continued)

MODE ADJUST ▶ **(Listening Mode)** ▶ **CUSTOM** ▶ **RESET MODE**

3. Press the Menu ◀ arrow to close the CUSTOM menu and return to the listening mode menu.

Note:

When the CUSTOM menu RESET MODE option is selected to restore the factory-default version of the selected listening mode, the corresponding TRIGGER SETUP menu listening mode parameter is automatically set to OFF.

ROLLOFF 500Hz to 20.0kHz, OFF

Simulates the absorption of high frequencies in a real space. It is recommended to begin with a low setting to simulate high-frequency absorptive spaces.

SIDE L/R OFF, -30 to +12dB

MODE ADJUST ▶ **(Listening Mode)** ▶ **OUTPUT LEVELS** ▶ **SIDE L/R**

Controls the output level of the Main Zone audio output connector labeled Side L/R.

SIZE 4 to 20 or 30m

Adjusts the length of the listening space within a 4 to 20 or 30m range (depending on the listening mode). Increase the size of the space to increase the reverb effect.

CAUTION

Setting the BASS RT, MID RT, and SIZE parameters to a high value may produce undesirable or damaging audio.

SOUND STAGE FRONT, NEUTRAL, REAR

Dynamically controls the relative balance of the Main Zone audio output connectors. When set to FRONT, Side L/R and Rear L/R output levels are attenuated by 6dB, shifting the perceived balance of the sound field to the front of the listening space. When set to NEUTRAL, Side L/R and Rear L/R output levels are slightly attenuated by 3dB, shifting the perceived balance of the sound field to the center of the listening space. When set to REAR, Side L/R and Rear L/R output levels are not attenuated, preserving the intended balance of the sound field.

SOURCE RIGHT, LEFT & RIGHT, LEFT

Refer to page 5-12.

SPEAKER ANGLE 10 to 90deg

Refer to page 5-12.

SPEECH DETECT ON, OFF

Distinguishes monaural speech from other input sources. When set to ON, effects are lowered to minimize interference and unnatural echo in monaural speech. When stereo input sources are present, the front left and right channels are independently used as inputs for ambience synthesis. When strong monaural speech is present in the input source, the monaural component of the ambience effect is reduced and the stereo component of the effect is increased. When set to OFF, the amount of ambience synthesis is dynamically controlled.

SUB LEVEL OFF, -30 to +12dB

Controls the output level of the Main Zone audio output connector labeled Subwoofer. The SUB LEVEL parameter appears on listening mode menus when the listening mode does not accommodate multi-channel output signals.

SUBWOOFER OFF, -30 to +12dB

MODE ADJUST ▶ **(Listening Mode)** ▶ **OUTPUT LEVELS** ▶ **SUBWOOFER**

Controls the output level of the Main Zone audio output connector labeled Subwoofer.

SURR ROLLOFF 500Hz to 20.0kHz, OFF

Applies high-frequency attenuation control to the Main Zone audio output connectors labeled Side L/R and Rear L/R. This filter is only applied to output signals generated by the SDP-5.

SURROUND DLY 0 to 15ms

Increases the perceived depth of the listening space by delaying the arrival time of signals from the side and rear speakers. It is recommended to increase the setting when a greater sense of depth is desired in the listening space.

SURROUND EX AUTO, ON, OFF

Controls the THX Surround EX decoding feature, which can be used to extract a rear channel from 5.1-channel Dolby Digital sources.

- When set to ON, THX Surround EX decoding is engaged for all 5.1-channel Dolby Digital sources.
- When set to OFF, THX Surround EX decoding is not engaged for all 5.1-channel Dolby Digital sources.
- When set to AUTO, THX Surround EX decoding is engaged when a flagged 5.1-channel Dolby Digital source with THX Surround EX encoding is detected. THX Surround EX decoding is not engaged when a non-flagged 5.1-channel Dolby Digital source with or without THX Surround EX encoding is detected.
- The SDP-5 cannot automatically detect THX Surround EX encoding in non-flagged 5.1-channel Dolby Digital sources. A non-flagged source does not include information in the input signal that identifies THX Surround EX encoding.

The 5.1 THX SurEX listening mode is available when THX Surround EX decoding is engaged. The 5.1 THX and 5.1 THX ULTRA2 listening modes are available when THX Surround EX decoding is not engaged. THX Surround EX decoding cannot be engaged unless both side and rear speakers are present. Refer to page 5-16 for more information.

... *Listening Mode Menu Option & Parameter Descriptions continues on page 5-36*

Listening Mode Menu Option & Parameter Descriptions

(continued from page 5-31)

SURROUND EX (continued)

When the Shift command bank is activated, pressing the remote control THX button while a 5.1-channel Dolby Digital input source is present activates the 5.1 THX, 5.1 THX ULTRA2, or 5.1 THX SurEX listening mode.

Note:

Toggleing the SURROUND EX parameter setting produces low-level clicks in the front speakers.

SURROUND MIX -5 to +5dB

Controls the relative level of surround channel information sent to the Main Zone audio output connectors labeled Front L/R. It is recommended to set this parameter to +2 or +3dB for all input sources.

VOCAL ENHANCE +6.0dB, +3.0dB, +0.0dB

Controls the level of dialog boost in the Main Zone audio output connector labeled Center. Increase this setting to improve dialog intelligibility, particularly at lower volume levels.

6

Troubleshooting & Maintenance

Troubleshooting	6-2
Routine Maintenance	6-3
Restoring Factory-Default Settings	6-4

TROUBLESHOOTING

The SDP-5 does not power on.

1. Attempt to power on the SDP-5 with the front panel standby button and remote control On button.
2. Make sure the rear panel power switch is set to the \bigcirc ("on") position.
3. Examine the power cord to ensure a good connection between the rear panel AC input connector and the wall outlet.
4. Check the electrical circuit and breaker.

The remote control does not work.

1. Make sure the front panel IR receiver window shown on page 2-3 is not obstructed. The remote control must be in line-of-sight with the receiver for proper operation. Refer to page 2-9 for more information.
2. Make sure the remote control batteries are correctly inserted with the proper polarity. Refer to page 1-5 for instructions to install new batteries.

The SDP-5 is powered on, but there is no audio.

1. Examine the audio cables to ensure a good connection to the associated amplifier.
2. Make sure volume level is audible. Volume level can be increased with the front panel volume knob (2-3) or the remote control VOL \blacktriangle and \blacktriangledown buttons (2-14).

3. Make sure audio has not been muted. The message "MUTE ON" or "FULL MUTE ON" will appear on the on-screen and front panel displays when audio has been muted. To deactivate mute, press the front panel or remote control Mute button or use the front panel volume knob or the remote control VOL \blacktriangle and \blacktriangledown buttons to adjust volume level.
4. Check the INPUT SETUP menu DIGITAL IN and ANALOG IN parameters to ensure the appropriate audio connector is assigned to the selected input. Refer to page 3-6 for more information.
5. Make sure the SDP-5 is receiving an audio signal. To do this, follow the instructions that begin on page 2-18 to open the STATUS menu for the current input source.
6. Make sure all associated power amplifiers are powered on.

Dialog sounds muffled.

1. If the speaker setup does not include a center speaker, make sure a custom – as opposed to a JBL Synthesis – speaker setup is selected. Then, make sure the CUSTOM SETUP menu CENTER parameter is set to NONE (3-29).

A humming sound is present in the audio.

1. If a cable TV connection is present, disconnect the cable from the wall outlet. If this eliminates the humming sound, a ground loop isolation device is required. Contact your dealer or the cable provider for assistance.
2. Disconnect components one at a time to isolate the problem. Once the problem is identified, make sure the associated component is properly grounded and connected to the same electrical circuit as the SDP-5.

The SDP-5 is powered on, but there is no video.

1. Examine the video cables – particularly the S-video cables – to ensure a good connection to the associated component.
2. Check the INPUT SETUP menu VIDEO IN (page 3-11) and COMPONENT IN (page 3-12) parameters to ensure the appropriate video connector is assigned to the selected input.

RF interference is present in the audio or video.

1. Make sure the SDP-5 is not positioned near unshielded TV or FM antennas, cable TV decoders, and other RF-emitting devices.
2. Replace unshielded cables with shielded cables wherever possible.

The SDP-5 is exhibiting erratic behavior.

1. Set the rear panel power switch to the I (“off”) position. Wait 10 seconds. Then, set the rear panel power switch to the O (“on”) position.
2. Document all user-defined settings on the installation worksheet that begins on page A-14. Then, follow the instructions on the next page to restore factory-default settings.

If all else fails . . .

1. Set the rear panel power switch to the I (“off”) position. Wait 10 seconds. Then, set the rear panel power switch to the O (“on”) position.

2. Document all user-defined settings on the installation worksheet that begins on page A-14. Then, follow the instructions on the next page to restore factory-default settings.
3. Contact an authorized JBL Synthesis dealer.
4. Contact JBL Synthesis customer service at 818-830-8757.

Note:

Visit www.jblsynthesis.com for additional troubleshooting information.

ROUTINE MAINTENANCE

The bulleted items below describe routine maintenance that should be performed on a periodic basis.

- Clean the SDP-5 exterior surface with a soft, lint-free cloth. Do not use alcohol, benzene, acetone-based cleaners, or strong commercial cleaners. Do not use a cloth made with steel wool or metal polish. If the SDP-5 is exposed to a dusty environment, a low-pressure blower can be used to remove dust from its exterior surface.
- Replace the remote control batteries as needed. The remote control requires two AA batteries. When these batteries are low on power, the remote control enters a low-voltage condition that prevents it from operating the SDP-5. When this occurs, follow the instructions on page 1-5 to replace the batteries. Normal operation will resume when new batteries are installed.

RESTORING FACTORY-DEFAULT SETTINGS

When factory-default settings are restored, all parameters and user-defined values are restored to their factory-default settings. Before restoring factory-default settings, it is recommended to record all user-defined settings on the installation worksheet that begins on page A-14.

To restore factory-default settings:

1. Record all user-defined settings on the installation worksheet that begins on page A-14. When factory-default settings are restored, all parameters and user-defined values are restored to their factory-default settings.
2. If the SDP-5 is powered on, press the front panel standby button or the remote control Off button to activate standby mode and deactivate the SDP-5. If the SDP-5 is in standby mode, proceed to step 3.
3. Press the front panel standby button or the remote control On button to deactivate standby mode and activate the SDP-5.
4. Quickly press and hold the front panel or remote control Mute button until the FACTORY SETTINGS menu shown below opens on the on-screen and front panel displays.



The Mute button must be pressed within 2 seconds of activating the SDP-5. If the message "MUTE ON" appears on the on-screen and front panel displays when the Mute button

is pressed, too much time has passed. If this occurs, begin again with step 2.

5. Press the remote control Menu ▲ and ▼ arrows to highlight the desired option. Highlight the RESTORE DEFAULTS option to restore factory-default settings. Highlight the EXIT option to close the FACTORY SETTINGS menu without restoring factory-default settings.
6. When the desired option is highlighted, press the Menu ► arrow to select this option.
 - If the RESTORE DEFAULTS option was selected, the FACTORY SETTINGS message shown below appears on the on-screen and front panel displays. When this message appears, press a front panel or remote control button to restart the SDP-5.



- If the EXIT option is selected, the FACTORY SETTINGS menu will close and the two-line status (2-18) opens on the on-screen and front panel displays.

A

Appendix

Specifications	A-2
Declaration of Conformity	A-4
Menu Tree	A-4
Installation Worksheet	A-14

SPECIFICATIONS

Audio Input & Output Connectors	
Analog Audio Inputs	<ul style="list-style-type: none"> • 8 stereo (RCA) or 5 stereo and one 5.1-channel or 2 stereo and two 5.1-channel connectors
Digital Audio Inputs	<ul style="list-style-type: none"> • 4 S/PDIF coaxial (RCA) and 4 S/PDIF optical (TosLink) connectors • Coaxial and optical input connectors conform to IEC-958, S/PDIF standards • Accepts 44.1, 48, 88.2, and 96kHz sample rates • Accepts 16-24 bits PCM audio, Dolby Digital, dts, and dts-ES discrete data formats
Main Zone Audio Outputs	<ul style="list-style-type: none"> • 8 unbalanced (RCA) connectors for Front L/R, Center, Subwoofer, Side L/R, and Rear L/R
Zone 2 Audio Outputs	<ul style="list-style-type: none"> • 1 unbalanced (RCA, variable output level) stereo connector • 1 S/PDIF coaxial (RCA) connector

Main Zone Audio Performance	
A/D Conversion	<ul style="list-style-type: none"> • 24-bit, 96kHz, dual-bit $\Delta\Sigma$ architecture
D/A Conversion	<ul style="list-style-type: none"> • 24-bit, 44.1 to 192kHz, multi-bit $\Delta\Sigma$ architecture
Frequency Response	<ul style="list-style-type: none"> • 10Hz to 20kHz, +0.05dB/-0.1dB, -0.5dB at 40kHz, reference 1kHz
THD + Noise	<ul style="list-style-type: none"> • Below 0.008% at 1kHz, maximum output level
Dynamic Range	<ul style="list-style-type: none"> • 108dB minimum, 22kHz bandwidth
Signal-to-Noise Ratio	<ul style="list-style-type: none"> • 108dB minimum, 22kHz bandwidth
Input Sensitivity	<ul style="list-style-type: none"> • 200mVrms (2Vrms for maximum output level) at 0dB input gain

Main Zone Audio Performance (continued)	
Input Impedance	<ul style="list-style-type: none"> • 100kΩ in parallel with 150pF
Output Level	<ul style="list-style-type: none"> • 150mVrms typical, 6Vrms maximum (RCA connectors) • Maximum value with full-scale input signal and volume at +6dB
Output Impedance	<ul style="list-style-type: none"> • 100Ω in parallel with 150pF (RCA connectors) • 50Ω in parallel with 150pF (XLR connectors)

Zone 2 Audio Performance	
D/A Conversion	<ul style="list-style-type: none"> • 24-bit, 44.1 to 192kHz, multi-bit $\Delta\Sigma$ architecture
Frequency Response	<ul style="list-style-type: none"> • 10Hz to 20kHz, +0.1dB/-0.25dB, -0.75dB at 40kHz, reference 1kHz
THD + Noise	<ul style="list-style-type: none"> • Below 0.005% at 1kHz, maximum output level
Dynamic Range	<ul style="list-style-type: none"> • 103dB minimum, 22kHz bandwidth
Signal-to-Noise Ratio	<ul style="list-style-type: none"> • 103dB minimum, 22kHz bandwidth
Input Sensitivity	<ul style="list-style-type: none"> • 200mVrms (4Vrms for maximum output level)
Input Impedance	<ul style="list-style-type: none"> • 100kΩ in parallel with 150pF
Output Level	<ul style="list-style-type: none"> • 200mVrms typical, 4Vrms maximum (RCA connectors) • Maximum value with full-scale input signal and volume at 0dB
Output Impedance	<ul style="list-style-type: none"> • 100Ω in parallel with 150pF (RCA connectors)

Video Input & Output Connectors	
Video Inputs	<ul style="list-style-type: none"> • 5 composite (RCA), 5 S-video, and 3 component video (RCA)
Video Outputs	<ul style="list-style-type: none"> • 2 composite (RCA, 1 monitor and 1 Zone2), 2 S-video (1 monitor and 1 Zone2), and 1 component (RCA)

Composite & S-video Performance	
Compatibility	<ul style="list-style-type: none"> • NTSC, PAL, and SECAM
Switching	<ul style="list-style-type: none"> • Active
Output Level	<ul style="list-style-type: none"> • 1.0V peak-to-peak
Impedance	<ul style="list-style-type: none"> • 75Ω
Input Return Loss	<ul style="list-style-type: none"> • >40dB
Differential Gain	<ul style="list-style-type: none"> • <0.5%
Differential Phase	<ul style="list-style-type: none"> • <0.5°
Bandwidth	<ul style="list-style-type: none"> • >25MHz
K Factor	<ul style="list-style-type: none"> • <0.3%
Gain	<ul style="list-style-type: none"> • ±0.15dB
Signal-to-Noise Ratio	<ul style="list-style-type: none"> • >65dB
Frequency Response	<ul style="list-style-type: none"> • 10Hz to 10MHz + 0.1/-0.3dB

Component Video Performance	
Compatibility	<ul style="list-style-type: none"> • 3-channel (Y, Pr, Pb), format-independent
Switching	<ul style="list-style-type: none"> • Passive
Impedance	<ul style="list-style-type: none"> • 75Ω

Component Video Performance (continued)	
Insertion Loss	<ul style="list-style-type: none"> • <3dB
Bandwidth	<ul style="list-style-type: none"> • >150MHz

Other	
Trigger Outputs	<ul style="list-style-type: none"> • 1 power on/off and 1 programmable connector on detachable screw terminals (+12 VDC, 0.5 amps each)
RS-232 Serial Input/Output	<ul style="list-style-type: none"> • 2 9-pin D-sub connectors
Power Requirements	<ul style="list-style-type: none"> • 90-250 VAC, 50-60Hz, 60W (universal line input), detachable power cord
SDP-5 Dimensions & Weight	<ul style="list-style-type: none"> • Height (with feet): 5.04 inches (128mm) • Width: 17.3 inches (440mm) • Depth: 14.85 inches (377mm) • Weight: 24lbs (10.7kg)
Rack Mounting	<ul style="list-style-type: none"> • Brackets are provided for installation in a standard 19" equipment rack (3 rack units required).
Environment	<ul style="list-style-type: none"> • Operating Temperature: 0° to 35°C (32° to 95°F) • Storage Temperature: -30° to 75°C (-22° to 167°F) • Relative Humidity: 95% maximum without condensation
Remote Control	<ul style="list-style-type: none"> • Hand-held, backlit infrared remote control unit • Requires 2 AA batteries (Alkaline batteries recommended)

Specifications are subject to change without notice.

DECLARATION OF CONFORMITY**Application of Council Directive(s):**

89/336/EEC and 93/68/EEC

Standard(s) to which Conformity is Declared:

EN55022:1994 + A1:1995 + A2:1997, EN55024:1998,
EN61000-3-2: 2000, EN61000-3-3:2000, and
EN60065: 1998

Manufacturer: Lexicon, Inc.
3 Oak Park
Bedford, MA 01730-1413 USA

The equipment identified here conforms to the Directive(s)
and Standard(s) specified above.

Type of Equipment: Digital Controller

Model: JBL Synthesis SDP-5

Date: February 2003

Lexicon, Inc.
Vice President of Engineering
3 Oak Park
Bedford, MA 01730-1413 USA
Tel: 781-280-0300
Fax: 781-280-0490

MENU TREE

The menu tree that begins on the next page is based on Software
Version 1.0.

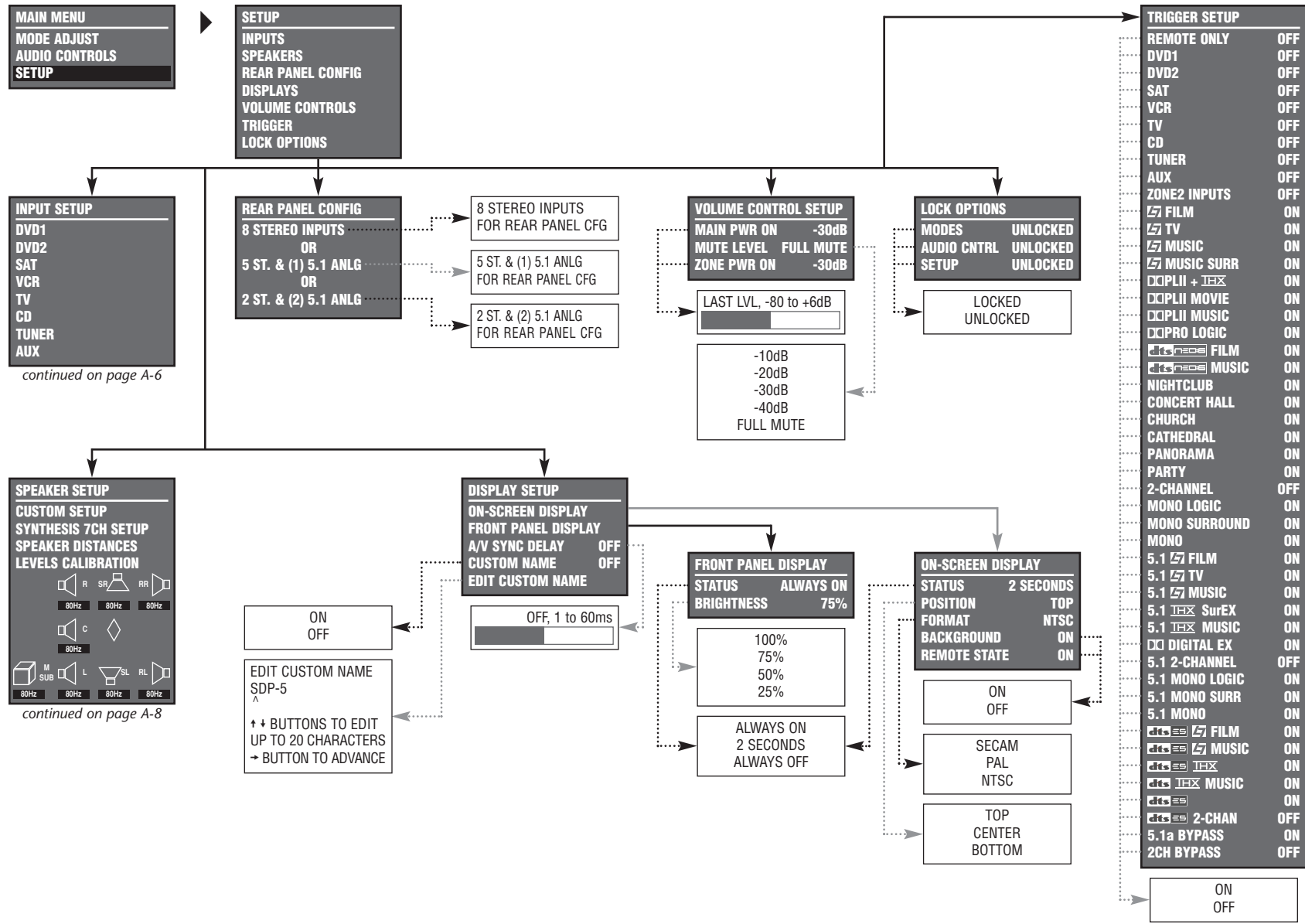

Menu Tree (continued from page A-5)

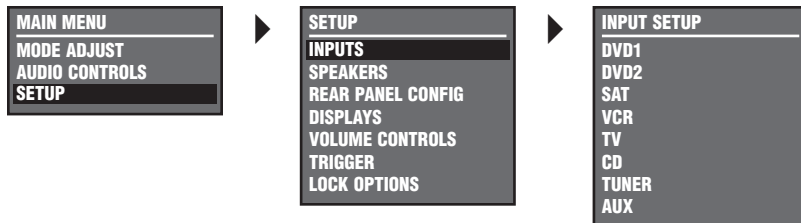

Selecting the SETUP menu INPUTS option prompts the selection of the desired input (e.g. DVD1). Selecting an input opens the corresponding INPUT SETUP menu shown below. The parameters on the left side of the INPUT SETUP menus are identical regardless of which input is selected. The parameter settings on the right side are adjustable. Default parameter settings differ from input to input. The INPUT SETUP menus shown below indicate default parameter settings for each input.

continued from page A-5

DVD1 INPUT SETUP	
NAME	DVD1
DIGITAL IN	COAX-1
ANALOG IN	NONE
ANLG IN LVL	+0dB
VIDEO IN	S-VIDEO-1
COMPONENT IN	1
2-CH	[M] FILM
DOD	5.1 [M] FILM
[DTS ES] [DTS ES]	[M] FILM
MAIN ADVANCED	
ZONE2 IN	DIGITAL

SAT INPUT SETUP	
NAME	SAT
DIGITAL IN	OPTICAL-1
ANALOG IN	ANALOG-1
ANLG IN LVL	+0dB
VIDEO IN	S-VIDEO-3
COMPONENT IN	3
2-CH	[M] TV
DOD	5.1 [M] TV
[DTS ES] [DTS ES]	[M] FILM
MAIN ADVANCED	
ZONE2 IN	ANLG

TV INPUT SETUP	
NAME	TV
DIGITAL IN	OPTICAL-2
ANALOG IN	ANALOG-3
ANLG IN LVL	+0dB
VIDEO IN	S-VIDEO-5
COMPONENT IN	NONE
2-CH	[M] TV
DOD	5.1 [M] TV
[DTS ES] [DTS ES]	[M] FILM-
MAIN ADVANCED	
ZONE2 IN	ANLG

TUNER INPUT SETUP	
NAME	TUNER
DIGITAL IN	NONE
ANALOG IN	ANALOG-4
ANLG IN LVL	+0dB
VIDEO IN	NONE
COMPONENT IN	NONE
2-CH	[M] MUSIC
DOD	5.1 [M] MUSIC
[DTS ES] [DTS ES]	[M] MUSIC
MAIN ADVANCED	
ZONE2 IN	ANLG

DVD2 INPUT SETUP	
NAME	DVD2
DIGITAL IN	COAX-2
ANALOG IN	NONE
ANLG IN LVL	+0dB
VIDEO IN	S-VIDEO-2
COMPONENT IN	2
2-CH	[M] FILM
DOD	5.1 [M] FILM
[DTS ES] [DTS ES]	[M] FILM
MAIN ADVANCED	
ZONE2 IN	DIGITAL

VCR INPUT SETUP	
NAME	VCR
DIGITAL IN	NONE
ANALOG IN	ANALOG-2
ANLG IN LVL	+0dB
VIDEO IN	S-VIDEO-4
COMPONENT IN	NONE
2-CH	[M] FILM
DOD	5.1 [M] FILM
[DTS ES] [DTS ES]	[M] FILM
MAIN ADVANCED	
ZONE2 IN	ANLG

CD INPUT SETUP	
NAME	CD
DIGITAL IN	COAX-3
ANALOG IN	NONE
ANLG IN LVL	+0dB
VIDEO IN	COMPOSITE-1
COMPONENT IN	NONE
2-CH	[M] MUSIC
DOD	5.1 [M] MUSIC
[DTS ES] [DTS ES]	[M] MUSIC
MAIN ADVANCED	
ZONE2 IN	DIGITAL

AUX INPUT SETUP	
NAME	AUX
DIGITAL IN	OPTICAL-3
ANALOG IN	NONE
ANLG IN LVL	+0dB
VIDEO IN	COMPOSITE-2
COMPONENT IN	NONE
2-CH	[M] MUSIC
DOD	5.1 [M] MUSIC
[DTS ES] [DTS ES]	[M] MUSIC
MAIN ADVANCED	
ZONE2 IN	DIGITAL

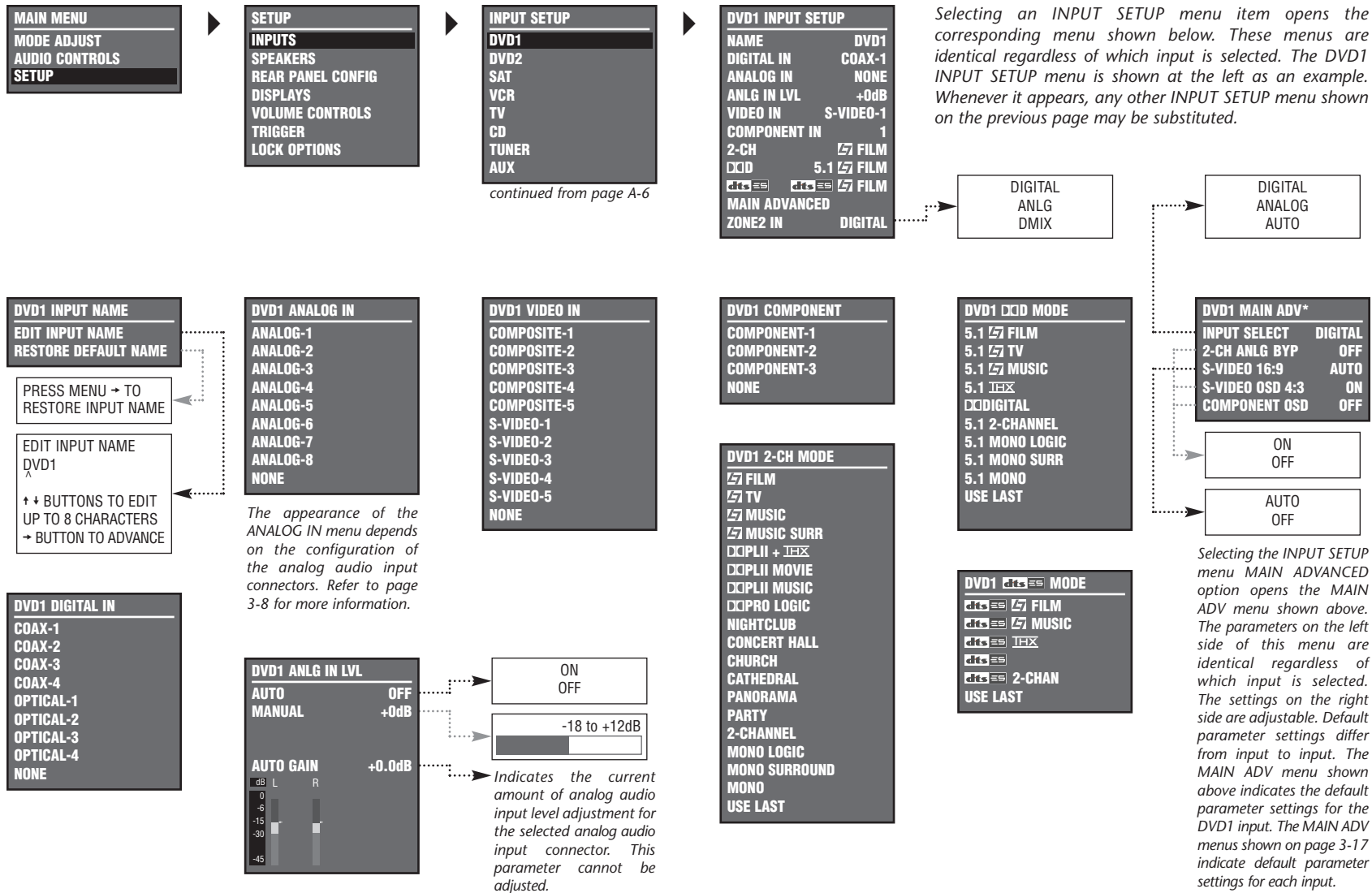

Menu Tree (continued from page A-7)

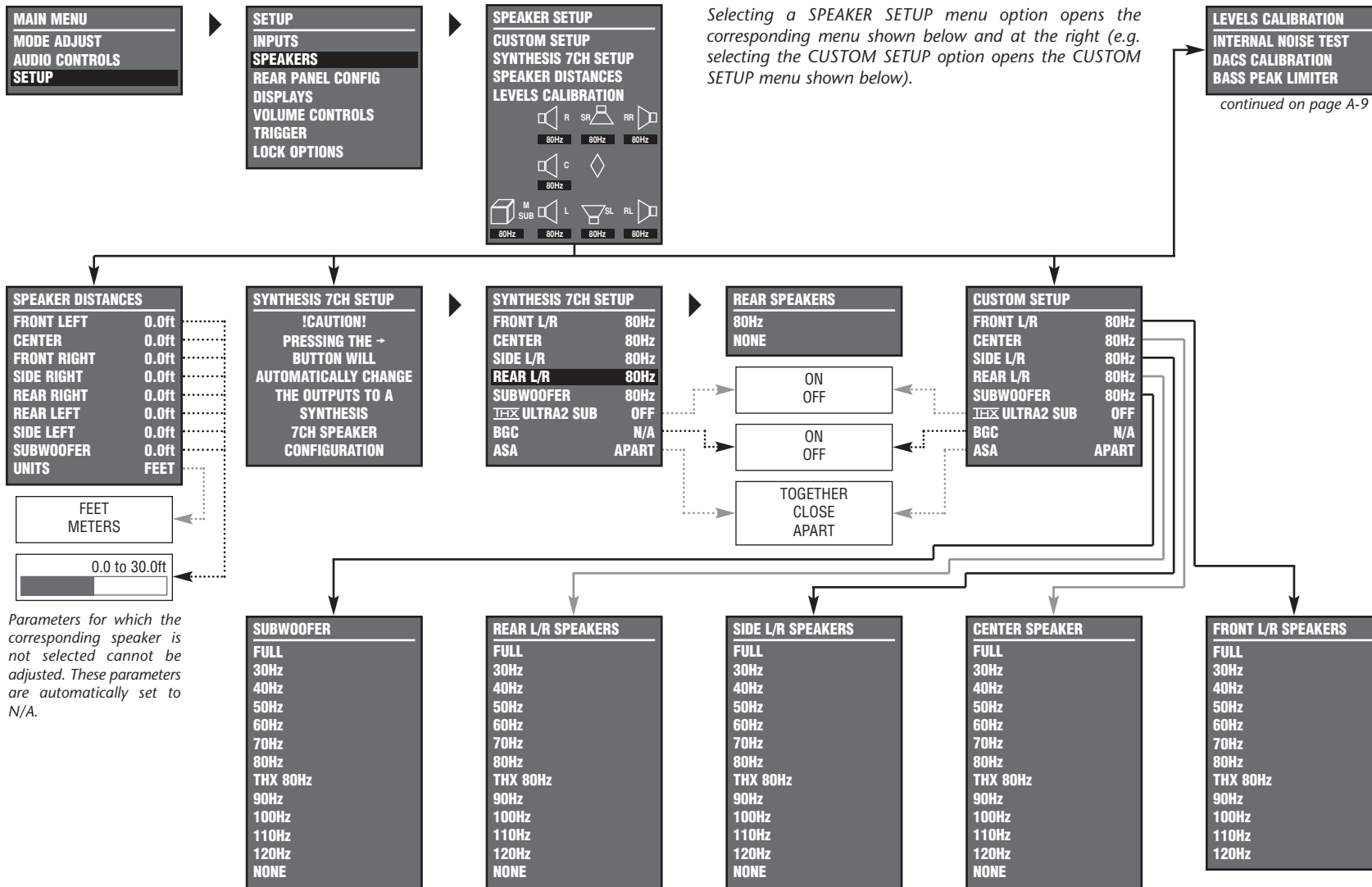

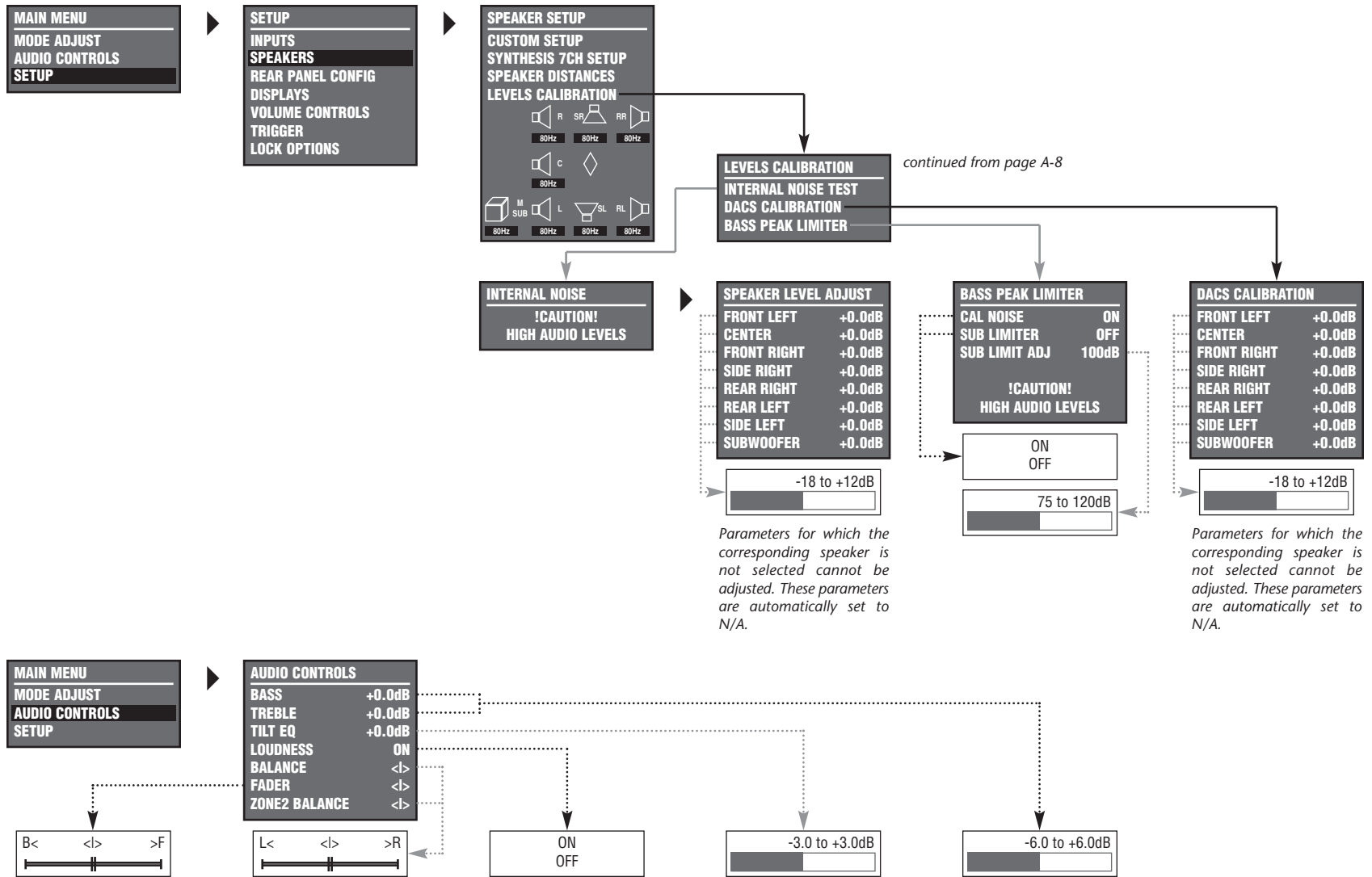

Menu Tree (continued from page A-9)

MAIN MENU	MODE ADJUST
MODE ADJUST	<ul style="list-style-type: none"> 5.1 FILM 5.1 TV 5.1 MUSIC 5.1 MUSIC SURR 5.1 DOLBY + THX 5.1 DOLBY MOVIE 5.1 DOLBY MUSIC 5.1 DOLBY PRO LOGIC 5.1 DTS ES FILM 5.1 DTS ES MUSIC NIGHTCLUB CONCERT HALL CHURCH CATHEDRAL PANORAMA PARTY 2-CHANNEL MONO LOGIC MONO SURROUND MONO 5.1 5.1 FILM 5.1 5.1 TV 5.1 5.1 MUSIC 5.1 5.1 THX * 5.1 5.1 THX MUSIC 5.1 5.1 DIGITAL* 5.1 5.1 2-CHANNEL 5.1 5.1 MONO LOGIC 5.1 5.1 MONO SURR 5.1 5.1 MONO 5.1 5.1 DTS ES FILM* 5.1 5.1 DTS ES MUSIC* 5.1 5.1 DTS ES THX * 5.1 5.1 DTS ES THX MUSIC 5.1 5.1 DTS ES * 5.1 5.1 DTS ES 2-CHAN* 5.1a 5.1a BYPASS 2CH 2CH BYPASS

Selecting a MODE ADJUST menu listening mode opens the corresponding listening mode menu shown below and on the next page. The parameters on the left side of these menus differ from listening mode to listening mode. The settings on the right side are adjustable. The listening mode menus shown below and on the next page indicate default parameter settings for each listening mode. All listening mode menu parameter drop-down menus are shown on pages A-12 and A-13. The OUTPUT LEVELS, CUSTOM, and PANORAMA CALIBRATION menus are shown on page A-12.

5.1 FILM	
AUTO AZIMUTH	ON
VOCAL ENHANCE	+0.0dB
RE-EQUALIZER	ON
SOUND STAGE	REAR
5 SPKR ENHANCE	OFF
BASS ENHANCE	OFF
SURR ROLLOFF	15.3kHz
REAR DLY OFFSET	15ms
OUTPUT LEVELS	CUSTOM

5.1 MUSIC SURR	
VOCAL ENHANCE	+0.0dB
FRONT STEERING	MSURR
SOUND STAGE	NEUTRAL
5 SPKR ENHANCE	OFF
BASS ENHANCE	OFF
SURR ROLLOFF	15.3kHz
REAR DLY OFFSET	15ms
OUTPUT LEVELS	CUSTOM

5.1 DTS ES FILM	
OUTPUT LEVELS	CUSTOM

CHURCH	
CENTER DEPTH	5
SPEECH DETECT	ON
SIZE	20m
MID RT	1.56s
BASS RT	1.87s
PRE-DELAY	24ms
ROLLOFF	2.4kHz
EFFECT LVL	-3dB
OUTPUT LEVELS	CUSTOM

5.1 TV	
AUTO AZIMUTH	ON
VOCAL ENHANCE	+0.0dB
FRONT STEERING	FILM
RE-EQUALIZER	OFF
SOUND STAGE	REAR
5 SPKR ENHANCE	OFF
BASS ENHANCE	OFF
SURR ROLLOFF	15.3kHz
REAR DLY OFFSET	15ms
OUTPUT LEVELS	CUSTOM

5.1 DOLBY + THX	
RE-EQUALIZER	ON
OUTPUT LEVELS	CUSTOM

5.1 DTS ES MUSIC	
OUTPUT LEVELS	CUSTOM

NIGHTCLUB	
CENTER DEPTH	11
SPEECH DETECT	ON
SIZE	5m
LIVENESS	196ms
PRE-DELAY	5ms
ROLLOFF	9.0kHz
EFFECT LVL	+3dB
OUTPUT LEVELS	CUSTOM

CATHEDRAL	
CENTER DEPTH	12
SPEECH DETECT	ON
SIZE	30m
MID RT	3.72s
BASS RT	4.47s
PRE-DELAY	23ms
ROLLOFF	3.1kHz
EFFECT LVL	-8dB
OUTPUT LEVELS	CUSTOM

5.1 MUSIC	
VOCAL ENHANCE	+0.0dB
FRONT STEERING	MUSIC
SOUND STAGE	NEUTRAL
5 SPKR ENHANCE	OFF
BASS ENHANCE	OFF
SURR ROLLOFF	15.3kHz
REAR DLY OFFSET	15ms
OUTPUT LEVELS	CUSTOM

5.1 DOLBY MOVIE	
OUTPUT LEVELS	CUSTOM

CONCERT HALL	
CENTER DEPTH	12
SPEECH DETECT	ON
SIZE	20m
LIVENESS	1.72s
PRE-DELAY	OFF
ROLLOFF	2.4kHz
EFFECT LVL	-2dB
OUTPUT LEVELS	CUSTOM

PANORAMA	
EFFECT LVL	+4dB
BASS CONTENT	STEREO
LOW FREQ WIDTH	+0
SURR ROLLOFF	3.1kHz
REAR DLY OFFSET	15ms
INPUT BALANCE	< >
CALIBRATION	
OUTPUT LEVELS	CUSTOM

5.1 DOLBY MUSIC	
PANORAMA	OFF
CTR WIDTH	3
DIMENSION	NEUTRAL
SURROUND DLY	10ms
OUTPUT LEVELS	CUSTOM

5.1 DOLBY PRO LOGIC	
OUTPUT LEVELS	CUSTOM

* These listening mode names differ depending on the input source, the speaker configuration, and certain parameter settings. Refer to the Listening Mode Descriptions section that begins on page 5-3 for more information.

PARTY
 OUTPUT LEVELS
 CUSTOM

2-CHANNEL
 SUB LEVEL +0dB
 CUSTOM

MONO LOGIC
 EFFECT LVL -9dB
 ACADEMY FILTER ON
 SURR ROLLOFF 3.1kHz
 OUTPUT LEVELS
 CUSTOM

MONO SURROUND
 OUTPUT LEVELS
 CUSTOM

MONO
 SUB LEVEL +0dB
 CUSTOM

5.1 FILM
 VOCAL ENHANCE +0.0dB
 5 SPKR ENHANCE OFF
 BASS ENHANCE OFF
 RE-EQUALIZER ON
 REAR DLY OFFSET 15ms
 COMPRESSION OFF
 LFE MIX +0.0dB
 OUTPUT LEVELS
 CUSTOM

5.1 TV
 VOCAL ENHANCE +0.0dB
 5 SPKR ENHANCE OFF
 BASS ENHANCE OFF
 RE-EQUALIZER OFF
 REAR DLY OFFSET 15ms
 COMPRESSION OFF
 LFE MIX +0.0dB
 OUTPUT LEVELS
 CUSTOM

5.1 MUSIC
 VOCAL ENHANCE +0.0dB
 5 SPKR ENHANCE OFF
 BASS ENHANCE OFF
 RE-EQUALIZER OFF
 REAR DLY OFFSET 15ms
 COMPRESSION OFF
 LFE MIX +0.0dB
 OUTPUT LEVELS
 CUSTOM

5.1 THX
 RE-EQUALIZER ON
 SURROUND EX AUTO
 COMPRESSION OFF
 LFE MIX +0.0dB
 OUTPUT LEVELS
 CUSTOM

5.1 THX MUSIC
 COMPRESSION OFF
 LFE MIX +0.0dB
 OUTPUT LEVELS
 CUSTOM

DIGITAL
 EX DECODING AUTO
 COMPRESSION OFF
 LFE MIX +0.0dB
 OUTPUT LEVELS
 CUSTOM

5.1 2-CHANNEL
 CENTER MIX +0dB
 SURROUND MIX +0dB
 CNTR DLY SAMPLES +0
 MASTER LEVEL +0dB
 COMPRESSION OFF
 LFE MIX +0.0dB
 SUB LEVEL +0dB
 CUSTOM

5.1 MONO LOGIC
 EFFECT LVL -9dB
 ACADEMY FILTER ON
 SURR ROLLOFF 3.1kHz
 OUTPUT LEVELS
 CUSTOM

5.1 MONO SURR
 OUTPUT LEVELS
 CUSTOM

5.1 MONO
 SUB LEVEL +0dB
 CUSTOM

5.1 FILM
 VOCAL ENHANCE +0.0dB
 5 SPKR ENHANCE OFF
 BASS ENHANCE OFF
 RE-EQUALIZER ON
 REAR DLY OFFSET 15ms
 LFE MIX +0.0dB
 DECODING OFF
 OUTPUT LEVELS
 CUSTOM

5.1 MUSIC
 VOCAL ENHANCE +0.0dB
 5 SPKR ENHANCE OFF
 BASS ENHANCE OFF
 REAR DLY OFFSET 15ms
 LFE MIX +0.0dB
 DECODING OFF
 OUTPUT LEVELS
 CUSTOM

THX
 RE-EQUALIZER ON
 LFE MIX +0.0dB
 DECODING AUTO
 OUTPUT LEVELS
 CUSTOM

THX MUSIC
 LFE MIX +0.0dB
 OUTPUT LEVELS
 CUSTOM

ES
 LFE MIX +0.0dB
 DECODING AUTO
 OUTPUT LEVELS
 CUSTOM

2-CHAN
 CENTER MIX +0dB
 SURROUND MIX +0dB
 CNTR DLY SAMPLES +0
 MASTER LEVEL +0dB
 LFE MIX +0.0dB
 DECODING AUTO
 SUB LEVEL +0dB
 CUSTOM

5.1a BYPASS
 OUTPUT LEVELS
 CUSTOM

2CH BYPASS
 NO PARAMETERS

Menu Tree (continued from page A-11)

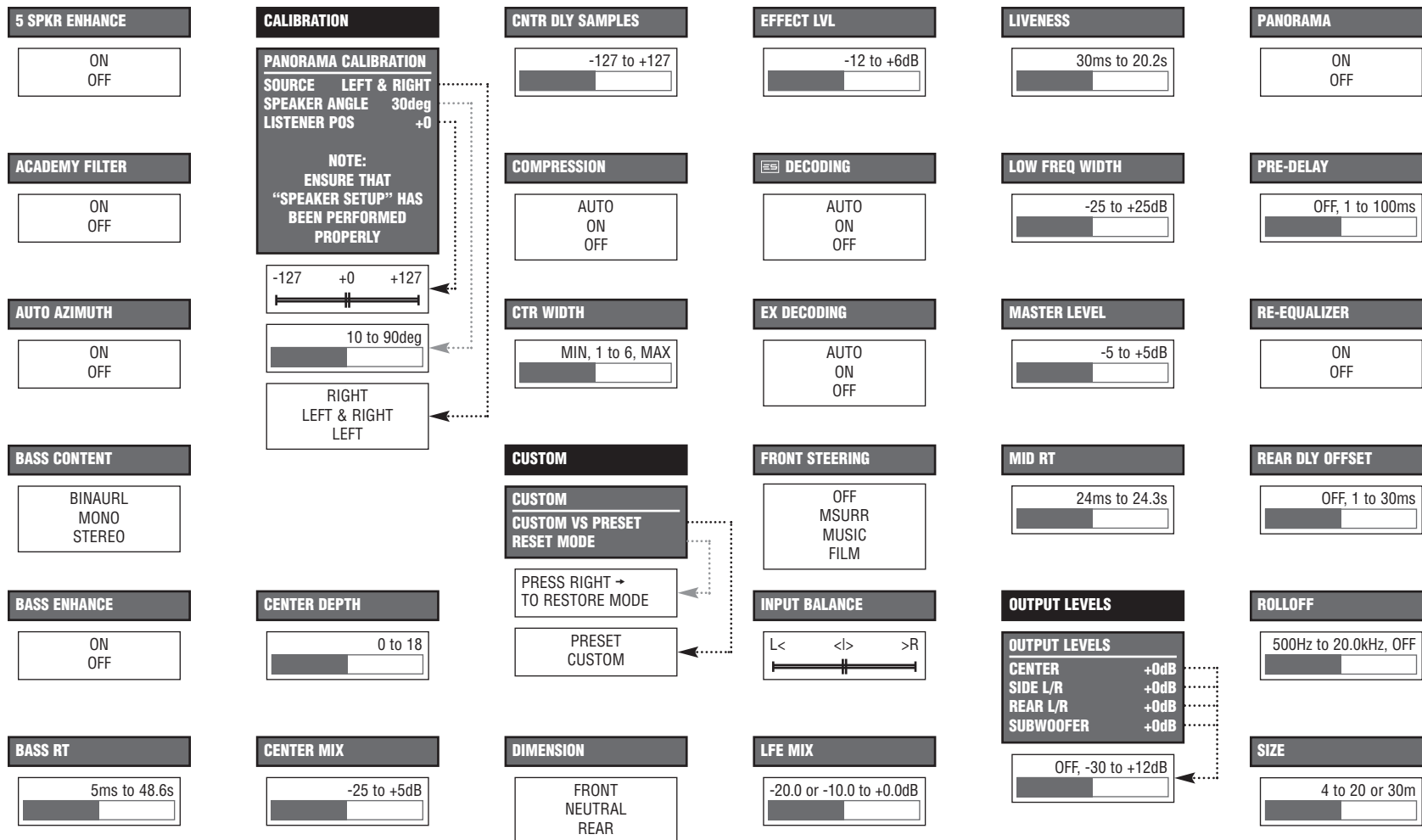

When the Shift command bank is active, pressing the remote control Stat button opens the STATUS menu for the current input source. This menu contains parameters that provide information about the current input source and listening mode. STATUS menus are available for 2-channel, Dolby Digital, dts(-ES), digital, and analog input sources. Refer to page 2-18 for more information.

STATUS menu parameters provide information about the current input source and listening mode. These parameters cannot be adjusted. Refer to the STATUS Menu Parameter Descriptions section that begins on page 2-23 for more information.

SOUND STAGE

FRONT
NEUTRAL
REAR

SURROUND DLY

0 to 15ms

SPEECH DETECT

ON
OFF

SURROUND EX

AUTO
ON
OFF

SUB LEVEL

OFF, -30 to +12dB

SURROUND MIX

-5 to +5dB

SURR ROLLOFF

500Hz to 20.0kHz, OFF

VOCAL ENHANCE

+6.0dB
+3.0dB
+0.0dB

2CH STATUS

INPUT
MODE
INPUT TYPE
SAMPLE RATE

DOD STATUS PG1

INPUT
MODE
CHANNELS
BIT RATE
EX ENCODING

DOD STATUS PG2

SAMPLE RATE
2.0 ENCODING
DIALOG OFFSET
MIX ROOM
CENTER MIX LVL
SURR MIX LVL

dts STATUS PG1

INPUT
MODE
CHANNELS
BIT RATE
ENCODING

dts STATUS PG2

WORD LENGTH
SAMPLE RATE

5.1a BYPASS STATUS

INPUT
MODE
INPUT TYPE

Activating the SDP-5 while pressing and holding the front panel or remote control Mute button opens the FACTORY SETTINGS menu shown below. Refer to page 6-4 for more information.

FACTORY SETTINGS
EXIT
RESTORE DEFAULTS



FACTORY SETTINGS
HAVE BEEN RESTORED
PRESS ANY KEY
TO RESTART

2CH BYPASS STATUS

INPUT
MODE
INPUT TYPE

DIGITAL STATUS

INPUT
MODE
INPUT TYPE
SAMPLE RATE

INSTALLATION WORKSHEET

INPUT SETUP	DVD1	DVD2	SAT	VCR	TV	CD	TUNER	AUX
NAME								
DIGITAL IN								
ANALOG IN								
ANLG IN LVL								
VIDEO IN								
COMPONENT IN								
2-CH								
DD D								
dts-ES								
<i>MAIN ADV</i>								
INPUT SELECT								
2-CH ANLG BYP								
S-VIDEO 16:9								
S-VIDEO 4:3 OSD								
COMPONENT OSD								
ZONE2 IN								

SPEAKER SETUP	CUSTOM SETUP	SYNTHESIS 7CH SETUP	SPEAKER DISTANCES	LEVELS CALIBRATION
FRONT LEFT/RIGHT		SYNTHESIS 7CH 80Hz		
CENTER		SYNTHESIS 7CH 80Hz		
SIDE LEFT/RIGHT		SYNTHESIS 7CH 80Hz		
REAR LEFT/RIGHT				
SUBWOOFER		SYNTHESIS 7CH 80Hz		
THX ULTRA2 SUB				
BGC				
ASA				
UNITS				
CAL NOISE				
SUB LIMITER				
SUB LIMIT ADJ				

REAR PANEL CONFIG	SETTINGS		
<i>Circle One</i>	8 STEREO INPUTS	5 ST. & (1) 5.1 ANLG	2 ST. & (2) 5.1 ANLG

... Installation Worksheet continues on page A-16

Installation Worksheet (continued from page A-15)

DISPLAY SETUP	SETTING
ON-SCREEN DISPLAY	
STATUS	
POSITION	
FORMAT	
BACKGROUND	
REMOTE STATE	
FRONT PANEL DISPLAY	
STATUS	
BRIGHTNESS	
A/V SYNC DELAY	
CUSTOM NAME	
EDIT CUSTOM NAME	

VOLUME CONTROL SETUP	SETTING
MAIN PWR ON	
MUTE LEVEL	
ZONE PWR ON	

TRIGGER SETUP	SETTING
REMOTE ONLY	
<i>If the REMOTE ONLY parameter is set to OFF, circle the inputs and listening modes selected for program operation.</i>	
DVD1	PANORAMA
DVD2	PARTY
SAT	2-CHANNEL
VCR	MONO LOGIC
TV	MONO SURROUND
CD	MONO
TUNER	5.1 L7 FILM
AUX	5.1 L7 TV
ZONE2 INPUTS	5.1 L7 MUSIC
L7 FILM	5.1 THX SurEX
L7 TV	DOLBY DIGITAL EX
L7 MUSIC	5.1 2-CHANNEL
L7 MUSIC SURR	5.1 MONO LOGIC
DOLBY PLII + THX	5.1 MONO SURR
DOLBY PLII MOVIE	5.1 MONO
DOLBY PLII MUSIC	dts(-ES) L7 FILM
DOLBY PRO LOGIC	dts(-ES) L7 MUSIC
dts NEO:6 FILM	dts (-ES) THX
dts NEO:6 MUSIC	dts THX MUSIC
NIGHTCLUB	dts(-ES)
CONCERT HALL	dts(-ES) 2-CHAN
CHURCH	5.1a BYPASS
CATHEDRAL	2CH BYPASS

LOCK OPTIONS	SETTING
SETUP	
AUDIO CNTRL	
MODES	

AUDIO CONTROLS	SETTING
BASS	
TREBLE	
TILT EQ	
LOUDNESS	
BALANCE	
FADER	
ZONE2 BALANCE	

Free Manuals Download Website

<http://myh66.com>

<http://usermanuals.us>

<http://www.somanuals.com>

<http://www.4manuals.cc>

<http://www.manual-lib.com>

<http://www.404manual.com>

<http://www.luxmanual.com>

<http://aubethermostatmanual.com>

Golf course search by state

<http://golfingnear.com>

Email search by domain

<http://emailbydomain.com>

Auto manuals search

<http://auto.somanuals.com>

TV manuals search

<http://tv.somanuals.com>