

OWNER'S MANUAL 2007

990 ADVENTURE
990 ADVENTURE S

ART. NR. 3.211.149 EN



We would like to congratulate you on your purchase of a KTM motorcycle. You are now the owner of a state-of-the-art sport motorcycle that guarantees to bring you lots of fun and enjoyment, provided that you clean and maintain it appropriately. Please insert the serial numbers of your motorcycle in the boxes below:

Frame number

Engine number

Key number

Stamp of dealer

All information contained is without obligation. KTM-Sportmotorcycle AG particularly reserves the right to modify any equipment, technical specifications, prices, colors, shapes, materials, services, service work, constructions, equipment and the like so as to adapt them to local conditions or to cancel any of the above items, all without previous announcement and without giving reasons. KTM may stop manufacturing certain models without previous notice. KTM shall not be held liable for any deviations of availability and/or ability to deliver, illustrations, descriptions, printing and/or other errors. The illustrated models partly contain extra equipment, which is not applied to standard models.

© 2006 by KTM-SPORTMOTORCYCLE AG, Mattighofen AUSTRIA; All rights reserved; Reprint, also in extracts, with written allowance of KTM-SPORTMOTORCYCLE AG, Mattighofen only.

CONSUMER INFORMATION FOR AUSTRALIA ONLY Tampering with noise control system prohibited Owners are warned that the law may prohibit:

- (a) The removal or rendering inoperative by any person other than for purposes of maintenance, repair or replacement, of any device or element of design incorporated into any new vehicle for the purpose of noise control prior to its sale or delivery to the ultimate purchaser or while it is in use; and
- (b) the use of the vehicle after such device or element of design has been removed or rendered inoperative by any person.



In accordance with the international quality management ISO 9001 standard, KTM uses quality assurance processes that lead to the highest possible product quality.

INTENDED PURPOSE

The KTM 990 Adventure is designed to resist the usual wear and tear of normal use on roads and easy terrain (unpaved roads).

OWNER'S MANUAL

Carefully read the entire Owner's Manual before you start riding your motorcycle, even if this will take a little time. It contains useful tips and information on the best way to handle the motorcycle and how to protect yourself from injuries. The Manual also contains important information on service and maintenance. In your own interest, pay particular attention to the information marked as follows:



WARNING

- Ignoring these instructions, can endanger your body and your life.



CAUTION

- Ignoring these instructions could cause damage to parts of your motorcycle or that the motor-cycle is not road-safe anymore.

The Owner's Manual corresponded to the latest information available for this model series at the time it was printed. Minor deviations resulting from enhancements to the motorcycle design cannot be entirely precluded. The Owner's Manual is an integral part of the motorcycle and must be handed over to the new owner when the motorcycle is sold.

SERVICE

Observance of the service, maintenance and operating instructions for the engine and chassis specified in the Owner's Manual is a prerequisite for faultless operation and the avoidance of premature wear. Please observe the prescribed breaking-in periods, inspection intervals and service intervals. Strict observance will significantly prolong the service life of your motorcycle.

Use of the motorcycle under extreme conditions, e.g. on extremely muddy and wet terrain, can lead to higher than average wear on components such as the drive train or the brakes. In this case it may become necessary to service or replace wear parts before the service limit specified in the maintenance schedule has been reached.

WARRANTY

The service work specified in the „Lubrication and Maintenance Schedule“ must be performed by an authorized KTM workshop. This is the only place that has the qualified technicians and the special tools required for the 990 Adventure. Be sure to have the workshop verify all service work carried out in the service manual to avoid losing your right to claim under the warranty. The warranty or guarantee shall become void for damage and consequential damage caused by manipulations or conversions to the motorcycle.

AUTOMOTIVE FLUIDS

The fuels, lubricants and liquids specified in the Owner's Manual or automotive fluids with equivalent specifications must be used in accordance with the maintenance schedule.

SPARE PARTS, ACCESSORIES

For your own safety, only use spare parts and accessories approved by KTM. KTM shall not assume any liability for other products or consequential damage resulting from the use of such products.

ENVIRONMENT

Motorcycle driving is a wonderful sport and we hope that you will be able to enjoy it to the full. It may, however, involve potential problems for the environment or lead to conflicts with others. These problems or conflicts can be avoided if the motorcycle is used responsibly. To safeguard the future of motorcycle sports, make sure that you use the motorcycle in accordance with the law, show that you are environmentally conscious and respect the rights of others.

Enjoy driving your motorcycle !

KTM SPORTMOTORCYCLE AG
5230 MATTIGHOFEN, AUSTRIA

INTRODUCTION	1	Spring preload of the fork	20
IMPORTANT INFORMATION	2	Damping action during compression of shock absorber . . .	21
SERIAL NUMBER LOCATIONS	6	Rebound damping of shock absorber	22
Chassis number	6	Shock absorber's preload adjuster	22
Engine number, engine type	6	Baggage carrier plate	22
OPERATION INSTRUMENTS	7	Grips	23
Clutch lever	7	Footrests	23
Hand brake lever	7	Alarm system	23
Multi-functional digital speedometer	8	GENERAL TIPS AND WARNINGS FOR STARTING	
Display	8	THE MOTORCYCLE	24
Setting options in the display	10	Instructions for initial operation	24
Cooling liquid temperature display	12	Running in the LC8 engine	24
Indicator lamps	13	Accessories and payload	25
ABS warning lamp – models with ABS		DRIVING INSTRUCTIONS	26
(antilock brake system)	14	Check the following before each start	26
ABS button – models with ABS (antilock brake system) . .	14	Starting the engine	28
Tachometer	15	Starting off	29
Ignition lock	15	Shifting/Riding	29
Combination switch	16	Braking – models without ABS (antilock brake system) . . .	30
Emergency OFF tip switch, starter tip switch	16	Braking – models with ABS (antilock brake system)	30
Storage compartment	17	Switching off the ABS	31
Filler caps	17	Stopping and parking	32
Seat lock	17	Fuel	34
Fuel taps	18	PERIODIC MAINTENANCE SCHEDULE	36
Shift lever	18	MAINTENANCE WORK ON CHASSIS AND ENGINE	40
Side stand	19	Removing and remounting the seat	41
Center stand	19	Tool set	41
Foot brake pedal	19	Adjusting the fork and shock absorber	42
Compression damping of fork	20	Adjusting compression damping of fork	42
Rebound damping of fork	20	Adjusting rebound damping of fork	42

Adjusting the spring preload on the fork	43	Replacing the flasher bulbs	69
Compression damping of shock absorber	44	Cooling system	70
Rebound damping of shock absorber	45	Checking the cooling liquid level in the compensating tank .71	
Adjusting the preload of the shock absorber	46	Checking the cooling liquid level in the radiator	72
Breathing the fork legs	46	Bleeding the cooling system	73
Cleaning the dust sleeves of the telescopic fork	47	Changing the original position of the clutch lever	74
Checking the chain tension	47	Checking the oil level of the hydraulic clutch	74
Correct chain tension	48	Engine oil	75
Chain maintenance	49	Checking the engine oil level	75
Checking the chain for wear	49	Changing the engine oil and the oil filter, cleaning the oil screen	76
General informations about KTM disc brakes	50	Activating the ignition curve for low-octane fuel	82
Adjusting of free travel at the hand brake lever	53	TROUBLE SHOOTING	83
Checking of brake fluid level - front brake	53	CLEANING	88
Checking the front brake pads	53	CONSERVATION FOR WINTER OPERATION	88
Checking rear brake fluid level	54	STORAGE	89
Checking the rear brake pads	54	TECHNICAL SPECIFICATIONS – CHASSIS	90
Dismounting and mounting the front wheel	56	TECHNICAL SPECIFICATIONS – ENGINE	94
Dismounting and mounting the rear wheel	58	Engine oil	95
Tires, air pressure	59	HEAD WORD INDEX	96
Checking spoke tension	60	CONSUMER INFORMATION FOR USA ONLY	98
Battery	61		
Demounting and mounting the battery	62		
Charging the battery	63		
Jump start	63		
Main fuse	64		
ABS fuses – models with ABS (antilock brake system)	64		
Fuses for individual current consumers	65		
Replacing the headlight lamps	66		
Adjusting the headlight range	68		
Replacing the brake and tail light bulbs	68		

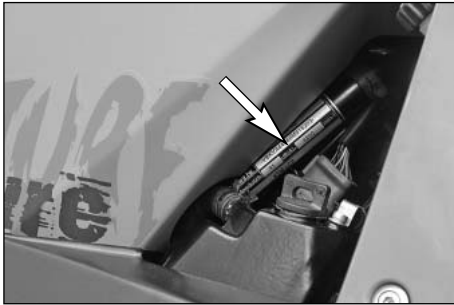

Chassis number

The chassis number is located on the right side of the steering head tube and on the type label. Write this number into the relevant area on page 1.



Engine number, engine type

The engine number and engine type are embossed in the engine case near the shift lever. Write this number into the relevant area on page 1.

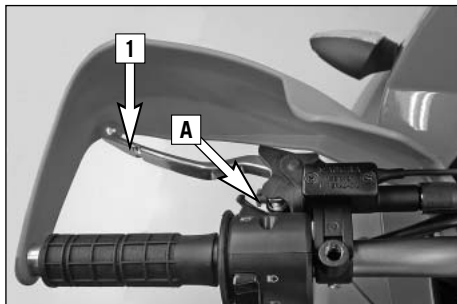

Clutch lever

The clutch lever **[1]** is located on the left side of the handlebar. The adjusting screw **[A]** is used to change the original position of the clutch lever (see maintenance work on chassis and engine).

The clutch is hydraulically actuated and adjusts itself automatically.

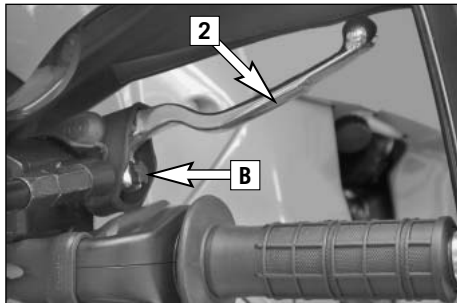

Hand brake lever

The hand brake lever **[2]** is mounted on the handlebars on the right and actuates the front wheel brake. The adjusting screw **[B]** can be used to change the basic position of the hand brake lever (see Maintenance).

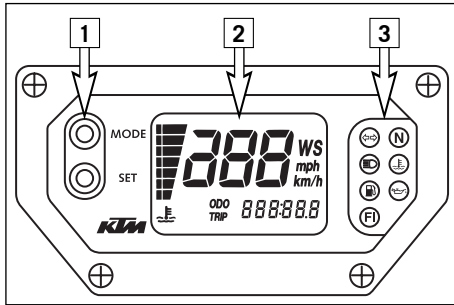

Multi-functional digital speedometer

The universal instrument is divided into 3 parts.

Use the MODE and SET [1] button to change the display and the basic settings in the display.

Display [2] shows all of the information that may be of interest to you. 5 display modes can be selected with the MODE button.

The indicator lamps [3] provide additional information on the motorcycle's running condition.

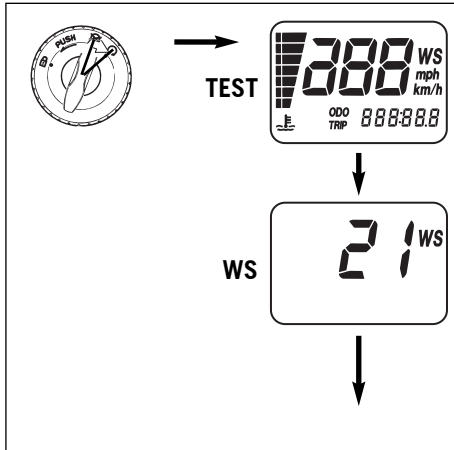

Display

TEST

When you switch on the ignition, all of the display elements will light up for 1 second for the function test.

WS (wheel size)

The display will change and show the diameter of the front wheel in inches for 1 second (WS = wheel size).

Then the CLOCK mode will be displayed, or the mode that was active when the ignition was switched off.

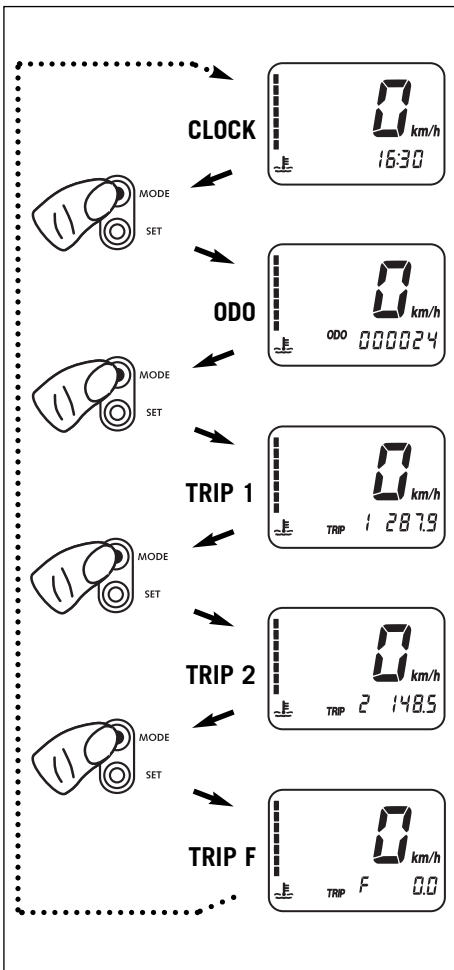

CLOCK

You will recognize the CLOCK display by the blinking dots between the hours and minutes. It displays the speed, temperature of the cooling liquid and the clock.

To switch to the next display mode, press the MODE button.

ODO

The speed, temperature of the cooling liquid and the total kilometers or miles traveled are shown in the ODO mode.

To switch to the next display mode, press the MODE button.

TRIP 1

The TRIP 1 mode shows the speed, the temperature of the cooling liquid and the trip odometer 1.

To switch to the next display mode, press the MODE button.

TRIP 2

The TRIP 2 mode shows the speed, the temperature of the cooling liquid and the trip odometer 2.

To switch to the next display mode, press the MODE button.

TRIP F

The TRIP F (fuel) mode shows the speed, the temperature of the cooling liquid and the distance traveled since reaching the low-fuel mark (the low-fuel indicator lamp lights up).

To return to the CLOCK mode, press the MODE button.

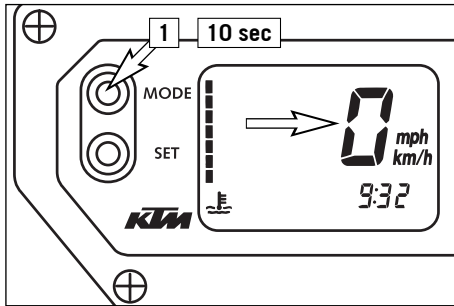

Setting options in the display

KILOMETERS OR MILES.

You can have the speed and distance shown in kilometers or miles in the display. The display can be adapted to the respective country on long-distance trips.

To switch from kilometers to miles, switch on the ignition and press the MODE [1] button for approx. 10 seconds. The **km/h** display will switch to **mph**. The speed and the stored distances will be converted and displayed in miles.

To return to kilometers, proceed as described above.

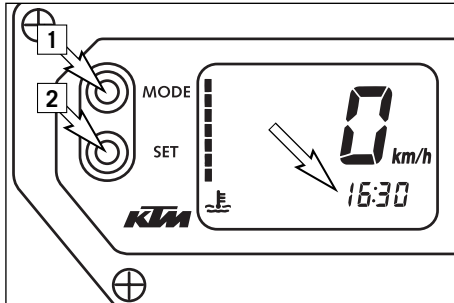

CLOCK

Switch on the ignition and change to the CLOCK mode.

Simultaneously press MODE [1] and SET [2]. The numbers on the clock will start to blink.

Use the MODE button to set the hours and the SET button to set the minutes.

The press the MODE and SET buttons simultaneously.

NOTE:

0:00 will be displayed if the clock is not supplied with electricity. This can be caused by a defective fuse or a fault in the board electric system (see Troubleshooting).

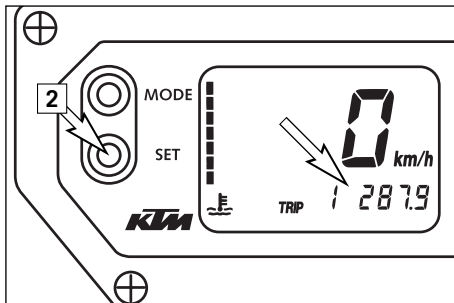

TRIP 1

The trip meter 1 runs continuously and counts up to 999.9. It can be used to measure the length of a certain route on a trip or the distance between two refueling stops.

To return the trip meter 1 to zero, switch on the ignition, change to the TRIP 1 mode and press the SET button.

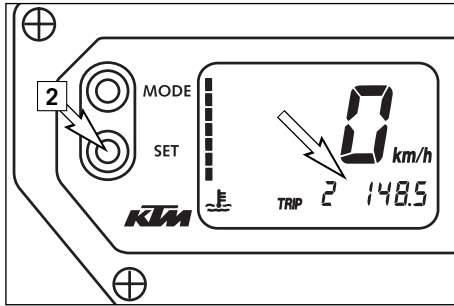

RESETTING TRIP 2

The trip meter 2 runs continuously and counts up to 999.9. It can be used similarly to TRIP 1 or together with a switch available as an accessory (see below) for trips according to a roadbook.

To return the trip meter 2 to zero, switch on the ignition, change to the TRIP 2 mode and press the SET button.

NOTE:

A Tripmaster switch (Part no. 582.14.069.044) is available as an accessory and enhances the trip meter 2 functions. You can correct the displayed route by increasing or decreasing in increments of 0.1. For example, if you have taken the wrong road when driving according to a roadbook, you can easily correct the display to correspond to the roadbook again. It can also be used to change the display modes. The switch is mounted on the handlebars so that you can keep your hands on the handlebars.

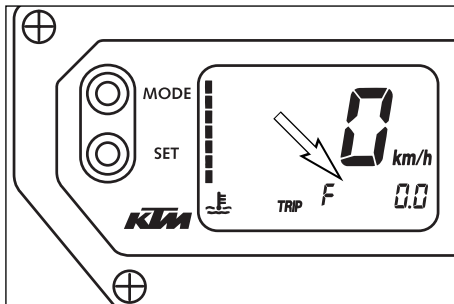

TRIP F

When the fuel level reaches the reserve mark, the display will automatically switch to TRIP F and begin to count (no matter which display mode was active before). At the same time, the fuel warning lamp will light up. You will still have enough reserve fuel for at least 30 kilometers.

After refueling, it will take approx. 8 minutes for the fuel warning lamp to switch off and for TRIP F to automatically reset to 0 and return to the previous display mode.

NOTE:

Press the SET key for 2 seconds to immediately turn off the fuel warning lamp.

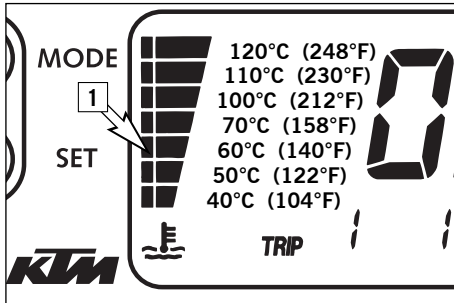

Cooling liquid temperature display

The temperature display [1] is shown in 7 bars. The more bars that light up, the hotter the cooling liquid. When the lowest bar lights up, the cooling liquid has reached a temperature of approx. 40°C (104°F). When the upper bar lights up 120°C (248°F), all of the bars will start to blink and the red warning lamp [2] will light up.

! CAUTION

Possible causes for an increase in temperature, causing the red warning light for the cooling liquid temperature to light up:

- Driving too slowly and driving with a heavy load at high air temperatures
- Not enough cooling liquid in the system
- The ventilator on the radiator is not running
- Improper use of the clutch when driving slowly

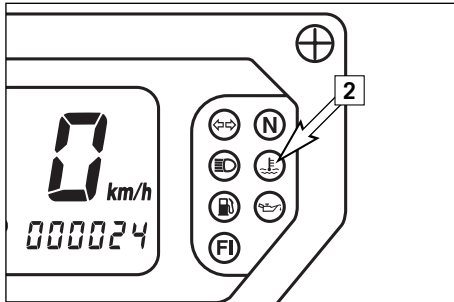





Indicator lamps

- 

The green indicator lamp will blink in the blinker rhythm when the blinker is switched on.
NOTE: The indicator lamp will blink faster when a blinker is broken.
- 

The green indicator lamp will light up when the gearbox is in an idling position.
- 

The blue indicator lamp will light up when the high beams are switched on.
- 

The red warning light will light up when the cooling liquid has reached a temperature of approx. 120°C (248°F).
- 

The orange warning light will light up when the fuel level has reached the reserve mark. At the same time the display will automatically change to TRIP F (see TRIP F).
- 

The red warning lamp lights up when the ignition is switched on but the engine is not running. When the engine is started, the warning lamp will go out as soon as the oil pressure is high enough.
- 

The orange warning lamp (fuel injection) briefly lights up when the ignition is switched on. It will go out when the gasoline pressure is high enough.
If this warning lamp lights up while driving, a component in the injection system is defective. The error can be identified by means of a blink code (see Trouble shooting).

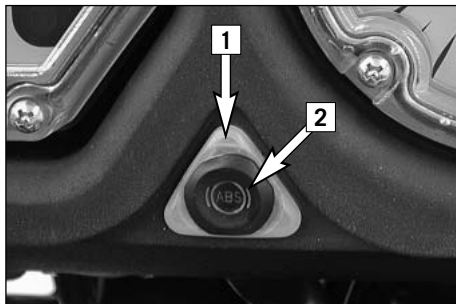

ABS warning lamp – models with ABS (antilock brake system)

The ABS warning lamp [1] must light up when the ignition is switched on and go out at a speed of approx. 5 KPH after you drive off. If it stays on or lights up while driving, the ABS is defective. The ABS is no longer active and the wheels can lock when braking.

NOTE:

The brake system will still function but ABS control will no longer be active. Continue to drive carefully and have the ABS checked at an authorized KTM workshop.

NOTE:

The ABS warning lamp can also light up if there is a large deviation between the speed of the front and rear wheel in extreme driving situations, e.g. during a wheelie or if the rear wheel slips when accelerating on loose ground. The ABS will no longer be active and the wheels can lock when braking. To activate the ABS again, stop and switch off the ignition. If the warning lamp goes off again at a speed of approx. 5 KPH after you drive off, the ABS is active and fully operative.

ABS button – models with ABS (antilock brake system)

The ABS button [2] switches off the ABS. To switch off the ABS, stop the motorcycle and press the ABS button for at least 3 seconds with the engine running. Let go of the ABS button as soon as the ABS warning lamp starts blinking fast. The ABS warning lamp will blink slowly to indicate that the ABS is switched off.

To switch the ABS on again, stop and switch off the ignition. The ABS will be active again when you switch on the ignition.



Tachometer

The tachometer shows the engine speed in revolutions per minute. Do not run the engine beyond the black mark at 9500 rpm.

The speed limiter will set in at 9600 rpm, drastically reducing the engine power above this rotational speed.

When you switch on the ignition, the indicating needle will move to the black mark and back again.

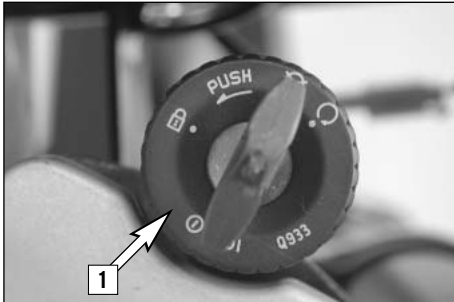

Ignition lock

The ignition lock [1] has 3 switching positions.





Ignition off, (engine can't be started)



Ignition on, (engine can be started)



Ignition off, handlebar blocked

To switch the ignition to position  turn the ignition key to position  and firmly press it into the lock. Turn the handlebar to the left, then turn the ignition key to the left.



The ignition key can be withdrawn in position  and .

Socket for electric accessories

A socket is provided in the cockpit for electric accessories, e.g. GPS, roadbook, cell phone, etc.

The socket has a 12V voltage and is protected by a 10 A fuse. Do not plug power consumers with a higher requirement into this socket.

! CAUTION

Remember that electric accessories will run down the battery.

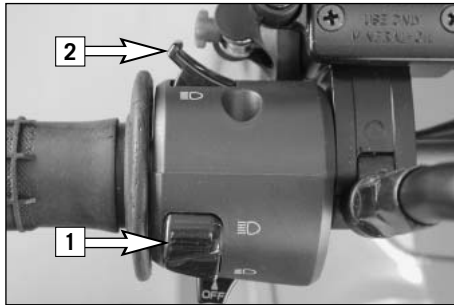

Combination switch

The rocker switch LIGHTS [1] actuates the high beam or low beam.

 = High-beam light

 = Low-beam light

 The light signal (high beam) is actuated with button [2].

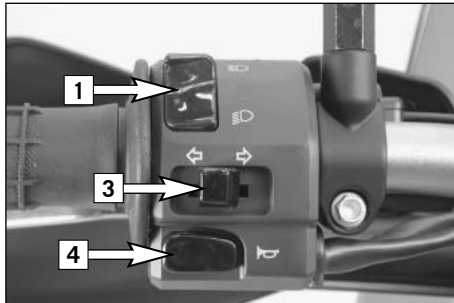

 The indicator switch [3] returns to central position after actuation. Press flasher switch towards switch housing to switch off the flasher.

 The horn is sounded with button [4].

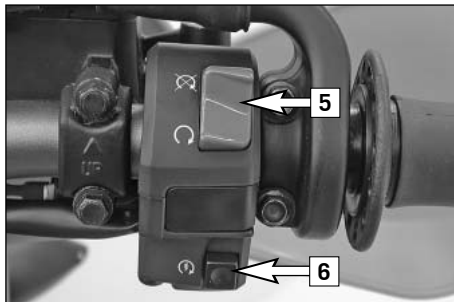

Emergency OFF tip switch, starter tip switch

The emergency off switch [5] is provided for emergency situations and should not be used to switch off the engine.

The engine is ready for operation in position  (ignition circuit and starter circuit are switched on).

The engine cannot be started in position  (ignition circuit and starter circuit are interrupted).

 Use the starter tip switch [6] to operate the electric starter.

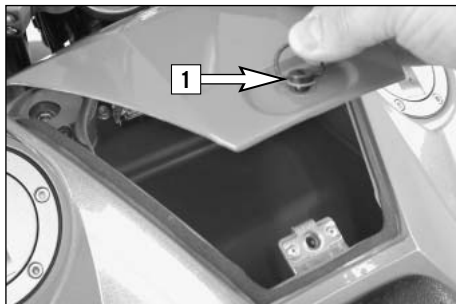

Storage compartment

A storage compartment is located under the seat to hold small, frequently used items. To open, turn the quick release [1] approx. 180° in a counterclockwise direction and lift the cover. To lock, close the cover, insert the quick release in the dolly and turn 180° in a clockwise direction.

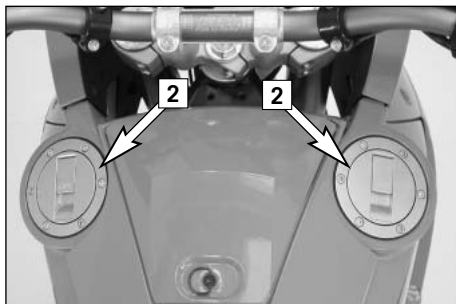

Filler caps

The 990 Adventure has 2 separate fuel tanks. Both filler caps [2] can be locked and are equipped with a tank vent system. To open, insert the ignition key, turn 45° in a clockwise direction and fold up the filler cap. The ignition key can be pulled out to open the other filler cap. Simply press on the filler cap to close.



Seat lock

The seat is unlocked by inserting the ignition key in the lock [3] on the side and turning the key in a counterclockwise direction. See "Maintenance Work" to remove and remount the seat.

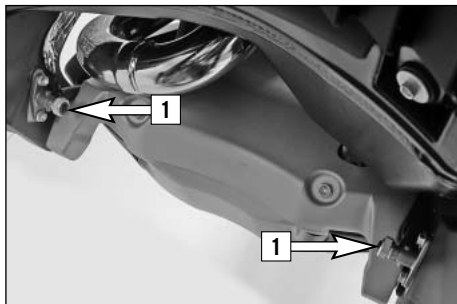

Fuel taps

Both fuel taps [1] must be open when the motorcycle is running. The level in the fuel tanks is equalized by means of a connecting hose. Only close the fuel taps to remove the tanks.

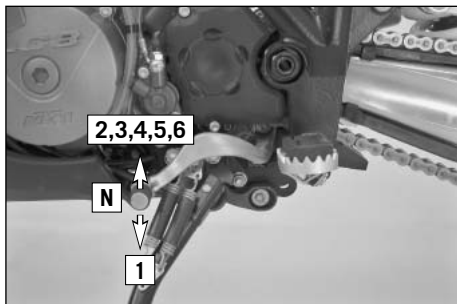

Shift lever

The shift lever is mounted on the left side of the engine. The position of the gears is shown in the illustration. Neutral, or the idle speed, is located between first and second gear.

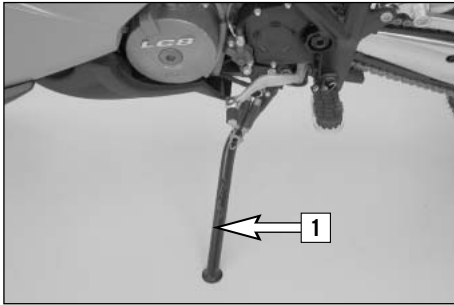

Side stand

Fold the side stand [1] forward to the stop with your foot and put the weight of the motorcycle on the stand. Make sure it is standing securely on a firm surface. The side stand is linked to the safety start system; follow the driving instructions.

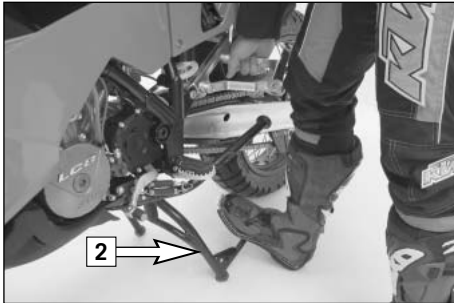

Center stand

The bike is equipped with a side stand and a center stand [2].



Foot brake pedal

The foot brake pedal [3] is located in front of the right footrest. Its basic position can be adjusted to your seat position (see maintenance work).

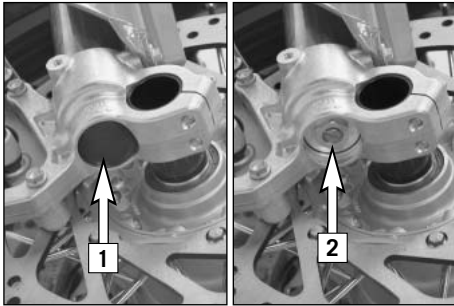

Compression damping of fork

The fork's damping action during compression travel (compression damping) can be adjusted. This allows you adjust the damping behavior to match your driving style and the payload. The adjusting screws [2] are located under the cap [1] on the lower end of the fork legs. More information is provided in the chapter "Adjusting the fork and shock absorber."

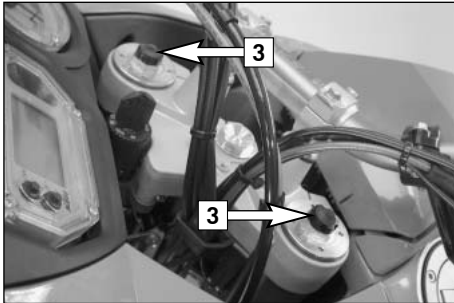

Rebound damping of fork

The fork's damping action during rebound travel (rebound damping) can also be adjusted. This allows you adjust the damping behavior to match your driving style and the payload. The adjusting screws [3] are located on the upper end of the fork legs. More information is provided in the chapter "Adjusting the fork and shock absorber."

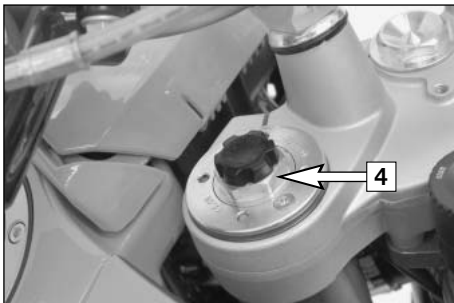

Spring preload of the fork

The fork's preload can be adjusted by means of the adjusting screws [4]. More information is provided in the chapter "Adjusting the fork and shock absorber."



Damping action during compression of shock absorber

The shock absorber's damping action during compression travel (compression damping) can be adjusted. This allows you adjust the shock absorber's damping behavior to match your driving style and the payload.

The damping rate can be adjusted in the low and high-speed range (Dual Compression Control). The designation low and high-speed refers to the movement of the shock absorber and not to the motorcycle's driving speed.

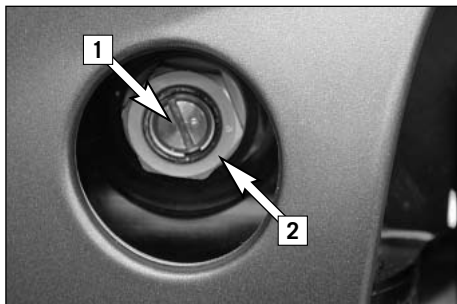

The adjusting screw [1] for the low-speed range can be adjusted with a screwdriver.

The adjusting screw [2] for the high-speed range can be adjusted with a 17 mm socket wrench.

More information is provided in the chapter "Adjusting the fork and shock absorber."

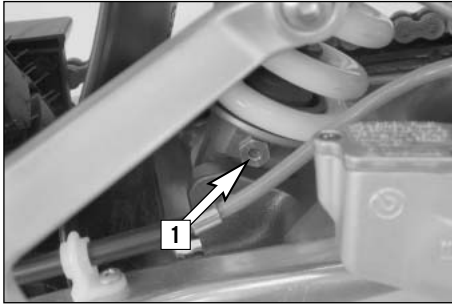

Rebound damping of shock absorber

The shock absorber's damping action during rebound travel (rebound damping) can also be adjusted. This allows you adjust the damping behavior to match your driving style and the payload.

The adjusting screw [1] is located on the bottom of the shock absorber.

More information is provided in the chapter "Adjusting the fork and shock absorber."

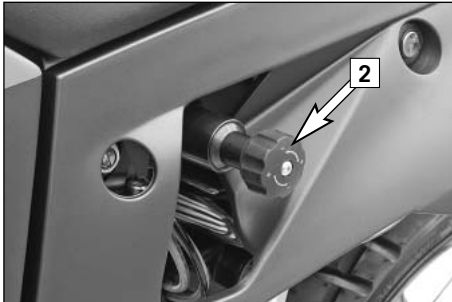

Shock absorber's preload adjuster

The shock absorber's preload adjuster is infinitely variable by means of the hand wheel [2]. This allows the shock absorber to be adapted to match your body weight and the payload. The hand wheel can be swung out to make adjustments.

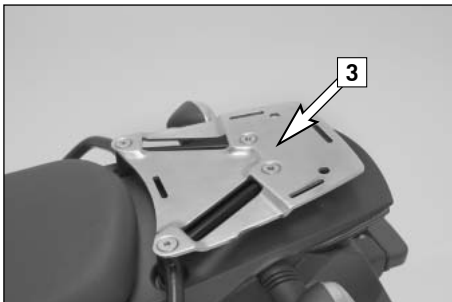

Baggage carrier plate

The base plate for your choice of case system can be attached to the baggage carrier plate [3].

WARNING

- Do not load more than 8 kg on the trunk carrier rack.
- Observe the baggage manufacturer's instructions.

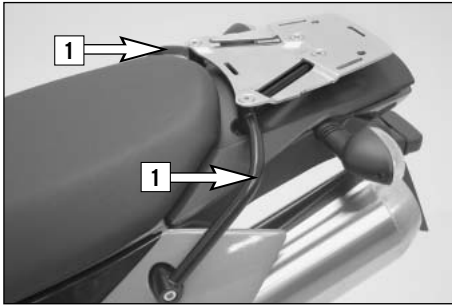

Grips

The passenger can hold on to both grab handles [1].

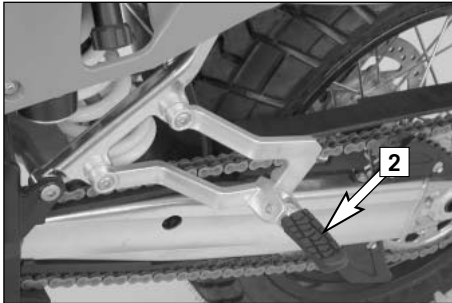

Footrests

The passenger footrests [2] fold up.

Alarm system

An alarm system can be retrofitted. Ask your authorized KTM shop for details.

Instructions for initial operation

- Make sure the work for the „pre-delivery inspection“ was performed by your authorized KTM workshop. The DELIVERY CERTIFICATE and SERVICE MANUAL will be handed over when you pick up your vehicle.
- Read these operating instructions carefully before your first ride.
- Enter the chassis, engine and key numbers on page 1.
- Familiarize yourself with the operating elements.
- Adjust the hand brake lever and foot brake lever to your most comfortable position.
- The motorcycle is equipped with 2 three-way catalysts. Leaded fuel will destroy the catalytic converters. Please use unleaded fuel only.
- Get used to handling the motorcycle on an empty parking lot, before starting on a longer drive. Also try to drive as slowly as possible and in standing position, to improve your feeling for the vehicle.
- Do not drive along off-road tracks which go beyond your ability and experience.
- Hold the handlebars with both hands and leave your feet on the foot rests while driving.
- Remove your foot from the foot brake lever when you are not braking. If the foot brake lever is not released the brake pads rub continuously and the braking system is overheated.
- Do not make any alterations to the motorcycle and always use ORIGINAL KTM

SPARE PARTS. Spare parts from other manufacturers can impair the safety of the motorcycle.

- New tires have a smooth surface, which means that they must be run in to achieve full grip. For this purpose, ride the motorcycle carefully at moderate speed during the first 200 kilometers with new tires, tilting the vehicle at different angles so that all sections are properly roughened. Tires will not display their full grip characteristics until they are properly run in.
- Motorcycles are sensitive to changes in the weight distribution. Read the section on "Accessories and payload" when carrying luggage.
- Pay attention to running-in procedure.

Running in the LC8 engine

Even finely machined surfaces of engine parts have rougher surfaces than parts that slide on each other for a long time. Therefore, every engine must be run in. For this reason, do not demand maximum performance from the engine for the first 1000 kilometers (620 miles). The vehicle must be run in at low, changing performance level for the first 1000 km (620 miles). The maximum number of revolutions per minute must not go exceed 6500 rpm. Once you have run your engine in for 1000 km, you may push it to its 9500 rpm limit, i.e. up to the black zone indicated in the tachometer. Exceeding the above listed rotations as well as pushing high rpm when the engine is cold will have an adverse effect on the life of your engine.



WARNING

- **Wear suitable clothing when driving a motorcycle. Clever KTM drivers always wear a helmet, boots, gloves and a jacket, regardless of whether driving all day or just for a short trip. The protective clothing should be brightly colored so that other vehicle can see you as early as possible. Your passenger will also need suitable protective clothing.**
- **Do not drive after having consumed alcohol.**
- **Always turn on the light to make sure that other drivers become aware of you as early as possible.**
- **Drive at a moderate speed for the first few kilometers of each trip to allow the tires to reach the necessary operating temperature. Maximum road grip is assured when the tires are warm.**
- **The front and rear wheel are allowed to be fitted only with tires that have the same profile type.**

⚠ WARNING

- The tires must be designed for a maximum speed of 240 kph (speed symbol V) and must be authorized by KTM.
- Do not exceed the respective maximum speed for tires designed with a speed index of less than "V" (240 kph). A sticker showing the maximum speed must be affixed to the motorcycle within the driver's field of vision.
- New wheels have a smooth surface, which means that they must be run in to achieve full grip. For this purpose, ride the motorcycle carefully at moderate speed during the first 200 kilometers with new tires, tilting the vehicle at different angles so that all sections are properly roughened. Tires will not display their full grip characteristics until they are properly run in.
- Wheels with a different rim diameter or other rim width may not be mounted otherwise the vehicle handling will no longer be safe. For models equipped with ABS (antilock brake system), the ABS function is no longer guaranteed.
- Models with ABS: The ABS is designed to be used with the tires authorized by KTM and works best with these tires. The ABS function cannot be guaranteed if other tires are used.
- Models with ABS: an incorrect tire pressure will have an adverse effect on the ABS control and driving stability and will increase the stopping distance.

- Observe the traffic regulations, drive defensively and trying to look ahead as far as possible so that any hazards can be recognized as early as possible.
- The faster you drive, the more sensitive your motorcycle will be to crosswind and changing road conditions. Your motorcycle can easily go out of control at high speeds.
- Choose your driving speed according to the conditions and your driving skills.
- Drive carefully on unknown roads or on unfamiliar trials.
- Renew the visor on your helmet or the glass of your goggles on time so as to ensure optimum vision in any situation. When light shines directly on scratched visor or goggles, the operator will be blinded.
- Never leave your motorcycle without supervision if the engine is running.

Accessories and payload

Accessory parts and baggage can significantly decrease a motorcycle's driving stability. Please observe the following warnings.

⚠ WARNING

- Never drive faster than 130 kph (80 mph) if you have mounted accessory parts on your motorcycle. Accessory parts can significantly impair the motorcycle's handling, especially in the maximum speed range.

- Never drive faster than 130 kph (80 mph) if your motorcycle is loaded with cases or other baggage. They will impair the motorcycle's handling at higher speeds and can easily cause it to go out of control
- If you have cases mounted, do not exceed the manufacturer's recommended maximum payload.
- Fasten the baggage close to the center of the motorcycle and distribute the weight evenly on the front and rear wheels and on the left and right.
- Baggage must be securely and adequately fastened; loose baggage will significantly impair driving safety.
- A high payload will change the motorcycle's handling and considerably increase the braking distance; adapt your driving speed accordingly.
- Never exceed the maximum permissible laden weight and the axle weights. The maximum permissible laden weight is made up of the following components:
 - Motorcycle ready for operation and tank full
 - Luggage
 - Driver and passenger with protective clothing and helmet

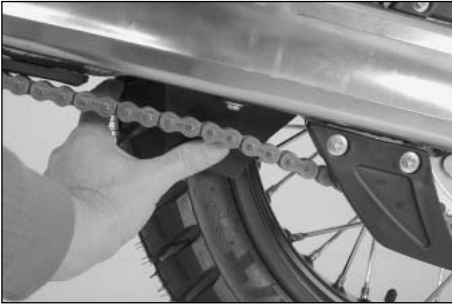

Check the following before each start

When you start, the motorcycle must be in perfect mechanical condition. For safety reasons, you should make a habit of performing an overall check of your motorcycle before each start.

The following checks should be performed:

1 FUEL

Check the fuel quantity in the tanks.

2 CHAIN

Check the tension and condition of the chain.

A loose chain can fall off the sprockets and a worn-out chain can tear. In both cases this can damage other motorcycle components and cause the motorcycle to go out of control. A chain that is too tight or not greased will cause unnecessary wear to the chain and sprockets.

3 TIRES

Check for damaged tires. Tires showing cuts or dents must be replaced. The tread depth must comply with the legal regulations. Also check the air pressure. Insufficient tread and incorrect air pressure deteriorate the driving performance.

4 BRAKES

Check correct functioning of the braking system. Check for sufficient brake fluid in the reservoir. The reservoirs have been designed in such a way that brake fluid does not need to be refilled even when the brake pads are worn. If the level of brake fluid falls below the minimum value, this indicates a leak in the braking system or completely worn out brake pads. Arrange for the braking system to be checked by a KTM specialist, as complete failure of the braking system can be avoided.

Also check the state of the brake hose and the thickness of the brake linings.

Check free travel at hand brake lever and foot brake lever.

5 CABLES

Check smooth operation of the throttle cables.



6 COOLING FLUID

Check the level of cooling fluid when the engine is cold.

7 ELECTRICAL SYSTEM

Start the engine and check the headlight, taillight, brake light, turn signal, indicator lamps and horn for proper functioning.

8 CHECK OIL LEVEL

Insufficient oil results in premature wear and consequently to engine damage.

9 BAGGAGE, PAYLOAD

Never exceed the maximum total weight (430 kg, 949 lbs) and the motorcycle's wheel loads. The maximum total weight is comprised of:

- the motorcycle in a running condition and refueled (232 kg, 512 lbs)
- the baggage and accessories
- the driver and passenger with protective gear and helmet

Adjust the tire inflation pressure as well as the preload and damping properties of the fork and shock absorber to the total weight.

Make sure your luggage is correctly fastened before you drive off.



WARNING

Never drive faster than 130 kph (80 mph) if your motorcycle is loaded with cases or other baggage. They will impair the motorcycle's handling at higher speeds and can easily cause it to go out of control.

10 REAR MIRROR

Sit on the motorcycle and check the adjustment of the rear mirror.

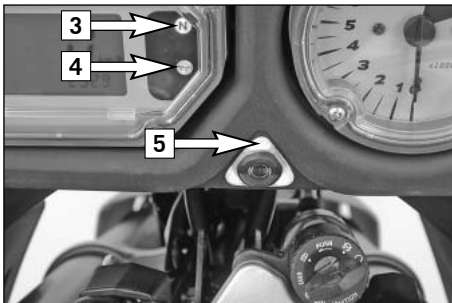
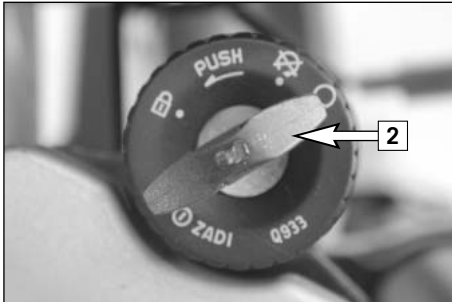
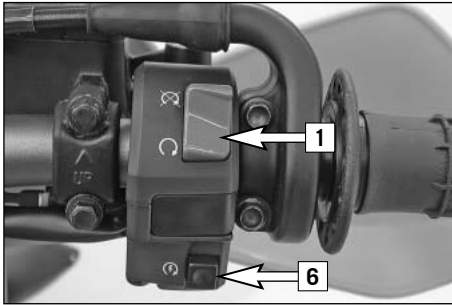

Starting the engine

- 1 Switch on emergency OFF switch [1].
- 2 Switch on ignition (turn ignition key [2] into position ).
- NOTE: You will hear the operation of the fuel pump for approx. 2 seconds after switching on the ignition. The **FI** indicator lamp will also light up during this time and the engine cannot be started.
- 3 NOTE FOR MODELS WITH ABS:
The ABS warning lamp [5] must light up when the ignition is switched on.
- 4 Switch transmission to idle (green indicator lamp **N** [3] lights up).
- 5 **Do not accelerate**; operate starter button [6].
- NOTE: If you accelerate during the starting process you will hear a loud, metallic sound caused by the torque limiter. The torque limiter protects the components in the starter drive from being damaged.
- 6 The oil pressure warning lamp [4] should go out as soon as the engine is running.
- 7 Take the motorcycle off of the main stand or side stand.

WARNING

- Do not start the engine and allow it to idle in a closed room. Exhaust fumes are poisonous and can cause loss of consciousness and death. Always provide adequate ventilation while the engine is running.
- Never operate the motorcycle with a run-down battery or without the battery. This can damage the electronic components or safety equipment in either case and the motorcycle will no longer be roadworthy.

CAUTION

- If you accelerate while starting, the engine management will not inject any fuel and the engine will not start. Do not accelerate while starting!
- If the oil pressure warning lamp does not go out as soon as the engine is running, immediately switch off the engine. If the engine is not switched off, engine damage will occur within a short period of time. Check the engine oil level or contact a ktm workshop.
- Maximum period for continuous starting: 5 seconds. Wait at least 5 seconds before trying again.
- Don't ride your motorcycle with full load and don't rev engine when cold. Because the piston is warming up faster than the water cooled cylinder, it can cause engine damage. Always let the engine warm up before and refrain from driving with full load until the engine is warm.

IF THE ENGINE DOES NOT CRANK WHEN YOU ACTUATE THE STARTER TIP SWITCH:

- whether you accelerated while starting
- the transmission is switched to idle
- Check if the emergency OFF switch is on
- Check if the ignition is on
- the headlight is on (the light is switched off when actuating the starter button)
 - If this is not the case, the battery is discharged
 - If the lights are on, proceed as described in the „Trouble-shooting“ section or contact a KTM dealer.

IF THE ENGINE CRANKS BUT DOES NOT START, WHEN YOU ACTUATE THE STARTER TIP SWITCH:

- whether you accelerated while starting
- whether the **FI** indicator lamp is blinking
 - if yes, check Troubleshooting - Blink codes table
- Check if sufficient fuel is in the tank
 - If this is not the case, refill the tank
 - if sufficient fuel is in the tank, proceed as described in the „Trouble-shooting“ section or contact a KTM dealer.

NOTE:

This motorcycle is equipped with a safety starting system. The engine can only be started if the transmission is in neutral or the clutch lever is pulled. If the side stand is folded down, the engine can only be started if the trans-

mission is in neutral or the clutch lever is pulled. The engine will stall if a gear is engaged and the clutch lever is released with the side stand folded down.

Starting off

Pull the clutch lever and engage 1st gear. Slowly release the clutch lever while you gently accelerate.

WARNING

Before you start off, check that the main stand has been swung up fully. If the stand drags on the ground, the motorcycle can go out of control.

Shifting/Riding

You are now in first gear, referred to as the drive or uphill gear. Depending on the conditions (traffic, road gradient, etc.), you can shift to a higher gear. Close throttle, at the same time pull clutch lever and shift to the next higher gear. Let clutch lever go again and carefully open throttle. Do not shift gears and accelerate carefully in curves.

Only accelerate to the extent that road and weather conditions allow. Be especially careful when you accelerate in curves. Abrupt opening of the throttle can cause the motorcycle to go out of control and also increases fuel consumption.

By shifting down, use the brakes if necessary and close throttle at the same time. Pull clutch lever and shift down to the next gear.

Let clutch lever go slowly and open throttle or shift down again.

If the engine is killed f.ex. at a crossing, simply pull the clutch lever and start. It is not necessary to switch the gear to NEUTRAL. Stop immediately if the FI indicator lamp lights up while driving. The FI indicator lamp will start blinking as soon as the transmission is in neutral. The rhythm of the blinking lamp will let you determine the two-digit „blink code“, e.g.:

Blink code 34: FI blinks 3x long, 4x short, pause,



Blink code 06: FI blinks 6x short, pause.

The blink code will indicate which component is defective (see Troubleshooting). This makes it possible to pinpoint the defect if a diagnostic tool is unavailable.

WARNING

- **Avoid abrupt load changes while riding around bends and on wet or slippery ground. Otherwise you might easily lose control over your motorcycle.**

⚠ WARNING

- While riding your motorcycle, never switch the ignition lock to positions  And .
- Do not try to change the settings of the multi-functional Speedometer while driving. Your attention will be distracted from the traffic and may cause you to lose control of your motorcycle.
- The passenger must hold on to the driver or the grab handle on the baggage carrier during the ride and keep his feet on the passenger footrests.
- Regularly make sure that the baggage and cases are tightly fastened.
- After falling with the motorcycle, check all functions thoroughly before starting up operations again.
- A bent handlebar must always be replaced. Never try to straighten the handlebar because this will cause it to lose its stability.

! CAUTION

- High rpm rates when the engine is cold have an adverse effect on the life of your engine. We recommend you run the engine in a moderate rpm range for a few miles giving it a chance to warm up. After that no further precautions in this respect need be taken. The engine has reached operating temperature as soon as the 4th bar on the temperature indicator lights up.
- If the red oil pressure warning lamp lights up while driving, the oil pressure is too low to adequately lubricate the engine.

Stop immediately and switch off the engine. If you continue to drive, engine damage will occur within a short period of time. Check the engine oil level or contact an authorized KTM workshop.

- Never have the throttle wide open when changing down to a lower gear. The engine will overspeed, damaging the valves. In addition, the rear wheel blocks so that the motorcycle can easily get out of control.
- Never use your motorcycle without an air filter. Otherwise dust and dirt may enter the engine and cause increased wear.
- Stop immediately if a perceptible power loss occurs while driving due to a defective ignition caused by a cylinder misfiring or breaking down. If the unburned fuel/air mixture reaches the catalytic converter, it will ignite and the resulting heat will destroy the catalytic converter and the adjoining components.
- the red coolant warning lamp lights up when the coolant temperature has reached 120°C (248°F).

possible causes for the increase in temperature:

- low driving velocity and high load situation in high air temperatures
- level of coolant in the system is insufficient
- fan at radiator is not running
- improper use of the clutch while driving at low velocities

Let the engine cool down. Meanwhile, check whether any cooling liquid is leaking out of the motorcycle. Check the cool-

ing liquid level in the radiator (not only in the compensating tank). - CAUTION SCALDING HAZARD! Do not drive on, until there is sufficient liquid in the cooling system.

- In the event that, while riding on your motorcycle, you notice any unusual operation-related noise, stop immediately, turn the engine off, and contact an authorized KTM dealer.

Braking – models without ABS (antilock brake system)

Close throttle and apply the hand and foot brakes at the same time. Carefully apply the brakes on sandy, wet or slippery surfaces. Always brake with feeling, blocking wheels can cause you to skid or fall. Also change down to lower gears depending on your speed. Always finish braking before you enter a curve.

When driving downhill, use the braking effect of the engine. Change down one or two gears but do not overspeed the engine. In this way, you will not need to brake so much and the brakes will not overheat.

Braking – models with ABS (antilock brake system)

Close throttle and apply the hand and foot brakes at the same time. The ABS allows you to apply the full braking force during full braking and with poor road grip on sandy, wet

or slippery surfaces without running a risk of having the wheels lock.

WARNING

- The ABS cannot prevent one or both wheels from losing the road grip if the motorcycle is banked during the braking procedure. Although the wheel will not lock, the centrifugal force will cause the wheel to lose traction and cause the motorcycle to crash despite the ABS.
- The ABS cannot prevent one or both wheels from losing traction if braking the motorcycle on laterally sloping surfaces. Although the wheel will not lock, the lateral force will cause the wheel to lose traction and cause the motorcycle to crash despite the ABS.
- The ABS cannot prevent the rear wheel from locking on slippery surfaces due to the engine's braking effect.
- The ABS cannot generally guarantee a shorter stopping distance in every situation.
- Do not try to offset the added safety afforded by the ABS against a risky driving style!

When braking, shift to a lower gear in accordance with the speed. Pull the clutch during emergency braking or braking on slippery surfaces. Always finish braking before you enter a curve. When driving downhill, use the braking effect of the engine. Change down one or two gears but do not overspeed the

engine. In this way, you will not need to brake so much and the brakes will not overheat.

Switching off the ABS

The ABS can be switched off when driving off-road with a special driving technique when you want the wheels to lock up.

To switch off the ABS, stop the motorcycle and press the ABS button for at least 3 seconds with the engine running. Let go of the ABS button as soon as the ABS warning lamp starts blinking fast. The ABS warning lamp will blink slowly to indicate that the ABS is switched off.

To switch the ABS on again, stop and switch off the ignition. The ABS will be active again when you switch on the ignition.

WARNING

Do not try to switch the ABS on or off while driving. Your attention will be distracted from the traffic and it may cause you to lose control of the motorcycle.

WARNING

Applies to all models with and without ABS:

- In the rain, or after the motorcycle has been washed, braking action may be delayed due to wet brake discs. First, the brakes must be braked dry.
- On salt-sprayed or dirty roads brake action may be delayed as well. First, the brakes must be braked clean.
- Remember that the stopping distance will be longer if you are carrying a passenger or baggage.
- When you brake, the brake discs, brake pads, brake caliper and brake fluid heat up. The hotter these parts get, the weaker the braking effect. In extreme cases, the entire braking system can fail.
- If the resistance in the hand brake lever or foot brake pedal feels „spongy“ (too much play), this is an indication that something is wrong with the brake system. Don't ride your motorcycle anymore without first having the brake system looked over by a KTM dealer.

Stopping and parking

Apply the brakes fully and put the engine into neutral. To stop the engine, switch off the ignition. Park the motorcycle on a firm surface and lock.

WARNING

- Always park your motorbike on a solid and horizontal surface.
- Never leave your motorcycle without supervision as long as the engine is running.
- Motorcycle engines produce a great amount of heat while running. The engine radiators, exhaust, exhaust system, brake discs, and shock absorbers can become very hot. Do not touch any of these parts after operating the motorcycle, and take care to park it where pedestrians are not likely to touch it and get burned
- Never park your motorcycle in places where there exist fire hazards due to dry grass or other easily flammable materials.

CAUTION

Always take out the ignition key when parking your motorcycle so that it cannot be used by unauthorized persons.



INFORMATION ABOUT THE SIDE STAND

Use your foot to push the side stand forward as far as possible, and lean your motorcycle to the side. Make sure that your motorcycle is standing safely on solid ground. Just in case, you can also put in a gear.

CAUTION

The side stand is dimensioned for the weight of the motorcycle only. If you are sitting on the motorbike and thus apply an additional load onto the side stand, you may cause damage to the side stand or the engine case, and your motorbike may fall over.



NOTE REGARDING THE CENTER STAND:

We advise the following procedure to place the motorcycle on the center stand as effortlessly as possible:

- a) press main stand to ground using foot
- b) put your weight on the stand stabilizer and pull the motorcycle back by the footrest support (see illustration).

Make sure that the ground is solid and that your motorcycle is standing securely.

! CAUTION

- The center stand is designed to hold the weight of the motorcycle only. By sitting on the motorcycle, you will put additional weight on the center stand, possibly causing the center stand or frame to be damaged or the motorcycle to fall down.
- Do NOT pull the motorcycle back on the center stand by holding the hand wheel [2] on the shock absorber adjustment (it could cause the shock absorber to leak) but use the footrest bracket [1].

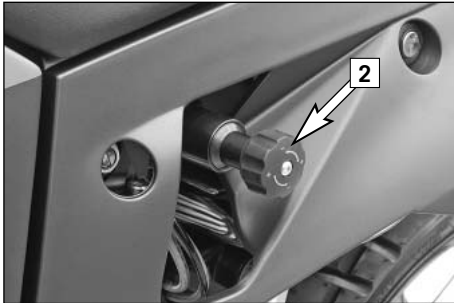

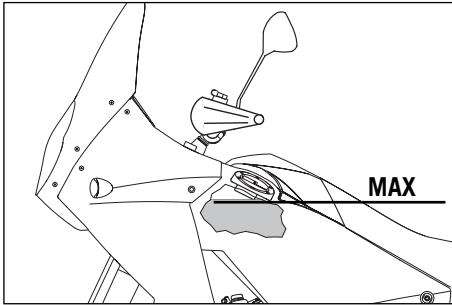

Fuel

In the condition at delivery, the LC8 engine requires unleaded fuel with at least RON 95 (USA = Premium PON 91).

If using lower octane fuel, it is easy to change over to the pre-programmed ignition curve for 80 - 94 octane (RON) (see activating the ignition curve for low-octane fuel).

After refueling, it will take approx. 8 minutes for the fuel warning lamp to switch off and for TRIP F to automatically reset to 0 and return to the previous display mode.

NOTE:

Press the SET key for 2 seconds to immediately turn off the fuel warning lamp.

! CAUTION

- Use unleaded fuel with at least RON 95 (USA = Premium RON 91). If using lower octane fuel, the ignition curve must be changed, otherwise engine damage will occur.
- This motorcycle is equipped with 2 catalytic converters. Leaded fuel will destroy the catalytic converters. Please use unleaded fuel only.

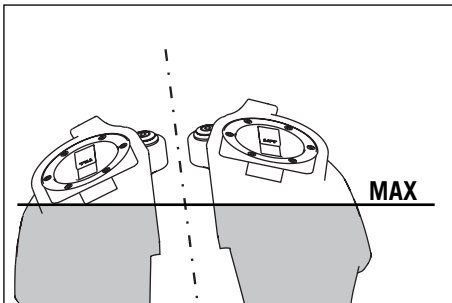

The 990 Adventure has 2 tanks with 1 filler cap each. Both filler caps can be locked and are equipped with a tank vent system. To open, insert the ignition key, turn 45° in a clockwise direction and fold up the filler cap. The ignition key can be pulled out to open the other filler cap. Simply press on the filler cap to close.

Fill the right tank first, then the left tank (see drawing for the maximum filling level). If the right tank is filled up to the filler neck, fuel may overflow when the motorcycle is parked on the side stand after refueling when the fuel becomes warm.

⚠ WARNING

Gasoline is highly flammable and poisonous. Extreme caution should be used when handling gasoline. Do not refuel the motorcycle near open flames or burning cigarettes. Always switch off the engine before refuelling. Be careful not to spill gasoline on the engine or exhaust pipe while the engine is hot. Wipe up spills promptly. If gasoline is swallowed or splashed in the eyes, seek a doctor's advice immediately.

990 ADVENTURE 2007 A clean motorcycle can be checked more quickly which saves money!		1st Service after 1000 km	every 7500 km or once a year	every 15000 km or every 2 years
ENGINE	Change engine oil and oil filter	●	●	●
	Clean oil screens of engine and oil tank	●	●	●
	Clean magnetic drain plugs of engine and oil tank	●	●	●
	Check oil lines for damage and kink-less arrangement	●	●	●
	Renew spark plugs			●
	Check and adjust valve clearance	●		●
	Check engine fastening bolts for tight fit	●	●	●
	Check all engine bolts accessible from the outside for tight fit	●	●	●
	Check clutch linings			●
	Check clutch pressure booster system			●
	Clean the oil jet for the clutch lubrication	●		●
FUEL INJECTION	Check rubber boots for cracks or leaks	●		●
	Check fault memory with the KTM diagnosis tool	●	●	●
	Perform a status check of neutral, clutch, 2nd/3rd gear and side stand switch using the KTM diagnosis tool	●	●	●
	Make sure the fuel hose, hoses on the vacuum sensors, SAS hoses and vent hoses are run correctly and check for damage	●	●	●
	Replace the O-ring on the fuel hose connection and check for leaks	●	●	●
Check the wiring harness on the throttle body for proper installation and damage	●		●	
ADD-ON-PARTS	Check cooling system for leaks and antifreeze protection	●	●	●
	Check radiator fan for proper operation	●	●	●
	Check exhaust system for leaks and correct fitment	●	●	●

990 ADVENTURE 2007 A clean motorcycle can be checked more quickly which saves money!		1st Service after 1000 km	every 7500 km or once a year	every 15000 km or every 2 years
ADD-ON-PARTS	Check actuating cables for damage, smooth operation, and kink-less arrangement, adjust and lubricate	●	●	●
	Check fluid level of the clutch master cylinder		●	●
	Check air filter, renew if necessary, clean air filter box			●
	Check cables for damage and kink-less arrangement	●	●	●
	Check headlamp adjustment	●	●	●
	Check electrical system for function (low/high beams, stop light, turn indicators, headlamp, flasher, tell-tale lamps, ABS warning lamp, speedometer illumination, horn, side-stand switch, clutch switch, emergency-off switch)	●	●	●
	Make sure all bolts and nuts are tight	●	●	●
BRAKES	Check brake fluid level, lining thickness, and brake discs	●	●	●
	Change brake fluid			●
	Check brake lines for damage and leaks	●	●	●
	Check/adjust smooth operation, free travel of handbrake/footbrake levers	●	●	●
	Check bolts of brake system for tight fit	●	●	●
	Check the ABS fault memory using the KTM diagnostics tool	●	●	●
CHASSIS	Check shock absorber and fork for leaks and proper operation	●	●	●
	Clean fork dust sleeves		●	●
	Bleed fork legs	●	●	●
	Check swinging-fork pivot	●	●	●
	Check/adjust steering-head bearing	●	●	●
	Check all chassis bolts for tight fit (fork plates, fork leg, axle nuts/bolts, swinging-fork pivot, shock absorber)	●	●	●

990 ADVENTURE 2007 A clean motorcycle can be checked more quickly which saves money!		1st Service after 1000 km	every 7500 km or once a year	every 15000 km or every 2 years
WHEELS	Check spoke tension and rim joint	●	●	●
	Check tire condition and inflation pressure	●	●	●
	Check chain, sprockets and chain guides for wear, force fit and tension	●	●	●
	Check bolts on pinion and chain sprocket for locking devices and a tight fit	●	●	●
	Lubricate chain	●	●	●
	Check wheel bearings and jerk damper for play		●	●

If motorcycle is used for competition 7500 km service should be carried out after every race!

Service intervalls should never be exceeded by more than 500 km.

Maintenance work done by KTM authorized workshops is not a substitute of care and checks done by the rider!

990 ADVENTURE 2007 ADDITIONAL SERVICE WORK TO BE PERFORMED UNDER A SEPARATE ORDER		
	at least once a year	every 15000 km or every 2 years
Perform complete fork maintenance		●
Perform complete shock absorber maintenance		●
Clean and lubricate steering-head bearing and sealing elements	●	
Treat the electrical contacts and switches with contact spray	●	
Treat battery connections with contact grease	●	
Change coolant fluid		●

990 ADVENTURE 2007 VITAL CHECKS AND CARE PROCEDURES TO CONDUCTED BY THE OWNER OR THE MECHANIC			
	before each start	after every cleaning	every 1000 km or after off road use
Check oil level	●		
Check brake fluid level	●		
Check brake pads for wear	●		
Check lighting system for proper operation	●		
Check horn for proper operation	●		
Lubricate actuating cables and nipples		●	
Bleed fork legs			●
Clean chain			●
Lubricate chain		●	●
Check chain tension	●		
Check tire pressure and wear	●		
Check coolant level	●		
Check fuel lines for leaks	●		
Check all control elements for smooth running	●		
Check brake performance	●	●	
Treat exposed metal components (except for the braking and exhaust systems) with wax-based anti-corrosion agents		●	
Treat ignition/steering lock and light switch with contact spray		●	

! CAUTION

- When cleaning the motorcycle, do not use a high pressure cleaning unit if possible, otherwise water will penetrate the bearings, electric connectors etc.
- Do not use toothed washers or spring washers with the engine fastening screws, as these work into the frame parts and keep working loose. Instead, use self-locking nuts.
- If you unscrew any screwed connections with self-locking nuts, they must be replaced when mounting. If no self-locking nuts are available, apply Loctite 243 to the thread. The screws and nuts must be replaced if the thread is damaged.
- All screws and nuts must be tightened to the specified torque figures using a torque wrench. If screws or nuts are not adequately tightened, they can become loose and cause the motorcycle to go out of control while you drive. Tightening the screws and nuts too tightly can damage the thread and components.
- Let your motorcycle cool down before beginning any maintenance work in order to avoid getting burned.
- Dispose of oil, grease, filters, fuels, cleaning agents etc. according to your local regulations.
- Under no circumstances may used oil be disposed of in the sewage system or in the open countryside. 1 liter used oil contaminates 1,000.000 liters water.



Removing and remounting the seat

Insert the ignition key in the seat lock and turn in a counterclockwise direction to unlock the seat. Lift the back of the seat and pull off towards the rear.

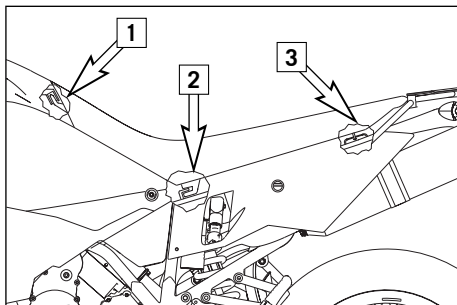

To remount, fit the nose [1] of the seat in the front, lower the back while pushing towards the front. Both noses [2] should fit into the frame. Insert the catch bolts [3] in the lock housing and push the seat down in the back until you hear the catch bolts snap into place. Check whether the seat is correctly mounted.

! CAUTION

If not correctly mounted, the seat can slip while you are driving and cause you to lose control of your motorcycle.

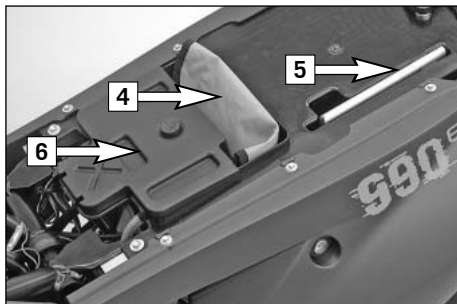

Tool set

The tool set [4] and an extension piece [5] for some of the wrenches in the tool set are located in the pocket under the seat.

The 990 Adventure S model (without ABS) has an additional storage compartment under the cover [6].

BASIC SETTING FORK 990 ADVENTURE 990 ADVENTURE S	Driving Comfort	Basic Setting	Driving Sport	Maximum Payload
	Compression adjuster (clicks)	20	15	10
Rebound adjuster (clicks)	23	18	13	13
Spring preload (turns)	5	5	8	7

Adjusting the fork and shock absorber

There are a number of ways to adjust the fork and shock absorber to match the chassis to your driving style and the payload.

We have provided a table with pragmatival values to help you tune up your motorcycle. These tune-up specifications are reference values only and should serve as a basis for your personal chassis and suspension tuning. Do not make arbitrary changes to the settings (maximum $\pm 40\%$) since this may impair the handling characteristics (particularly in the high-speed range).

We recommend the "Driving Sport" damping adjustment for off-road rides on soft subgrades (e.g. sand) and the "Driving Comfort" damping adjustment for off-road rides on hard subgrades (e.g. rocks).

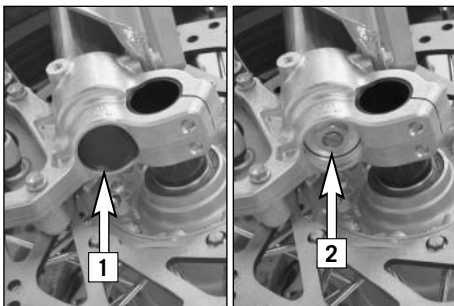

Adjusting compression damping of fork

Hydraulic compression damping determines the reaction when the fork is compressed. The degree of compression can be adjusted with adjusting screws at the bottom of the fork legs. Carefully pry out the protection cover [1] with a screwdriver and remove.

Turn the adjusting screws [2] clockwise to increase damping, turn it counterclockwise to reduce damping during compression. Make the same damping rate adjustments to both fork legs.

STANDARD ADJUSTMENT

- Turn adjusting screw clockwise as far as it will go.
- Turn 15 clicks in a counterclockwise direction.

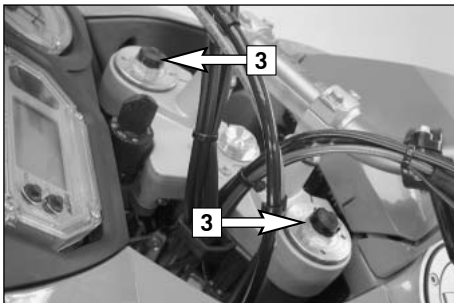

Adjusting rebound damping of fork

Hydraulic rebound damping determines the reaction when the fork is rebound. By turning the adjusting screw [3] (REB), the degree of damping of the rebound can be adjusted. Turn the knob clockwise to increase damping, turn it counterclockwise to reduce damping during rebounding. Make the same damping rate adjustment to both fork legs.

STANDARD ADJUSTMENT

- Turn adjusting screw clockwise as far as it will go.
- Turn 18 clicks in a counterclockwise direction.

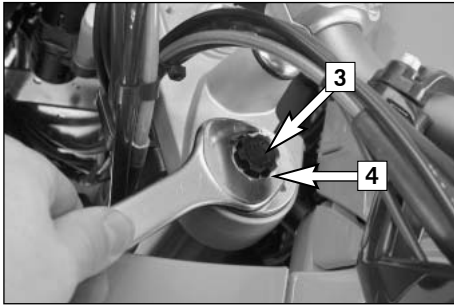

Adjusting the spring preload on the fork

The fork spring preload can be adjusted by turning the adjusting screws [4] (wrench size 24 mm) \pm 5 mm (0,2 in).

Turning in a clockwise direction will increase the preload, turning in a counterclockwise direction will decrease the preload. 1 turn will change the preload by 1 mm.

Changing the preload will not affect the rebound damping adjustment, although adjusting screw [3] will turn at the same time. Make the same spring preload adjustments to both fork legs.

Generally, if the preload is higher, the rebound damping should also be set higher.

STANDARD ADJUSTMENT:

Turn the adjusting screw in a counterclockwise direction up to the stop and then 5 turns in a clockwise direction.

BASIC SETTING SHOCK ABSORBER 990 ADVENTURE	Driving Comfort	Basic Setting	Driving Sport	Maximum Payload
Compression adjuster Low Speed (clicks)	25	20	15	15
Compression adjuster High Speed (turns)	2	1.5	1	1
Rebound adjuster (clicks)	20	15	10	10
Spring preload (turns)	6	6	10	18

BASIC SETTING SHOCK ABSORBER 990 ADVENTURE S	Driving Comfort	Basic Setting	Driving Sport	Maximum Payload
Compression adjuster Low Speed (clicks)	25	20	15	15
Compression adjuster High Speed (turns)	2	1.5	1	1
Rebound adjuster (clicks)	20	15	10	10
Spring preload (turns)	6	6	10	12



Compression damping of shock absorber

The shock absorber can synchronize the compression damping in the low and high-speed range separately (Dual Compression Control).

Low and high speed refers to the movement of the shock absorber during compression and not to the speed of the motorcycle.

The low and high-speed technology overlaps.

The low-speed setting is primarily for slow to normal shock absorber compression rates.

The high-speed setting is effective at fast compression rates.

Turning in a clockwise direction will increase the damping, turning counterclockwise will decrease the damping.

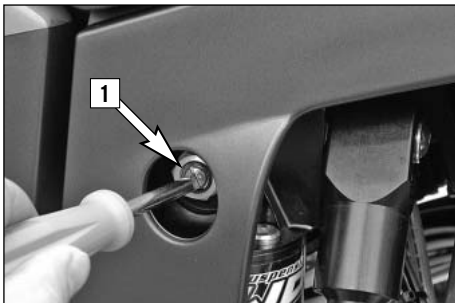

STANDARD ADJUSTMENT LOW-SPEED:

- turn the adjusting screw [1] to the limit in a clockwise direction using a screwdriver.
- unscrew the respective number of clicks for the specific type of shock absorber in a counterclockwise direction.

990 Adventure20 clicks

990 Adventure S20 clicks



STANDARD ADJUSTMENT HIGH-SPEED:

- Turn the adjusting screw in a clockwise direction up to the stop with a socket wrench (wrench size 17 mm).
- Turn the adjusting screw in a counterclockwise direction the number of turns specified for the respective type of shock absorber.

990 Adventure1.5 turns

990 Adventure S1.5 turns

⚠ WARNING

The damping unit of the shock absorber is filled with high-compression nitrogen. Never try to take the shock absorber apart or to do any maintenance work yourself. Severe injuries could be the result.

Never unscrew the black screw connection (24mm).

Rebound damping of shock absorber

By using the adjusting screw [4], the degree of damping of the rebound can be adjusted. Turn the knob in a clockwise direction to increase damping, turn it in a counterclockwise direction to reduce damping during rebounding.

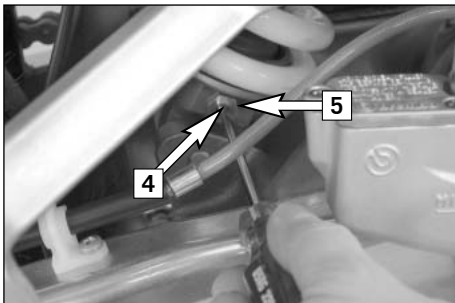

STANDARD ADJUSTMENT:

- turn the adjusting screw clockwise to the stop.
- then turn the adjusting screw counterclockwise, counting the number of clicks that corresponds to the respective type of shock absorber.

990 Adventure15 clicks

990 Adventure S15 clicks

⚠ WARNING

The damping unit of the shock absorber is filled with high-compression nitrogen. Never try to take the shock absorber apart or to do any maintenance work yourself. Severe injuries could be the result.

Never unscrew the black screw connection [5] (15mm).

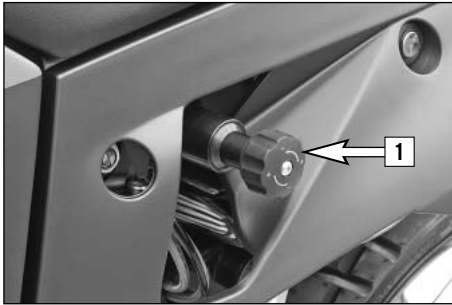

Adjusting the preload of the shock absorber

The baggage and passenger put the main load on the shock absorber. To guarantee maximum handling performance, the preload of the shock absorber must be adapted to the load. The preload is hydraulically adjusted by turning the hand wheel [1]. Turning in a clockwise direction will increase the preload, turning in a counterclockwise direction will reduce the preload.

Our pragmatcal values are provided in the table "Basic settings for the shock absorber" to help you to make the necessary adjustments.

STANDARD ADJUSTMENT:

- Turn the hand wheel in a counterclockwise direction up to the stop
- Turn the hand wheel 6 turns in a clockwise direction

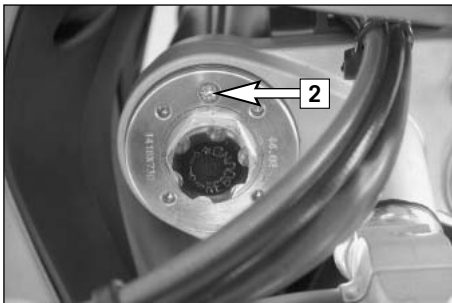

Breathing the fork legs

Breath the fork legs regularly (see Maintenance Schedule).

To breath, place the motorcycle on the side stand and briefly remove the bleeder screws [2] to allow any overpressure to escape from the fork.

! CAUTION

Excessive pressure in the interior of the fork can cause leaks in the fork. If your fork is leaking, it is recommended to open the breather plugs before having the seals replaced.

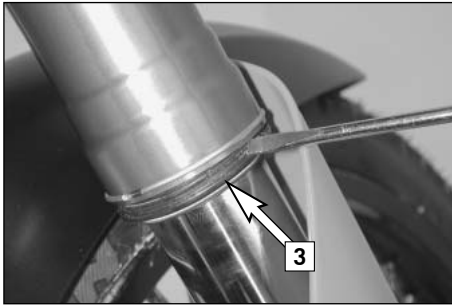

Cleaning the dust sleeves of the telescopic fork

The dust-protection bellows [3] are to remove dust and coarse dirt particles from the fork tube. However, after some time, dirt may also get in behind the dust-protection bellows. If this dirt is not removed, the oil sealing rings located behind it may start to leak. Use a screwdriver to lever the dust-protection bellows out of the outer tubes and slide them downward.

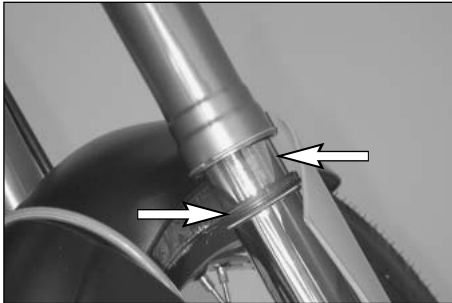

Clean dust-protection bellows, outer tubes, and fork tubes thoroughly, and oil them thoroughly with Universal oil spray (Motorex Joker 440) or engine oil. Then, push dust-protection bellows into the outer tubes by hand.

WARNING

No oil may reach the front tire or the brake disks since this would considerably reduce the tire's road grip and the braking effect of the front brake.

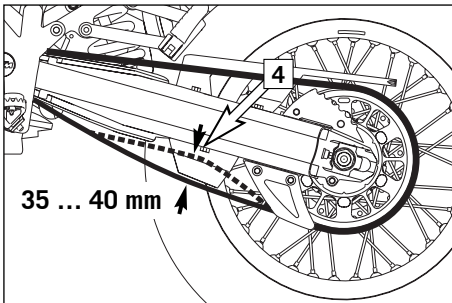

Checking the chain tension

Place the motorcycle on the side stand and switch the transmission to idle. Press the chain upwards under the lower chainguard screw [4]. The difference to the sagging chain should be 35 - 40 mm (1.37 ... 1.57 in).

WARNING

- If chain tension is too great, parts within the secondary power transmission (chain, chain sprockets, transmission and rear wheel bearings) will be subjected to unnecessary stress, resulting in premature wear and even chain breakage.
- Too much slack in the chain, on the other hand, can result in the chain jumping off the chain wheels. If this happens, the chain could also block the rear wheel or damage the engine.
- In either case the operator is likely to lose control of the motorcycle.

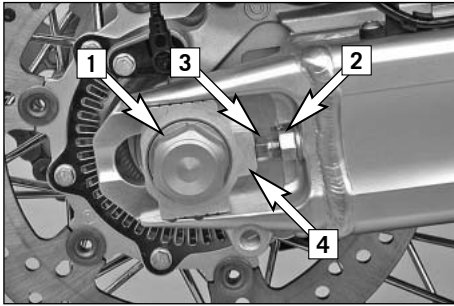

Correct chain tension

Loosen collar nut [1], loosen counter nuts [2], and turn right and left adjusting screws [3] equally far. Tighten counter nuts [2].

Before tightening the wheel spindle, verify that the chain adjusters [4] are sitting close to the adjusting screws and that the rear wheel has been aligned with the front wheel.

Tighten collar nut [1] with 90 Nm.

WARNING

If you don't happen to have a torque wrench at hand, make sure you have the tightening torque corrected by a KTM dealer as soon as possible. A loose axle may lead to an unstable driving behavior of your motorcycle.

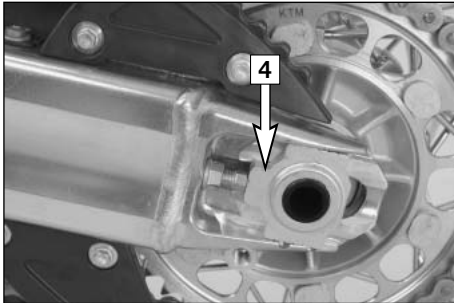

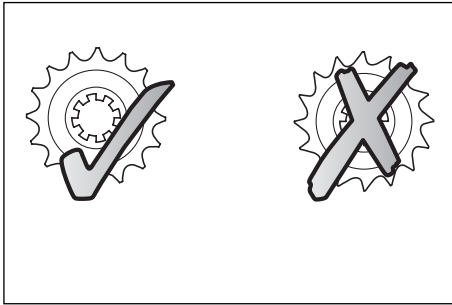

Chain maintenance

Maintenance of the X-ring chain is reduced to a minimum. Rinse off any heavy dirt with plenty of water. Residual used grease must be removed prior to lubrication (Motorex Chain Clean 611). After drying, use a chain spray specially designed for X-ring chains (Motorex Chainlube 622).

⚠ WARNING

- No lubrication is allowed to reach the rear tire or the brake disk, otherwise the road adherence and the rear wheel braking effects would be strongly reduced and the motorcycle could easily get out of control.
- The chain does not have a chain joint for safety reasons. Always have the chain replaced in an authorized KTM workshop where the service technicians have the required riveting tool.
- Never mount a normal chain joint.

Also check sprockets and chain guides for wear, and replace if necessary.

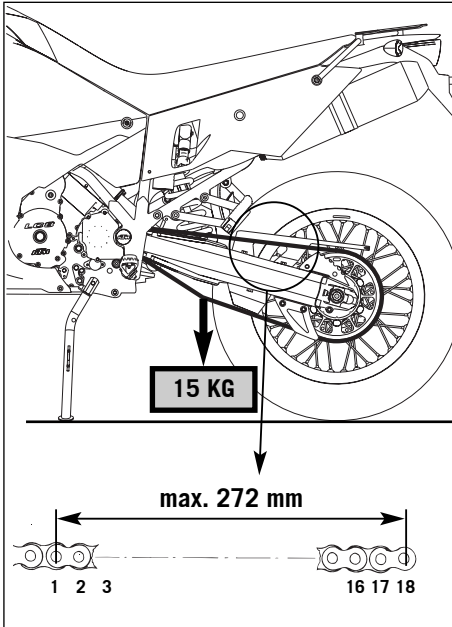

Checking the chain for wear

To check the chain for wear proceed as follows:

Switch the transmission to idle and put a load of approx. 15 kilograms (33 lbs) on the lower part of the chain (see illustration). Now measure the distance between 18 chain rollers on the upper part of the chain. The chain needs to be replaced when the distance is 272 mm (10.70 in). Since chains do not always wear evenly, repeat the measurement at different parts of the chain.

Replace the chain if any X-rings are missing.

NOTE:

If you mount a new chain, the sprockets should also be replaced. New chains wear faster if used on old used sprockets.

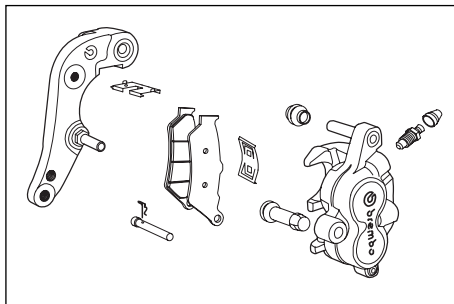

General informations about KTM disc brakes

BRAKE CALIPERS:

The brake calipers of this series “float”. This means that the brake calipers are not solidly attached to the caliper support. Thus, the brake pads are always in optimum contact with the brake disc. Secure the screws of the caliper support with Loctite 243 and tighten to 25 Nm.

⚠ WARNING

For safety reasons, always have maintenance work and repairs to the brake system performed by an authorized KTM workshop.



BRAKE PADS:

Your motorcycle is equipped with sintered brake pads in the front and rear and homologated accordingly. They guarantee maximum braking performance.

Front brake pads: Toshiba TT 2172 HH

Rear brake pads: Toshiba TT 2701 HH

⚠ WARNING

- **Brake pads available in the accessory trade are often not authorized for operation of your KTM motorcycle in road traffic. The brake pads design and friction factor and therefore the braking power can deviate significantly from original KTM brake pads. If you use different brake pads than those provided with the original equipment, it cannot be warranted that they are authorized for use in road traffic. Your motorcycle will not longer comply with the regulations authorizing the use of vehicles for road traffic and the warranty will be void.**
- **Models with ABS (antilock brake system): The ABS is designed to be used with the original brake pads. The ABS function cannot be guaranteed if other brake pads are used.**



BRAKE FLUID RESERVOIRS:

The brake fluid reservoirs on the front and rear wheel brakes have been designed in such a way that even if the brake pads are worn it is not necessary to top up the brake fluid. There is no reason to remove the reservoir cap under normal conditions. If the brake fluid level drops below the minimum either the brake system has a leak or the brake pads are completely worn down. In this case, consult an authorized KTM dealer immediately.

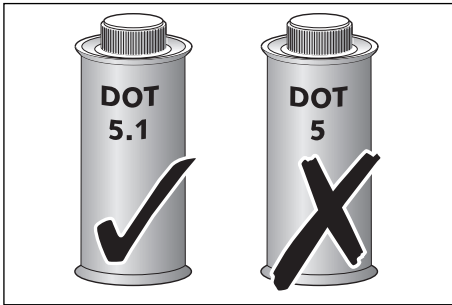

BRAKE FLUID:

We recommend that you use Motorex DOT 5.1 brake fluid when you refill or change the brake fluid. DOT 5.1 brake fluid has a wet boiling point of 180°C / 356°F (25°C / 45°F higher than DOT 4) and is safer for high performance applications. Brake fluid DOT 5.1 is a polyethylene glycol based fluid, amber-colored and can be mixed with DOT 4 brake fluid. **Do not, in any event, use DOT 5 brake fluid.** It is based on silicone oil and is dyed purple. KTM motorcycle gaskets and brake hoses are not designed for DOT 5 brake fluid.

Brake fluid is exposed to a high thermal load and absorbs moisture from the air, which lowers the boiling point. The brake fluid should therefore be changed at the prescribed intervals.

WARNING

Have the brake fluid for the front and rear brake changed at an authorized KTM workshop every 2 years.

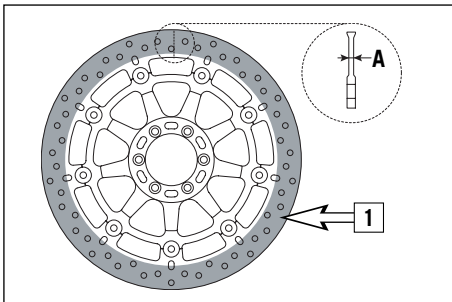

BRAKE DISCS:

Wear reduces the thickness of the brake disc in the area of contact [1] with the brake pads. The brake disk should not be thinner than 4.5 mm (0.18 in) at the weakest point [A]. Check the wear at several points.

WARNING

Brake disks that are less than 4.5 mm (0.18 in) thick are a safety hazard. Have worn brake disks replaced immediately.

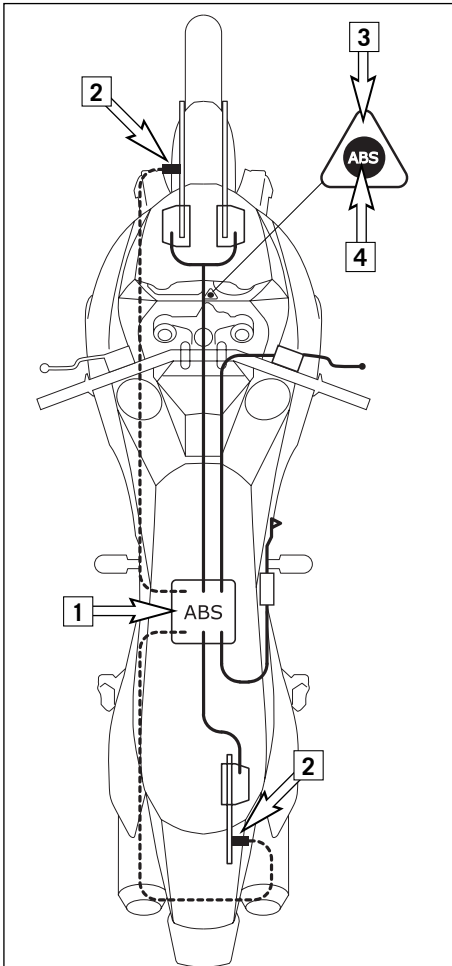

ABS (ANTILOCK BRAKE SYSTEM) 990 ADVENTURE:

The ABS is a safety system that prevents the wheels from locking when driving straight ahead without the influence of lateral forces. The ABS unit [1], consisting of a hydraulic unit, an electronic control unit and the electric pump motor, is located under the seat. Sensors [2] on the front and rear wheel send pulses to the control unit to indicate how fast the wheel is turning.

The KTM 990 Adventure ABS operates with two independent brake circuits (front and rear wheel brake). During normal service the brake system works just like a conventional brake without the ABS. The ABS control phase sets in when the control unit detects that one of the wheels is starting to lock. It releases the pressure in the respective brake circuit and prevents the wheel from locking. You can feel the control function as a slight pulsing in the brake lever.

The ABS warning lamp [3] must light up when the ignition is switched on and go out at a speed of approx. 5 KPH after you drive off. If it stays on or lights up while driving, the ABS is defective (see Troubleshooting).

The ABS can be switched off with the ABS button [4] (see Driving Instructions).

⚠ WARNING

- Do not mount wheels with a different rim diameter. The ABS function can no longer be guaranteed.
- Do not carry out any chassis modifications that extend or shorten the spring travel otherwise the proper functioning of the ABS cannot be warranted.
- The ABS is designed to be used with the tires authorized by KTM and works best with these tires. The ABS function cannot be guaranteed if other tires are used.
- Maximum ABS control can no longer be guaranteed if the tire pressure is incorrect.

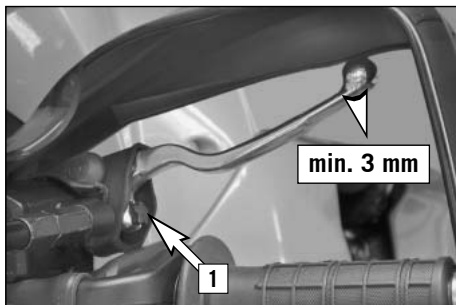

Adjusting of free travel at the hand brake lever

Free travel at the hand brake lever may be readjusted by using adjusting screw [1]. In this way, the position of the point of pressure (i.e., the resistance you feel on the hand brake lever when the brake pads are pressed against the brake disc) can be adjusted for any hand size.

! CAUTION

At the hand brake lever, free travel must at least be 3 mm (0.12 in). Only then may the piston in the hand brake cylinder be moved (to be recognized by the greater resistance of the hand brake lever). If this free travel is not provided, pressure will build up in the braking system, and the front wheel brake may fail due to overheating.

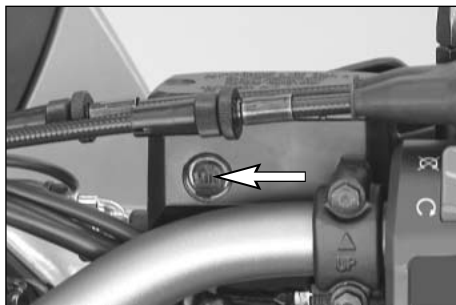

Checking of brake fluid level - front brake

The brake fluid reservoir is linked with the hand brake cylinder at the handlebar and the reservoir is provided with an inspection glass. With the reservoir in a horizontal position, the brake fluid level should not go below middle of the glass.

⚠ WARNING

- If the brake fluid level drops below the minimum either the brake system has a leak or the brake pads are completely worn down. In this case, consult an authorized KTM dealer immediately.
- Have the brake fluid changed at an authorized KTM workshop every 2 years.

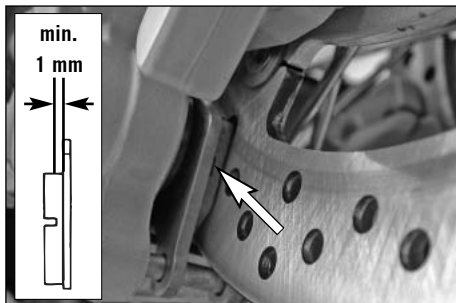

Checking the front brake pads

The brake pads can be inspected from below. The linings must be at least 1 mm (0.04 in) thick.

⚠ WARNING

At their most worn point brake pad linings should not be thinner than 1 mm, otherwise they could lead to brake failure. For your own safety don't put off having your brake pads changed.

! CAUTION

If the brake pads are replaced too late when the lining is partly or completely worn off, the steel parts on the brake pads will grind against the brake disks. This significantly decreases the braking effect and destroys the brake disks.

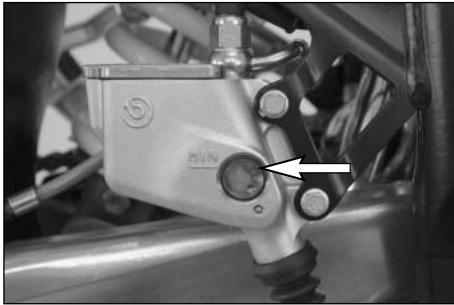

Checking rear brake fluid level

The brake fluid reservoir for the rear disk brake is combined with the foot brake cylinder and has an inspection window. The brake fluid level should not drop below the "MIN" mark when the motorcycle is in a vertical position.

WARNING

- If the brake fluid level drops below the minimum either the brake system has a leak or the brake pads are completely worn down. In this case, consult an authorized KTM dealer immediately.
- Have the brake fluid changed at an authorized KTM workshop every 2 years.

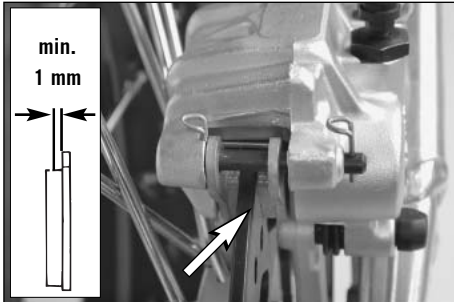

Checking the rear brake pads

The brake pads can be inspected from the rear. The thickness of the linings may not be less than 1 mm (0.04 in).

WARNING

At their most worn point brake pad linings should not be thinner than 1 mm, otherwise they could lead to brake failure. For your own safety don't put off having your brake pads changed.

CAUTION

If the brake pads are replaced too late so that the lining is partly or entirely worn away, the steel components of the brake pad will rub against the brake disc, impairing the braking effect and destroying the brake disc.

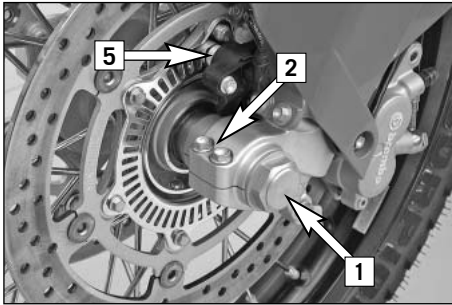

Dismounting and mounting the front wheel

Jack the motorcycle up at the underride protection until the front wheel no longer touches the ground.

Loosen the collar screw [1] and the clamp screws [2] at both fork leg axle passages. Unscrew the collar screw approx. 8 turns, pressing your hand against the collar screw to push the axle passage out of the fork leg and remove the collar screw. Hold the front wheel and pull out the axle passage. Slightly pull one brake caliper out and take the front wheel off the fork.

Take the left [3] and right distance bushing out of the shaft seal rings.

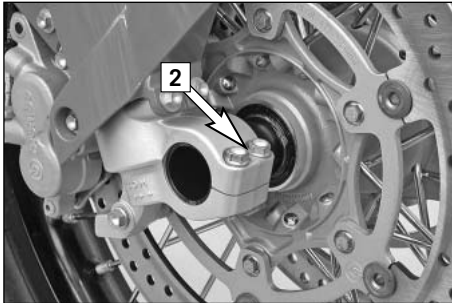

! CAUTION

- Do not operate the hand brake when the front wheel has been dismantled.
- When you lay the wheel down, make sure the brake disks and (for models with ABS) the ABS sensor wheel are not damaged.
- Models with ABS: when you dismount and mount the front wheel, make sure that you do not damage the ABS sensor [5] and do not bend the ABS sensor wheel.

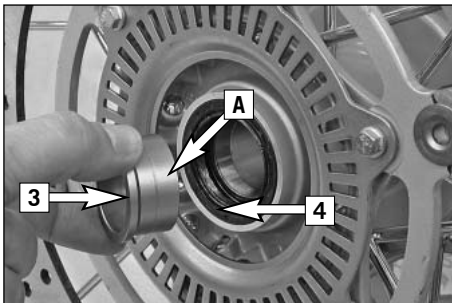

Before remounting the front wheel, clean and grease the shaft seal rings [4] and the bearing surface [A] of the distance bushings and mount the distance bushings (wide distance bushing in the left shaft seal ring). Slightly push back the brake pads with a screwdriver. Set up the front wheel facing in the running direction (see arrow [B] on the tire).

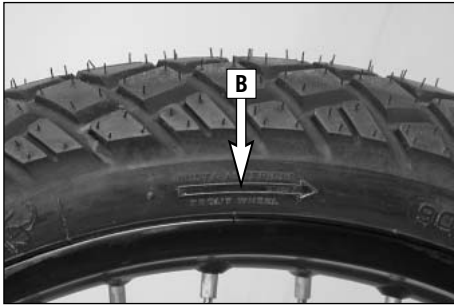

To mount the front wheel, lift the wheel into the fork, slightly pull one brake caliper out and push the tire in between the brake calipers. Insert the brake disks in the brake calipers and mount the axle passage.

Mount the collar screw [1] and tighten slightly. Tighten the clamp screws [2] on the right fork leg axle passage (in the direction of travel) tighten to prevent the axle passage from turning and tighten the collar nut to 60 Nm.

Loosen the clamp screws on the right fork leg axle passage, take the motorcycle off the stand, actuate the front wheel brake and vigorously compress the fork several times to align the fork legs.

Now you can tighten the clamp screws on both fork leg axle passages to 15 Nm.

WARNING

- If you do not have a torque wrench to mount the wheel, have the torques corrected by an authorized KTM workshop as soon as possible. A loose axle passage can cause the motorcycle's handling performance to become instable.
- After mounting the front wheel, keep operating the hand brake until the pressure point returns.
- Always keep the brake disks free from oil and grease, otherwise the braking effect will be significantly reduced.

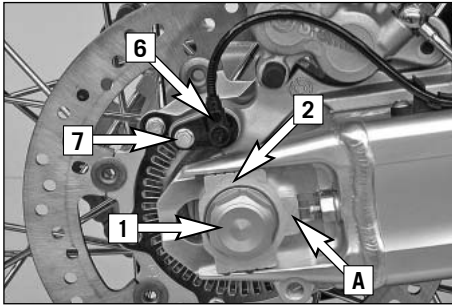

Dismounting and mounting the rear wheel

NOTE FOR MODELS WITH ABS (ANTILOCK BRAKE SYSTEM):

The ABS sensor [6] can be removed to make it easier to dismount and mount the rear wheel. Loosen the HH screw [7] and pull out the ABS sensor. When remounting, apply Loctite 243 (screw retainer) to the thread, mount the screw and tighten to 8 Nm.

Set the motorcycle on the center stand to keep the rear wheel from touching the ground. Unscrew the collar nut [1], remove the chain tensioner [2], hold on to the rear wheel while you pull out the axle passage [3]. Push the rear wheel as far to the front as possible, take the chain off of the rear sprocket and lay it on the rear sprocket guard. Carefully lift the rear wheel out of the swing arm.

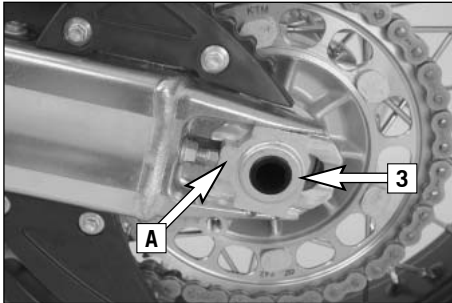

! CAUTION

- Do not operate the rear brake when the rear wheel has been dismounted.
- When you lay the wheel down, make sure the brake disk and (for models with ABS) the ABS sensor wheel are not damaged.
- If the axle is dismounted, clean the thread of the wheel spindle and collar nut thoroughly and apply a new coat of grease (Motorex Long Term 2000) to prevent the thread from jamming.
- Models with ABS: when you dismount and mount the rear wheel, make sure that you do not damage the ABS sensor [6] and do not bend the ABS sensor wheel.

Before remounting the rear wheel, clean and grease the bearing surface of the bushings [4] and the shaft seal ring [5].

The rear wheel is remounted in reverse order. Pay attention to the same mounting position of the axle passage and the chain tensioner and make sure the noses [A] point to the front. Before tightening the collar nut to 90 Nm, push the rear wheel forwards so that the chain tensioners lie on the tension screws.

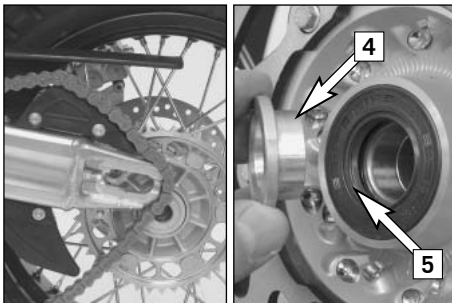

⚠ WARNING

- If you don't happen to have a torque wrench at hand, make sure you have the tightening torque corrected by a KTM dealer as soon as possible. A loose wheel spindle may lead to an unstable driving behavior of your motorcycle.
- After mounting the rear wheel, keep operating the footbrake until the pressure point returns.
- It is very important to keep the brake disk free from oil and grease, otherwise the braking effect would be strongly reduced.



Tires, air pressure

Tire type, tire condition, and how much air pressure the tires have in them affect the way your motorcycle rides, and they must therefore be checked whenever you're getting ready to go anywhere on your motorcycle.

⚠ WARNING

- Only use tires authorized by KTM to guarantee driving safety and maximum handling performance (tire releases are available on the Internet at www.ktm.com). Other tires can have an adverse effect on the vehicle handling (e.g. „wobbling“ at high speeds) and the stopping distance.
- Do not exceed the respective maximum speed for tires designed with a speed index of less than „V“ (240 kph, 150 miles/h). A sticker showing the maximum speed must be affixed to the motorcycle within the driver's field of vision.

TIRES – AIR PRESSURE	front	rear
Road, driver only	2.4 bar (34psi)	2.6 bar (37psi)
Road, with passenger	2.4 bar (34psi)	2.8 bar (40psi)
maximum payload	2.4 bar (34psi)	2.8 bar (40psi)

- Tire type and size can be found in the technical specifications and in the homologation certificate.
- Tire condition has to be checked every time you want to ride your motorcycle. Before leaving check for punctures and nails or other sharp objects that might have become embedded in the tire.
- Refer to the specific regulations in your country for minimum tire tread requirements. We recommend replacing tires at the latest when the tread is down to 2 mm (0.08 in).
- Tire pressure should be checked regularly on a “cold” tire. Adapt the air pressure to the motorcycle's total weight. Proper pressure ensures optimum driving comfort and extends the life of your tires.

⚠ WARNING

- Do not mount tires which have not been approved by KTM. Other tires could have adverse effects on the way your motorcycle rides.
- Models with ABS (antilock brake system): do not mount wheels with a different rim diameter. The ABS function can no longer be guaranteed.
- Models with ABS: The ABS is designed to be used with the tires authorized by KTM and works best with these tires. The ABS function cannot be guaranteed if other tires are used.
- Use tires of the same brand and type for the front and rear wheels.
- For your own safety replace damaged tires immediately.
- Worn tires can have a negative effect on how your motorcycle performs, especially on wet surfaces.
- If air pressure is too low, abnormal wear and overheating of the tire can result.

WARNING

- Models with ABS: an incorrect tire pressure will have an adverse effect on the ABS control and driving stability and will increase the stopping distance.
- New wheels have a smooth surface, which means that they must be run in to achieve full grip. For this purpose, ride the motorcycle carefully at moderate speed during the first 200 kilometers (125 miles) with new tires, tilting the vehicle at different angles so that all sections are properly roughened. Tires will not display their full grip characteristics until they are properly run in.
- For reasons of safety, it is recommended to exchange the valve insert whenever a new tire is mounted.



Checking spoke tension

The correct spoke tension is very important for the stability of the wheels and thus for riding safety. A loose spoke causes the wheel to become unbalanced and before long other spokes will have come loose. Check spoke tension, especially on a new motorcycle, in regular intervals. For checking, tap on each spoke with the blade of a screw driver (see illustration). A clear tone must be the result. Dull tones indicate loose spokes. If necessary, have the spokes retightened and the wheel centered by a KTM dealer.

WARNING

- If you continue to drive with loose spokes, the spokes can tear and lead to an instable handling performance. Torn spokes can damage the air hose. The loss of air can easily cause the motorcycle to go out of control.
- Excessively tensioned spokes may rupture due to local overloading. The spokes must be tensioned to $5 \text{ Nm} \pm 1 \text{ Nm}$.



Battery

The battery is located in the underride protection in front of the engine and is maintenance-free. It is not necessary to check the electrolyte level or to refill water. Simply keep the battery poles clean and slightly grease them with an acid-free grease if necessary. The charge condition and type of charge are very important for the battery's service life.

WARNING

Never operate the motorcycle with a run-down battery or without the battery. This can damage the electronic components or safety equipment in either case and the motorcycle will no longer be roadworthy.

CAUTION

Do not remove the locking strip [1] otherwise the battery will be damaged.

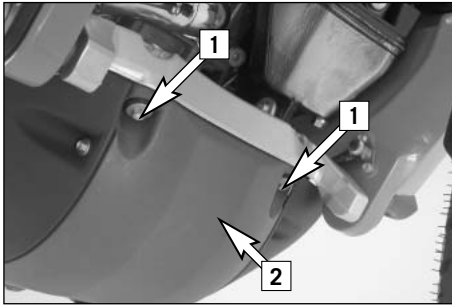

Demounting and mounting the battery

The battery does not need to be demounted unless the motorcycle is being immobilized. To demount the battery, remove the screws [1] and fold the underride protection [2] down. Remove the screws [3] and tilt the battery cover [4] to the front. First disconnect the negative pole and then the positive pole. Remove the battery cover and remove the battery together with the battery case.

Recharge the battery before and after storage. Storage temperature: 0 - 35°C (32 - 95°F).

To mount, place the battery and battery case in the battery compartment and mount the battery cover. First connect the positive pole, then the negative pole to the battery to avoid a short circuit. Fold the battery cover up and fasten with 2 screws. Fold the underride protection up, apply Loctite 243 (screw retainer) to both screws, mount the screws and tighten to 25 Nm (19 ft.lbs).

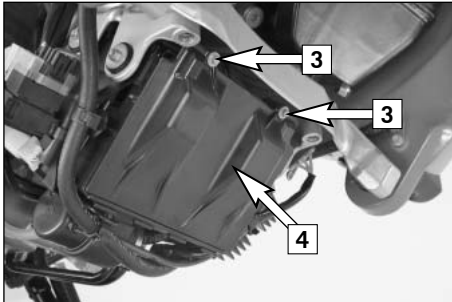

⚠ WARNING

- If electrolyte (sulphuric acid) leaks from the battery, proceed with great care. The electrolyte can cause severe burns.
- In the case of skin contact rinse thoroughly with water.
- In the case of contact with the eyes, thoroughly rinse eyes with water for at least 15 minutes. Immediately consult a doctor.
- The battery is a closed model but can nevertheless emit explosive gases. Avoid sparks and open fire near the battery.
- Defective batteries must be stored out of the reach of children. Ensure proper disposal of discarded batteries.
- The screws on the underride protection must be secured with loctite 243 to prevent them from becoming loose.

! CAUTION

Never disconnect the battery while the engine is running. This will destroy the rectifier-regulator.

STORAGE:

If the motorcycle is being immobilized for longer periods of time, remove and charge the battery. Storage temperature 0 - 35°C (32 - 95°F), avoid direct sunlight.

Charge the battery every 3 months.



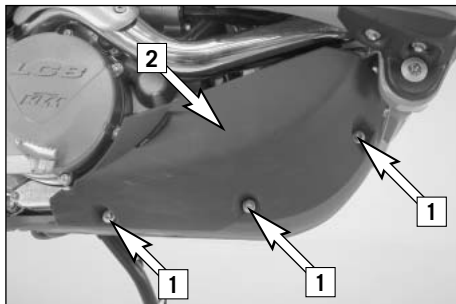

Charging the battery

The battery does not need to be dismantled to charge. Remove the screws [1] and the engine cover [2]. Remove the red protection cover and connect the charging device with the positive terminal post at screw [3] and the negative terminal post at screw [4]. Charge the battery as specified in the following table. Do not exceed the amperage and charging times. Quick charges with high amperages will have an adverse effect on the battery's service life.

BATTERY CHARGE			
normal	1.1 amperes	5 - max. 10 hrs.	max. 14.4 volts
quick	5.5 amperes	max. 1 hr.	max. 14.4 volts

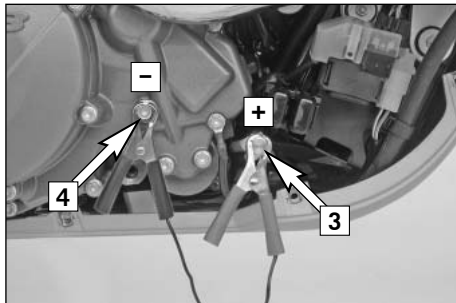

To charge the battery while mounted, always use the KTM battery charger (Item no. 58429074000) to ensure that the electric system is not damaged by excess voltage. **Always remove the battery if using other battery chargers!** You can also use this charging device to test the off-load voltage and startability of the battery and generator. It is impossible to over-charge the battery with this device.

Charge the battery immediately if it is empty when you start the motorcycle. If left to stand in an uncharged condition for a longer period of time, the battery will run down and sulfatize, destroying the battery.

Recharge the battery every 3 months if it is being stored for a longer period of time.

! CAUTION

- Do not remove the locking strip otherwise the battery will be damaged.
- To charge, connect the battery to the battery charger before you switch on the battery charger. When the battery is charged, switch off the battery charger before you disconnect the battery.
- Provide adequate ventilation when charging the battery in a closed room; the battery emits explosive gases when charging.
- Electrolytes will escape through the safety valves if the battery is charged too long or at an excessive voltage or amperage. This will reduce battery capacity.
- Try to avoid quick charges.



Jump start

Jump starts are not recommended since they can damage the motorcycle's electronic system.

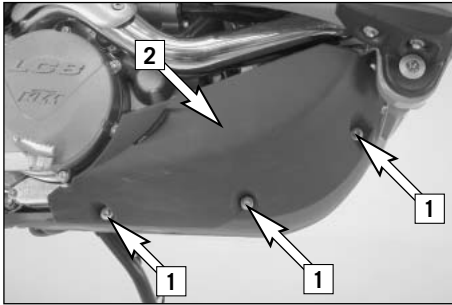

Main fuse

The main fuse protects all of the motorcycle's current consumers. The main fuse is located in the starter relay under the right engine cowl. Remove the screws [1] and take off the engine cowl [2].

⚠ WARNING

Do not burn yourself on the hot exhaust pipe.

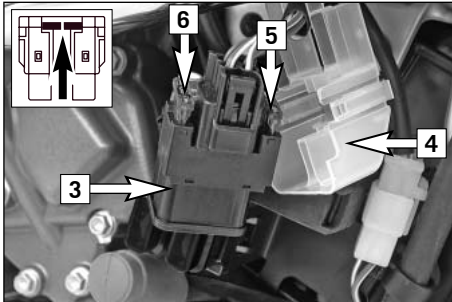

Lift the starter relay [3] out of the bracket, remove the cap [4] and check the main fuse [5]. A spare fuse [6] (30 ampere) is also plugged into the starter relay. Replace a blown fuse only with an equivalent one. Visit an authorized KTM workshop if the new fuse blows again.

! CAUTION

Under no circumstances is a stronger fuse allowed to be set in or a fuse allowed to be "repaired". An inexpert treatment could damage the whole electrical installation!

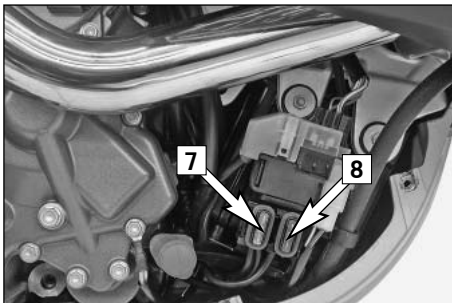

ABS fuses – models with ABS (antilock brake system)

Two fuses for the ABS are located under the starter relay. Remove the caps and check the fuses [7] and [8]. Replace blown fuses with the same type of fuse. Visit an authorized KTM workshop if the new fuse blows again.

! CAUTION

Under no circumstances is a stronger fuse allowed to be set in or a fuse allowed to be "repaired". An inexpert treatment could damage the whole electrical installation!

Spare 25 and 40-ampere fuses are located next to the fuse box in the storage compartment in front of the seat.

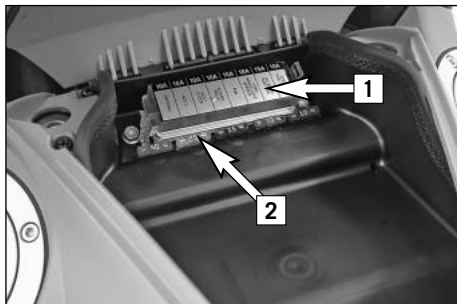

Fuses for individual current consumers

A fuse box with additional fuses is mounted in the storage compartment to separately protect the current consumers against short circuits.

The current consumers and the corresponding fuse capacities are listed on the cover of the fuse box [1]. Spare 10, 15, 25 and 40-ampere fuses [2] are also located next to the storage compartment.



Replace a blown fuse only with an equivalent one. Visit an authorized KTM workshop if the new fuse blows again.

! CAUTION

Under no circumstances is a stronger fuse allowed to be set in or a fuse allowed to be “repaired”. An inexpert treatment could damage the whole electrical installation!

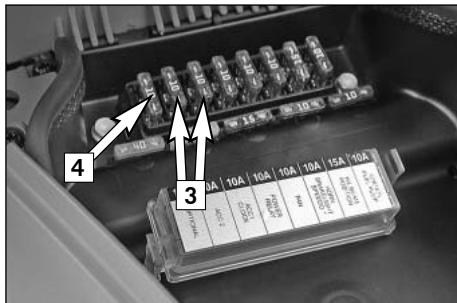

The ACC 1 / CLOCK and ACC 2 fuses [3] are designed for accessory equipment with a maximum current consumption of 10 amperes each. The respective connectors for this equipment are provided under the headlight cover. For more information, contact an authorized KTM workshop.

NOTE FOR MODELS WITH ABS:

The ABS OPTIONAL fuse [4] is the fuse for the ABS.

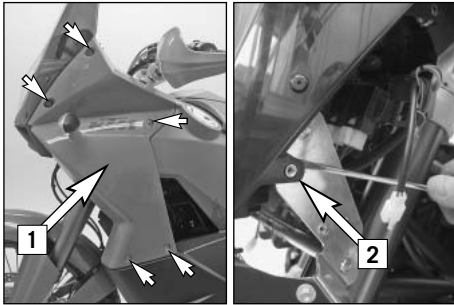

Replacing the headlight lamps

Remove the 5 screws on the left and right and take off both side covers [1]. Use a screwdriver to detach the retaining tabs [2], tilt the windshield and headlight forward and pull the connector off the connector support. Place the headlight on a soft pad to keep it from being damaged.

! CAUTION

Never touch the glass of the bulb with your fingers. The glass of the bulb must remain absolutely free from grease. Heat will otherwise cause the grease to evaporate and settle down on the reflector.

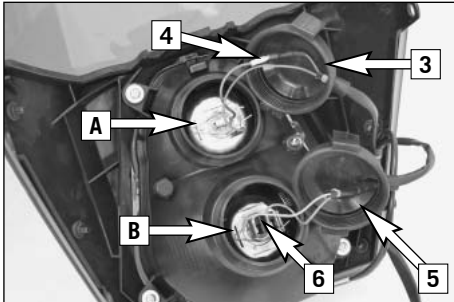

HIGH BEAM BULB [A] :

Remove the rubber cap [3] and pull off the connector [4]. Detach the retaining clip and remove the bulb.

Insert a new bulb (see Technical specifications – Chassis / Lighting), fit the retaining clip, connect the connector and mount the rubber cap.

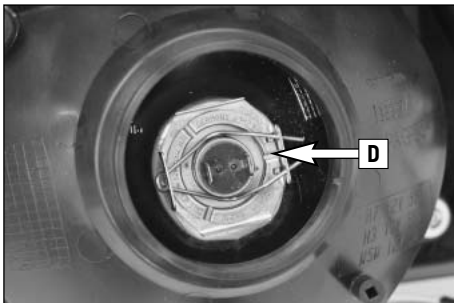

LOW BEAM BULB [B] :

Remove the rubber cap [5] and pull off the connector [6]. Detach the retaining clip and remove the bulb.

When inserting the new bulb (see Technical specifications – Chassis / Lighting), make sure tab [D] is firmly seated in the socket recess.

Fit the retaining clip, connect the connector to the bulb and mount the rubber cap.

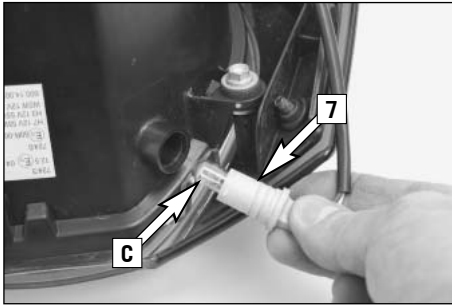

PARKING LIGHT BULB [C] :

Pull the bulb socket [7] out of the reflector and pull the bulb out of the bulb socket.

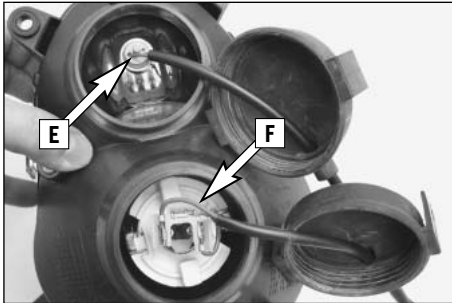

USA design:

The parking light [E] is located in the upper part of the headlight in the USA design. Bulb [F] (see Technical specifications – Chassis / Lighting) with high and low beams is mounted in the lower part of the headlight.

Connect the connectors to the connector support to check all of the bulbs for proper functioning before you remount the headlight.

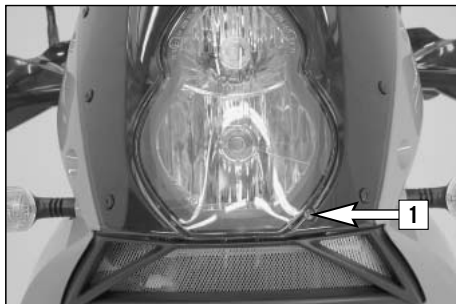

Adjusting the headlight range

The payload can make it necessary to correct the headlight range. The headlight range can be adjusted with the adjusting screw [1]. Turning in a clockwise direction will increase the headlight range, turning in a counterclockwise direction will reduce the headlight range.

TO CHECK:

Make a mark on a light wall behind a level surface at a height of 830 mm (32.7 in) (990 Adventure S) or 790 mm (31.1 in) (990 Adventure) respectively. Position your motorcycle loaded ready for the trip (baggage, driver, passenger) 10 meters away from the wall and switch on the low beam. The light/dark cut-off line should be at the mark.

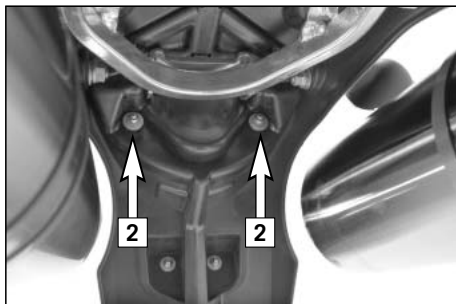

Replacing the brake and tail light bulbs

Remove the hexagon nuts [2] on the bottom of the fender and pull the tail light off towards the rear.

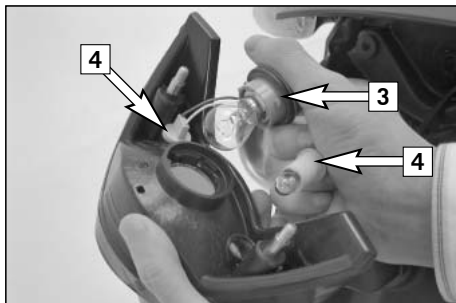

BRAKE LIGHT BULB:

Turn the lamp socket [3] approximately 30° counterclockwise and pull it out of the tail light housing. Slightly depress the bulb, turn it approx. 30° counterclockwise and pull it out of the socket.

To mount the lamp reverse the worksteps indicated above.

TAIL LIGHT BULBS:

Pull the socket [4] out of the housing and pull the bulb out of the socket.

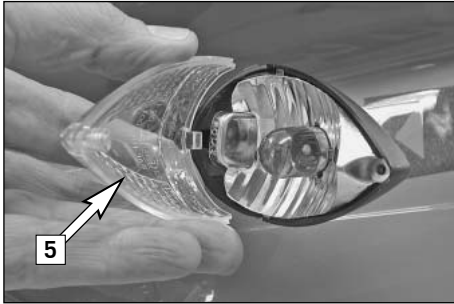

Replacing the flasher bulbs

Remove the screw on the back of the turn signal, carefully fold the lens [5] towards the motorcycle and remove.

Slightly depress the bulb, turn it approx. 30° counterclockwise and pull it out of the socket.

To mount the lamp reverse the worksteps indicated above.

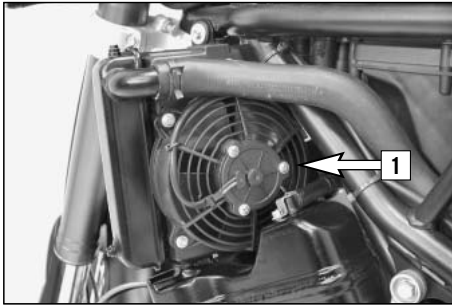

Cooling system

The water pump in the engine ensures a forced circulation of the cooling liquid. When the engine is cold, the cooling liquid only circulates in the cylinders and cylinder heads. The thermostat will open when the engine reaches approx. 75°C (167°F) and the cooling liquid will also be pumped through the aluminum radiator.

Cooling is by means of the air stream. The lower the speed, the lower the cooling effect. Soiled cooling fins also impair the cooling effect.

If, for example, slow urban traffic or waiting at a traffic light cause little or no air to stream through the radiator, the temperature of the cooling liquid will rise. The radiator fan [1] switches on when the cooling liquid reaches a temperature of 102°C (216°F). Additional air is blown through the radiator to prevent the cooling system from overheating.

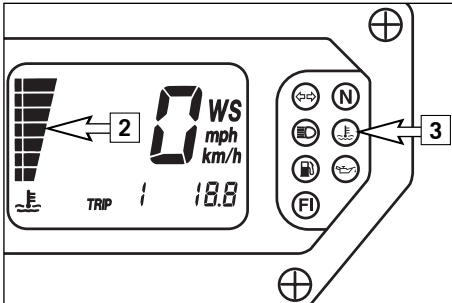

! CAUTION

The temperature indicator [2] will begin to blink and the red cooling liquid temperature warning lamp [3] will light up when the cooling liquid reaches approx. 120°C (248°F), having exceeded the normal operating temperature.

Possible causes:

- **Slow riding with large loads at a higher air temperature:**
If possible increase your running speed, so that more air can blow through the radiators. Should the warning light still be on after 1500 meters (1 mile), stop immediately, switch off the engine and look for other possible causes.
- **The cooling fan on the radiator is not working:**
The cooling fan must be running, when the cooling liquid temperature is 120°C (248°F) and the ignition is on. If the fan is not working, and there appears to be sufficient cooling liquid, the only thing you can do is to drive on to your nearest authorized KTM workshop at the least possible engine load.
- **Too little cooling liquid in the system:**
Check whether any cooling liquid is leaking out (also on the bottom of the motorcycle). Let the engine cool down and check the cooling liquid level in the radiator (see chapter Checking the cooling liquid level in the radiator). Only continue to drive if there is enough cooling liquid in the system. Contact an authorized KTM workshop to have the error eliminated. You will damage the engine if you continue to drive when the cooling liquid temperature warning lamp is on.
- **Excessive use of the clutch at slow speed.**

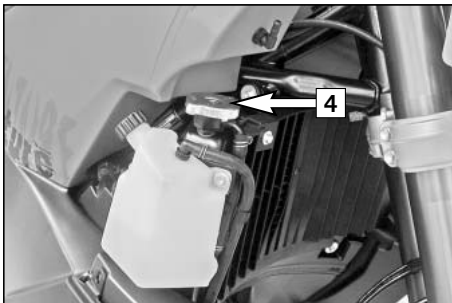

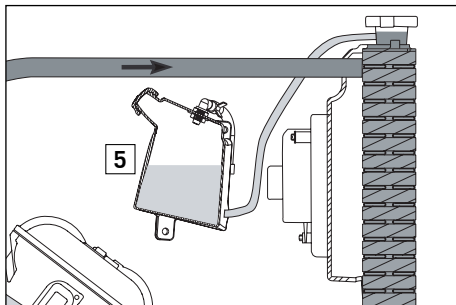

A mixture of 50% antifreeze and 50% distilled water is used as the cooling liquid. However, the anti-freeze protection must be at least -25°C (-13°F). Aside from antifreezing protection, this mixture also provides great corrosion protection which is why it must not be replaced by pure water.

! CAUTION

- For the cooling system, use only high-grade antifreezer (Motorex Anti-Freeze). Using low-grade antifreeze agents, can cause corrosion and coolant foaming.
- More antifreeze must be added if you plan to travel to a region where temperatures are expected to drop below -25°C (-13°F).

Pressure induced by heating of the cooling liquid in the cooling system is controlled by a valve in the radiator cap [4]; a water temperature rising up to 125°C (257°F) is admissible, without fear of problems.

Any excess cooling liquid caused by thermal expansion is conducted to the compensating tank [5]. It will be sucked back in as soon as the temperature in the cooling system drops.

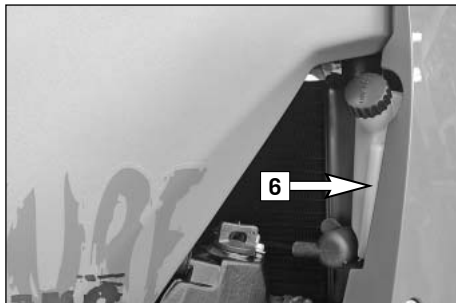

Checking the cooling liquid level in the compensating tank

Check the level of the cooling liquid when the engine is cold. It should fall between the MIN and MAX marks on the compensating tank [6].

Add cooling liquid (see above for mixture ratio) if the cooling liquid level drops below the MIN mark.

If you need to add cooling liquid quite often, the cooling system may leak. If the compensating tank is empty, also check the cooling liquid level in the radiator. Have the cooling system checked by an authorized KTM workshop.

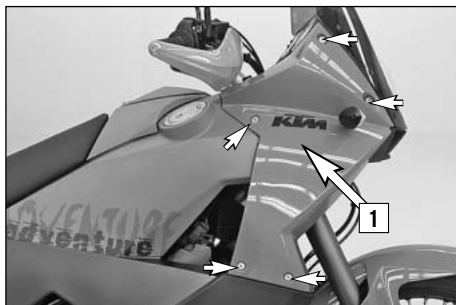

Checking the cooling liquid level in the radiator

Remove the 5 screws and the right cover [1], disconnect the flasher cable and tank ventilation.

⚠ WARNING

If possible, always check level of cooling liquid when engine is cold. If you have to open the radiator cap when engine is hot, use a rag to cover the cap and open slowly to release pressure.

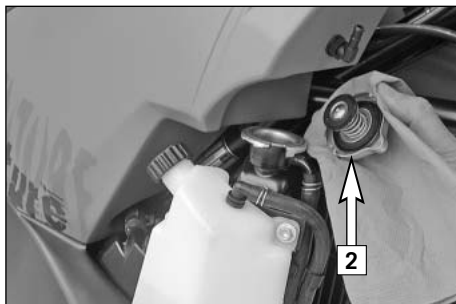

Carefully remove the radiator cap [2] with a rag, turning in a counterclockwise direction. The radiator should be completely filled with cooling liquid. No air should be in the radiator.

If any cooling liquid is missing, the cooling system may leak. Have the cooling system checked by an authorized KTM workshop.

! CAUTION

If more than 1 liter (0.26 USgal) of cooling liquid needs to be added, the cooling system must be bled.

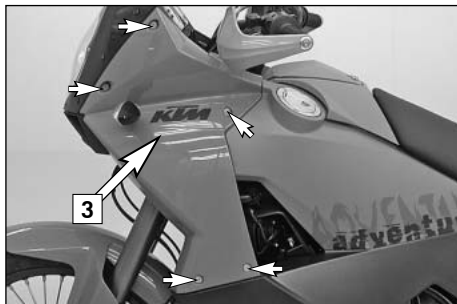

Bleeding the cooling system

Remove the 5 screws and the left cover [3], disconnect the flasher cable and tank ventilation.

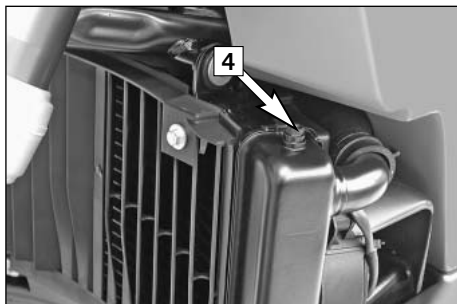

Remove the bleeder screw [4] on the left side of the radiator.



To be able to completely bleed the cooling system, raise the motorcycle approx. 50 cm in the front.

Add cooling liquid until it runs out of the discharge opening without bubbles and immediately mount the screw to prevent more air from getting into the radiator. Completely fill the radiator with cooling liquid.

Connect the flasher cable and tank ventilation. Mount the cover. Take a short ride and check the cooling liquid level again.

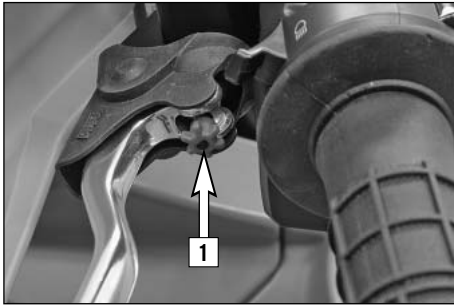

Changing the original position of the clutch lever

The adjusting screw [1] can be used for individual adjustment of the original position of the clutch lever, thus allowing adjustment to an optimal position for every hand size. Turning the adjusting screw counterclockwise reduces the distance between the clutch lever and the handlebar. Turning the adjusting screw clockwise increases the distance between the clutch lever and the handlebar.

! CAUTION

Adjustment of the clutch lever position is only possible within certain limits. Only turn the adjusting screw manually and never apply excessive force.

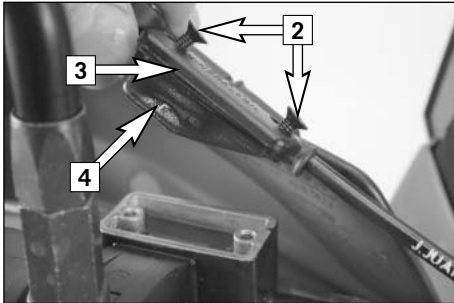

Checking the oil level of the hydraulic clutch

To check the oil level in the master cylinder of the clutch remove the cover. For this purpose, remove screws [2] and cover [3] together with the rubber boot [4]. The oil level in the horizontal-standing master cylinder should be 4 mm below the upper edge. If necessary, add SAE 10 biodegradable hydraulic oil (Motorex clutch fluid 75), available from your authorized KTM workshop.

! CAUTION

KTM uses biodegradable, hydraulic mineral oil to actuate the hydraulic clutch. Do not mix this oil with any other hydraulic oil. Always use original KTM hydraulic oil (available from your authorized KTM workshop) to make sure your clutch operates smoothly. Never refill with brake fluid.

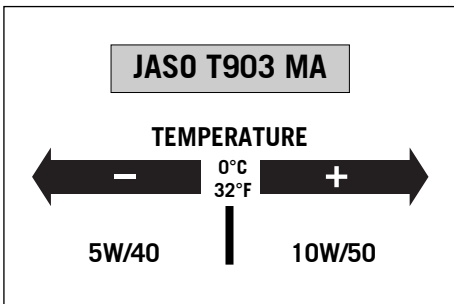

Engine oil

Automobile engine oil used to be used for four-stroke motorcycles before there were separate motorcycle specifications. Different technical developments made it necessary to have a separate specification for four-stroke motorcycles - the JASO T903 MA standard. Whereas car engines require long changing intervals, motorcycle engines require a higher power output at higher speeds. Most motorcycle engines also use the same oil to lubricate the transmission and the clutch. The JASO MA standard responds to these special requirements. Only use fully synthetic engine oils that meet the JASO MA quality requirements (see information on the can).

KTM recommends Motorex Power Synt 4T in the 10W/50 viscosity (for temperatures over 0°C, 32°F) or 5W/40 (for temperatures under 0°C, 32°F).

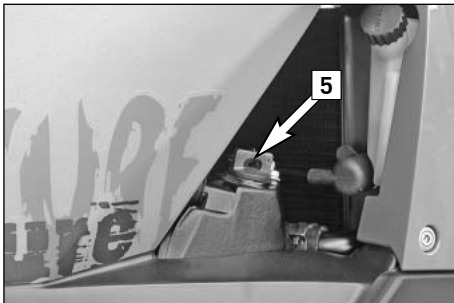

Checking the engine oil level

Check the engine oil level when the engine is warm (at least 4 bars on the temperature indicator light up). Allow the warm engine to run idle for approx. 1 minute and motorcycle place the motorcycle on a level surface (not on the side stand).

Turn off the engine, unscrew the oil dipstick [5] and wipe off with a cloth. **Screw the oil dipstick all the way back in** and back out again.

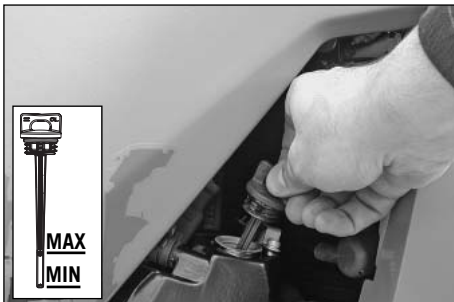

The oil level should fall between the lower end of the oil dipstick (MIN) and the MAX mark. The oil capacity between the MIN and MAX mark is 0.5 liters (0.13 USgal). Add more engine oil if necessary and check the engine for leakage.

! CAUTION

- Insufficient amounts of or low-grade engine oil lead to premature wear in the engine.
- Do not overfill the engine case.
- Do not underfill the engine case.

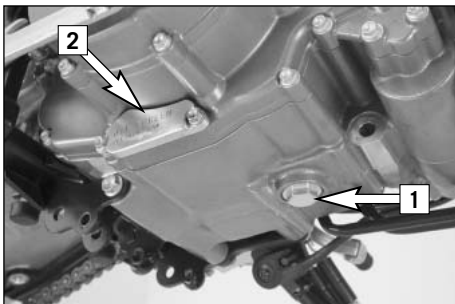

Changing the engine oil and the oil filter, cleaning the oil screen

! CAUTION

You may only change the engine oil yourself after the warranty period has expired. The warranty will become void if you change the oil yourself during the warranty period.

NOTE: The LC8 engine has a dry-sump lubrication system. The engine oil is pumped from the oil sump in the engine case to the oil tank. The engine oil must also be drained from the oil tank during an oil change. Since many parts must be demounted for an oil change, we recommend having the engine oil changed by an authorized KTM workshop. During the guaranty period, the oil change must be performed by an authorized KTM mechanic. Otherwise, the guarantee will become void.

The engine oil change is to be carried out when the engine is still warm.

⚠ WARNING

An engine having been run warm, and the engine oil in it is very hot – do not burn yourself.

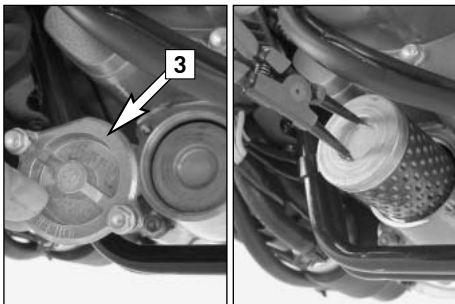

Place the motorcycle on a level surface. Remove the 4 screws, take off the underride protection and place a receptacle for the used oil under the engine. Remove the oil drain plug [1], take off the cap [2] and pull the oil sieve out of the engine case with a pair of pliers.

Remove the oil filter cover [3] and pull the oil filter out of the engine case with circlip pliers (upside-down).

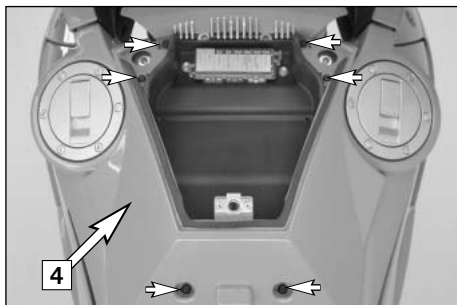

Remove the 6 screws and the cover [4].

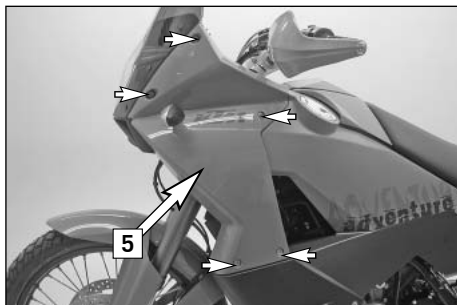

Remove the 5 screws, take off the left panel [5] and disconnect the turn signal cable.

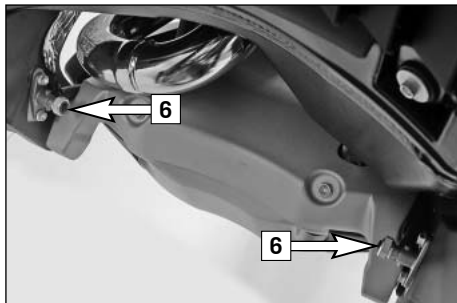

Close both fuel taps [6] on the connecting line.

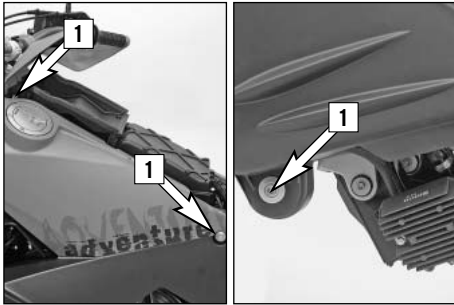

Remove the 3 screws [1], lift the tank approx. 15 mm and carefully tilt to the side. Disconnect the fuel lines, disconnect the connector for the fuel pump and the pickup cable (fuel level) and set down the tank.

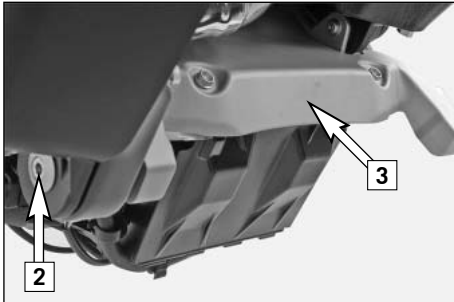

Remove the lower screw [2] on the right tank. Remove the HH screws and take off the battery cover [3].

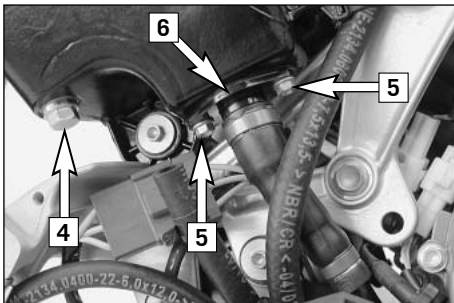

Remove the drain plug [4] on the oil tank and allow the oil to drain into a receptacle. Remove the screws [5] and tilt the oil return valve [6] to the side.

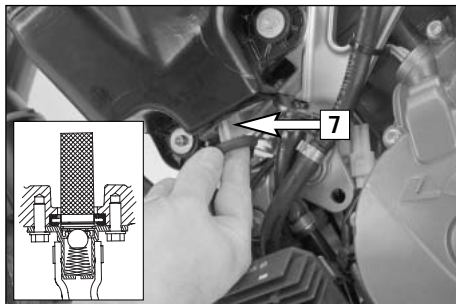

Carefully pull the oil screen [7] out of the oil tank.

Thoroughly clean the drain plugs, the cover and both oil screens. Clean all rubber seal rings and check for damage. Replace if necessary.

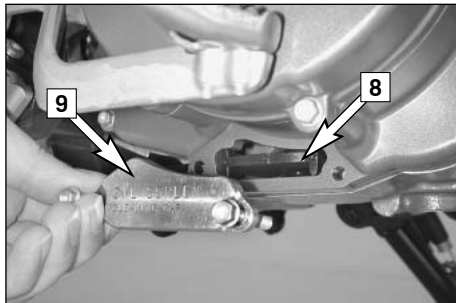

Mount the oil drain plug on the engine with a new seal ring and tighten to 20 Nm.

Slide the oil screen [8] into the guides in the oil pump housing with the TOP mark facing up. Make sure the form ring is in place and mount the cap [9]. Tighten the screws to 10 Nm.



Insert a new oil filter [1] in the engine case, grease the O-ring and mount the oil filter cover together with the O-ring. Tighten the screws to 6 Nm.

! CAUTION

Only use original KTM oil filters. The engine can be damaged if other filters are used.

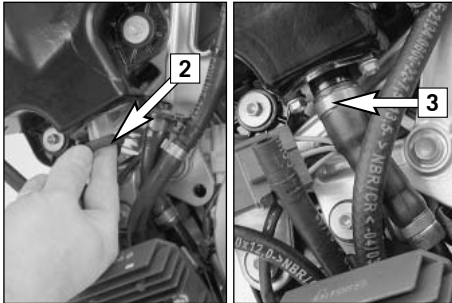

Mount the oil drain plug on the oil tank with a new seal ring and tighten to 20 Nm.

Grease the seal ring [2] and carefully slide the oil screen into the oil tank. Position the oil return valve [3], mount the screws and tighten to 10 Nm.



Mount the battery cover and tighten the screws to 25 Nm. Mount the lower screw on the right tank and tighten to 25 Nm.

Attach the left tank to the upper bracket. Connect the fuel lines and connector for the fuel pump and the pickup cable (fuel level). Fasten the tank with 3 screws and tighten the screws to 25 Nm.

Open both fuel taps and the connecting line.



Add 2.5 liters (0.7 USgal) of fully synthetic engine oil meeting the JASO MA standard (e.g. Motorex Power Synt 4T) and mount the oil dipstick. Start the engine, allow to run warm for 4 minutes and switch off the engine. Remove the oil dipstick and add engine oil up to the MAX mark (approx. 0.5 liters, 0.13 USgal).

Check the engine and the oil tank for oil leakage.



Apply Loctite 243 to the thread of the 4 screws, mount the underride protection and tighten the screws to 25 Nm.

! CAUTION

The screws on the underride protection must be secured with loctite 243 to prevent them from becoming loose.

Connect the turn signal cable and the tank vent hose and mount the left panel. Mount the storage compartment cover.

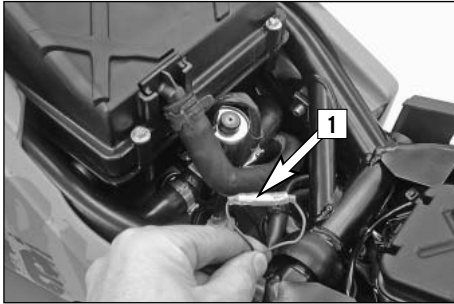

Activating the ignition curve for low-octane fuel

If you are traveling to a country where fuel having at least 95 octane (RON) is not available, you can easily activate the corresponding ignition curve.

A plug and socket connection [1] on a brown/black cable is located near the upper shock absorber holder .

If the two connectors are connected to each other, the ignition curve for fuel having at least 95 octane (RON) is activated.

If you disconnect the plug and socket connection, the ignition curve for fuel having 80 - 94 octane (RON) is activated. Although this causes the engine to lose some of its power output, it prevents poor glow ignitions and engine damage.

! CAUTION

If fuel having at least RON 95 (USA = Premium PON 91) is not available, the ignition curve for 80 - 94 octane (RON) must be activated to prevent engine damage.

If you have your motorcycle serviced as set forth in this manual, no malfunctioning is to be expected. Nevertheless, if an error does arise, we recommend that you look for the error according to the following chart.

Please note that you cannot perform all of the work yourself. If you are not sure, contact your KTM dealer.

TROUBLE	CAUSE	REMEDY
Engine does not start when the starter button is actuated	Operating error	Turn on the ignition, switch the gear to neutral and switch the emergency OFF switch on, do not accelerate while starting the engine.
	Discharged battery	Recharge the battery and investigate the causes for discharging; contact an authorized KTM workshop.
	Blown fuse IGNITION.	Replace fuse IGNITION
	Main fuse is blown	Remove the engine cowl and replace the main fuse
	Defect ignition lock or emergency OFF switch	Check ignition lock and emergency OFF switch, contact an authorized KTM workshop.
The engine cranks only with pulled clutch lever	A gear is engaged	Shift the transmission to neutral.
	A gear is engaged and the side stand is still folded down	Shift the transmission to neutral.
	Defect safe-starting system.	Contact an authorized KTM workshop.
Engine cranks with gear engaged	Defect safe-starting system	Contact an authorized KTM workshop.
Engine cranks but doesn't start.	Operating error	Pay attention to starting off information (see driving instructions).

TROUBLE	CAUSE	REMEDY
Engine cranks but doesn't start.	<p>Blown fuse for the fuel pump</p> <p>Clutch not attached to the fuel line</p> <p>The plug and socket connector on the wiring harness is oxidized</p> <p>Error in the injection system</p> <p>A gear is engaged and the side stand is folded down</p>	<p>Replace the FUEL PUMP fuse</p> <p>Connect the clutch to the fuel line</p> <p>Remove the panel and fuel tank, clean the plug and socket connector and spray with contact spray</p> <p>Visit an authorized KTM workshop</p> <p>Switch to neutral gear</p>
Engine will not reach full power	<p>Air filter/fuel filter heavily soiled</p> <p>Error in the injection system</p> <p>The ignition curve for 80 octane is activated</p>	<p>Have the air filter/fuel filter replaced at an authorized KTM workshop</p> <p>Visit an authorized KTM workshop</p> <p>Activate the ignition curve for 95 octane, if fuel with at least RON 95 (USA = Premium PON 91) is being used</p>
Engine overheats	<p>Insufficient cooling liquid</p> <p>Radiator fins are extremely dirty</p> <p>Foam forms in cooling system</p> <p>Radiator hose is kinked or damaged</p> <p>Blown fan fuse</p>	<p>Refill cooling liquid (see maintenance work), check cooling system for leaks</p> <p>Clean radiator with water jet</p> <p>Replace cooling liquid, use antifreezer with brand name</p> <p>Run the radiator hose correctly or replace</p> <p>Replace fuse FAN</p>

TROUBLE	CAUSE	REMEDY
Engine overheats	Defect fan or thermostitch for fan Air in the cooling system Thermostat defective	Contact an authorized KTM workshop. Bleed the cooling system (see Maintenance work) Have the thermostat checked (opening temperature 75°C, 167°F) or replaced; contact an authorized KTM workshop
Fl lamp is blinking / lights up	Error in the injection system (see blink code)	Visit an authorized KTM workshop
ABS warning lamp lights up	Driving situation with extremely different wheel speeds Fuse is blown ABS sensor is loose or the cable damaged ABS sensor wheel is bent Error in the ABS	Stop, switch off the ignition, start again Replace the ABS fuses (under the right engine cover) Replace the ABS OPTIONAL fuse Check the ABS sensors for a tight fit and the cable for damage, visit an authorized KTM workshop Visit an authorized KTM workshop Visit an authorized KTM workshop
Engine stalls while driving	No fuel Fuse for fuel pump has blown	Refuel Replace fuse FUEL PUMP
High oil consumption	Engine oil level too high Engine oil too thin (viscosity)	Check engine oil level when the engine is warm; correct if necessary Use thicker engine oil; see chapter „Engine oil“
Headlight and position light fail	Bulb burned out Blown fuse	Replace bulb Replace fuse H/L BEAM POSITION.

TROUBLE	CAUSE	REMEDY
Flasher lights, brake light, horn and multi-functional digital speedometer fail	Bulb burned out	Replace bulb
	Blown fuse	Replace fuse HORN BRAKELIGHT SPEEDO.
Time is not displayed or not correctly displayed	Blown fuse, thus no continuous power supply	Replace fuse ACC 1 / CLOCK and set the clock.
The battery is discharged	The ignition (power consumer) hasn't been switched off	Recharge the battery according to the relevant instructions.
	The battery isn't charged by the generator	Voltage regulator and generator should be checked by an authorized KTM workshop.
No values are visible in the multi-functional digital speedometer display.	Blown fuse	Replace fuse HORN BRAKELIGHT SPEEDO.
The speed indication on the multifunctional digital speedometer is not working	Pickup cable is damaged or contacts on the cable connector have oxidized	Check the pickup cable for damage, visit an authorized KTM workshop

The blink code (FI indicator lamp) indicates which component is affected by an error. This allows the error to be identified if no diagnosis tool is available. The rhythm of the blinking lamp will let you determine the two-digit „blink code“, e.g.: Blink code 34: FI blinks 3x long, 4x short, pause, Blink code 06: FI blinks 6x short, pause

BLINK CODE	SIGNAL / COMPONENT	ERROR DESCRIPTION	ENGINE
02	Pulse generator	Malfunction	Stalls
06	Throttle sensor	Output signal too low /high	Continues to run
07	Sensor for 2nd throttle valve	Output signal too low /high	Continues to run
09	Intake manifold air pressure for sensor rear cylinder	Output signal too low /high	Continues to run
11	Intake manifold air pressure sensor for front cylinder	Output signal too low /high	Continues to run

The blink code indicates which component is affected by an error. This allows the error to be identified if no diagnosis tool is available.

BLINK CODE	SIGNAL / COMPONENT	ERROR DESCRIPTION	ENGINE
12	Coolant temperature sensor	Output signal too low /high	Continues to run
13	Air temperature sensor	Output signal too low /high	Continues to run
14	Ambient air pressure sensor	Output signal too low /high	Continues to run
15	Tilt angle sensor	Output signal too low /high	Continues to run
17	Lambda probe for rear cylinder	Malfunction	Continues to run
18	Lambda probe for front cylinder	Malfunction	Continues to run
24	Control unit voltage supply	Malfunction	Continues to run
25	Side stand switch	Short circuit to ground	Continues to run
33	Injection nozzle for rear cylinder	Malfunction	Stalls
34	Injection nozzle for front cylinder	Malfunction	Stalls
37	Ignition coil for rear cylinder	Malfunction	Stalls
38	Injection coil for front	Malfunction	Stalls
41	Fuel pump relay	Short circuit to ground / positive	Stalls
45	Lambda probe heater for rear cylinder	Short circuit to ground / positive	Continues to run
46	Lambda probe heater for front cylinder	Short circuit to ground / positive	Continues to run
49	Idle control motor	Malfunction	Continues to run
53	Purge valve for carbon canister	Short circuit to ground / positive	Continues to run
54	Secondary air valve	Short circuit to ground / positive or interruption	Continues to run
65	EEPROM error	Malfunction	Continues to run
68	Vacuum hose for front cylinder is defective	Malfunction	Continues to run
69	Vacuum hose for rear cylinder is defective	Malfunction	Continues to run
72	Stepper motor for 2nd throttle valve	Malfunction	Continues to run

Regular cleaning and paintwork care is part of the maintenance work and helps to maintain the value of your motorcycle.

! CAUTION

Never clean your motorcycle with a high-pressured cleaner or a high-pressured water jet. The water could otherwise run into the electrical components, connectors, sheathed cables, bearings etc. and cause disturbances or lead to a premature destruction of these parts.

- Before you wash your motorcycle, close the muffler openings.
- Use warm water with a commercial detergent and sponge. Coarse dirt can be removed with a soft water jet. Areas that are heavily soiled can be sprayed with a motorcycle cleaner (e.g. Motorex 900) and cleaned with a brush.
- After the motorcycle has been rinsed with a soft water jet, it should be dried by air pressure and a cloth. Then take a short drive until the engine has reached the working temperature and also use the brakes. Due to the heat, the water also evaporates at the unapproachable parts of the engine and the brakes.
- Slide back the protective covers on the handlebar-mounted instruments so that any water that may have swept into this parts of the motorcycle is allowed to evaporate.
- After the motorcycle has cooled down, oil or lubricate all of the friction bearings and bearing positions and treat the chain with chain spray. Treat all bare areas (except brake disks) with a corrosion inhibitor (e.g. Motorex Protect & Shine).
- The exhaust pipes can be polished with a chrome care product. The mufflers are made of stainless steel and should be treated with a suitable care product.
- Clean the windshield with plenty of water and a soft sponge. Chemical cleansers will corrode the plastic.
- To prevent failures in the electric system, you should treat the ignition lock, the emergency OFF switch, light switch and the socket connectors with contact spray.
- Treat all of the painted parts with a mild paint care product.

CONSERVATION FOR WINTER OPERATION »

In the event that the motorcycle is also used in winter and on roads where one has to expect salt spraying, you will have to take precautions against the aggressive road salt.

- Clean motorcycle thoroughly and let it dry
- Treat engine, swing arm and all other bare parts (except for brake discs) with a wax-based anti-corrosion agent.

⚠ WARNING

Keep anti-corrosion agent from getting into contact with the brake discs, for otherwise this will significantly reduce the braking power.

! CAUTION

After rides on salted roads, clean motorcycle thoroughly with cold water and let it dry well!

Should you desire to make a pause over a longer space of time, please observe the following instructions:

- Drive the tanks empty to be able to fill up with fresh fuel when starting the motorcycle up again.
- Clean motorcycle thoroughly (see chapter: CLEANING)
- Change engine oil and oil filter (old engine oil contains aggressive contaminations).
- Check antifreezer and amount of cooling liquid.
- Correct tire pressure.
- Disassemble and charge battery (see chapter: BATTERY).
- Jack up the motorcycle if possible so the wheels do not touch the ground.
- The storage place should be dry and not subject to excessive temperature fluctuations.
- Cover the motorcycle with an air permeated tarpaulin or blanket. Do not use non air permeable materials as a possible humidity might not be able to escape and could cause corrosion.

! CAUTION

It would be very bad to let the engine run for a short time during the storage period. The engine would not get warmed up enough and the thus developed steam would condense during the combustion process and cause the valves and exhaust to rust.

RE-INITIATION AFTER TIME OF STORAGE

- Mount the charged battery (regard polarity), secure the screws on the underride protection with Loctite 243.
- Fill up tank with fresh fuel.
- Check motorcycle as before each start (see driving instructions).
- Take a short, careful test ride first.

NOTE: Before you put your motorcycle away for the winter, you have to check all parts for their function and wear. Should any service jobs, repairs, or any refitting be necessary, you should have them carried out during the off-season (lower workload at mechanics' shops). This way, you can avoid the long waiting times at your mechanic at the beginning of the next biking season.

CHASSIS	990 ADVENTURE / 990 ADVENTURE S
Frame	Tubular chrome-molybdenum-steel space frame
Fork	WP – Up Side Down 4860 MXMA (Multiadjuster)
Wheel travel front	ADVENTURE = 210 mm (8.3 in), ADVENTURE S = 265 mm (10.4 in)
Rear suspension	WP Suspension Progressive Damping System shock absorber with hydraulic preload adjuster
Wheel travel rear	ADVENTURE = 210 mm (8.3 in), ADVENTURE S = 265 mm (10.4 in)
Front brake	Disk brake, 2 perforated brake disks Ø 300 mm (11.8 in), floating brake calipers and brake disks
Rear brake	Disk brake, perforated brake disk Ø 240 mm (9.5 in), floating brake calipers and brake disks
ABS (antilock brake system)	ADVENTURE: Brembo/Bosch with 2 independent brake circuits / ADVENTURE S: –
Authorized front tires *	Pirelli MT90 90/90 21 M/C 54V Up to a max. of 160 kph/100 mph: Continental TKC80 90/90-21 M/C 54S TT M+S
Air pressure front	road/driver only 2,4 bar (34 psi) road/with passenger 2,4 bar (34 psi)
Authorized rear tires *	Pirelli MT90 150/70 18 M/C 70V Up to a max. of 160 kph/100 mph: Continental TKC80 150/70B18 M/C 70Q TT M+S
Air pressure rear	road/driver only 2.6 bar (37 psi) road/with passenger 2.8 bar (40 psi)
Fuel tank capacity	19.5 liters (5.1 USgal), 4 liters (1 USgal) reserve
Gear ratio – rear wheel	17:42
Chain	525 HV (5/8 x 5/16”) X-ring, 118 rolls
Lighting	high beam H3 12V 55W (socket PK22s) low beam H7 12V 55W (socket PX26d) USA: high beam + low beam H4 12V 60/55 W (socket P43t) position light front + rear 12V 5W (socket W2.1x9.5d) indicator lamps LED stoplight 12V 21W (socket BA15s)

* further tire releases are available on the Internet at www.ktm.com
Download from www.Somaterials.com. All Manuals Search And Download.

CHASSIS	990 ADVENTURE / 990 ADVENTURE S
Lighting	flasher 12V 10W (socket BA15s) licens plate illumination 12V 5W (socket W2.1x9,5d)
Battery	maintenance-free battery 12V 11.2 Ah
Steering head angle	63.4°
Wheel base	1570 mm (61.8 in)
Seat height, unloaded	ADVENTURE: 860 mm (33.8 in), ADVENTURE S: 915 mm (36 in)
Ground clearance, unloaded	ADVENTURE: 261 mm (10.3 in), ADVENTURE S: 316 mm (12.4 in)
Dry weight	ADVENTURE: 209 kg (461 lbs) / ADVENTURE S: 207 kg (457 lbs)
Max. axle load, front	200 kg (441.5 lbs)
Max. axle load, rear	250 kg (552 lbs)
Max. total weight	430 kg (949 lbs)

BASIC SETTING FORK 990 ADVENTURE 990 ADVENTURE S	Driving Comfort	Basic Setting	Driving Sport	Maximum Payload
	Compression adjuster (clicks)	20	15	10
Rebound adjuster (clicks)	23	18	13	13
Spring preload (turns)	5	5	8	7

BASIC SETTING SHOCK ABSORBER 990 ADVENTURE	Driving Comfort	Basic Setting	Driving Sport	Volle Nutzlast
	Compression adjuster Low Speed (clicks)	25	20	15
Compression adjuster High Speed (turns)	2	1,5	1	1
Rebound adjuster (clicks)	20	15	10	10
Spring preload (turns)	6	6	10	18

BASIC SETTING SHOCK ABSORBER 990 ADVENTURE S	Driving Comfort	Basic Setting	Driving Sport	Maximum Payload
	Compression adjuster Low Speed (clicks)	25	20	15
Compression adjuster High Speed (turns)	2	1,5	1	1
Rebound adjuster (clicks)	20	15	10	10
Spring preload (turns)	6	6	10	12

TIGHTENING TORQUES – CHASSIS		
HH clamp bolts on top triple clamp	M8	20 Nm
HH clamp bolts for steering stem	M8	20 Nm
HH clamp bolts on bottom triple clamp	M8	15 Nm
AH bolt for handlebar mount	M10	20 Nm
Collar bolts for handlebar clamps	M8	20 Nm
HH clamp bolts on fork leg axle passages	M8	15 Nm
Collar screw on front wheel spindle	M24x1,5	60 Nm
Collar nut wheel spindle rear	M25x1,5	90 Nm
Collar nut for swing arm bolt	M19x1,5	130 Nm
AH screw shock absorber top	M14x1,5	80 Nm
AH bolt shock absorber bottom	M14x1,5	80 Nm
AH bolt for top of brake-hose guide	M6	Loctite 243 + 8 Nm
HH bolts on front brake caliper	M8	Loctite 243 + 25 Nm
HH bolts on footbrake cylinder	M6	Loctite 243 + 10 Nm
Collar bolt front brake disks	M6	Loctite 243 + 14 Nm
Collar bolt rear brake disk	M6	Loctite 243 + 14 Nm
AH bearing bolt for foot brake pedal	M8	Loctite 243 + 25 Nm
HH bolts on foot brake pedal surface	M5	Loctite 243 + 6 Nm
AH bolts on subframe	M10x1,25	Loctite 243 + 45 Nm
AH bolts on back of footrest support	M8	Loctite 243 + 25 Nm
AH bolts on tank cover	M5	5 Nm
HH bolt on fuel level indicator	M5	3 Nm
HH bolts fuel taps	M6	6 Nm
AH bolts on tank mounting	M8	25 Nm

TIGHTENING TORQUES – CHASSIS		
Exhaust nuts on manifold	M8	evenly, do not bend sheet metal
HH bolts on exhaust suspension	M6	Loctite 243 + 12 Nm
Spoke nipple	M5	5 Nm ± 1 Nm
HH nuts on rear sprocket bolts	M10x1,25	Loctite 243 + 50 Nm
Hexagon nut on engine sprocket	M20x1,5	Loctite 243 + sheet retainer + 100 Nm
Engine carrier bolts	M10	45 Nm
HH bolts for side stand bracket - engine	M10	Loctite 243 + 45 Nm
HH bolts side stand bracket - side stand console	M10	Loctite 243 + 25 Nm
HH bolts side stand mounting	M10	Loctite 243 + 35 Nm
HH bolt spring retainer side stand	M8	Loctite 243 + 25 Nm
HH bolt side stand switch	M6	Loctite 243 + 10 Nm
HH bolts for underride protection	M8	Loctite 243 + 25 Nm
Drain plug on oil tank	M12x1,5	25 Nm
HH collar screw for front ABS sensor	M6	6 Nm
Special screw for rear ABS sensor	M6	Loctite 243 + 8 Nm
Nut for plug socket	M18x1	4 Nm
Other bolts on chassis	M6	10 Nm
	M8	25 Nm
	M10	45 Nm
Other collar nuts on chassis	M6	15 Nm
	M8	30 Nm
	M10	50 Nm

ENGINE	990 LC8
Design	Liquid-cooled, 2-cylinder 4-stroke engine with 75° V arrangement with balancer shaft and electric starter
Displacement	999 cc
Bore / Stroke	101/62.4 mm
Compression ratio	11.5:1
Fuel	unleaded fuel with at least RON 95 (USA: Premium PON 91*) / RON 80 - 94 for other ignition curve)
Valve timing	4 valves controlled over bucket tappet and 2 camshafts, camshaft drive with gears/chain
Valve diameter	Intake: 38 mm Exhaust: 33 mm
Valve clearance, cold	Intake: 0.10 - 0.15 mm Exhaust: 0.25 - 0.30 mm
Crankcase bearing	Friction bearings (2 main bearings / 1 supporting bearing)
Conrod bearing	Friction bearing
Piston pin bearing	Dual-fuel bearing
Piston	Light alloy – forged
Piston rings	1 compression ring, 1 taper face ring, 1 single-piece oil scraper ring with spiral-type expander
Engine lubrication	Dry sump with 2 trochoidal pumps (pressure pump and suction pump)
Engine oil	SAE 10W-50 (Motorex Power Synt 4T) #
Quantity of engine oil	approx. 3.0 liters during oil/filter change
Primary drive	Straight-toothed spur wheels 35 : 67
Clutch	Multi-disc clutch in oil bath
Transmission	6-speed claw shifted
Gear ratio	1st gear 12:35 2nd gear 15:32 3rd gear 18:30 4th gear 20:27 5th gear 24:27 6th gear 26:27

ENGINE	990 LC8
Mixture preparation	EFI (electronic fuel injection)
Ignition system	breakerless transistorized electronic ignition system with digital ignition advance
Ignition timing	Map-controlled via TPS
Generator	12V 450W at 6000 rpm
Spark plug	NGK DCPR 8 E
Electrode distance	0.8 mm
Cooling system	liquid cooled, permanent circulation of cooling liquid through water pump
Cooling liquid	2.1 liters, 50% antifreeze, 50% distilled water, at least -25° C
Starting aid	0.9 kW electric starter

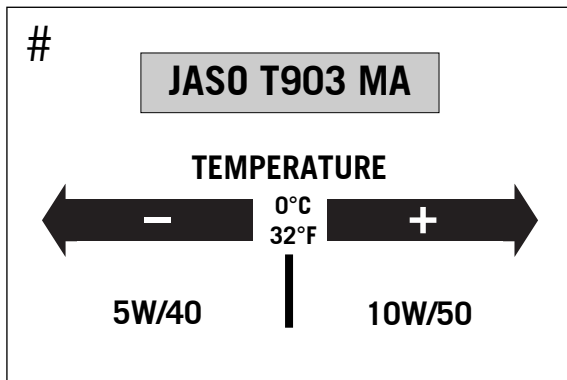

*

PON / CLC	RON / ROZ	MON
87	91	83
91 Premium	95	87

PON = Pump Octane Number
 CLC = Cost of Living Council
 RON = Research Octane Number
 ROZ = Research Oktan Zahl
 MON = Motor Octane Number

Engine oil

Only use fully synthetic engine oils that meet the JASO MA quality requirements (see information on the can).

KTM recommends Motorex Power Synt 4T in the 10W/50 viscosity (for temperatures over 0°C, 32°F) or 5W/40 (for temperatures under 0°C, 32°F).

ABS button – models with ABS (antilock brake system)	14	Checking the chain for wear	49
ABS fuses – models with ABS (antilock brake system)	64	Checking the chain tension	47
ABS warning lamp – models with ABS (antilock brake system) . .	14	Checking the cooling liquid level in the compensating tank . .	71
Accessories and payload	25	Checking the cooling liquid level in the radiator	72
Activating the ignition curve for low-octane fuel	82	Checking the engine oil level	75
Adjusting compression damping of fork	42	Checking the front brake pads	53
Adjusting of free travel at the hand brake lever	53	Checking the oil level of the hydraulic clutch	74
Adjusting rebound damping of fork	42	Checking the rear brake pads	54
Adjusting the fork and shock absorber	42	Cleaning	88
Adjusting the headlight range	68	Cleaning the dust sleeves of the telescopic fork	47
Adjusting the preload of the shock absorber	46	Clutch lever	7
Adjusting the spring preload on the fork	43	Combination switch	16
Alarm system	23	Compression damping of fork	20
Baggage carrier plate	22	Compression damping of shock absorber	44
Battery	61	Conservation for winter operation	88
Bleeding the cooling system	73	Consumer information for USA only	98
Braking – models with ABS (antilock brake system)	30	Cooling liquid temperature display	12
Braking – models without ABS (antilock brake system)	30	Cooling system	70
Breathing the fork legs	46	Correct chain tension	48
Center stand	19	Damping action during compression of shock absorber	21
Chain maintenance	49	Demounting and mounting the battery	62
Changing the engine oil and the oil filter, cleaning the oil screen	76	Dismounting and mounting the front wheel	56
Changing the original position of the clutch lever	74	Dismounting and mounting the rear wheel	58
Charging the battery	63	Display	8
Chassis number	6	Driving instructions	26
Check the following before each start	26	Emergency OFF tip switch, starter tip switch	16
Checking of brake fluid level - front brake	53	Engine number, engine type	6
Checking rear brake fluid level	54	Engine oil	95
Checking spoke tension	60	Engine oil	75
		Filler caps	17

Foot brake pedal	19	Serial number locations	6
Footrests	23	Setting options in the display	10
Fuel	34	Shift lever	18
Fuel taps	18	Shifting/Riding	29
Fuses for individual current consumers	65	Shock absorber's preload adjuster	22
General informations about KTM disc brakes	50	Side stand	19
General tips and warnings for starting the motorcycle	24	Spring preload of the fork	20
Grips	23	Starting off	29
Hand brake lever	7	Starting the engine	28
Ignition lock	15	Stopping and parking	32
Important information	2	Storage	89
Index	4	Storage compartment	17
Indicator lamps	13	Switching off the ABS	31
Instructions for initial operation	24	Tachometer	15
Introduction	1	Technical specifications – chassis	90
Jump start	63	Technical specifications – engine	94
Main fuse	64	Tires, air pressure	59
Maintenance work on chassis and engine	40	Tool set	41
Multi-functional digital speedometer	8	Trouble shooting	83
Operation instruments	7		
Periodic maintenance schedule	36		
Rebound damping of fork	20		
Rebound damping of shock absorber	45		
Rebound damping of shock absorber	22		
Removing and remounting the seat	41		
Replacing the brake and tail light bulbs	68		
Replacing the flasher bulbs	69		
Replacing the headlight lamps	66		
Running in the LC8 engine	24		
Seat lock	17		

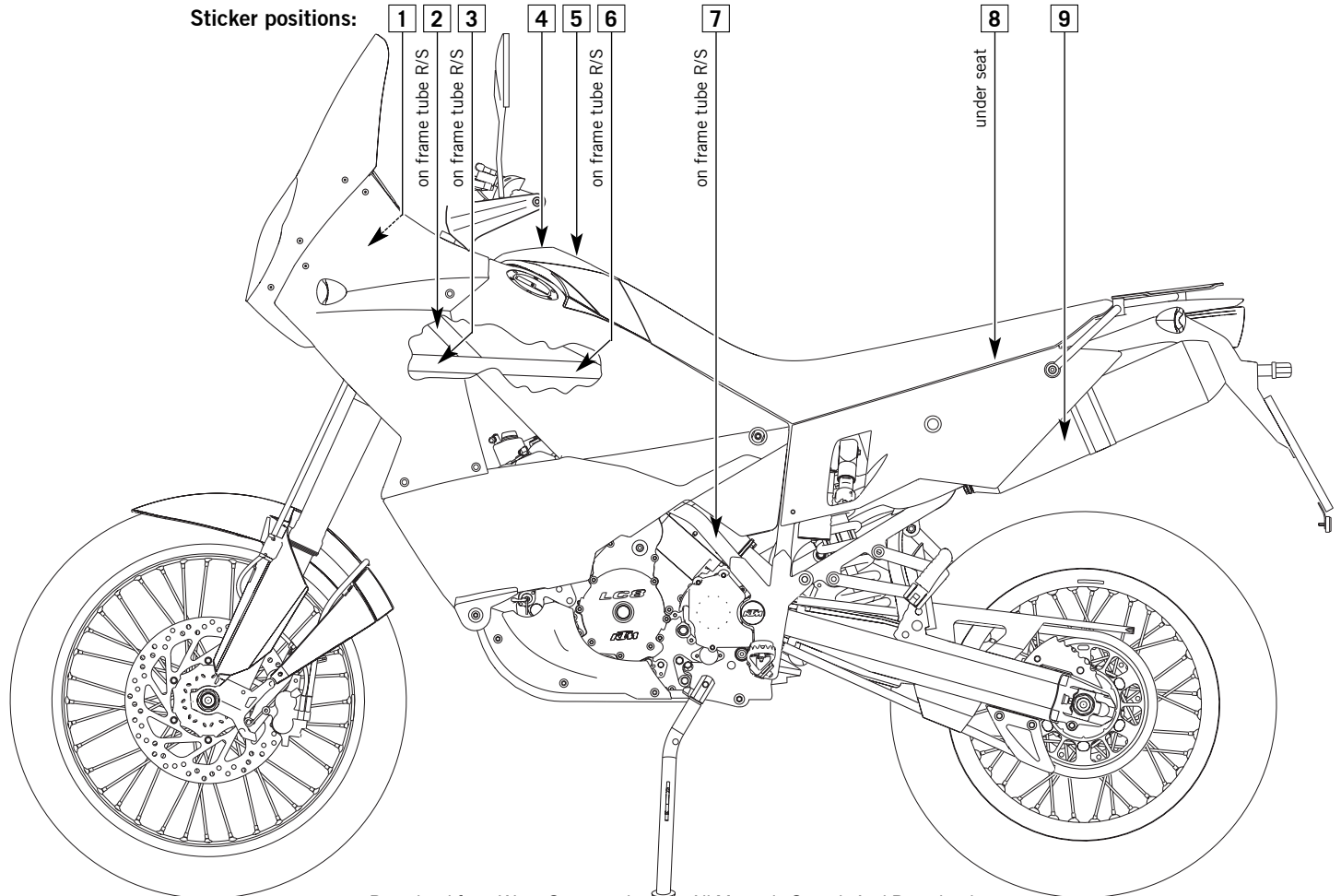

[1] EAVP

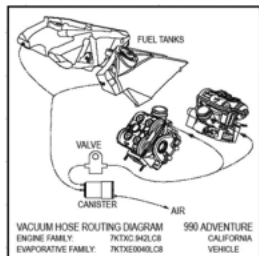

[4] Fuel level

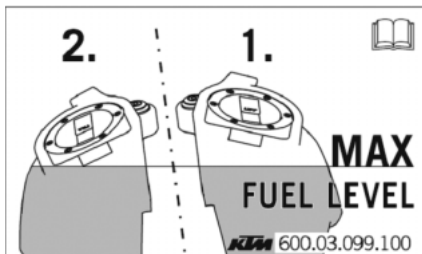

[7] Noise emission

MOTORCYCLE NOISE EMISSION CONTROL INFORMATION	
KTM SPORTMOTORCYCLE AG, AUSTRIA	
THIS 2007 KTM710999 MOTORCYCLE 601.05.183.000 MEETS THE U.S. EPA NOISE EMISSION REQUIREMENTS OF 80 dBA AT 4250 RPM BY THE U.S. FEDERAL TEST PROCEDURE. MODIFICATIONS WHICH CAUSE THIS MOTORCYCLE TO EXCEED FEDERAL NOISE STANDARDS ARE PROHIBITED BY U.S. FEDERAL LAW. SEE OWNER'S MANUAL.	
Motorcycle Type : 990 ADVENTURE	Date manufactured : 2008.07.04 VIN : VBK00040XKM000000

[2] Type label USA

KTM MFD. BY KTM SPORTMOTORCYCLE AG AUSTRIA		MOTORCYCLE		DATE
GAWR	884 lbs	400 kg		
GAWR FRONT	442 lbs	200 kg WITH 90/90-21 TIRE, 54V TYPE,		
	2,15-21 RIM, AT	35 psi 2.4 bar COLD		
GAWR REAR	530 lbs	240 kg WITH 150/70-18 TIRE, 70V TYPE,		
	4,00-18 RIM, AT	37 psi 2,6 bar COLD		
THIS VEHICLE CONFORMS TO ALL APPLICABLE U.S. FEDERAL MOTOR VEHICLE SAFETY STANDARDS IN EFFECT ON THE DATE OF MANUFACTURE SHOWN ABOVE.				
VBKVA440X3M123456				

[5] Before you go for the first ride

ACHTUNG
Lesen Sie vor der ersten Inbetriebnahme des Motorrades die gesamte Bedienungsanleitung aufmerksam durch!

IMPORTANT
Before you go for the first ride on your motorbike, read the entire User's Guide carefully!

ATTENZIONE
Prima della prima messa in servizio del motociclo, leggere attentamente l'intero manuale d'uso.

ATTENTION
Il convient de lire attentivement tout le manuel d'utilisation avant la première mise en service!

ATENCIÓN
Leer atentamente todas las instrucciones para el servicio antes de la primera puesta en marcha de la motocicleta!

[8] Technical information

990 ADVENTURE / 990 ADVENTURE S Fuel RON 95 unleaded (USA - PREMIUM RON 93) Tyre front 90/90-21, speed index V Air pressure rider only 2.4 bar (34 psi) / max. payload 2.4 bar (34 psi) Tyre rear 150/70-18, speed index V Air pressure rider only 2.5 bar (37 psi) / max. payload 2.8 bar (40 psi) Max. payload 230 kg (463 lbs), max. total weight 420 kg (948 lbs) Engine oil fully synthetic 10W/50 (SWS40 under 0°C, 32°F) Chain tension, see figure	
Further information see owners handbook	

[2] Type label CAN

MANUFACTURED BY/FABRIQUE PAR: KTM SPORTMOTORCYCLE AG		KTM	
GAWR/FBNV: 400 KG	DATE: 05.08		
V.I.N./N.I.V.: VBKVA440X3M123456			
TYPE: BIC		COLD INFL. PRESS.	
GAWR/PHSE	TREFFP/HEUMENSIION-R/MIJANTE	PRESS. DE GONFL. A FROID	
		PSI/PC	KPA
TR 200 KG	90/90-21	2,15-21	35 240
TR 200 KG	150/70-18	4,00-18	37 250
THIS VEHICLE CONFORMS TO ALL APPLICABLE STANDARDS PRESCRIBED UNDER THE CANADIAN SAFETY REGULATIONS IN EFFECT ON THE DATE OF MANUFACTURE. - CE VEHICULE EST CONFORME A TOUTES LES NORMES DU LIA SONT APPLICABLES EN VERTU DU REQUISIEMENT SUR LA SECURITE DES VEHICULES AUTOMOBILES DU CANADA EN VIGUEUR LA DATE DE SA FABRICATION			

[6] Vehicle emission

VEHICLE EMISSION CONTROL INFORMATION	
KTM SPORTMOTORCYCLE AG, MATTHIGHOFEN, AUSTRIA	
IMPORTER : KTM NORTH AMERICA INC.	
ENGINE DISPLACEMENT :	1000 cc
EVAP FAMILY :	7K7XC.942LCS
EVAP FAMILY :	7K7XB9946LCS
ENGINE EXHAUST CONTROL SYSTEM :	TWC
THIS VEHICLE CONFORMS TO US EPA AND CALIFORNIA REGULATIONS APPLICABLE TO 2007 MODEL YEAR NEW MOTORCYCLES AND IS CERTIFIED TO 1.4 g/km HC + NOx EXHAUST EMISSION STANDARD IN CALIFORNIA.	
ENGINE TUNELUP SPECIFICATIONS:	
IGNITION TIMING :	NON ADJUSTABLE
IDLE SPEED :	1400 rpm IN NEUTRAL
IDLE MIXTURE :	NON ADJUSTABLE
SPARK PLUG :	NGK DCPRIE
SPARK PLUG GAP :	0,7 mm
FUEL :	UNLEADED GASOLINE - 91 OCTANE R+M2
OIL :	SAE 15 W 40
V.I.N. : VBKXXX40X7MXXXXXXX	DATE OF MANUFACTURE : 03.06.2006

[9] Exhaust system

MOTORCYCLE EXHAUST SYSTEM NOISE EMISSION CONTROL INFORMATION
 -THIS KTM EXHAUST SYSTEM 601.05.183.000 MEETS EPA NOISE EMISSIONS REQUIREMENTS OF 80(dBA) FOR THE FOLLOWING MOTORCYCLES
 KTM 7210999 , 8210999 , 9210999 , 0210999 , 1210999
INSTALLATION OF THIS EXHAUST SYSTEM ON MOTORCYCLE MODELS NOT SPECIFIED MAY VIOLATE FEDERAL LAW.
KTM VBK 990 Adv, CAT Type Screen Type

REPORTING SAFETY DEFECTS

If you believe that your vehicle has a defect which could cause an accident resulting in injury or death, you should immediately inform the National Highway Traffic Safety Administration (NHTSA) in addition to notifying KTM North America, Inc.

If NHTSA receives similar complaints, it may open an investigation, and if it finds that a safety defect exists in a group of vehicles, it may order a recall and remedy campaign. However, NHTSA cannot become involved in individual problems between you, your dealer, or KTM North America, Inc.

To contact NHTSA, you may either call the Auto Safety Hotline toll-free at 1-800-424-9393 or visit the website www.nhtsa.dot.gov, or write to: NHTSA, U.S. Department of Transportation, 400 7th Street, Southwest, Washington, D.C. 20590. You can also obtain other information about motor vehicle safety from the Hotline.

NOISE EMISSION WARRANTY

KTM Sportmotorcycle AG warrants that this exhaust system, at the time of sale, meets all applicable U.S. EPA Federal noise standards. This warranty extends to the first person who buys this exhaust system for purposes other than resale, and to all subsequent buyers.

Warranty claims should be directed to:

KTM North America, Inc. 1119 Milan Avenue, Amherst, Ohio 44001, Telephone: (440) 9853553

TAMPERING WARNING

TAMPERING WITH NOISE CONTROL SYSTEM PROHIBITED. FEDERAL LAW PROHIBITS THE FOLLOWING ACTS OR CAUSING THEREOF:

- 1) The removal or rendering inoperative by any person other than for purposes of maintenance, repair, or replacement, of any device or element of design incorporated into any new vehicle for the purpose of noise control prior to its sale or delivery to the ultimate purchaser or while it is in use, or
- 2) The use of the vehicle after such device or element of design has been removed or rendered inoperative by any person.

AMONG THOSE ACTS PRESUMED TO CONSTITUTE TAMPERING ARE THE ACTS LISTED BELOW.

- 1) Removal of, or puncturing the muffler, baffles, header pipes or any other components which conducts exhaust gases.
- 2) Removal or puncturing of any part of the intake system.
- 3) Lack of proper maintenance.
- 4) Replacing any moving part of the vehicle, or parts of the exhaust or intake system, with parts other than those specified by the manufacturer.

WARNING STATEMENT

This product should be checked for repair or replacement if the motorcycle noise has increased significantly through use. Otherwise, the owner may become subject to penalties under state and local ordinances.

CONSUMER RIGHTS

Limited Warranty claims should be directed to an authorized KTM dealer. If you are not satisfied, please contact KTM North America, Inc., Customer Relations, 1119 Milan Avenue, Amherst, Ohio 44001.

Your rights may vary, please refer to the applicable state laws.



10/2006 FOTO: MITTERBAUER



KTM Sportmotorcycle AG
A-5230 Mattighofen
www.ktm.at

Download from www.Somanuals.com. All Manuals Search And Download.

Free Manuals Download Website

<http://myh66.com>

<http://usermanuals.us>

<http://www.somanuals.com>

<http://www.4manuals.cc>

<http://www.manual-lib.com>

<http://www.404manual.com>

<http://www.luxmanual.com>

<http://aubethermostatmanual.com>

Golf course search by state

<http://golfingnear.com>

Email search by domain

<http://emailbydomain.com>

Auto manuals search

<http://auto.somanuals.com>

TV manuals search

<http://tv.somanuals.com>