

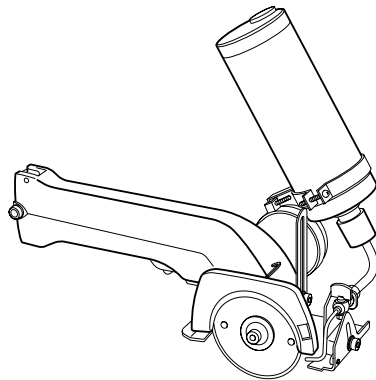

Cordless Cutter

85 mm (3-3/8")

MODEL 4190D



003503

I N S T R U C T I O N M A N U A L

⚠ WARNING:

For your personal safety, READ and UNDERSTAND before using.
SAVE THESE INSTRUCTIONS FOR FUTURE REFERENCE.

www.makitatools.com

SPECIFICATIONS

Model		4190D	
Wheel diameter		85 mm (3-3/8")	
Cutting depth	90°	0 - 21 mm (0 - 53/64")	
	45°	1 - 17 mm (3/64" - 43/64")	
No load speed (RPM)		1,000/min.	
Overall length		313 mm (12-3/8")	
Net weight		1.9 kg (4.2 lbs)	
Battery Cartridge 9000		Battery Charger DC9700A	
Voltage	Input	Output	Charging time
9.6V	A. C. only 50 Hz - 60 Hz	D. C. 7.2 V - 9.6 V	1 Hr.

- Manufacturer reserves the right to change specifications without notice.
- Specifications may differ from country to country.

GENERAL SAFETY RULES

USA003-1

(FOR ALL BATTERY OPERATED TOOLS)

⚠ WARNING:

Read and understand all instructions. Failure to follow all instructions listed below, may result in electric shock, fire and/or serious personal injury.

SAVE THESE INSTRUCTIONS

Work Area

- 1. Keep your work area clean and well lit.** Cluttered benches and dark areas invite accidents.
- 2. Do not operate power tools in explosive atmospheres, such as in the presence of flammable liquids, gases, or dust.** Power tools create sparks which may ignite the dust or fumes.
- 3. Keep bystanders, children, and visitors away while operating a power tool.** Distractions can cause you to lose control.

Electrical Safety

- 4. A battery operated tool with integral batteries or a separate battery pack must be recharged only with the specified charger for the battery.** A charger that may be suitable for one type of battery may create a risk of fire when used with another battery.
- 5. Use battery operated tool only with specifically designated battery pack.** Use of any other batteries may create a risk of fire.

Personal Safety

- 6. Stay alert, watch what you are doing, and use common sense when operating a power tool. Do not use tool while tired or under the influence of drugs, alcohol, or medication.** A moment of inattention while operating power tools may result in serious personal injury.
- 7. Dress properly. Do not wear loose clothing or jewelry. Contain long hair. Keep your hair, clothing, and gloves away from moving parts.** Loose clothes, jewelry, or long hair can be caught in moving parts.
- 8. Avoid accidental starting. Be sure switch is in the locked or off position before inserting battery pack.** Carrying tools with your finger on the switch or inserting the battery pack into a tool with the switch on invites accidents.
- 9. Remove adjusting keys or wrenches before turning the tool on.** A wrench or a key that is left attached to a rotating part of the tool may result in personal injury.
- 10. Do not overreach. Keep proper footing and balance at all times.** Proper footing and balance enable better control of the tool in unexpected situations.
- 11. Use safety equipment. Always wear eye protection.** Dust mask, non-skid safety shoes, hard hat, or hearing protection must be used for appropriate conditions.

Tool Use and Care

- 12. Use clamps or other practical way to secure and support the workpiece to a stable platform.** Holding the work by hand or against your body is unstable and may lead to loss of control.
- 13. Do not force tool. Use the correct tool for your application.** The correct tool will do the job better and safer at the rate for which it is designed.
- 14. Do not use tool if switch does not turn it on or off.** A tool that cannot be controlled with the switch is dangerous and must be repaired.
- 15. Disconnect battery pack from tool or place the switch in the locked or off position before making any adjustments, changing accessories, or storing the tool.** Such preventive safety measures reduce the risk of starting the tool accidentally.
- 16. Store idle tools out of reach of children and other untrained persons.** Tools are dangerous in the hands of untrained users.
- 17. When battery pack is not in use, keep it away from other metal objects like: paper clips, coins, keys, nails, screws, or other small metal objects that can make a connection from one terminal to another.** Shorting the battery terminals together may cause sparks, burns, or a fire.
- 18. Maintain tools with care. Keep cutting tools sharp and clean.** Properly maintained tools with sharp cutting edge are less likely to bind and are easier to control.
- 19. Check for misalignment or binding of moving parts, breakage of parts, and any other condition that may affect the tool's operation. If damaged, have the tool serviced before using.** Many accidents are caused by poorly maintained tools.
- 20. Use only accessories that are recommended by the manufacturer for your model.** Accessories that may be suitable for one tool may create a risk of injury when used on another tool.

SERVICE

21. Tool service must be performed only by qualified repair personnel. Service or maintenance performed by unqualified personnel may result in a risk of injury.

22. When servicing a tool, use only identical replacement parts. Follow instructions in the Maintenance section of this manual. Use of unauthorized parts or failure to follow Maintenance instructions may create a risk of shock or injury.

SPECIFIC SAFETY RULES

USB070-1

DO NOT let comfort or familiarity with product (gained from repeated use) replace strict adherence to cordless cutter safety rules. If you use this tool unsafely or incorrectly, you can suffer serious personal injury.

- 1. DANGER! Keep hands away from cutting area and wheel. Keep your second hand on auxiliary handle or motor housing.** If both hands are holding the tool, they cannot be cut by the wheel.
- 2. Keep your body positioned to either side of the wheel, but not in line with the wheel.** KICKBACK could cause the tool to jump backwards. (See “Causes and Operator Prevention of Kickback”)
- 3. Do not reach underneath the work.**
- 4. Always observe that the wheel has stopped spinning before placing tool down on bench or floor.** A coasting wheel will cause the tool to walk backwards, cutting whatever is in its path. Be aware of the time it takes for the wheel to stop after switch is released.
- 5. NEVER hold piece being cut in your hands or across your leg.** It is important to support the work properly to minimize body exposure, wheel binding, or loss of control.
- 6. Hold tool by insulated gripping surfaces when performing an operation where the cutting tool may contact hidden wiring.** Contact with a “live” wire will also make

exposed metal parts of the tool “live” and shock the operator.

- 7. When ripping always use a rip fence or straight edge guide.** This improves the accuracy of cut and reduces the chance for wheel binding.
- 8. Always use wheels with correct size and shape (diamond vs. round) arbor holes.** Wheels that do not match the mounting hardware of the tool will run eccentrically, causing loss of control.
- 9. Never use damaged or incorrect wheel washers or bolts.** The wheel washers and bolt were specially designed for your tool, for optimum performance and safety of operation.
- 10. Causes and Operator Prevention of Kickback:**

Kickback is a sudden reaction to a pinched, bound, or misaligned wheel, causing an uncontrolled tool to lift up and out of the workpiece toward the operator.

When the wheel is pinched or bound tightly by the kerf closing down, the wheel stalls and the motor reaction drives the unit rapidly back toward the operator.

If the wheel becomes twisted or misaligned in

the cut, the teeth at the back edge of the wheel can dig into the top surface of the wood causing the wheel to climb out of the kerf and jump back toward the operator.

Kickback is the result of tool misuse and/or incorrect operating procedures or conditions and can be avoided by taking proper precautions as given below:

Maintain a firm grip on the tool and position your body and arm in a way that allows you to resist KICKBACK forces. KICKBACK forces can be controlled by the operator, if proper precautions are taken.

When wheel is binding, or when interrupting a cut for any reason, release the trigger and hold the tool motionless in the material until the wheel comes to a complete stop. Never attempt to remove the tool from the work or pull the tool backward while the wheel is in motion or KICKBACK may occur. Investigate and take corrective actions to eliminate the cause of wheel binding.

When restarting a tool in the workpiece, center the wheel in the kerf and check that teeth are not engaged into the material. If wheel is binding, it may walk up or KICKBACK from the workpiece as the tool is restarted.

Support large panels to minimize the risk of wheel pinching and KICKBACK. Large panels tend to sag under their own weight. Supports must be placed under the panel on both sides, near the line of cut and near the edge of the panel.

To minimize the risk of wheel pinching and kickback. When cutting operation requires the resting of the tool on the workpiece, the tool shall be rested on the larger portion and the smaller piece cut off.

Do not use dull or damaged wheel. Unsharpened or improperly set wheels produce narrow kerf causing excessive friction, wheel binding and KICKBACK.

Wheel depth and bevel adjusting locking levers must be tight and secure before making cut. If wheel adjustment shifts while cutting, it will cause binding and KICKBACK.

Use extra caution when making a “Pocket Cut” into existing walls or other blind areas. The protruding wheel may cut objects that can cause KICKBACK.

11. **Use only diamond wheels. NEVER use tool with wood cutting blades or other sawblades. Such blades when used on this tool frequently kick and cause loss of control leading to personal injury.**
12. **Check the wheel carefully for cracks or damage before operation. Replace cracked or damaged wheel immediately.**
13. **Use only flanges specified for this tool.**
14. **Be careful not to damage the spindle, flanges (especially the installing surface) or bolt. Damage to these parts could result in wheel breakage.**
15. **Hold the tool firmly.**
16. **Make sure the wheel is not contacting the workpiece before the switch is turned on.**
17. **Wait until the wheel attains full speed before cutting.**
18. **Stop operation immediately if you notice anything abnormal.**
19. **Never attempt to cut with the tool held upside down in a vise. This can lead to serious accidents, because it is extremely dangerous.**
20. **Do not stop the wheel by lateral pressure on the disc.**
21. **Some material contains chemicals which may be toxic. Take caution to prevent dust inhalation and skin contact. Follow material supplier safety data.**

SAVE THESE INSTRUCTIONS

⚠ WARNING:
MISUSE or failure to follow the safety rules stated in this instruction manual may cause serious personal injury.

IMPORTANT SAFETY INSTRUCTIONS FOR CHARGER & BATTERY CARTRIDGE

USC001-3

1. **SAVE THESE INSTRUCTIONS** - This manual contains important safety and operating instructions for battery charger.
2. Before using battery charger, read all instructions and cautionary markings on (1) battery charger, (2) battery, and (3) product using battery.
3. **CAUTION** - To reduce risk of injury, charge only **MAKITA** rechargeable batteries marked on the charger label. Other types of batteries may burst causing personal injury and damage.
4. Do not expose charger to rain or snow.
5. Use of an attachment not recommended or sold by the battery charger manufacturer may result in a risk of fire, electric shock, or injury to persons.
6. To reduce risk of damage to electric plug and cord, pull by plug rather than cord when disconnecting charger.
7. Make sure cord is located so that it will not be stepped on, tripped over, or otherwise subjected to damage or stress.
8. An extension cord should not be used unless absolutely necessary. Use of improper extension cord could result in a risk of fire and electric shock. If extension cord must be used, make sure:
 - a. That pins on plug of extension cord are the same number, size, and shape as those of plug on charger;
 - b. That extension cord is properly wired and in good electrical condition;
 - c. That wire size is at least as large as the one specified in the table below.

Table 1: RECOMMENDED MINIMUM AWG SIZE FOR EXTENSION CORDS FOR BATTERY CHARGERS

Length of Cord (Feet)	25	50	100	150
AWG Size of Cord	18	18	18	16

9. Do not operate charger with damaged cord or plug - replace them immediately.
10. Do not operate charger if it has received a sharp blow, been dropped, or otherwise damaged in any way; take it to a qualified serviceman.
11. Do not disassemble charger or battery cartridge; take it to a qualified serviceman when service or repair is required, incor-

-
- rect reassembly may result in a risk of electric shock or fire.
12. To reduce risk of electric shock, unplug charger from outlet before attempting any maintenance or cleaning. Turning off controls will not reduce this risk.
 13. The battery charger is not intended for use by young children or infirm persons without supervision.
 14. Young children should be supervised to ensure that they do not play with the battery charger.
 15. If operating time has become excessively shorter, stop operating immediately. It may result in a risk of overheating, possible burns and even an explosion.
 16. If electrolyte gets into your eyes, rinse them out with clear water and seek medical attention right away. It may result in loss of your eyesight.

ADDITIONAL SAFETY RULES FOR CHARGER & BATTERY CARTRIDGE

1. Do not charge Battery Cartridge when temperature is **BELOW 10°C (50°F)** or **ABOVE 40°C (104°F)**.
2. Do not attempt to use a step-up transformer, an engine generator or DC power receptacle.
3. Do not allow anything to cover or clog the charger vents.
4. Always cover the battery terminals with the battery cover when the battery cartridge is not used.
5. Do not short the battery cartridge:
 - (1) Do not touch the terminals with any conductive material.
 - (2) Avoid storing battery cartridge in a container with other metal objects such as nails, coins, etc.
 - (3) Do not expose battery cartridge to water or rain.

A battery short can cause a large current flow, overheating, possible burns and even a breakdown.
6. Do not store the tool and Battery Cartridge in locations where the temperature may reach or exceed 50°C (122°F).
7. Do not incinerate the Battery Cartridge even if it is severely damaged or is completely worn out. The battery cartridge can explode in a fire.
8. Be careful not to drop, shake or strike battery.
9. Do not charge inside a box or container of any kind. The battery must be placed in a well ventilated area during charging.

SAVE THESE INSTRUCTIONS

FUNCTIONAL DESCRIPTION

⚠ CAUTION:

- Always be sure that the tool is switched off and the battery cartridge is removed before adjusting or checking function on the tool.

003507

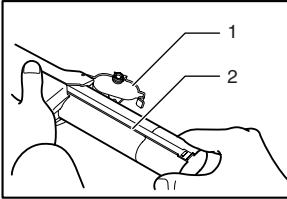

1. Set plate
2. Battery cartridge

Installing or removing battery cartridge

- Always switch off the tool before insertion or removal of the battery cartridge.
- To remove the battery cartridge, pull out the set plate on the tool and grasp both sides of the cartridge while withdrawing it from the tool.
- To insert the battery cartridge, align the tongue on the battery cartridge with the groove in the housing and slip it into place. Snap the set plate back into place. Be sure to close the set plate fully before using the tool to prevent the battery cartridge from accidentally falling out of the tool.
- Do not use force when inserting the battery cartridge. If the cartridge does not slide in easily, it is not being inserted correctly.

001332

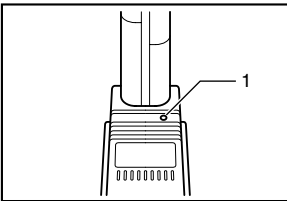

1. Charging light

Charging

1. Plug the battery charger into the proper AC voltage source.
2. Insert the battery cartridge so that the plus and minus terminals on the battery cartridge are on the same sides as their respective markings on the charger. Insert the cartridge fully into the port so that it rests on the charger port floor.
3. When the battery cartridge is inserted, the charging light color will flash in red color and charging will begin.
4. When the charging light goes out after about one hour, you may remove the fully charged battery cartridge.
5. After charging, unplug the charger from the power source.

NOTE:

- The battery charger is for charging Makita battery cartridge. Never use it for other purposes or for other manufacturer's batteries.

- If you try to charge a battery cartridge from a just operated tool, sometimes the charging light will not come on. If this occurs, let the cartridge cool off for a while. Then re-insert it and try to charge it once more.
- When you charge a new battery cartridge or a battery cartridge which has not been used for a long period of time, it may not accept a full charge. This is a normal condition and does not indicate a problem. You can recharge the battery cartridge fully after discharging it completely and recharging a couple of times.
- When you charge a new battery cartridge or a battery cartridge which has not been used for a long period, sometimes the charging light will go out soon. If this occurs, remove the battery cartridge and re-insert it. If the charging light goes out within one minute even after repeating this procedure a couple of times, the battery cartridge is dead. Replace it with a new one.
- If you wish to charge two battery cartridges, allow 15 minutes between charging on the charger.

Tips for maintaining maximum battery life

1. Charge the battery cartridge before completely discharged.
Always stop tool operation and charge the battery cartridge when you notice less tool power.
2. Never recharge a fully charged battery cartridge.
Overcharging shortens the battery service life.
3. Charge the battery cartridge with room temperature at 10° C - 40° C (50° F - 104° F).
Let a hot battery cartridge cool down before charging it.

003509

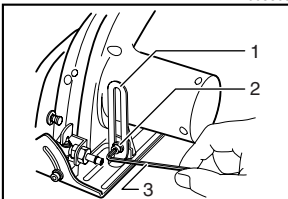

1. Depth guide
2. Bolt (A)
3. Hex wrench

Adjusting the depth of cut

Loosen the bolt (A) on the depth guide with the hex wrench and move the base up or down. At the desired depth of cut, secure the base by tightening the bolt (A).

003514

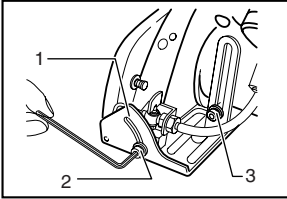

1. Bevel scale plate
2. Bolt (B)
3. Bolt (A)

Bevel cutting

Loosen the bolt (A) on the depth guide and the bolt (B) on the bevel scale plate with the hex wrench. Set for the desired angle (0° - 45°) by tilting accordingly, then tighten the bolts (A) and (B) securely.

⚠ CAUTION:

- After adjusting depth of cut and bevel cutting angle, be sure to tighten the bolts (A) and (B) securely.

003519

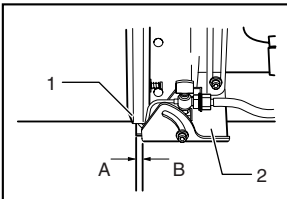

1. Blade case
2. Base

Sighting

For straight cuts, align the A position on the front of the base with your cutting line. For 45° bevel cuts, align the B position with it.

NOTE:

- When making bevel cuts, view the cutting line on the workpiece through the window in the blade case in order to cut more accurately. If you have difficulty seeing it because of the water tank, adjust the position of the tank by tilting it backward slightly.

003522

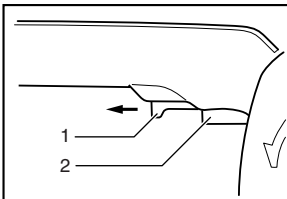

1. Lock-off lever
2. Switch trigger

Switch action

⚠ CAUTION:

- Before inserting the battery cartridge into the tool, always check to see that the switch trigger actuates properly and returns to the "OFF" position when released.

To prevent the switch trigger from being accidentally pulled, a lock-off lever is provided.

To start the tool, slide the lock-off lever in the direction of the arrow and pull the switch trigger. Release the switch trigger to stop.

ASSEMBLY

⚠ CAUTION:

- Always be sure that the tool is switched off and the battery cartridge is removed before carrying out any work on the tool.

003526

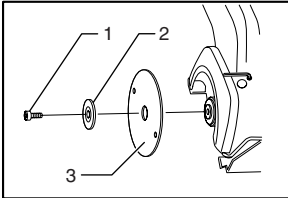

1. Bolt
2. Flange
3. Diamond wheel

Installing or removing diamond wheel

To install the wheel, first loosen the bolt with the hex wrench and remove the bolt and the flange. Then mount the wheel, the flange and the bolt. The wheel should be mounted with the Makita name on the flange side.

003527

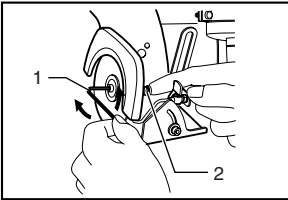

1. Hex wrench
2. Blade stopper pin

Press the blade stopper pin and insert it through the hole in the wheel so that the wheel cannot revolve. Use the hex wrench to tighten the bolt securely.

To remove the wheel, follow the installation procedure in reverse.

⚠ CAUTION:

- When installing the wheel, be sure to tighten the bolt securely.
- Use only the Makita wrench to install or remove the wheel.

003533

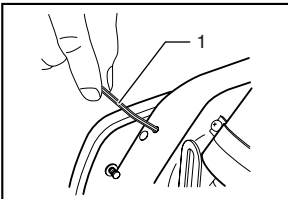

1. Hex wrench

Hex wrench storage

When not in use, store the hex wrench as shown in the figure to keep it from being lost.

003538

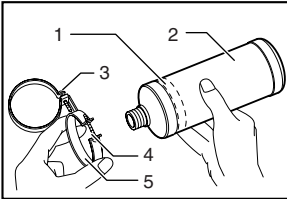

1. Tank holder installing portion
2. Tank
3. Screw (B)
4. Screw (A)
5. Tank holder

Installing water supply

Attach the tank holder on the tank. The tank holder should be attached around the portion shown with the dotted line. Tighten the screw (A) to the extent that the tank can still turn within the tank holder.

003539

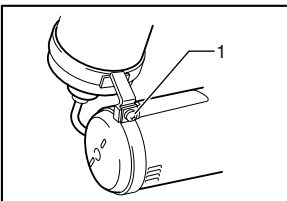

1. Screw (B)

Attach the tank holder onto the motor housing. Tighten the screw (B) securely.

003541

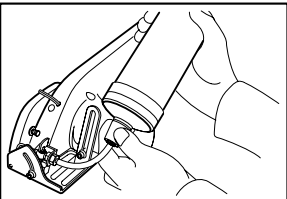

Connect the cap on the end of the polyvinyl tube to the mouth of the tank. Turn the tank clockwise when making the connection. Then tighten the screw (A) securely to secure the tank.

⚠ CAUTION:

- If you find the polyvinyl tube is bent like a "V" or has been strained excessively after installing the water supply, loosen the screw (B) and adjust the position of the tank to alleviate the bent, pinched or strained condition.

003542

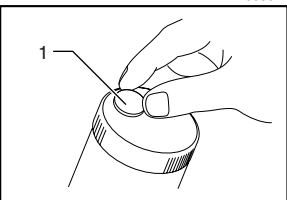

1. Cap

Water supply

Remove the cap on the tank and fill through the hole. Recap the tank. Be sure that the water cock is turned off when filling the tank with water.

⚠ CAUTION:

- When filling the tank with water, be careful not to let the tool get wet.

OPERATION

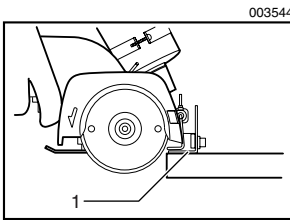

003544

1. Base

Hold the tool firmly. Set the base plate on the workpiece to be cut without the wheel making any contact. Then turn the tool on and wait until the wheel attains full speed. Feed water to the wheel by adjusting the water cock to obtain a gentle flow of water. Move the tool forward over the workpiece surface, keeping it flat and advancing smoothly until the cutting is completed. Keep your cutting line straight and your speed of advance uniform.

For fine, clean cuts, cut slowly. (When cutting glass plate 5 mm (3/16") thick, cut at about 250 mm/min (9-7/8"/min). When cutting tile 10 mm (3/8") thick, cut at about 300 mm/min (11-13/16"/min).) Also slow down as you complete a cut to avoid breaking or cracking the workpiece being cut.

⚠ CAUTION:

- Be sure to hold the workpiece firmly down on a stable bench or table during operation.
- Do not twist or force the tool in the cut, or the motor may be overloaded or the workpiece may break.
- Do not use the tool with the wheel in an upward or sideways position.
- When cutting glass plate, it is recommended to attach a rubber plate (optional accessory) on the base of the tool to prevent the workpiece surface from being scratched.
- The wheel for this tool is a wet-type wheel for glass and tile applications. Be sure to feed water to the wheel during operation.
- If the cutting action of the wheel begins to diminish, dress the cutting edge of the wheel using an old discarded coarse grit bench grinder wheel or concrete block. Dress by pressing lightly on the outer edge of the wheel.

NOTE:

- If the tool is operated continuously until the battery cartridge has discharged, allow the tool to rest for 15 minutes before proceeding with a fresh battery.

MAINTENANCE

⚠ CAUTION:

- Always be sure that the tool is switched off and the battery cartridge is removed before attempting to perform inspection or maintenance.

After use

Brush off accumulation of dust on the base.

To maintain product SAFETY and RELIABILITY, repairs, any other maintenance or adjustment should be performed by Makita Authorized or Factory Service Centers, always using Makita replacement parts.

EN0001-1

Recycling the Battery

The only way to dispose of a Makita battery is to recycle it. The law prohibits any other method of disposal.

To recycle the battery:

1. Remove the battery from the tool.
2. a) Take the battery to your nearest Makita Factory Service Center
or
b) Take the battery to your nearest Makita Authorized Service Center or Distributor that has been designated as a Makita battery recycling location.

Call your nearest Makita Service Center or Distributor to determine the location that provides Makita battery recycling. See your local Yellow Pages under "Tools-Electric".

ACCESSORIES

- These accessories or attachments are recommended for use with your Makita tool specified in this manual. The use of any other accessories or attachments might present a risk of injury to persons. Only use accessory or attachment for its stated purpose.

If you need any assistance for more details regarding these accessories, ask your local Makita service center.

- Diamond wheels
- Hex wrench 4
- Rubber plate
- Various type of Makita genuine batteries and chargers

Cut



First-Class
Postage
Required

Post Office will
not deliver
without proper
postage.

Makita U.S.A., Inc.
14930 Northam Street
La Mirada, CA 90638-5753



Fold

MAIL THIS PORTION

Your answers to the following questions are appreciated.

1. This product was purchased from:

- Home Center Other ()
 Hardware/Lumber Store
 Tool Distributor
 Industrial Supply
 Construction Supply

3. How did you learn about this product:

- Magazine Radio
 From Dealer Exhibition
 Newspaper From Friend
 Store Display Previous Usage
 Catalog Other ()

2. Use of the product is intended for:

- Construction Trade
 Industrial Maintenance
 Home Maintenance
 Hobby
 Other ()

4. Most favored points are:

- Design Repair Service
 Features Durability
 Size Power
 Price Other ()
 Makita Brand

5. Any comments:

DATE PURCHASED			MODEL NO.														
MONTH		DAY		YEAR		SERIAL NO.											
INTL. LAST NAME / COMPANY NAME											STATUS		SEX				
											Married Single		M F				
STREET ADDRESS																	
CITY																	
STATE		ZIP CODE			PHONE			AREA CODE									
AGE:		<input type="checkbox"/> Under 19		<input type="checkbox"/> 20-29		<input type="checkbox"/> 30-39		<input type="checkbox"/> 40-49		<input type="checkbox"/> 50-60		<input type="checkbox"/> Over 60					

BE SURE TO COMPLETE THE CUSTOMER'S PORTION OF THIS FORM AND RETAIN FOR YOUR RECORDS.

Please return this portion by facsimile or mail.

Facsimile No: (714) 522-8133

FACTORY SERVICE CENTERS

1-800-4-MAKITA

RETAIN THIS PORTION FOR YOUR RECORDS

ARIZONA

3707 E. Broadway Rd., Ste. 6
Phoenix, AZ 85040
(602) 437-2850

CALIFORNIA

41850 Christy St.
Fremont, CA 94538-5107
(510) 657-9881

14930 Northam St.
La Mirada, CA 90638-5753
(714) 522-8088

1970 Fulton Avenue
Sacramento, CA 95825
(916) 482-5197

7674 Clairemont Mesa Blvd.
San Diego, CA 92111
(858) 278-4471

16735 Saticoy St., Ste. 105
Van Nuys, CA 91406
(818) 782-2440

COLORADO

11839 E. 51st Ave.
Denver, CO 80239-2709
(303) 371-2850

FLORIDA

750 East Sample Road
Pompano Beach, FL 33064
(954) 781-6333

GEORGIA

4680 River Green Parkway NW
Duluth, GA 30096
(770) 476-8911

ILLINOIS

1450 Feehanville Dr.
Mt. Prospect, IL 60056-6011
(847) 297-3100

MARYLAND

7397 Washington Boulevard,
Suite 104 Elkridge, MD 21075
(410) 476-4401

MASSACHUSETTS

232 Providence Hwy.
Westwood, MA 02090
(781) 461-9754

MINNESOTA

6427 Penn Ave. South
Richfield, MN 55423
(612) 869-5199

MISSOURI

9876 Watson Road
St. Louis, MO 63126-2221
(314) 909-9889

NEBRASKA

4129 S. 84th St.
Omaha, NE 68127
(402) 597-2925

NEVADA

3375 S. Decatur Blvd.
Suites. 22 - 24
Las Vegas, NV 89102
(702) 368-4277

NEW JERSEY

251 Herrod Blvd.
Dayton, NJ 08810-1539
(609) 655-1212

NEW YORK

4917 Genessee Street
Cheektowaga, NY 14225
(716) 685-9503

OREGON

828 19th Avenue, N.W.
Portland, OR 97209
(503) 222-1823

PENNSYLVANIA

1704 Babcock Blvd.
Pittsburgh, PA 15209
(412) 822-7370

PUERTO RICO

200 Guayama St.
Hato Rey, PR 00917
(787) 250-8776

TENNESSEE

1120 Elm Hill P.
Suite 170 Nashville, TN 372
(615) 248-3321

TEXAS

12801 Stemmons Fwy Ste. 809
Farmers Branch, TX 75234
(972) 243-1150

12701 Directors Dr.
Stafford, TX 77477-3701
(281) 565-8665

3453 IH-35 North, Ste. 101
San Antonio, TX 78219
(210) 228-0676

WISCONSIN

Lincoln Plaza Shopping Ctr.
2245 S. 108th St. West Allis, WI
53227
(414) 541-4776

CUSTOMER'S RECORD

<p>When you need service: Send complete tool (prepaid) to one of the Makita Factory Service Centers listed, or to an Authorized Makita Service Center. Be sure to attach a letter to the outside of the carton detailing the problem with your tool.</p>	Date Purchased
	Dealer's Name & Address
	Model No.
	Serial No.

WARNING

Some dust created by power sanding, sawing, grinding, drilling, and other construction activities contains chemicals known to the State of California to cause cancer, birth defects or other reproductive harm. Some examples of these chemicals are:

- lead from lead-based paints,
- crystalline silica from bricks and cement and other masonry products, and
- arsenic and chromium from chemically-treated lumber.

Your risk from these exposures varies, depending on how often you do this type of work. To reduce your exposure to these chemicals: work in a well ventilated area, and work with approved safety equipment, such as those dust masks that are specially designed to filter out microscopic particles.

MAKITA LIMITED ONE YEAR WARRANTY

Warranty Policy

Every Makita tool is thoroughly inspected and tested before leaving the factory. It is warranted to be free of defects from workmanship and materials for the period of ONE YEAR from the date of original purchase. Should any trouble develop during this one year period, return the COMPLETE tool, freight prepaid, to one of Makita's Factory or Authorized Service Centers. If inspection shows the trouble is caused by defective workmanship or material, Makita will repair (or at our option, replace) without charge.

This Warranty does not apply where:

- repairs have been made or attempted by others:
- repairs are required because of normal wear and tear:
- the tool has been abused, misused or improperly maintained:
- alterations have been made to the tool.

IN NO EVENT SHALL MAKITA BE LIABLE FOR ANY INDIRECT, INCIDENTAL OR CONSEQUENTIAL DAMAGES FROM THE SALE OR USE OF THE PRODUCT. THIS DISCLAIMER APPLIES BOTH DURING AND AFTER THE TERM OF THIS WARRANTY.

MAKITA DISCLAIMS LIABILITY FOR ANY IMPLIED WARRANTIES, INCLUDING IMPLIED WARRANTIES OF "MERCHANTABILITY" AND "FITNESS FOR A SPECIFIC PURPOSE," AFTER THE ONE YEAR TERM OF THIS WARRANTY.

This Warranty gives you specific legal rights, and you may also have other rights which vary from state to state. Some states do not allow the exclusion or limitation of incidental or consequential damages, so the above limitation or exclusion may not apply to you. Some states do not allow limitation on how long an implied warranty lasts, so the above limitation may not apply to you.

Makita Corporation of America

2650 Buford Hwy., Buford, GA 30518

Free Manuals Download Website

<http://myh66.com>

<http://usermanuals.us>

<http://www.somanuals.com>

<http://www.4manuals.cc>

<http://www.manual-lib.com>

<http://www.404manual.com>

<http://www.luxmanual.com>

<http://aubethermostatmanual.com>

Golf course search by state

<http://golfingnear.com>

Email search by domain

<http://emailbydomain.com>

Auto manuals search

<http://auto.somanuals.com>

TV manuals search

<http://tv.somanuals.com>