



marantz®

Model PD4292D User Guide

Plasma Monitor





IMPORTANT INFORMATION

PRECAUTIONS

Please read this manual carefully before using your marantz 42 inch Plasma Monitor and keep the manual handy for future reference.



This symbol warns the user that uninsulated voltage within the unit may have sufficient magnitude to cause electric shock. Therefore, it is dangerous to make any kind of contact with any part inside of this unit.



This symbol alerts the user that important literature concerning the operation and maintenance of this unit has been included. Therefore, it should be read carefully in order to avoid any problems.

WARNING

TO PREVENT FIRE OR SHOCK HAZARDS. DO NOT EXPOSE THIS UNIT TO RAIN OR MOISTURE. ALSO DO NOT USE THIS UNIT'S POLARIZED PLUG WITH AN EXTENSION CORD RECEPTACLE OR OTHER OUTLETS, UNLESS THE PRONGS CAN BE FULLY INSERTED. REFRAIN FROM OPERATING THE CABINET AS THERE ARE HIGH-VOLTAGE COMPONENTS INSIDE. REFER SERVICING TO QUALIFIED SERVICE PERSONNEL.

DOC compliance Notice

This class A digital apparatus meets all requirements of the Canadian Interference-Causing Equipment Regulations.

WARNING

This equipment has been tested and found to comply with the limits for a Class A digital device, pursuant to Part 15 of the FCC Rules. These limits are designed to provide reasonable protection against harmful interference when the equipment is operated in a commercial environment. This equipment generates, uses, and can radiate radio frequency energy and, if not installed and used in accordance with the instruction manual, may cause harmful interference to radio communications. Operation of this equipment in a residential area is likely to cause harmful interference in which case the user will be required to correct the interference in which case the user will be required to correct the interference at his own expense.

Warnings and Safety Precaution

The SLIM SERIES PLASMA MONITOR PD4292D is designed and manufactured to provide long, trouble-free service. No maintenance other than cleaning is required. Use a soft dry cloth to clean the panel. Never use solvents such as alcohol or thinner to clean the panel surface.

For operating safety and to avoid damage to the unit, read carefully and observe the following instructions.

To avoid shock and fire hazards:

1. Provide adequate space for ventilation to avoid internal heat build-up. Do not cover rear vents or install in a closed cabinet or shelves.
The unit is equipped with cooling fans. If you enclose the unit in a cabinet or rack, be sure there is adequate space at the top of the unit to allow heated air to rise and escape. If the monitor becomes too hot, the overheat protector will be activated and the monitor will be turned off. If this happens, turn off the power to the monitor and unplug the power cord. If the room where the monitor is installed is particularly hot, move the monitor to a cooler location, and wait for the monitor to cool for 60 minutes. If the problem persists, contact your marantz dealer for service.
2. Do not use the power cord polarized plug with extension cords or outlets unless the prongs can be completely inserted.
3. Do not expose unit to rain or moisture.
4. Avoid damage to the power cord, and do not attempt to modify the power cord.
5. Unplug unit during electrical storms or if unit will not be used over a long period.
6. Do not open the cabinet which has potentially dangerous high voltage components inside. If the unit is damaged in this way the warranty will be void. Moreover, there is a serious risk of electric shock.
7. Do not attempt to service or repair the unit. marantz is not liable for any bodily harm or damage caused if unqualified persons attempt service or open the back cover. Refer all service to authorized marantz Service Centers.

To avoid damage and prolong operating life:

1. Use only with 120 V 50/60 Hz AC power supply. Continued operation at line voltage greater than 120 Volts AC will shorten the life of the unit, and might even cause a fire hazard.
2. Handle the unit carefully when installing it and do not drop.
3. Locate set away from heat, excessive dust, and direct sunlight.
4. Protect the inside of the unit from liquids and small metal objects. In case of accident, unplug the unit and have it serviced by an authorized marantz Service Center.
5. Do not hit or scratch the panel surface as this causes flaws on the surface of the screen.
6. For correct installation and mounting it is strongly recommended to use a trained, authorized Marantz dealer.
7. As is the case with any phosphor-based display (like a CRT monitor, for example) light output will gradually decrease over the life of a Plasma Display Panel.



Recommendations to avoid or minimize phosphor burn-in

Like all phosphor-based display devices and all other gas plasma displays, SLIM SERIES PLASMA MONITOR can be susceptible to phosphor burn under certain circumstances. Certain operating conditions, such as the continuous display of a static image over a prolonged period of time, can result in phosphor burn if proper precautions are not taken. To protect your investment in this Marantz SLIM SERIES PLASMA MONITOR, please adhere to the following guidelines and recommendations for minimizing the occurrence of image burn:

- * Always enable and use your computer's screen saver function during use with a computer input source.
- * Display a moving image whenever possible.
- * Always power down the monitor when you are finished using it.

If the SLIM SERIES PLASMA MONITOR is in long term use or continuous operation take the following measures to reduce the likelihood of phosphor burn:

- * Lower the Brightness and Contrast levels as much as possible without impairing image readability.
- * Display an image with many colors and color gradations (ie. photographic or photo-realistic images).
- * Create image content with minimal contrast between light and dark areas, for example white characters on black backgrounds. Use complementary or pastel color whenever possible.
- * Avoid displaying images with few colors and distinct, sharply defined borders between colors.

Contact Marantz service center at 1-800-270-4533 for other recommended procedures that will best suit your particular application needs.



PDP Monitor burning characteristics

Regarding the subject titled, we hereby furnish you with the following report:

1. Burning

The fluorescent substance used in the plasma module loses its brightness with the lapse of lighting time.

This deterioration in brightness appears to be a difference in brightness in relation to the surroundings, and comes to be recognized as burning.

In other words, the burning is defined as follows: when the same pattern (of the fixed display) is displayed for a long time, a difference in brightness is caused around the lighting area and non-lighting area due to deterioration in the fluorescent substance. When the present pattern is changed over to another one, the boundary comes to be seen between the lighting area and non-lighting area due to difference in brightness in the pattern shown shortly before changeover. If this condition is accumulated, the boundary or burning comes to be seen with the naked eyes.

2. Secular change in brightness

The life of brightness, defined as the reduction to half the initial level, is more than 10 thousand hours on average.

Conditions: All white (100% white) input at an ambient temperature of 25°C.

However, this life time is not a guarantee value for life and brightness. It should be recognized simply as the data for reference.

3. Warranty period

Burning and faults in brightness and picture elements are excluded from the warranty objects.

4. Cause of deterioration in brightness

A major possible cause of deterioration in brightness is damage in the fluorescent substance due to impact caused by ions generated at the time of plasma discharges.

5. Practical value for burning

The deterioration in brightness tends to be accelerated up to 100 hours in the initial period. In the initial period, the fixed display of patterns particularly tends to cause burning. The practical value for burning is difficult to define in concrete numerals. As described below, you are advised to take proper measures to make the occurrence of burning as slow as possible.

6. Proposed measures taken to relieve burning

So long as there is the reduction of brightness in the fluorescent substance, it is impossible to avoid the occurrence of burning. Therefore, to relieve burning, we offer you a method of entering an image input that may ensure reluctance to the generation of the difference in brightness reduction among the displayed dots.

The images from TV broadcasting involve a high rate of motion picture displays.

Therefore, there is less chance of being a cause of difference in brightness reduction among the cells. Even when the fixed patterns are displayed, they generally last for a few minutes. Since the same pattern is less liable to be displayed, there is almost no influence toward burning.

If the fixed patterns tend to be displayed for a long time, however, there occurs a substantial imbalance between the lighting and non-lighting areas, thus causing a difference in brightness as a result. In this paper, we offer you some proposals of installation, paying attentions to the two points: the reduction of difference in brightness achieved by integrated lighting time leveling and the method of edge smearing to make burning hard to be discerned.

The result from these proposals can, however, greatly depend on the contents of images and the operating environment. Therefore, we consider that it is essential to take the suitable measures in consideration of the customer's operating environment.

Example of Proposal 1: The display position is moved while the fixed display pattern is changed over, or it is scrolled during the display.

Example of Proposal 2: If possible, a pattern of complementary color is incorporated (for integrated time leveling).

Example of Proposal 3: The fixed pattern and the motion picture display are reciprocally exchanged, in order to minimize the display period of the fixed pattern.

Example of Proposal 4: During operation, the brightness of screen is suppressed as low as possible. For the display patterns, characters are indicated not on the black ground (non-picture area) but on the colored ground (mixture of R, G, B recommended).

7. Proposed countermeasures for the plasma module

Since the PDP is a display that uses a fluorescent substance like the CRT, it is a fundamental phenomenon that burning occurs. Unlike the CRT, the PDP gives rise to deterioration in the fluorescent substance due to impact caused by ions generated during plasma display.

As a result of the above-mentioned improvements, it is possible to extend the PDP lifetime and relieve the effect of burning, but is impossible to realize the complete elimination of burning so far as a fixed pattern is displayed for a long time.



NOTE:

When you connect a computer to this monitor, attach the supplied ferrite cores. If you do not do this, this monitor will not conform to mandatory FCC standards. Attaching the ferrite cores.

Set the ferrite cores on the both ends of the DVI cable (not supplied), and the one end of the power cable (supplied).

Close the lid tightly until the clamps click.

Use the band to secure the ferrite core (supplied).

DVI cable (not supplied)



Power cable (supplied)

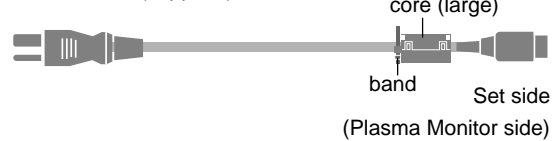

To avoid damage and prolong operating life:

1. Use only with 120V 50/60Hz AC power supply. Continued operation at line voltages greater than 120 Volts AC will shorten the life of the unit, and might even cause a fire hazard.
2. Handle the unit carefully when installing it and do not drop.
3. Locate set away from heat, excessive dust, and direct sunlight.
4. Protect the inside of the unit from liquids and small metal objects. In case of accident, unplug the unit and have it serviced by an authorized Marantz Service Center.
5. Do not hit or scratch the panel surface as this causes flaws on the surface of the screen.
6. For correct installation and mounting it is strongly recommended to use a trained, authorized Marantz dealer.
7. As is the case with any phosphor-based display (like a CRT monitor, for example) light output will gradually decrease over the life of a Plasma Display Panel.

Recommendations to avoid or minimize phosphor burn-in

Like all phosphor-based display devices and all other gas plasma displays, plasma monitors can be susceptible to phosphor burn under certain circumstances. Certain operating conditions, such as the continuous display of a static image over a prolonged period of time, can result in phosphor burn if proper precautions are not taken. To protect your investment in this Marantz plasma monitor, please adhere to the following guidelines and recommendations for minimizing the occurrence of image burn:

- * Always enable and use your computer's screen saver function during use with a computer input source.
- * Display a moving image whenever possible.
- * Always power down the monitor when you are finished using it.

If the SLIM SERIES PLASMA MONITOR is in long term use or continuous operation take the following measures to reduce the likelihood of phosphor burn:

- * Lower the Brightness and Contrast levels as much as possible without impairing image readability.
- * Display an image with many colors and color gradations (ie. photographic or photo-realistic images).
- * Create image content with minimal contrast between light and dark areas, for example white characters on black backgrounds. Use complementary or pastel color whenever possible.
- * Avoid displaying images with few colors and distinct, sharply defined borders between colors.

Contact Marantz service center 1-800-270-4533 for other recommended procedures that will best suit your particular application needs.

Contents

How to Attach Options to the SLIM SERIES 42-inch Plasma Monitor ..	1
Introduction	2
Introduction to the PlasmaSync 42-inch Plasma Monitor	2
The features you'll enjoy include:	2
Contents of the Package	2
Part Names and Function	3
Front View	3
Rear View / Terminal Board	4
LCD Remote Controller RC2000MKII	5
Battery Installation and Replacement	19
LCD remote controller notes	19
Handling the LCD remote controller	19
Operating Range	19
Installation	20
Connecting Your PC Or Macintosh Computer	21
Connections with Equipment that has a Digital Interface ...	21
Connecting Your Document Camera	21
Connecting Your VCR Or Laser Disc Player	21
Connecting Your DVD Player	21
External Speaker Connections	22
Connecting Your PC or Macintosh Computer	23
Connecting Your Document Camera	23
Connecting Your VCR or Laser Player	23
Connecting Your DVD Player	23
Pin Assignments and Signal Levels for 15 pin RGB (Analog)	24
Pin Configuration and Signal of the RGB 3 IN Connector (DVI Connector)	24
Basic Operations	25
POWER	25
To turn the unit ON and OFF:	25
VOLUME	25
To adjust the volume:	25
MUTE	25
To cancel the sound:	25
DISPLAY	25
To check the settings:	25
DIGITAL ZOOM	25
OFF TIMER	26
To set the off timer:	26
To check the remaining time:	26
Canceling the off timer	26
WIDE Operations	27
Watching with a wide screen (manual)	27
When watching videos or digital video discs	27
When watching high definition video source	27
Watching computer images with a wide screen	28
OSM Controls	29
Menu Operations	29
Picture Settings Menu	31
Adjusting the picture	31
Setting the picture mode according to the brightness of the room	32
Setting the color temperature	33
Adjusting the color to the desired quality	34
Reducing noise in the picture	35
Sound settings menu	36
Adjusting the treble, bass and left/right balance	36
Screen Settings Menu	37
Adjusting the Position, Size, Fine Picture, Picture Adj	38
Function Settings Menu	38
Setting the on-screen display	38
Adjusting the position of the menu display	39
Setting the power management for computer images	40
POWER/STANDBY indicator	41
Setting the gray level for the sides of the screen	42
Setting the brightness level to the minimum	42
Setting the picture to suit the movie	43
Resetting to the default values	43
Option setting menu	44
Setting the allocation of the audio connectors	44
Setting the BNC connectors	44
Setting a computer image to the correct RGB select screen	45
Setting high definition image to the suitable screen size	46
Adjusting the display position in the RGB3 input mode	46
Information Menu	47
Checking the frequencies and polarities of input signals	47
Setting the language for the menus	47
Setting the video signal format	48
External Control	49
Table for Signals Supported	57
Supported resolutions	57
Troubleshooting	58
Specifications	59

How to Attach Options to the Plasma Monitor

You can attach your optional mounts or stand to the plasma monitor in one of the following two ways:

- * As it is upright. (See Drawing A)
- * As it is laid down with the screen face down (See Drawing B). Lay the protective sheet, which was wrapped around the monitor when it was packaged, beneath the screen surface so as not to scratch the screen face.

- **This device cannot be installed on its own. Be sure to use a stand or original mounting unit. (Wall mount unit, Stand, etc)**
 - * See page 2.
- **For correct installation and mounting it is strongly recommended to use a trained, authorized Marantz dealer.**

Failure to follow correct mounting procedures could result in damage to the equipment or injury to the installer.

Product warranty does not cover damage caused by improper installation.

Drawing A

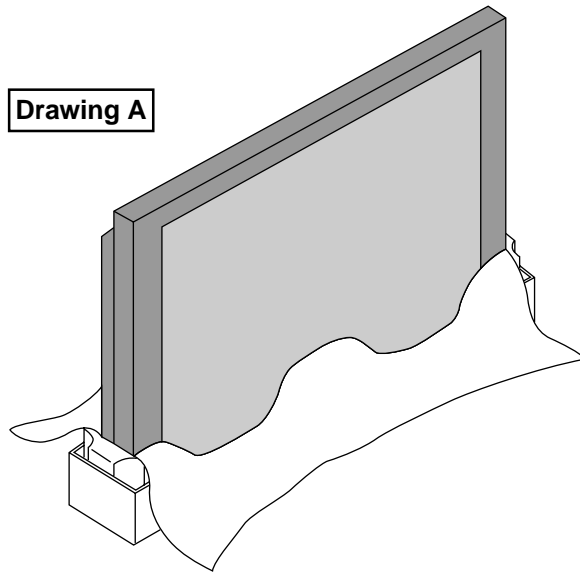

Drawing B

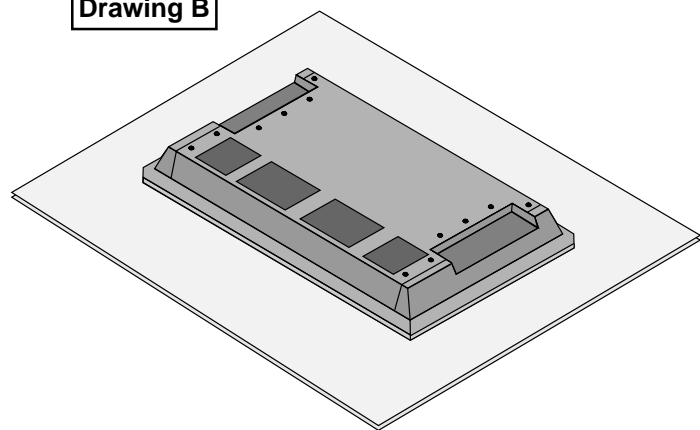

Ventilation Requirements for enclosure mounting

To allow heat to disperse, leave space between surrounding objects as shown on the diagram below when installing.

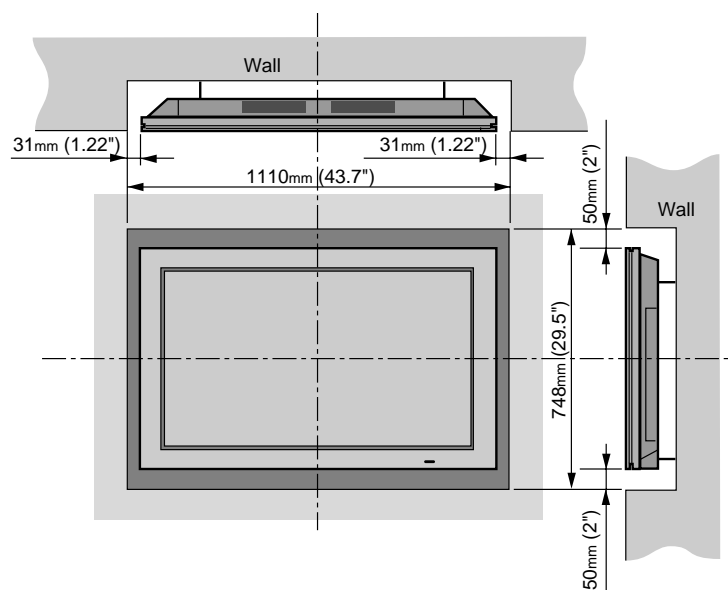

Introduction

Introduction to the SLIM SERIES PLASMA MONITOR

PD4292D is a seamless blend of cutting-edge visual technology and sophisticated design. At 42-inches, with a 16:9 aspect ratio, the PD4292D certainly makes a big impression. However, at a mere 3.5 inches/ 89mm thin, the monitor's sleek techno-art lines blend in well with your environment. Plasma monitor's crisp, vivid image quality will transform data from any graphic medium from PCs to DVD players- into art. And weighing only 70.6 lbs/ 32 kg, it actually can be hung almost anywhere. Marantz has made sure that a host of multimedia resources can be easily connected and displayed as brilliantly as intended on the SLIM SERIES PLASMA monitor.

The features you'll enjoy include:

- 42-inch screen
- 16:9 aspect ratio
- Capsulated Color Filter (CCF) and black matrix
- 3.5 inch / 89 mm thin
- 70.6 lbs/ 32 kg light
- High-resolution screen: 853 × 480 pixels
- 160-degrees of off-axis viewing, horizontally and vertically.
- Flicker - and warp - free display provides excellent image geometry even in screen corners
- Not affected by magnetic fields, no color drift or edge distortion.
- VGA, SVGA, XGA, SXGA(60Hz), computer signal compatibility
- NTSC, PAL, SECAM, composite and S-Video signal compatibility
- 480P, 1080I, 720P and HDTV signal compatibility
- PCs, VCRs, Laser Disc and DVD player source compatibility
- AccuBlend scan conversion automatically converts VGA, SVGA and SXGA signals to the panel's native resolution
- RGB input (3*), Video input (3), DVD/HD input (2*), Audio input (3), External Control input (1)
- AccuColor control system provides user selectable on-screen color temperature settings
- New Drive Technology
- Component video input terminal for DVD, 15.75kHz (Y, CB, CR)
- Marantz's OSM menu-driven on screen control system that makes image adjustments a snap
- Seven languages (English, German, French, Italian, Spanish, Swedish, and Japanese)

* You can select RGB source or Component source for the 5BNC terminal. When selecting an RGB input, the source is switched to the RGB input (3); when selecting a component input, the source is switched to the DVD/HD input (2).

Contents of the Package

- PD4292D plasma monitor
- Power cord
- LCD Remote control unit with four AA Batteries
- User's manual
- Safety metal fitting*
- Screw for safety metal fitting*
- Ferrite core (small × 2, large × 1)

* These are fittings for fastening the unit to a wall to prevent tipping due to external shock when using the stand (option). Fasten the safety fittings to the holes in the back of the monitor using the safety fitting mount screws.

Options

- Tilt mount unit
- Tabletop stand

Part Names and Function

Front View

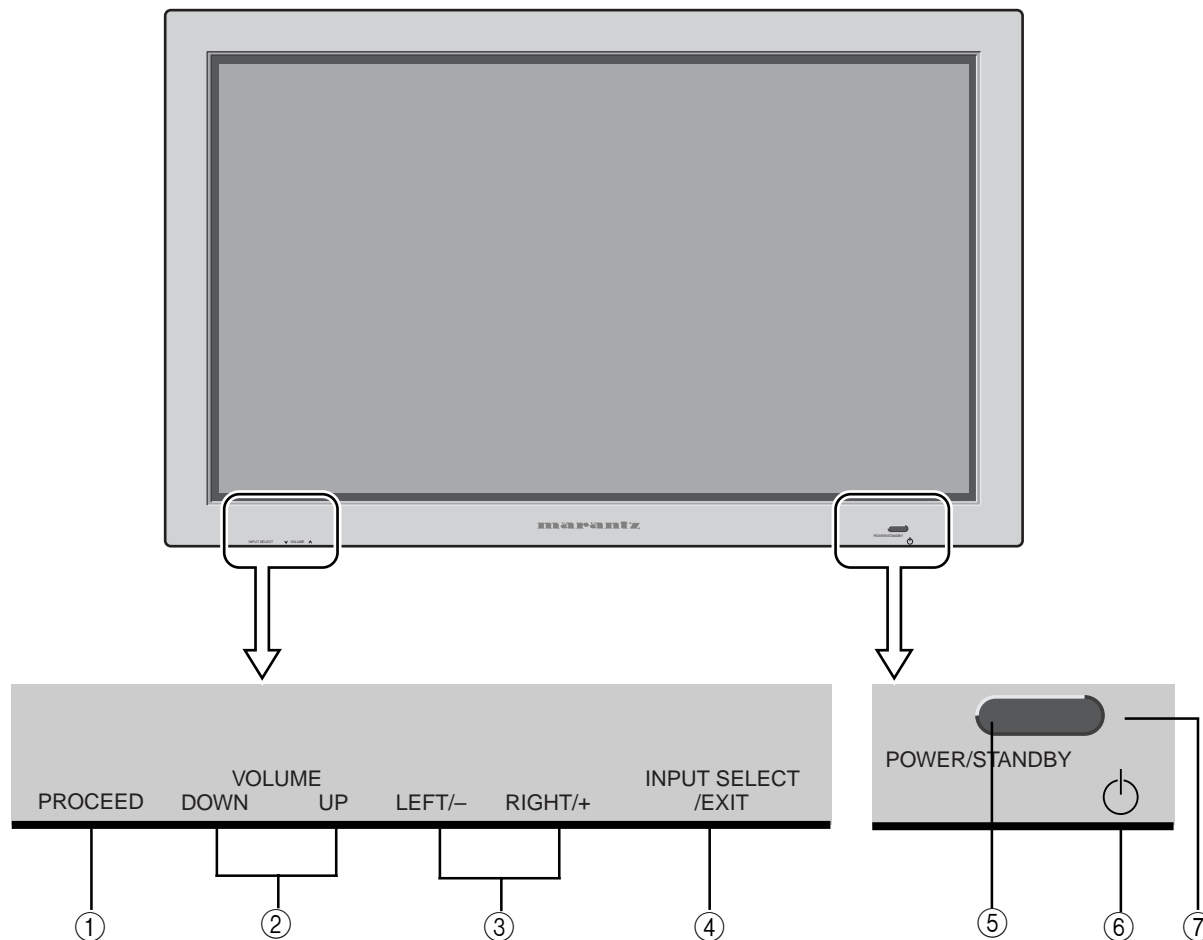

① **PROCEED**

Sets the on-screen display (OSM) mode and displays the main menu.

② **VOLUME Down and Up**

Adjust the volume. Functions as the CURSOR (▲/▼) buttons in the On-screen display (OSM) mode.

③ **LEFT/- and RIGHT/+**

Enlarges or reduces the image. Functions as the CURSOR (◀ / ▶) buttons in the On-screen display (OSM) mode.

④ **INPUT SELECT / EXIT**

Switches the input, in the following order:

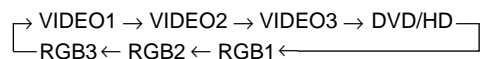

Functions as the EXIT buttons in the On-screen display (OSM) mode.

⑤ **POWER/STANDBY indicator**

When the power is on..... Lights green.
When the power is in the standby mode ... Lights red.

⑥ **Power**

Turns the monitor's power on and off.

⑦ **Remote sensor window**

Receives the signals from the remote control unit.



Rear View/ Terminal Board

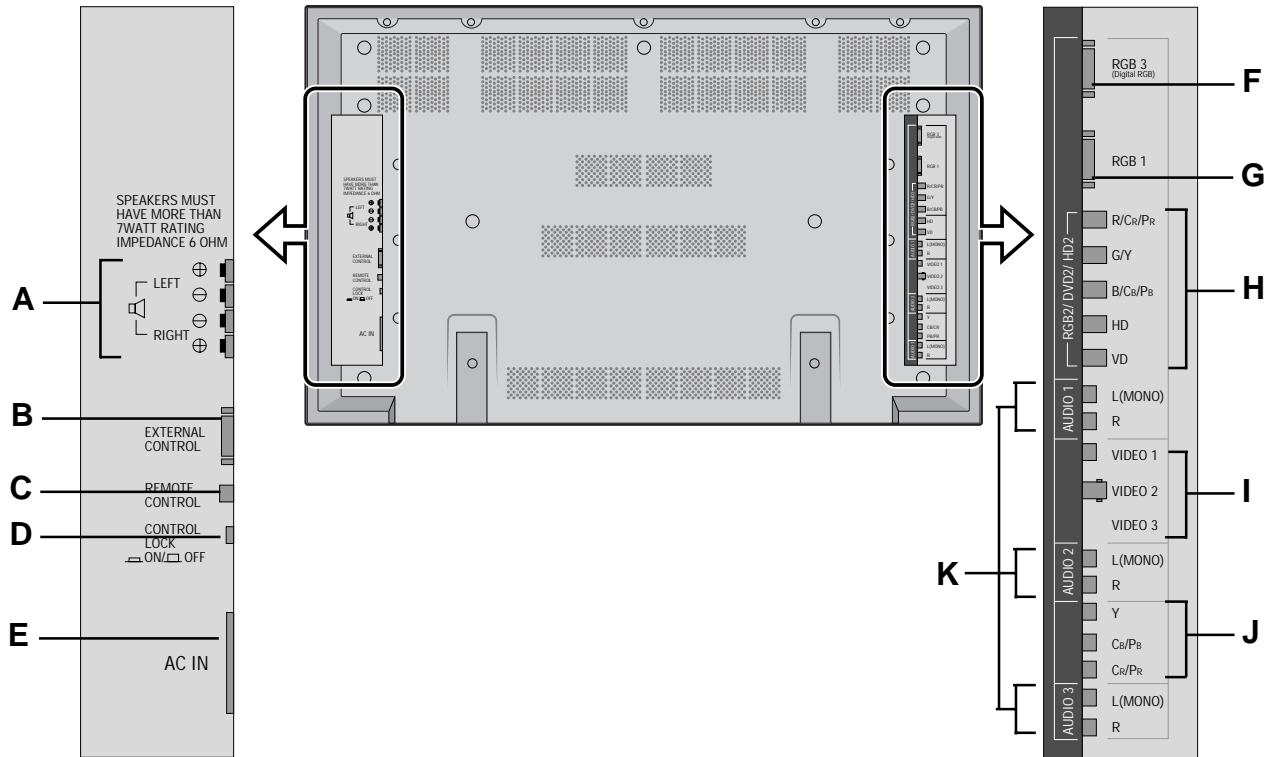

A EXT SPEAKER L and R

Connect speakers here.

B EXTERNAL CONTROL

This terminal is used when power ON/OFF, input selection and AUDIO MUTE and other controls are operated externally (by external control). See also page E-36 for external control.

C REMOTE CONTROL

Connect the supplied remote cable here.

D CONTROL LOCK

When "CONTROL LOCK" is set "ON", the buttons on the set's control panel do not function.

E AC IN

Connect the included power cord here.

F RGB3 (DVI 29pin)

Inputs a digital RGB signal (TMDS).

G RGB1

Inputs the analog RGB signal of personal computer, etc.

H RGB2/ DVD2/ HD2

RGB2: Inputs the analog RGB signal.
DVD2/ HD2: Connect DVD's, high definition Laser Discs, etc. here.

I VIDEO1, 2, 3

Connect VCR's, DVD's or LaserDiscs, etc. here.

J DVD1 / HD1

Connect DVD's high definition LaserDiscs, etc. here.

K AUDIO1, AUDIO2, AUDIO3

These are audio input terminals.
The input is selectable. Set which video image to allot them to on the menu screen.



LCD REMOTE CONTROLLER RC2000MKII

- The remote control unit provided with the Plasma monitor is a “learning”-type, programmable unit capable of controlling almost any component in your system, as well as the Marantz D-BUS components (RC-5). The components to be controlled can be selected with ten buttons.

OPERATION

The provided remote control unit (RC2000MKII) is a system remote controller. The POWER button 5, 10-key numeric buttons 12 and control buttons 15 are used in common across different input source components.

The input source system controlled with the RC2000MKII, such as receiver and AV amplifier changes the input when one of the input selector buttons 9 is pressed.

Example: To select the LD player as the input source for receiver and play an LD on it

Press the LD button twice within 2 seconds.

The input function of the receiver is switched to LD and the RC2000MKII is set for control of the LD player.

Press the PLAY button ► to play an LD.

FUNCTION AND OPERATION

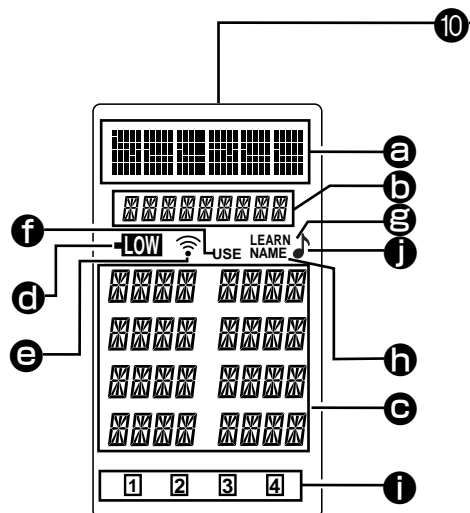

1 MODE (operating mode)

This button is used to change from normal operation to the learning mode, and is used when “learning” commands from other brands of A/V components. Each time this button is pressed (using a small pointed instrument, such as the tip of a paper clip) the mode changes as follows: LEARN → USE → NAME. As the mode changes, the LCD display will show which mode is currently selected.

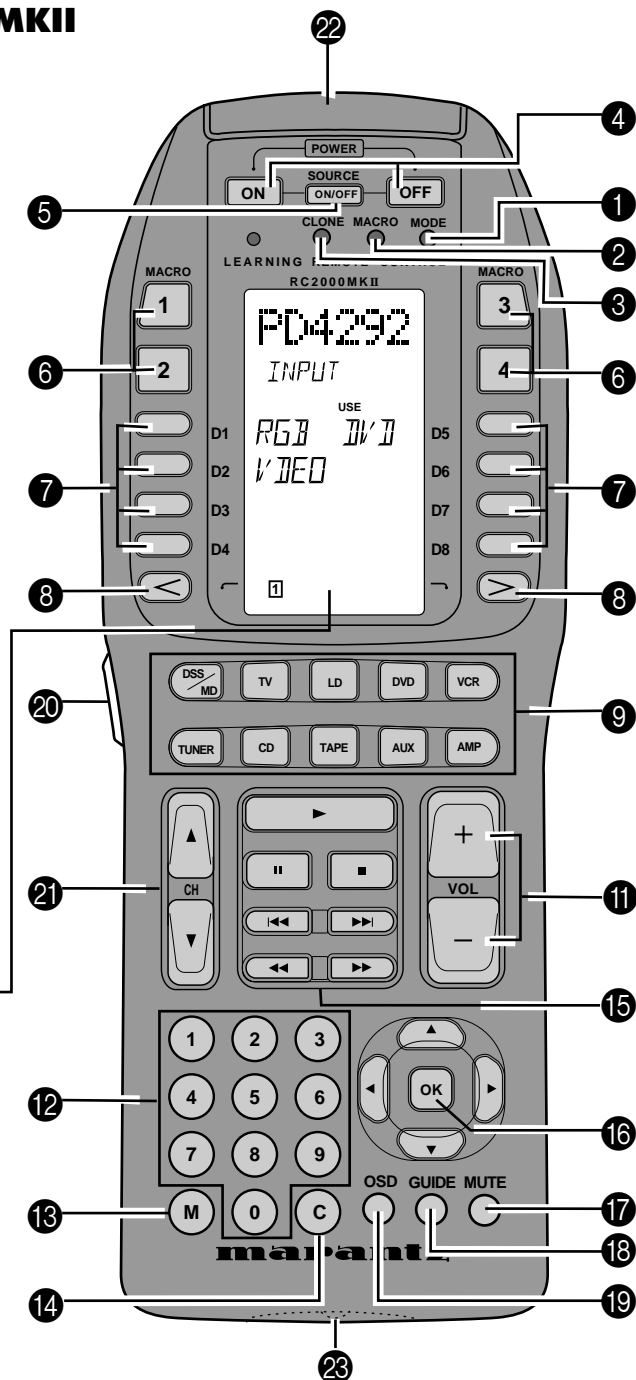

2 MACRO (for multiple step macro functions)

This button is used to memorize a series of functions. When this button is pressed, the RC2000MKII changes to macro programming mode, and is ready to learn a sequence of remote control commands.



3 CLONE

The RC2000MKII has the ability to “replicate” itself, downloading all of its internal pre-programmed and user-programmed commands to another RC2000MKII. This button is used when you wish to “teach” another RC2000MKII all of the customized commands you’ve already programmed in this RC2000MKII.

4 POWER ON and OFF

These two buttons are used to turn the main component’s (amplifier or receiver) AC power on and off. We provide both ON and OFF commands so that your A/V system is remote compatible with external infrared controllers, such as in-wall key pads, etc.

5 SOURCE ON/OFF

This button is used to turn the AC power on and off to any of your A/V source components that have their own remote control turn-on and turn-off commands, such as TV, laser disc player, VCR, etc.

6 MACRO 1-4

Each of these 4 buttons can be programmed with a “string” of commands, called a macro, to initiate a sequence of remote codes to achieve a particular result. For example, a macro button could be programmed to turn on the main system power, then turn on a particular source component (such as a laser disc player), then turn on the PD4292D, and then adjust the surround processor to the home theater surround decoding mode, then activate the laser disc player’s PLAY function. This means that by pressing one macro button, you can achieve the same result as pushing up to 20 buttons in sequence.

7 DIRECT

With today’s high performance A/V systems, it is not unusual for each component in your system to have dozens of specialized command functions. If we were to duplicate all of those commands for each component onto the RC2000MKII key pad, we could easily exceed 300 buttons for an entire home theater system, which would result in either a huge key pad, or buttons of infinitesimal size. The DIRECT command buttons (4 on each side of the LCD display, 8 total) work with the PAGE buttons (4 pages for each source component) to provide up to 32 dedicated specialized functions for each of the 10 function input selectors. Each DIRECT function may also be provided with an alpha-numeric function indicator visible in the LCD display. You may even change the displayed name of each function to another name, if you wish.

8 PAGE

Used to select any 1 of the 4 pages of 8 functions for each DIRECT button, as explained above.

9 FUNCTION

Press one of these buttons once or twice to select a particular source component. For example, to set the amplifier or receiver to the laser disc input, press the LD button twice within 2 seconds. Along with the source selection, special functions may become available (the DIRECT keys), as well as activating the transport function keys, so that you can now directly operate the laser disc player from the RC2000MKII. If you wish, you may even re-program the status indicators in the LCD window to reflect your own particular function name whenever that source (function) button is selected.

Here are the button names and their functions:

LD	: Laser disc player
TV	: Plasma Monitor PD4292D
VCR	: Video cassette recorder
DSS/MD	: Digital satellite decoder or mini disc player
AUX	: Can be used for an auxiliary source component
TUNER	: AM/FM tuner, or AM/FM tuner section of a receiver
CD	: Compact disc player or changer
TAPE	: Audio tape deck, or digital audio recorder
AMP	: Amplifier or receiver control functions
DVD	: Digital video disc player

Note: Press a function selector button only once to select the LD player, etc.

Remember, when you press a function selector button only once, the RC2000MKII will not send out a remote control code to instruct the amplifier or receiver to change to that corresponding input, but the RC2000MKII keypad and DIRECT function commands will provide the selected component’s specialized remote control codes. Press a function selector button twice within 2 seconds to change the function of the amplifier or receiver.

For example, if you press the LD function button twice within 2 seconds, the amplifier or receiver’s input will immediately be switched to the laser disc input, and the keypad and DIRECT function commands for laser disc operation will be activated. Press the CD function button only once, the amplifier or receiver’s input will not switch to the CD input, however the RC2000MKII keypad and DIRECT function commands for compact disc operation will be activated.

We have provided 10 popular function command selector buttons, based upon the typical input selections available with most quality A/V amplifiers (or receivers) including popular Marantz models.

The function button DSS/MD is a little different from the others, in that when you press this button, the RC2000MKII will send out a command to the amplifier or receiver to switch to the DSS input, and then the

RC2000MKII keypad and DIRECT function commands will be configured for DSS (digital satellite system) control. We have included DSS commands within the RC2000MKII's pre-programmed memory for RCA brand DSS equipment. If you have another brand of DSS, you can "teach" the RC2000MKII with the remote control codes of your equipment.

10 LCD window

The LCD window provides a wealth of information, including function selection name, DIRECT function names, learning and programming steps, as well as useful indicators for battery status, and helpful indicators. The LCD window features back-lighting, making it easy to view when the room ambient light is very low.

11 Volume up (+) and down (-)

Used to raise and lower the main system volume level. Note that these buttons are clearly the largest size, and are conveniently located and contoured for easy operation, even in low lighting.

12 Ten keypad

Like a telephone key pad, the ten number buttons (0-9) are used to enter numeric digits, useful for finding a specific track on a CD, or to tune a pre-set radio station, etc.

13 MEMO

This button is used to program your CD player's track memory, or to enter a VCR recording program, and can be used to provide the MEMO function included with other components in your system.

14 CLEAR

This button is used to cancel certain memory or programming operations.

15 Transport control functions

These buttons provide transport commands for your source components, such as laser disc player, CD player, VCR, audio tape deck, etc., and are dependent on the function source selected. For example, when the RC2000MKII is set to LD (laser disc) mode, the transport keys will operate the laser disc player's PLAY, STOP, PAUSE, FAST FORWARD, FAST REVERSE, NEXT and PREVIOUS track functions. Change the RC2000MKII function selector to VCR, and these keys will then operate the VCR's transport command functions, etc.

16 CURSOR buttons

Some components feature menus that are navigated with up, down, left and right direction commands. The cursor buttons can be used to navigate within on-screen menus, for components such as amplifier or receiver, PD4292D, DSS/satellite tuner, etc. These buttons are also used for certain RC2000MKII programming functions.

17 MUTE

For those components (such as amplifier or receiver, etc.) with a mute function, this button can be used to mute the sound temporarily.

18 GUIDE

This button is intended for owners of DSS (digital satellite system) or similar equipment, to activate the on-screen programming guide, used when changing channels etc.

19 OSD (On Screen Display)

Some components, such as an amplifier or receiver, PD4292D, etc., feature on screen display for operation and/or programming. The OSD button can be used to activate the on screen display, or turn it off if desired.

20 LIGHTING

Press this button to activate the back-lit LCD screen and back-lit keys independently SETUP mode. A quick touch is all that is necessary. The back-lighting will remain on for 3 seconds. If you wish, you can even re-program the RC2000MKII to shorten or lengthen the amount of time the back-lighting is activated when this button is pressed.

21 Channel up(▲), down(▼)

Press this button to change the tuner, DSS or VCR pre-set channels to upward or downward.

22 Transmitter window

Infrared signals will emanate from behind this window. Simply aim the RC2000MKII towards the component(s) you wish to control. You may find that the RC2000MKII works fine when placed on a coffee table pointing towards your A/V system components.

23 Receiving window

Used when learning commands from other remotes, this window is placed at the bottom of the RC2000MKII, so that the two remotes are vertically oriented for easy transfer of remote control information. Later in this guide we will show you which of the RC2000MKII buttons can be "taught" new commands from other components.



Liquid Crystal Display (LCD) Window

Within this display, all operating messages (function name, mode names, etc.) are shown. When a particular button is pressed (such as a transport command, like PLAY), its status will be shown in the display for 1 minutes. The display will continue to show the source function selected continuously, however.

Ⓐ Function indication:

The selected source function is displayed, such as LD, TV, etc., up to 6 characters maximum.

Ⓑ Status indication:

The selected status of the present page, or other items, is displayed, up to 9 characters maximum.

Ⓒ Direct commands:

8 DIRECT commands are available in 1 page, up to 4 characters maximum.

Ⓓ Battery indicator:

When the batteries are running low, this indicator will become visible. At this point, it will not be possible to learn any new remote codes, but normal remote control operation is still provided (including the use of any previously learned codes). At this point, you should consider changing the batteries soon. As time goes on, and the battery power diminishes further, this indicator will begin blinking. At this point, no remote commands will be transmitted. This is your signal to replace the batteries with fresh ones as soon as possible. Eventually, if you ignore the blinking battery indicator and do not install fresh batteries, then the batteries may eventually be totally exhausted, and the LCD display window will be completely blank. However, any previously learned commands and macros will not be erased from the microprocessor's memory.

The RC2000MKII is supplied with a full set of RC-5 remote control codes in permanent (non-volatile) memory. Even if the batteries are fully exhausted, the RC-5 codes (used for Marantz A/V components) and learned codes will never disappear.

We recommend that you use a quality brand of alkaline batteries, for best results and longest life. Newly available lithium "AA" batteries can even provide longer life than alkaline batteries, and are also recommended.

Ⓔ Transmit indicator:

When a button is pressed, this indicator shows that an infrared code is being transmitted.

Ⓕ USE indicator:

For normal operation, the USE indicator should be visible.

Ⓖ LEARN indicator:

Visible when the RC2000MKII is set to LEARN mode.

Ⓗ NAME indicator:

Visible when the RC2000MKII is in the learning mode, and function naming is being changed.

Ⓘ PAGE or MACRO indicator:

This indicator usually functions in association with the PAGE button **n**, but also functions as the MACRO indicator when the MACRO button **n** is pressed.

⓷ Beep indicator:

Visible when the RC2000MKII is set the beep function.

Installing the batteries:

The battery compartment is located on the rear panel. Please use only alkaline or lithium batteries, "AA" size. The RC2000MKII requires four AA batteries. There are markings in the battery compartment to show you the proper battery orientation. If after installing the batteries, you cannot see any indication in the LCD window when a button is pressed, re-check to ensure that the batteries are properly positioned in the compartment.



RC2000MKII Basic Operation

USE Mode:

As supplied from the factory, the RC2000MKII is already permanently programmed with many pre-set commands common to Marantz and Philips equipment, as well as other brands of components that utilize the Philips RC-5 remote control language.

1. If the RC2000MKII is in another mode (LEARN, etc.), press the operation mode button [1] with the tip of a paper clip, until the USE indication appears.
2. Press one of the function buttons [9], such as LD (refer to Figure 1).

Figure 1

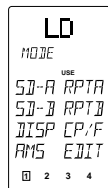

3. "LD" will be indicated within the LCD window, and the function codes will be set to operate the laser disc player, press the function button again within 2 seconds as well as changing the amplifier or receiver's input to laser disc.
4. Now you can operate the laser disc player. When a button is pressed, the  symbol indicates that a remote code is being transmitted. Note that for a particular source component, not every button may have a command programmed for it. In that case, nothing would be indicated.
5. Using the DIRECT buttons D-1 through D-8, PAGES 1 through 4, up to 32 different specialized commands are available for each FUNCTION, up to a total of 320 specialized commands (32 direct commands times 10 functions). Note that for any particular function selector, not all 32 direct commands may be provided and/or named as supplied from the factory.
6. For example, the RC2000MKII is supplied from the factory with 3 pages of DIRECT commands for the LD (laser disc) function. To change pages, press the page direction ◀ or ▶ buttons [8]:

Page 1: MODE: Side A/B laser disc playback functions
 Page 2: L D: Specialized laser disc functions
 Page 3: R E C: Recording from laser disc to VCR functions

At this point, you may wish to put this guide aside temporarily, and begin using the RC2000MKII with your A/V system. If you already have any Marantz components, or Philips and/or other brands of components that use the RC-5 remote control language, you can begin controlling those components with the RC2000MKII right away. Take some time to become comfortable with the operation of the RC2000MKII. We think that its intuitive key pad layout and easy to read LCD window will permit you to quickly become familiar with its operation.

If you do not have any Marantz or other brands of components that use the Philips RC-5 remote control language, then you may wish to proceed to the next section, which will describe the steps necessary to "teach" your RC2000MKII remote codes from other components you may have in your system.

LEARN mode:

The RC2000MKII has the ability to learn remote codes for just about any component in your A/V system. If the original component was supplied with an infrared remote control, its commands can be learned by the RC2000MKII. If you have another brand of laser disc player, for example, you can program the RC2000MKII with its codes.

For example, we'll show you how to "teach" the RC2000MKII commands from another brand of laser disc player.

1. Using a sharp point (such as the tip of a paper clip), press the operation MODE button [1]. Within the LCD display, the LEARN indicator will begin blinking.
2. Place the laser disc player's supplied infrared remote controller so that its transmitter window (usually at the top) is facing the infrared sensor window of the RC2000MKII (at the bottom), about 5 cm (2 inches) apart.
3. Press the LD function button on the RC2000MKII.
4. Press the play button [5] on the RC2000MKII.

5. Press and hold the corresponding play button on the laser disc player's remote transmitter until the "OK" indicator appears in the RC2000MKII LCD window (see Figure 2) or the beeps sounds emit (if the beep sound function is set).

Figure 2

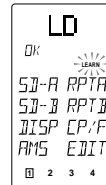

If the "AGAIN" indicator appears in the RC2000MKII LCD window, it means that for some reason the command was not properly learned. Repeat steps 3, 4 and 5 above.

In the unlikely event that an infrared command cannot be learned by the RC2000MKII, "NG" (no good) will appear in the LCD window, meaning that the command is not "learnable". The RC2000MKII has been tested for compatibility with a very wide range of infrared remote control frequencies and data word lengths, but in some very rare instances, it may not be possible to learn a particular remote control command.

Continue to "teach" the RC2000MKII the rest of the source transmitter's transport function commands, such as stop, pause, next, previous, fast forward and rewind, by repeating steps 3, 4 and 5 above.

6. Proceed to learn the numeric "10 keys" from the source transmitter to the RC2000MKII's 10 key numeric pad/2 by repeating steps 3, 4 and 5 above.
7. For each additional function, such as TV, VCR, etc., repeat steps 3, 4 and 5 above. During the LEARN operation, if any button is not pressed within 1 minute, the RC2000MKII will revert back to the previous (non-LEARN) operating mode (USE).
8. After memorizing all desired remote codes, press the operation mode button [1] with the tip of a paper clip, and select the USE mode. The LCD display window will continue to display the USE indicator, and all of the newly memorized codes will be available (see Figure 3).

Figure 3

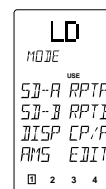

For any button for which a new code was not learned, the factory programmed RC-5 code will still transmit as usual.

Note: POWER ON/OFF [4] code can be learned regardless of the function button selection:

Programming the DIRECT mode buttons [7]:

The following example will show how to memorize the SIDE-A function command of another brand of laser disc player into the D1 direct button.

1. Using a sharp point (such as the tip of a paper clip), press the operation MODE button [1] to switch the RC2000MKII to LEARN mode.
2. Place the laser disc player's supplied infrared remote controller so that its transmitter window is facing the infrared sensor window of the RC2000MKII about 5 cm (2 inches) apart.
3. Press the LD function button [9] on the RC2000MKII.
4. Using the direct function page keys ◀ and ▶ [8], set the direct function to Page 1. Press the D-1 button [7] on the RC2000MKII.



- Press and hold the corresponding SIDE-A button on the laser disc player's remote transmitter until the "OK" indicator appears in the RC2000MKII LCD window or beep sounds emit. The RC2000MKII changes to the RENAME mode automatically as next step. A function name of the DIRECT function button is blinked, you can re-name this blinking function name. You input the desired letter or number with the ten keypad. (See the table in step 3 of the next procedure to refer.) If you need not to rename, press the OK button and other button except the ten keypad.
- Now, proceed to program the other commands from the laser disc player's remote transmitter to the other DIRECT function buttons (D2-D8). When you have "taught" all 8 direct functions for Page 1, press the page direction key \blacktriangleright [8] to go to Page 2, and you can program more direct function keys.
- After memorizing all codes to all DIRECT function buttons, press the operation MODE button [1] with the tip of a paper clip and return the RC2000MKII to the USE mode. Now, the newly memorized codes are usable from the RC2000MKII.

If you wish, you can re-write the names for each function name, status name, and the direct function command names as follows:

For our example, you can change the LCD display window indication from "LD" to "LV-520" (which is the model number for a Marantz laser disc player). Remember, you can re-name a function selector button with a new name of up to six characters of letters and numbers in any combination.

- Using the tip of a paper clip, press the operation MODE button [1] until the NAME indicator appears and begins to blink in the LCD window.
- Choose a button that you wish to re-name, in this case, press the "LD" function button [9]. In the LCD window, the first character of the six function character display indicators starts blinking "A", which is the first letter of the alphabet.
- Choose the desired letter or number by pressing the 10 keypad buttons [12]. Each 10 keypad button has 4 characters attached to it as follows:

10 key pad button	Press, press again, press again, etc.
1	1 → A → B → C → 1 →etc.
2	2 → D → E → F → 2 →etc.
3	3 → G → H → I → 3 →etc.
4	4 → J → K → L → 4 →etc.
5	5 → M → N → O → 5 →etc.
6	6 → P → Q → R → 6 →etc.
7	7 → S → T → U → 7 →etc.
8	8 → V → W → X → 8 →etc.
9	9 → Y → Z → / → 9 →etc.
0	0 → + → - → SPACE → , → ' → 0etc.

So, in the above example, by pressing the 10 keypad number 4 four times, you get the letter "L" to appear in the display (see Figure 4).

Figure 4

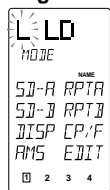

- You use the cursor buttons \blacktriangleleft and \blacktriangleright [16] to move to the next character in the display. By pressing the right cursor button \blacktriangleright , the letter "L" is confirmed in the first character space in the LCD window and the next character position begins blinking. If you wish to erase a previously memorized character, position the cursor over the character and put the SPACE character in its place (the SPACE character is ten key pad number 0 pressed four times, from the above character chart).
- Continuing along, re-write the remaining letters "V", "-", "5", "2", and "0". By pressing the cursor keys \blacktriangleleft and \blacktriangleright , each character is confirmed in place. When you go to other DIRECT function pages by using the page function keys [8], characters in the previous page are also confirmed in place.

The name re-writing operation must be done on a function by function basis, that is, re-write the names for all of the LD direct functions, then switch to another function such as VCR, and begin the re-writing process anew to re-name the VCR direct function commands.

How to re-write the STATUS name:

Using the same steps as outlined above, you can re-write the 9 character status name. During step 5 above, by pressing the up and down cursor keys \uparrow and \downarrow the left side of the status indicator begins blinking, and you can change its display according to the same method outlined above, using the 10 keypad character generator. Remember, to confirm each character change, use the cursor keys \blacktriangleleft and \blacktriangleright . As above, when you change the direct function page by pressing the page direction keys [8], this will confirm the re-written characters in place as well for the page you just finished re-naming. You have up to 9 letters, numbers or other characters available for each status name.

How to re-write the DIRECT function button names:

You can change the name for each of the 8 direct function buttons by using the steps described above to change main function name and status name. Remember, each main function has 8 direct function buttons on each of the 4 pages, so you have up to 32 direct functions that can be re-named, if you wish, for each of the 10 main function selection buttons [9]. You have up to 4 characters available for each direct function button name.

After completing all re-writing of any of the names, press the OK button within the cursor keys [16], or switch to another function button (such as CD). If, during re-naming, a button has not been pressed for 1 minutes, the RC2000MKII will revert to the prior operating mode (USE) automatically.

If re-writing of all of the desired direct mode functions has been completed, use the pen tip to press the operation MODE button [1], and select the "USE" mode. Now, all of the re-written names are available for use.

How to clear (erase) the memorized codes (and any re-written names):

The RC2000MKII has a high capacity RAM, which ordinarily will allow the learning of several hundred remote codes (and their associated new names, if desired). However, due to the fact that some remote codes occupy more memory space than others, it is possible that the available RAM fills up completely, and the "FULL" indicator appears in the LCD window. In this case, it will not be possible to learn any new remote codes without first deleting some or all of the previously learned remote codes and/or re-written names. There are 4 ways to erase learned remote codes from memory:

- Erasing by button(s)
- Erasing by DIRECT button(s)
- Erasing by function(s)
- Erasing all memory contents (complete erasure)
- Note that the factory-programmed RC-5 codes are not stored in RAM, and are therefore not erasable.

For any of these memory erasure options, you must first set the RC2000MKII to LEARN mode.

Erasing the memory assigned to a particular button:

Press and hold the CLEAR button [4] and press the button that you wish to erase 2 times. The code previously learned by that button will be erased, and will then be either empty, or the original factory provided RC-5 code will re-appear in its place.



Erasing the memory assigned to a DIRECT buttons:

All codes and names which were previously memorized for each of the functions (such as TV, LD, VCR, etc.) in pages can be erased. Press and hold the CLEAR button [14] and press the < or > button [8] 2 times. You will see the "DIR- CLR?" (direct button - clear?) indication in the LCD window (see Figure 5). If you wish to go ahead and clear all of the memorized codes for that DIRECT button (8 buttons × 4), press the OK button

Figure 5

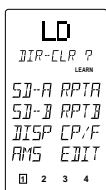

Erasing the memory assigned to each function command set:

All codes and names which were previously memorized for each of the functions (such as TV, LD, VCR, etc.) can be erased.

Press and hold the CLEAR button [14], and press the function button that you want to erase 2 times. You will see the "FNC - CLR?" (function - clear?) indication in the LCD window (see Figure 6).

Figure 6

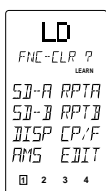

If you wish to go ahead and clear all of the memorized codes for that function button, press the OK button within the cursor keys/6. After clearing the memory contents for that function, the RC2000MKII will restore any factory programmed RC-5 codes for the function, if any, or will simply be empty.

If you want to cancel the memory clear operation, do not press the "OK" button, but instead simply touch any other button. When you clear all the commands associated with a function button, all of the learned direct function commands (D-1 through D-8, pages 1 through 4) and control buttons, ten keypad, etc are cleared as well.

Complete erasure:

While holding the CLEAR button [14] depressed, press both of the ON and OFF POWER buttons [4] simultaneously; "ALL-CLR?" is displayed on the LCD window (see Figure 7).

Figure 7

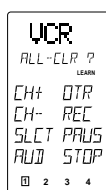

If you wish to finalize the complete erasure process, press the OK button within the cursor keys [16]. If you do not wish to proceed with the complete erasure process, simply press any key other than OK. Remember, the RC-5 codes as supplied from the factory cannot be erased from memory, but they can be replaced with different codes as you wish.

- By now, you have learned how to memorize codes from other brands of components, including changing the various function, status, and direct function names.

Before continuing on to the more advanced RC2000MKII programming techniques, you may wish to continue "teaching" the RC2000MKII remote control with any or all other commands for other components in your system. When you feel you've transferred as many different commands from other components into the RC2000MKII as you'd like, and possibly changed some or all of their names as well, then feel free to proceed to the next section.

- The all-clear operation takes about 15 seconds after the OK button is pressed.

Advanced Programming Techniques

Macro mode:

The word "macro" is used to describe a series of specific steps carried out in sequence. For example, a word processing program can use macros to carry out common repetitive typing tasks. During the day to day operation of an A/V system, you might find yourself pressing the same combination of remote control buttons often.

The RC2000MKII features the ability to "learn" a sequence of infrared commands, and "assign" that sequence to a single button, called a MACRO button [6]. Then, when you want to achieve a specific result, you can activate a macro button to begin sending out a series of commands. For example, suppose you wish to activate your A/V system, and watch a movie on laser disc. A single macro button could send out the following commands in this suggested sequence:

- Turn the main amp power on, then turn the TV power on, then switch the TV to the AUX video input, then change the amp to the laser disc (LD) input, then turn the LD player power on, then activate the LD play command, then set the amp surround sound mode to Dolby Pro Logic.

The above 7 step sequence can be programmed into a single macro button, and can be used anytime you want to watch a LD movie. Other macro functions could be used for CD listening, or any other sequence of steps that you regularly perform while controlling your A/V system.

Macro commands are available when the RC2000MKII is set to either USE modes.

To program a macro, first identify which commands you wish to memorize, and note if any commands must be in a specific order (for example, before you can activate an amplifier's surround mode, the amp must first be turned on).

1. Press the MACRO [2] operation mode button with the tip of a paper clip. Within the LCD window, the MACRO indication appears, then the LEARN indicator starts blinking (see Figure 8).

Figure 8



If a macro was previously programmed, one or more of the numeric indicators at the bottom of the LCD window will appear with a box around it.

2. Press macro button 1 [6] to begin memorizing the various codes. In the LCD display window the indicator "M1-00" appears in the status line b (see Figure 9).

Figure 9

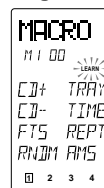

The "M1-00" indication signifies Macro number 1, no steps yet programmed. As each macro step is programmed, the "00" indicator will advance by one digit-"01", "02", etc. After the first macro step is programmed, two additional digits (with a decimal in between) become visible at the end of the status line, showing the timing value for each step (see Figure 10).

Figure 10





- Press the command buttons in the desired sequence. When you press a command button to be learned into the macro sequence, its name will appear within the LCD window. Every time you press another remote command, the macro step number increases one by one.
- It is possible during macro programming to adjust the timing of the interval between several macro steps. Using the cursor keys \leftarrow and \rightarrow , the interval between macro playback steps can be increased or decreased in 1/2 second steps, over the range beginning at 1/2 second up to 10 seconds. For example, when the indicator shows "0.5 SEC", if you press the \leftarrow direction key, the interval time would change to 10 seconds, then with another press of the \leftarrow direction key, it would change to 9.5 seconds, etc. Use the \rightarrow direction key to increase the interval time, and use the \leftarrow direction key to decrease the interval time. Some equipment may not be able to receive infrared commands in one-half second steps. If after programming a macro you find that the sequence was not properly carried out, you may wish to experiment with different sequence timings to obtain the correct operation results, by using the adjustment method described above. Within each macro button, up to 20 steps can be memorized. In the event that you wish to memorize more than 20 steps per macro, then press another MACRO2 button [6], and follow the above operations. A maximum of 80 steps can be programmed this way. However, you will probably find that 20 steps is more than enough to carry out even the most complex macro instructions to achieve a specific home theater operating result.

Note: To memorize the cursor button [6], press and hold the LIGHTING button [20] before pressing the cursor button.

When programming macro steps, note that the following buttons would not normally be included in a macro sequence, and are therefore not available for inclusion in a macro:

MODE [1], MACRO [2], CLONE [3], PAGE [8], VOLUME [11], MEMO [13], CLEAR [14] and LIGHTING [20].

To check to see which MACRO buttons [6] have been programmed with macros, at the beginning of the macro learning sequence the four numerical (1 through 4) indicators at the bottom of the LCD window will show a box around the number for each MACRO button that already has a macro assigned to it (see Figure 11, which shows that only MACRO button number 1 has a macro assigned to it).

Figure 11



In the event that you wish to revise a programmed macro sequence, search the step number you wish to change by using the cursor button \blacktriangle and \blacktriangledown , and then re-enter the new command. If you memorized different commands than have already been programmed, then the previous macro sequence will be erased and re-written over with the new sequence. To add the new command, press the MEMO button at your desired point. To delete the sequence, press the CLEAR button at your desired point.

During macro programming, if a button is not pressed within 1 minutes, the mode will automatically revert to the original mode (USE).

When you have completed the macro programming sequence, press the MACRO [2] operation button with the the tip of a paper clip. The "END" indication appears in the LCD display window. When you release the MACRO button, all indications will revert to the initial status.

There is one more important point to note about programming a macro sequence. During a macro sequence, you may include more than one function selection button to access some transport and/or other commands. Depending on the macro sequence, this might result in the amplifier or receiver's function selection to be inadvertently changed as well when the macro is played back. The RC2000MKII has a special feature to prevent this from occurring, allowing you to access the special commands available under each RC2000MKII function button during a macro playback sequence, while at the same time prevent the amplifier or receiver from constantly switching its input source back and forth at the same time.

During the programming sequence, just remember that if you wish to activate a specific input selector on your amplifier or receiver, make sure that you press the desired input selection button FIRST. Subsequent function button selections can be incorporated in the macro sequence, but on playback, the RC2000MKII will only send out a function selection infrared command to the amplifier or receiver based upon the first function command used in the macro sequence.

For example, you may wish to have a macro sequence which activates the laser disc player input on your amplifier or receiver, and then have additional commands in the sequence to instruct your TV set to switch to an external video source to receive the laser disc video signal. During the macro programming, make sure that you press the LD function selector button BEFORE you press any of the other function selector buttons in the sequence. You can then include any of the TV commands by pressing the TV function selector button, later in the sequence. When this macro is next used (played back), the RC2000MKII will send out the command to change the amplifier or receiver's input selector to laser disc input (since its function selector button was the first one programmed into that macro sequence), and will not subsequently change the amplifier or receiver's input to TV (but will send out any special TV commands that you included in the macro sequence).

Note: To AMP button is not include the above functions buttons.

Programming a macro under a function selector key:

If you wish, you can also program a macro that can be activated by pressing one of the function selector [9] keys. The programming steps are similar to the steps outlined for programming a macro number button [6]. The following example shows how to program a macro under the LD (laser disc) function selector [9]:

(activate the main amplifier's power on, switch the source to laser disc, switch the amplifier's surround mode to PRO LOGIC, switch on the television, switch to the television's AUX video input, power up the laser disc player, and begin laser disc playback)

- Press the MACRO [2] operation mode button with the tip of a paper clip.
- Press the LD function button [9].
- Press the following buttons:
POWER ON, LD, AMP, direct function D-5 (PRO LOGIC selector) in page 1, TV*, SOURCE ON, direct function D-4 (VIDEO input selector) in page 1, LD*, SOURCE ON, and PLAY.
- Press the MACRO [2] button with the tip of a paper clip. The RC2000MKII will revert to the normal mode and save the macro under the LD function button.
- To execute the new macro sequence, press twice and hold the LD function selector button for 3 seconds.



Using the macro function(s) you have programmed:

1. Press the desired MACRO [6] button. The corresponding macro number will appear at the bottom of the display window, OR if a macro has been programmed under a function button, press the MACRO [6] button twice and hold that function button for 3 seconds. The LCD display window will indicate the macro number in the LCD window (see Figure 12), or if a macro is programmed under a function key, the status line will display the macro under function buttons as follows:

Figure 12

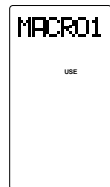

Macro under function button:	Status line shows:
LD	"LD" as the first 2 characters in the line
TV	"TV" as the first 2 characters in the line
VCR	"VC" as the first 2 characters in the line
DSS/MD	"DS" as the first 2 characters in the line
AUX	"AX" as the first 2 characters in the line
TUNER	"TU" as the first 2 characters in the line
CD	"CD" as the first 2 characters in the line
TAPE	"TP" as the first 2 characters in the line
DVD	"DV" as the first 2 characters in the line
AMP	"AP" as the first 2 characters in the line

2. The macro sequence will begin, and the remote control codes will be sent from the RC2000MKII and the display will show the names of the transmitted codes.
3. When the macro transmit sequence has ended, the RC2000MKII will return to the same mode before the macro function was initiated.

Now that we've explained how to program a macro, perhaps the following suggested example can help you become more familiar with the process:

(to switch the RC2000MKII to CD, then initiate CD playback, and go to track 3 on the CD)

1. Press the MACRO x operation mode button with the tip of a paper clip.
2. Press one of the MACRO buttons (1 through 4).
3. Press the following buttons:
 - CD function selector, then numeric key pad 3, then transport control key pad PLAY key. (see Figures 13, 14, and 15)

Figure 13

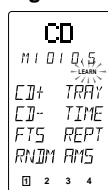

Figure 14

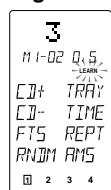
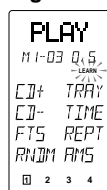

Figure 15



Note that this sequence will operate a Marantz CD player (or any other CD player equipped with the RC-5 remote control language). If you have another brand of CD player, you may wish to check its owner's manual to see if direct track selection is possible via remote, or if the macro sequence needs to be adjusted according to the programming steps required by your CD player.

4. Press the MACRO [2] button with the tip of a paper clip. The RC2000MKII will revert to the normal mode (see Figure 16).

Figure 16

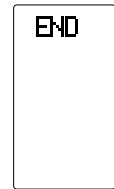

5. Press the MACRO [6] button you desired. RC2000MKII will transmit the programmed code. (see Figures 17, 18, and 19)

Figure 17



Figure 18

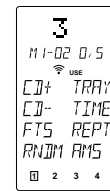

Figure 19



Note: If you would like to cancel the MACRO function, press the STOP [15] button.

Now, we'll show you another macro programming example, with a more sophisticated sequence:

(activate the main amplifier's power on, switch the source to laser disc, switch the amplifier's surround mode to PRO LOGIC, switch on the television, switch to the television's AUX video input, power up the laser disc player, and begin laser disc playback).

1. Press the MACRO [2] operation mode button with the tip of a paper clip.
2. Press one of the MACRO buttons (1 through 4).
3. Press the following buttons: POWER ON, LD, AMP, direct function D-2 (PRO LOGIC mode), TV*, SOURCE ON, direct function D-4 (VIDEO input selector), LD*, SOURCE ON, and PLAY.
4. Press the MACRO [2] button with the tip of a paper clip. The RC2000MKII will revert to the normal mode.
5. To execute the new macro sequence, press the appropriate MACRO button (1 through 4) that you chose at the beginning of the above programming sequence.
6. RC2000MKII will transmit the programmed code.
 - Note that the function selector buttons TV and LD marked with an asterisk (*) in this macro sequence do not actually send out infrared codes, but simply change over the RC2000MKII's programmed memory code banks for those respective functions.

If you would like to clear the MACRO programmed sequence(s), press and hold the CLEAR [14] button and simultaneously press the appropriate MACRO button (1 through 4) or function button. "M1-CLR?" (macro 1-clear?) appears in the LCD window. Release the buttons, and then press the OK button (within the cursor control buttons), and the macro is erased. If you do not wish to erase the macro, simply press any other button (but not the OK button).

CLONE mode:

Duplicating the memory contents of one RC2000MKII to another RC2000MKII.

For a complete home theater system, with numerous components from many different manufacturers, you may find that you have stored dozens, even hundreds of different codes, along with specialized names, macros, etc. We have provided a very quick and simple procedure that allows you to download the entire customized memory contents of one RC2000MKII remote control into another, fresh RC2000MKII.



To “clone” (duplicate) the memory contents of one RC2000MKII into another RC2000MKII, please follow these steps:

1. Place the source RC2000MKII (the one with all of the customized commands, names, macros, macro sequences, and the like) with its infrared transmitter window 22 facing the infrared sensor 23 of another “fresh” RC2000MKII (5 cm, or 2 inches apart).
2. Press the CLONE button 3 of the source RC2000MKII with the tip of a paper clip, and select “CLONE TX” (clone transmit) mode (see Figure 20).

Figure 20

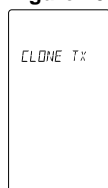

3. Press the CLONE button 3 of the learning (receiving) RC2000MKII with the tip of a paper clip or a similar object, and select “CLONE RX” (clone receive mode). Then press the PLAY button 15.

Figure 21

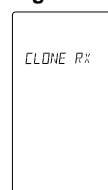

4. Press the source RC2000MKII’s transport control PLAY 15 button to begin the infrared data transmission sequence. If you wish to duplicate only 1 to 8 function’s memory, press function button(s) you wish before pressing the PLAY button. Now the “LEARN” indicator starts to blink. (see Figure 23)

Figure 22



Figure 23

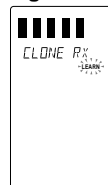

After all bars are lit up on both displays, “TX OK” (transmission OK) will appear in the source RC2000MKII’s LCD window, and “RX OK” (reception OK) will appear in the “cloned” RC2000MKII’s LCD window, confirming the end of the copying process (see Figures 24 and 25).

Figure 24



Figure 25



Please be sure that, during the copying process, neither RC2000MKII is physically disturbed (ideally, they should be placed on a table or other surface, and not hand-held during the copying process). If, for some reason, the copying process was interrupted, the “clone” RC2000MKII’s LCD display window will indicate “RX NG” (reception no good). Simply begin the clone process anew by repeating the above steps.

Note: The cloning is available between the same remote control unit series only therefore the RC2000MKII cannot be cloned by RC2000.

5. If the source RC2000MKII’s memory contents are at or near full capacity, the copying process will take about 3 minutes. After completion of the copying (cloning) process, press the CLONE button 3 on both RC2000MKII’s with the tip of a paper clip, and select the OFF mode.

Then, you’ll have two identically programmed RC2000MKII remotes, one of which can again be used as your system’s primary remote control, and you’ll have the added confidence of knowing that in the event of inadvertent programming (or memory contents being cleared somehow), you can simply retrieve the “backup” RC2000MKII that you’ve safely tucked away, and within minutes restore the programming contents of the original RC2000MKII with your customized configuration.

Other Functions

The Marantz RC2000MKII includes the ability to tailor the lighting features according to your preferences. As supplied from the factory, the RC2000MKII has a lighting features (and lighting timings):

1. The lighting time is set at the factory for a period of 2 seconds which you can change if you prefer a different lighting time. If you wish to maximize battery life, you can defeat the lighting function entirely. There is also a lighting button 20, so that in any light situations, you can activate the backlighting feature. The lighting time in this case is set at the factory for a period of 2 seconds, which you can also change. If you wish to conserve battery power, you can de-activate the lighting function entirely.

RC-5 Shipped destination:

As mentioned earlier in this guide, the RC2000MKII is provided with many commands from the factory with infrared codes conforming to the Philips RC-5 remote control language (used by Marantz, Philips, and some other companies). We have provided two different RC-5 command code sets in the RC2000MKII, according to the local requirements of different markets and the different types of remote control codes used in those markets. One code set is for North American (US) users, while the other code set is for REST users. Your RC2000MKII has been set at the factory for US (United States) codes. It can be easily changed, if you wish.

Set-Up:

To change the lighting time(s), or the destination setting, please follow these steps:

- Select the SETUP mode, by holding the MEMO button 13 and at the same time press the OK button within the cursor keys/6. (see Figures 26 and 27)

Figure 26



Figure 27





LAMP - Lighting function ON or OFF and TIME

Press the D-5 direct function button, and you can then set the time (in seconds) directly using the numeric key pad [12] buttons. A time figure consisting of only 1 digit can be input by pressing the figure then waiting for 2 seconds or input "0" before entering a desired digit. You can set time in the range from 0 up to 60 seconds (which would use up more battery life than a lower figure, such as 3 or 5 seconds). "2" is set when shipped from the factory. You can set "OFF" to input "0".

BEEP sound

The beep sounds when press any buttons.

The beep sound level can be set to decrease or increase by pressing the D-6 button. The display indicates "+" indication and the beeps are sounded by pressing the D-6 button. The "+" indication is followed the "+" indication as the beep sound is increased; + → ++ → +++ → ++++ When the "++++" is indicated and the D-6 button is pressed, the minimum level "+" is set.

"J" is indicated in LCD window when the beep sound is set.

Note: The beep sound is different between the function buttons and other buttons.

VER

Press the D-7 direct function button to switch between US to REST. If you need to change this function, we recommend that you make the change before you begin "learning" any new infrared codes for other brands of equipment in your system.

Note: The name of the DIRECT button will be erased by changing the VER(sion).

Battery life:

- Battery life will vary from user to user, if the remote is used constantly or only occasionally, including the amount of backlighting usage. We feel that you can expect the batteries to last about 4 months, based upon 15 remote control operations per day (every day), and 3 lighting operations per day (every day). If the remote is used more often, and if the lighting times are set to longer times than the factory settings, then the battery life may be shortened somewhat.
 - As explained earlier in the guide, the RC2000MKII's sophisticated battery conservation system will advise you long before the battery power is fully exhausted, and will further warn you to replace the batteries by simply becoming inoperative at a certain point. The customized memory contents and user-adjusted settings will still be retained in memory. When you install a fresh set of batteries, the memory contents are protected always, because the RC2000MKII use the non-volatile memory. Alkaline (and the newer lithium) types are recommended for longest battery life.
- As you become more familiar over time with how you are using the RC2000MKII in your A/V system, you may wish to consider reducing the lighting time(s) if possible, as this can help to extend the battery life.

Adjustment of the LCD contrast

- The LCD contrast can be adjusted as follows; Set SETUP mode to the RC2000MKII by pressing the MEMO and OK button. Press the VOL+ to increase the LCD contrast. Press the VOL- to decrease the LCD contrast. Press the OK button to end this setting and return the original operation.

Direct Command Functions Listing

Within the RC2000MKII LCD window, each of the 8 Direct Function buttons has 4 character label attached for pre-programmed remote commands. These commands can be used with various Marantz A/V components, or other components using the Philips RC-5 remote control language.

You can easily replace the factory-supplied remote command codes with different codes from other brands of equipment. Most functions that are supplied apply to a wide variety of equipment from many companies. The following list shows the remote code assignments for the direct function buttons, for each of the 10 main function selector buttons, as supplied from the factory. You can add or replace function commands, including re-naming them if you wish, in order to customize the RC2000MKII for your own particular selection of A/V components.

AMP	1 MODE-1	1 AC-3 2 RF 3 OPT 4 COAX 5 P/L 6 6-CH 7 2-CH 8 NITE	selects Dolby Digital (AC-3) decoding selects Dolby Digital RF input selects optical digital input selects coaxial digital input Dolby Pro Logic decoding activates 6 channel setup Stereo (no surround decoding) selects NIGHT mode
	2 MODE-2	1 AC-3 2 P/L 3 3-ST 4 MOV 5 THX 6 MTRX 7 HALL 8 2-CH	selects Dolby Digital (AC-3) decoding Dolby Pro Logic decoding Dolby 3-stereo decoding Movie surround sound THX Cinema decoding Matrix surround sound Hall surround sound Stereo (no surround decoding)
	3 SETUP	1 TEST 2 DLAY 3 R-EQ 4 ATT 5 CH+ 6 LVL+ 7 LVL- 8 MLTI	activates test tone increases delay time activates RE-EQ function activates ATT function next channel (up) increases channel level volume decreases channel level volume activates multi-room mode
	4 PROCESSOR	1 RF 2 OPT 3 COAX 4 BYP 5 VOL+ 6 VOL- 7 SLEP 8 6-CH	selects Dolby Digital RF input selects optical digital input selects coaxial digital input bypasses Dolby Digital decoding increases Dolby Digital volume decreases Dolby Digital volume activates amplifier's sleep timer activates 6 channel setup
TUNER	1 BAND	1 FM 2 AM 3 LW 4 BAND 5 MODE 6 TIME 7 F/P 8 SCAN	FM band AM/MW band long wave band selects radio band mono/stereo/muting mode selector time display frequency or preset channel display programmed preset channel scan
	2 REC	1 TP-1 2 REC	commands for Tape 1 control (NO output) record



TUNER	2 REC	3 PAUS 4 STOP 5 TP-2 6 REC 7 PAUS 8 STOP	pause stop commands for Tape 2 control (NO output) record pause stop
	2 RDS (for REST only)	1 STM 2 AF 3 PTY 4 DISP 5 6 7 8 DWR	selects station mode selects AF function selects PTY function selects display function selects DSR wave range
CD	1 MODE	1 CD+ 2 CD - 3 FTS 4 RNDM 5 TRAY 6 TIME 7 REPT 8 AMS	CD changer next disc CD changer previous disc favorite track selection random (shuffle) play function tray open/close time display elapsed/remain/total repeat function automatic music scan
	2 CHANGER1	1 CD1 2 CD2 3 CD3 4 CD4 5 CD5 6 EDIT 7 RCL 8 CNCL	selects Disc 1 selects Disc 2 selects Disc 3 selects Disc 4 selects Disc 5 tape edit function recall track programming cancel track programming
	3 CHANGER2	1 UNIT 2 DISC 3 TR 4 CATG 5 MODE 6 TITL 7 T-S 8 ENT	selects unit No. selects disc No. selects track No. selects category selects mode selects function title mode selects title search selects enter
	4 REC	1 TAPE 2 REC 3 PAUS 4 STOP 5 MD 6 REC 7 PAUS 8 STOP	commands for Tape control (no output) record pause stop commands for MD control (no output) record pause stop
TAPE	1 MODE	1 TP-A 2 TP-B 3 DIR 4 TIME 5 TRAY 6 AMS 7 REC 8 PAUS	selects tape deck A selects tape deck B auto-reverse direction time display tray open/close automatic music scan record pause
DVD	1 MODE1	1 ANGL 2 TITL 3 SUBT 4 MENU 5 TRAY 6 SUND 7 SET 8 RTN	selects angle selects title menu selects sub title selects main menu tray open/close selects languages selects setup menu return to menu
	2 MODE2	1 SLOW 2 LPLY 3 RNDM 4 RPT 5 A/B 6 +10 7 T/C 8 ZOOM	slow forward last play function shuffle play function repeat modes repeat A to B digit entry +10 title and chapter zoom mode on/off
	3 KARAOKE	1 ONOF 2 ONCE 3 MELO 4 VOCL 5 MODE 6 3-D 7 VSLF 8 VRLR	karaoke on/off once play again melody play vocal support play karaoke modes surround processor on/off very slow forward very slow reverse
	4 REC	1 VCR1 2 REC 3 PAUS 4 STOP 5 MD 6 REC 7 PAUS 8 STOP	selects VCR1 control (no output) record pause stop selects MD control (no output) record pause stop
LD	1 MODE	1 SD-A 2 SD-B 3 DISP 4 AMS 5 RPTA 6 RPTB 7 CP/F 8 EDIT	side A side B display on/off automatic music scan Repeat A start point Repeat B stop point selects chapter or frame activate tape edit function
	2 LD	1 MSP+ 2 MSP- 3 FRM+ 4 FRM- 5 MS-F 6 MS-R 7 AUD 8 DACX	CAV multi-speed increase CAV multi-speed decrease frame advance frame reverse CAV multi-speed forward direction CAV multi-speed reverse direction Stereo, left only, right only channel digital audio, analog audio, CX NR
	3 REC	1 VCR1 2 REC 3 PAUS 4 STOP 5 VCR2	commands for VCR 1 control (NO output) record pause stop commands for VCR 2 control (NO output)



LD	3 REC	6 REC 7 PAUS 8 STOP	record pause stop	
	4 VCD (for REST only)	1 PBC 2 KARA 3 IDX+ 4 IDX- 5 SEL 6 RTN 7 NEXT 8 PREV	selects play back control selects karaoke index up index down play or select audio stop or select return track next track previous	
	TV	1 INPUT	1 RGB 2 VIDEO 3 4 5 DVD 6 7 8	select RGB/PC selects VIDEO selects DVD/HD
		2 MODE	1 ZOM+ 2 ZOM- 3 4 5 WIDE 6 7 8	enlarge the picture reduce the picture select screen size
	3 MENU	1 ON 2 3 4 5 OFF 6 7 TIME 8	display the main menu exit off timer	
4 POINTER	1 ON 2 3 4 5 6 7 8	on/off the pointer on display		
VCR	1 MODE	1 CH+ 2 CH- 3 SLCT 4 AUD 5 OTR 6 REC 7 PAUS 8 STOP	next channel (up) previous channel (down) select TV or VCR audio track selector one touch recording record pause stop	
	2 PLAY MODE	1 2XPL 2 SLOW 3 STIL 4 5 SKIP 6 VIS+ 7 VIS- 8	twice normal playback speed slower than normal playback speed still frame skip to next program marker VHS index search next VHS index search previous	
VCR (for USA only)	3 MENU	1 MENU 2 STAT 3 CLR	activate menu show current status clear programming	
	4 GOTO	4 GOTO 5 PLUS 6 7 8	go to next item video PLUS	
	1 DSS	1 DISP 2 PREV 3 CH+ 4 CH- 5 FAV 6 ALT 7 FTCH 8 ANT	brings up on screen channel marker goes to previously selected channel next channel previous channel favorite users and channel lists alternate audio channel, languages brings up on screen channel logos selects broadcast or cable antenna	
	2 MODE	1 CH+ 2 CH- 3 SLCT 4 AUD 5 OTR 6 REC 7 PAUS 8 STOP	next channel previous channel select TV or VCR audio track selector one touch recording record pause stop	
AUX	3 PLAY MODE	1 2XPL 2 SLOW 3 STIL 4 5 SKIP 6 VIS+ 7 VIS- 8	two times play speed slow speed play still frame skip to next program VHS index search next VHS index search previous	
	4 MENU	1 MENU 2 STAT 3 CLR 4 GOTO 5 6 7 8	activate menu show current status clear programming go to next item	
AUX	1 REC	1 VCR1 2 REC 3 PAUS 4 STOP 5 VCR2 6 REC 7 PAUS 8 STOP	commands for VCR 1 control (NO output) record pause stop commands for VCR 2 control (NO output) record pause stop	
	2 VCD/PHI 1 (for REST only)	1 CD+ 2 CD- 3 OSD 4 SCAN 5 A/B 6 SLOW 7 8	selects disc up selects disc down OSD on/off selects time search repeat A to B slow forward	



AUX	3 VCD/PHI 2 (for REST only)	1 PBC 2 KARA 3 IND+ 4 IND- 5 SEL 6 RTN 7 NEXT 8 PREV	selects play back control selects karaoke program selects video index up selects video index down selects in PBC returns in PBC next previous
	4 VCD/PHI 3 (for REST only)	1 CD+ 2 SHUT 3 OVEW 4 RESM 5 CHAN 6 FADR 7 8	selects disc up selects shutter function selects digest function selects last paly function selects channel selects MPX/vocal fader
MD	1 MODE 1	1 MD-A 2 MD-B 3 RPT 4 DISP 5 EJCT 6 AMS 7 RNDM 8 LP	select MD A select MD B select repeat modes select display modes eject automatic music scan randam diaplay selects SP/LP mode
	2 EDIT	1 EDIT 2 CHAR 3 DEL 4 ENT 5 AMRK 6 SYNC 7 PROG 8	selects edit mode selects character mode selects delete selects enter selects auto marker syncro REC selects program mode
	3 REC	1 MD 2 RECP 3 PAUS 4 STOP 5 TAPE 6 REC 7 PAUS 8 STOP	command MD (no output) REC-pause pause stop command tape (no output) record pause stop

Receiving the remote control codes

The RC2000MKII can learn most of the remote control codes from various equipment, it learns the full word length of the code it is receiving.

Due to the sensitivity of the receiving LED the RC2000MKII may also "learn" noise from fluorescent lights, etc. which can quickly fill up the memory of the RC2000MKII.

In order to maximize the memory capacity of the RC2000MKII please pay close attention to the following:

- (1) Aim the transmitting remote control at a direct line of the sight to the RC2000MKII remote receiver eye.
- (2) Keep 2 inches between transmitting remote and the RC2000MKII receiving eye.

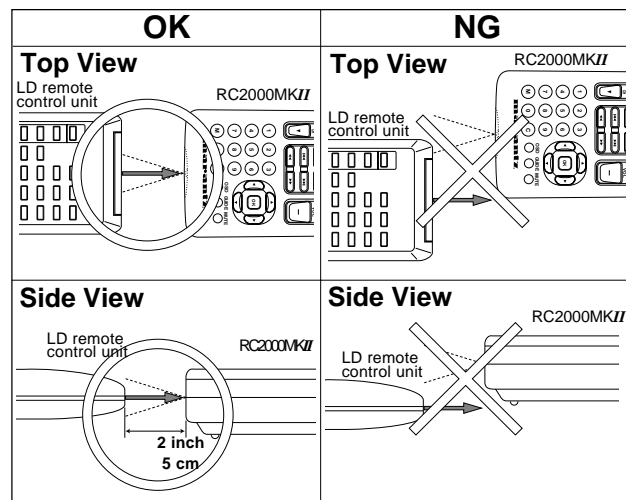



Battery Installation and Replacement

Insert the 4 "AA" batteries, making sure to set them in with the proper polarity.

1. Press and pull.

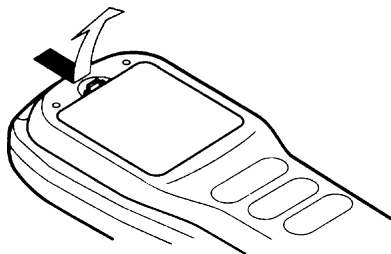

2. Load the batteries in the direction indicated by the "+" and "-" marks in the case.

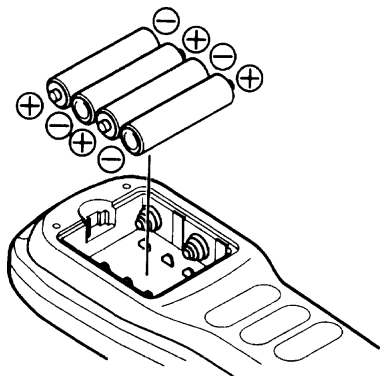

3. Put the lid back on.

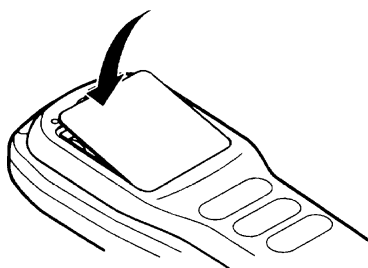

LCD Remote Controller Notes

- * Keep the back light button turned off except when using the LCD remote controller in a dark room. Leaving the back light on wears down the batteries faster.

Handling the LCD remote controller

- * Do not subject to strong shocks.
- * Do not subject to moisture.
If moisture gets on the unit, wipe it off immediately.
- * Keep away from heat.
- * Do not scratch or tap on the LCD remote controller's liquid crystal display with sharp objects (pens, compasses, etc.), and do not subject it to strong shocks.

Operating Range

- * Use the LCD remote controller within a distance of about 7 meters from the front of the monitor's remote control sensor and at a horizontal angle of within 30°.
- * The remote control operation may not function if the monitor's remote control sensor is exposed to direct sunlight or strong artificial light, or if there is an obstacle between the sensor and the remote control unit.

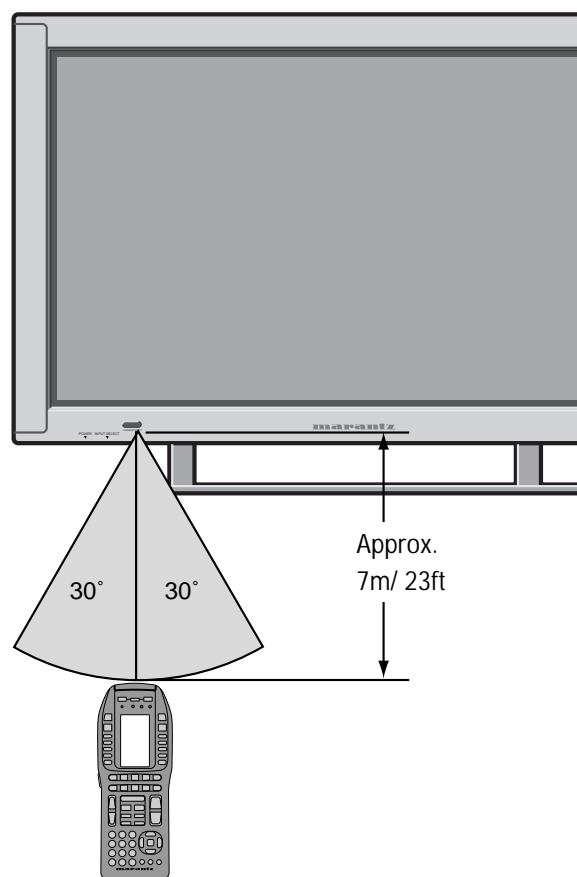

LCD remote controller

Installation

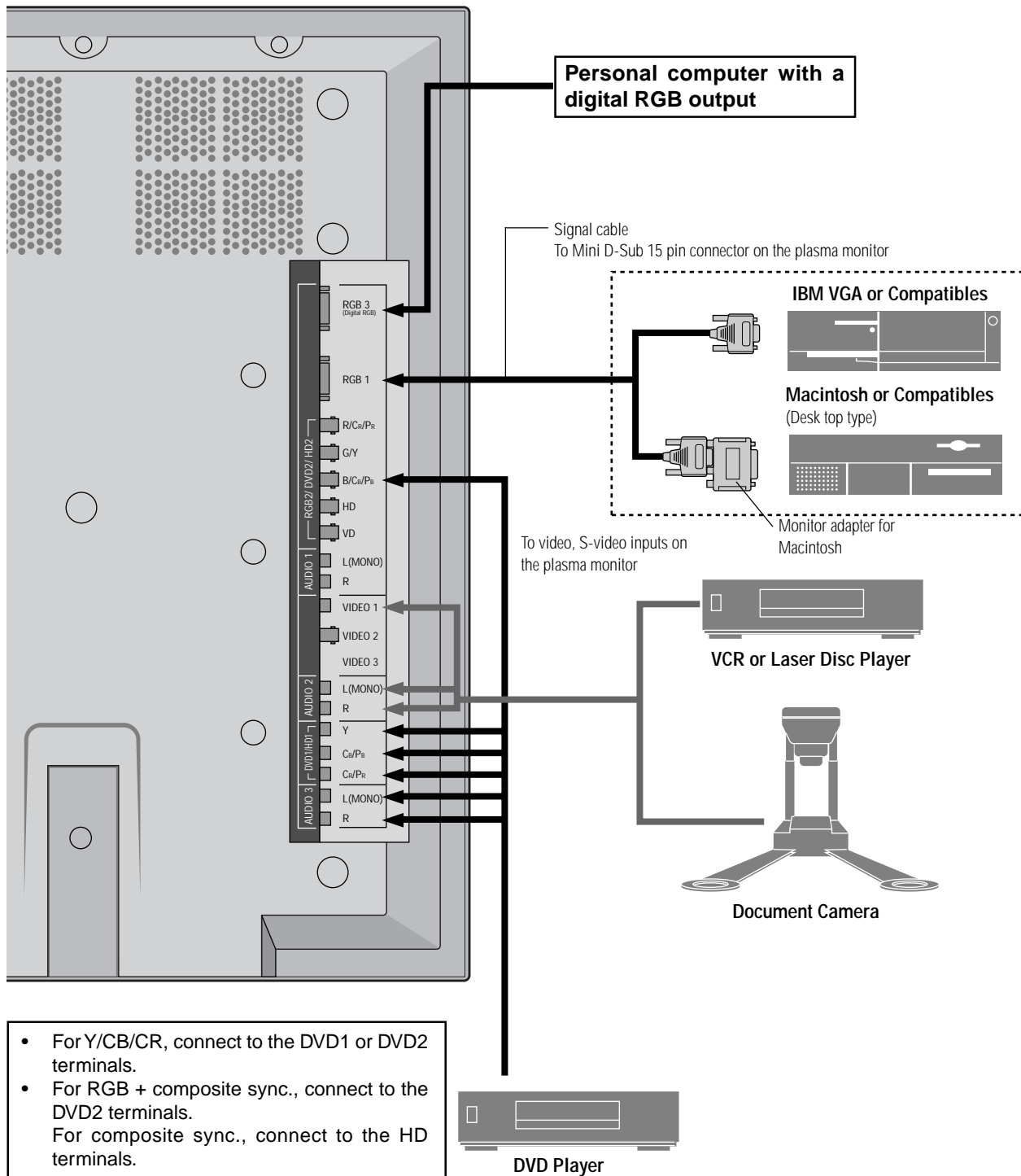



Connecting Your PC Or Macintosh Computer

Connecting your PC or Macintosh computer to your plasma monitor will enable you to display your computer's screen image for an impressive presentation. The plasma monitor supports the signals described on page 58.

To connect to a PC, Macintosh or compatible graphics adapter, simply:

1. Turn off the power to your plasma monitor and computer.
2. If your PC does not support XGA/SVGA/VGA you will need to install an XGA/SVGA/VGA graphics board. Consult your computer's owner's manual for your XGA/SVGA/VGA configuration. If you need to install a new board, see the manual that comes with your new graphics board for installation instructions.
3. The plasma monitor provides signal compatibility up to VESA 1280×1024@60Hz (SXGA). However, it is not recommended to use this resolution due to image readability on the monitors 853×480 native pixel resolution panel.
4. Use the signal cable that's supplied to connect your PC or Macintosh computer to the plasma monitor. For Macintosh, use the supplied monitor adapter to connect to your computer's video port.
5. Turn on the plasma monitor and the computer.
6. If the plasma monitor goes blank after a period of inactivity, it may be caused by a screen saver installed on the computer you've connected to the plasma monitor.

When using a Macintosh with the plasma monitor, the following four display standards are supported using the included Macintosh adapter :

- 13" fixed mode
- 16" fixed mode
- 19" fixed mode
- 21" fixed mode

The 13" fixed mode is recommended for the plasma monitor.

Connections with Equipment that has a Digital Interface

Connections can be made with equipment that is equipped with a digital interface compliant with the DVI (Digital Visual Interface) standard.

- * Use a DVI 29-pin signal cable (available separately) and the ferrite cores (supplied) when making connections to the RGB3 IN (DVI) connector of the main unit.
Note that the RGB3 IN(DVI) terminal does not support analog RGB input source.

Note:

1. Input TMDS signals conforming to DVI standards.
The TMDS input corresponds to 1 link.
2. To maintain display quality, use a cable with a quality prescribed by DVI standards that is within 5 meters in length.

Connecting Your Document Camera

You can connect your plasma monitor to a document camera. To do so, simply:

1. Turn off the power to your plasma monitor and document camera.
2. Use a standard video cable to connect your document camera to the Video input on your plasma monitor.
3. Turn on the plasma monitor and the document camera.

Note: Refer to your document camera's owner's manual for more information about your camera's video output requirements.

Connecting Your VCR Or Laser Disc Player

Use common RCA cables (not provided) to connect your VCR or laser disc player to your plasma monitor. To make these connections, simply:

1. Turn off the power to your plasma monitor and VCR or laser disc player.
2. Connect one end of your RCA cable to the video output connector on the back of your VCR or laser disc player, connect the other end to the Video input on your plasma monitor. Use standard RCA audio patch cords to connect the audio from your VCR or laser disc player to your plasma monitor (if your VCR or laser disc player has this capability). Be careful to keep your right and left channel connections correct for stereo sound.
3. Turn on the plasma monitor and the VCR or laser disc player.

Note: Refer to your VCR or laser disc player owner's manual for more information about your equipment's video output requirements.

Connecting Your DVD Player

You can connect your plasma monitor to a DVD player. To do so, simply:

1. Turn off the power to your plasma monitor and DVD player.
2. Use a standard video cable to connect your DVD player to the Y, Cb, and Cr inputs on your plasma monitor.
Or use the DVD-player's S-Video output. Use a standard S-Video cable to connect to the S-Video input on the plasma monitor.
3. Turn on the plasma monitor and the DVD player.

External Speaker Connections

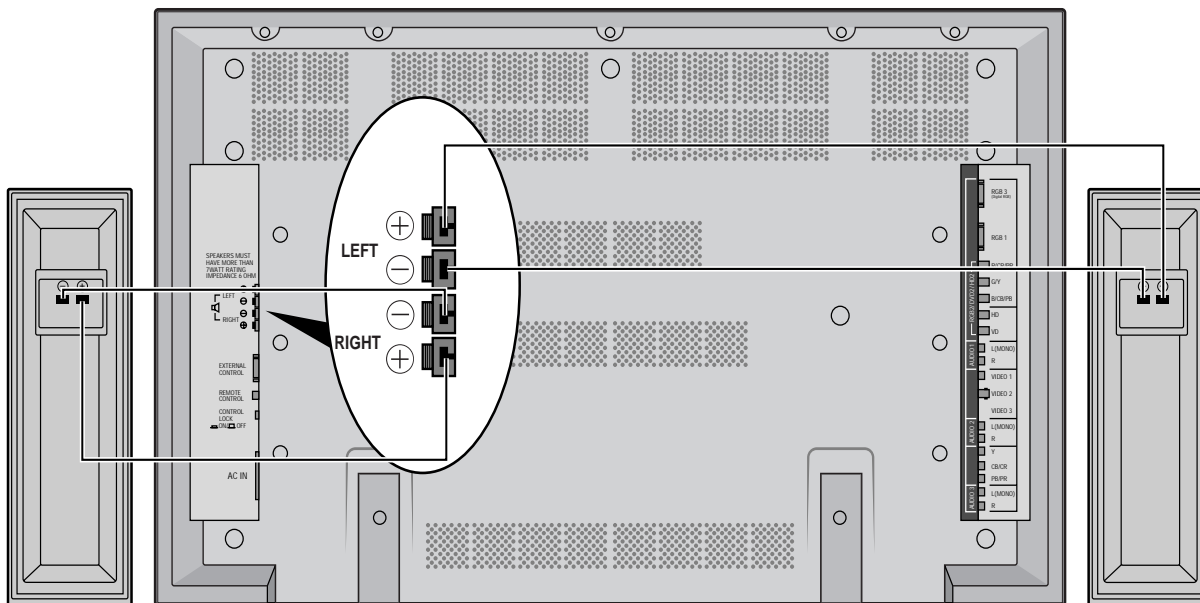

External speakers may be connected to the plasma monitor to reproduce sound from VIDEO, DVD or RGB signal sources.

External speakers may be connected directly to the SPEAKERS terminals or indirectly by connecting a stereo system amplifier to the audio outputs.

CAUTION: Unplug the plasma monitor and all connected components before connecting external speakers. Use only speakers with 6-ohm impedance and a power output rating of 7 watts or more.

To connect external speakers directly to the plasma monitor:

1. Strip the ends of the speaker wires.
2. Press down the tabs below the SPEAKERS terminals, insert the speaker wire and release the tab to secure the speaker wire connection:
 - [a] Connect the right speaker (located at right side of the monitor when viewed from the front) positive (+) wire to RIGHT +.
 - [b] Connect the right speaker negative (-) wire to RIGHT -.
 - [c] Connect the left speaker negative (-) wire to LEFT-.
 - [d] Connect the left speaker positive wire (+) to LEFT+.



Connecting Your PC Or Macintosh Computer

Connecting your PC or Macintosh computer to your Plasma monitor will enable you to display your computer's screen image for an impressive presentation. The Plasma monitor supports the signals described on page 50.

To connect to a PC, Macintosh or compatible graphics adapter, simply:

1. Turn off the power to your Plasma monitor and computer.
2. If your PC does not support XGA/SVGA/VGA you will need to install an XGA/SVGA/VGA graphics board. Consult your computer's owner's manual for your SXGA/XGA/SVGA/VGA configuration. If you need to install a new board, see the manual that comes with your new graphics board for installation instructions.
3. The Plasma monitor provides signal compatibility with VESA 1280×1024@60Hz (SXGA). However, it is not recommended to use this resolution due to image readability on the monitors 853×480 native pixel resolution panel.
4. Use the signal cable that's supplied to connect your PC or Macintosh computer to the Plasma monitor. For Macintosh, use the supplied monitor adapter to connect to your computer's video port.
5. Turn on the Plasma monitor and the computer.
6. If the Plasma monitor goes blank after a period of inactivity, it may be caused by a screen saver installed on the computer you've connected to the Plasma monitor.

When using a Macintosh with the Plasma monitor, the following three display standards are supported using the included Macintosh adapter :

- 13" fixed mode
- 16" fixed mode
- 19" fixed mode

The 13" fixed mode is recommended for the Plasma monitor.

Connecting Your Document Camera

You can connect your Plasma monitor to a document camera. To do so, simply:

1. Turn off the power to your Plasma monitor and document camera.
2. Use a standard video cable to connect your document camera to the Video input on your Plasma monitor.
3. Turn on the Plasma monitor and the document camera.

Note: Refer to your document camera's owner's manual for more information about your camera's video output requirements.

Connecting Your VCR Or Laser Disc Player

Use common RCA cables (not provided) to connect your VCR or laser disc player to your Plasma monitor. To make these connections, simply:

1. Turn off the power to your Plasma monitor and VCR or laser disc player.
2. Connect one end of your RCA cable to the video output connector on the back of your VCR or laser disc player, connect the other end to the Video input on your Plasma monitor. Use standard RCA audio patch cords to connect the audio from your VCR or laser disc player to your Plasma monitor (if your VCR or laser disc player has this capability). Be careful to keep your right and left channel connections correct for stereo sound.
3. Turn on the Plasma monitor and the VCR or laser disc player.

Note: Refer to your VCR or laser disc player owner's manual for more information about your equipment's video output requirements.

Connecting Your DVD Player

You can connect your Plasma monitor to a DVD player. To do so, simply:

1. Turn off the power to your Plasma monitor and DVD player.
2. Use a standard video cable to connect your DVD player to the Y, Cb, and Cr inputs on your Plasma monitor. Or use the DVD-player's S-Video output. Use a standard S-Video cable to connect to the S-Video input on the Plasma monitor.
3. Turn on the Plasma monitor and the DVD player.

Pin Assignments and Signal Levels for 15 pin RGB (Analog)

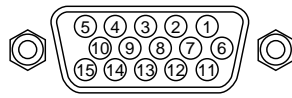

Pin No.	Signal (Analog)
1	Red
2	Green or sync-on-green
3	Blue
4	No connection
5	Ground
6	Red ground
7	Green ground
8	Blue ground
9	No connection
10	Sync signal ground
11	No connection
12	Bi-directional DATA (SDA)
13	Horizontal sync
14	Vertical sync
15	SCL

Pin Configuration and Signal of the RGB 3 IN Connector (DVI Connector)

The unit is equipped with a type of connector commonly used for both analog and digital.
 (Functionally, this cannot be used for analog input.)
 (TMDS can be used for one link only)

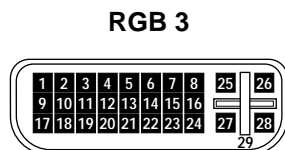

Pin No.	Signal (Digital)
1	T.M.D.S Data 2 -
2	T.M.D.S Data 2 +
3	T.M.D.S Data 2 Shield
4	No connection
5	No connection
6	DDC Clock
7	DDC Data
8	No connection
9	T.M.D.S Data 1 -
10	T.M.D.S Data 1 +
11	T.M.D.S Data 1 Shield
12	No connection
13	No connection
14	+5V Power
15	Ground
16	Hot Plug Detect
17	T.M.D.S Data 0 -
18	T.M.D.S Data 0 +
19	T.M.D.S Data 0 Shield
20	No connection
21	No connection
22	T.M.D.S Clock Shield
23	T.M.D.S Clock +
24	T.M.D.S Clock -
25	No connection
26	No connection
27	No connection
28	No connection
29	No connection

Basic Operations

POWER

To turn the unit ON and OFF:

1. Plug the power cord into an active AC power outlet.
2. Press the POWER ON button (on the remote controller) to turn on.

The monitor's POWER/STANDBY indicator will light up (green) when the unit is on.

3. Press the POWER OFF button (on the remote controller or the unit) to turn off.

The monitor's POWER/STANDBY indicator turns red and the standby mode is set (only when turning off the unit with the remote control).

VOLUME

To adjust the volume:

1. Press and hold the VOLUME ▲ button (on the remote controller or the unit) to increase to the desired level.
2. Press and hold the VOLUME ▼ button (on the remote controller or the unit) to decrease to the desired level.

MUTE

To cancel the sound:

Press the MUTE button on the remote controller to cancel sound; press again to restore.

DISPLAY

To check the settings:

1. The screen changes each time the OSD button is pressed.
2. If the button is not pressed for approximately three seconds, the menu turns off.

DIGITAL ZOOM

Digital zoom specifies the picture position and enlarges the picture.

1. Press the [4]-D1(ON) button to display the pointer. ()

To change the size of the picture:

Press the [2]-D1(ZOM+) button and enlarge the picture.

The pointer will change to resemble a magnifying glass. ()

A press of the [2]-D2(ZOM-) button will reduce the picture and return it to its original size.

To change the picture position:

Select the position with the ▲▼◀▶ buttons.

2. Press the [4]-D1(ON) button to delete the pointer.



OFF TIMER

To set the off timer:

The off timer can be set to turn the power off after 30, 60, 90 or 120 minutes.

1. Press the **[3]-D7(TIME)** button to start the timer at 30 minutes.
2. Press the **[3]-D7(TIME)** button to the desired time.
3. The timer starts when the menu turns off.

→ 30 → 60 → 90 → 120 → 0 →

 OFF TIMER30

Canceling the off timer

1. Press the **[3]-D7(TIME)** button twice in a row.
2. The off timer is canceled.

 OFF TIMER0

Note:

After the power is turned off with the off timer ... A slight current is still supplied to the monitor. When you are leaving the room or do not plan to use the system for a long period of time, turn off the power of the monitor.

To check the remaining time:

1. Once the off timer has been set, press the **[3]-D7(TIME)** button once.
2. The remaining time is displayed, then turns off after a few seconds.
3. When five minutes remain the remaining time appears until it reaches zero.

 OFF TIMER28

WIDE Operations

Watching with a wide screen (manual)

With this function, you can select one of four screen sizes.

When watching videos or digital video discs

1. Press the [2]-D5(WIDE) button on the remote controller.
2. *Within 3 seconds ...*

Press the [2]-D5(WIDE) button again.
The screen size switches as follows:

→ ZOOM → NORMAL → FULL → STADIUM

ZOOM size screen

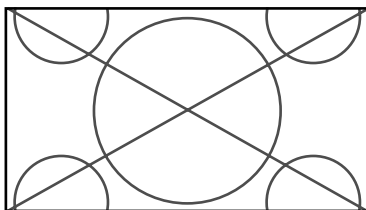

The picture is expanded in the horizontal and vertical direction, maintaining the original proportions.

* Use this for theater size (wide) movies, etc.

NORMAL size screen (4:3)

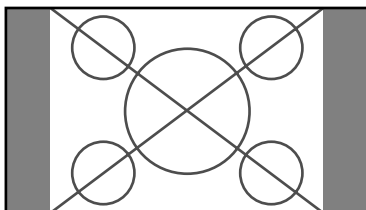

The normal size screen is displayed.

* The picture has the same size as video pictures with a 4 : 3 aspect ratio.

FULL size screen

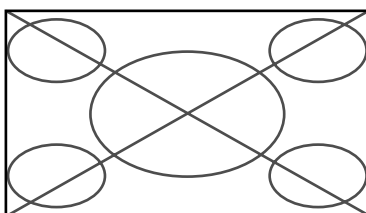

The image is expanded in the horizontal direction.

* Images compressed in the horizontal direction ("squeezed images") are expanded in the horizontal direction and displayed on the entire screen. (Normal images are expanded in the horizontal direction.)

STADIUM size screen

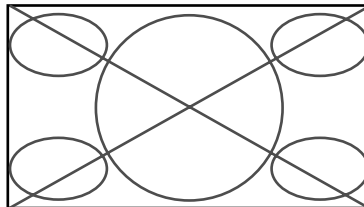

The picture is expanded in the horizontal and vertical directions at different ratios.

* Use this for watching normal video programs (4:3) with a wide screen.

When watching high definition video source

1. Press the "WIDE" button on the remote controller.

FULL size screen (16 : 9)

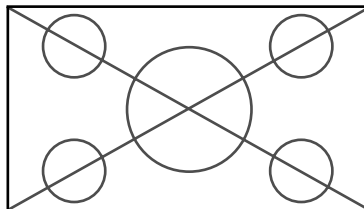

The full size screen is displayed.

* The picture has the same size as video pictures (16 : 9).



Watching computer images with a wide screen

Switch to the wide screen mode to expand the 4 : 3 image to fill the entire screen.

1. Press the **[2]-D5(WIDE)** button on the remote controller.
2. *Within 3 seconds ...*

Press the **[2]-D5(WIDE)** button again.
The screen size switches as follows:



NORMAL size screen (4:3 or SXGA 5:4)

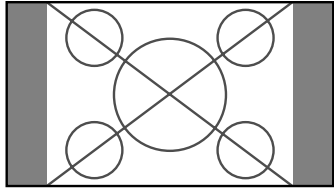

The picture has the same size as the normal computer image.

FULL size screen

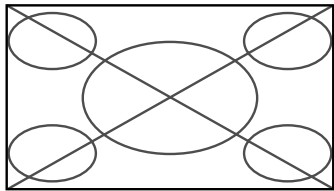

The image is expanded in the horizontal direction.

When using a graphic accelerator board that is capable of displaying 848 × 480.

FULL size screen

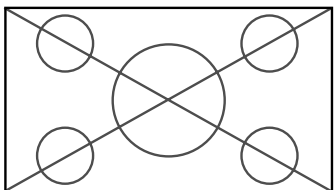

Information

Supported resolution

- See page 58 for details on the display output of the various VESA signal standards supported by the monitor.
- When 852 dot × 480 line wide VGA (*) signals with a vertical frequency of 60 Hz and horizontal frequency of 31.72 kHz are input, select "WIDE" for the "RGB SELECT" setting. Since selecting an 848 × 480 signal automatically displays the image in correct size, it is not necessary to change the RGB SELECT setting.

* "IBM PC/AT" and "VGA" are registered trademarks of IBM, Inc. of the United States.

OSM(On Screen Menu) Controls

Menu Operations

The OSM window is displayed with respect to the screen as shown on the diagram.

- * Depending on the screen's mode, the OSM may be displayed slightly differently. In the explanation, the OSM section is shown close up.

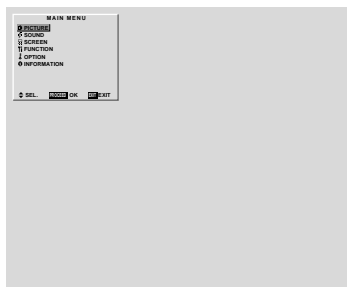

The following describes how to use the menus and the selected items.

1. Press the **[3]-D1(ON)** button on the remote controller to display the MAIN MENU.

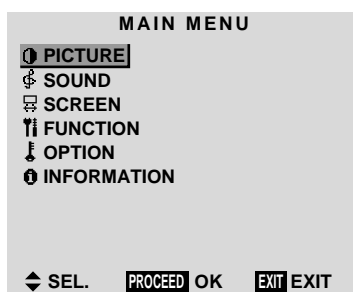

2. Press the cursor buttons **▲ ▼** on the remote controller to highlight the menu you wish to enter.
3. Press the **[3]-D1(ON)** button on the remote controller to select a submenu or item.

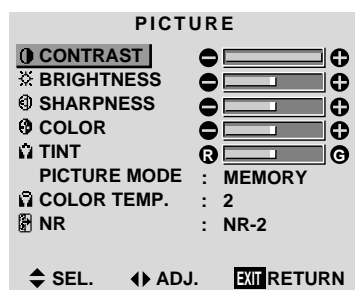

4. Adjust the level or change the setting of the selected item by using the cursor buttons **◀ ▶** on the remote controller.

5. The change is stored until you adjust it again.
6. Repeat steps 2 – 5 to adjust an additional item, or press the EXIT button on the remote controller to return to the main menu.

Note: The main menu disappears by pressing the **[3]-D5(OFF)** button.



Main menu	Sub menu	Functions	Default	Reset
PICTURE	CONTRAST	Adjusts the contrast.	Max	○
	BRIGHTNESS	Adjusts the brightness.	Center	○
	SHARPNESS	Adjusts the sharpness.	Center	○
	COLOR	Adjusts the color.	Center	○
	TINT	Adjusts the tint.	Center	○
	PICTURE MODE	Sets the picture mode according to the VIDEO environment and image software.	MEMORY	○
	COLOR TEMP	Adjusts the color temperature and white balance.	2	○
	NR	Reduces noise visible in image.	NR-1	○
Main menu	Sub menu	Functions	Default	Reset
SOUND	BASS	Sets the bass.	Center	○
	TREBLE	Sets the treble.	Center	○
	BALANCE	Sets the left/right balance.	Center	○
Main menu	Sub menu	Functions	Default	Reset
SCREEN	V-POSITION	Adjusts the vertical position	Center	○
	H-POSITION	Adjusts the horizontal position	Center	○
	V-HEIGHT	Adjusts the vertical size	Min	○
	H-WIDTH	Adjusts the horizontal size	Min	○
	AUTO PICTURE	Turn this on to have the monitor automatically adjust "FINE PICTURE" and "PICTURE ADJ"	OFF*1	×
	FINE PICTURE	Adjusts for flickering on the computer image	Min*1	○
	PICTURE ADJ.	Adjusts for striped patterns on the computer image	Center*1	○
Main menu	Sub menu	Functions	Default	Reset
FUNCTION	OSM	Turns the on-screen display (screen mode, etc.) off (when set to "OFF"). When set to "ON", the on-screen display is displayed.	ON	○
	OSM ADJ.	Adjusts the vertical and horizontal positions of the menu display.	1	○
	POWER MGT	Sets the monitor for use as an energy-saving display when used with a computer.	OFF	○
	GRAY LEVEL	In case of 4 : 3, sets the luminance of both sides.	3	○
	PLE+INVERSE	Set the brightness level to the minimum in conjunction with the inverse function.	AUTO	○
	CINEMA MODE	Setting the picture to suit the movie.	AUTO	○
	RESET	Resets all the settings (PICTURE, SOUND, SCREEN, FUNCTION, etc.) to the factory default values.	-	-
Main menu	Sub menu	Functions	Default	Reset
OPTION	AUDIO INPUT	Setting the allocation of the audio connectors.	*2	○
	BNC SELECT	Setting the BNC connectors.	RGB	○
	RGB SELECT	Sets the appropriate mode for the computer image. RGB (VGA signals), VIDEO (Moving picture), WIDE (WIDE VGA) DTV.	RGB	○
	HD SELECT	Sets the digital broadcasting (1080A, 1080B) or the High Vision (1035I).	1080B	×
	RGB3 ADJ	Adjusts the display position in the RGB3 input.	1	○
Main menu	Sub menu	Functions	Default	Reset
INFORMATION	FREQUENCY	Used to check the frequency and synchronizing polarities of the signal currently being inputted.	-	-
	LANGUAGE	Sets the language of the menus (Japanese, English, German, French, Swedish, Italian or Spanish).	English	×
	COLOR SYSTEM	Sets the VIDEO format (AUTO1, AUTO2, PAL, PAL-M, PAL-N, PAL60, SECAM, 4.43 NTSC or 3.58 NTSC).	AUTO1	×

*1 RGB/ PC only.

*2 AUDIO1: RGB1 AUDIO2: VIDEO1 AUDIO3: HD/DVD1



Picture Settings Menu

Adjusting the picture

The contrast, brightness, sharpness, color and tint can be adjusted as desired.

Example: Adjusting the contrast

Press the [3]-D1(ON) button on the remote controller to display the MAIN MENU on the screen, then...

1. Use the ▲ and ▼ buttons to select "PICTURE", then press the [3]-D1(ON) button. The "PICTURE" screen appears.
2. Use the ▲ and ▼ buttons to select "CONTRAST".

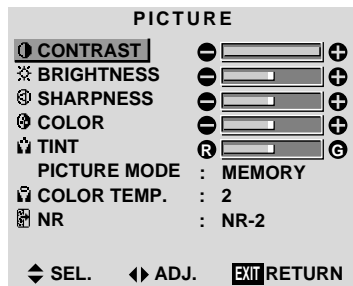

3. Use the ◀ and ▶ buttons to adjust the picture.

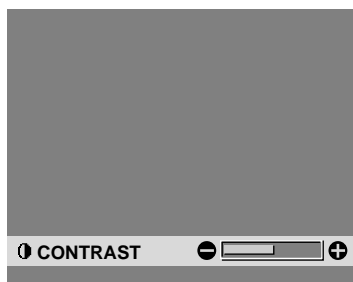

* If neither the ◀ or ▶ button is pressed within 5 seconds, the current setting is set and the previous screen reappears.

4. Press the [3]-D1(ON) button. The contrast adjustment is completed.

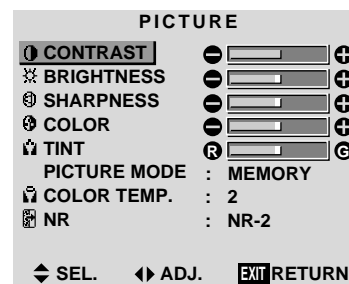

5. Once the adjustment is completed ... Press the "OK" button to return to the main menu. To delete the main menu, press the "OK" button once more.

Note: If "CAN NOT ADJUST" appears ... When trying to enter the PICTURE submenu, make sure PICTURE MODE is set to MEMORY.

Information

Picture adjustment screen

- CONTRAST Changes the picture's contrast.
- BRIGHTNESS Changes the picture's brightness.
- SHARPNESS Changes the picture's sharpness. Adjusts picture detail of VIDEO display.
- COLOR Changes the color density.
- TINT Changes the picture's tint. Adjust for natural colored skin, background, etc.

Adjusting the computer image

Only the contrast and brightness can be adjusted when a computer signal is connected.

Restoring the factory default settings

Select "RESET" under the "PICTURE MODE" settings.



Setting the picture mode according to the brightness of the room

There are four picture modes that can be used effectively according to the environment in which you are viewing the display.

Example: Setting the "THEATER" mode

Press the [3]-D1(ON) button on the remote controller to display the MAIN MENU on the screen, then...

1. Use the ▲ and ▼ buttons to select "PICTURE", then press the [3]-D1(ON) button. The "PICTURE" screen appears.
2. Use the ▲ and ▼ buttons to select "PICTURE MODE".

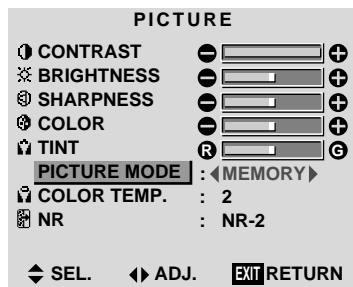

3. To set to "THEATER" ... Use the ◀ and ▶ buttons to select "THEATER". The mode switches as follows when the ◀ and ▶ buttons are pressed:

→ MEMORY ↔ THEATER ↔ NORMAL ↔ RESET ←



* If neither the ◀ or ▶ button is pressed within 5 seconds, the current selection is set and the previous screen reappears.

4. Press the [3]-D1(ON) button. The picture mode is set to "THEATER".

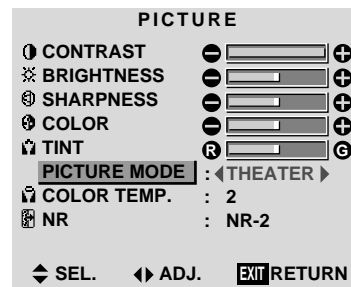

5. Once the adjustment is completed ... Press the "OK" button to return to the main menu. To delete the main menu, press the "OK" button once more.

Information

Types of picture modes

MEMORY The last picture adjustments are stored here.

THEATER Set this mode when watching video in a dark room.

This mode provides darker, finer pictures, like the screen in movie theaters.
 CONTRAST = 80% for RESET mode
 BRIGHTNESS = 95% for RESET mode

NORMAL Set this mode when watching video in a bright room.

This mode provides dynamic pictures with distinct differences between light and dark sections.

CONTRAST = 96% for RESET mode

RESET Use this to reset the picture to the factory default settings.



Setting the color temperature

Use this procedure to set color tone produced by the plasma display.

Example: Setting "1"

Press the **[3]-D1(ON)** button on the remote controller to display the MAIN MENU on the screen, then...

1. Use the **▲** and **▼** buttons to select "PICTURE", then press the **[3]-D1(ON)** button. The "PICTURE" screen appears.
2. Use the **▲** and **▼** buttons to select "COLOR TEMP."

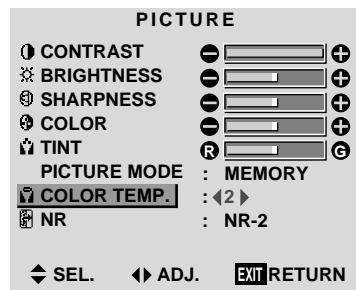

3. Use the **◀** and **▶** buttons to select "1". The mode switches as follows when the **◀** and **▶** buttons are pressed:

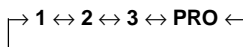

* See page 35 to set "PRO".

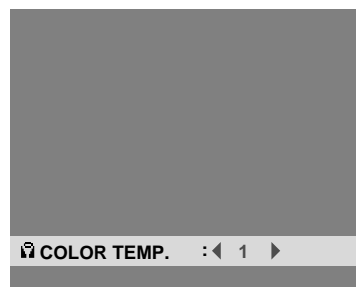

If neither the **◀** or **▶** button is pressed within 5 seconds, the current selection is set and the previous screen reappears.

4. Press the **[3]-D1(ON)** button. The "COLOR TEMP." is set to "1".

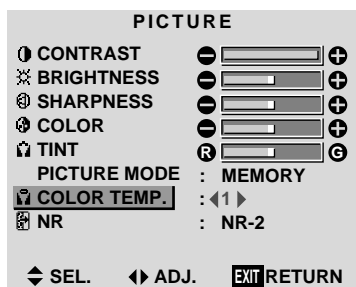

5. Once the setting is completed... Press the "OK" button to return to the main menu. To delete the main menu, press the "OK" button once more.

Information

Setting the color temperature

- 1 High (bluer)
- 2 Middle (Standard)
- 3 Low (redder)

Restoring the factory default settings

Select "RESET" under the function menu. Note that this also restores other settings to the factory defaults.



Adjusting the color to the desired quality

Use this procedure to adjust the white balance for bright pictures and dark pictures to achieve the desired color quality.

Example: Adjusting the "WHITE BALANCE"

Press the [3]-D1(ON) button on the remote controller to display the MAIN MENU on the screen, then...

- Use the ▲ and ▼ buttons to select "PICTURE", then press the [3]-D1(ON) button. The "PICTURE" screen appears.
- Use the ▲ and ▼ buttons to select "COLOR TEMP."

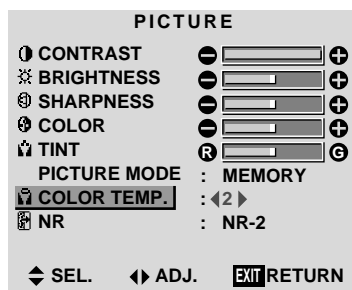

- Use the ◀ and ▶ buttons to select "PRO". The mode switches as follows when the ◀ and ▶ buttons are pressed:

→ 1 ↔ 2 ↔ 3 ↔ PRO ←

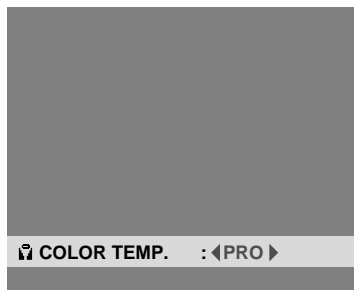

If neither the ◀ or ▶ button is pressed within 5 seconds, the current selection is set and the previous screen reappears.

- Press the [3]-D1(ON) button. The "WHITE BALANCE" screen appears.
- Use the ▲ and ▼ buttons to select "RED-GAIN".

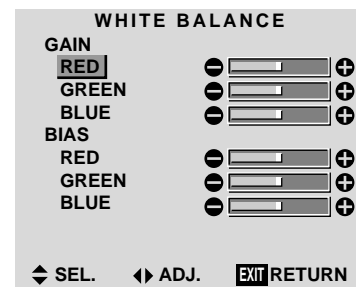

- Adjusts the white balance using the ◀ and ▶ buttons.



* If neither the ◀ or ▶ button is pressed within 5 seconds, the current setting is set and the previous screen reappears.

- Press the [3]-D1(ON) button. The white balance has now been adjusted.

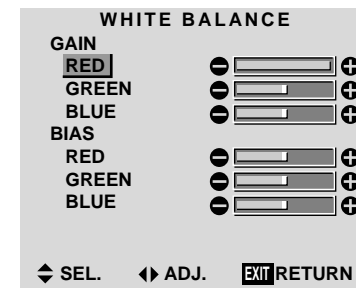

- Once the adjustment is completed... Press the "OK" button to return to the main menu. To delete the main menu, press the "OK" button once more.

Information

■ Adjusting the white balance

RGB-GAIN White balance adjustment for signal level

RGB-BIAS White balance adjustment for black level

■ Restoring the factory default settings

Restoring the factory default settings

Select "RESET" under the function menu. Note that this also restores other settings to the factory defaults.



Reducing noise in the picture

Use these settings if the picture has noise due to poor reception or when playing video tapes on which the picture quality is poor.

Example: Setting "NR-3"

Press the [3]-D1(ON) button on the remote controller to display the MAIN MENU on the screen, then...

1. Use the ▲ and ▼ buttons to select "PICTURE", then press the [3]-D1(ON) button. The "PICTURE" screen appears.
2. Use the ▲ and ▼ buttons to select "NR".

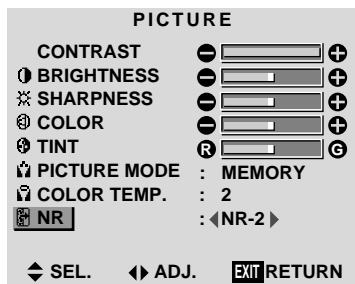

4. Press the [3]-D1(ON) button. The noise reduction mode is set to "NR-3".

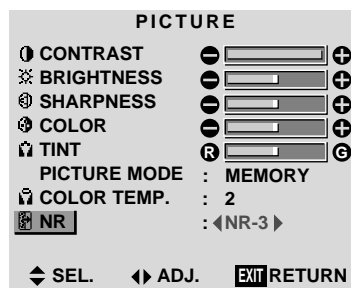

5. Once the setting is completed ... Press the "OK" button to return to the main menu. To delete the main menu, press the "OK" button once more.

3. Use the ◀ and ▶ buttons to select "NR-3". The mode switches as follows when the ◀ and ▶ buttons are pressed:

→ OFF ↔ NR-1 ↔ NR-2 ↔ NR-3 ←



Information

■ NR

- * "NR" stands for Noise Reduction.
- * This function reduces noise in the picture.

■ Types of noise reduction

There are three types of noise reduction. Each has a different level of noise reduction. The effect becomes stronger as the number increases (in the order NR-1 → NR-2 → NR-3). OFF Turns the noise reduction function off.

* If neither the ◀ or ▶ button is pressed within 5 seconds, the current selection is set and the previous screen reappears.

Sound Settings Menu

Adjusting the treble, bass and left/right balance

The treble, bass and left/right balance can be adjusted to suit your tastes.

Example: Adjusting the bass

Press the **[3]-D1(ON)** button on the remote controller to display the **MAIN MENU** on the screen, then...

1. Use the **▲** and **▼** buttons to select "SOUND", then press the **[3]-D1(ON)** button. The "SOUND" screen appears.
2. To adjust the bass ... Use the **▲** and **▼** buttons to select "BASS".

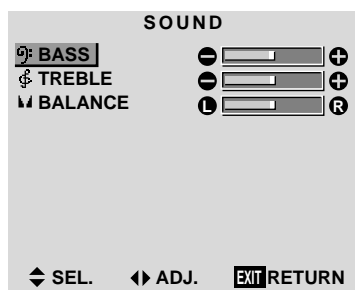

3. Adjust the bass using the **◀** and **▶** buttons.

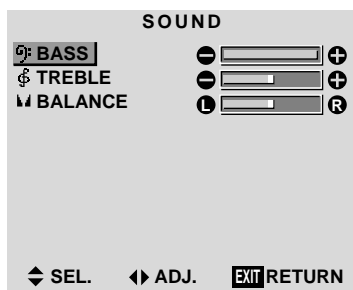

To continue adjusting the sound ... Repeat from step 2.

4. Press the **[3]-D1(ON)** button. The bass has now been adjusted.

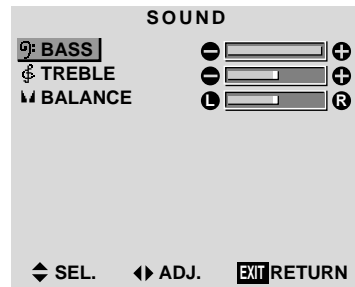

5. Once the adjustment is completed ... Press the "OK" button to return to the main menu. To delete the main menu, press the "OK" button once more.

Note: If "CAN NOT ADJUST" appears ... Set **AUDIO INPUT** on the **OPTION** menu correctly.

Information

■ Sound settings menu

- BASS** Changes the level of low frequency sound.
- TREBLE** Changes the level of high frequency sound.
- BALANCE** Changes the balance of the left and right channels.

■ Restoring the factory default settings

Select "RESET" under the function menu. Note that this also restores other settings to the factory defaults.

* If neither the **◀** or **▶** button is pressed within 5 seconds, the current selection is set and the previous screen reappears.



Screen Settings Menu

Adjusting the Position, Size, Fine Picture, Picture Adj

The position of the image can be adjusted and flickering of the image can be corrected.

Example: Adjusting the vertical position in the normal mode

Press the [3]-D1(ON) button on the remote controller to display the MAIN MENU on the screen, then...

1. Use the ▲ and ▼ buttons to select "SCREEN", then press the [3]-D1(ON) button. The "SCREEN" menu appears.

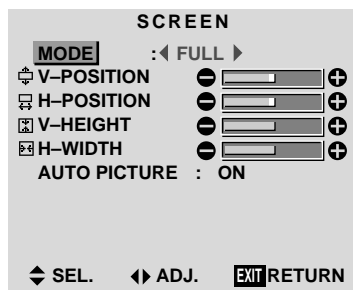

2. To adjust the normal mode ...

Use the ◀ and ▶ buttons to select "NORMAL". The mode switches as follows when the ◀ and ▶ buttons are pressed:

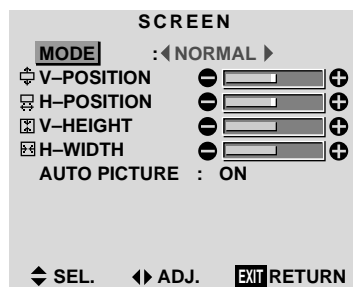

* The mode can also be switched by pressing the "WIDE" button on the remote controller.

3. To adjust the vertical position ...

Use the ▲ and ▼ buttons to select "V-POSITION".

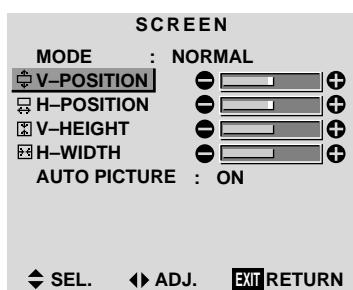

4. Adjust using the ◀ and ▶ buttons.

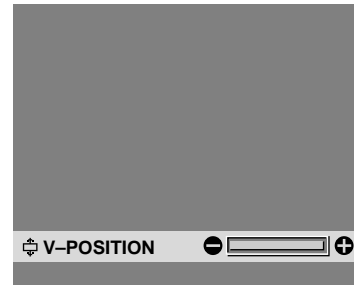

* If neither the ◀ or ▶ button is pressed within 5 seconds, the current adjustment is set and the previous screen reappears.

To continue making other computer image adjustments

... Repeat from step 3.

5. Press the [3]-D1(ON) button.

The vertical position of the computer's image has now been adjusted.

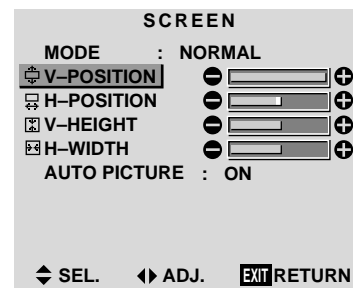

6. Once all adjustments are completed ...

Press the "OK" button to return to the main menu.

To delete the main menu, press the "OK" button once more.

Information

When "AUTO PICTURE" is "OFF"

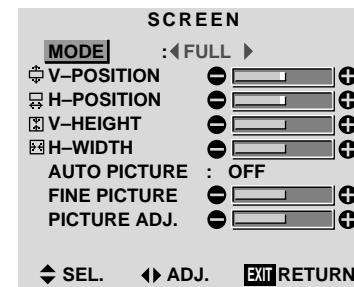

When Auto Picture is off, the Fine Picture and the Picture ADJ items are displayed so that you can adjust them.



Information

■ Adjusting the Auto Picture

ON The Picture ADJ and Fine Picture adjustments are made automatically.

OFF The Picture ADJ and Fine Picture adjustments are made manually.

■ Adjusting the position of the image

V-POSITION Adjusts the vertical position of the image.

H-POSITION Adjusts the horizontal position of the image.

V-HEIGHT Adjusts the vertical size of the image. (Except for STADIUM mode)

H-WIDTH Adjusts the horizontal size of the image. (Except for STADIUM mode)

FINE PICTURE* ... Adjusts for flickering.

PICTURE ADJ* Adjusts for striped patterns on the image.

* The Picture ADJ and Fine Picture features are available only when the "Auto Picture" is off,.

* The AUTO PICTURE, FINE PICTURE and PICTURE ADJ. are available for VIDEO and HD/DVD source.

■ Restoring the factory default settings

Select "RESET" under the function menu. Note that this also restores other settings to the factory defaults also restores other settings to the factory defaults except that the Auto Picture is not reset.

Function Settings Menu

Setting the on-screen display

When using the monitor for presentations, etc., the monitor can be set so that the input source, screen mode, etc., do not appear.

Example: Turning the on-screen display mode off

Press the [3]-DI(ON) button on the remote controller to display the MAIN MENU on the screen, then...

1. Use the ▲ and ▼ buttons to select "FUNCTION", then press the [3]-DI(ON) button. The "FUNCTION" screen appears.

2. Use the ▲ and ▼ buttons to select "OSM".

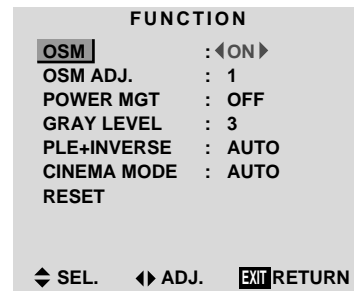

3. To turn the on-screen display mode off...

Use the ◀ and ▶ buttons to select "OFF".

The mode switches as follows each time the ◀ or ▶ button is pressed:

ON ↔ OFF

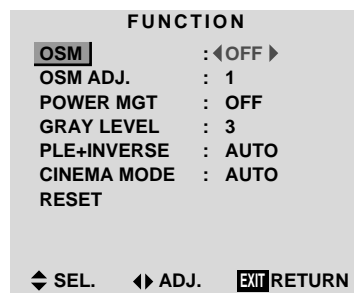

4. Once the setting is completed ...

Press the "OK" button to return to the main menu.

To delete the main menu, press the "OK" button once more.

Information

■ OSM modes

ON The on-screen display appears.

OFF The on-screen display does not appear.

■ Restoring the factory default settings

Select "RESET" under the function menu. Note that this also restores other settings to the factory defaults.



Adjusting the position of the menu display

Use these operations to adjust the position of the menus that appear on screen.

Example: Adjusting the position of the menu display

Press the [3]-DI(ON) button on the remote controller to display the MAIN MENU on the screen, then...

1. Use the ▲ and ▼ buttons to select "FUNCTION", then press the [3]-DI(ON) button. The "FUNCTION" menu appears.
2. Use the ▲ and ▼ buttons to select "OSM ADJ."

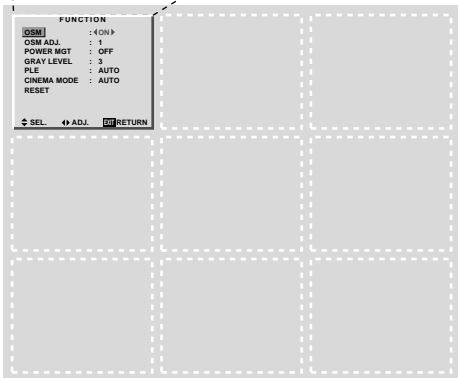
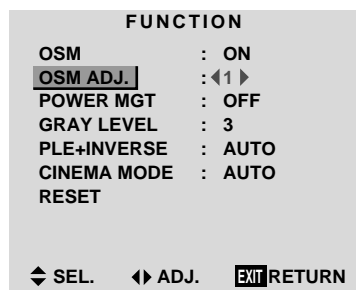

3. To adjust the position... Adjust using the ◀ and ▶ buttons.

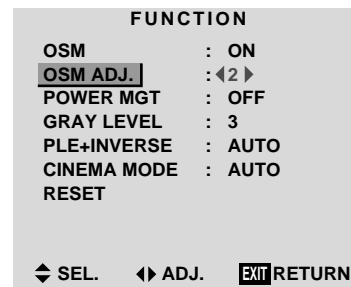

4. Once all adjustments are completed ... Press the "OK" button to return to the main menu. To delete the main menu, press the "OK" button once more.

Information

■ Adjusting the position of the menu display

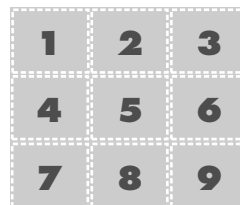

The position can be set between 1 and 9.

■ Restoring the factory default settings

Select "RESET" under the function menu. Note that this also restores other settings to the factory defaults.



Setting the power management for computer images
 This energy-saving (power management) function automatically reduces the monitor's power consumption if no operation is performed for a certain amount of time.

Example: Turning the power management function on

Press the **[3]-DI(ON)** button on the remote controller to display the MAIN MENU on the screen, then...

1. Use the **▲** and **▼** buttons to select "FUNCTION", then press the **[3]-DI(ON)** button. The "FUNCTION" screen appears.
2. Use the **▲** and **▼** buttons to select "POWER MGT".

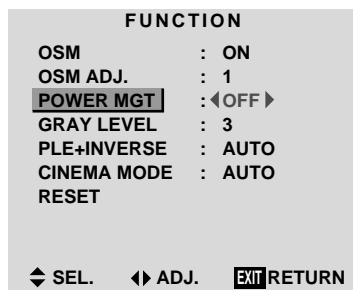

3. To turn the power management function on ... Use the **◀** and **▶** buttons to select "ON". The mode switches as follows each time the **◀** or **▶** button is pressed:

ON ↔ OFF

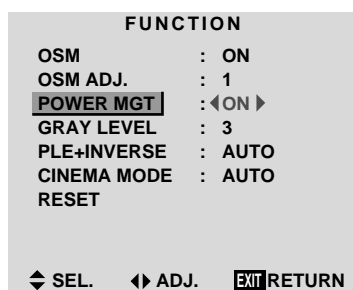

4. Once the setting is completed ... Press the "OK" button to return to the main menu. To delete the main menu, press the "OK" button once more.

Information

Power management function

- * The power management function automatically reduces the monitor's power consumption if the computer's keyboard or mouse is not operated for a certain amount of time. This function can be used when using the monitor with a computer conforming to the VESA DPMS format.
- * If the computer's power is not turned on or if the computer and selector tuner are not properly connected, the system is set to the off state.
- * For instructions on using the computer's power management function, refer to the computer's operating instructions.

Power management settings

- ON In this mode the power management function is turned on.
- OFF In this mode the power management function is turned off.

Power management function and POWER/STANDBY indicator

The POWER/STANDBY indicator indicates the status of the power management function. See page 41 for indicator status and description.

Restoring the factory default settings

Select "RESET" under the function menu. Note that this also restores other settings to the factory defaults.



POWER/STANDBY indicator

Power management mode	POWER/STANDBY indicator	Power management operating status	Description	Turning the picture back on
On	Green	Not activated.	Horizontal and vertical synchronizing signals are present from the computer.	Picture already on.
Standby	Orange	Activated.	No horizontal synchronizing signals are sent from the computer.	Operate the keyboard or mouse. The picture reappears immediately.
Suspend	Red	Activated.	No vertical synchronizing signals are sent from the computer.	Operate the keyboard or mouse. The picture reappears, but more time is required than from the standby mode.
Off	Red	Activated.	No horizontal or vertical synchronizing signals are sent from the computer.	Operate the keyboard or mouse. The picture reappears, but more time is required than from the standby mode or suspend mode.



Setting the gray level for the sides of the screen

Use this procedure to set the gray level for the parts on the screen on which nothing is displayed when the screen is set to the 4:3 size.

Example: Adjusting the "GRAY LEVEL"

Press the [3]-DI(ON) button on the remote controller to display the MAIN MENU on the screen, then...

1. Use the ▲ and ▼ buttons to select "FUNCTION", then press the [3]-DI(ON) button. The "FUNCTION" screen appears.
2. Use the ▲ and ▼ buttons to select "GRAY LEVEL".

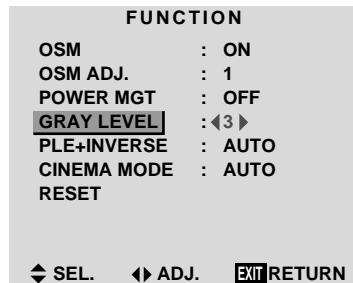

3. To adjust the "GRAY LEVEL" ... Use the ◀ and ▶ buttons to adjust the GRAY LEVEL.

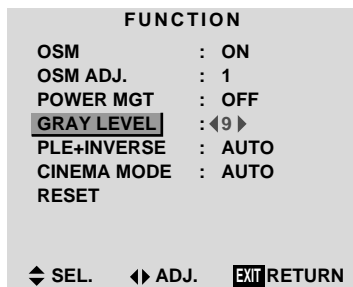

5. Once the setting is completed ... Press the "OK" button to return to the main menu. The delete the main menu, press the "OK" button once more.

Information

■ GRAY LEVEL

This adjusts the brightness of the black (the gray level) for the sides of the screen.

The standard is 0 (black). The level can be adjusted from 1 to 15. The factory setting is 3 (dark gray).

■ Restoring the factory default settings

Select "RESET" under the function menu. Note that this also restores other settings to the factory defaults.

Setting the brightness level to the minimum

Locking this mode allows you to dim the picture.

Example: Setting the "PLE+INVERSE" to "LOCK"

Press the [3]-DI(ON) button on the remote controller to display the MAIN MENU on the screen, then...

1. Use the ▲ and ▼ buttons to select "FUNCTION", then press the [3]-DI(ON) button. The "FUNCTION" screen appears.
2. Use the ▲ and ▼ buttons to select "PLE+INVERSE".

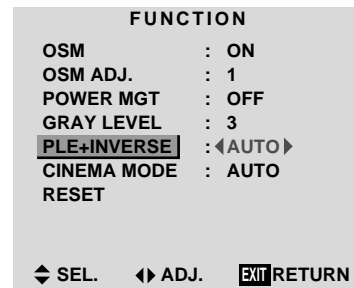

3. To set the PLE+INVERSE to "LOCK" ... Use the ◀ and ▶ buttons to select "LOCK". The mode switches as follows each time the ◀ or ▶ button is pressed:

AUTO ↔ LOCK ↔ LOCK+ON ↔ AUTO+ON

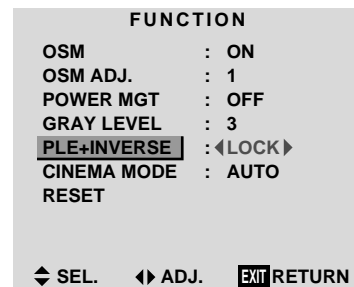

4. Once the setting is completed ... Press the "OK" button to return to the main menu. The delete the main menu, press the "OK" button once more.

Information

■ PLE+INVERSE

AUTO Normally set to AUTO.

LOCK Sets the brightness level to the minimum.

AUTO+ON Turns on the inverse function.

LOCK+ON Turns on the inverse function as well as the lock function.

■ Restoring the factory default settings

Select "RESET" under the function menu. Note that this also restores other settings to the factory defaults.



Setting the picture to suit the movie

The film image is automatically discriminated and projected in an image mode suited to the picture.
[NTSC, PAL60, 480I (60Hz) only]

Example: Setting the "CINEMA MODE" to "ON"

Press the [3]-DI(ON) button on the remote controller to display the MAIN MENU on the screen, then...

1. Use the ▲ and ▼ buttons to select "FUNCTION", then press the "OK" button.
The "FUNCTION" screen appears.
2. Use the ▲ and ▼ buttons to select "CINEMA MODE".

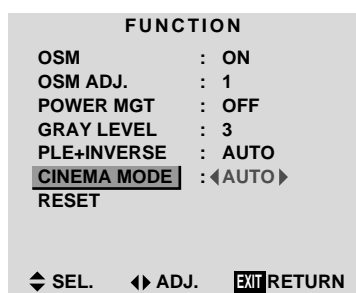

3. To set the CINEMA MODE to "ON" ...
Use the ◀ and ▶ buttons to select "ON".
The mode switches as follows each time the ◀ or ▶ button is pressed:

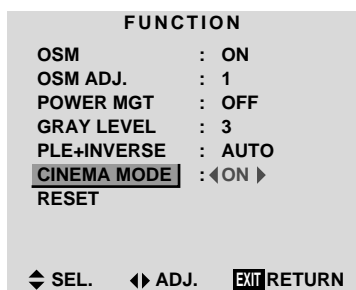
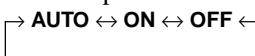

4. Once the setting is completed ...
Press the "OK" button to return to the main menu.
To delete the main menu, press the "OK" button once more.

Information

■ CINEMA MODE

- AUTO Automatic discrimination of the image and projection in cinema mode.
- ON All images are projected in cinema mode.
- OFF Cinema mode does not function.

■ Restoring the factory default settings

Select "RESET" under the function menu. Note that this also restores other settings to the factory defaults.

Resetting to the default values

Use these operations to restore all the picture adjustments, audio settings, to the factory default values.
Refer to page 17 for items to be reset.

Press the [3]-DI(ON) button on the remote controller to display the MAIN MENU on the screen, then...

1. Use the ▲ and ▼ buttons to select "FUNCTION", then press the [3]-DI(ON) button.
The "FUNCTION" screen appears.
2. Use the ▲ and ▼ buttons to select "RESET", then press the [3]-DI(ON) button.

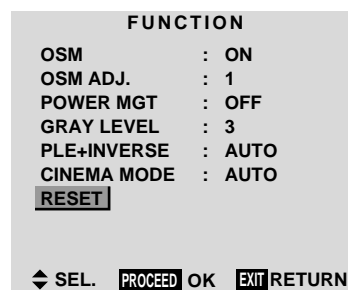

The "RESET" screen appears.

3. Use the ▲ and ▼ buttons to select "RESET", then press the [3]-DI(ON) button.

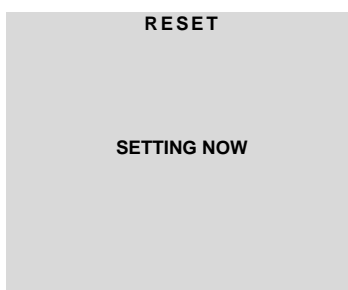

When the "SETTING NOW" screen disappears, the screen will be restored to the previous "RESET" mode, then all the settings are restored to the default values.

4. Once the setting is completed ...
Press the "OK" button.
To delete the main menu, press the "OK" button once more.



Option Setting Menu

Setting the allocation of the audio connectors

Setting the AUDIO 1, 2, and 3 connectors to the desired input.

Example: Set AUDIO 1 to RGB 2.

Press the **[3]-D1(ON)** button on the remote controller to display the MAIN MENU on the screen, then...

- Use the **▲** and **▼** buttons to select "OPTION", then press the **[3]-D1(ON)** button. The "OPTION" screen appears.
- Use the **▲** and **▼** buttons to select "AUDIO 1".



- To set the AUDIO1 to "RGB2"... Use the **▲** and **▼** buttons to select "AUDIO1". Use the **◀** and **▶** buttons to select "RGB2". The mode switches as follows each time the **◀** or **▶** button is pressed:

→ VIDEO1 ↔ VIDEO2 ↔ VIDEO3 ↔ HD/DVD1 ↔ RGB1 ↔ RGB2 ↔ RGB3 ←



- Once setting is completed... Press the "OK" button to return to the main menu. To delete the main menu, press the "OK" button once more.

Information

■ AUDIO INPUT

A single audio input cannot be selected as the audio channel for more than one input terminal.

■ Restoring the factory default settings

Select "RESET" under the function menu. Note that this also restores other settings to the factory defaults.

Setting the BNC connectors

Select whether to set the input of the 5 BNC connectors to RGB or component.

Example: Set the BNC SELECT mode to "COMP"

Press the **[3]-D1(ON)** button on the remote controller to display the MAIN MENU on the screen, then...

- Use the **▲** and **▼** buttons to select "OPTION", then press the **[3]-D1(ON)** button. The "OPTION" screen appears.
- Use the **▲** and **▼** buttons to select "BNC SELECT".



- To set the BNC SELECT mode to "COMP"... Use the **◀** and **▶** buttons to select "COMP". The mode switches as follows each time the **◀** or **▶** button is pressed:

RGB ↔ COMP



- Once setting is completed... Press the "OK" button to return to the main menu. To delete the main menu, press the "OK" button once more.

Information

■ BNC SELECT

RGB Uses the 5BNC terminal for RGB input.

COMP. Use the 3BNC terminal for component input.

■ Restoring the factory default settings

Select "RESET" under the function menu. Note that this also restores other settings to the factory defaults.



Setting a computer image to the correct RGB select screen

On the computer image select the RGB mode, moving image (video) mode, wide mode or digital broadcast.

Example: Setting the RGB SELECT mode to "VIDEO"

Press the **[3]-D1(ON)** button on the remote controller to display the MAIN MENU on the screen, then...

1. Use the **▲** and **▼** buttons to select "OPTION", then press the **[3]-D1(ON)** button. The "OPTION" screen appears.



2. Use the **▲** and **▼** buttons to select "RGB SELECT".

Information

■ RGB SELECT modes

One of these 4 modes must be selected in order to display the following signals correctly.

RGB VESA 640×480@60Hz (Use this mode for normal computer images.)

VIDEO To display the video signal that is converted to the RGB signal, set this mode.

WIDE When an 852 dot × 480 line signal with a horizontal frequency of 31.72 KHz is input, the image may be compressed horizontally. To prevent this, set RGB SELECT to WIDE.

DTV Set this model when watching digital broadcasting (480P).

■ Restoring the factory default settings

Select "RESET" under the function menu. Note that this also restores other settings to the factory defaults.

3. To set the RGB select mode to "VIDEO" ... Use the **◀** and **▶** buttons to select "VIDEO". The mode switches as follows each time the **◀** or **▶** button is pressed:

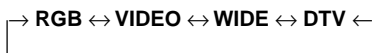

4. Once the setting is completed ... Press the "OK" button to return to the main menu. To delete the main menu, press the "OK" button once more.



Setting high definition images to the suitable screen size

Use this procedure to set whether the number of vertical lines of the input high definition image is 1035 or 1080.

Example: Setting the "1080B" mode to "1035I"

Press the **[3]-DI(ON)** button on the remote controller to display the MAIN MENU on the screen, then...

1. Use the **▲** and **▼** buttons to select "OPTION", then press the **[3]-DI(ON)** button. The "OPTION" screen appears.
2. Use the **▲** and **▼** buttons to select "HD SELECT".



3. To set the HD SELECT mode to "1035I" ... Use the **◀** and **▶** buttons to select "1035I". The mode switches as follows each time the **◀** or **▶** button is pressed:



4. Once the setting is completed ... Press the "OK" button to return to the main menu. To delete the main menu, press the "OK" button once more.

Information

■ HD SELECT modes

These 2 mode are not displayed in correct image automatically.

- 1080A Special digital broadcasts (for example : DTC100) [RGB/ PC only]
- 1080B Standard digital broadcasts
- 1035I Japanese "High Vision" signal format

Adjusting the display position in the RGB3 input mode

If the image is not stable when in the RGB3 input mode, switch the "RGB3 ADJ." number to 2 or 3.

Example: Setting the "1" mode to "2"

Press the **[3]-DI(ON)** button on the remote controller to display the MAIN MENU on the screen, then...

1. Use the **▲** and **▼** buttons to select "OPTION", then press the **[3]-DI(ON)** button. The "OPTION" screen appears.
2. Use the **▲** and **▼** buttons to select "RGB3 ADJ.".



3. To set RGB3 ADJ. mode to "2"... Use the **◀** and **▶** buttons to select "2". The mode switches as follows when the **◀** or **▶** buttons are pressed:

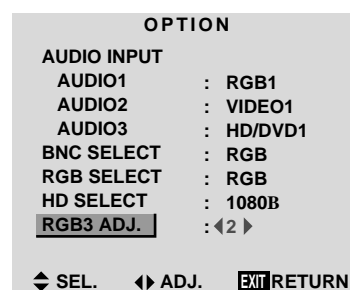
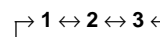

4. Once the adjustment is completed ... Press the "OK" button to return to the main menu. To delete the main menu, press the "OK" button once more.

Information

■ RGB3 ADJ.

The display position will change when the number is changed; when using the unit with "AUTO PICTURE" ON, switch it OFF and then back ON again to return the display position to its original location. When using the unit with "AUTO PICTURE" OFF, please perform the display position adjustment again.

■ Restoring the factory default settings

Select "RESET" under the function menu. Note that this also restores other settings to the factory defaults.

Information Menu

Checking the frequencies and polarities of input signals

Use this function to check the frequencies and polarities of the signals currently being inputted from a computer, etc.

Press the [3]-D1(ON) button on the remote controller to display the MAIN MENU on the screen, then...

1. Use the ▲ and ▼ buttons to select "INFORMATION", then press the [3]-D1(ON) button. The "INFORMATION" screen appears.
2. Use the ▲ and ▼ buttons to select "FREQUENCY", then press the [3]-D1(ON) button.

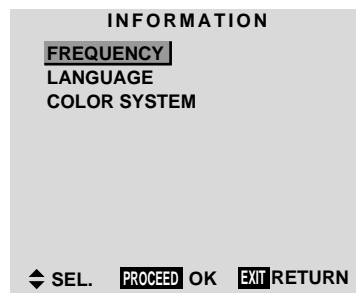

3. The frequency is displayed.

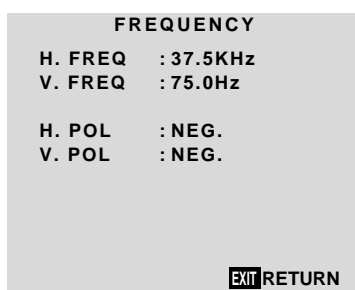

* Press the "OK" button to return to the previous screen.

4. Once you have checked the frequency ... Press the "OK" button to return to the main menu. To delete the main menu, press the "OK" button once more.

Setting the language for the menus

The menu display can be set to one of seven languages: Japanese, English, German, French, Swedish, Italian or Spanish.

Example: Setting the menu display to "DEUTSCH"

Press the [3]-D1(ON) button on the remote controller to display the MAIN MENU on the screen, then...

1. Use the ▲ and ▼ buttons to select "INFORMATION", then press the [3]-D1(ON) button. The "INFORMATION" screen appears.
2. Use the ▲ and ▼ buttons to select "LANGUAGE", then press the [3]-D1(ON) button.

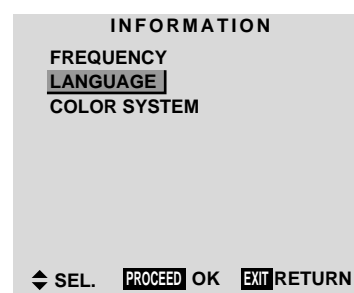

The "LANGUAGE" screen appears.

3. To select "DEUTSCH" ... Use the ◀ and ▶ buttons to select "DEUTSCH". The mode switches as follows when the ◀ and ▶ buttons are pressed:

→ ENGLISH ↔ DEUTSCH ↔ FRANÇAIS ←
 ↳ 日本語 ↔ SVENSKA ↔ ITALIANO ↔ ESPAÑOL ←



4. Press the [3]-D1(ON) button. The display language is switched to Deutsch.
5. Once the setting is completed ... Press the "OK" button to return to the main menu. To delete the main menu, press the "OK" button once more.

Information

■ Language settings

ENGLISH English
 DEUTSCH German
 FRANÇAIS French
 ESPAÑOL Spanish
 ITALIANO Italian
 SVENSKA Swedish
 日本語 Japanese



Setting the video signal format

Use these operations to set the video signal format.

Example: Setting the video signal format to "3.58 NTSC"

Press the [3]-D1(ON) button on the remote controller to display the MAIN MENU on the screen, then...

1. Use the ▲ and ▼ buttons to select "INFORMATION", then press the [3]-D1(ON) button. The "INFORMATION" screen appears.
2. Use the ▲ and ▼ buttons to select "COLOR SYSTEM", then press the [3]-D1(ON) button.

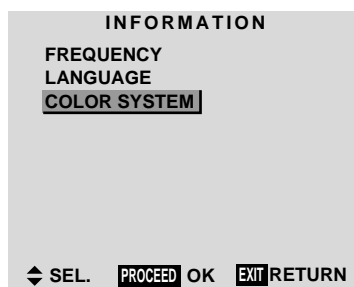

The "COLOR SYSTEM" screen appears.

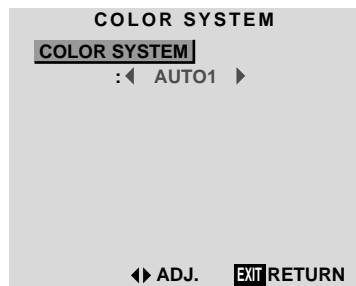

3. To select "3.58 NTSC" ... Use the ◀ and ▶ buttons to select "3.58 NTSC". The mode switches as follows when the ◀ and ▶ buttons are pressed:

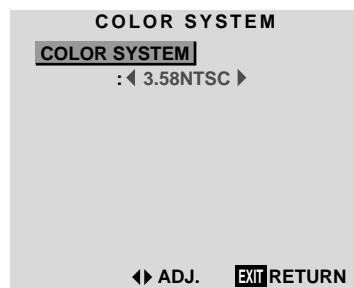
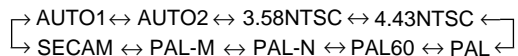

4. Once the setting is completed ... Press the "OK" button to return to the main menu. To delete the main menu, press the "OK" button once more. The color system is set to "3.58 NTSC".

Information

■ Video signal formats

Different countries use different formats for video signals. Set to the format used in your current country.

AUTO1/2 The video signals are automatically detected and the format is set accordingly.

AUTO1: 3.58NTSC, 4.43NTSC, PAL, SECAM, PAL60

AUTO2: PAL-M, PAL-N, 3.58NTSC

PAL(B.G) This is the standard format used mainly in the United Kingdom and Germany.

SECAM This is the standard format used mainly in France and Russia.

4.43 NTSC, PAL60 This format is used for videos in countries using PAL and SECAM video signals.

3.58 NTSC This is the standard format used mainly in Japan and the United States.

PAL-M This is the standard format used mainly in Brazil.

PAL-N This is the standard format used mainly in Argentina.

External Control

Application

These specifications cover the communications control of the plasma monitor by external equipment.

Connections

Connections are made as described below.

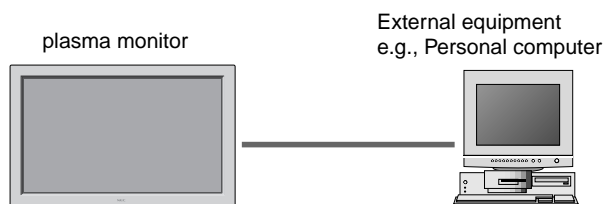

- 1) Connector on the plasma monitor side: EXTERNAL CONTROL connector.

Type of connector: D-Sub 9-pin male

No.	Pin Name
1	No Connection
2	RXD (Receive data)
3	TXD (Transmit data)
4	DTR (DTE side ready)
5	GND
6	DSR (DCE side ready)
7	RTS (Ready to send)
8	CTS (Clear to send)
9	No Connection

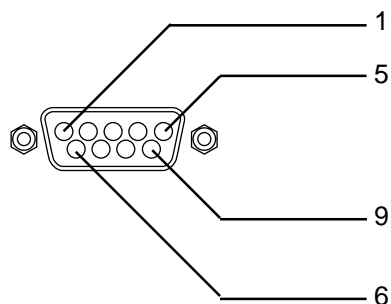

- 2) Connector on the external equipment side: Serial port (RS-232C) connector

See the specifications of the equipment that is to be connected for the type of connector and the pin assignment.

- 3) Wiring

Use a crossed (reverse) cable.

Wire the cable so that each pair of data lines cross between the two devices. These data line pairs are RXD (Receive data) and TXD (Transmit data), DTR (DTE side ready) and DSR (DCE side ready), and RTS (Ready to send) and CTS (Clear to send).

Communication Parameters

- | | |
|--------------------------|--------------|
| (1) Communication system | Asynchronous |
| (2) Interface | RS-232C |
| (3) Baud rate | 9600 bps |
| (4) Data length | 8 bits |
| (5) Parity | Odd |
| (6) Stop bit | 1 bit |
| (7) Communication code | Hex |



Communication Format

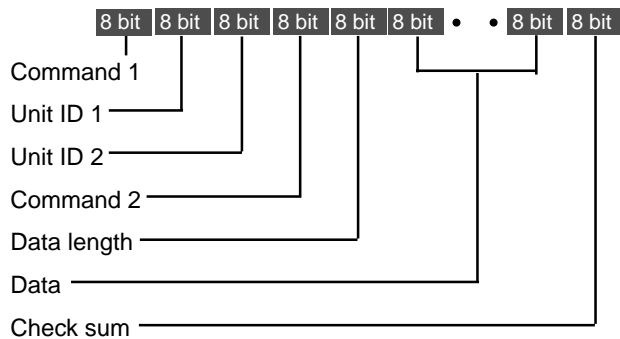

Command 1

Command 1, along with command 2, is a number used to distinguish each command.

In the case of ACK, when the lower order 4 bits is FH (as in 3FH and 7FH), this indicates that the commands and data of the supported equipment have been received. When the lower order 4 bits is BH (as in 3BH and 7BH), this indicates that unsupported commands and data have been received.

Unit ID 1 and Unit ID 2

Unit ID 1 and unit ID 2 are numbers used to identify the equipment that is to be connected.

60H is used for the plasma monitor and 80H is used for external control equipment such as a personal computer.

- 1) Unit ID 1: Indicates the equipment sending the signal
- 2) Unit ID 2: Indicates the equipment receiving the signal

Command 2

Command 2, along with command 1, is a number used to distinguish each command.

Check Sum (CKS), Error Processing, and ACK

- 1) The check sum described below and RS-232C odd parity are used together for a check of the received data. The check sum is the lower order 8 bits of one frame of sent or received data comprising the sum total of Command 1, Unit ID 1 and 2, Command 2, Data Length, and Data.

Check Sum Example

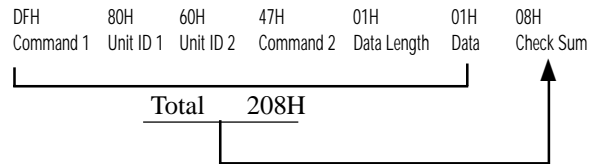

2) Error Processing

- When the communication interval is vacant for more than 4 ms, thereafter a received Command 1 will be recognized. If, at this time, meaningful data cannot be recognized, that data will not be recognized (as valid data).
- An ACK will not be returned unless the receive data error, the check sum error, and the receive data are all taken in.

Communications Flow

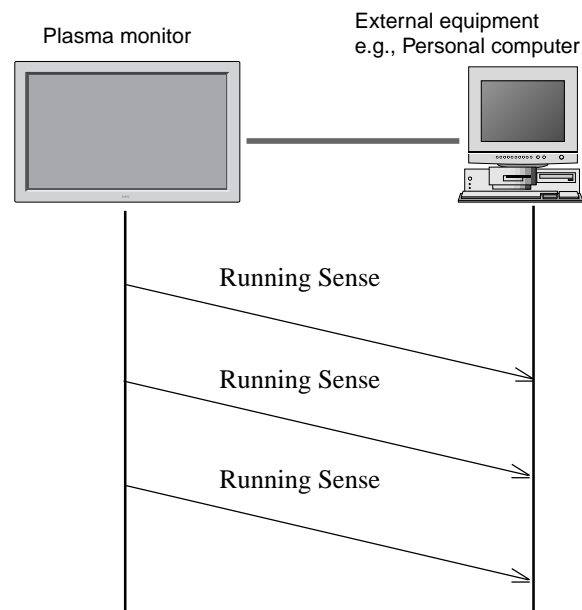

The plasma monitor regularly transmits a Running Sense command at an interval of approximately 1 second. (Running Sense command: 1FH 60H E0H 88H 00H E7H) This command is used to recognize optional equipment. The return of an ACK is not required when external equipment such as a personal computer has been connected. Note that destruction of this data is recommended when it is taken in.

When various commands are to be sent from external equipment such as a personal computer, the plasma monitor is always receive enabled.

Note that when an ACK has not been returned from the plasma monitor in 1.5 seconds, a resending of the command is recommended.



Command Reference List

	CMD1	CMD2	LEN
01. Power ON	9FH	4EH	00H
02. Power OFF	9FH	4FH	00H
03. Input Switch Change	DFH	47H	01H
04. VOLUME Gain Data	DFH	7FH	03H
05. SCREEN MODE Select	DFH	51H	01H
06. AUDIO Mute On	9FH	3EH	00H
07. AUDIO Mute Off	9FH	3FH	00H
08. OSM Select	DFH	58H	01H
09. Color Gain Data	DFH	7FH	03H
10. TINT Gain Data	DFH	7FH	03H
11. SHARPNESS Gain Data	DFH	7FH	03H
12. CONTRAST Gain Data	DFH	7FH	03H
13. BRIGHT Gain Data	DFH	7FH	03H
14. Input MODE Request	1FH	41H	00H
15. RESET	1FH	54H	00H
16. COLOR TEMP SELECT	DFH	00H	01H
17. RED Gain Data	DFH	7FH	04H
18. GREEN Gain Data	DFH	7FH	04H
19. BLUE Gain Data	DFH	7FH	04H
20. VIDEO ADJ Request	1FH	45H	00H
21. Audio Select Set	DFH	70H	02H
22. Audio Select Request	1FH	6FH	00H
23. PLE_INVERSE Set	DFH	6AH	02H
24. Failure Mode Request	1FH	3FH	00H

01. Power ON

Function

The external control equipment switches on the power of the plasma monitor.

Transmission Data

9FH 80H 60H 4EH 00H CKS

ACK

The plasma monitor returns the following ACK when the power is switched on.

3FH 60H 80H 4EH 00H CKS

02. Power OFF

Function

The external control equipment switches off the power of the plasma monitor.

Transmission Data

9FH 80H 60H 4FH 00H CKS

ACK

The plasma monitor returns the following ACK when the power is switched off.

3FH 60H 80H 4FH 00H CKS

03. Input Switch Change

Function

The external control equipment switches the input of the plasma monitor.

Transmission Data

DFH 80H 60H 47H 01H DATA00 CKS

DATA00 : Input Select

01H: Video1
02H: Video2
03H: Video3
05H: HD (HD1 or DTV or DTV1)
06H: HD2 (DTV2)
07H: RGB1/PC1
08H: RGB2/PC2
0CH: RGB3/PC3

ACK

The plasma monitor returns the following ACK when the input is switched.

3FH 60H 80H 47H 00H CKS

04. VOLUME Gain Data

Function

The external control equipment changes the VOLUME gain data of the plasma monitor.

Transmission Data

DFH 80H 60H 7FH 03H DATA00 DATA01 DATA02 CKS

DATA00 USER SOUND Gain Flag 05H
DATA01 VOLUME Gain Flag 01H
DATA02 VOLUME Gain 00H: Step 0
|
0AH: Step 10 (Default)
|
2AH: Step 42

ACK

7FH 60H 80H 7FH 02H DATA00 DATA01 CKS

DATA00 USER SOUND Gain Flag 05H
DATA01 VOLUME Gain Flag 01H

05. SCREEN MODE Select

Function

The external control equipment switches the screen mode of the plasma monitor.

Transmission Data

DFH 80H 60H 51H 01H DATA00 CKS

DATA00 02H : STADIUM
03H : ZOOM
04H : NORMAL
05H : FULL

ACK

7FH 60H 80H 51H 01H DATA00 CKS

DATA00 02H : STADIUM
03H : ZOOM
04H : NORMAL
05H : FULL



06. AUDIO Mute On

Function

The external control equipment switches on AUDIO Mute of the plasma monitor.

Transmission Data

9FH 80H 60H 3EH 00H CKS

ACK

3FH 60H 80H 3EH 00H CKS

07. AUDIO Mute Off

Function

The external control equipment switches off AUDIO Mute of the plasma monitor.

Transmission Data

9FH 80H 60H 3FH 00H CKS

ACK

3FH 60H 80H 3FH 00H CKS

08. OSM Select

Function

The external control equipment switches on or off the on-screen display (OSM) of the plasma monitor.

Transmission Data

DFH 80H 60H 58H 01H DATA00 CKS

DATA00 01H : Screen display On
02H : Screen display Off

ACK

7FH 60H 80H 58H 01H DATA00 CKS

DATA00 01H : Screen display On
02H : Screen display Off

Screen display On/Off is equivalent to the screen display On/Off function of the convenient function settings.

*Operation is as described in the table below.

Operation	On-Screen Display (OSD)			
	Display of items and adjustments on the menu		Volume display, input display, and screen size display	
	When screen display is ON	When screen display is OFF	When screen display is ON	When screen display is OFF
Remote control operation	Yes	Yes	Yes	No
Personal computer control operation	No	No	Yes	No

09. COLOR Gain Data

Function

The external control equipment changes the COLOR gain data of the plasma monitor.

Transmission Data

DFH 80H 60H 7FH 03H DATA00 DATA01 DATA02 CKS

DATA00: USER PICTURE Gain Flag 01H
DATA01: COLOR Gain Flag 04H
DATA02: COLOR Gain EAH: -22
|
FFH: -01
00H: 0
01H: +01
|
16H: +22

ACK

7FH 60H 80H 7FH 02H DATA00 DATA01 CKS

DATA00: USER PICTURE Gain Flag 01H
DATA01: COLOR Gain Flag 04H

10. TINT Gain Data

Function

The external control equipment changes the TINT gain data of the plasma monitor.

Transmission Data

DFH 80H 60H 7FH 03H DATA00 DATA01 DATA02 CKS

DATA00: USER PICTURE Gain Flag 01H
DATA01: TINT Gain Flag 05H
DATA02: TINT Gain EAH: -22
|
FFH: -01
00H: 0
01H: +01
|
16H: +22

ACK

7FH 60H 80H 7FH 02H DATA00 DATA01 CKS

DATA00: USER PICTURE Gain Flag 01H
DATA01: TINT Gain Flag 05H



11. SHARPNESS Gain Data

Function

The external control equipment changes the SHARPNESS gain data of the plasma monitor.

Transmission Data

DFH	80H	60H	7FH	03H	DATA00	DATA01	DATA02	CKS
DATA00:	USER PICTURE Gain Flag				01H			
DATA01:	SHARPNESS Gain Flag				06H			
DATA02:	SHARPNESS Gain				FOH: -16			
					FFH: -01			
					00H: 0			
					01H: +01			
					10H: +16			

ACK

7FH	60H	80H	7FH	02H	DATA00	DATA01	CKS
DATA00:	USER PICTURE Gain Flag				01H		
DATA01:	SHARPNESS Gain Flag				06H		

12. CONTRAST Gain Data

Function

The external control equipment changes the CONTRAST gain data of the plasma monitor.

Transmission Data

DFH	80H	60H	7FH	03H	DATA00	DATA01	DATA02	CKS
DATA00:	USER PICTURE Gain Flag				01H			
DATA01:	CONTRAST Gain Flag				07H			
DATA02:	CONTRAST Gain				00H : 0			
					34H: +52			

ACK

7FH	60H	80H	7FH	02H	DATA00	DATA01	CKS
DATA00:	USER PICTURE Gain Flag				01H		
DATA01:	CONTRAST Gain Flag				07H		

13. BRIGHT Gain Data

Function

The external control equipment changes the BRIGHT gain data of the plasma monitor.

Transmission Data

DFH	80H	60H	7FH	03H	DATA00	DATA01	DATA02	CKS
DATA00:	USER PICTURE Gain Flag				01H			
DATA01:	BRIGHT Gain Flag				08H			
DATA02:	BRIGHT Gain				EOH: -32			
					FFH: -01			
					00H: 0			
					01H: +01			
					20H: +32			

ACK

7FH	60H	80H	7FH	02H	DATA00	DATA01	CKS
DATA00:	USER PICTURE Gain Flag				01H		
DATA01:	BRIGHT Gain Flag				08H		

14. Input MODE Request

Function

The display returns the current input information by the external control equipment's request.

Transmission Data

1FH	80H	60H	41H	00H	CKS
-----	-----	-----	-----	-----	-----

ACK

7FH	60H	80H	41H	01H	DATA00	CKS
DATA00:	Input Select					
	01H: Video1				02H: Video2	
	03H: Video3				04H: HD (HD1 or DTV or DTV1)	
	05H: RGB1/PC1				06H: RGB2/PC2	
	0AH: DVD (DVD1)				0CH: HD2 (DTV2)	
	0DH: DVD2				0EH: RGB3/PC3	

15. RESET

Function

The external control equipment resets the user adjustment of the plasma monitor.

Transmission Data

1FH	80H	60H	54H	00H	CKS
-----	-----	-----	-----	-----	-----

ACK

3FH	60H	80H	54H	00H	CKS
-----	-----	-----	-----	-----	-----

16. COLOR TEMP SELECT

Function

The external control equipment changes the COLOR TEMP of the plasma monitor.

Transmission Data

DFH	80H	60H	00H	01H	DATA00	CKS
-----	-----	-----	-----	-----	--------	-----

DATA00

- 00H: 1
- 01H: 2
- 02H: 3
- 03H: PRO

ACK

7FH	60H	80H	00H	01H	DATA00	CKS
-----	-----	-----	-----	-----	--------	-----

DATA00:

- 00H: 1
- 01H: 2
- 02H: 3
- 03H: PRO

NOTE: Set so that at the selection of 1, 2, or 3 of COLOR TEMP change of the following R/G/B GAIN data cannot be accepted. (This must be operated in the same way as OSD menu.)



17. RED Gain Data

Function

The external control equipment changes the RED Gain Data of the plasma monitor.

Transmission Data

DFH	80H	60H	7FH	04H	DATA00 to DATA03	CKS
					DATA00: USER PICTURE Gain Flag	01H
					DATA01: RED Gain Flag	01H
					DATA02: RED Gain 1 (Bias)	D8H: -40 FFH: -1 00H: 0 28H: +40
					DATA03: RED Gain 2 (Drive)	D8H: -40 FFH: -1 00H: 0 28H: +40

ACK

7FH	60H	80H	7FH	02H	DATA00	DATA01	CKS
					DATA00: USER PICTURE Gain Flag	01H	
					DATA01: RED Gain Flag	01H	

18. GREEN Gain Data

Function

The external control equipment changes the GREEN Gain Data of the plasma monitor.

Transmission Data

DFH	80H	60H	7FH	04H	DATA00 to DATA03	CKS
					DATA00: USER PICTURE Gain Flag	01H
					DATA01: GREEN Gain Flag	02H
					DATA02: GREEN Gain 1 (Bias)	D8H: -40 FFH: -1 00H: 0 28H: +40
					DATA03: GREEN Gain2 (Drive)	D8H: -40 FFH: -1 00H: 0 28H: +40

ACK

7FH	60H	80H	7FH	02H	DATA00	DATA01	CKS
					DATA00: USER PICTURE Gain Flag	01H	
					DATA01: GREEN Gain Flag	02H	

19. BLUE Gain Data

Function

The external control equipment changes the BLUE Gain Data of the plasma monitor.

Transmission Data

DFH	80H	60H	7FH	04H	DATA00 to DATA03	CKS
					DATA00: USER PICTURE Gain Flag	01H
					DATA01: BLUE Gain Flag	03H
					DATA02: BLUE Gain1(Bias)	D8H: -40 FFH: -1 00H: 0 28H: +40
					DATA03: BLUE Gain2(Drive)	D8H: -40 FFH: -1 00H: 0 28H: +40

ACK

7FH	60H	80H	7FH	02H	DATA00	DATA01	CKS
					DATA00: USER PICTURE Gain Flag	01H	
					DATA01: BLUE Gain Flag	03H	



20. VIDEO ADJ Request

Function

The display returns the video adjustments information by the external control equipment's request.

Transmission Data

1FH 80H 60H 45H 00H CKS

ACK

7FH 60H 80H 45H 0CH DATA00 to DATA0B CKS

DATA00: RED Gain(Bias) D8H: -40
 |
 FFH: -1
 00H: 0
 |
 28H: +40

DATA01: GREEN Gain(Bias) D8H: -40
 |
 FFH: -1
 00H: 0
 |
 28H: +40

DATA02: BLUE Gain(Bias) D8H: -40
 |
 FFH: -1
 00H: 0
 |
 28H: +40

DATA03: COLOR Gain EAH: -22
 |
 FFH: -01
 00H: 0
 01H: +01
 |
 16H: +22

DATA04: TINT Gain EAH: -22
 |
 FFH: -01
 00H: 0
 01H: +01
 |
 16H: +22

DATA05: SHARPNESS Gain F0H: -16
 |
 FFH: -01
 00H: 0
 01H: +01
 |
 10H: +16

DATA06: CONTRAST Gain 00H: 0
 |
 34H: +52

DATA07: BRIGHT Gain E0H: -32
 |
 FFH: -01
 00H: 0
 01H: +01
 |
 20H: +32

DATA08: RED Gain(Drive) D8H: -40
 |
 FFH: -1
 00H: 0
 |
 28H: +40

DATA09: GREEN Gain(Drive) D8H: -40
 |
 FFH: -1
 00H: 0
 |
 28H: +40

DATA0A: BLUE Gain(Drive) D8H: -40
 |
 FFH: -1
 00H: 0
 |
 28H: +40

DATA0B: COLOR TEMP 00H: 1
 01H: 2
 02H: 3
 03H: PRO



21. Audio Select Set

Function

The external control equipment sets combinations of audio and video inputs for the plasma monitor.

Transmission Data

DFH	80H	60H	70H	02H	DATA00	DATA01	CKS
-----	-----	-----	-----	-----	--------	--------	-----

DATA00: AUDIO INPUT
 01H: AUDIO 1
 02H: AUDIO 2
 03H: AUDIO 3

DATA01: VISUAL INPUT
 01H: Video 1
 02H: Video 2
 03H: Video 3
 05H: HD (HD1 or DTV or DTV1)
 06H: HD2 (DTV2)
 07H: RGB 1/ PC 1
 08H: RGB 2/ PC 2
 0CH: RGB 3/ PC 3

ACK

The plasma monitor returns the following ACK when the input is switched.

3FH	60H	80H	70H	00H	CKS
-----	-----	-----	-----	-----	-----

* The plasma monitor returns "Not Available" when selecting the video input same as the one set at one of the AUDIO 01 to 3.

Example:

The plasma monitor returns "Not Available" when selecting the VIDEO1 for AUDIO2 or VIDEO3 after VIDEO1 has been set to AUDIO1.

22. Audio Select Request

Function

The external control equipment inquires the current combinations of audio and video inputs for the plasma monitor.

Transmission Data

1FH	80H	60H	6FH	00H	CKS
-----	-----	-----	-----	-----	-----

ACK

The plasma monitor returns the following ACK:

7FH	60H	80H	6FH	03H	DATA00	DATA01	DATA02	CKS
-----	-----	-----	-----	-----	--------	--------	--------	-----

DATA00: AUDIO 1
 DATA01: AUDIO 2
 DATA02: AUDIO 3

VISUAL INPUT DATA
 01H: Video 1
 02H: Video 2
 03H: Video 3
 05H: HD (HD1 or DTV or DTV 1)
 06H: HD2 (DTV2)
 07H: RGB 1 /PC 1
 08H: RGB 2 /PC 2
 0CH: RGB 3 /PC 3

23. PLE_INVERSE Set

Function

The external control equipment sets the PLE and INVERSE (inverse of image brightness) of the plasma monitor.

Transmission Data

DFH	80H	60H	6AH	02H	DATA00	DATA01	CKS
-----	-----	-----	-----	-----	--------	--------	-----

DATA00 : PLE
 01H: AUTO
 02H: LOCK

DATA01 : INVERSE
 01H: ON
 02H: OFF

ACK

The plasma monitor returns the following ACK when setting the PLE and INVERSE (inverse of image brightness):

3FH	60H	80H	6AH	00H	CKS
-----	-----	-----	-----	-----	-----

24. Failure Mode Request

Function

The external control equipment inquires the detection of failures of the plasma monitor.

Transmission Data

1FH	80H	60H	3FH	00H	CKS
-----	-----	-----	-----	-----	-----

ACK

The plasma monitor returns the following ACK:

7FH	60H	80H	3FH	02H	DATA00	DATA01	CKS
-----	-----	-----	-----	-----	--------	--------	-----

DATA00:FAILURE MODE 1

Bit 0 : PDP MODULE
 0: Abnormal
 1: Normal

Bit 1 : fixed (backup)

Bit 2 : TEMPERATURE
 0: Abnormal
 1: Normal

Bit 3 : FAN
 0: Abnormal
 1: Normal

Bit 4 : fixed (backup)

Bit 5 : fixed (backup)

Bit 6 : fixed (backup)

Bit 7 : fixed (backup)

DATA00:FAILURE MODE 2

Bit 0-7 : fixed (backup)

Table for Signals Supported

Supported resolution

- When screen mode is NORMAL, each signal is converted to a 640 dots × 480 lines signal. (Except for *3)
- When screen mode is FULL, each signal is converted to a 853 dots × 480 lines signal. (Except for *2)

Computer input signals supported on this system

Model	Dots × lines	Vertical frequency (Hz)	Horizontal frequency (kHz)	Screen mode	
				NORMAL	FULL
*IBM PC/AT compatible computers	640 × 400	70.1	31.5	YES*1	YES*1
	640 × 480	59.9	31.5	YES	YES
		72.8	37.9	YES	YES
		75.0	37.5	YES	YES
		85.0	43.3	YES	YES
		100.0	51.1	YES	YES
		120.0	61.3	YES	YES
	848 × 480*2	60.0	31.0	--	YES
	800 × 600	56.3	35.2	YES	YES
		60.3	37.9	YES	YES
		72.2	48.1	YES	YES
		75.0	46.9	YES	YES
		85.0	53.7	YES	YES
		100.0	63.0	YES	YES
	1024 × 768	120.0	75.7	YES	YES
		60.0	48.4	YES	YES
		70.0	56.5	YES	YES
		75.0	60.0	YES	YES
85.0		68.7	YES	YES	
1280 × 1024	100.0	80.5	YES	YES	
	60.0	64.0	YES*3	YES	
	640 × 480	66.6	35.0	YES	YES
	832 × 624	74.6	49.7	YES	YES
*Apple Macintosh	1024 × 768	74.9	60.2	YES	YES
	1152 × 870	75.1	68.7	YES	YES

*1 Display only 400 lines with the screen center of the vertical orientation located at the center.

*2 Only when using a graphic accelerator board that is capable of displaying 848 × 480.

*3 Aspect ratio is 5:4. This signal is converted to a 600 dots × 480 lines signal.

NOTE:

- With digital inputs some signals are not accepted.
- The sync may be disturbed when non standard signals other than the aforementioned are input.
- When connecting a composite sync signal, use the HD terminal.

* "IBM PC/AT" and "VGA" are a registered trademark of International Business Machines, Inc. of the United States.

* "Apple Macintosh" is a registered trademark of Apple Computer, Inc. of the United States.

Troubleshooting

If the picture quality is poor or there is some other problem, check the adjustments, operations, etc., before requesting service.

Symptom	Checks	Remedy
Picture is disturbed. Sound is noisy. Remote control unit operates erroneously.	<ul style="list-style-type: none"> Is a connected component set directly in front or at the side of the display? 	<ul style="list-style-type: none"> Leave some space between the display and the connected components.
The remote controller does not work.	<ul style="list-style-type: none"> Are the remote controller's batteries worn out? 	<ul style="list-style-type: none"> Replace both batteries with new ones.
Monitor's power does not turn on when the remote controller's power button is pressed.	<ul style="list-style-type: none"> Is the monitor's power cord plugged into a power outlet? 	<ul style="list-style-type: none"> Plug the monitor's power cord into a power outlet.
	<ul style="list-style-type: none"> Are all the monitor's indicators off? 	<ul style="list-style-type: none"> Press the power button on the monitor to turn on the power.
	<ul style="list-style-type: none"> Are the remote controller's batteries worn out? 	<ul style="list-style-type: none"> Replace both batteries with new ones.
Monitor does not operate when the remote controller's buttons are pressed.	<ul style="list-style-type: none"> Is the remote controller pointed at the monitor, or is there an obstacle between the remote controller and the monitor? 	<ul style="list-style-type: none"> Point the remote controller at the monitor's remote control sensor when pressing buttons, or remove the obstacle.
	<ul style="list-style-type: none"> Is direct sunlight or strong artificial light shining on the monitor's remote control sensor? 	<ul style="list-style-type: none"> Eliminate the light by closing curtains, pointing the light in a different direction, etc.
	<ul style="list-style-type: none"> Are the remote controller's batteries worn out? 	<ul style="list-style-type: none"> Replace both batteries with new ones.
	<ul style="list-style-type: none"> The remote cable is plugged into the REMOTE IN terminal (Wired) 	<ul style="list-style-type: none"> Unplug the remote cable from the monitor.
	<ul style="list-style-type: none"> The front panel buttons of the main unit do not function. 	<ul style="list-style-type: none"> The front panel buttons do not function during Control Lock.
No sound or picture is produced.	<ul style="list-style-type: none"> Is the monitor's power cord plugged into a power outlet? 	<ul style="list-style-type: none"> Plug the monitor's power cord into a power outlet.
Picture appears but no sound is produced.	<ul style="list-style-type: none"> Is the volume set at the minimum? 	<ul style="list-style-type: none"> Increase the volume.
	<ul style="list-style-type: none"> Is the mute mode set? 	<ul style="list-style-type: none"> Press the remote controller's mute button.
	<ul style="list-style-type: none"> Are the speakers properly connected? 	<ul style="list-style-type: none"> Connect the speakers properly.
	<ul style="list-style-type: none"> Is AUDIO INPUT set correctly? 	<ul style="list-style-type: none"> Set AUDIO INPUT on the OPTION menu correctly.
Poor picture with VIDEO signal input.	<ul style="list-style-type: none"> Improper control setting. Local interference. Cable interconnections. Input impedance is not correct level. 	<ul style="list-style-type: none"> Adjust picture control as needed. Try another location for the monitor. Be sure all connections are secure.
Poor picture with RGB signal input.	<ul style="list-style-type: none"> Improper control setting. Incorrect 15 PIN connector pin connections. 	<ul style="list-style-type: none"> Adjust picture controls as needed. Check pin assignments and connections.
Tint is poor or colors are weak.	<ul style="list-style-type: none"> Are the tint and colors properly adjusted? 	<ul style="list-style-type: none"> Adjust the tint and color (under "PICTURE").
Nothing appears on screen.	<ul style="list-style-type: none"> Is the computer's power turned on? 	<ul style="list-style-type: none"> Turn on the computer's power.
	<ul style="list-style-type: none"> Is a source connected? 	<ul style="list-style-type: none"> Connect source to the monitor.
	<ul style="list-style-type: none"> Is the power manager function in the standby or off mode? 	<ul style="list-style-type: none"> Operate the computer (move the mouse, etc.).
Part of picture is cut off or picture is not centered.	<ul style="list-style-type: none"> Is the position adjustment appropriate? 	<ul style="list-style-type: none"> Adjust the "SCREEN" properly.
Image is too large or too small.	<ul style="list-style-type: none"> Is the screen size adjustment appropriate? 	<ul style="list-style-type: none"> Press the "WIDE" button on the remote controller and adjust properly.
Picture is unstable.	<ul style="list-style-type: none"> Is the computer's resolution setting appropriate? 	<ul style="list-style-type: none"> Set to the proper resolution.
POWER/STANDBY indicator is lighted in orange or red.	<ul style="list-style-type: none"> Horizontal and / or vertical sync signal is not present when the Intelligent Power Manager control is on. 	<ul style="list-style-type: none"> Check the input signal.
POWER/STANDBY indicator is blinking in red.	<ul style="list-style-type: none"> The temperature inside the main unit has become too high and has activated the protector. 	<ul style="list-style-type: none"> Promptly switch off the power of the main unit and wait until the internal temperature drops. See *1.
POWER/STANDBY indicator is blinking in green.	_____	<ul style="list-style-type: none"> Promptly switch off the power of the main unit. See *2.

*1 Overheat protector

If the monitor becomes too hot, the overheat protector will be activated and the monitor will be turned off. If this happens, turn off the power to the monitor and unplug the power cord. If the room where the monitor is installed is particularly hot, move monitor to a cooler location and wait for the monitor to cool for 60 minutes. If the problem persists, contact your Marantz dealer for service.

*2 In the following case, power off the monitor immediately and contact your dealer.

The monitor turns off 5 seconds after powering on and then the POWER/STANDBY indicator blinks. It indicates that the power supply circuit or, one more fans have been damaged.

Specifications

Product Name	SLIM SERLES PLASMA MONITOR
Product Code	PD4292D
Screen Size	36.3"(H) × 20.4"(V) inches 921(H) × 518.4(V) mm diagonal 42"
Aspect Ratio	16 : 9
Resolution	853(H) × 480(V) pixels
Pixel Pitch	0.04"(H) × 0.04"(V) inches 1.08(H) × 1.08(V) mm
Color Reproduction	256 levels, 16,770,000 colors
Signals	
Synchronization Range	Horizontal : 15.5 to 80.5 kHz (automatic : step scan) Vertical : 50.0 to 120 Hz (automatic : step scan)
Input Signals	RGB, NTSC (3.58/4.43), PAL (B,G,M,N), PAL60, SECAM, HD* ¹ , DVD* ¹ , DTV* ¹
Input Terminals	
RGB	
Visual 1 (Analog)	mini D-sub 15-pin × 1
Visual 2 (Analog)	BNC (R, G, B, H/CS, V) × 1
Visual 3 (Digital)	DVI-I 29-pin × 1* ² (Not compatible with analog input)
Video	
Visual 1	RCA-pin × 1
Visual 2	BNC × 1
Visual 3	S-Video: DIN 4-pin × 1
DVD/HD/DTV	
Visual	RCA-pin (Y, Pb[Cb], Pr[Cr])
Audio	Stereo RCA × 3
External Control	D-sub 9-pin × 1 (RS-232C)
Sound output	7W+7W at 6 ohm
Power Supply	AC100-240V 50/60Hz
Current Rating	5.0A (maximum) Marantz
Power Consumption	395W (typical)
Dimensions	41.3 (W) × 25.5 (H) × 3.5 (D) inch 1048 (W) × 648 (H) × 89 (D) mm
Weight	70.6 lbs / 32 kg
Environmental Considerations	
Operating Temperature	0°C to 40°C / 32°F to 104°F
Humidity	20 to 80%
Altitude	0 to 1900m / 0 to 6230ft
Storage Temperature	-10°C to 50°C / 14°F to 122°F
Humidity	10 to 90%
Altitude	0 to 3000m / 0 to 9840ft
Front Panel User Controls	Power on/off, Input source select, Volume up/down/ OSM control
Remote Control Functions	Power on/off, Input source select, OSM control, Volume up/down, Cursor (UP, DOWN, LEFT, RIGHT), Pointer, Zoom up/down, Off timer, Wireless/ Wired remote control
OSM Functions	Picture (Contrast / Brightness / Sharpness / Color / Tint / Picture mode/ Color temperature / Noise reductions), Sound (Bass / Treble / Balance), Screen (V-Position / H-Position / V- Height/ H-Width/ Auto Picture/ Fine picture/ Picture adjustment), Function (OSM/ OSM adjustment/ Power management/ Gray level/ PLE+INVERSE/ Cinema mode/ Reset)/ Option (Audio input/ BNC select/ RGB select/ HD select/ RGB3 Adjustment), Information (Fre- quency / Language / Color system)

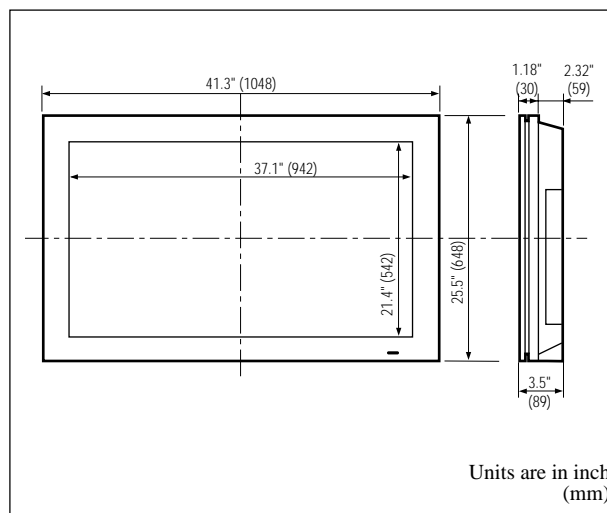

The features and specifications may be subject to change without notice.

*¹ HD/DVD/DTV input signals supported on this system

480P (60 Hz)	480I (60 Hz)
525P (60 Hz)	525I (60 Hz)
625P (50 Hz)	625I (50 Hz)
720P (60 Hz)	1035I (60 Hz)
	1080I (60 Hz)

*² It doesn't cope with copy protection.

Other Features	Power management, plug and play (DDC1, DDC2b, RGB3: DDC2b only), Control lock
Accessories	Remote controller RC2000MK2 with four AA batteries, Power cord, User's Manual, Safty metal fitting (2 pieces), Screw for safty metal fitting (2 pieces), Ferrite core. (small × 2, large × 1)
Regulations	UL Approved (UL 1950, CSA 950) DOC Canada requirements Meets FCC Class A requirements



marantz®

Limited Warranty for the Marantz SLIM SERIES PLASMA MONITOR

Who is covered?

You must have proof of purchase to receive warranty service.

What is covered?

- 1) Warranty coverage begins the day you purchase your Plasma Television, and continues for a period of one year.
- 2) Marantz America will provide in-home warranty repair.
- 3) Marantz America will incur all labor charges for repairs during the warranty period.
- 4) Marantz America will incur all freight charges for warranty repairs, both to Marantz and the return to the customer.
We suggest keeping all packing materials for any shipping that might be required.
- 5) All parts, including repaired and replaced parts are covered only for the original warranty period.

When the warranty on the product expires, the warranty on all replaced and repaired parts also expires.

What is excluded?

Your warranty does not cover:

- 1) Labor charges for installation or setup of the product, cleaning, adjustment of customer controls on the product, and installation or repair of antenna systems outside of the product.
- 2) Improper installation, removal or maintenance, or failure to follow instructions supplied with the product.
- 3) Reception problems caused by signal conditions from cable or antenna systems outside the product.
- 4) Repair, attempted repair or modification performed by anyone other than an authorized Marantz America service center.
- 5) Any product, on which the serial number has been defaced, modified or removed.
- 6) Warranty is void if purchase was made from anyone other than an authorized Marantz dealer.
- 7) Warranty is void if purchased from outside The United States of America.
- 8) Warranty only valid in the United States of America.
- 9) Damage due to lightning or power line surges, spikes

and brown outs, damages that occur during shipping or transit, or damage which is attributed to acts of God.

- 10) Incidental or consequential damages resulting from the product. (Some states do not allow the exclusion of incidental or consequential damages, so the above exclusion may not apply to you. This warranty gives you specific legal rights, and you may also have other rights that vary from state to state.)
- 11) Commercial or institutional use.
- 12) Any other cause which does not relate to product defect.
- 13) Burns or residual images upon the phosphor of the tubes.

Note: Pixel defect

Plasma is one of the most advanced technologies for consumer products. The panel is made by high precision technology, however some pixel defects may be found on the Plasma display panel. We are trying our best to control the quality in order to reduce the number of defective pixels. It is almost impossible to have zero pixel defects, even using the most advanced technology. This is not a problem only for Marantz, but all Plasma manufacturers. Therefore we have to note that the warranty does not cover the Plasma display panel for pixel defects. We appreciate your understanding.

Before requesting service:

Please check your owner's manual before requesting service. Adjustments of the controls and hook up guidelines discussed there may save you a service call.

To get warranty service:

Repair must be performed by an authorized service center. If you do not know of a Marantz authorized Plasma Television service center, contact your dealer. If your dealer is an authorized service center, they will arrange for repair. If your dealer is not a Marantz authorized Plasma Television service center, they will direct you to an authorized service center. You can also call 1-800-270-4533 for an authorized Marantz service center in your area.

Optimum performance:

For optimum performance and picture quality, the Plasma monitor is only guaranteed up to 6,230 feet above sea level.

Marantz America, Inc.

440 Medinah Road
Roselle, IL 60172-2330
Tel. 630-307-3100 Fax. 630-307-2687



marantz® is a registered trademark.

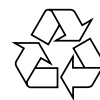

Printed in Japan

00/09 MIT 314W851210



PD4292D-2

61



00.10.4, 3:11 PM



Free Manuals Download Website

<http://myh66.com>

<http://usermanuals.us>

<http://www.somanuals.com>

<http://www.4manuals.cc>

<http://www.manual-lib.com>

<http://www.404manual.com>

<http://www.luxmanual.com>

<http://aubethermostatmanual.com>

Golf course search by state

<http://golfingnear.com>

Email search by domain

<http://emailbydomain.com>

Auto manuals search

<http://auto.somanuals.com>

TV manuals search

<http://tv.somanuals.com>