



HD6400W Digital Projection Television and Remote Control



Getting Started

- Warning/Precautions1
- DPTV Integrated Product Design and Features ..1
- Basic DPTV and Remote Control Description of Controls and Operations2-3
- Digital (ATSC) Menu Control Operations4-5
- Analog (NTSC) Menu Control Operations6
- Monitor Menu Control Operations7
- Digital TV Rollout - Time/Terms/& Technology .8

- For details on product safety, registration, warranty, and service refer to the other literature included with your TV information packet. Please retain all these materials and keep them handy for future reference.

NOTE: Not all features (and drawings) discussed in this owner's manual will necessarily match those found with your television set. This is normal and does not require you contacting your dealer or requesting service.

WARNING: TO PREVENT FIRE OR SHOCK HAZARD DO NOT EXPOSE THIS UNIT TO RAIN OR EXCESSIVE MOISTURE.

INTEGRATED PRODUCT DESIGN

DPTV/NTSC/MONITOR

The Marantz HD6400W Digital Projection Television (DPTV) represents an advanced first step concept in integrated digital products. Designed for discrete and cross-over system functionality the HD6400W will support traditional NTSC Television standards, receive all certified FCC defined ATSC digital transmission formats, as well as perform PC Monitor Display capability.

Although future plans allow for the two television broadcast systems to coexist for a number of years, the eagerly awaited transition from analog (NTSC) to digital (ATSC) high-definition television has begun.

The Marantz HD6400W DPTV is uniquely positioned to operate within both current and future video signal formats. The HD6400W will provide the largest of viewing windows into an unprecedented era of high-definition picture resolutions, digital surround sound playback, and access to a variety of entertainment and interactive services.

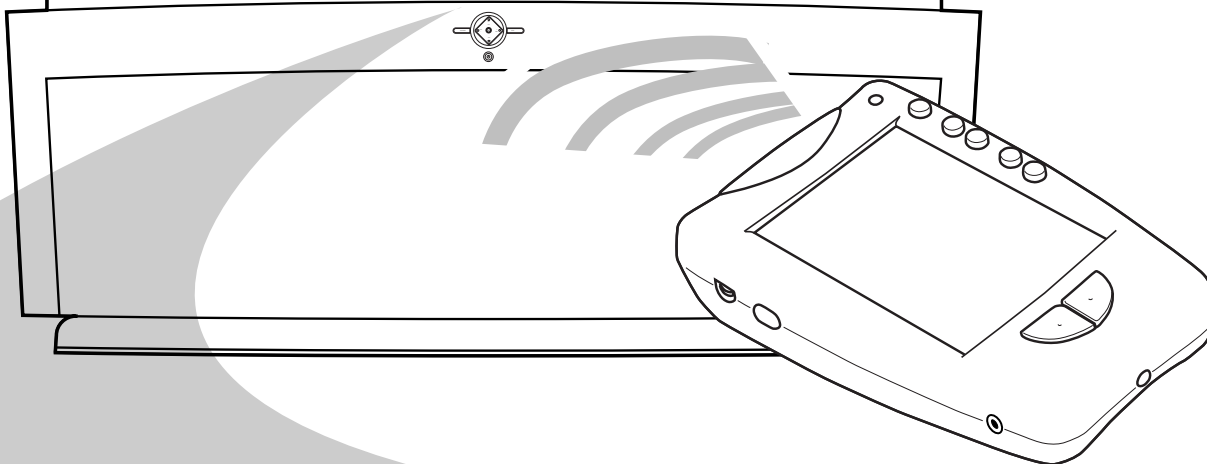
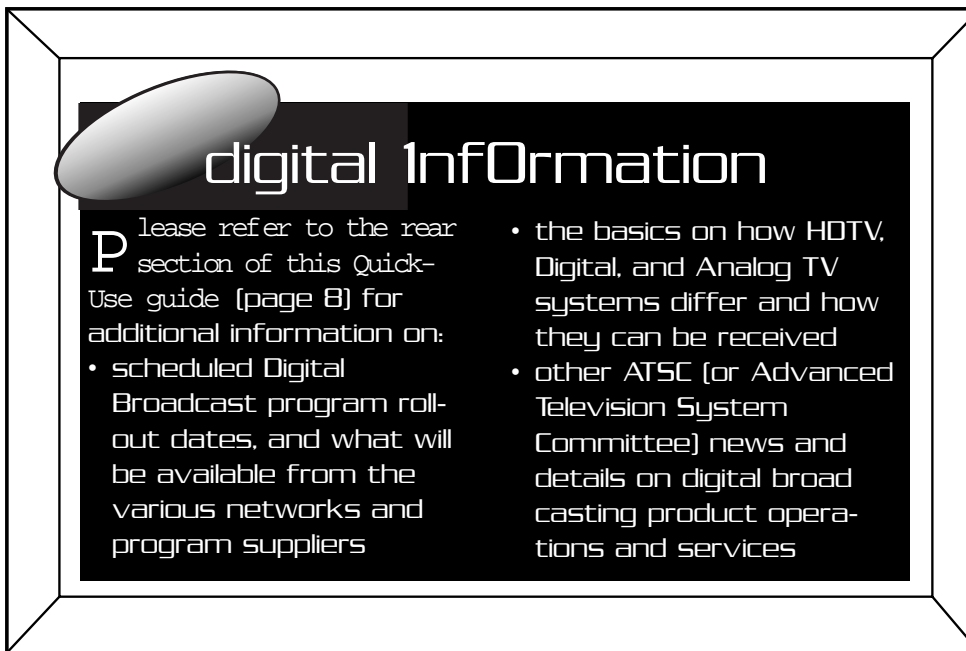

INTEGRATED FEATURES

- **64-Inch Rear Projection Television Screen**
- **Audio Inputs** - Stereo and 6-channel Dolby Digital
- **Subwoofer** - for low frequency bass surround sound
- **Display formats** - normal (overscan), letterbox, or underscan
- **Clock/Sleep Timer** - set in NTSC analog system operational in ATSC as well.
- **Pronto Remote** - set for both NTSC and ATSC select feature operations

PRONTO REMOTE FEATURES

- **Liquid Crystal Display** - with large backlit touchscreen for direct button entry and key feature access
- **Learn Capability** - to learn and operate other infrared remote control product codes
- **Customize** - built-in device templates for total product control
- **Macro** - editable programming for frequently used button sequences

DIGITAL (ATSC) FEATURES

- **ATSC Formats** - decodes all ATSC digital system requirements as specified by FCC
- **ATSC Broadcasts** - tunes terrestrial signal transmissions of major and sub-channel digital programming
- **PSIP Data** - receives and processes signal data for Program System Information Protocol to display channel and program information
- **Video Display** - 1920 x 1080i resolution capability (4x3 ATSC video formats linearly stretched to fill 16:9 display)
- **DTV Closed Captioning**
- **Dolby Digital Audio** - for playback of 6-channel Dolby Digital audio material
- **Alternate Audio** - plays additional audio tracks if available with ATSC programming
- **Freeze Video** - holds video action while audio continues (with time-out feature to prevent possible screen burn)
- **Autoprogram** - for valid digital channels (with means of adding/deleting specific stations from channel map)

ANALOG (NTSC) FEATURES

- **NTSC** - reception of terrestrial broadcast NTSC signals
- **Audio/Video Inputs** - composite Video or S-Video input connections with accompanying Left/Right 2-channel audio
- **Autoprogramming** - for easy automatic selection of favorite area stations
- **Closed Captioning** - to view program dialogue or voice conversation as on-screen text.
- **Channel Labels** - individual channel call-letter/number editable titles

MONITOR FEATURES

- **Video Inputs:** VGA and HD
- **Audio Inputs:** stereo and 6-channel Dolby Digital
- **Display formats:** normal (overscan), letterbox, or underscan

DPTV DESCRIPTION OF CONTROLS AND OPERATION

DPTV

BEGIN

1 Press the **POWER** button to turn the DPTV ON. (Green Power Light will display behind the ON button.)

2 Press the **VOLUME (+) UP** or **VOLUME (-) DOWN** button to adjust the sound level.

3 Press the **CHANNEL UP** or **CHANNEL DOWN (▼)** button to select the desired TV channels.

STOP

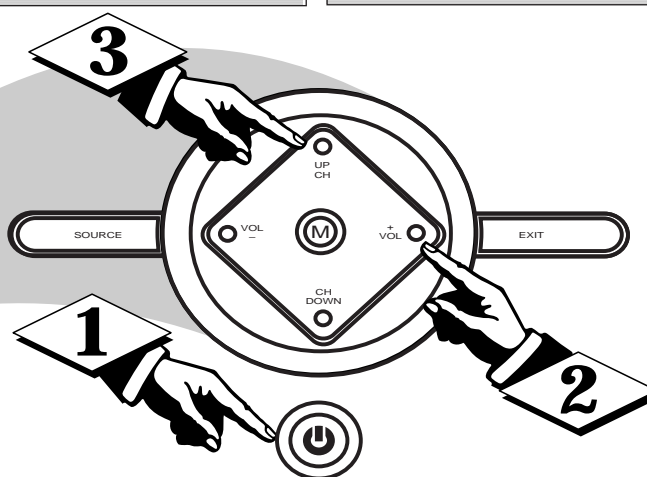
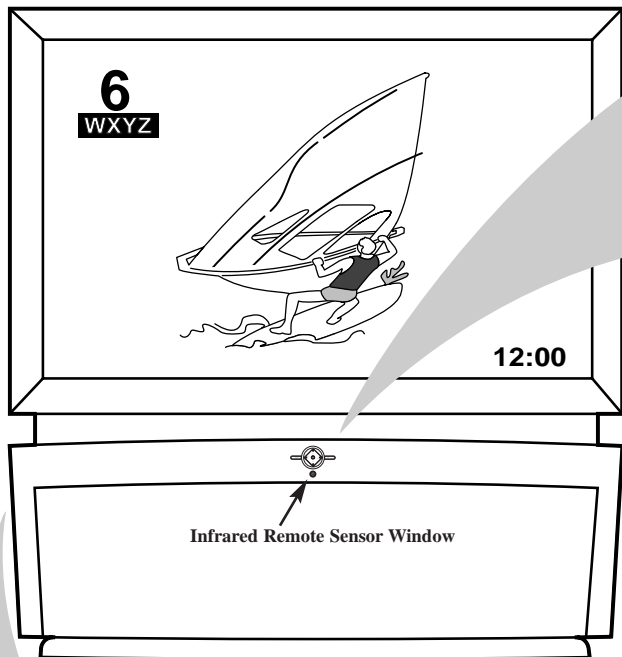

DPTV LOCAL KEYBOARD FUNCTIONS

- **Source** - Press to cycle through the DPTV available inputs (ATSC, NTSC tuners and all external inputs.)
- **Menu (M)** - Press to display the on-screen control system for the selected system. (See the ATSC, NTSC, & Monitor sections for details on the use and navigation of the menus.)
- **CH Up/Down** - With a select Menu system displayed, press to move through the list of control features.
- **VOL Up/Down** - With a select Menu system control displayed, press to adjust the on-screen feature.
- **Exit** - Press to display a Status screen for the selected Menu system, or clear the screen following Menu feature adjustments.

digital Information

Digital Television (DTV) will be available to consumers by over-the-air broadcasts in select city markets beginning in the fall of 1998. Homeowners can use Indoor and Outdoor Antennas to receive the new transmissions, but like previous NTSC Analog programming reception can be effected by the type and quality of the antenna, and the terrain interference typical to certain areas. See page 8 for DTV rollout plans, dates, and schedules.

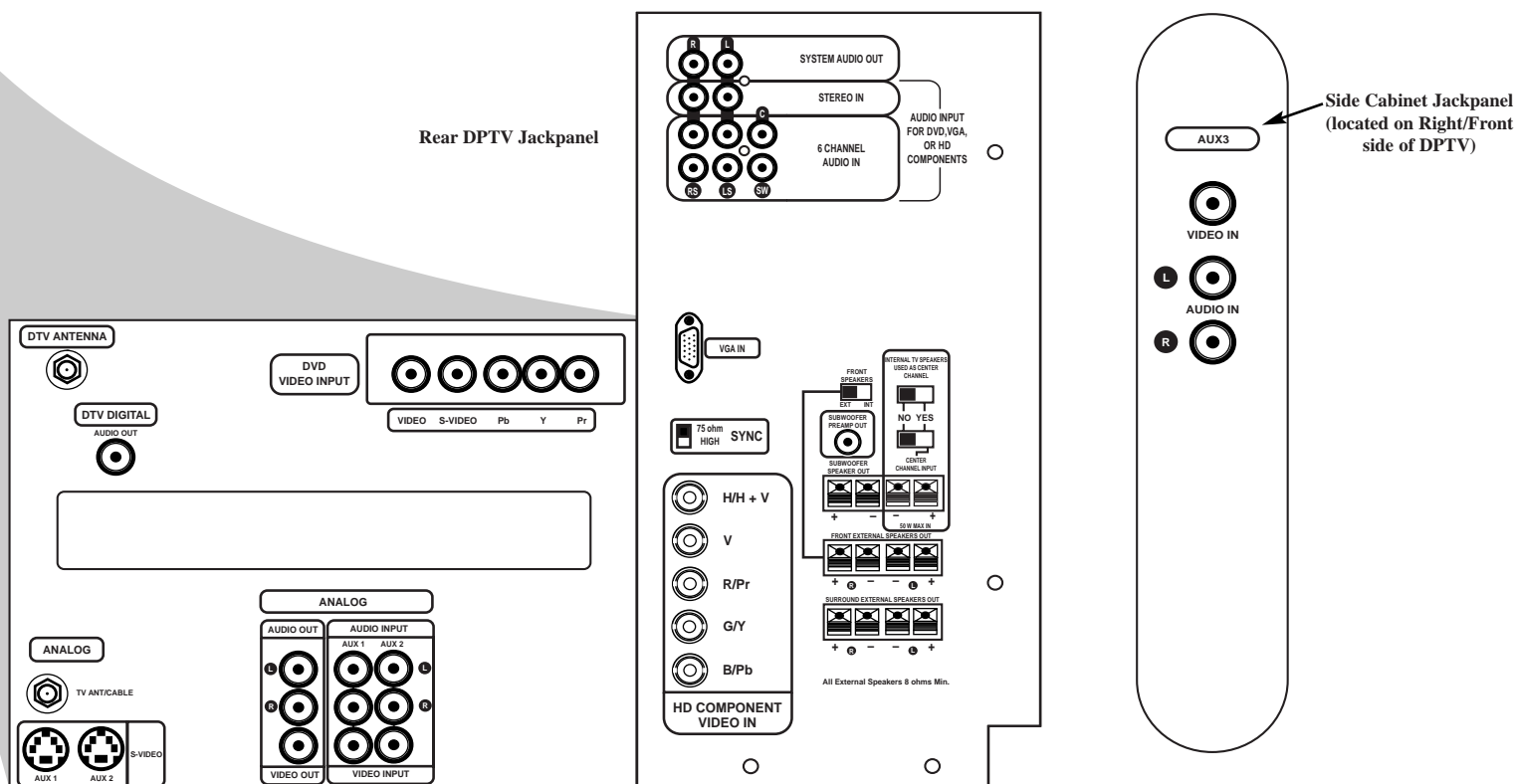

Antenna/Cable Inputs (ATSC/NTSC)

- The DPTV can receive broadcasts from two antenna sources. Connect an ATSC antenna to the DTV Antenna jack, and a NTSC antenna, or cable TV signal, to the TV Antenna/Cable jack.

DVD Video Inputs

- Multiple DVD signal connectors (Component-Y/Pb/Pr; S-Video; or Composite) to be used for a variety of DVD playback options. The DVD Inputs work in conjunction with the DVD Stereo In audio jacks for sound playback.

Audio/Video Inputs (NTSC)

- Three groups of NTSC Auxiliary Audio/Video Inputs can be selected through the EXT INPUT button on the remote, or the SOURCE button on the local keyboard.
- **AUX1** - includes S-Video, CVBS Video, and accompanying (Right)/(Left) channel audio inputs. Note: The AUX1 and AUX2 S-Video inputs work in conjunction with the AUX1 and AUX2 audio jacks for sound playback.
- **AUX2** - identical in operation to the AUX1 S-Video, CVBS Video, (Right)/(Left) Audio Inputs.
- **AUX3** - located on the right-side of the front of the DPTV. Jacks include CVBS Video and (Right)/(Left) Audio inputs.

A/V Inputs Monitor

- Two sets of A/V jacks direct external source signals to the DPTV monitor:
- **VGA IN** - to connect a standard VGA (Video Graphics Array) source for display.
- **HD VIDEO IN** - to input digital video from an external source such as a computer. Input jacks include BNC connectors for R/Pr, G/Y, B/Pb, and H/H+ V signals.
- **SYNC Switch** - related to the HD Video inputs to allow for synchronization switching between 75Ohm and High, depending on the level of the digital source used.

- **STEREO IN** - jacks for (Right)/(Left) 2-channel stereo sound to the DPTV speakers.
- **6-CHANNEL AUDIO IN** - to connect Right, Left, Center, Right Surround (RS), Left Surround (LS), and Subwoofer (SW) audio channels from an external Dolby Digital device. The playback of 6-channel audio is also dependent upon the configuration and adjustment of other jackpanel (and ATSC Speaker Menu) switches and controls.

Audio Speaker Switches/Connectors

- The DPTV is capable of a variety of audio speaker configurations and connections for sending six channel audio to internal and external speakers, as well as receiving external supplied source material for playback.
- **FRONT SPEAKERS Switch** - to set the output of the DPTV's front (R)/(L)channel audio. INT(ernal) sends (Right)/(Left) audio through the DPTV's built-in (R)/(L) front speaker system. EXT(ernal) routes the (R)/(L) channel audio to the FRONT EXTERNAL SPEAKERS OUT terminals on the rear of the DPTV.
- **FRONT EXTERNAL SPEAKERS OUT Terminals** - for the playback of the DPTV's front (Right/Left) channel audio to external speakers (if connected). Note: These speaker terminals are only active when the FRONT SPEAKERS switch is set to EXT(ernal).
- **SURROUND EXTERNAL SPEAKERS OUT Terminals** - to send the Surround Right (SR) and Surround Left (SL) channel audio to external speakers.
- **SUBWOOFER PREAMP OUT Jack** - to send the Subwoofer audio channel (at line level) to an external powered Subwoofer speaker.
- **SUBWOOFER SPEAKER OUT Terminals** - to send an amplified Subwoofer channel audio to an external non-powered Subwoofer speaker.
- **INTERNAL TV SPEAKERS USED AS CENTER CHANNEL Switch** - used (in tandem with the Center Channel Input switch - see next control description) to set

the DPTV's built-in speaker system. Place the switch to the YES position to use the DPTV for Center Channel audio playback (as connected and supplied from an external Dolby Digital capable Amplifier source.) Place the switch to the NO position to retain full DPTV internal speaker system audio (with active Surround External Speaker Out and Subwoofer Speaker Out terminal operation.)

Note: When the INTERNAL TV SPEAKERS and CENTER CHANNEL INPUT switches are placed in the YES position no audio will be heard through the DPTV speaker system (unless a Dolby Digital capable Amplifier's Center Channel Output terminal is connected and active through the DPTV'S CENTER CHANNEL INPUT terminals.)

- **CENTER CHANNEL INPUT Switch** - to control the playback of the DPTV's built-in speaker system for either Center Channel audio (place switch to YES position when connected to an external Dolby Digital capable Amplifier's Center Channel Output terminal); or for full speaker DPTV system audio (place switch to NO in tandem with the Internal TV Speakers switch, see information listed above.)

Audio/Video Outputs

- Three sets of audio output connectors and one video output connector are on the rear of the DPTV.
- **SYSTEM AUDIO OUT** - jacks send the DPTV system audio (ATSC, NTSC, and Monitor) to an external amplifier. The DPTV outputs a 2-channel (Left/Right) stereo audio signal.
- **TV VIDEO OUT** - CVBS video connector, matched with a set of (Right/Left) Audio Outputs, used to send NTSC video to an external source (such as a VCR, etc.)
- **DTV DIGITAL AUDIO OUT** - RCA connector which routes the audio from the ATSC module to an external amplifier/decoder that accepts a SPDIF (Sony-Philips Digital Interface Format) input source.

LCD REMOTE DESCRIPTION OF CONTROLS AND OPERATION

LCD REMOTE

INTELLIGENT REMOTE

Your remote is a LCD touchscreen universal, learn remote that combines flexibility of use with maximum adaptability. Set to automatically work with your Marantz HD6400W DPTV and all its integrated Menu system features, the remote also has preset "Device" operations for a variety of Audio and Video accessory products (such as VCR, DVD, CD, Tape, etc.)

Although the remote's preprogrammed operating codes (RC5/6) were set to work with Marantz and Philips branded products, other manufacturer's equipment can easily be controlled through the remote's "Learn" mode capability. Even the remote's keypress buttons and Device select list can be customized or rearranged to better match the order and commands for your specific in-home electronics.

The remote can also memorize select key button sequences in order to automate, or "short-cut", a feature function selection or process. Once created and placed in memory the recorded "macros" will execute the desired commands to the various components in order to complete, for example, a VCR movie playback on the DPTV or other similar procedure.

Due to the amount of optional components available within the remote's Device Reference and Learn Code Lists, please refer to the separate full-use Remote Control Owner's Manual for complete details on its functions and operations.

BEGIN

1 To install the four supplied AA batteries: Slide the battery cover off the back of the remote.

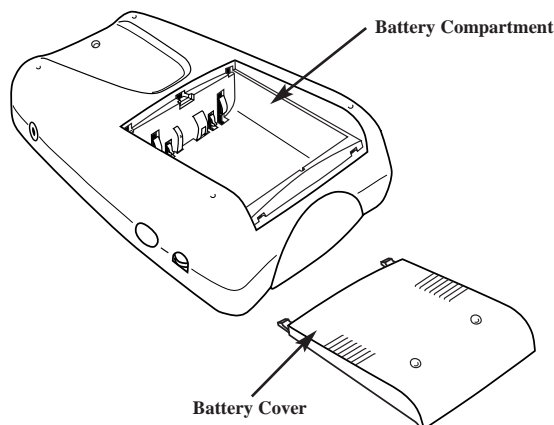

- Battery Life Note -

- Use only AA alkaline or lithium batteries for best results.
- Never mix worn and fresh batteries.
- When battery power is running low a Low Battery icon blinks at the top of the remote LCD display.
- Certain features may continue to operate when battery power is low, but you won't be able to use the remote's learn or customizing features.

2 Insert (4-AA) batteries into the battery compartment. Be sure the (+) and (-) ends of the batteries line up correctly (inside of case is marked.)

3 Reattach the battery cover when completed. The remote should now be ready for use.

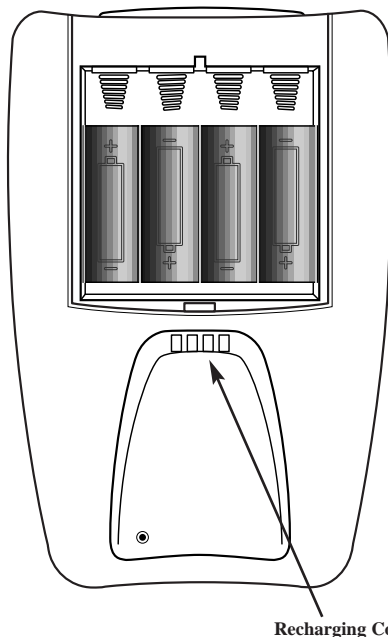

BATTERY RECHARGING

An optional recharging dock and rechargeable battery pack are also available for the remote.

A light on the front of the Battery Dock will indicate when the batteries are fully charged. Depending upon the condition of the battery pack a complete recharge could take 2-3 hours.

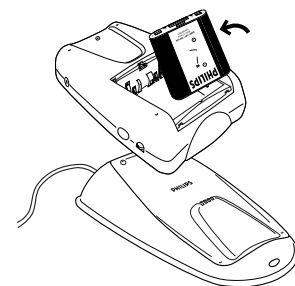

CONTROLS

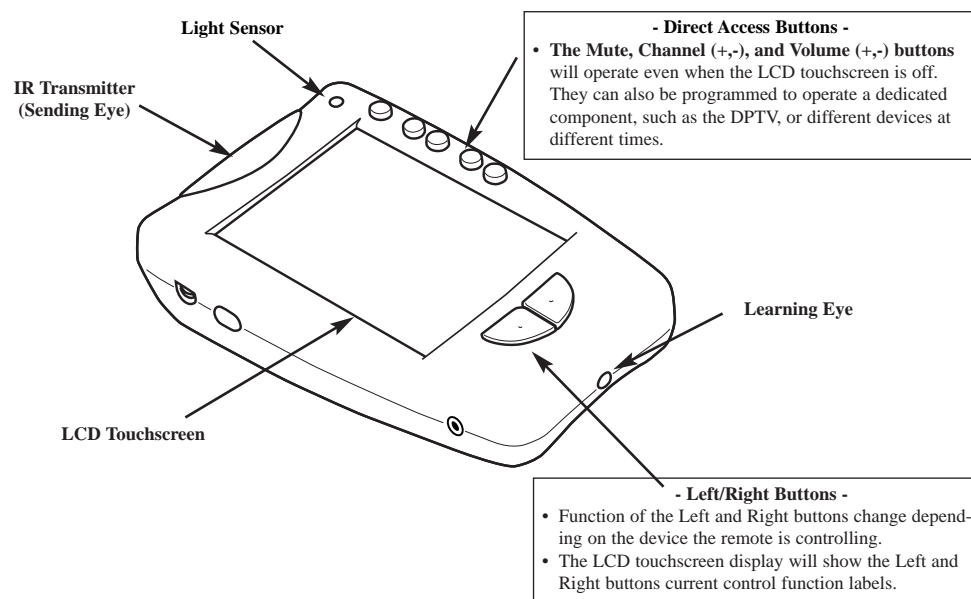

OPERATIONS

BEGIN

1 To turn the remote display screen ON, touch the screen with your finger, then let go.

Pressing the Backlight button (on the left side of the remote) also turns the display ON.

Turn the Contrast dial (on the left side of the remote) to adjust the screen's brightness.

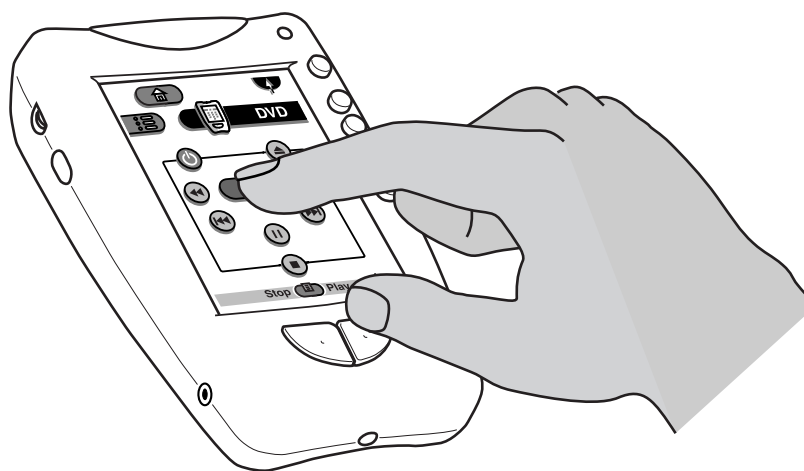

TOUCHSCREEN USE/CARE

- Tap the touchscreen gently when using the remote. Never use force.
- Do not use pens, or any sharp object to tap the screen. You might damage the surface.
- Keep the touchscreen dry. Wipe off any spills immediately. Never immerse the remote in water or any liquid.
- Do not drop the remote on hard surfaces (or drop anything on the LCD touchscreen itself.)
- Do not expose the remote to extreme temperatures.
- Clean the touchscreen with a soft cloth (dampened slightly if needed.) Never use abrasives or cleaning solutions.

2 The remote will display the last device screen used (or the Home screen for all of the devices the remote is set to operate.)

Press the Home button at any time to return to the remote's components menu list.

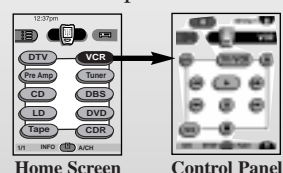

Press the button for the desired device to display a control panel screen for the device.

3 A Device menu can also be used to select components from a currently opened control screen.

Press the Device tab on the touchscreen and a Device list will appear. Just tap the name of the device you want to operate.

You can also scroll the Device list by pressing the Arrow button to move down or up the list.

4 Press a button on the control panel to send a remote command to the selected "active" device.

Use the scroll arrows to move to the next (or previous) page of controls. The touchscreen will display the current control screen's page number, and the total number of pages available for the device (1/8; 2/8; etc.)

5 The remote is ready to send device commands when the remote icon is shown (at the center top of the touchscreen display.)

If another mode label is covering the remote icon, such as DEL or LEARN, the USE mode will need to be reselected.

Tap the Mode button on the touchscreen, and reselect the USE mode to return the remote to its normal operating mode.

DIGITAL (ATSC) MENU CONTROL OPERATIONS

ATSC MENUS

DPTV CONTROLS

Although the visual presentation and display for each of the three independent on-screen Menu systems (ATSC, NTSC, Monitor) differ to help identify which mode the DPTV is in, the overall highlight/selection/ and adjustment operations for each of the Menus will be consistent, or have the same on-screen "feel."

Use the remote's touchscreen "DTV" device menu (page 3/3), or the DPTV's local keyboard, to access and select controls within each of the three DPTV Menu systems.

BEGIN

1 With the remote's DTV device touchscreen selected, press the "DTV" command button (located on the lower right of the remote's case - see illustration) to select the ATSC on screen feature Menu controls for the DPTV.

You can also press the SOURCE button on the DPTV's local keyboard to select the ATSC Menu mode.

2 Press the Scroll Arrows on the remote's touchscreen to select the DTV Menu (page 3/3) cursor screen to operate the DPTV's Main Menu. Then press the "menu" or "ok" button on the touchscreen to display the DTV Main Menu.

If using the DPTV's local keyboard, press the M(enu) button to display the DTV MAIN MENU.

3 Press the Up/Down ▲▼ Arrows on the remote touchscreen to highlight items within the DTV Main Menu features' list. Press the "menu" (or "ok" button) on the touchscreen to select the specific highlighted Main Menu feature.

If using the DPTV's local keyboard, press the CH(annel) UP/DOWN buttons to highlight the Main Menu features. Then press the M(enu) button to select the highlighted feature.

4 Press the Left/Right ◀▶ direction Arrows on the remote to adjust the selected on-screen feature control.

If using the DPTV's local keyboard, press the the VOL(ume) +,- buttons to adjust the feature.

5 Press the "exit" button on the remote (or the DPTV's local keyboard) to clear the screen after an adjustment.

The screen can also be cleared by selecting the Main Menu's "Exit" item and pressing the MENU (M) button. Waiting about a minute, without a button press, will also remove the MENU from the screen.

STOP

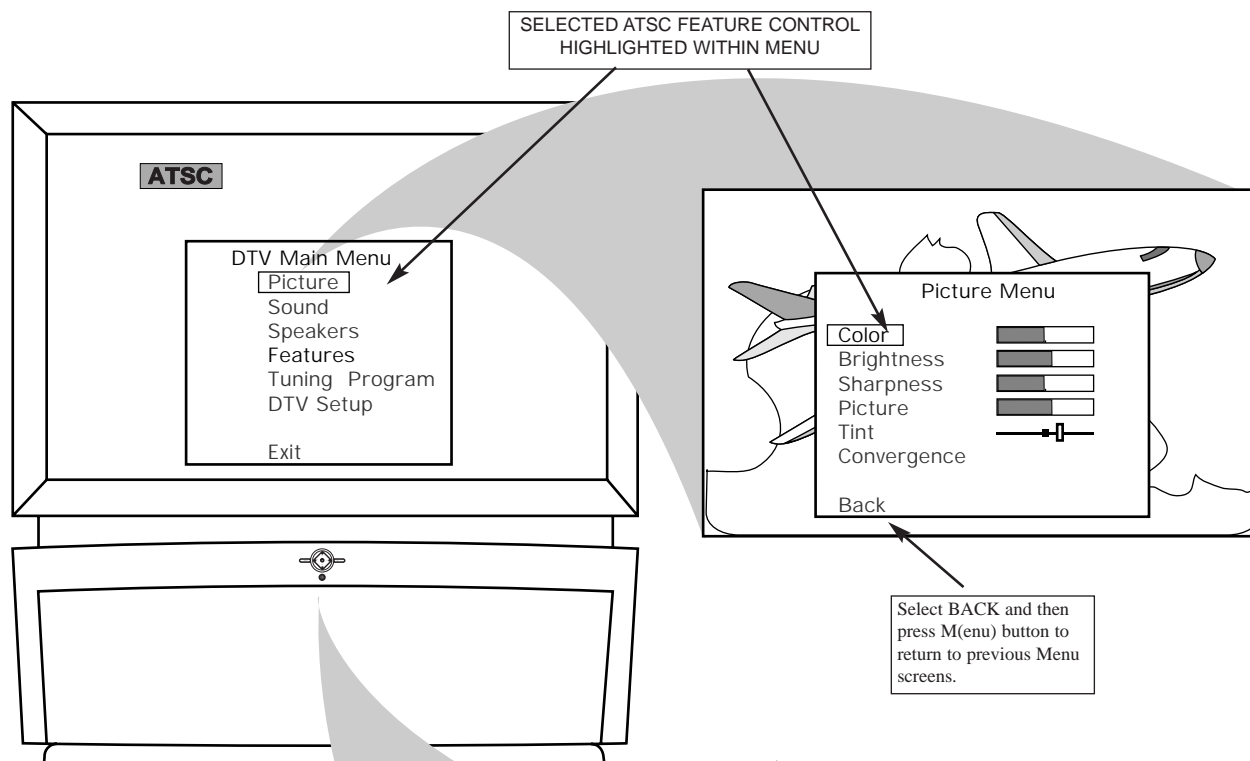

ON THE DPTV

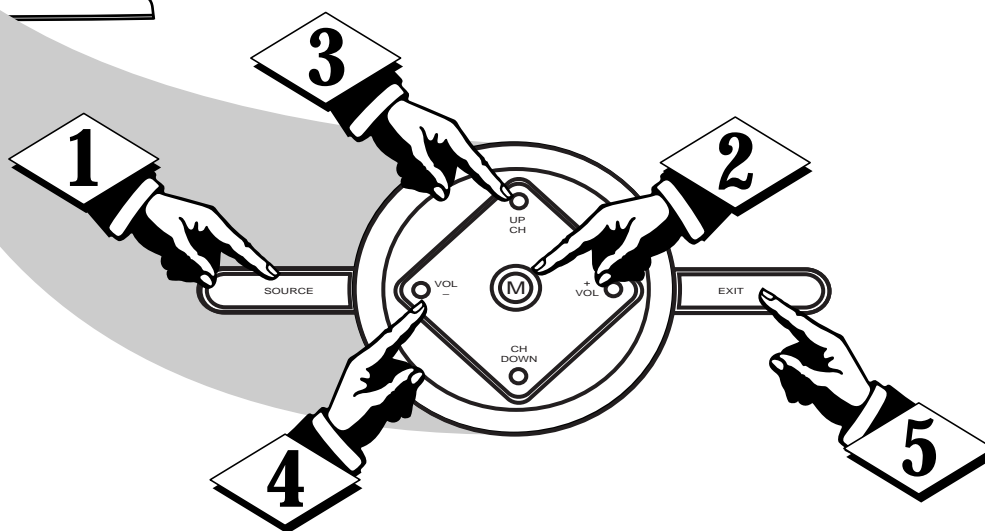

ON THE REMOTE

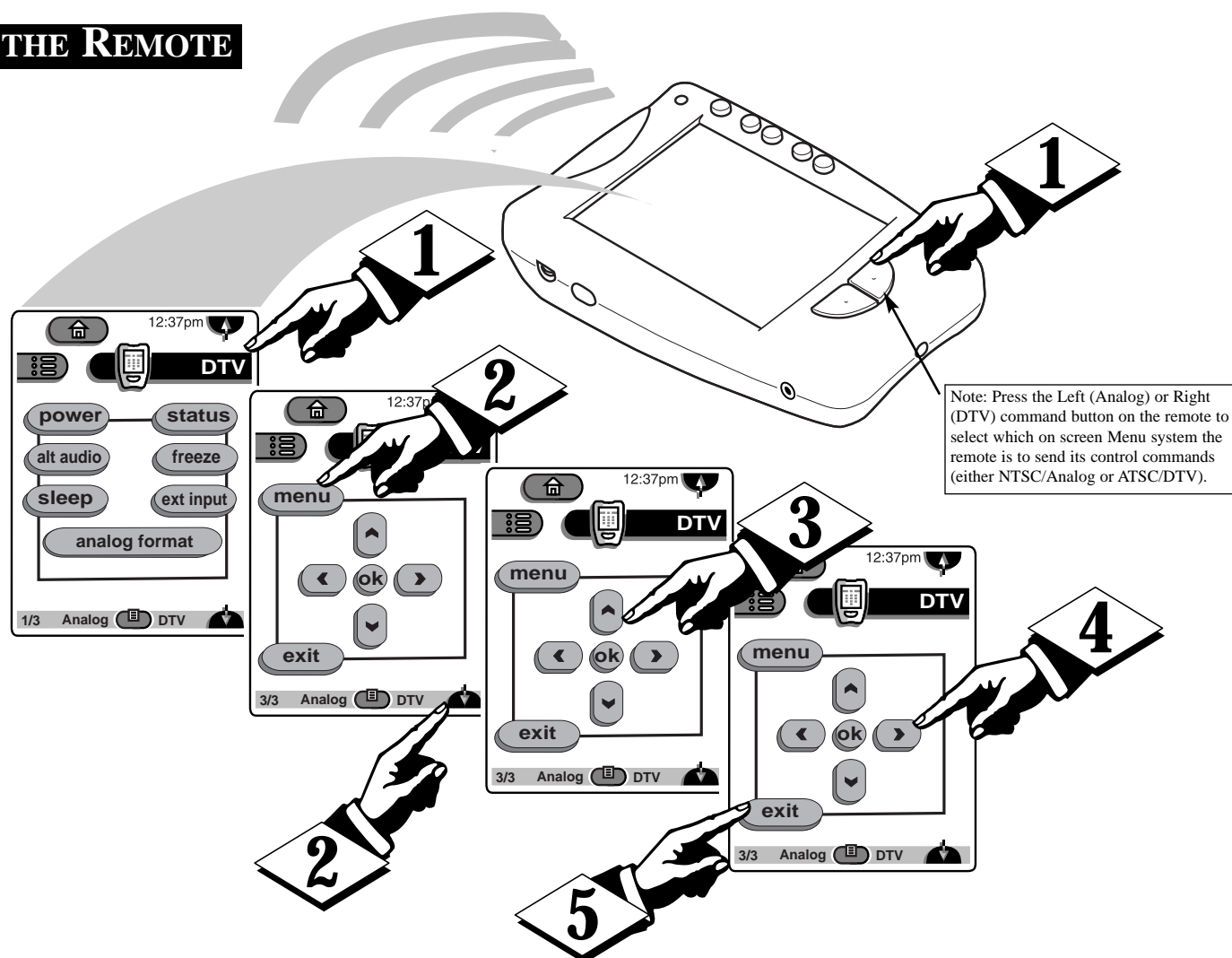

ADDITIONAL REMOTE DPTV FUNCTIONS

- ALTERNATE AUDIO** - Press to cycle through any audio language tracks available with a current DTV program. If alternate audio is found, the DPTV will play the selected alternate soundtrack and display its language as an on-screen indicator.
- SLEEP** - Press to set the amount of time before the DPTV will automatically turn itself OFF (15 minute - 2 hour settings).
- DTV FREEZE** - Press to freeze current TV action on the DPTV screen. Press the Freeze button again (or wait approximately one minute without a button press) to return the DPTV to live action. Audio will continue to play while the picture is frozen. A freeze picture indicator will appear on-screen.
- EXTERNAL INPUT** - Press to cycle through the Analog NTSC Auxiliary Inputs (AUX1/2/3); and other possible External Monitor connection inputs (EXT HD, DVD VGA, etc.). The DPTV will display the name of the selected input in the corner of the DPTV screen.
- ANALOG FORMAT** - Press to select the Analog NTSC tuning mode on the DPTV. Remote transmitter commands will be directed to the "normal" analog TV menu system control features.

DIGITAL (ATSC) MENU CONTROL OPERATIONS (CONTINUED)

digital Information

ATSC MENUS

AUTOPROGRAM CHANNELS

The "DTV Setup" menu automatically takes care of some of the digital channel scan memory functions for the DPTV. Once connected to receive local digital broadcast transmissions, available area stations can be quickly added into the DPTV's channel memory for programmed channel selection or access.

SUBCHANNEL SELECTIONS

Note: The new standards (for bandwidth and signal compression) employed with digital ATSC broadcasting make it possible to receive multiple program channels under a single "major" channel number. For example, under a traditional channel "6" broadcast program number you might be able to find as many as four or more additional programs available for selection. These so called "sub-channels" might carry a "06.01, 06.02, 06.03, etc." type station number designation and could be selected by pressing a four digit remote control direct-access channel number entry.

The multiplication and diversity of sub-channel programming is contingent upon the decisions of broadcasters and how the space allocated for high-definition television signals might be used. The content and information available with sub-channels will be an evolving digital issue which could experience redirection on a number of multicasting information technology pathways. For example, the "squeezing" of numerous Standard Definition digital channels (SDTV) into signal bandwidths could be used rather than dedicating the total signal spectrum to true High Definition (HDTV) broadcasts that would rival the picture resolution and quality of film or cinema.

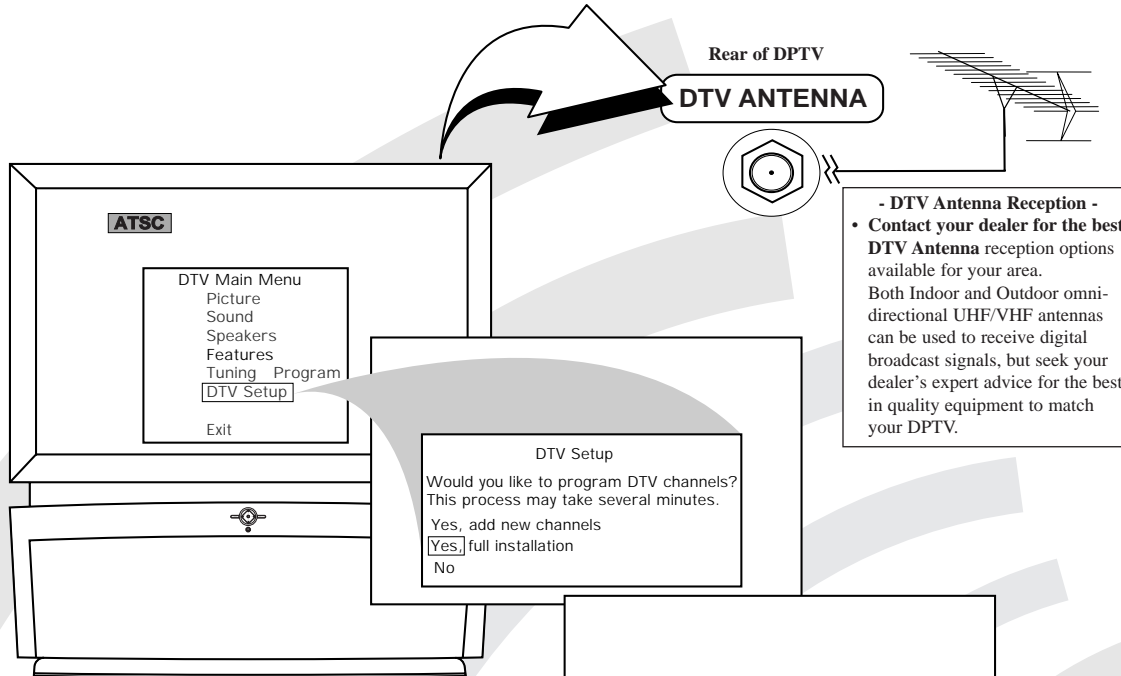

Initial Digital broadcasts will be available through Over-the-Air signal, Direct-Satellite transmission, and on some Cable TV operator systems. Route the DTV signal connection to the DTV Antenna plug on the rear of the DPTV. See page 8 for further details.

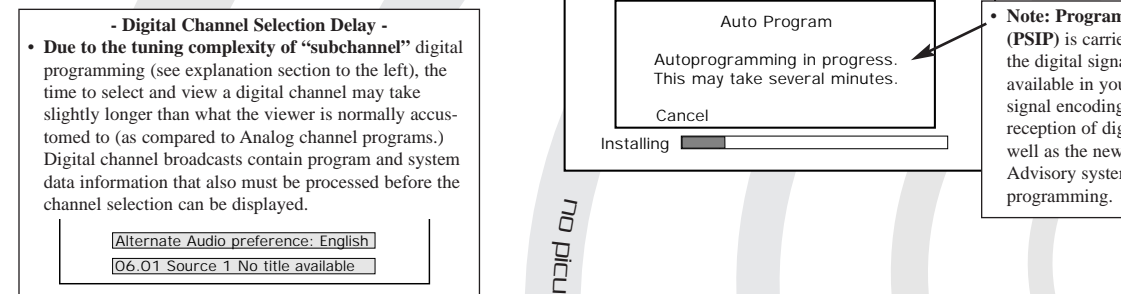

- Digital Channel Selection Delay -
 • Due to the tuning complexity of "subchannel" digital programming (see explanation section to the left), the time to select and view a digital channel may take slightly longer than what the viewer is normally accustomed to (as compared to Analog channel programs.) Digital channel broadcasts contain program and system data information that also must be processed before the channel selection can be displayed.

Note: Program and System Info or (PSIP) is carried automatically within the digital signal for program broadcasts available in your area. PSIP contains the signal encoding necessary for the reception of digital audio processing, as well as the new Parental Content Advisory system for movies and TV programming.

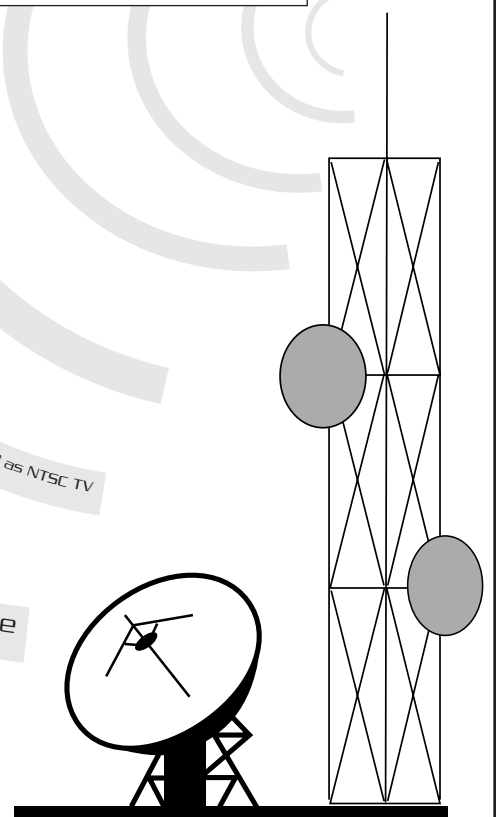
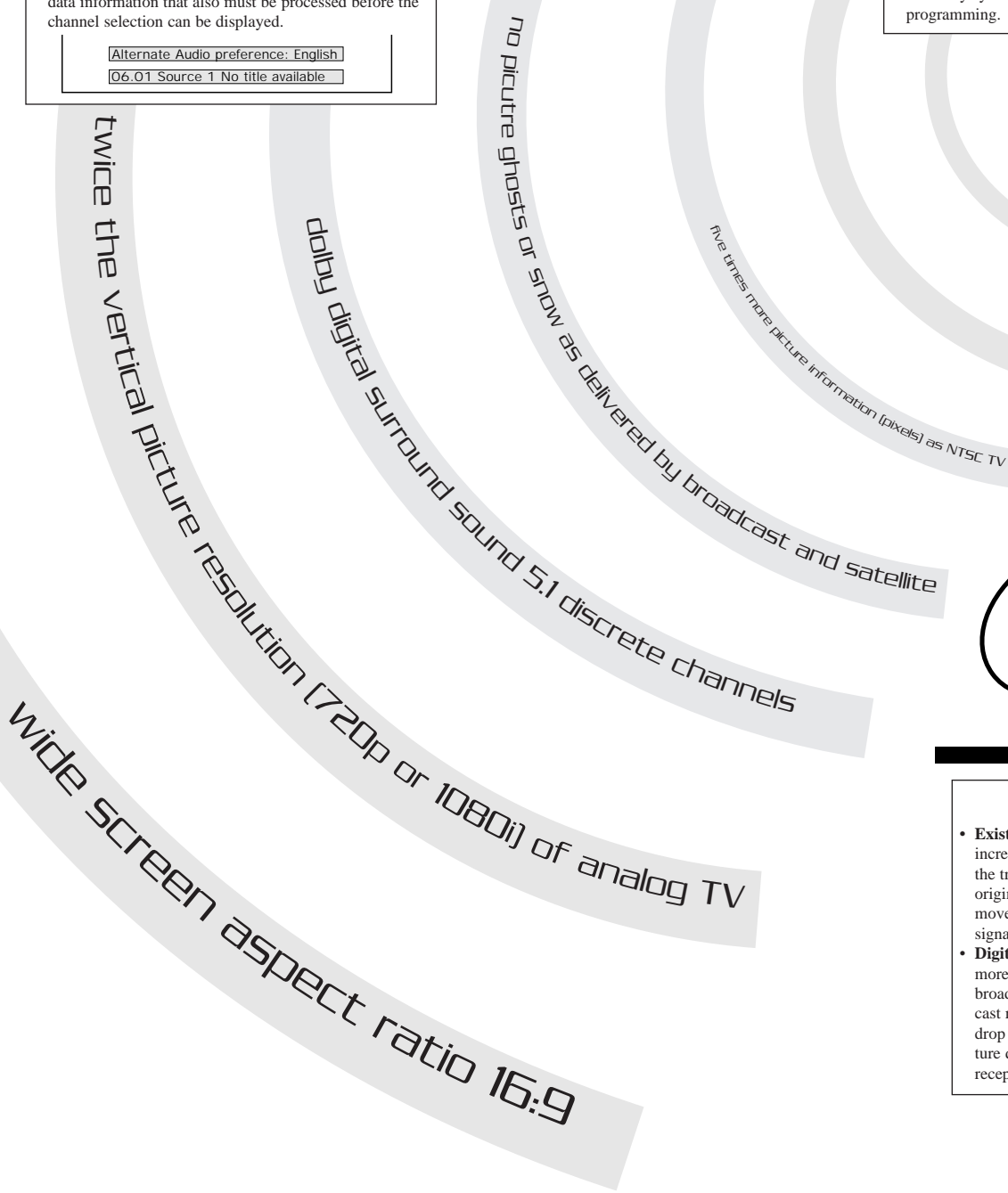

Analog vs. Digital Antenna Signals (Strength and Direction Traits)

- Existing analog broadcast signals experience increasing picture snow/ghosts/or interference as the transmitted signal travels further from the original broadcasting tower. The farther out you move the reception point, the more the broadcast signal degrades or grows weaker.
- Digital broadcast reception maintains a clearer, more interference free picture throughout its broadcast range, but once the limit of its broadcast range is reached the picture will quickly drop from the screen (rather than a slower picture quality degrade as is the case with analog reception.)

PICTURE MENU FUNCTIONS

- Select to adjust separate Color and Picture controls on the DPTV. When the slide bar scales are centered, control settings are at normal mid-range levels.
- Use the Convergence control to line up the Red and Blue light paths for the DPTV screen.

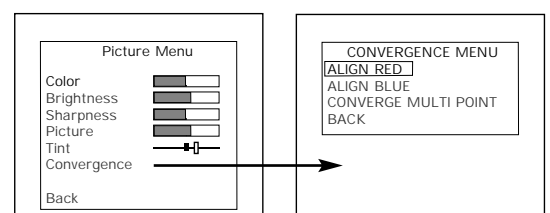

SPEAKER MENU FUNCTIONS

- Select the various Speaker Menu controls to setup the configuration of the DPTV's six speaker system for Dolby Digital audio playback. Each trim control can be adjusted to match test tone levels, or customized to match current listening room arrangements.

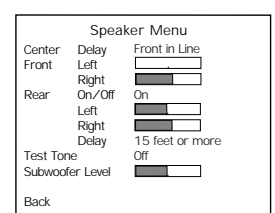

SOUND MENU FUNCTIONS

- Select Surround Mode to direct and process Dolby Digital audio through the DPTV 6-speaker sound system. (Stereo redirects Left and Right channel stereo playback without Dolby ProLogic processing.)
- Use Auto Volume to control the variable amount of peak compression for Dolby Digital audio available with ATSC broadcasts. This can make for even, more consistent sound between program changes, etc.

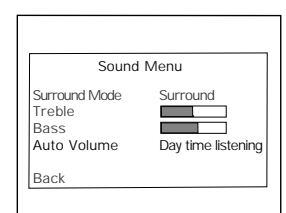

FEATURES MENU FUNCTIONS

- Select and adjust for Closed Caption mode settings and display options.
- Use the Add/Delete Channel control to add (or delete) digital channel numbers from the DPTV's program scan memory.
- Use Parental Control to block out or censor unwanted channels.

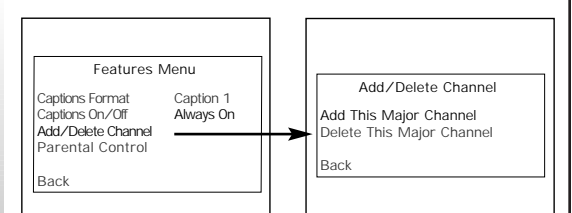

ANALOG (NTSC) MENU CONTROL OPERATIONS

NTSC MENUS

ANALOG TV CONTROLS

Operating in the same manner as other DPTV integrated product Menus (ATSC, Monitor), highlight the desired on-screen control and press the M(enu) button on the remote, or DPTV local keyboard, to select the Analog NTSC feature for use.

BEGIN

1 Press the "Analog" command button (located on the lower left of the remote's case - see illustration on this page) to select the NTSC on screen Menu controls for the DPTV.

You can also press the SOURCE button on the DPTV's local keyboard to select the NTSC Menu mode.

2 Press the direction Arrows on the remote's TV touchscreen (page 3/3) to highlight items within the Main Menu features' list. Press the "menu" (or ok) button on the touchscreen to select the specific highlighted control.

If using the DPTV's local keyboard, press the CH(annel) UP/DOWN and VOL(ume) +/- buttons to highlight the Main Menu features. Then press the M(enu) button to select the highlighted feature.

3 Press the Left/Right Arrows on the remote to adjust the selected on-screen feature control. If using the DPTV's local keyboard, press the VOL(ume) +/- buttons to adjust the feature.

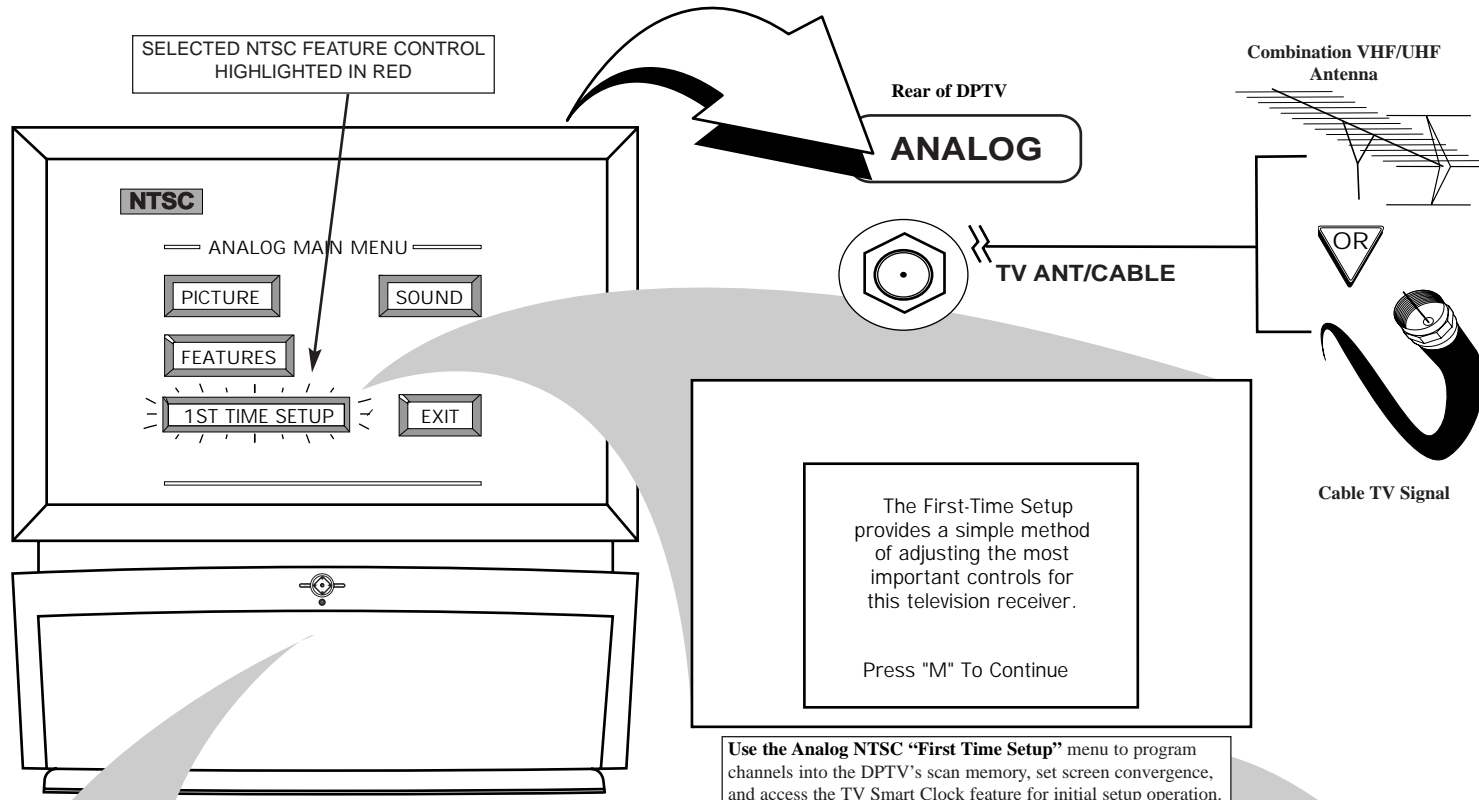

Use the Analog NTSC "First Time Setup" menu to program channels into the DPTV's scan memory, set screen convergence, and access the TV Smart Clock feature for initial setup operation.

- Use EXIT on the remote touchscreen, or the DPTV local keyboard, to remove the Menu from the screen.
- You can also select and highlight EXIT within the Menu, then press the Menu button to drop on-screen controls, or wait approximately a minute and the screen will automatically time out and disappear.

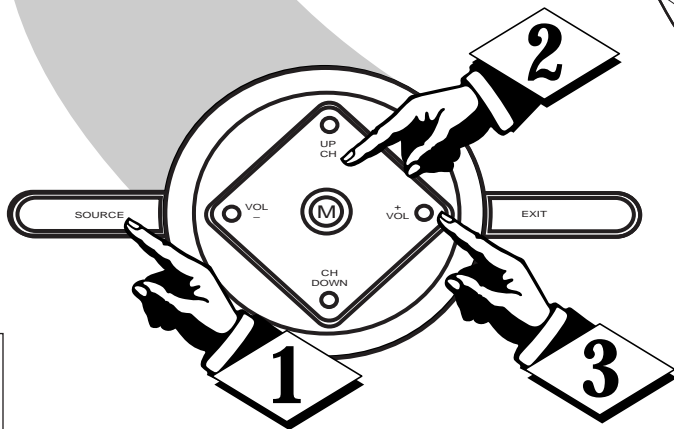

Note: Press the Left (Analog) or Right (DTV) command button on the remote to select which on screen Menu system the remote is to send its control commands (either NTSC/Analog or ATSC/DTV).

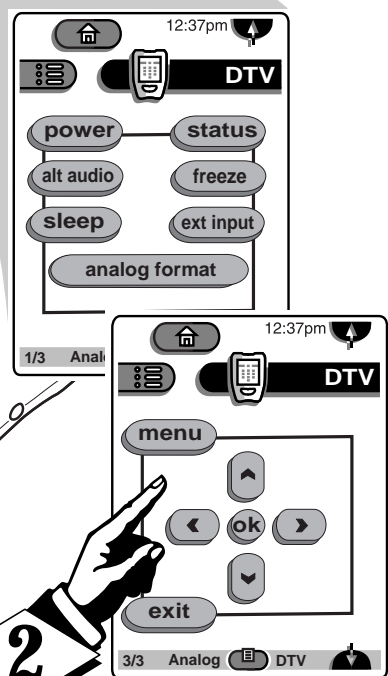

PICTURE MENU FUNCTIONS

- Select to adjust separate Color and Picture controls within the Analog NTSC Menu. When the slide bar scales are centered, control settings are at normal mid-range levels.
- Use the Convergence control to line up the Red and Blue light paths for the DPTV screen.

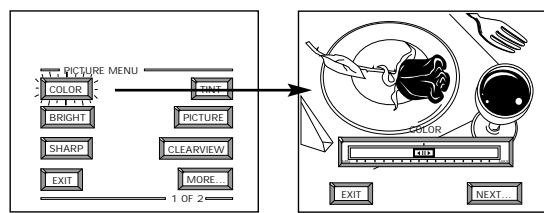

Color and Picture Menu Control Adjustments

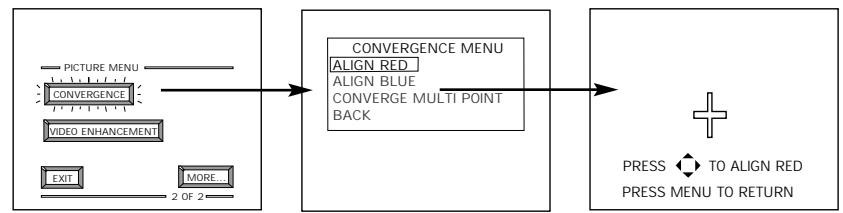

Convergence Menu Control Adjustments

FEATURES MENU FUNCTIONS

- Note: Certain Feature Menu tasks, such as Program Channel Memory and Cable Tuning, are automatically completed for you as part of "First Time Setup."
- Select and adjust Closed Captions for Caption and Text mode display options.
- Use the Add/Delete Channel control to add, or drop, individual channel numbers from the program scan memory.
- Use Smart Picture to set individual "preferences" in the setup and use of select control features.

- Channel Labels enable the viewer to choose from a "preset" list of station callouts (or manually create specific station titles.)
- Display Format resets the DPTV's screen for various aspect ratio and image format styles.
- Channel Display controls the size and style of the DPTV's on-screen status displays.
- Use Parental Control to block out or censor unwanted channels.
- Set Clock to enter the current time for the DPTV's clock.

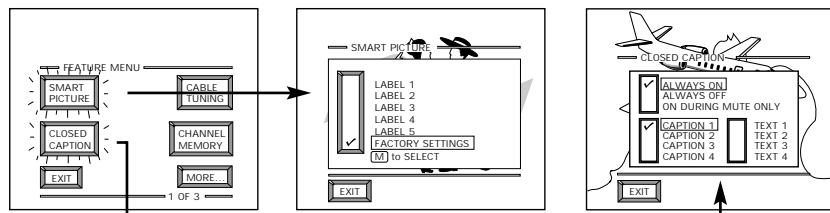

Feature Menu Control Adjustments

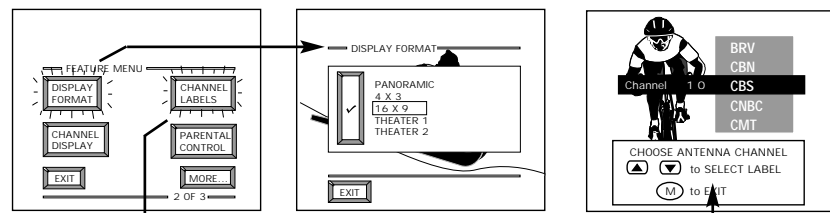

SOUND MENU FUNCTIONS

- Use the Bass, Treble, and Balance controls to adjust the sound playback for the NTSC mode audio.
- Select Stereo to switch between monaural (mono) and two channel stereo broadcast material.
- Use SAP (Second Audio Program) to receive separate audio channel simulcast program information (when available.)

- Use the AVL (Automatic Volume Limiter) control to preset the desired volume level for program viewing. This can maintain a consistent sound transition between program changes, commercial breaks, etc.
- Use the Display Volume control to see DPTV's volume levels on the DPTV screen.

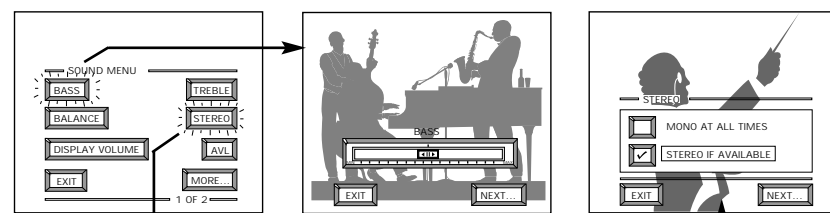

Sound Menu Control Adjustments

MONITOR MENU CONTROL OPERATIONS

MONITOR MENUS

MONITOR DISPLAY CONTROLS

Operating in the same manner as other DPTV integrated product Menus (ATSC, NTSC), highlight the desired on-screen control and press the M(enu) button on the remote, or DPTV local keyboard, to select the Monitor display feature for use.

BEGIN

1 Press the "ext input" button on the remote's TV touchscreen, or SOURCE on the local keyboard, to place the DPTV in the desired monitor display mode (VGA, SVGA, EXTHD).

2 Press the Up/Down ▲▼ Arrows on the remote's TV touchscreen (page 4/4) to highlight items within the Monitor controls' list. Press the "menu" (or "M" button) on the touchscreen to select the specific highlighted feature.

If using the DPTV's local keyboard, press the CH(annel) UP/DOWN buttons to highlight the Monitor Menu features. Then press the M(enu) button to select the highlighted feature.

3 Press the Left/Right ◀▶ Arrows on the remote to adjust the selected on-screen feature control.

If using the DPTV's local keyboard, press the VOL(ume) +,- buttons to adjust the feature.

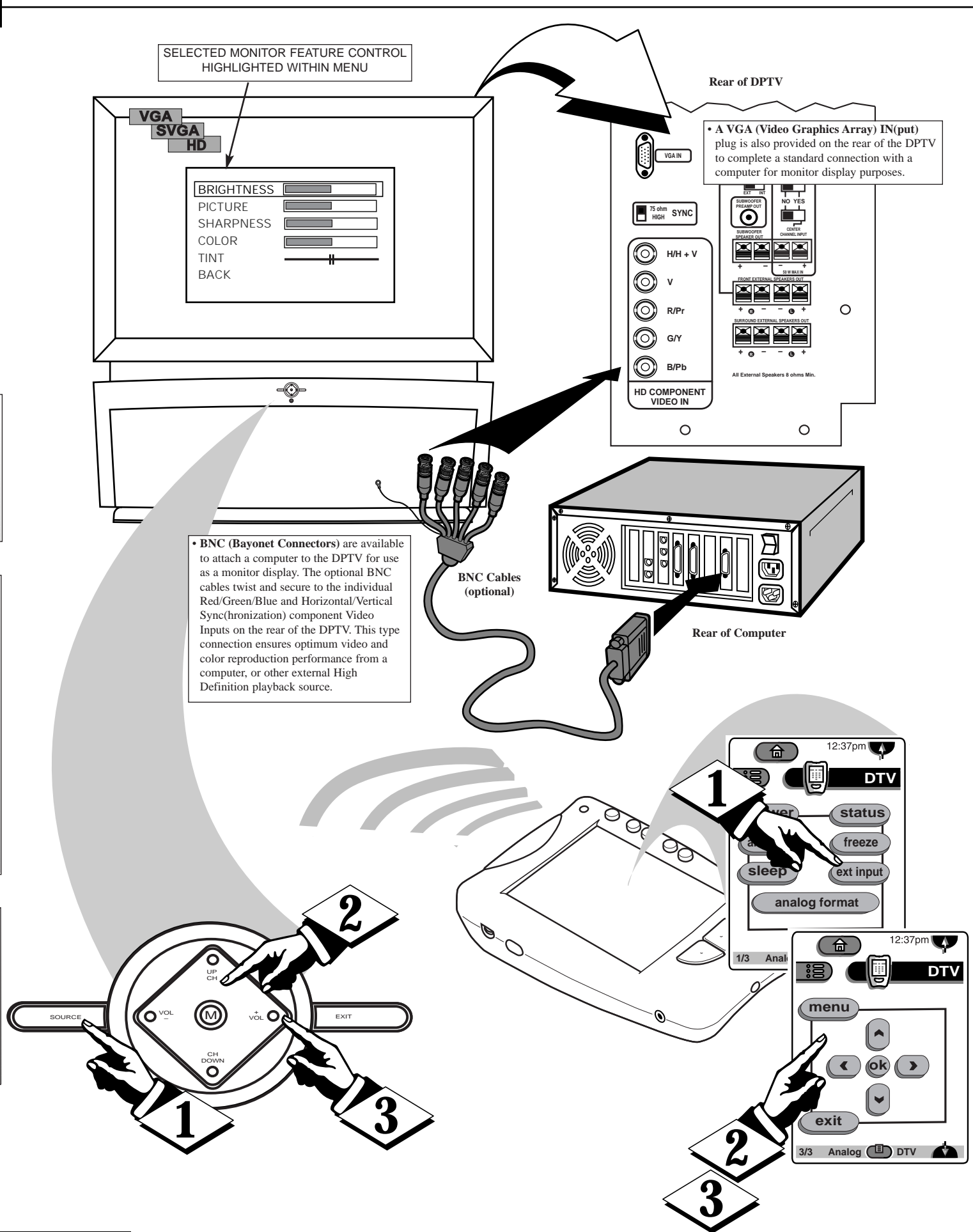

MONITOR MENU FUNCTIONS

- Note: Certain barscale Monitor Feature Menu adjustments** (such as Brightness, Picture, etc.) will display separate control panel screens for individual settings. Re-press the Menu button (on the remote or local keyboard) to return the DPTV to the Monitor Feature Menu when control adjustments are complete.
- Use the Brightness** and other Monitor picture features (such as Picture, Sharpness, etc.) to adjust overall DPTV screen intensity for optimum light/dark screen areas and shading details.
- Turn the Volume Bar** control ON to display the volume level settings for external audio sourced material on the DPTV screen.
- Select the Bass/Treble/Balance** controls to adjust low/high frequency sound and speaker balance for external input audio source material played through the DPTV's audio system.
- Use the Display Mode and Format** controls to set the DPTV for the type of external monitor input source (VGA, SVGA, HD); and the DPTV's display screen format for use (PC, Normal).

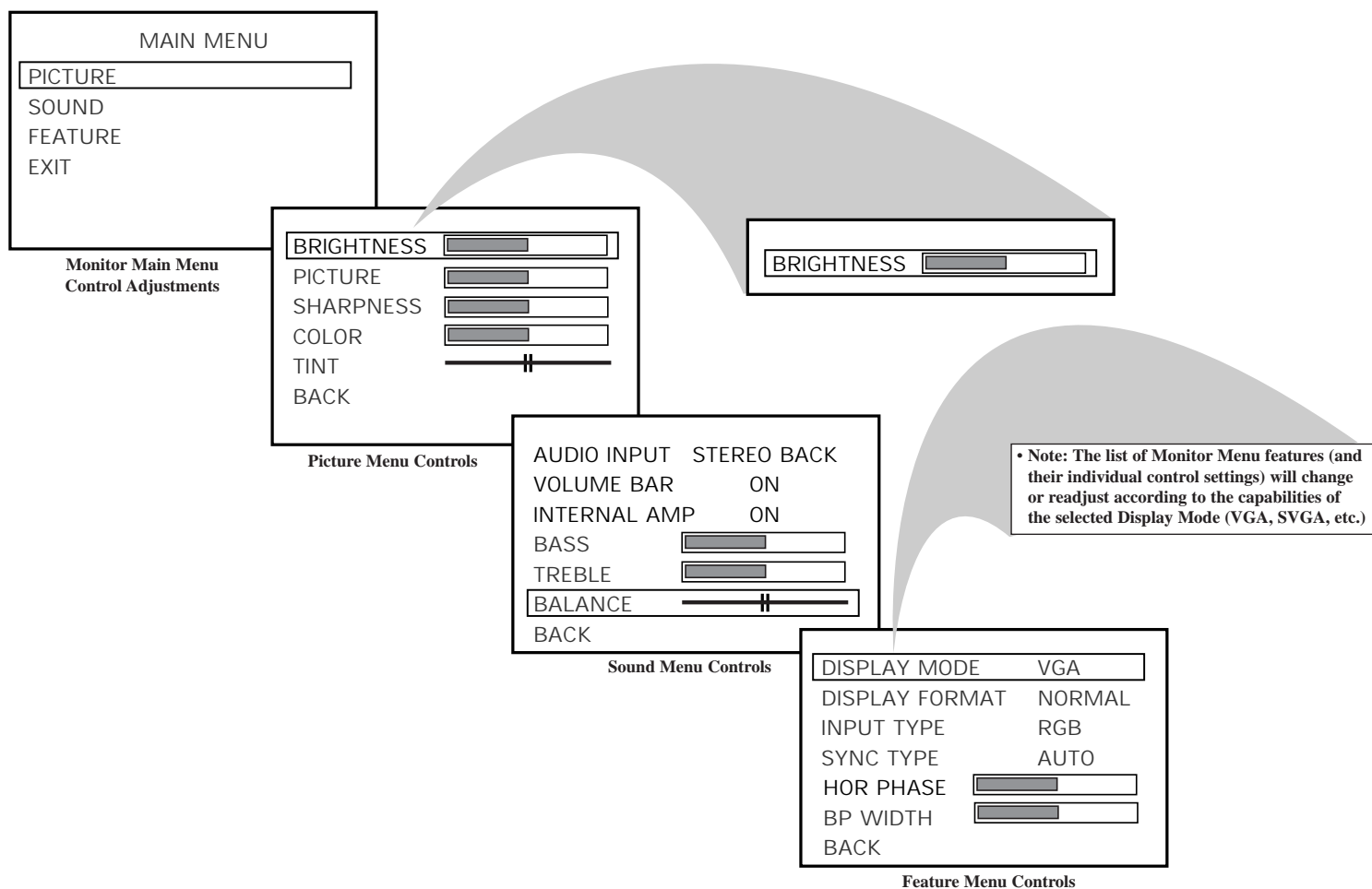

DIGITAL TV ROLLOUT - TIME/TERMS/TECHNOLOGY

DTV TIMETABLE

PROGRAM AVAILABILITY

The switch to digital programming won't happen overnight, but broadcasters are beginning the task of converting equipment and production capabilities to meet the FCC's rules for signal format and launch of digital TV. The first step for the networks will be to supply their affiliates with one satellite program feed for continuing NTSC service (at least thru the year 2006), and another feed for a single channel of HDTV (or SDTV format channels). ABC, CBS, NBC, and PBS networks are all attempting to broadcast some HDTV programming beginning in the fall of 1998 (see the digital Information section to the right for specific plans and details), but much in the way of new digital broadcast tower construction, site zoning and other conversion issues will need to be resolved in order for the broadcasts to begin in earnest. In the beginning local stations can offer different programming on their allotted digital channel space, but as time passes the percentage of NTSC programs that must be converted to digital "simulcast" broadcasts will increase (in order to meet specified conversion schedule requirements.)

The Cable TV industry's standard for the use and carrying of digital broadcasts, which has a different frequency modulation than cable signals, is unresolved (as of the date of this publication.) Although some cable operators promise that digital set-top boxes or decoders will be available to pass HDTV signals to digital TV sets, no official "must carry" design for the interfacing of cable TV programming and digital TV technologies has been agreed upon. Even without firm program launch dates or established guidelines, digital cable decoder equipment and program offering plans (by such cable program providers as HBO, Turner Broadcasting and the Discovery Channel) are all underway for the interconnection of cable TV and the arrival of HDTV. It may not have immediate solutions at the outset, but market and industry demands should speed cable operators to provide for the HDTV signal to make it into the cable supplied home. Direct-broadcast satellite system (DSS) providers (such as DirecTV, Unity Motion, Dish Network, etc.) have also announced plans to deliver HDTV to its customer base in the spring of 1999. DSS subscribers will likely need upgraded dish and satellite receiver designed equipment to complete their digital reception package, but a number of providers are working on both off-the-air signal and direct satellite feed solutions.

TOP TEN MARKETS (30% OF US HOUSEHOLDS)

- By November 1998 (Voluntary)
- By May 1999 (Mandatory)
- Atlanta
- Boston
- Chicago
- Dallas
- Detroit
- Los Angeles
- New York
- Philadelphia
- San Francisco
- Washington, D.C.

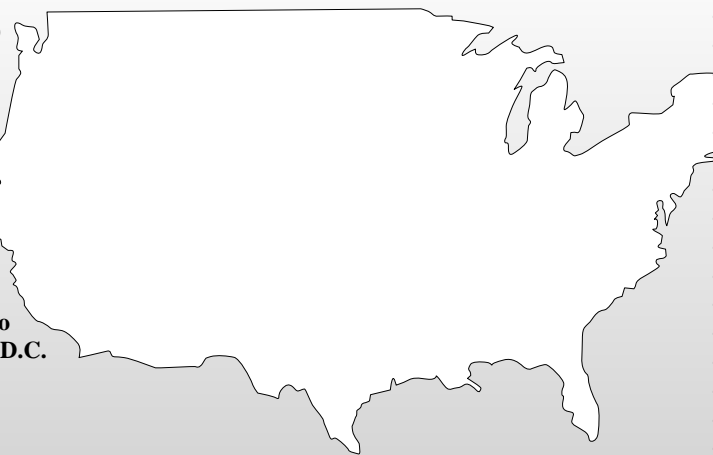

all other commercial stations must construct digital facilities by May 2002 (non-commercial stations, such as PBS affiliates, by May 2003)

- Baltimore
- Charlotte
- Cincinnati
- Cleveland
- Denver
- Hartford/New Haven
- Houston
- Indianapolis
- Miami
- Minneapolis/St. Paul
- Orlando
- Phoenix
- Pittsburgh
- Portland
- Raleigh/Durham
- Sacramento
- San Diego
- Seattle/Tacoma
- St. Louis
- Tampa/St. Petersburg
- By November 1999

TOP 30 MARKETS (50% OF US HOUSEHOLDS)

ADVANCED TELEVISION SYSTEM COMMITTEE FORMATS

Digital Television Format/Name	Horizontal Resolution (pixels across screen width)	Vertical Resolution (Viewable Scan Lines)	Screen/Image Aspect Ratio (width to height)	Total Pixels (transmitted per video frame*)
High Definition TV HDTV 1080P/1080I	1920	1080	16:9	2,073,600
High Definition TV HDTV 720P/720I	1280	720	16:9	921,600
Standard Definition TV (SDTV) 525P/525I	704	480	4:3 - 16:9	337,920
Standard Definition TV (SDTV)	640	480	4:3	307,200

FOR BROADCAST

*60 frames per second (fps) for live video; 24 and 30 fps for material produced in film.

Digital Television (DTV) is the umbrella term used to describe the new digital television system adopted by the FCC. DTV is an open standard with few specific format rules for the implementation of HDTV/SDTV and a host of potential data broadcast applications. Although there are certain guidelines for frequency/bit rates/transmission power/etc. the FCC has taken the position that the marketplace should decide or dictate what formats will best serve the public.

- **High Definition Television (HDTV)** is approximately twice the vertical and horizontal resolution of today's NTSC TV. Because of the extra width (16:9) format of HDTV the picture contains about five times as much information (or pixels) as conventional TV. HDTV also includes 5.1 channels of Dolby Digital surround sound to be broadcast through two front speakers; one center speaker; two rear back speakers; and a separate bass channel or subwoofer signal.
- HDTV refers to the product/system with the following minimum performance specs:
 - Resolution: vertical display resolution of 720P, 1080I, or higher
 - Aspect Ratio: capable of displaying 16:9 format images at the minimum resolution levels
 - Audio: receives, reproduces, and/or outputs Dolby digital audio
 - Receiver: receives all ATSC (Table 3) formats
- **Standard Definition Television (SDTV)** offers about the same picture resolution as today's NTSC TV, but the picture quality is improved because of the lack of snow and ghosts that accompany normal NTSC over-the-air broadcasting. Multiple channels are possible with SDTV since the 6-MHz signal space allotted for digital broadcasts can be used for other types of less data filled format programming.
- Standard Definition Television (SDTV) refers to the product/system with the following performance attributes:
 - Resolution: display resolution lower than that of HDTV
 - Aspect Ratio: none specified
 - Audio: produces useable audio
 - Receiver: receives all ATSC (Table 3) formats and produces a useable picture

PROGRESSIVE (P) AND INTERLACE (I) SCAN

- **Progressive and Interlace** refer to the method in which the video from a picture telecast is scanned or displayed on the TV screen.
- **Interlace** scans or paints half the vertical lines for the picture on the screen every 1/60 of a second. Then the rest of the picture is filled in between the lines of the first half on a followup scan. The speed of this process is so fast that it appears to the eye as being one complete picture. Due to the amount of information

contained in a 1080-line HD picture, interlace is needed to fit the format into the allotted 6MHz channel space.

- **Progressive** scans or paints the entire video picture one line after another. Used with today's computer monitors this progressive process can eliminate some of the picture artifacts found with interlace scan, but does require a larger bandwidth in order to deliver programs at the same frame rate.

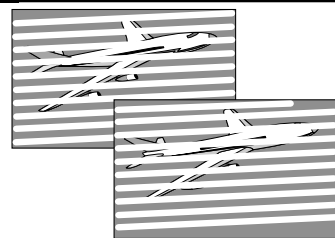

INTERLACE FIELDS

(Separate scans sent every 1/60 of a second)

The interlace scan process was first used with NTSC broadcasts to conserve video bandwidth space. With certain scenes or video material the interlace process can cause image blurring or other visual screen artifacts.

FREQUENTLY ASKED DTV QUESTIONS

Q: What are the goals of DTV?
 A: In the United States the commitment for free and local digital broadcasts is a main standard for the new ATSC system. The reception and interaction of local terrestrial broadcasting for DTV programming is to remain the same regardless of the region or area of the country in which you reside.

Q: How long will the transition to DTV take?

A: The move to digital programming will shift from initial select program offerings; to increased simulcast availability; to the ultimate return of analog NTSC broadcast channels to the federal government in 2006. The NTSC and ATSC systems will coexist for years to come (with possible date extensions provided for the return of NTSC system channels if needed.) Products such as the HD6400W DPTV are uniquely positioned with

operation capability matched for both the NTSC and ATSC systems.

Q: What's in the future for DTV?
 A: Because of the computer, multimedia, and broadcast services involved in setting ATSC and signal compression standards, DTV picture formats can be universally adopted not only for TV broadcasts but also for computer and other interrelated web and network service purposes.

digital Information

While they may differ on the choice of digital formats (1080i, 720p, 480i, etc.) the networks broadcast plans center mainly on select primetime * program viewing. Because of the production techniques and equipment upgrades necessary for digital broadcasts the telecasting of sports or other live events will not become available until audience viewership can justify costs. Some initial network plans for digital broadcasts:

ABC- Wonderful World of Disney (in 720p format); to phase in other HDTV broadcasts later.

CBS- proposed to send five hours of 1080i programming per week

NBC- to begin shooting The Tonight Show with Jay Leno in HDTV beginning in 1999; also plans to show other primetime shows in HDIV

Fox to distribute some portion of its schedule in 720p HDTV.

*Outside of the primetime slot for network digital shows local stations can provide different programming on their digital broadcast channel. They are free to convert current NTSC programming into digital SDIV or even upgrade their signal to true HDTV. ABC, NBC and Fox are advising affiliates to use 480p for the majority of its broadcast day, while CBS recommends its stations use the 480i format.

Free Manuals Download Website

<http://myh66.com>

<http://usermanuals.us>

<http://www.somanuals.com>

<http://www.4manuals.cc>

<http://www.manual-lib.com>

<http://www.404manual.com>

<http://www.luxmanual.com>

<http://aubethermostatmanual.com>

Golf course search by state

<http://golfingnear.com>

Email search by domain

<http://emailbydomain.com>

Auto manuals search

<http://auto.somanuals.com>

TV manuals search

<http://tv.somanuals.com>