

marantz®

Model PM7001 / PM7001 KI User Guide

Integrated Amplifier

ENGLISH

WARRANTY

For warranty information, contact your local Marantz distributor.

RETAIN YOUR PURCHASE RECEIPT

Your purchase receipt is your permanent record of a valuable purchase. It should be kept in a safe place to be referred to as necessary for insurance purposes or when corresponding with Marantz.

IMPORTANT

When seeking warranty service, it is the responsibility of the consumer to establish proof and date of purchase. Your purchase receipt or invoice is adequate for such proof.

FOR U.K. ONLY

This undertaking is in addition to a consumer's statutory rights and does not affect those rights in any way.

FRANÇAIS

GARANTIE

Pour des informations sur la garantie, contacter le distributeur local Marantz.

CONSERVER L'ATTESTATION D'ACHAT

L'attestation d'achat est la preuve permanente d'un achat de valeur. La conserver en lieu sûr pour s'y reporter aux fins d'obtention d'une couverture d'assurance ou dans le cadre de correspondances avec Marantz.

IMPORTANT

Pour l'obtention d'un service couvert par la garantie, il incombe au client d'établir la preuve de l'achat et d'en corroborer la date. Le reçu ou la facture constituent des preuves suffisantes.

DEUTSCH

GARANTIE

Bei Garantiefragen wenden Sie sich bitte an Ihren Marantz-Händler.

HEBEN SIE IHRE QUITTING GUT AUF

Die Quittung dient Ihnen als bleibende Unterlage für Ihren wertvollen Einkauf. Das Aufbewahren der Quittung ist wichtig, da die darin enthaltenen Angaben für Versicherungszwecke oder bei Korrespondenz mit Marantz angeführt werden müssen.

WICHTIG!

Bei Garantiefragen muß der Kunde eine Kaufunterlage mit Kaufdatum vorlegen. Ihren Quittung oder Rechnung ist als Unterlage ausreichend.

NEDERLANDS

GARANTIE

Voor inlichtingen omtrent garantie dient u zich tot uw plaatselijke Marantz.

UW KWITANTIE, KASSABON E.D. BEWAREN

Uw kwitantie, kassabon e.d. vormen uw bewijs van aankoop van een waardevol artikel en dienen op een veilige plaats bewaard te worden voor evt. verwijzing bijv. in verband met verzekering of bij correspondentie met Marantz.

BELANGRIJK

Bij een evt. beroep op de garantie is het de verantwoordelijkheid van de consument een gedateerd bewijs van aankoop te tonen. Uw kassabon of factuur zijn voldoende bewijs.

ESPAÑOL

GARANTIA

Para obtener información acerca de la garantía póngase en contacto con su distribuidor Marantz.

GUARDE SU RECIBO DE COMPRA

Su recibo de compra es su prueba permanente de haber adquirido un aparato de valor. Este recibo deberá guardarlo en un lugar seguro y utilizarlo como referencia cuando tenga que hacer uso del seguro o se ponga en contacto con Marantz.

IMPORTANTE

Quando solicite el servicio otorgado por la garantía el usuario tiene la responsabilidad de demostrar cuando efectuó la compra. En este caso, su recibo de compra será la prueba apropiada.

ITALIANO

GARANZIA

L'apparecchio è coperto da una garanzia di buon funzionamento della durata di un anno, o del periodo previsto dalla legge, a partire dalla data di acquisto comprovata da un documento attestante il nominativo del Rivenditore e la data di vendita. La garanzia sarà prestata con la sostituzione o la riparazione gratuita delle parti difettose.

Non sono coperti da garanzia difetti derivanti da uso improprio, errata installazione, manutenzione effettuata da personale non autorizzato o, comunque, da circostanze che non possano riferirsi a difetti di funzionamento dell'apparecchio. Sono inoltre esclusi dalla garanzia gli interventi inerenti l'installazione e l'allacciamento agli impianti di alimentazione.

Gli apparecchi verranno riparati presso i nostri Centri di Assistenza Autorizzati. Le spese ed i rischi di trasporto sono a carico del cliente.

La casa costruttrice declina ogni responsabilità per danni diretti o indiretti provocati dalla inosservanza delle prescrizioni di installazione, uso e manutenzione dettagliate nel presente manuale o per guasti dovuti ad uso continuato a fini professionali.

SVENSKA

GARANTI

För information om garantin, kontakta Marantz lokagent.

SPAR KVITTOT

Kvittot är ett inköpsbevis på en värdefull vara. Det skall förvaras säkert och hänvisas till vid försäkringsfall eller vidkorrespondens med Marantz.

VIKTIGT

Fö att garantin skall gälla är det kundens sak att framställa bevis och datum om köpet. Kvitto eller faktura är tillräckligt bevis för detta.

CE MARKING

- CE English**
The PM7001 is in conformity with the EMC directive and low-voltage directive.
- CE Français**
Le PM7001 est conforme à la directive EMC et à la directive sur les basses tensions.
- CE Deutsch**
Das Modell PM7001 entspricht den EMC-Richtlinien und den Richtlinien für Niederspannungsgeräte.
- CE Nederlands**
De PM7001 voldoet aan de EMC eisen en de vereisten voor laag-voltage.
- CE Español**
El PM7001 está de acuerdo con las normas EMC y las relacionadas con baja tensión.
- CE Italiano**
Il PM7001 è conforme alle direttive CEE ed a quelle per i bassi voltaggi.
- CE Svenska**
PM7001 är tillverkad i enlighet med EMC direktiven och direktiven för lågvoltstrusning.

English

WARNINGS

- Do not expose the equipment to rain or moisture.
- Do not remove the cover from the equipment.
- Do not insert anything into the equipment through the ventilation holes.
- Do not handle the mains cord with wet hands.
- Do not cover the ventilation with any items such as tablecloths, newspapers, curtains, etc.
- No naked flame sources, such as lighted candles, should be placed on the equipment.
- When disposing of used batteries, please comply with governmental regulations or environmental public instruction's rules that apply in your country or area.
- Make a space of about 0.2 meter around the unit.
- No objects filled with liquids, such as vases, shall be placed on the apparatus.
- When the switch is in the OFF position, the equipment is not completely switched off from MAINS.

Français

AVERTISSEMENTS

- Ne pas exposer l'appareil à la pluie ni à l'humidité.
- Ne pas essayer de retirer le boîtier de l'appareil.
- Ne rien insérer dans l'appareil par les orifices de ventilation.
- Ne pas manipuler le cordon d'alimentation avec les mains mouillées.
- Ne pas recouvrir les ouïes de ventilation avec un objet quelconque comme une nappe, un journal, un rideau, etc.
- Ne placer aucune source de flamme nue, comme une bougie allumée, sur l'appareil.
- Pour mettre au rebut les piles usées, respecter les lois gouvernementales ou les règlements officiels concernant l'environnement qui s'appliquent à votre pays ou région.
- Veiller à ce qu'aucun objet ne soit à moins de 0,2 mètre des côtés de l'appareil.
- Aucun objet rempli de liquide, un vase par exemple, ne doit être placé sur l'appareil.
- Lorsque l'interrupteur est sur la position OFF, l'appareil n'est pas complètement déconnecté du SECTEUR (MAINS).

Deutsch

WARNHINWEISE

- Das Gerät nicht Regen oder Feuchtigkeit aussetzen.
- Die Abdeckung nicht vom Gerät abnehmen.
- Keine Gegenstände durch die Belüftungsschlitze stecken.
- Das Netzkabel nicht mit feuchten oder nassen Händen anfassen.
- Decken Sie die Lüftungsöffnungen nicht mit einem Tischtuch, einer Zeitung, einem Vorhang usw. ab.
- Es dürfen keine Gegenstände mit offener Flamme, wie etwa brennende Kerzen, auf dem Gerät aufgestellt werden.
- Beachten Sie bei der Entsorgung der verbrauchten Batterien alle geltenden lokalen und überregionalen Regelungen.
- Auf allen Geräteseiten muß ein Zwischenraum von ungefähr 0,2 meter vorhanden sein.
- Auf das Gerät dürfen keine mit Flüssigkeiten gefüllte Behälter, wie etwa eine Vase, gestellt werden.
- Wenn der Schalter ausgeschaltet ist (OFF-Position), ist das Gerät nicht vollständig vom Stromnetz (MAINS) abgetrennt.

Nederlands

WAARSCHUWINGEN

- Stel het apparaat niet bloot aan regen of vocht.
- Verwijder de afdekplaat van het apparaat niet.
- Duw niets door de ventilatieopeningen in het apparaat.
- Raak het netsnoer niet met natte handen aan.
- Bedek de ventilatieopeningen niet met enige voorwerpen, zoals tafelkleden, kranten, gordijnen, enz.
- Plaats geen brandende voorwerpen, zoals kaarsen, op het apparaat.
- Volg bij het weggooien van verbruikte batterijen de overheidswetgeving of milieuvoorschriften op die van kracht zijn in het land of de regio waarin u zich bevindt.
- Zorg dat er 0,2 meter vrije ruimte rond het toestel is.
- Plaats geen voorwerpen met een vloeistof erin, zoals een bloemenvaas, op het apparaat.
- Als de schakelaar op OFF staat, is het apparaat niet volledig losgekoppeld van de netspanning (MAINS).

Español

ADVERTENCIAS

- No esponga el equipo a la lluvia ni a la humedad.
- No extraiga la tapa del equipo.
- No introduzca nada en el interior del equipo a través de los orificios de ventilación.
- No maneje el cable de alimentación con las manos mojadas.
- No cubra la ventilación con objetos como manteles, periódicos, cortinas, etc.
- No deben colocarse sobre el equipo elementos con fuego, por ejemplo velas encendidas.
- Cuando se eliminen baterías usadas, deben cumplirse las reglamentaciones oficiales o las normas de protección medioambiental aplicables en su país o en su zona.
- Deje un espacio de unos 0,2 metro alrededor de la unidad.
- No se deben colocar sobre el aparato recipientes que contengan líquidos, como por ejemplo jarrones.
- Cuando el interruptor está en la posición OFF, el equipo no está completamente desconectado de la alimentación MAINS.

Italiano

AVVERTENZE

- Non esporre l'apparecchio alla pioggia o all'umidità.
- Non rimuovere il coperchio dell'apparecchio.
- Non introdurre oggetti all'interno dell'apparecchio attraverso i fori di ventilazione.
- Non toccare il cavo di alimentazione con le mani bagnate.
- Non coprire le fessure di ventilazione con tovaglie, giornali, tende od oggetti analoghi.
- Non posare sull'apparecchio sorgenti di fiamme scoperte quali candele accese.
- Smaltire le pile usate in conformità alle norme governative o disposizioni ambientali vigenti nel proprio paese o zona.
- Lasciare 0,2 metro liberi tutto intorno l'unità.
- Non mettere sull'apparecchiatura alcun contenitore di liquido, come ad esempio dei vasi.
- Quando l'interruttore è nella posizione OFF, l'apparecchiatura non è completamente scollegata da MAINS.

Svenska

VARNINGAR

- Utsätt inte utrustningen för regn eller fukt.
- Ta inte bort utrustningens hölje.
- För inte in föremål i utrustningen genom ventilationshålen.
- Hantera inte nätsladden med våta händer.
- Täck inte för ventilationsöppningarna med några föremål som till exempel bordsdukar, dagstidningar, gardiner e.d.
- Inga föremål med öppen låga, som till exempel tända stearinljus, bör placeras på utrustningen.
- Följ de lagar och miljöskyddsråd som gäller i det land eller område där du bor när du gör dig av med batterier.
- Se till att det finns omkring 0,2 meter fri plats runt omkring enheten.
- Inga objekt som är fyllda med någon vätska, till exempel blomstervaser, bör placeras på apparaten.
- Även om strömbrytaren står i det avstängda läget OFF, så är utrustningen inte helt bortkopplad från det elektriska nätet (MAINS).

CONTENTS

BEFORE USE	1
FEATURES	2
BEFORE MAKING CONNECTIONS	3
WIRING SPEAKER CABLE	3
BI-WIRING CONNECTION	3
CONNECTIONS	4
NAMES AND FUNCTIONS OF PARTS	6
FRONT PANEL	6
REAR PANEL	7
RC4001PM REMOTE CONTROLLER	8
BASIC OPERATION	11
PLAYBACK	11
RECORDING	11
HOW TO USE AND SET FEATURES	12
MAIN IN JACKS	12
REMOTE CONTROL JACKS	13
TROUBLESHOOTING	14
OTHERS	15
SPECIFICATIONS & DIMENSIONAL DRAWINGS	15

A NOTE ABOUT RECYCLING



This product's packaging materials are recyclable and can be reused. This product and the accessories packed together are the applicable product to the WEEE directive except batteries.

Please dispose of any materials in accordance with your local recycling regulations.

When discarding the unit, comply with your local rules or regulations.

Batteries should never be thrown away or incinerated but disposed of in accordance with your local regulations concerning chemical wastes.

BEFORE USE

This section must be read before any connection is made to the mains supply.

■ EQUIPMENT MAINS WORKING SETTING

Your Marantz product has been prepared to comply with the household power and safety requirements that exist in your area.

PM7001 can be powered by 230V AC only.

■ COPYRIGHT

Recording and playback of any material may require consent. For further information refer to the following:

- Copyright Act 1956
- Dramatic and Musical Performers Act 1958
- Performers Protection Acts 1963 and 1972
- Any subsequent statutory enactments and orders

■ Do Not Locate in the Following Places

To ensure long-lasting use, do not locate the PM7001 where:

- Exposed to direct sunlight.
- Near to sources of heat such as heaters.
- Highly humid or poorly ventilated.
- Dusty.
- Subjected to mechanical vibrations.
- On wobbly, inclined or otherwise unstable surfaces
- Radiated heat is blocked such as in cramped audio racks.

To ensure proper heat radiation, ensure the below clearance from walls and other equipment.

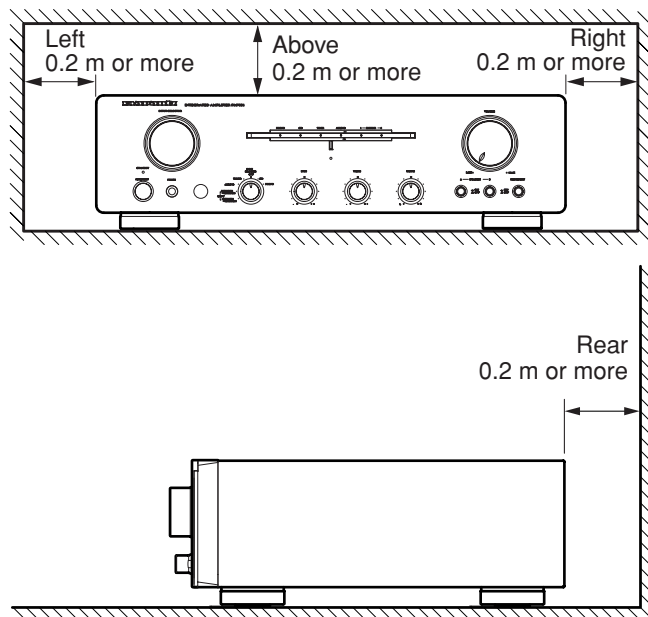

■ Keep Objects Off

Keep objects off the PM7001. Blocking the vent can result in accident and damage.

■ Do Not Touch Hot Spots During and Immediately After Use

During and immediately after use, the PM7001 is hot in areas other than the controls and rear panel connection jacks. Do not touch hot spots and especially the top panel. Contact with hot areas can cause burns.

■ Battery Handling

Improper use of dry cell batteries can result in electrolyte leaks, rupture and corrosion. Read the following precautions before use.

- If not planning to use the remote controller for an extended period of 1 month or more, remove the batteries.
- Do not mix old batteries with new batteries.
- Load batteries in the proper direction indicated on the remote controller.
- Do not mix batteries of differing type. Even batteries of the same shape and size can have differing voltages.
- If batteries leak, wipe the case clean of any adhering electrolyte and replace the old batteries with new batteries.

■ Accessories Check

Before use, check the below accessories were included in the package.

- AC power cable

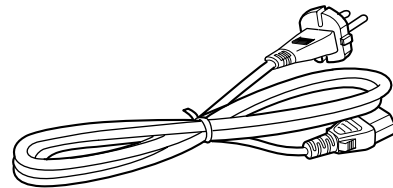

The power cable included in the package can be used with the PM7001 only. It cannot be used with other equipment.

- RC4001PM remote controller
- AA-size batteries x 2

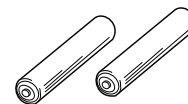
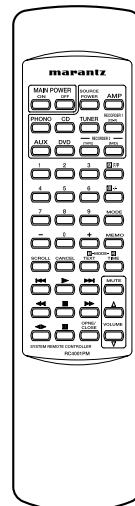

- Registration Card
- User Guide (This manual)

FEATURES

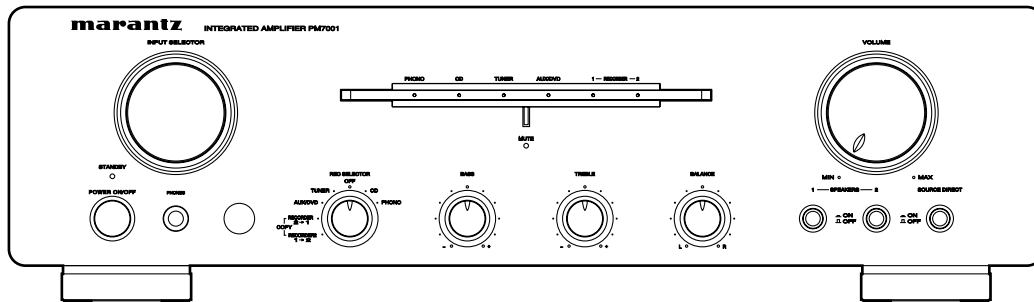

The PM7001 is an integrated amplifier developed on the design concepts of Marantz's PM-11S1 high-end model amplifier.

• CD Direct Buffer Amplifier

The PM7001 incorporates a specialized input buffer amplifier nearby the CD input jack. This buffer amplifier faithfully transmits the CD input jack signal by preventing interference from between the left and right channels, and from the effects of other circuits. A discrete configuration high-speed buffer amplifier which is built on the HDAM[®]SA technology is incorporated into the buffer amplifier circuit.

• CD Direct Selector

The output of CD direct buffer amplifier has a specialized relay switch, which directly transmits the input signal by the shortest path to the pre-amplifier.

• Improved Momentary-Current Supply Capability

It is known that sound quality differs between amplifiers that use the same spec, and Marantz believes that this is caused by differences in speaker drive capability. The PM7001 main-amplifier has the capability to momentarily pass 25 amperes or more of current, providing high-powered drive to the speakers.

• Short Power Line Layout

In order to improve the momentary-current supply capability, a new layout which places priority on making the large current line connections as short as possible was adopted.

In this layout the power supply circuit, main-amplifier output stage, and heatsink are unified, and the large current line is arranged to be as short as possible while still achieving symmetry on the left and right sides.

• Current Feedback Amplifier

Both pre-amplifier and main-amplifier incorporate a high-speed current feedback amplifier circuit, which faithfully amplify signals from the CD player. Moreover, the high-speed current feedback amplifier reproduces a natural sound field space.

PM7001 KI Version Features

Compared to the PM7001, the PM7001 KI version contains the following upgrades.

• Current Feedback PHONO Equalizer

A high-speed current feedback circuit similar to the pre-amplifier and main-amplifier circuits was adopted in the PHONO equalizer for the MM cartridge.

• Newly Developed Toroidal Transformer

A newly developed Toroidal power transformer, which produces less vibration and magnetic leakage flux than previously, has been incorporated. The materials and manufacturing process of the ring-shaped core are strictly controlled to reduce vibration, while the short-ring attached to the perimeter of the transformer reduce magnetic leakage flux.

• High Performance Volume

The volume controller, which is often considered to be the core function of an amplifier, has been upgraded to an even more reliable type of controller.

• Large Capacitance Block Capacitor

A large capacity 18000 μ F block capacitor is incorporated into the main-amplifier power supply circuit.

• Film capacitors and electrochemical capacitors etc.

The capacitors used in high end models like the PM-11S1 are incorporated into the PM7001 amplifier.

• Copper-coated Chassis

BEFORE MAKING CONNECTIONS

WIRING SPEAKER CABLE

- Be careful not to short circuit in wiring speaker cables.
- Peel off the coating of speaker cable as shown below.

Approx. 1 cm

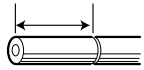

Cut the coating of cable.



Peel off the edge of cable.

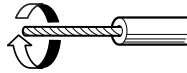

Twist conductors.

- Wiring with speaker cable.

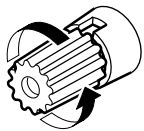

Turn counter-clockwise to loosen.

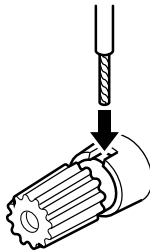

Insert conductor of cable.

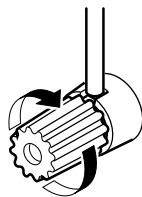

Turn clockwise to tighten.

Your speaker system must satisfy the below conditions. If it does not, the PM7001's protective circuit will activate, whereby preventing proper playback. In some cases, the amplifier and speakers may be damaged.

- If using 1 set of speakers, total speaker impedance must be 4Ω or more.
- If using 2 sets of speakers, total speaker impedance must be 8Ω or more.

Here following is explained BI-WIRING connection that improve sound quality. The speakers in this explanation have low and mid/high input jacks that support a BI-WIRING connection. To determine whether or not your speakers support a BI-WIRING connection, check in the instruction manual that came with your speakers or contact the manufacturer.

BI-WIRING CONNECTION

A bi-wiring connection separately connects the low and mid/high jacks of the speaker to the amplifier using separate speaker cables. Because separate cables are used for low and mid/high sounds, the kick back current in the low speaker causes little interference with the mid/high speaker. The PM7001 and speakers of Connection Example 1 (pg. 5) use a bi-wiring connection, therefore also refer to that page for help.

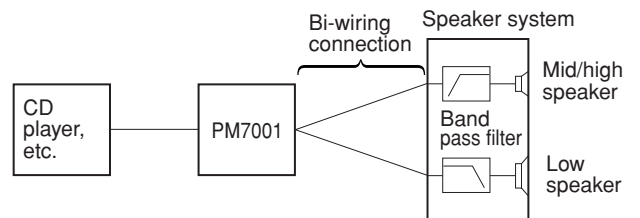

CONNECTIONS

Connection Example : Basic Connection for Stereo Playback

Refer also to the instruction manuals of components to connect equipment correctly.

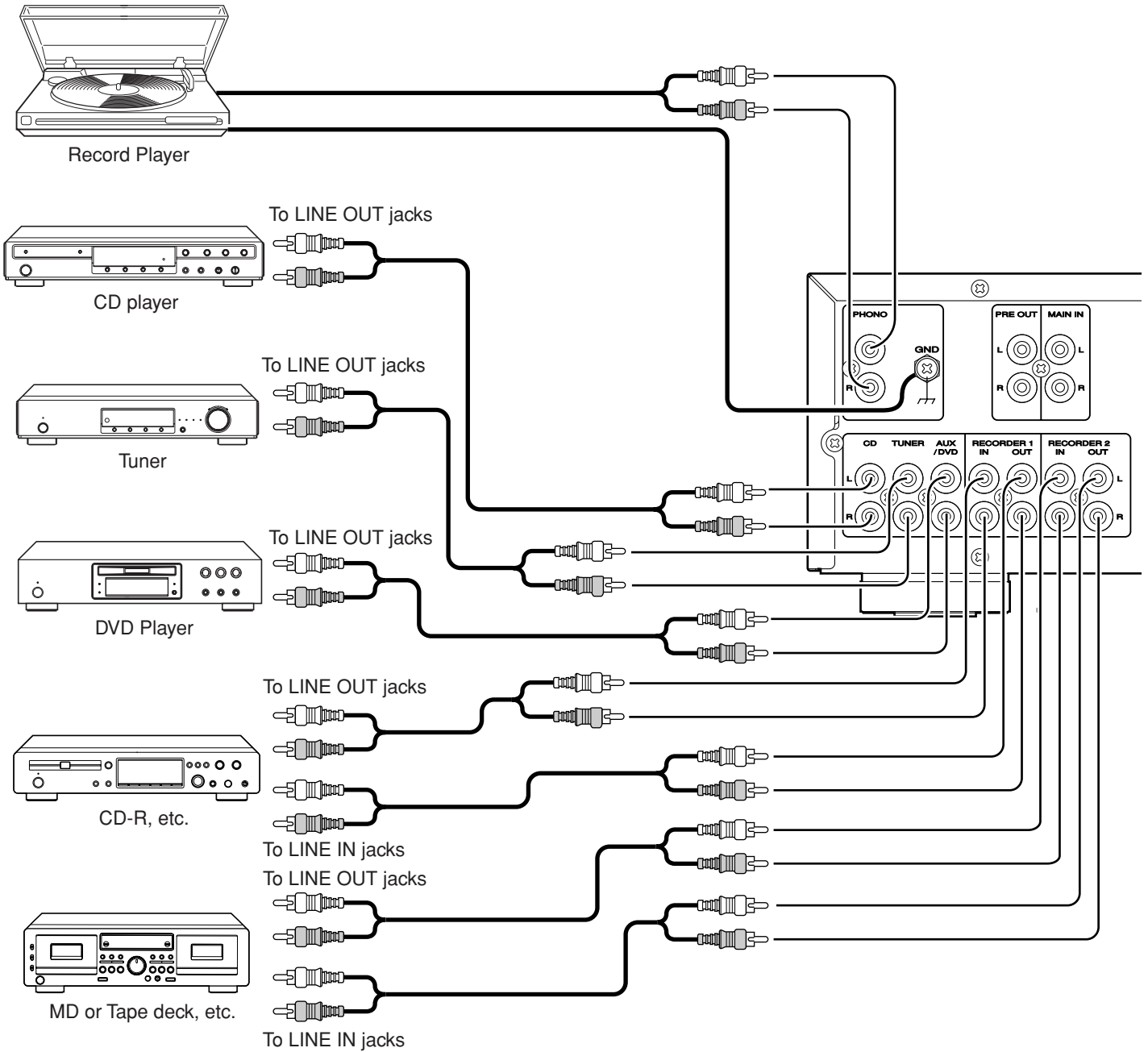

CONNECTIONS

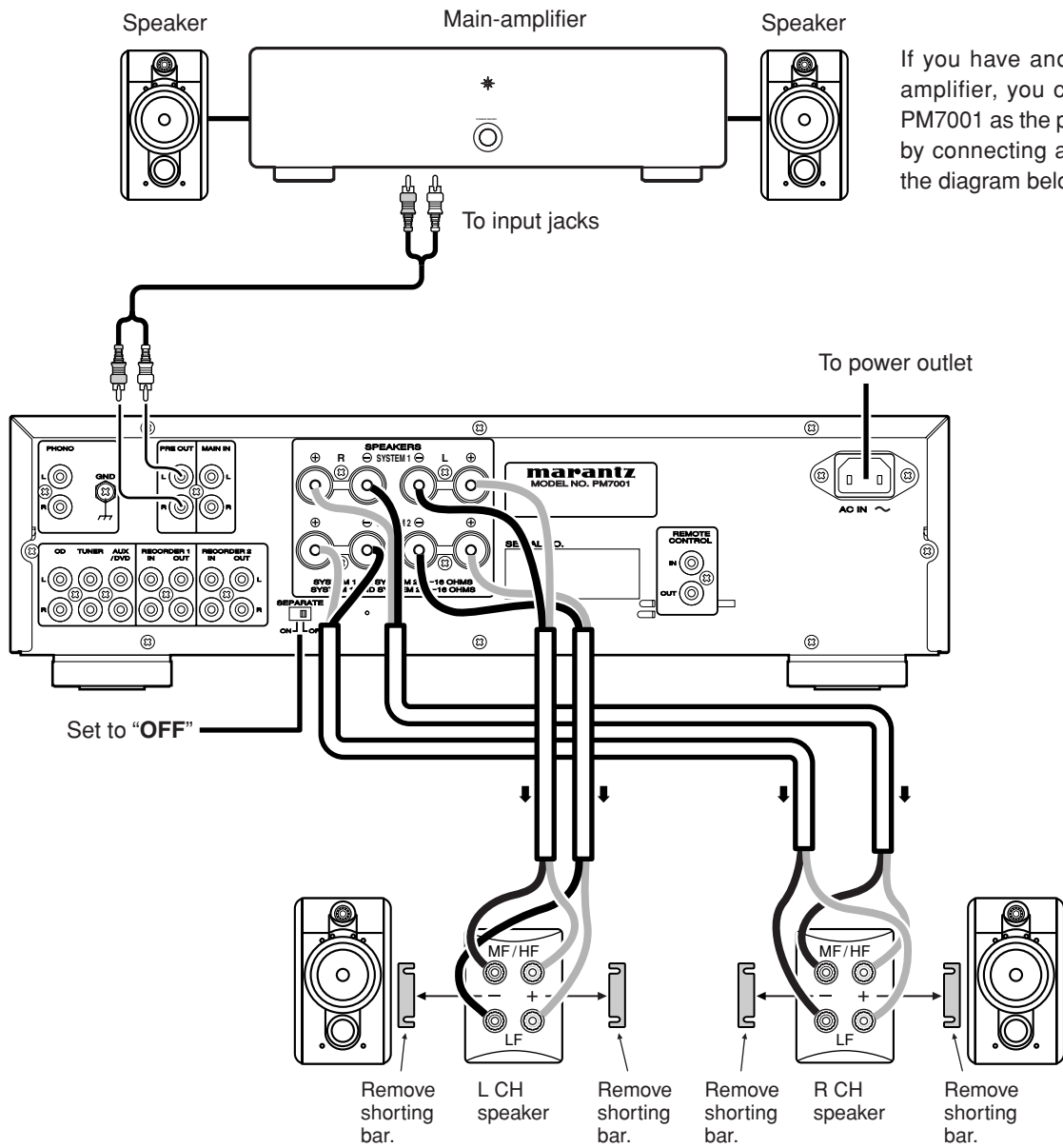

If you have another main-amplifier, you can use the PM7001 as the pre-amplifier by connecting as shown in the diagram below.

- Use a bi-wiring connection (pg. 3) for speakers.
- Set the **SPEAKERS** button 1 and button 2 on the front panel in the ON position.

NAMES AND FUNCTIONS OF PARTS

FRONT PANEL

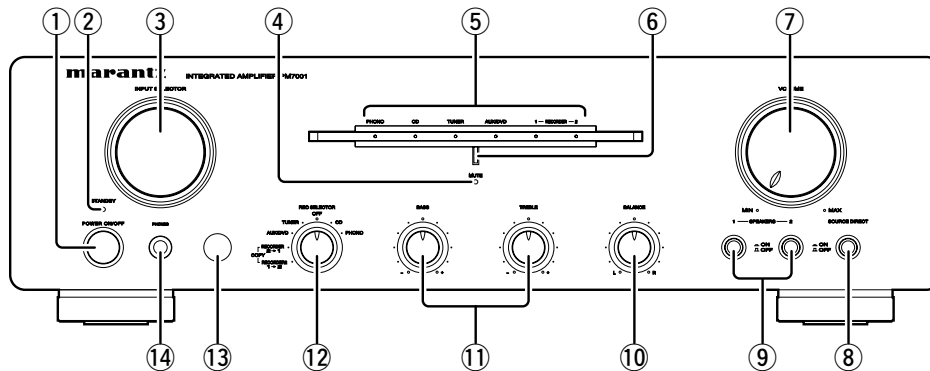

① POWER ON/OFF button

Pressing this button once turns power to the amplifier ON, and pressing it again turns power to the amplifier OFF. When the button is in the ON position, power can be switched ON/OFF using the supplied remote controller. If the power is switched OFF using the remote controller, the amplifier engages in standby mode. When in this mode, you cannot switch the power ON by pressing the **POWER ON/OFF** button ①. The amplifier remains in standby mode even if this button is pressed. To switch the power ON, either turn the **INPUT SELECTOR** knob ③ or press the **MAIN POWER ON** button 1 on the remote controller.

② STANDBY indicator

This indicator is lit red when the amplifier is in standby mode. When in standby mode, you can switch the power ON by using the **MAIN POWER ON** button 1 on the remote controller. If the amplifier's protective circuit activates, this indicator flashes and the amplifier's power automatically shuts off.

③ INPUT SELECTOR knob

This knob selects the input source for playback. The selected input source is displayed on the function indicator. The amplifier memorize the selected input source when the power is turned OFF, and then re-selects the same input source when the power is turned ON again.

④ MUTE indicator

When the **MUTE** button 3 on the remote controller is pressed, the MUTE function is activated and the volume is lowered. Pressing the **MUTE** button 3 again releases the MUTE function. Moreover, the MUTE function can also be released by pressing the **VOLUME ▲/▼** button 3 on the remote controller. If the amplifier's protective circuit activates, this indicator flashes for approx. 15 seconds and the MUTE function activates. While this indicator is flashing, the **VOLUME** knob 7 automatically turns and the volume decreases.

⑤ Function indicator

This indicator displays the input source currently selected by the **INPUT SELECTOR** knob ③.

⑥ Power indicator

This indicator is lit a blue color while power to the PM7001 is ON.

⑦ VOLUME knob

Turning this knob clockwise increases the volume, while turning it counterclockwise decreases the volume. The volume can also be adjusted using the remote controller. If the amplifier's protective circuit activates, the **VOLUME** knob 7 automatically turns for approx. 15 seconds and the volume decreases.

⑧ SOURCE DIRECT button

When this button is pressed in, the audio signal is transmitted bypassing the balance and tone control circuits, allowing you to enjoy a higher level of sound quality.

⑨ SPEAKERS 1/2 buttons

These buttons turn the speaker output to the speakers connected to the **SPEAKERS SYSTEM 1** and **2** terminals ㊦ on the rear panel **ON** and **OFF**. When listening with headphones, turn the speaker output **OFF**.

⑩ BALANCE knob

This knob is used to adjust the sound level from one of either the **L** (left) or **R** (right) channels. If the **BALANCE** knob 10 is turned all the way round to one side, sound is not output from the opposite side.

Please note that this knob does not function when the **SOURCE DIRECT** button 8 is in the **ON** position.

⑪ Tone Control knobs (BASS/TREBLE)

These knobs are used to adjust the BASS and TREBLE sound level. Turning the knobs clockwise increases the sound level, and turning them counterclockwise decreases the sound level. Please note that these knobs do not function when the **SOURCE DIRECT** button 8 is in the **ON** position.

⑫ REC SELECTOR knob

This knob switches the input sources for recording. Moreover, you can connect a tape deck, CD-R player, and other such device to the **RECORDER 1** and **2** terminals ① ② to make copies. We recommend the knob be set to the **OFF** position when not recording to obtain optimal sound quality. (See page 11.)

NAMES AND FUNCTIONS OF PARTS

13 Infrared Receptor Window

This is the receptor of control signals sent from the **RC4001PM** remote controller. Point the remote controller towards this window to properly transmit signals.

14 PHONES jack

This jack is for connecting headphones with a standard stereo plug. To listen with headphones, turn the speaker output **OFF** by setting the **SPEAKERS 1** and **2** buttons ⑨ in the **OFF** position.

REAR PANEL

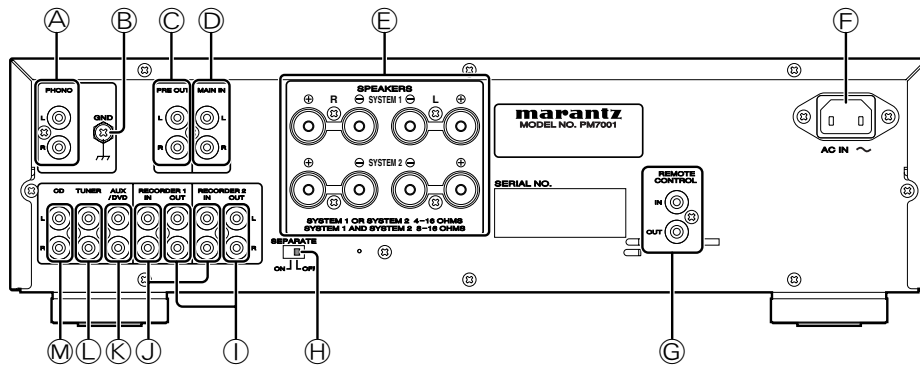

A PHONO Input jacks

These jacks are for connecting to an analog record player. MM cartridges can be used.

B PHONO GND terminal

Connect the grounding wire from an analog record player.

C PRE OUT jacks

These jacks are for connecting to the input jacks of another main-amplifier or active subwoofer.

D MAIN IN jacks

These jacks are for connecting to the output terminals of another pre-amplifier when using the PM7001 as the main-amplifier. In this case, set the **SEPARATE** switch ⑧ to the **ON** position.

E SPEAKERS SYSTEM 1, 2 output terminals

You can connect 2 speaker systems, **SPEAKERS 1** and **SPEAKERS 2** ⑨. Speaker output can be turned ON/OFF from the **SPEAKERS 1** and **2** buttons ⑨ on the front panel.

F AC IN socket

Connect the supplied AC power cable to this socket and a power outlet.

G REMOTE CONTROL jacks

These jacks are for connecting to other Marantz components such as a CD player or DVD player that has a remote control connector (D.BUS jack). You can use the remote controller supplied with the PM7001 to control the system. For more details, see page 13.

H SEPARATE switch

This switch is used for selecting the pre-amplifier and main-amplifier connection modes.

OFF: Select this position when the amplifier is used as a normal integrated amplifier. (Standard factory setting)

ON: The pre-amplifier and main-amplifier are separated. The PM7001 can be used as a main-amplifier when input is connected to the **MAIN IN** jacks ④.

I RECORDER 1/RECORDER 2 output jacks

These jacks are for connecting to the recording input jacks of a CD-R recorder, MD deck, tape deck, etc. Output signals can be selected using the **REC SELECTOR** knob ⑫ on the front panel.

J RECORDER 1/RECORDER 2 input jacks

These jacks are for connecting to the output jacks of a CD-R player, MD deck, tape deck, etc.

K AUX/DVD input jacks

These jacks are for connecting to the output jacks of a DVD player or other LINE component.

L TUNER input jacks

These jacks are for connecting to the output jacks of a tuner or other LINE component.

M CD input jacks

These jacks are for connecting to the output jacks of a CD player or similar component.

NAMES AND FUNCTIONS OF PARTS

RC4001PM REMOTE CONTROLLER

Using this remote controller, you can control the PM7001 and Marantz CD players, DVD players, tuners, tape decks etc. that have a remote control receptor. The operations possible by remote controller may differ with each component; therefore see the instruction manual that came with the component. (See page 13)

The RC4001PM remote controller buttons are laid out as shown below.

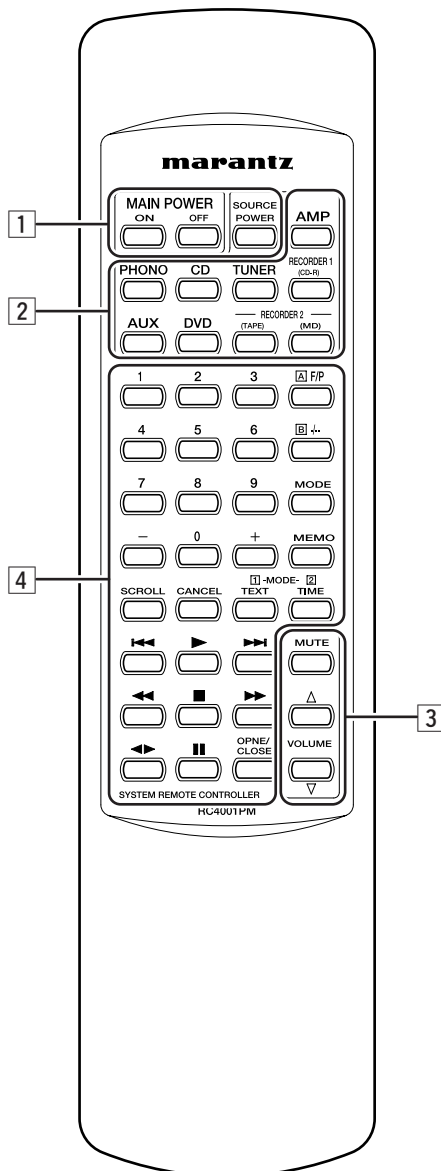

1 Power ON/OFF buttons

- **MAIN POWER ON button**
This button switches the power ON when the PM7001 is in **STANDBY** mode.
- **MAIN POWER OFF button**
This button switches the PM7001 to **STANDBY** mode when the power is ON.
- **SOURCE POWER button**
This button switches between power **ON** and **STANDBY** modes for Marantz products that have a standby function. By pressing this button after one of the buttons in the button group [2](#), you can switch the power between **ON** and **STANDBY** modes for the Marantz product that corresponds to that button.
By pressing this button after the **AMP** button [2](#), you can switch the PM7001 between power **ON** and **STANDBY** modes.

2 Input selector buttons

This group of buttons is used for selecting the input source.

Caution

In the PM7001, **AUX** and **DVD**, and **RECORDER 2's** **TAPE** and **MD** each share the same input jacks. The signal codes for controlling these Marantz products using the RC4001PM differ, therefore separate buttons have been built into the remote controller.

3 VOLUME adjustment buttons

- **MUTE Button**
This button activates the mute function. Pressing this button again releases the **MUTE** function.
The **MUTE** function can also be released by pressing either the **VOLUME ▲** or **▼** buttons [3](#).
- **VOLUME ▲ Button**
This button increases the volume level.
- **VOLUME ▼ Button**
This button decreases the volume level.

4 Component operating buttons

These buttons are for performing basic operations of a Marantz CD player, DVD player, etc. The function of each button changes to match the component selected as the input source using the input selector buttons [2](#).

NAMES AND FUNCTIONS OF PARTS

■ CD

When the **CD** button [2] is pressed, the buttons in group [4] function as indicated in the table below. These buttons can only be used when a Marantz CD player is connected to the **CD** input jacks [M].

BUTTON NAME	FUNCTION
A F/P	None
B -/--	Disc Select
MODE	Auto Music Scan (AMS)
MEMO	Program
SCROLL	Scroll/Recall Program
CANCEL	Cancel
TEXT (MODE [1])	Text
TIME (MODE [2])	Time
1 - 9	1 - 9
0	0
-	Previous Track
+	Next Track
▶	Play
⏮	Previous Track
⏭	Next Track
⏪	Fast Reverse
⏩	Fast Forward
■	Stop
◀▶	None
⏸	Pause
OPEN/CLOSE	Open/Close

■ TUNER

When the **TUNER** button [2] is pressed, the buttons in group [4] function as indicated in the table below. These buttons can only be used when a Marantz tuner is connected to the **TUNER** input jacks [L].

BUTTON NAME	FUNCTION
A F/P	Frequency Direct
B -/--	Preset 10
MODE	T-mode (Stereo/Mono)
MEMO	Memo
SCROLL	Display
CANCEL	Cancel
TEXT (MODE [1])	Preset Scan
TIME (MODE [2])	IF Band
1 - 9	Preset 1 - Preset 9, 1 - 9
0	0
-	Preset Down
+	Preset Up
▶	None
⏮	None
⏭	None
⏪	Tuning Down
⏩	Tuning Up
■	None
◀▶	None
⏸	None
OPEN/CLOSE	None

■ DVD

When the **DVD** button [2] is pressed, the buttons in group [4] function as indicated in the table below. These buttons can only be used when a Marantz DVD player is connected to the **AUX/DVD** input jacks [K].

BUTTON NAME	FUNCTION
A F/P	Disc Skip
B -/--	Disc Skip
MODE	None
MEMO	None
SCROLL	None
CANCEL	None
TEXT (MODE [1])	Audio
TIME (MODE [2])	OSD
1 - 9	1 - 9
0	0
-	Previous Chapter
+	Next Chapter
▶	Play
⏮	Previous Chapter
⏭	Next Chapter
⏪	Scan -
⏩	Scan +
■	Stop
◀▶	None
⏸	Pause
OPEN/CLOSE	Open/Close

■ TAPE

When the **RECORDER 2 (TAPE)** button [2] is pressed, the buttons in group [4] function as indicated in the table below. These buttons can only be used when a Marantz tape deck is connected to the **RECORDER 2 (TAPE)** jacks [I].

BUTTON NAME	FUNCTION
A F/P	Deck A
B -/--	Deck B
MODE	None
MEMO	None
SCROLL	None
CANCEL	Counter Reset
TEXT (MODE [1])	None
TIME (MODE [2])	Time/Display
1 - 9	None
0	None
-	Back Skip
+	Forward Skip
▶	Play
⏮	Back Skip
⏭	Forward Skip
⏪	Fast Rewind
⏩	Fast Forward
■	Stop
◀▶	Direction
⏸	Pause
OPEN/CLOSE	Eject

NAMES AND FUNCTIONS OF PARTS

■ For use of Remote controller

• Loading batteries

Before using the remote controller for the first time, load the batteries in the remote controller. The batteries provided are used to verify the operations of the remote controller only.

1. Remove the battery cover which is found on the back side of the remote controller.

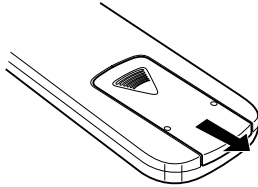

2. Load the two new size "AA" batteries inside the battery compartment while taking care to align their polarities correctly with the polarity markings (+ with + and - with -).

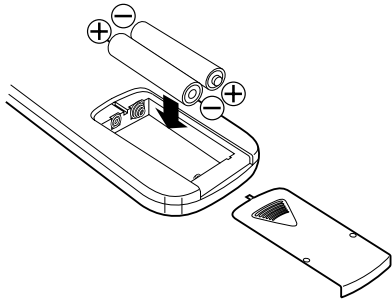

3. Push the cover on the back side in the direction of the arrow to close.

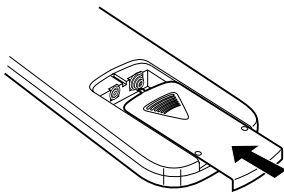

■ Operatable range of Remote controller

Operate the remote controller (RC4001PM) within a distance of approx. 5m from the infrared receptor window on the front of the PM7001.

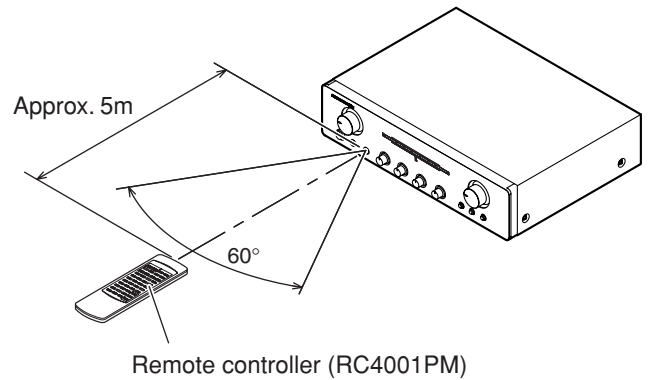

• Caution

- Do not allow direct sunlight, an inverter fluorescent light or other strong source of light to shine onto the player's infrared receptor window. Otherwise, the operation of the remote controller may be disabled.
- Bear in mind that operating the remote controller may cause other devices operated by infrared rays to be operated by mistake.
- The remote controller cannot be operated if the space between the controller and the player's infrared receptor window is obstructed.
- Do not place any objects on top of the remote controller. Doing so may cause one or more buttons to be held down which will cause the batteries to run down.

BASIC OPERATION

PLAYBACK

To explain how to play back input sources, representative examples are given with an CD player and analog record player. Before starting either procedure, check the component is correctly connected to the PM7001.

■ Disc Playback on an CD Player

1. Press the power ON/OFF button of the CD player to activate power to it.
2. Press the **POWER ON/OFF** button ① to activate power to it. Approximately 8 seconds after power has been activated, the muting turns OFF and audio output is enabled.
3. Select the **CD** from the **INPUT SELECTOR** knob ③.
4. To use the speakers connected to the **SPEAKERS SYSTEM** terminals, press the **SPEAKERS** button 1 and 2 ⑨.
5. Load a disc into the CD player and press the play button to start playback.
6. Adjust the volume level from the **VOLUME** knob ⑦.
7. Adjust bass/treble as desired from the **BASS** and **TREBLE** knobs ⑪. Be sure to first set the **SOURCE DIRECT** button ⑧ in the **OFF** position.

■ Disc Playback on an Analog Record Player

1. Press the **POWER ON/OFF** switch ① to activate power to it. Approximately 8 seconds after power has been activated, the muting turns OFF and audio output is enabled.
2. Select "PHONO" as the input source from the **INPUT SELECTOR** knob ③. To prevent unexpected accidents, it is recommended to set the volume level to **MIN.** by turning the **VOLUME** knob ⑦ until muting the volume level.
3. MM type cartridges can be connected. Use a step-up transformer when using an MC cartridge.
4. To use the speakers connected to the **SPEAKERS SYSTEM** terminals, press the **SPEAKERS** button 1 and 2 ⑨.
5. Set a record on the analog record player and play it.
6. Adjust the volume level from the **VOLUME** knob ⑦.
7. Adjust bass/treble as desired from the **BASS** and **TREBLE** knobs ⑪. Be sure to first set the **SOURCE DIRECT** button ⑧ in the **OFF** position.

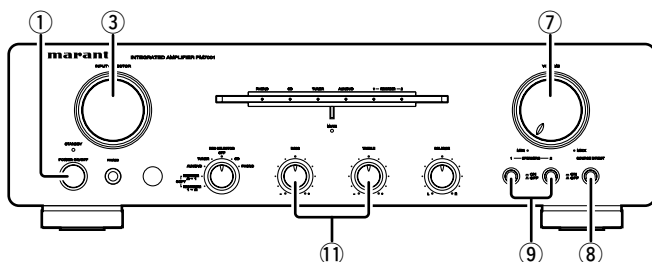

RECORDING

This example explains how to record from an input source such as an CD player to a recording device such as a CD-R.

1. Press the power ON/OFF switch of the CD player and CD-R to activate power to both components.
2. Press the **POWER ON/OFF** switch ① to activate power to it. Approximately 8 seconds after power has been activated, the muting turns OFF and audio output is enabled.
3. Select the **CD** with the **REC SELECTOR** knob ⑫. If you want to listen to the recording source through the speakers, set the **INPUT SELECTOR** knob ③ to the **CD** position.
4. Load a playback disc into the CD player and a recording disc into the CD-R.
5. Start playback on the CD player. Then, start recording on the CD-R.

About the REC SELECTOR

The **REC SELECTOR** knob ⑫ can be operated independently, irrespective of the input source selected using the **INPUT SELECTOR** knob ③.

OFF:

Cannot record because no signal is output to the **RECORDER 1, 2** jacks.

PHONO, CD, TUNER, AUX/DVD:

Selects the program source for recording.

COPY RECORDER 1-2:

Select this to copy the **RECORDER 1** signal onto **RECORDER 2**.

COPY RECORDER 2-1:

Select this to copy the **RECORDER 2** signal onto **RECORDER 1**.

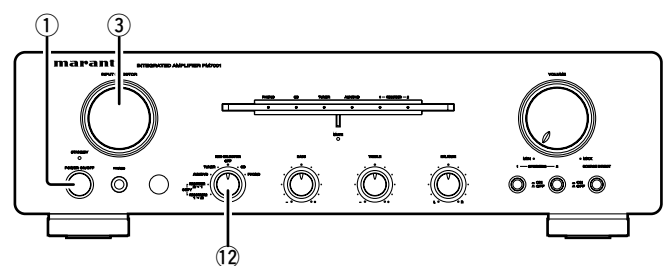

HOW TO USE AND SET FEATURES

MAIN IN JACKS

You can separate the pre-amplifier section and main-amplifier section by using the **SEPARATE** switch settings on the PM7001. If you have another pre-amplifier, you can use the PM7001 as the main-amplifier by connecting as shown in the diagram below.

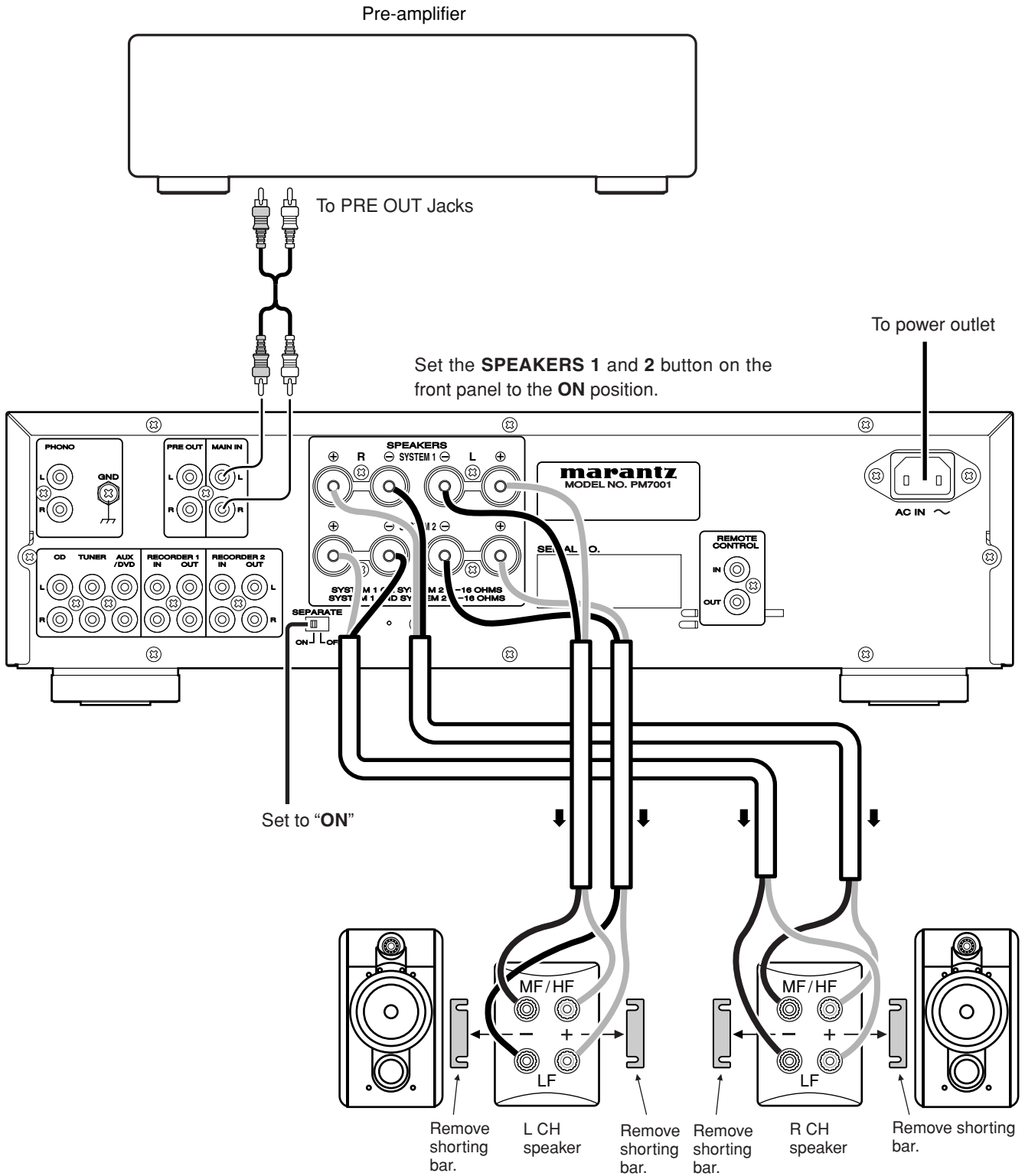

- Use a bi-wiring connection (pg. 3) for speakers.

HOW TO USE AND SET FEATURES

REMOTE CONTROL JACKS

The **REMOTE CONTROL** jacks are for connecting components that are capable of remote control (**D.BUS** jacks) such as a Marantz CD Player or DVD Player. This enables these other components to be operated with the remote controller included with the PM7001. The PM7001 comes with an RC4001PM system remote controller that can operate the basic features of Marantz CD Players and DVD Players. Here, a brief explanation of how to control the PM7001 and CD5001 using this remote controller is provided.

As shown in the illustration below, connect the **REMOTE CONTROL "IN"** jack of the CD5001 to the **REMOTE CONTROL "OUT"** jack of the PM7001, and set the CD5001 switch to **"EXTERNAL"**.

Both the PM7001 and CD5001 can be operated by pointing the **RC4001PM remote controller** (pg. 8, 9, 10) at the receptor of the PM7001.

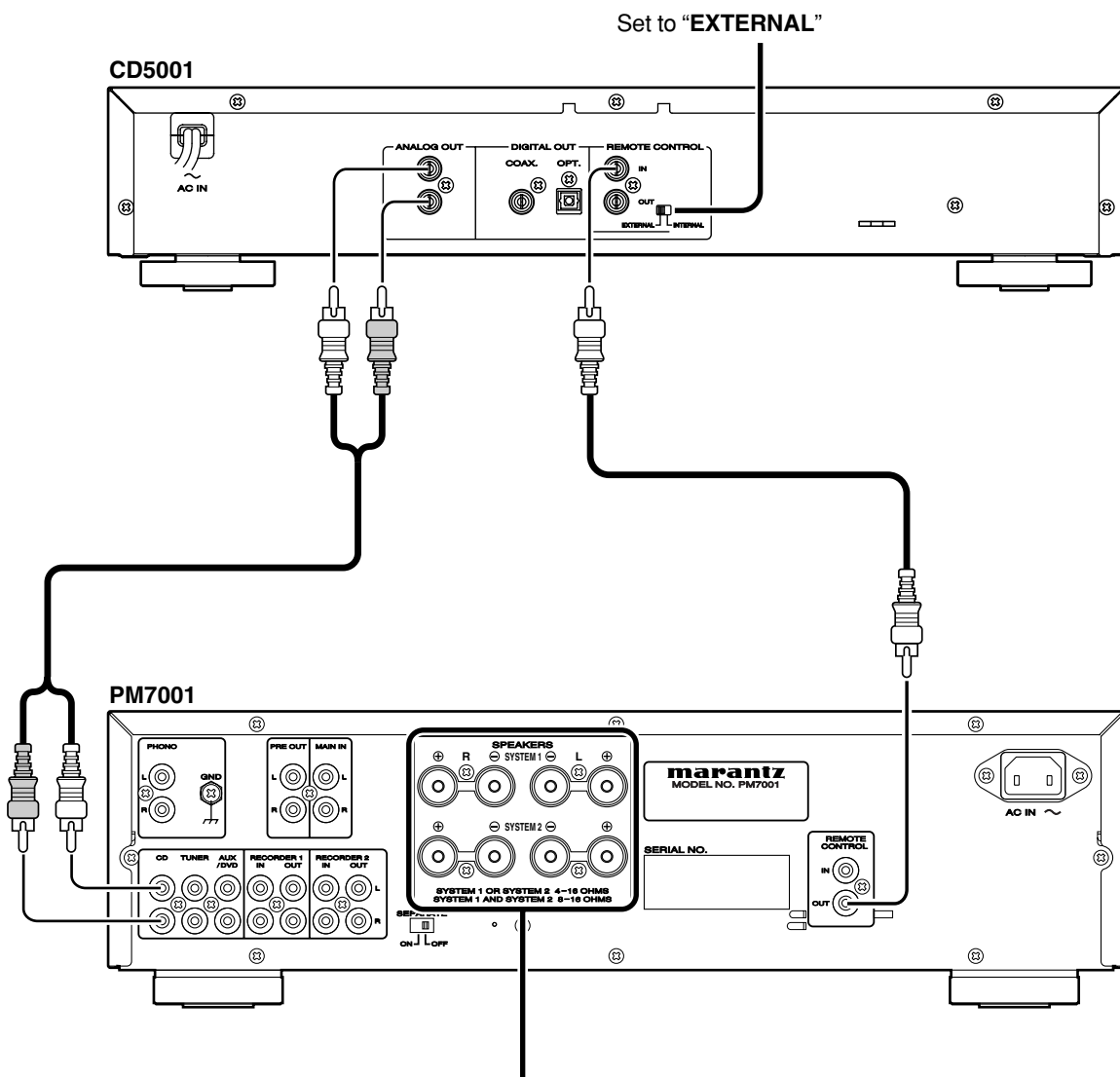

For details connecting the speakers, see page 5.

TROUBLESHOOTING

■ Before considering it as a failure

In case of trouble with this component, first check the following before calling for service.

What seems to be a serious malfunction is often due to a simple operation mistake.

If the trouble is not fixed after making the following checks, contact the place of purchase, your nearest Marantz dealer, our customer service center, or our repair service center.

* Power does not turn ON.

1. Is the power cable plugged securely into the power outlet?
2. Isn't the **STANDBY** indicator above the **POWER ON/OFF** button lit? Either turn the **INPUT SELECTOR** knob, or press the **MAIN POWER ON** button on the remote controller.
3. If the **STANDBY** indicator is flashing, the protective circuit has been activated. Switch the PM7001's **POWER ON/OFF** button to the **OFF** position, wait for more than a minute, and then turn the power back ON.

* Nothing is heard from the speakers.

1. Aren't the **SPEAKER 1** and **2** buttons on the front panel in the **OFF** position?
2. Isn't the **MUTE** function activated?
3. Did you make a mistake selecting the input source using the **INPUT SELECTOR** knob on the front panel?
4. Are you using the component correctly?
5. Are connection cables and speaker cables securely connected.
6. Is the **SEPARATE** switch on the rear panel set correctly?
7. The volume may have been muted by the protective circuit activated. Try adjusting the volume level again.

* Record player audio is not heard, or contains a lot of noise.

1. Are the **PHONO** plugs connected correctly?
2. Connect the grounding wire from the record player to the **PHONO GND** terminal.
3. Is the cartridge connected properly to the tone arm?
4. Sometimes plugging the record player's power cable into the power outlet with the polarity reversed can reduce noise.

■ About the Protective Circuit

The PM7001 is equipped with a protective circuit to protect the amplifier circuits and speaker system against damage.

If the protective circuit is activated, the sound is instantly muted. In this case, either the **MUTE** indicator in the center of the panel flashes, or the **STANDBY** indicator above the **POWER ON/OFF** button flashes.

• At Power On

For about 8 seconds after the power is turned on, the protective circuit is activated muting the sound to give the amplifier circuits time to stabilize. Once the amplifier circuits stabilize, the protective circuit releases and audio is enabled.

• In the Event of Overcurrent

The protective circuit is activated if current exceeding a certain level is detected, which can happen if excessive signal flow is input to the amplifier or if the PM7001 is connected to a speaker system of less than 4Ω impedance. The protective circuit is also activated if a speaker cable shorts.

In these cases, the **MUTE** indicator in the center of the panel flashes, and the volume is automatically reduced. Approximately 15 seconds later the protective circuit is released, therefore the volume needs readjusting to continue normal use.

Moreover, if the overcurrent continues, the amplifier's power shuts OFF and the **STANDBY** indicator above the **POWER ON/OFF** button flashes.

• If excessive ultra-bass signals are input

The protective circuit is also activated if ultra-bass signals that exceed the base signal range settings are input. In this case, the **MUTE** indicator in the center of the panel flashes, and the volume is automatically reduced. Approximately 15 seconds later, the protective circuit is released, therefore the volume needs readjusting to continue normal use. If excessive ultra-bass signal input continues or if DC voltage is detected due to trouble with the amplifier, the power shuts OFF and the **STANDBY** indicator above the **POWER ON/OFF** button flashes.

• If the Main-amplifier Overheats

The protective circuit is activated if the temperature of the main-amplifier section rises above a certain level, which can happen if the amplifier is continually used with excessive signal flow being input into it. The protective circuit is also activated when the set operating temperature is exceeded, which can happen if the vents on top of the amplifier are covered, or if the amplifier is installed on a cramped audio rack. In these cases, the **MUTE** indicator in the center of the panel flashes, and the volume is automatically reduced. Approximately 15 seconds later, the protective circuit is released, therefore the volume needs readjusting to continue normal use.

If the temperature does not sufficiently lower within a certain amount of time after the protective circuit activation, the power shuts OFF and the **STANDBY** indicator above the **POWER ON/OFF** button flashes.

• In the Event of Amplifier Trouble

The protective circuit is activated and the power is automatically shut OFF if an abnormality is detected in the power circuit. The same happens if the main fuse inside the amplifier blows. In these cases, the **STANDBY** indicator above the **POWER ON/OFF** button flashes.

OTHERS

The section describes the care and maintenance tasks that must be performed to optimize the operation of your Marantz component.

■ Cleaning of equipment external surfaces

The exterior finish of your unit will last indefinitely with proper care and cleaning. Never use scouring pads, steel wool, scouring powders or harsh chemical agents (e.g., lye solution), alcohol, thinner, benzene, insecticide or other volatile substances as these will mar the finish of the equipment. Likewise, never use cloths containing chemical substances. If the equipment get dirty, wipe the external surfaces with a soft, lint-free cloth.

If the equipment becomes heavily soiled:

- dilute some washing up liquid in water, in a ratio of one part detergent to six parts water.
- dip a soft, lint free in the solution and wring the it is damp.
- wipe the equipment with the damp cloth.
- dry the equipment by wiping it with a dry cloth.



■ Repairs

Only the most competent and qualified service technicians should be allowed to service the factory-trained warranty station personnel have the knowledge and special facilities needed for repair and calibration of this precision equipment. After the warranty period has expired, repairs will be performed for a charge if the equipment can be returned to normal operation. In the event of difficulty, refer to your dealer or write directly to the nearest location to you that is listed on the Marantz Authorized Service Station list. If writing, please include the model and serial number of the equipment together with a full description of what you think is abnormal about the equipment's behaviour.

SPECIFICATIONS & DIMENSIONAL DRAWINGS

Power output (20 Hz – 20 kHz simultaneous drive of both channels)	
.....	70W x 2 (8Ω load)
.....	100W x 2 (4Ω load)
Total harmonic distortion (20Hz – 20kHz simultaneous drive of both channels, 8Ω load)	0.02%
Output band width (8Ω load, 0.05%)	5Hz – 60kHz
Frequency response (CD, 1W, 8Ω load)	5Hz – 100kHz ±3dB
Dumping factor (8Ω load, 20Hz – 20kHz)	100
Input sensitivity/Input impedance	
PHONO (MM)	2.5mV/47kΩ
CD, LINE, TUNER, AUX/DVD, RECORDER	
.....	200mV/20kΩ
MAIN IN	1.6V/20kΩ
Output voltage/Output impedance	
PRE OUT	1.6 V/560Ω
Maximum allowable PHONO input level (1kHz)	
MM	130mV
RIAA deviation (20Hz ~ 20kHz)	±0.5dB
S/N (IHF-A, 1W, 8Ω load)	
PHONO (MM)	85dB (5mV input)
CD, LINE, TUNER, AUX/DVD, RECORDER	
.....	88dB (500mV input)
MAIN IN	107dB
Tone control	
Bass (50Hz)	±10dB
Treble (20kHz)	±10dB
Power requirement	AC 230V 50Hz
Power consumption	
(EN60065)	250W
(4Ω, 100W x 2 output)	470W

Accessories	
Remote controller	1
AA batteries	2
Detachable AC power cable	1
Maximum outer dimensions (Amplifier)	
Width	440mm
Height	126.5mm
Height (PM7001 KI)	128mm
Depth	364mm
Weight (Amplifier)	10.5kg

Specifications subject to change without prior notice.

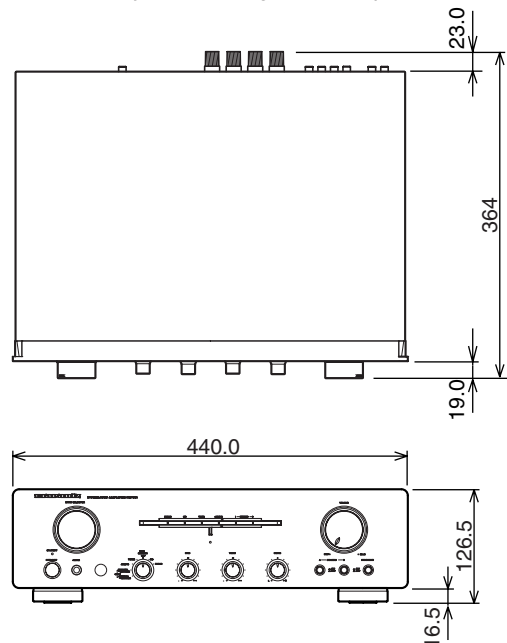

www.marantz.com

You can find your nearest authorized distributor or dealer on our website.

U.S.A. Marantz America, Inc. 1100 Maplewood Drive, Itasca, IL 60143, U.S.A.

EUROPE Marantz Europe B.V. P.O. Box 8744, 5605 LS Eindhoven, The Netherlands

marantz[®] is a registered trademark.



Printed in China

07/2005 00M14AJ851310 mzt-d

Free Manuals Download Website

<http://myh66.com>

<http://usermanuals.us>

<http://www.somanuals.com>

<http://www.4manuals.cc>

<http://www.manual-lib.com>

<http://www.404manual.com>

<http://www.luxmanual.com>

<http://aubethermostatmanual.com>

Golf course search by state

<http://golfingnear.com>

Email search by domain

<http://emailbydomain.com>

Auto manuals search

<http://auto.somanuals.com>

TV manuals search

<http://tv.somanuals.com>