

Nikon

DIGITAL CAMERA

D60

User's Manual

En

Trademark Information

- Microsoft and Windows Vista are either registered trademarks or trademarks of Microsoft Corporation in the United States and/or other countries.
- Macintosh, Mac OS, and QuickTime are trademarks of Apple Inc.
- Adobe and Acrobat are registered trademarks of Adobe Systems Inc.
- The SD logo is a trademark of the SD Card Association.
- The SDHC logo is a trademark.
- PictBridge is a trademark.
- All other trade names mentioned in this manual or the other documentation provided with your Nikon product are trademarks or registered trademarks of their respective holders.

Introduction

First Steps

Basic Photography

P, S, A, and M Modes

Changing Shooting Settings

More on Playback

Connecting to a Computer, Printer, or TV

Menu Guide

Optional Accessories

Maximizing the Life of the Camera

Technical Notes

For Your Safety

To prevent damage to your Nikon product or injury to yourself or to others, read the following safety precautions in their entirety before using this equipment. Keep these safety instructions where all those who use the product will read them.

The consequences that could result from failure to observe the precautions listed in this section are indicated by the following symbol:



This icon marks warnings. To prevent possible injury, read all warnings before using this Nikon product.

WARNINGS

- ⚠ Keep the sun out of the frame**
Keep the sun well out of the frame when shooting backlit subjects. Sunlight focused into the camera when the sun is within, or close to, the frame could cause a fire.
- ⚠ Do not look at the sun through the viewfinder**
Viewing the sun or other strong light source through the viewfinder could cause permanent visual impairment.
- ⚠ Using the viewfinder diopter control**
When operating the viewfinder diopter control with your eye to the viewfinder, care should be taken not to put your finger in your eye accidentally.
- ⚠ Turn off immediately in the event of malfunction**
Should you notice smoke or an unusual smell coming from the equipment or AC adapter (available separately), unplug the AC adapter and remove the battery immediately, taking care to avoid burns. Continued operation could result in injury. After removing the battery, take the equipment to a Nikon-authorized service center for inspection.
- ⚠ Do not disassemble**
Touching the product's internal parts could result in injury. In the event of malfunction, the product should be repaired only by a qualified technician. Should the product break open as the result of a fall or other accident, remove the battery and/or AC adapter and then take the product to a Nikon-authorized service center for inspection.
- ⚠ Do not use in the presence of flammable gas**
Do not use electronic equipment in the presence of flammable gas, as this could result in explosion or fire.
- ⚠ Keep out of reach of children**
Failure to observe this precaution could result in injury.
- ⚠ Do not place the strap around the neck of an infant or child**
Placing the camera strap around the neck of an infant or child could result in strangulation.
- ⚠ Observe proper precautions when handling batteries**
Batteries may leak or explode if improperly handled. Observe the following precautions when handling batteries for use in this product:

 - Only use a Rechargeable Li-ion Battery EN-EL9 (supplied). Use the Quick Charger MH-23 (supplied) to charge the battery.
 - Do not short or disassemble the battery.
 - Be sure the product is off before replacing the battery. If you are using an AC adapter, be sure it is unplugged.
 - Do not attempt to insert the battery upside down or backwards.
 - Do not expose the battery to flame or to excessive heat.
 - Do not immerse in or expose to water.
 - Replace the terminal cover when transporting the battery. Do not transport or store the battery with metal objects such as necklaces or hairpins.
 - Batteries are prone to leakage when fully discharged. To avoid damage to the product, be sure to remove the battery when no charge remains.
 - When the battery is not in use, attach the terminal cover and store in a cool, dry place.
 - The battery may be hot immediately after use or when the product has been used on battery power for an extended period. Before removing the battery turn the camera off and allow the battery to cool.
 - Discontinue use immediately should you notice any changes in the battery, such as discoloration or deformation.

⚠ **Observe proper precautions when handling the quick charger**

- Keep dry. Failure to observe this precaution could result in fire or electric shock.
- Dust on or near the metal parts of the plug should be removed with a dry cloth. Continued use could result in fire.
- Do not handle the power cable or go near the charger during lightning storms. Failure to observe this precaution could result in electric shock.
- Do not damage, modify, or forcibly tug or bend the power cable. Do not place it under heavy objects or expose it to heat or flame. Should the insulation be damaged and the wires become exposed, take the power cable to a Nikon-authorized service representative for inspection. Failure to observe this precaution could result in fire or electric shock.
- Do not handle the plug or charger with wet hands. Failure to observe this precaution could result in electric shock.

⚠ **Avoid contact with liquid crystal**

Should the monitor break, care should be taken to avoid injury due to broken glass and to prevent the liquid crystal from the monitor touching the skin or entering the eyes or mouth.

⚠ **Use appropriate cables**

When connecting cables to the input and output jacks, use only the cables provided or sold by Nikon for the purpose to maintain compliance with product regulations.

⚠ **CD-ROMs**

CD-ROMs containing software or manuals should not be played back on audio CD equipment. Playing CD-ROMs on an audio CD player could cause hearing loss or damage the equipment.

⚠ **Observe caution when using the flash**

Do not operate the flash with the flash window touching a person or object. Failure to observe this precaution could result in burns or fire.

Using the flash close to the subject's eyes could cause temporary visual impairment. Particular care should be observed when photographing infants, when the flash should be no less than one meter (39in.) from the subject.

Notices

- No part of the manuals included with this product may be reproduced, transmitted, transcribed, stored in a retrieval system, or translated into any language in any form, by any means, without Nikon's prior written permission.
- Nikon reserves the right to change the specifications of the hardware and software described in these manuals at any time and without prior notice.
- Nikon will not be held liable for any damages resulting from the use of this product.
- While every effort has been made to ensure that the information in these manuals is accurate and complete, we would appreciate it were you to bring any errors or omissions to the attention of the Nikon representative in your area (address provided separately).

Notices for Customers in the U.S.A.

Federal Communications Commission (FCC) Radio Frequency Interference Statement

This equipment has been tested and found to comply with the limits for a Class B digital device, pursuant to Part 15 of the FCC rules. These limits are designed to provide reasonable protection against harmful interference in a residential installation. This equipment generates, uses, and can radiate radio frequency energy and, if not installed and used in accordance with the instructions, may cause harmful interference to radio communications. However, there is no guarantee that interference will not occur in a particular installation. If this equipment does cause harmful interference to radio or television reception, which can be determined by turning the equipment off and on, the user is encouraged to try to correct the interference by one or more of the following measures:

- Reorient or relocate the receiving antenna.
- Increase the separation between the equipment and receiver.
- Connect the equipment into an outlet on a circuit different from that to which the receiver is connected.
- Consult the dealer or an experienced radio/television technician for help.



Nikon
D60

CAUTIONS

Modifications

The FCC requires the user be notified that any changes or modifications made to this device that are not expressly approved by Nikon Corporation may void the user's authority to operate the equipment.

Interface Cables

Use the interface cables sold or provided by Nikon for your equipment. Using other interface cables may exceed the limits of Class B Part 15 of the FCC rules.

Nikon Inc., 1300 Walt Whitman Road, Melville, New York 11747-3064, U.S.A. Tel.: 631-547-4200

Notices for Customers in Canada

CAUTION

This Class B digital apparatus complies with Canadian ICES-003.

Notice for Customers in the State of California

WARNING: Handling the cord on this product may expose you to lead, a chemical known to the State of California to cause birth defects or other reproductive harm. Wash hands after handling.

ATTENTION

Cet appareil numérique de la classe B est conforme à la norme NMB-003 du Canada.

Symbol for Separate Collection in European Countries

This symbol indicates that this product is to be collected separately.



The following apply only to users in European countries:

- This product is designated for separate collection at an appropriate collection point. Do not dispose of as household waste.
- For more information, contact the retailer or the local authorities in charge of waste management.

Notice Concerning Prohibition of Copying or Reproduction

Note that simply being in possession of material that has been digitally copied or reproduced by means of a scanner, digital camera, or other device may be punishable by law.

• Items prohibited by law from being copied or reproduced

Do not copy or reproduce paper money, coins, securities, government bonds, or local government bonds, even if such copies or reproductions are stamped "Sample."

The copying or reproduction of paper money, coins, or securities which are circulated in a foreign country is prohibited.

Unless the prior permission of the government has been obtained, the copying or reproduction or unused postage stamps or post cards issued by the government is prohibited.

The copying or reproduction of stamps issued by the government and of certified documents stipulated by law is prohibited.

• Cautions on certain copies and reproductions

The government has issued cautions on copies or reproductions of securities issued by private companies (shares, bills, checks, gift certificates, etc.), commuter passes, or coupon tickets, except when a minimum of necessary copies are to be provided for business use by a company. Also, do not copy or reproduce passports issued by the government, licenses issued by public agencies and private groups, ID cards, and tickets, such as passes and meal coupons.

• Copying with copyright notices

The copying or reproduction of copyrighted creative works such as books, music, paintings, woodcuts, prints, maps, drawings, movies, and photographs is governed by national and international copyright laws. Do not use this product for the purpose of making illegal copies or to infringe copyright laws.

Table of Contents

For Your Safety	ii
Notices	iii

Introduction..... 1







About This Manual	1
Information and Precautions	2
Getting to Know the Camera.....	4
Camera Body	4
The Mode Dial	6
The Power Switch	6
The Viewfinder Display	7
The Shooting Information Display	8
The Command Dial.....	10
Multi Selector.....	12
The Shutter-Release Button.....	13
? (Help) Button	13
The Camera Strap AN-DC1	14

First Steps..... 15

Charging and Inserting the Battery	16
The Quick Charger MH-23	16
The Rechargeable Li-ion Battery EN-EL9	16
Attaching a Lens	18
Detaching Lenses.....	19
Vibration Reduction Mode (VR)	20
Setting Display Language, Date and Time	21
Reset the Clock	21
Inserting Memory Cards.....	23
Inserting Memory Cards.....	23
Formatting Memory Cards	24
Adjusting Viewfinder Focus (Diopter Adjustment).....	26

Basic Photography 27

“Point-and-Shoot” Photography ( (Auto) Mode).....	28
Step 1 Turn the Camera On and Select Shooting Mode.....	28
Step 2 Frame a Photograph	30
Step 3 Focus and Shoot.....	32
Step 4 Viewing Photographs/Deleting Photographs	34

Shooting Particular Scenes.....	36
Taking Pictures	36
Features of  ,  ,  ,  ,  ,  , and  Modes.....	36
Getting Good Results with Autofocus.....	38
<hr/>	
P, S, A, and M Modes.....	39
Shooting in P, S, A, and M Modes.....	40
Shooting in P Mode (Programmed Auto).....	41
Shooting in S Mode (Shutter-Priority Auto).....	42
Shooting in A Mode (Aperture-Priority Auto).....	43
Shooting in M Mode (Manual)	44
<hr/>	
Changing Shooting Settings	47
The Quick Settings Display	48
Image Quality and Size.....	49
Image Quality	50
Image Size	50
White Balance	52
ISO Sensitivity	53
Releasing the Shutter	54
Release Mode.....	54
Continuous Mode	54
Self-Timer and Remote Control Modes	55
Focus.....	57
Focus Mode.....	57
AF-Area Mode.....	58
Focus Point Selection.....	59
Focus Lock	60
Manual Focus	61
Exposure.....	62
Metering	62
Autoexposure Lock	63
Using the Built-in Flash	64
Changing the Flash Mode.....	65
Exposure Compensation	67
Flash Compensation	68
Active D-Lighting	69
Two-Button Reset.....	70

More on Playback	71
Viewing Photographs in Full-Frame Playback.....	72
Full-Frame Playback	72
Photo Information.....	73
Viewing Multiple Photographs: Thumbnail Playback.....	76
Taking a Closer Look: Playback Zoom	77
Protecting Photographs from Deletion	78
<hr/>	
Connecting to a Computer, Printer, or TV	79
Connecting to a Computer.....	80
Before Connecting the Camera.....	80
Connecting the USB Cable	81
Connecting to a Printer.....	83
Printing Via Direct USB Connection	84
Connecting the Printer	85
Printing Photographs One at a Time.....	86
Printing Multiple Photographs.....	88
Creating an Index Print	89
Creating a DPOF Print Order: Print Set	90
Viewing Photographs on TV.....	92
<hr/>	
Menu Guide.....	93
Using Camera Menus.....	94
Playback Options: The Playback Menu	96
Delete.....	96
Playback Folder	97
Rotate Tall.....	98
Slide Show.....	98
Stop-Motion Movie	99
Shooting Options: The Shooting Menu	100
Optimize Image.....	101
Customizing Image Enhancement Options: Custom	102
White Balance	103
Fine-Tuning White Balance	104
Preset Manual	105
Noise Reduction	108

Custom Settings	109
R Reset	110
01 Beep	110
06 No Memory Card?.....	110
07 Image Review.....	111
09 AF-assist	111
10 ISO Auto.....	111
11  Fn Button.....	112
12 AE-L/AF-L	113
13 AE Lock.....	113
14 Built-in Flash/Optional Flash Unit.....	113
15 Auto off Timers.....	114
16 Self-Timer.....	114
17 Remote on Duration.....	115
18 Date Imprint.....	115
19 Rangefinder	116
Basic Camera Settings: The Setup Menu	117
CSM/Setup Menu	118
Choosing Menu Items for My Menu.....	119
Info Display Format	120
Auto Shooting Info	122
Shooting Info Auto off.....	123
LCD Brightness	123
Video Mode	123
Language.....	123
Image Comment.....	124
Folders.....	125
File No. Sequence.....	126
Clean Image Sensor	126
Mirror Lock-Up.....	126
Firmware Version	126
Dust off Ref Photo	127
Auto Image Rotation	128

Creating Retouched Copies: The Retouch Menu.....	129
Creating Retouched Copies.....	130
Creating Retouched Copies in Full-frame Playback.....	131
Quick Retouch.....	132
D-Lighting.....	132
Red-Eye Correction.....	133
Trim.....	134
Monochrome.....	134
Filter Effects.....	135
Small Picture.....	136
Image Overlay.....	138
NEF (RAW) Processing.....	140
Stop-motion Movie.....	141
Before and after (Making a Side-by-Side Comparison).....	143

Optional Accessories 145

Compatible Lenses.....	146
Optional Flash Units (Speedlights).....	150
Other Accessories.....	155
Connecting the Power Connector and the AC Adapter.....	157
Approved Memory Cards.....	158

Maximizing the Life of the Camera 159

Caring for the Camera.....	159
Storage.....	159
Cleaning.....	159
Caring for the Optical Low-Pass Filter.....	160
Caring for the Camera and Battery: Cautions.....	164
The Camera and Lens.....	164
The Battery.....	166

Technical Notes 167

Troubleshooting 167

 Display 167

 Shooting 168

 Playback 170

 Others 171

Camera Error Messages and Displays 172

Appendix 176

 Available Settings and Defaults 176

 Memory Card Capacity and Image Quality/Size 178

 Exposure Program (Mode P) 178

 Flash Control 179

 Shutter Speeds Available with the Built-in Flash 179

 Aperture, Sensitivity, and Flash Range 179

Specifications 180

 Supported Standards 186

Index 187

Introduction

About This Manual

Thank you for your purchase of a Nikon D60 digital single-lens reflex (D-SLR) camera. This manual was written to help you enjoy shooting with your Nikon digital camera. Read this manual thoroughly before use, and keep it where all those who use the product will read it.

Symbols and Conventions

To make it easier to find the information you need, the following symbols (icons) and conventions are used:



This icon marks cautions, information that should be read before use to prevent damage to the camera.



This icon marks tips, additional information that may be helpful when using the camera.



This icon marks notes, information that should be read before using the camera.



This icon indicates that more information is available elsewhere in this manual or in the *Quick Start Guide*.



This icon marks settings that can be adjusted from camera menus by pressing **MENU**.



This icon marks menu items for which button function can be assigned from the Custom Settings menu.

Notations

- A Secure Digital (SD) memory card is referred to as a “memory card.”
- The setting at the time of purchase is referred to as the “default setting.”
- The names of menu items displayed in the camera monitor, and the names of buttons or messages displayed in the computer monitor are indicated with bold text.

Screen Samples

In this manual, images are sometimes omitted from monitor display samples so that monitor indicators can be more clearly shown.

Illustrations and Screen Display

Illustrations and text displays shown in this manual may differ from actual display.

Information and Precautions

Life-Long Learning

As part of Nikon's "Life-Long Learning" commitment to ongoing product support and education, continually updated information is available online at the following sites:

- For users in the U.S.A.: <http://www.nikonusa.com/>
- For users in Europe and Africa: <http://www.europe-nikon.com/support/>
- For users in Asia, Oceania, and the Middle East: <http://www.nikon-asia.com/>

Visit these sites to keep up-to-date with the latest product information, tips, answers to frequently asked questions (FAQs), and general advice on digital imaging and photography. Additional information may be available from the Nikon representative in your area. See the URL below for contact information:

<http://nikonimaging.com/>

Digitutor

Digitutor, a series of "watch and learn" manuals in movie form, is available from the following website:

http://www.nikondigitutor.com/index_eng.html

Before Taking Important Pictures

Before taking pictures on important occasions (such as at weddings or before taking the camera on a trip), take a test shot to ensure that the camera is functioning normally. Nikon will not be held liable for damages or lost profits that may result from product malfunction.

Use Only Nikon Brand Electronic Accessories

Nikon digital single-lens reflex cameras are designed to the highest standards and include complex electronic circuitry. Only Nikon brand electronic accessories (including lenses, battery chargers, batteries, AC adapters, and flash accessories) certified by Nikon specifically for use with this Nikon digital single-lens reflex camera are engineered and proven to operate within the operational and safety requirements of this electronic circuitry.

Holographic seal: Identifies this device as an authentic Nikon product.

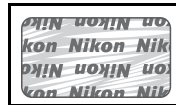

THE USE OF NON-NIKON ELECTRONIC ACCESSORIES COULD DAMAGE THE CAMERA AND MAY VOID YOUR NIKON WARRANTY.

For more information about Nikon brand accessories, contact a local authorized Nikon dealer.

About the Manuals

- No part of the manuals included with this product may be reproduced, transmitted, transcribed, stored in a retrieval system, or translated into any language in any form, by any means, without Nikon's prior written permission.
- Nikon reserves the right to change the specifications of the hardware and software described in these manuals at any time and without prior notice.
- Nikon will not be held liable for any damages resulting from the use of this product.
- While every effort was made to ensure that the information in these manuals is accurate and complete, we would appreciate it were you to bring any errors or omissions to the attention of the Nikon representative in your area (address provided separately).

Notice Concerning Prohibition of Copying or Reproduction

Note that simply being in possession of material that was digitally copied or reproduced by means of a scanner, digital camera or other device may be punishable by law.

• **Items prohibited by law from being copied or reproduced**

Do not copy or reproduce paper money, coins, securities, government bonds or local government bonds, even if such copies or reproductions are stamped "Sample." The copying or reproduction of paper money, coins, or securities which are circulated in a foreign country is prohibited. Unless the prior permission of the government was obtained, the copying or reproduction of unused postage stamps or post cards issued by the government is prohibited. The copying or reproduction of stamps issued by the government and of certified documents stipulated by law is prohibited.

• **Cautions on certain copies and reproductions**

The government has issued cautions on copies or reproductions of securities issued by private companies (shares, bills, checks, gift certificates, etc.), commuter passes or coupon tickets, except when a minimum of necessary copies are to be provided for business use by a company. Also, do not copy or reproduce passports issued by the government, licenses issued by public agencies and private groups, ID cards and tickets, such as passes and meal coupons.

• **Comply with copyright notices**

The copying or reproduction of copyrighted creative works such as books, music, paintings, woodcut prints, maps, drawings, movies and photographs is governed by national and international copyright laws. Do not use this product for the purpose of making illegal copies or to infringe copyright laws.

Disposing of Data Storage Devices

Please note that deleting images or formatting data storage devices such as memory cards or built-in camera memory does not completely erase the original image data. Deleted files can sometimes be recovered from discarded storage devices using commercially available software, potentially resulting in the malicious use of personal image data. Ensuring the privacy of such data is the user's responsibility.

Before discarding a data storage device or transferring ownership to another person, erase all data using commercial deletion software, or format the device and then completely refill it with images containing no private information (for example, pictures of empty sky). Be sure to also replace any pictures selected for the **Preset manual** white balance setting (📷 105) and **Wallpaper** (📷 120). Care should be taken to avoid injury or damage to property when physically destroying data storage devices.

Getting to Know the Camera

Take a few moments to familiarize yourself with camera controls and displays. You may find it helpful to bookmark this section and refer to it as you read through the rest of the manual.

Camera Body

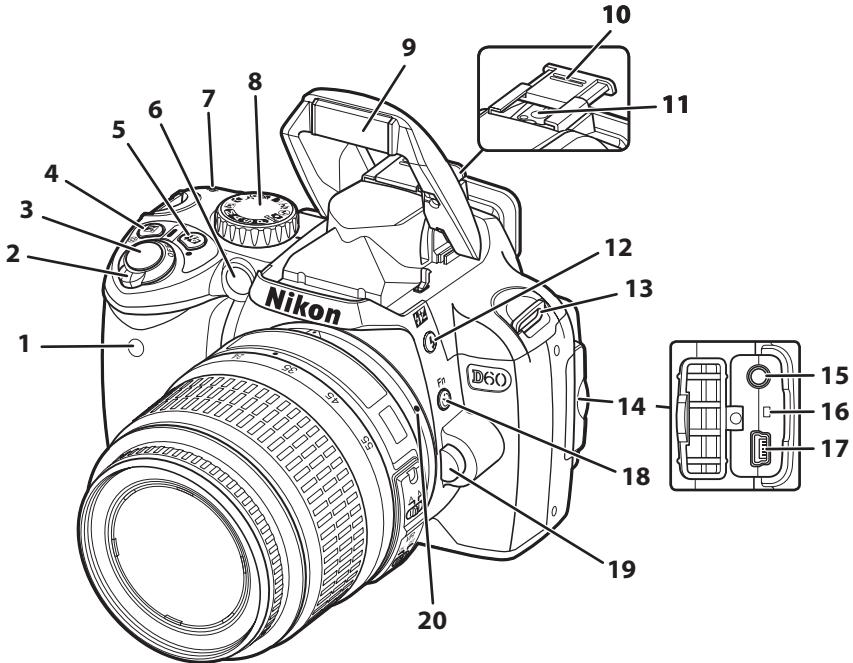

1	Infrared receiver	56	10	Accessory shoe cover	150
2	Power switch	6	11	Accessory shoe (for optional flash unit)	150
3	Shutter-release button	13	12	⚡ (flash mode) button	64
4	☒ (exposure compensation) button	67	13	⚡☒ (flash compensation) button	68
4	⊗ (aperture) button	44	13	Eyelet for camera strap	14
	Flash compensation button	68	14	Connector cover	81, 85, 92
5	⚡+ (Active D-Lighting) button	69	15	Video connector	92
5	● (reset) button	70	16	Reset switch	167
6	AF-assist illuminator	57	17	USB connector	81, 85
6	Self-timer lamp	56	18	⌚ (self-timer) button	54, 55
6	Red-eye reduction lamp	65	18	Fn FUNC. button	112
7	Focal plane mark	61	19	⏏ Lens release button	19
8	Mode dial	6	20	⏏ Lens mounting index	18
9	Built-in flash	64			

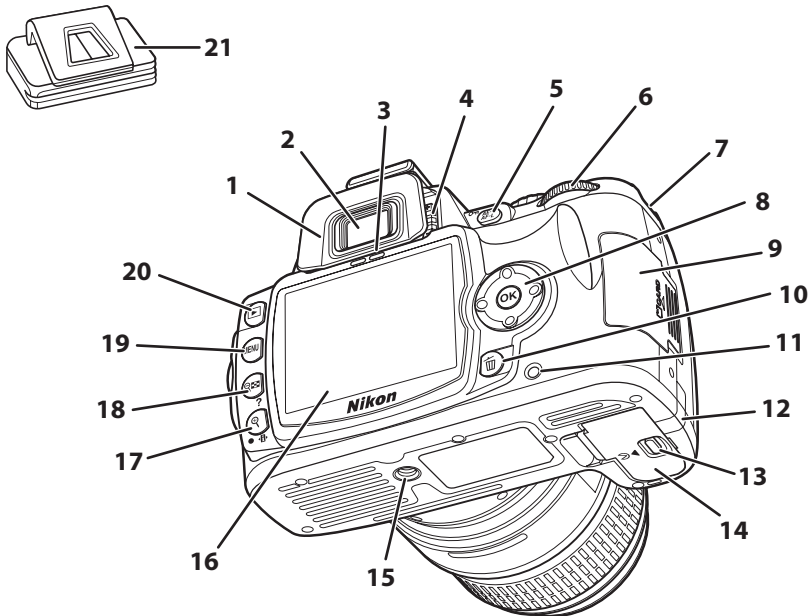

1	Rubber Eyecup DK-20.....	56	13	Battery-chamber cover latch.....	17
2	Viewfinder eyepiece.....	7, 26	14	Battery-chamber cover.....	17, 157
3	Eye sensor.....	32, 123	15	Tripod socket	
4	Diopter adjustment control.....	26	16	Monitor.....	8, 72, 123
5	AE-L AF-L (AE-L/AF-L) button.....	63, 113		(playback zoom in) button.....	77
	(protect) button.....	78	17	(Information display/Quick settings display) button.....	48
6	Command dial.....	10		(reset) button.....	70
7	Eyelet for camera strap.....	14		(thumbnail/playback zoom out) button.....	76
8	Multi selector.....	12	18	(help) button.....	13
9	Memory card slot cover.....	23	19	MENU (menu) button.....	94
10	(delete) button.....	34, 96	20	(playback) button.....	34, 72
11	Memory card access lamp.....	23	21	Eyepiece Cap DK-5.....	56
12	Power connector cover for optional power connector.....	157			

The Mode Dial

Use the mode dial to change the shooting mode. Rotate the mode dial so that the shooting mode icon is aligned with the indicator.

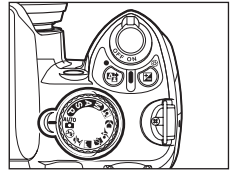

Advanced Modes (Exposure Modes)

Select these modes for full control over camera settings.

- | | |
|--|---|
| P — Programmed auto:  41 | A — Aperture-priority auto:  43 |
| S — Shutter-priority auto:  42 | M — Manual:  44 |

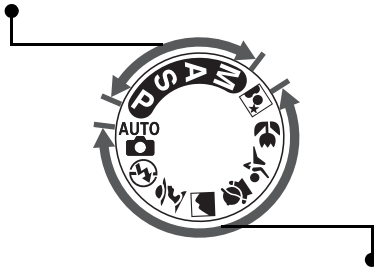

Point-and-Shoot Modes (Digital Vari-Programs)

Selecting a Digital Vari-Program automatically optimizes settings to suit the selected scene, making creative photography as simple as rotating the mode dial.

- | | |
|---|---|
|  — Auto:  28 |  — Child:  37 |
|  — Auto (flash off):  36 |  — Sports:  37 |
|  — Portrait:  36 |  — Close up:  37 |
|  — Landscape:  37 |  — Night portrait:  37 |

The Power Switch

The power switch is used to turn the camera on and off.

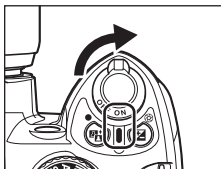

On

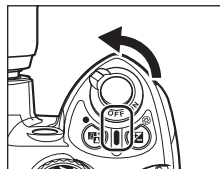

Off

The Viewfinder Display

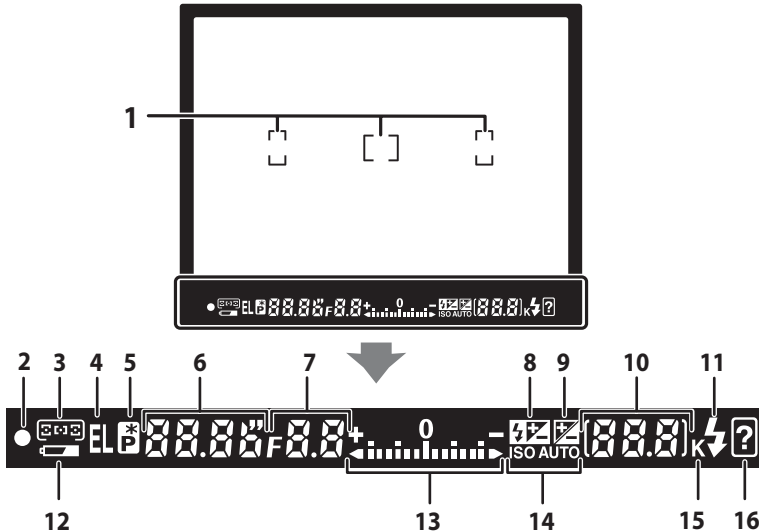
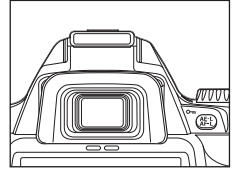

Actual display varies with current shooting mode and camera settings.

1	Focus points.....26, 30, 58, 59, 60	10	Number of exposures remaining..... 28, 178
2	Focus indicator..... 32, 61		Number of shots remaining before memory buffer fills..... 55, 178
3	Focus point display.....26, 30, 58, 59, 60		Preset white balance recording indicator..... 106
4	AF-area mode..... 58		10 Exposure compensation value.....67
5	Autoexposure (AE) lock.....63		Flash compensation value68
6	Shutter speed.....39–46		Active D-Lighting indicator69
7	Aperture (f-number).....39–46		PC connection indicator.....82
	Noise reduction indicator..... 108		Dust off ref photo mode indicator..... 127
8	Flash compensation indicator.....68, 113	11	Flash-ready indicator 33
9	Exposure compensation indicator.....67	12	Battery indicator 29
			Electronic analog exposure display45
		13	Exposure compensation.....67
			Rangefinder 116
		14	ISO auto indicator 53, 112
		15	"K" (appears when memory remains for over 1000 exposures) 29
		16	Warning indicator..... 13, 172

The Viewfinder

The response time and brightness of the viewfinder may vary with temperature. This is normal and does not indicate a malfunction.

The Shooting Information Display

When the camera is turned on, the Shooting information display will be shown in the monitor. Shooting information such as shutter speed, aperture, and number of exposures remaining, as well as the settings currently applied, can be confirmed.

The display changes, in the following order, each time  () is pressed:

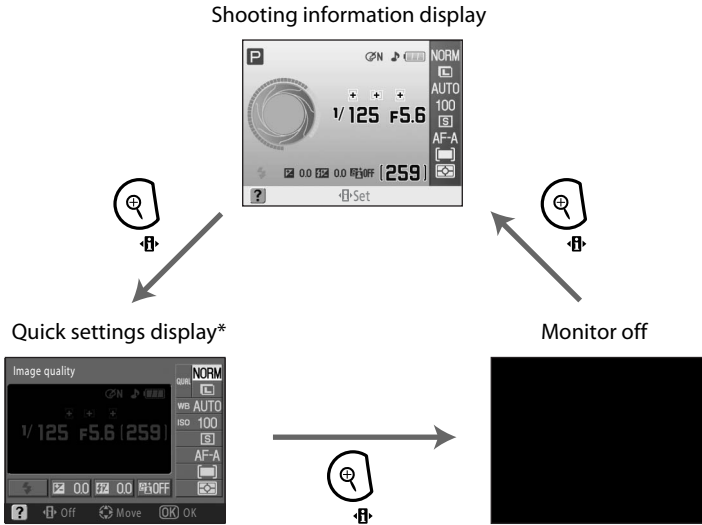
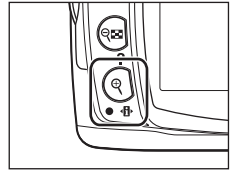

















* Frequently used shooting settings can be adjusted from the Quick settings display ( 48).

Tuning on and off Shooting Information Display

At default settings, shooting information also turns off as indicated below.

- When no operations are performed for about eight seconds.
- When the eye sensor is activated by looking through the viewfinder ( 31, 123).
- While the shutter-release button is held down.

When the Shooting information display is off, the Shooting information display is also shown as indicated below.

- When pressing halfway and releasing the shutter-release button ( 31).
- When  or  is pressed.
- When /Fn is pressed, unless **White balance** is selected for Custom setting 11 (/Fn button;  112) in , , , , , , or  mode.
- When  is pressed in any mode other than  Auto (flash off) mode.
- When  is pressed in **P**, **S**, or **A** mode.

Information Display Format

The format for information display is selected from the **Info display format** option ( 120) in the setup menu.

“Wide” (Landscape) Orientation

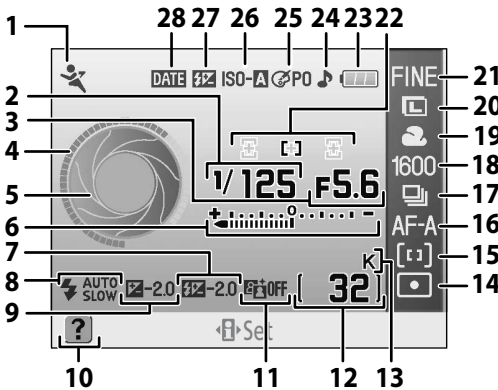

“Tall” (Portrait) Orientation

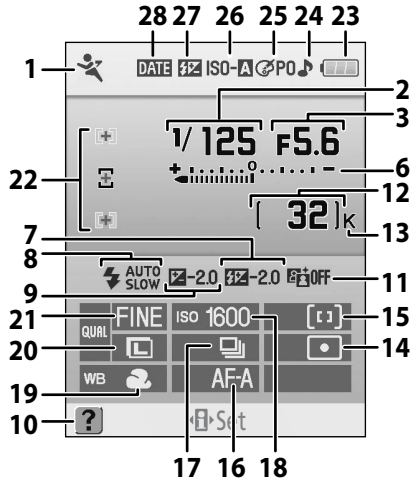

The information displayed in the monitor varies depending upon shooting mode and shooting conditions. The information included above may vary with current camera settings.

1	Shooting mode	6	15	AF-area mode	58
2	Shutter speed	40–46	16	Focus mode	57
3	Aperture (f-number)	40–46	17	Release mode	54
4	Shutter-speed display		18	ISO sensitivity	53
5	Aperture display		19	White balance mode	52, 103, 104
6	Electronic analog exposure display	45	20	Image size	50
7	Exposure compensation	67	21	Image quality	50
8	Flash compensation value	68	22	Focus point display	26, 30, 58, 59, 60
9	Flash sync mode	65	23	AF-area mode	58
10	Exposure compensation value	67	24	Battery indicator	29
11	Help indicator	13	25	“Beep” indicator	110
12	Active D-Lighting indicator	69	26	Optimize image indicator	101
13	Number of exposures remaining	28, 178	27	ISO auto indicator	53, 112
14	Preset white balance recording indicator	106	28	Manual flash control indicator	113
	Capture mode indicator	82		Flash compensation indicator for optional Speedlight	153
	“K” (appears when memory remains for over 1000 exposures)	29		Date imprint indicator	115
	Metering mode	62			

The Shutter-Speed and Aperture Displays

These displays provide a visual indication of shutter speed and aperture.



Fast shutter speed, large aperture
(small f-number)

























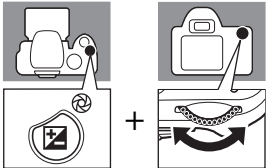
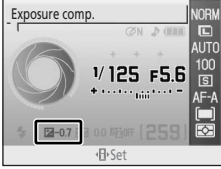







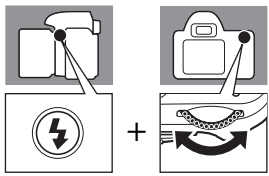

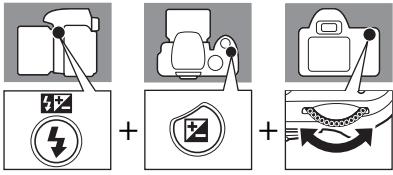
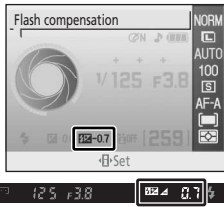

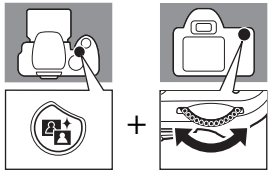

Slow shutter speed, small aperture
(large f-number)

Graphic displays of the shutter speed and aperture are shown when the mode dial is rotated.
Download from www.Somanuals.com. All Manuals Search And Download.

The Command Dial

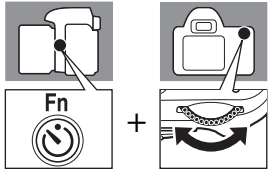
Rotate the command dial alone or use the command dial with other buttons to adjust the following settings. Changes to shooting settings can be viewed in the viewfinder and the monitor's Shooting information display as settings are adjusted.

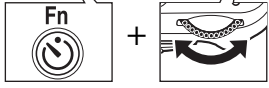
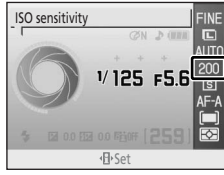
Function	Operation	Display
Flexible program (P mode;  41)		 
Choose a shutter speed (S and M modes;  42, 44).		 
Set aperture (A mode;  43).		 
Set aperture (M mode;  44).		 
Set exposure compensation (P , S , and A modes;  67).		 

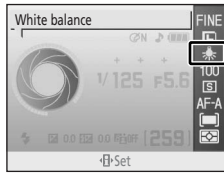
<p>Choose a flash mode (AUTO, , , , , P, S, A and M modes;  65).</p>		
<p>Set flash compensation (P, S, A and M modes;  68).</p>		
<p>Active D-Lighting ( 69)</p>		
<p>Release mode ( 54) (Set to single frame, continuous, self-timer, delayed remote, or quick-response remote mode.)</p>	<p>When /Fn (Custom Setting 11 /Fn button;  112) is set to any of the options indicated at right, the setting can be changed using the command dial.</p>	
<p>Image quality/size ( 49)</p>		
<p>ISO sensitivity ( 53)</p>		
<p>White balance ( 52)</p>		

Multi Selector

The multi selector is used for the following operations.

With Shooting

(Only when the dynamic area or single point option is selected for AF-area mode;  58)

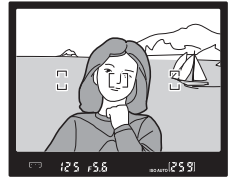
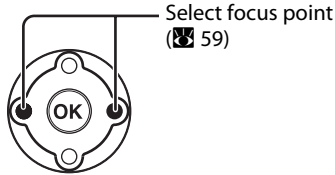

With Quick Settings Display

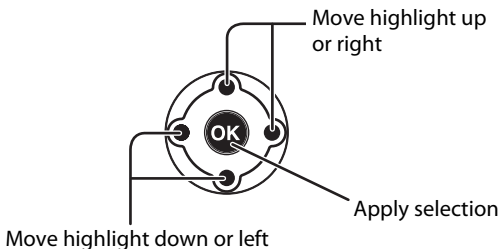

With Menu Screens

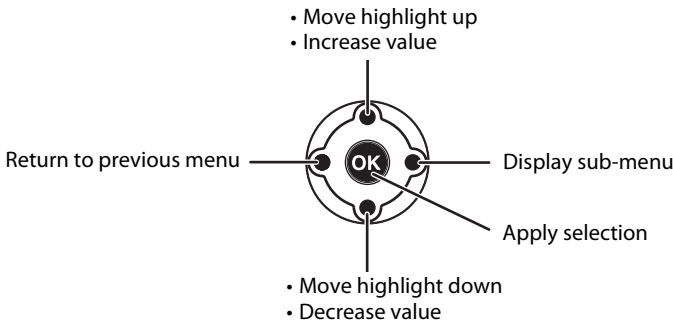

With Playback

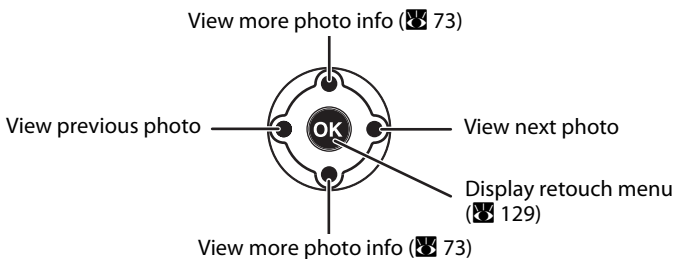



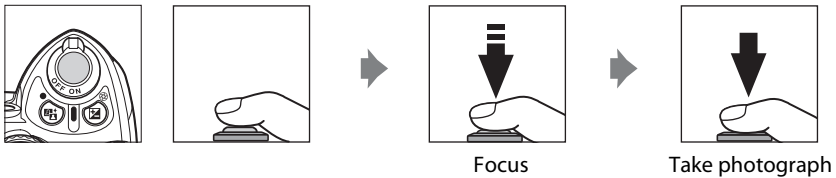

The Shutter-Release Button

The camera is equipped with a two-stage shutter-release button. To focus, press the shutter-release button halfway, stopping when you feel resistance. Focus will lock* while the shutter-release button is held in this position. To release the shutter and shoot, press the shutter-release button the rest of the way down.

* Focus will not lock, nor will the beep indicating that the subject is in focus sound, if **Focus mode** (M 57) is set to **Continuous-servo AF**, or if **Continuous-servo AF** is automatically applied with **Auto-servo AF** selected for moving subjects.



? (Help) Button

While  (?) is held down, information on current shooting conditions, and help for menus, are displayed in the monitor; to scroll the display, press the multi selector up or down. A blinking  icon in the monitor or a blinking  (warning indicator) in the viewfinder indicates that help on an error or other problem can be viewed in the monitor by pressing  (?).

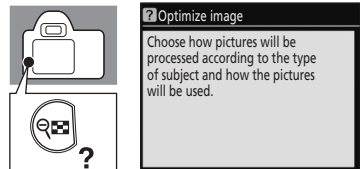

The Camera Strap AN-DC1

Attach the camera strap as shown below (two eyelets).

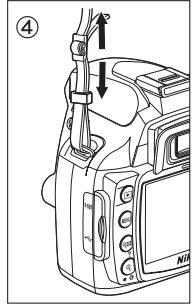
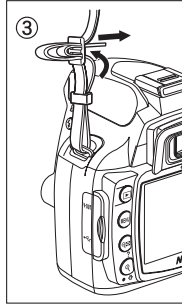
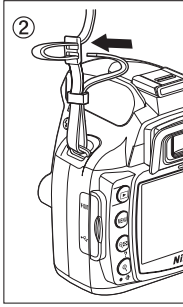
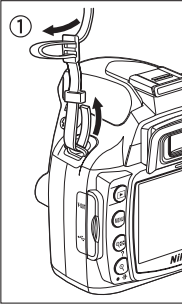

First Steps

This chapter explains the procedures necessary to prepare for shooting, including charging and inserting the battery, instructions for mounting lenses, setting the date and time, using memory cards.

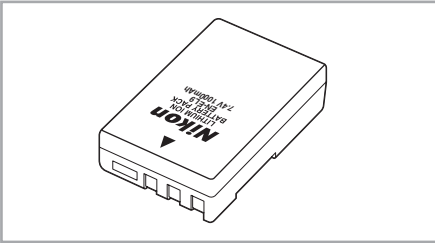

 16

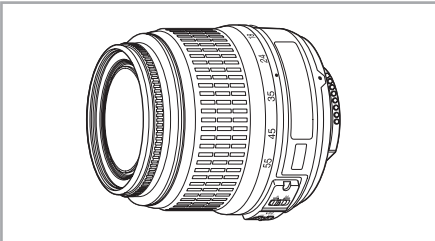

 18

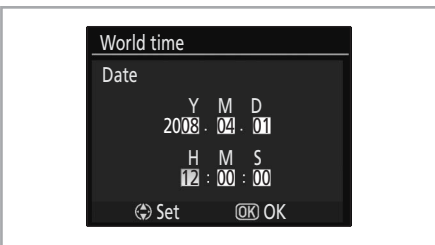

 21

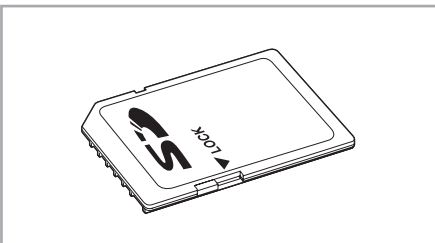

 23

Charging and Inserting the Battery

Use the supplied Quick Charger MH-23 to charge the supplied Rechargeable Li-ion Battery EN-EL9 before first use, or when the battery runs low.

The Quick Charger MH-23

The MH-23 is for use with the supplied Rechargeable Li-ion Battery EN-EL9.

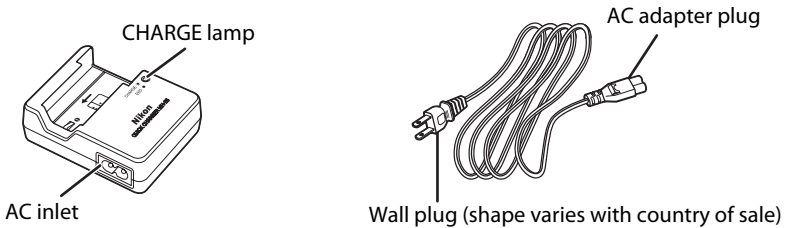

The Rechargeable Li-ion Battery EN-EL9

The EN-EL9 is for use with the D60.

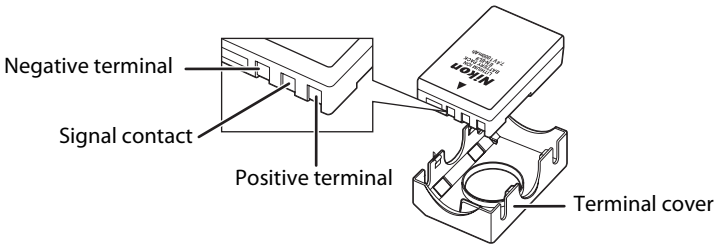

1 Charge the battery.

1.1 Remove the terminal cover from the battery.

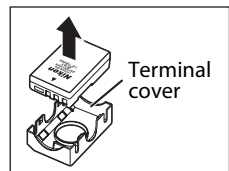

1.2 Connect the power cord to the charger and plug it in.

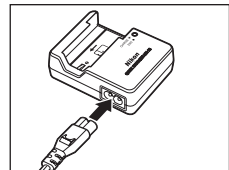

1.3 Place the battery in the charger. The **CHARGE** lamp will blink as the battery charges. About 90 minutes are required for an exhausted battery to fully charge.

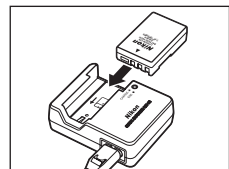

- 1.4** Charging is complete when the **CHARGE** lamp stops blinking.
Remove the battery from the charger and unplug the charger.

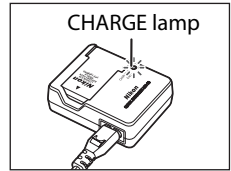

2 Insert the battery.

- 2.1** After confirming that the power switch is in the off position, open the battery chamber cover.

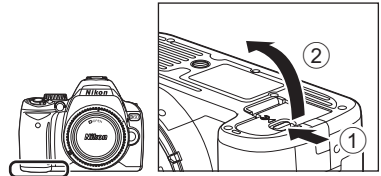

- 2.2** Insert a fully charged battery as shown at right. Close the battery chamber cover.

Be sure that the battery contacts are facing down.

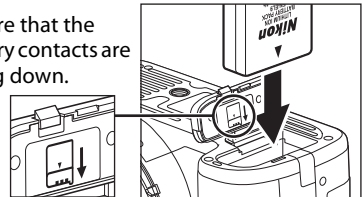

✓ Removing the Battery

Turn the camera off and confirm that the memory card access lamp is off before removing the battery.

✓ The Battery and Charger

- Read and follow the warnings and cautions on pages ii–iii and 164–166 of this manual, together with any warnings and instructions provided by the battery manufacturer.
- Do not use the battery at ambient temperatures below 0 °C (32 °F) or above 40 °C (104 °F). During charging, the temperature should be in the vicinity of 5–35 °C (41–95 °F). For best results, charge the battery at temperatures above 20 °C (68 °F). Battery capacity may drop if the battery is charged or used at lower temperatures.
- The battery may be hot immediately after use. If so, wait for the battery to cool down before charging.
- Replace the supplied terminal cover after removing the battery from the camera or the quick charger to avoid shorting the battery.
- Unplug the quick charger when it is not in use.

Attaching a Lens

Care should be taken to prevent dust from entering the camera when exchanging lenses.

- 1 Turn the camera off and remove the body cap.

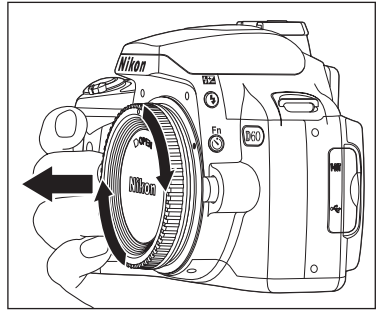

Remove the rear lens cap from the lens.

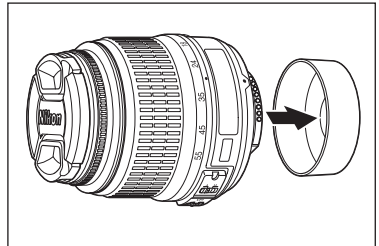

- 2 Keeping the mounting index on the lens aligned with the mounting index on the camera body, position the lens in the camera's bayonet mount and rotate the lens in the direction shown until it clicks into place.

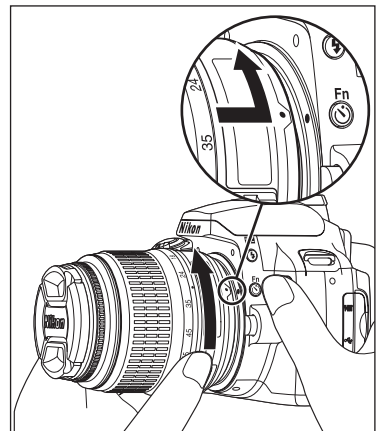

If the lens is equipped with an A-M or M/A-M switch, select A (autofocus) or M/A (autofocus with manual priority).



Lenses for Autofocus

Autofocus with this camera is supported only by AF-S and AF-I lenses. AF-S and AF-I lenses are equipped with an autofocus motor. Autofocus is not possible when any other type of lens is mounted, regardless of the autofocus capabilities of the lens itself.

Lens

An AF-S DX NIKKOR 18-55mm f/3.5-5.6G VR lens ( 185) is used in this manual for illustrative purposes. The AF-S DX Zoom NIKKOR 18-55mm f/3.5-5.6G ED II lens can be used in the same manner, but it is not equipped with the vibration reduction (VR) function. When using the other lenses, refer to the *User's Manual* provided with the lens.

1	Lens cap	
2	Focus ring	61
3	Zoom ring	30
4	Vibration reduction ON/OFF switch*	20
5	A-M mode switch	18, 61
6	CPU contacts	62
7	Rear lens cap	
8	Focal length scale	
9	Focal length scale index	
10	Mounting index	18

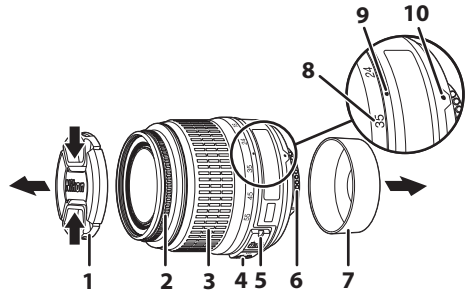

* The AF-S DX Zoom NIKKOR 18-55mm f/3.5-5.6G ED II lens is not equipped with vibration reduction ON/OFF switch.

Aperture Ring

If the lens is equipped with an aperture ring, lock aperture at the minimum setting (highest f-number). Refer to the *User's Manual* provided with the lens for details.

Detaching Lenses

Be sure the camera is off when removing or exchanging lenses. To remove the lens, press and hold the lens-release button (①) while turning the lens clockwise (②). After removing the lens, replace the camera body cap and rear lens cap.

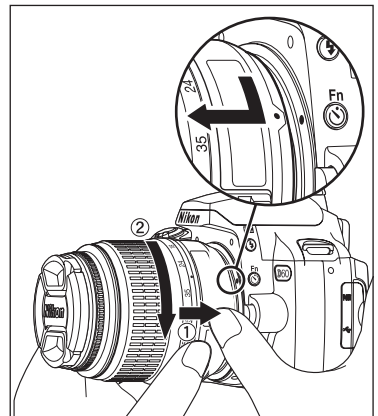

Vibration Reduction Mode (VR)

An AF-S DX NIKKOR 18-55mm f/3.5-5.6G VR lens is equipped with vibration reduction (VR) function.

Enabling vibration reduction (VR) allows for shooting at shutter speeds approximately three stops* slower (at a focal length of 55mm) than when vibration reduction is disabled. Panning is also supported.



* Based on results achieved under Nikon measurement conditions. The effects of vibration reduction may vary depending on individual and shooting conditions.

- Set the vibration reduction ON/OFF switch to **ON** to turn the vibration reduction on.
- Camera shake is reduced when the shutter-release button is pressed halfway. Autofocus and manual focusing, as well as precise framing of the subject, are simplified because camera shake visible through the viewfinder is also reduced.
- To disable vibration reduction, set the vibration reduction ON/OFF switch to **OFF**.

✓ Using Vibration Reduction

- If the camera is panned in a wide arc, compensation for camera shake in the panning direction is not performed. For example, with horizontal panning only vertical camera shake is reduced, making smooth pans much easier.
- Due to the characteristics of the vibration reduction mechanism, the image in the viewfinder may be blurred after the shutter is released. This is not a malfunction.
- Do not turn the camera off or remove the lens from the camera while vibration reduction is operating. Failure to observe this note could result in the lens sounding and feeling as if an internal component is loose or broken when it is shaken. This is not a malfunction. Turn the camera on again to correct this. Vibration reduction does not function while the built-in flash is charging.
- When the camera is mounted on a tripod, set the vibration reduction ON/OFF switch to **OFF**. However, set the switch to **ON** when using a tripod without securing the tripod head, or when using a monopod.

📷 Picture Angle and Focal Length

The size of the area exposed by a 35mm camera is 36×24 mm. The size of the area exposed by the D60, in contrast, is 23.6×15.8 mm, meaning that the picture angle of a 35mm camera is approximately 1.5 times that of the D60. The approximate focal length of lenses for the D60 in 35mm format can be calculated by multiplying the focal length of the lens by about 1.5 (for example, the effective focal length of a 24mm lens in 35mm format would be 36mm when mounted on the D60).

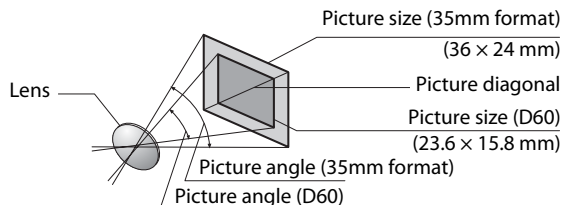

Setting Display Language, Date and Time

The first time the camera is turned on, the language selection dialog shown in step 1 will be displayed in the monitor. Follow the steps below to choose a language and set the time and date. No photographs can be taken until the camera clock has been set.

1 Turn camera on.

Language selection dialog is displayed.

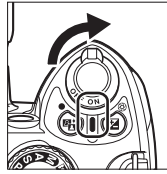

2 Select language.

Map of world time zones will be displayed.

UTC field shows time difference between selected time zone and Coordinated Universal Time (UTC), in hours.

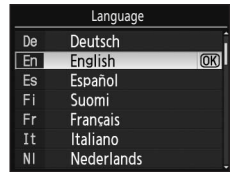

3 Select local time zone.

Daylight saving time options will be displayed.



4 Highlight On if daylight saving time is in effect.

Date menu is displayed.

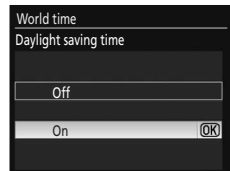

5 Press the multi selector left or right to select item, up or down to change.

To complete the settings, press **OK**.

When the settings are applied, display will return to shooting mode and shooting information will be shown.

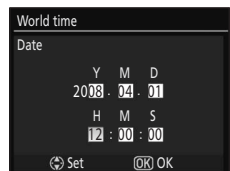

Reset the Clock

Use the **World time** option in the setup menu to reset the camera clock.

1 Turn the camera on and press **MENU**.

Menu screen is displayed in the monitor. If menu item is already highlighted, press the multi selector left to highlight icon for current menu in yellow.

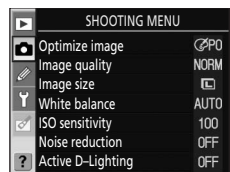
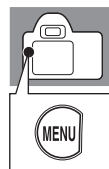

2 Highlight and press the multi selector right to highlight **World time**.

World time screen is displayed.

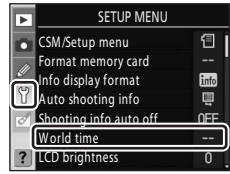

3 Highlight **Time zone**, **Date**, **Date format**, or **Daylight saving time**.

Press the multi selector right to proceed to the next set of options.

Monitor display returns to the world time screen each time date and time settings are applied.

When using the daylight saving time option, turn

Daylight saving time on before applying other date and time settings.

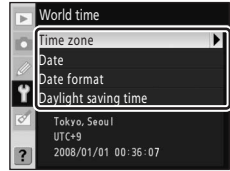

Time zone

Choose the time zone. The camera clock will automatically be reset to the time in the selected zone. See step 3 of the section, "Setting Display Language, Date and Time" (121).



Date

Set the camera clock. See step 5 of the section, "Setting Display Language, Date and Time" (121). Reset the clock regularly for accurate time keeping.

Date format

Choose the order in which the month, day, and year are displayed and press **OK**.

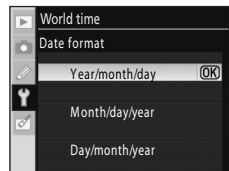

Daylight saving time

Turn **Daylight saving time** on when daylight saving time begins to automatically advance the camera's clock one hour. Turn **Daylight saving time** off (default setting) when daylight saving time ends.

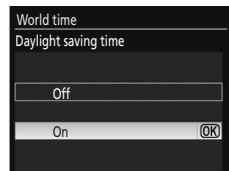

The Clock Battery

The camera clock is powered by the clock battery. The clock battery charges when the main battery is inserted, or the optional AC Adapter EH-5a with Power Connector EP-5 (156) is connected, and can provide a month of backup power after about three days of charging. When the message, **Clock not set**, is displayed in the monitor, the camera clock has been initialized and the shooting date and time will not be recorded correctly. Set the time and date again.

Changing Display Language

The language menu is only displayed automatically the first time the camera is turned on. To change the display language, use the **Language** option (123) in the setup menu (117).

Inserting Memory Cards

The camera records photographs on Secure Digital (SD) memory cards (available separately). See "Approved Memory Cards" (📖 158) for details.

Inserting Memory Cards

- 1 Before inserting or removing memory cards, *turn the camera off* and open the memory card slot cover.

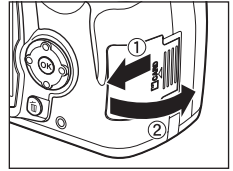

- 2 Slide the memory card in as shown at right until it clicks into place.

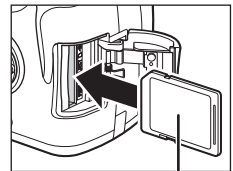

Front

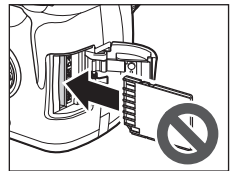

The memory card access lamp will light for about a few seconds. Close the memory card slot cover.

If a particular memory card will be used with this camera for the first time, proceed to "Formatting Memory Cards" (📖 24).

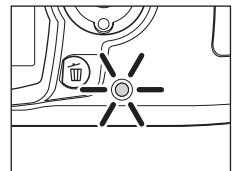

Removing Memory Cards

Confirm that the access lamp is off.

Turn the camera off and open the memory card slot cover.

Press the card in to partially eject (①). The card can then be removed by hand (②).

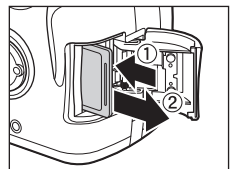

Formatting Memory Cards

Memory cards must be formatted in the camera before first use. **Note that formatting memory cards permanently deletes all photographs and other data they may contain.** Be sure all data you wish to keep have been copied to another storage device before formatting the card.

1 Turn camera on.

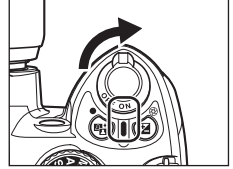

2 Display menus.

If menu item is already highlighted, press the multi selector left to highlight icon for current menu in yellow.

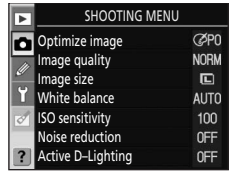
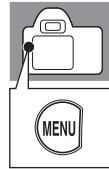

3 Highlight .



4 Position cursor in setup menu.

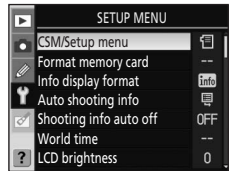

5 Highlight **Format memory card**.



6 Display options.

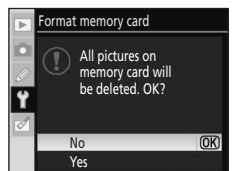

7 Highlight Yes.

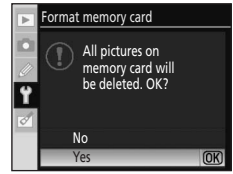

8 Format card. Do not turn camera off or open the battery-chamber cover or memory card slot cover until formatting is complete and setup menu is displayed.

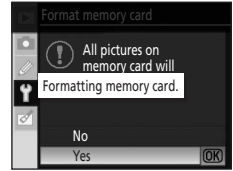

✓ Memory Cards

- Format memory cards in the camera before first use.
- Do not perform the following during formatting, while data is being written to or deleted from the memory card, or during data transfer to a computer. Failure to observe this precaution could result in the loss of data or in damage to the camera or memory card:
 - Take out the battery or memory card
 - Turn off the camera
 - Disconnect the AC adapter
- Do not touch the card terminals with your fingers or metal objects.
- Do not apply force to the card casing. Failure to observe this precaution could damage the card.
- Do not bend, drop, or subject to strong physical shocks.
- Do not expose to heat, water, high levels of humidity, or direct sunlight.

✓ Formatting Memory Cards

Use the camera **Format memory card** option to format memory cards. Performance may drop if cards are formatted in a computer.

🔍 The Write Protect Switch

Memory cards are equipped with a write protect switch to prevent accidental loss of data. When this switch is in the "LOCK" position, photos cannot be recorded or deleted and the memory card cannot be formatted.

Unlock by sliding the switch to the "write" position.

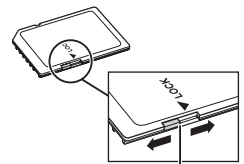

Write-protect switch

Adjusting Viewfinder Focus (Diopter Adjustment)

Photographs are framed in the viewfinder. Before shooting, make sure that the display in the viewfinder is in clear focus. The viewfinder can be focused by removing the lens cap and sliding the diopter adjustment control up and down until the focus points are in sharp focus. When operating the diopter adjustment control with your eye to the viewfinder, be careful not to put your fingers or fingernails in your eye.

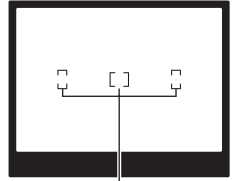
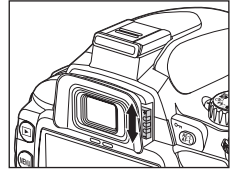

Focus points

"Point-and-Shoot" Photography ((Auto) Mode)

This section uses shooting in  (auto) mode to explain basic procedures.

 (auto) mode is an automatic "point-and-shoot" mode in which the majority of settings are controlled by the camera in response to shooting conditions.

Step 1 Turn the Camera On and Select Shooting Mode

1 Turn the camera on.

Remove the lens cap and turn the camera on.

The image sensor cleaning in progress screen will be displayed, and then shooting information will be displayed in the monitor.

Looking through the viewfinder turns the monitor off and the viewfinder display will light.

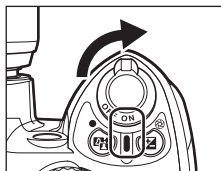

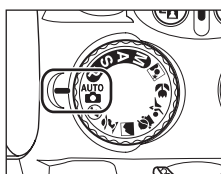

2 Rotate the Mode Dial to (Auto) Mode.

The camera enters  (auto) mode.



3 Check the battery level.

Check the battery level in the Shooting information display in the monitor ( 29).

If the monitor is off, press  () to display shooting information again.

When the battery is exhausted, the shooting information cannot be displayed. Charge or replace the battery.



4 Check the number of exposures remaining.

The number of photographs that can be recorded on the memory card is shown in the Shooting information display or viewfinder.

If there is not enough memory to store additional photographs at current settings, the display will flash as shown at right. No further photographs can be taken until the memory card has been replaced or photographs have been deleted ( 34, 96).

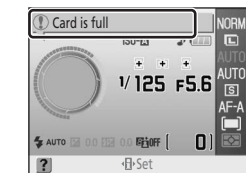
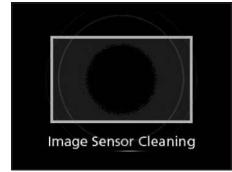







Image Sensor Cleaning

Each time the camera is turned on or off, the function that removes dirt or dust from the low-pass filter, which protects the image sensor, is activated (🔑 162). Choose whether cleaning is performed automatically when the camera is turned on or off from the **Clean image sensor** option in the setup menu (🔑 126).



Battery Level

Monitor	Viewfinder	Description
	—	Battery fully charged.
	—	Battery partially discharged.
		Low battery. Prepare to charge or replace battery.
 (blinks)	 (blinks)	Shutter release disabled. Charge or replace battery.

Large-Capacity Memory Cards

When enough space remains on the memory card to record a thousand or more photographs at the current settings, the number of exposures remaining will be displayed in units of thousands rounded down to the nearest hundred, with “K” displayed above the number. For example, if 1,160 shots are possible, the number of exposures remaining will show “K 1.1.”



Image Quality and Image Size

At default settings, **Image quality** is set to **JPEG normal**, and **Image size** is set to Large. These settings can be changed to suit intent (🔑 49) and the amount of space remaining on the memory card (🔑 49).



Step 2 Frame a Photograph

1 Hold the camera as shown.

Holding the Camera

Hold the handgrip in your right hand and cradle the camera body or lens with your left. Keep your elbows propped lightly against your torso for support and place one foot half a pace ahead of the other to keep your upper body stable.



2 Frame a photograph in the viewfinder.

When looking through the viewfinder, the monitor will turn off and the viewfinder display will turn on.

Photographs cannot be framed using the monitor.

Shooting information such as shutter speed, aperture, and number of exposures remaining can be confirmed in the viewfinder. When the viewfinder display turns off, press the shutter-release button halfway to reactivate the display.

Position the main subject inside any of the three focus points, within which the camera focuses.

Focus point

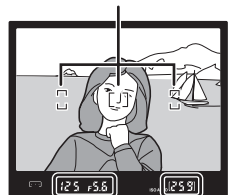

Using a Zoom Lens

Use the zoom ring to zoom in on the subject so that it fills a larger area of the frame, or zoom out to increase the area visible in the final photograph (select longer focal lengths to zoom in, shorter focal lengths to zoom out).

Zoom in

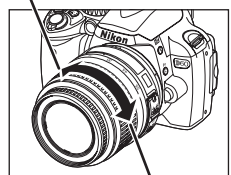

Zoom out

Dioptr Adjustment

For more information on adjusting viewfinder focus, see “Adjusting Viewfinder Focus (Dioptr Adjustment)” (📖 26).

Exposure Meters On/Off and Auto Meter-Off

This camera is equipped with exposure meters, which meter the brightness of the subject. Exposure meters are activated with the following situations:

- When the camera is turned on
- When the shutter-release button is pressed halfway while the camera is on
- When  (📖 1) is pressed while the camera is on

When exposure meters are on, the viewfinder display, or Shooting information display, will turn on, and shooting information such as shutter speed, aperture, and number of exposures remaining can be confirmed (📖 7, 9).

Exposure meters turn off automatically in conjunction with the **Auto meter-off** setting (📖 114). Auto meter-off is a function that reduces the drain on the battery. At default settings, exposure meters turn off if the shutter-release button is not pressed, even halfway, and no operations are performed for eight seconds. The length of time before exposure meters turn off can be adjusted using Custom Setting 15 (**Auto off timers**; 📖 114). Exposure meters are also active whenever the monitor is on with operations other than shooting, such as playback and when navigating camera menus (**Playback/menus**), or with image review immediately after a photograph is shot (**Image review**). However, exposure meters turn off when the monitor turns off, as specified with the auto off timers setting.

Shooting Info Auto Off

The eye sensor under the viewfinder is activated when your face comes closer to the viewfinder with shooting while the exposure meters are on, and turns the Shooting information display off (default setting) to reduce the drain on the battery. When the camera is lowered, or otherwise distanced from your face, the viewfinder display turns off and the Shooting information display turns on again. This option can be disabled using the **Shooting info auto off** option in the setup menu (📖 123). However, the Shooting information display will turn off when auto meter off is activated, regardless of the option selected for **Shooting info auto off**.

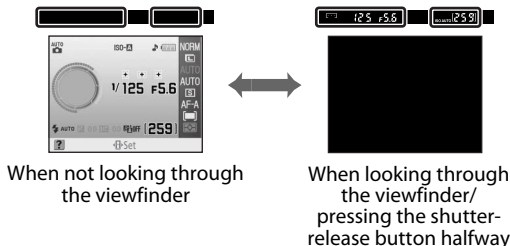

Step 3 Focus and Shoot

1 Press the shutter-release button halfway.

The camera will automatically select the focus point containing the main subject closest to the camera and focus on this subject.

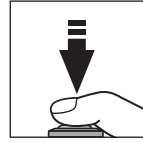

When the focus operation is complete, a beep will sound, and the in-focus indicator (●) will appear in the viewfinder. The selected focus point will be highlighted in red in the viewfinder.

If the in-focus indicator (●) in the viewfinder display blinks, the subject is not in focus. Recompose the shot and press the shutter-release button halfway to try focusing again.

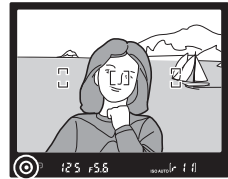

When shooting the subject with which autofocus does not perform well (📷 38), the camera may be unable to focus on the subject using autofocus. The number of exposures that can be recorded in the memory buffer (📷 55) is shown in the viewfinder display while the shutter-release button is pressed halfway. "r" is displayed in front of the number.

If the subject is dark, the AF-assist illuminator may light to assist the focus operation and the flash may pop up.

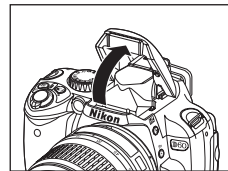
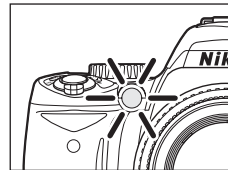

2 Smoothly press the shutter-release button the rest of the way down to release the shutter and record the photograph.

The memory card access lamp will light.

Do not open the memory card slot cover or battery-chamber cover, or remove or disconnect the power source until the memory card access lamp has gone out and recording is complete.

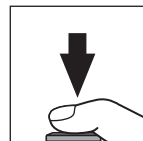

Photographs will be played back in the monitor for a few seconds after they are taken.

Press the shutter-release button halfway to immediately enable shooting, even when playing photographs back.

Rotate the power switch to turn the camera off when you have finished taking pictures.

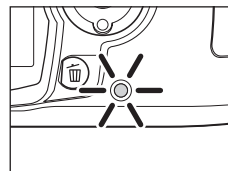

✎ Shutter-Release Button

For more information on the two-stage shutter-release button, see “The Shutter-Release Button” (📷 13).

✎ Beep

- When **Focus mode** (📷 57) is set to **Continuous-servo AF**, or if the subject is judged to be moving in **Auto-servo AF** (default setting) and **Continuous-servo AF** is automatically applied, a beep indicating that the subjects is in focus will not sound.
- This option can be disabled from Custom Setting 01 (**Beep**; 📷 110).

✎ The Built-in Flash

When shooting a dimly lit, or backlit, subject in 📷 (auto) mode, the built-in flash will pop up automatically when the shutter-release button is pressed halfway. When using the flash, remove the lens hood to prevent its shadow from appearing in photographs.

If the flash is required, picture can only be taken while the flash-ready indicator (📷) is displayed. If the flash-ready indicator is not displayed, the flash is charging and pictures cannot be taken even if the flash is up. Wait until 📷 is displayed. In 📷 (auto) mode with auto flash mode enabled, the flash will not fire, even if it has popped up automatically, if the subject is already sufficiently lit. Pictures can also be taken when 📷 is not displayed.

Select 📷 Auto (flash off) mode (📷 36) to prevent the flash from firing when lighting is poor.

For more information on using the flash, see “Using the Built-in Flash” (📷 64).

Flash range varies with aperture and ISO sensitivity (📷 179).

When the flash is not in use, return it to its closed position by pressing it gently downward until it clicks into place.

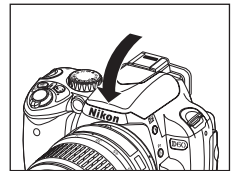

✎ Changing Shooting Settings

In addition to **Image quality** (📷 50) and **Image size** (📷 50), a variety of other shooting settings can be modified in 📷 (auto) mode, including the manners in which the shutter is released (**Release mode**; 📷 54), the manner in which the camera focuses (📷 57), **ISO sensitivity** (📷 53), and **Active D-Lighting** (📷 69).

📷 Image Review

Custom Setting 07 (**Image review**; 📷 111) can be set so that photographs are not automatically displayed in the monitor after they are taken.

Step 4 Viewing Photographs/Deleting Photographs

Viewing Photographs

While shooting information is displayed or the monitor is off after shooting, press  to display the most recent photograph in the monitor.

Additional photographs can be displayed by rotating the command dial or pressing the multi selector left or right.

Shooting information on the photograph currently displayed in the monitor can be viewed by pressing the multi selector up or down (, 35, 73).

To return to shooting mode, press the shutter-release button halfway, or press .

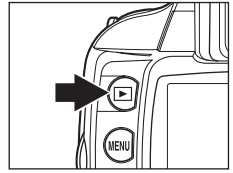



Deleting Photographs

Follow the procedure described below to delete unwanted photographs.

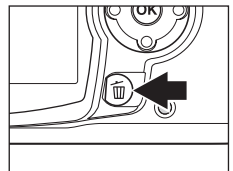

- 1 Press  to delete the photograph currently displayed in the monitor.



- 2 When the confirmation dialog is displayed, press  again to delete the image and return to playback. To exit without deleting the photograph, press .



📌 Full-Frame Playback

Option	Use	Description
Zoom in on photograph	🔍	Zoom in on current photograph (📷 77).
View thumbnails	🖼️	View multiple photographs (📷 76).
Retouch photograph	OK	Create retouched copy of current photograph (📷 129).
Exit to shooting mode	 or 	To return to shooting mode, press the shutter-release button halfway or press  .

📌 Displaying Photo Information

Press the multi selector up or down to change the display in the following order. Detailed information on the photograph can be viewed (📷 73).

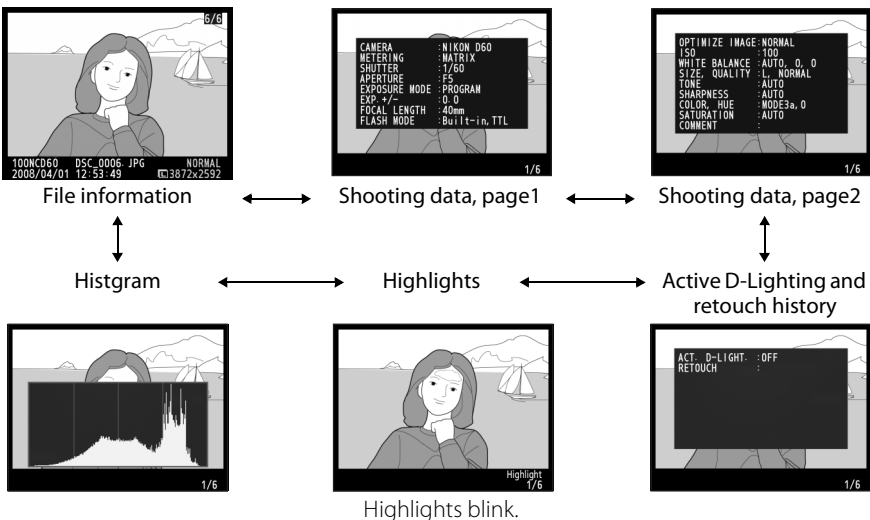

📌 Photograph Playback

- When photographs are automatically displayed in the monitor after they are taken, the battery level and number of exposures remaining is also clearly displayed.
- The length of time before the monitor automatically turns off can be modified from Custom Setting 15 (**Auto off timers**; 📷 114).









📌 Deleting Multiple Photographs

Multiple photographs can be deleted from the **Delete** option in the playback menu (📷 94, 96).

Shooting Particular Scenes

Digital Vari-Programs offer the following shooting modes, in addition to  (auto) mode. Selecting a program automatically optimizes settings to suit the selected scene, making creative photography as easy as rotating the mode dial.

Mode dial	Mode	Description
	Auto (flash off)	For pictures that do not use the flash.
	Portrait	For portraits.
	Landscape	For natural and man-made landscapes.
	Child	For pictures of children.
	Sports	For moving subjects.
	Close up	For close up shots of flowers, insects, and other small objects.
	Night portrait	For portraits shot under low light.

Taking Pictures

1 Rotate the mode dial to select a shooting mode.

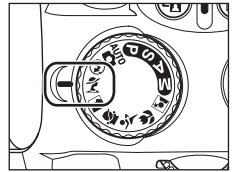

2 Frame a photograph in the viewfinder, focus, and shoot.

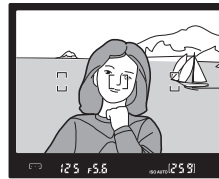

Features of , , , , , , and Modes

Auto (Flash Off)

The built-in flash turns off. Use where flash photography is prohibited, to photograph infants without using the flash, or to capture natural lighting under low light. The camera selects the focus point containing the closest main subject; the AF-assist illuminator will light to assist the focus operation when lighting is poor.



Portrait

Use for portraits with soft, natural-looking skin tones. The camera selects the focus point containing the closest main subject. If the subject is far from the background or a telephoto lens is used, background details will be softened to lend the composition a sense of depth.



 Landscape

Use for vivid landscape shots. The camera selects the focus point containing the closest main subject; the built-in flash and AF-assist illuminator turn off automatically.

 Child

Use for snapshots of children. Clothing and background details are vividly rendered while skin tones are given a soft, natural finish. The camera selects the focus point containing the closest main subject.

 Sports

High shutter speeds freeze motion for dynamic sports shots in which the main subject stands out clearly. The camera focuses continuously while the shutter-release button is pressed halfway, tracking the subject in the center focus point. If the subject leaves the center focus point, the camera will continue to focus based on information from the other focus points. The starting focus point can be selected by pressing the multi selector left or right (📷 59). The built-in flash and AF-assist illuminator turn off automatically.

 Close Up

Use for close-up shots of flowers, insects, and other small objects. The camera automatically focuses on the subject in the center focus point; a different focus point can be selected by pressing the multi selector left or right. Use of a tripod is recommended to prevent blur.

 Night Portrait

Use for a natural balance between the main subject and the background in portraits shot under low light. The camera selects the focus point containing the closest main subject. Use of a tripod is recommended to prevent blur.

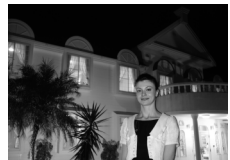
 The Built-in Flash

If additional lighting is required for correct exposure in 📷, 📷, 📷, or 📷 mode, the built-in flash will pop up automatically when the shutter-release button is pressed halfway, just as it does in 📷 (auto) mode (📷 64). The flash mode can be changed (📷 65).

Download from www.Somanuals.com. All Manuals Search And Download.

Getting Good Results with Autofocus

Autofocus does not perform well under the conditions listed below. The shutter release may be disabled if the camera is unable to focus under these conditions, or the in-focus indicator (●) may be displayed and the camera may sound a beep, allowing the shutter to be released even when the subject is not in focus. In these cases, use manual focus (M 61) or use focus lock (L 60) to focus on another subject at the same distance and then recompose the photograph.

There is little or no contrast between the subject and the background (e.g., the subject is the same color as the background).

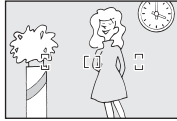

The focus point contains objects at different distances from the camera (e.g., the subject is inside a cage).



The subject is dominated by regular geometric patterns (e.g., a row of windows in a skyscraper).

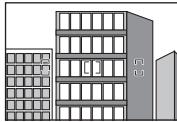

The focus point contains areas of sharply contrasting brightness (e.g., the subject is half in the shade).

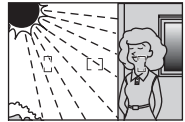

Background objects appear larger than the subject (e.g., focus point contains both foreground subject and distant buildings).



The subject contains many fine details (e.g., a field of flowers or other subjects that are small or lack variation in brightness).

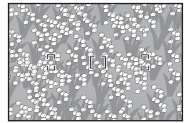

P, S, A, and M Modes

This chapter explains the procedures for shooting in Programmed auto (**P**) mode, Shutter-priority auto (**S**) mode, Aperture-priority auto (**A**) mode, and Manual (**M**) mode. These modes allow for manual adjustment of shutter speed and/or aperture settings, and offer control over a variety of advanced settings, including white balance (📷 52), metering (📷 62), flash compensation (📷 68), and exposure compensation (📷 67), which enables users to take photographs that reflect more of their own personal preferences than is possible with the Digital Vari-Programs.

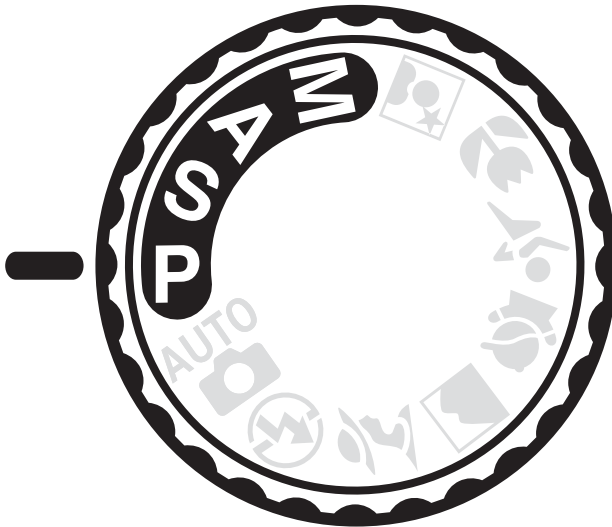

Shooting in P, S, A, and M Modes

P, S, A, and **M** modes offer a differing degrees of control over shutter speed and aperture. Choose the mode best suited to the situation.

Mode	Description
P Programmed auto (📷 41)	Camera sets shutter speed and aperture for optimal exposure. Recommended for snapshots and in other situations in which there is little time to adjust camera settings.
S Shutter-priority auto (📷 42)	User chooses shutter speed; camera selects aperture for best results. Use to freeze or blur motion.
A Aperture-priority auto (📷 43)	User chooses aperture; camera selects shutter speed for best results. Use to blur background or bring both foreground and background into focus.
M Manual (📷 44)	User controls both shutter speed and aperture. Set shutter speed to "bulb" for long time-exposures.

Shutter Speed and Aperture

The same exposure can be achieved with different combinations of shutter speed and aperture, allowing you to freeze or blur motion and control depth of field. The following figure shows how shutter speed and aperture affect exposure.

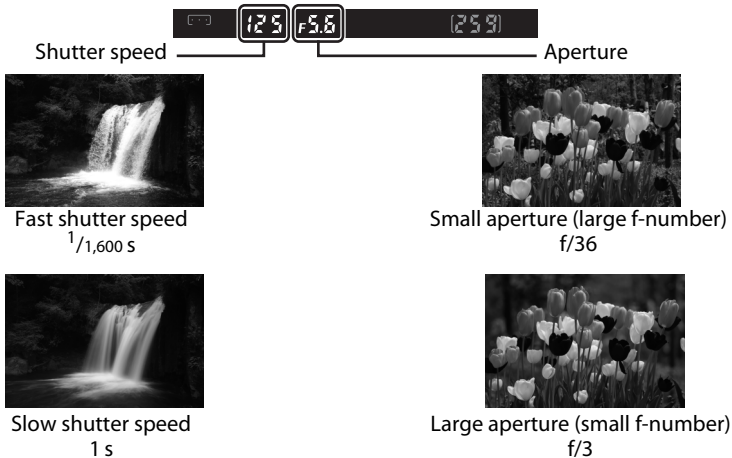

If the ISO sensitivity setting is changed (📷 53, 111), the range of shutter speed and aperture settings that will achieve optimal exposure also changes.

Lens Aperture Ring

When using a CPU lens equipped with an aperture ring, lock the aperture ring at the minimum aperture (highest f-number). Type G lenses are not equipped with an aperture ring. When a CPU lens is mounted, adjust the aperture from the camera.

Shooting in P Mode (Programmed Auto)

In this mode, the camera automatically adjusts shutter speed and aperture for optimal exposure in most situations. This mode is recommended for snapshots and other situations in which you want to leave the camera in charge of shutter speed and aperture.

1 Rotate the mode dial to **P**.

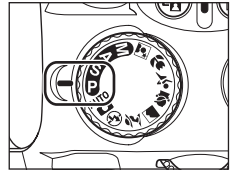

2 Frame a photograph, focus, and shoot.

Flexible Program

In **P** mode, different combinations of shutter speed and aperture can be selected by rotating the command dial (“flexible program”). While flexible program is in effect,  (**P***) indicators are shown in the viewfinder and Shooting information display.

Rotate the command dial to the right for large apertures (small f-numbers) that blur background details or fast shutter speeds that “freeze” motion. Rotate the command dial to the left for small apertures (large f-numbers) that increase depth of field or slow shutter speeds that blur motion. All combinations produce the same exposure. To restore default shutter speed and aperture settings, rotate the command dial



until the indicators are no longer displayed, choose another mode, or turn the camera off.

Download from www.Somanuals.com. All Manuals Search And Download.

Shooting in S Mode (Shutter-Priority Auto)

In shutter-priority auto mode, you choose the shutter speed while the camera automatically selects the aperture that will produce the optimal exposure. Use slow shutter speeds to suggest motion by blurring moving subjects, high shutter speeds to “freeze” motion (📷 40).

1 Rotate the mode dial to **S**.

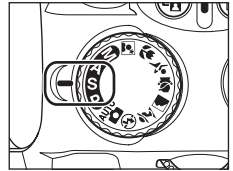

2 Rotate the command dial to choose the desired shutter speed.

Shutter speed displayed in the viewfinder will change. Set shutter speed to the desired value between $\frac{1}{4,000}$ s and 30 s.

Shutter speed can also be displayed in the Shooting information display by pressing (🔍) (📷).



3 Frame a photograph, focus, and shoot.

📷 Shutter Speed and Camera Shake

To reduce or prevent blur caused by camera shake, the shutter speed should be faster than the inverse of lens focal length in seconds. For example, when using a lens with a focal length of 300mm, choose a shutter speed faster than $\frac{1}{300}$ s. A tripod is recommended when shooting at slower shutter speeds. To reduce blur, try increasing shutter speed by increasing ISO sensitivity (📷 53), using the built-in flash (📷 64) or an optional Speedlight (📷 150), or by mounting the camera on a tripod, or using a vibration reduction (VR) lens (📷 20).

Shooting in A Mode (Aperture-Priority Auto)

In aperture-priority auto mode, you choose the aperture while the camera automatically selects the shutter speed that will produce the optimal exposure. Small apertures (high f-numbers) increase depth of field, bringing both the main subject and background into focus. Large apertures (low f-numbers) soften background details (📷 40).

1 Rotate the mode dial to **A**.

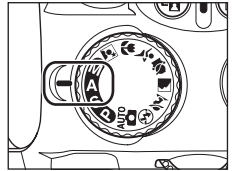

2 Rotate the command dial to choose the desired aperture.

Aperture displayed in the viewfinder will change. Set aperture to the desired value.

The minimum and maximum apertures available vary depending upon the lens.

Aperture can also be displayed in the Shooting information display by pressing  ().

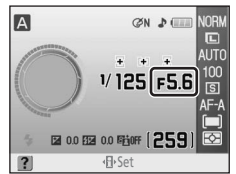

3 Frame a photograph, focus, and shoot.

Shooting in M Mode (Manual)

In manual exposure mode, you control both shutter speed and aperture. This mode can also be used for longer exposures, with which the shutter can be held open indefinitely ("Bulb" and "Time"; , necessary for shooting fireworks and stars.

1 Rotate the mode dial to M.

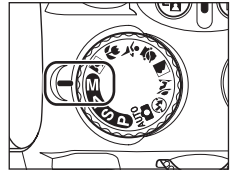



2 Watch the electronic analog exposure display () while rotating the command dial to set shutter speed and aperture.

Shutter speed displayed in the viewfinder will change as the command dial is rotated. Set shutter speed to the desired value between $\frac{1}{4,000}$ s and 30 s or "Bulb" ("bulb" is displayed in the viewfinder).

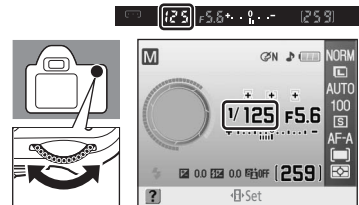
Shutter speed of "Bulb" is used for long time-exposure photographs (, 46).



Setting shutter speed

Aperture displayed in the viewfinder will change as the command dial is rotated while  () is pressed. Set aperture to the desired value.

The maximum and minimum apertures available vary depending upon the lens.

Adjust shutter speed and aperture settings as necessary to achieve the desired exposure.

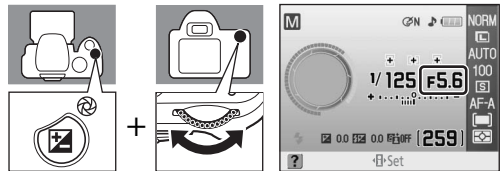





Setting aperture

Shutter speed and aperture can also be displayed in the Shooting information display by pressing  ().

3 Frame a photograph, focus, and shoot.

Electronic Analog Exposure Display

If a CPU lens ( 146) is attached and a shutter speed other than “Bulb” ( 46) is selected, the electronic analog exposure displays in the viewfinder and Shooting information display show whether the photograph would be under- or over-exposed at current settings. If the limits of the exposure metering system are exceeded, the displays will flash.

Display	Description
	Optimal exposure.
	If indicator is to right of 0, photograph will be underexposed. Display at left indicates that photograph will be underexposed by $\frac{1}{3}$ EV.
	If indicator is to left of 0, photograph will be overexposed. Display at left indicates that photograph will be overexposed by more than 2EV.

When **On** is selected for Custom Setting 10 (**ISO auto**;  111), ISO sensitivity is automatically adjusted to compensate for changes in aperture and shutter speed, with the result that changes to shutter speed and aperture will not affect the electronic analog exposure display.

Long Time-Exposures

Shutter speeds of “Bulb” and “Time” can be used for long time-exposure photographs of moving lights, the stars, night scenery, or fireworks. To prevent blurring caused by camera shake, use a tripod or an optional Wireless Remote Control ML-L3.

Bulb

Shutter remains open while the shutter-release button is held down, and closes when the shutter-release button is released.

This option is available when shooting in **M** mode at a shutter speed of “Bulb” (“bulb” is displayed in the viewfinder) (ⓧ 44).

Time

The optional Wireless Remote Control ML-L3 is required.

The shutter can remain open for up to 30 minutes without holding down the shutter-release button. Follow the instructions below to take pictures at a shutter speed of “Time”.

- 1 Set shutter speed to “Bulb” (“bulb” is displayed in the viewfinder) in **M** mode (ⓧ 44).
- 2 Set **Release mode** to **Delayed remote** or **Quick-response remote** (ⓧ 54).
 - “Time” will be displayed for shutter speed (“••” is displayed in the viewfinder).
- 3 Press the shutter-release button on the remote control.
 - Shutter opens immediately after, or two seconds after, the shutter-release button is pressed.
- 4 Press the shutter-release button on the remote control a second time to close the shutter.
 - Shutter closes automatically after 30 minutes has passed.



35 s, f/25

To prevent loss of power before the exposure is complete, use a fully charged battery or an optional AC Adapter EH-5a with a Power Connector EP-5 (ⓧ 156). Note that noise may be present in long exposures; before shooting, choose **On** for the **Noise reduction** option (ⓧ 108) in the shooting menu.

Changing Shooting Settings

This chapter explains the application and adjustment of camera functions, to suit shooting conditions and personal intent, using the Quick settings display. Note that some functions are not available in some shooting modes.

- Most of the functions explained in this chapter can be applied, or adjusted, from the shooting menu (📷 100) or Custom Settings (📷 109).

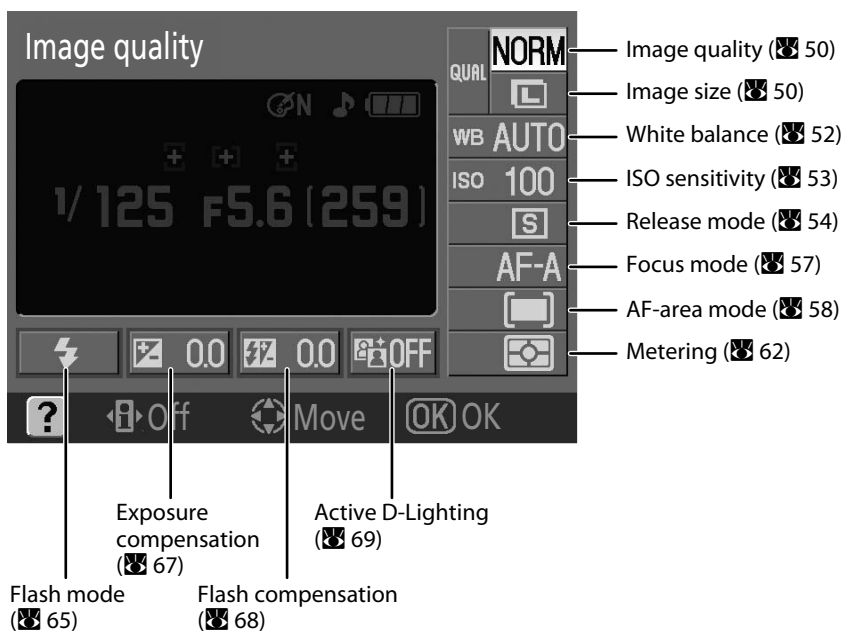

The Quick Settings Display

Switch the display in the monitor to the Quick settings display to change shooting settings.

When the Shooting information display (8) is shown, press (9) to switch to the Quick settings display.

Each time (9) is pressed, the display changes in the following order: Shooting information display → Quick settings display → monitor off → Shooting information display (8).

When playing photographs back, press to exit playback mode.

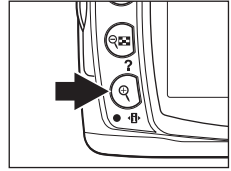

1 Image quality.....	50	7 AF-area mode.....	58
2 Image size.....	50	8 Metering.....	62
3 White balance.....	52	9 Flash mode.....	65
4 ISO sensitivity.....	53	10 Exposure comp.....	67
5 Release mode.....	54	11 Flash compensation.....	68
6 Focus mode.....	57	12 Active D-Lighting.....	69

Adjusting a Setting

1 Highlight desired setting.

Settings not available in current mode are grayed out and cannot be selected.



2 Display options for highlighted setting.



3 Highlight desired option.

Press the multi selector left to return to step 1.
Press (9) to turn the monitor off without modifying setting.



4 Select option.

The option selected in step 3 is applied, and the screen shown in step 1 will be displayed.

Repeat steps 1–4 to change other settings.

Press the shutter-release button halfway or   to complete the setting.



Image Quality and Size

Together, image quality (the amount of compression) and size determine how much space each photograph occupies on the memory card. Before shooting, choose image quality and image size according to how you plan to use the photograph and the capacity of the memory card. Larger, higher quality images can be printed at larger sizes but also require more memory, meaning that fewer such images can be recorded on the memory card.

Changing Shooting Settings

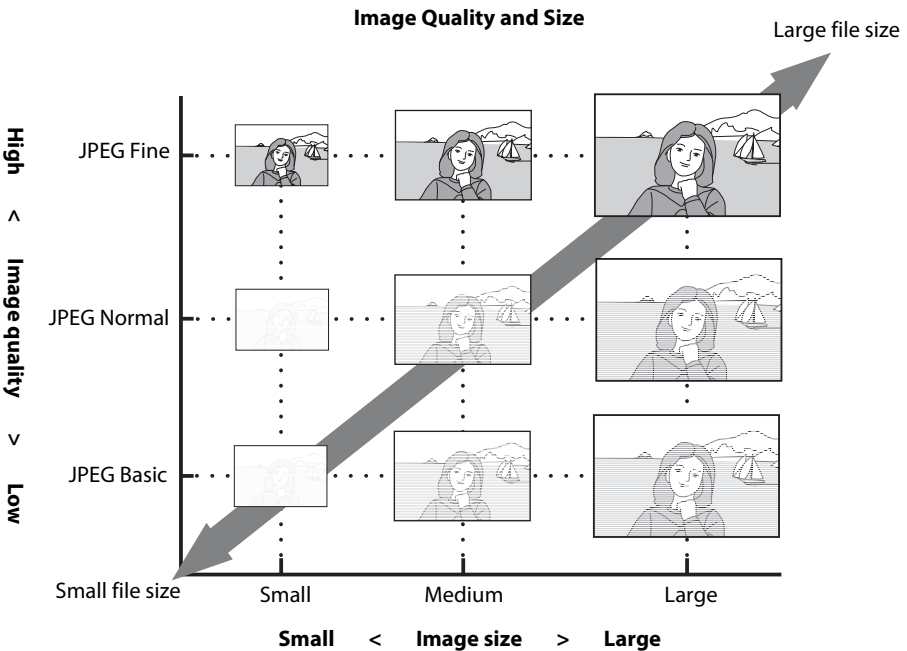

The approximate maximum file size of individual photographs and the total number of photographs that can be recorded at the selected setting are also shown in the Quick settings display while image quality or size options are displayed. Use the display only as a guide. Typical file sizes are listed in “Memory Card Capacity and Image Quality/Size” (178).



Image Quality

Select **Image quality** from the Quick settings display to adjust the setting (48). The camera supports the following image quality options (the first four are listed in descending order by image quality and file size).

Option	Format	Description
RAW	NEF	Compressed raw data from the image sensor are saved directly to memory card. Choose for images that will be processed or retouched on a computer to control image degradation. To print these images, use JPEG-format copies processed from NEF (RAW) photographs using the Quick retouch option (132) or the NEF (RAW) processing option (140) in the retouch menu, or use software that supports the NEF format on a computer.
FINE	JPEG	Images are compressed less than NORM , producing higher-quality images. Compression ratio: approx. 1:4.
NORM (default setting)		Best choice in most situations. Compression ratio: approx. 1:8.
BASIC		Smaller file size suited to e-mail or the website. Compression ratio: approx. 1:16.
RAW+B	NEF+JPEG	Two images are recorded: one NEF (RAW) image and one basic-quality JPEG image.

Image Size

Select **Image size** from the Quick settings display to adjust the setting (48).

Image size is measured in pixels. The following options are available. Choose an image size according to the size at which photos will be printed.

Image size	Size (pixels)	Approximate size when printed at 200 dpi
L (default setting)	3,872×2,592	49.2×32.9 cm (19.4×13.0 in.)
M	2,896×1,944	36.8×24.7 cm (14.5×9.7 in.)
S	1,936×1,296	24.6×16.5 cm (9.7×6.5 in.)

Note that the option selected for image size does not affect the size of NEF (RAW) images. When viewed on a computer, NEF images are 3,872×2,592 pixels in size.

NEF (RAW)/NEF (RAW)+JPEG Basic

To play back NEF (RAW) photographs on devices other than this camera, the files must first be processed to another format. NEF (RAW) photographs can be processed using **NEF (RAW) processing** ( 140) in the retouch menu. Use JPEG photographs created using the **NEF (RAW) processing** option in the retouch menu to print photographs from most professional print services, or via direct USB connection to a printer.

NEF (RAW) photographs can be viewed on a computer using software, such as Capture NX (available separately;  156) or ViewNX (supplied), which supports the NEF format. When photographs taken at **RAW+B** are viewed on the camera, only the JPEG image will be displayed. Note that when photographs taken at this setting are deleted, both NEF and JPEG images will be deleted.

Install ViewNX from the supplied Software Suite CD.

Be sure to update to the latest version of Capture NX. Nikon Message Center automatically checks for updates if an Internet connection is detected at startup.

File Names







Photographs are recorded as image files with names of the form "DSC_nnnn.xxx," where *nnnn* is a four-digit number between 0001 and 9999 assigned automatically in ascending order by the camera, and *xxx* is one of the following three letter extensions: "NEF" for NEF (RAW) images, "JPG" for JPEG images, or "AVI" for movie files ( 99). Files containing image dust off reference data have the extension ".NDF" ( 127). The NEF and JPEG files recorded at a setting of **RAW+B** have the same file names but different extensions. Small copies created with the small picture option ( 136) in the retouch menu have file names beginning with "SSC_" and ending with the extension ".JPG" (e.g., "SSC_0001.JPG"), while images recorded with the other options ( 129) in the retouch menu have file names beginning with "CSC" (e.g., "CSC_0001.JPG"). Movie files created with the stop-motion movie option ( 99) in the retouch menu have the file names beginning with "ASC_" and ending with the extension ".AVI" (e.g., "ASC_0001.AVI"). Images recorded at a **Optimize Image > Custom > Color Mode** setting of **II (AdobeRGB)** ( 102) have names that begin with an underscore (e.g., "_DSC0001.JPG"), however, files containing image dust off reference data have names that begin without an underscore (e.g., "DSC_nnnn") regardless of **Color Mode** setting.

Image Quality/Size







Image quality and size can also be set using the **Image quality** and **Image size** options in the shooting menu ( 100).

11 — /Fn Button (112)

Image quality and size can also be set using the command dial.

White Balance

Select **White balance** from the Quick settings display to adjust the setting (📷 48).

White balance ensures that colors are unaffected by the color of the light source. **Auto** (default setting) is recommended for most light sources; if necessary, other values can be selected according to the type of source. The following options are available in **P**, **S**, **A**, and **M** modes (**Auto** is automatically selected in , , , , , , and  modes).

AUTO Auto (default setting)

Camera sets white balance automatically. Recommended for most situations.



Incandescent

Use under incandescent lighting.



Fluorescent

Use under fluorescent lighting. The specific type of fluorescent lighting can be specified from **White balance** (📷 103) in the shooting menu.



Direct sunlight

Use with subjects lit by direct sunlight.



Flash

Use with built-in flash or optional Nikon flash units.



Cloudy

Use in daylight under overcast skies.



Shade

Use in daylight with subjects in the shade.

PRE Preset manual

Use gray or white object or existing photograph as reference for white balance. See "Preset Manual" for details (📷 105).

MENU White Balance (📷 103)

White balance can also be set from the shooting menu (📷 100). The **White balance** option in the shooting menu can be used to choose a specific type of fluorescent lighting or to fine tune white balance.

11 — Fn Button (📷 112)

White balance can also be set using the command dial.

ISO Sensitivity

Select **ISO sensitivity** from the Quick settings display to adjust the setting (📷 48).

Photographs taken at slow shutter speeds are prone to blurring. If ISO sensitivity is raised above the base setting of ISO 100, the same exposures can be achieved at faster shutter speeds, preventing blur. ISO sensitivity can be set to values between ISO 100 and ISO 1600 in steps of 1 EV, with a further high sensitivity setting of **Hi 1** available for an ISO equivalent of approx. 3200.

	Auto (default setting), 100–1600, Hi 1
P, S, A, M	100 (default setting)–1600, Hi 1

Digital Vari-Program modes also offer an **Auto** setting that allows the camera to automatically raise sensitivity when lighting is poor or lower sensitivity when lighting is bright.

✓ High Sensitivity Setting of Hi 1

Photographs taken at a sensitivity setting of **Hi 1** are prone to be grainy and exhibit mottling.

✎ ISO Sensitivity Setting

Rotating the mode dial from **P, S, A,** or **M** to a Digital Vari-Program mode automatically restores the default ISO sensitivity of **Auto**.

✎ ISO Auto

Use Custom Setting 10 (**ISO auto**; 📷 111) to enable automatic ISO sensitivity control in **P, S, A,** and **M** modes. When **Hi 1** is selected, automatic ISO sensitivity control is disabled.

✎ More Information

For more information about reduce noise at high sensitivities, see **Noise reduction** in the shooting menu (📷 108).

📷 Sensitivity

ISO sensitivity is the digital equivalent of film speed. The higher the ISO sensitivity, the less light needed to make an exposure, allowing higher shutter speeds or smaller apertures. Just as higher speed films tend to be “grainy,” photographs taken at high ISO sensitivities are prone to mottling.

📷 MENU ISO Sensitivity

ISO sensitivity can also be set using the **ISO sensitivity** option in the shooting menu (📷 100).

✎ 11 — 📷/Fn Button (📷 112)

ISO sensitivity can also be set using the command dial.

Releasing the Shutter

Release Mode



Select **Release mode** from the Quick settings display to adjust the setting ( 48).

Single frame (default setting)

Camera shoots one photograph each time the shutter-release button is pressed.

Continuous (burst mode)

 54

Camera records photographs at up to about three frames per second while the shutter-release button is pressed. The fastest frame rates can be achieved by choosing manual focus ( 61), rotating the mode dial to **S** or **M** and selecting a shutter speed of $1/250$ s or faster ( 42, 44), and using defaults for all other settings.

Self-timer

 55

Use for self-portraits or to reduce blurring caused by camera shake. Shutter is released about ten seconds after the shutter-release button is pressed.

2s Delayed remote

 55

Optional Wireless Remote Control ML-L3 required. Use for self-portraits. Shutter is released about two seconds after the shutter-release button on the remote control is pressed.

Quick-response remote





 55

Optional Wireless Remote Control ML-L3 required. Use to reduce blurring caused by camera shake. Shutter is released immediately after the shutter-release button on the remote control is pressed.

04 — Release Mode

Release mode also can be set in the custom settings menu ( 109).

11 — /Fn Button (112)

At default settings, self-timer mode can be applied by simply pressing /Fn. The release mode can be changed by holding down /Fn and rotating the command dial if **Release mode** is selected for Custom Setting 11 (/Fn button;  112).

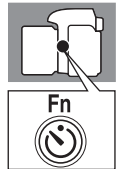

Continuous Mode

- 1 Highlight **Release mode** in the Quick settings display ( 48) and highlight  (Continuous).





- 2 Shoot.

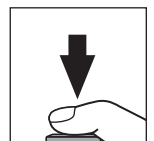

Photographs are shot continuously while the shutter-release button is held down.



Continuous Mode

When shooting conditions demand firing of the flash, continuous shooting is disabled even when  (Continuous) is selected for **Release mode**. Select  or change flash mode ( 65) to turn the flash off.

The Number of Shots Remaining before Memory Buffer Fills



The approximate number of images that can be recorded to the memory buffer, while maintaining the maximum frame rate, is shown in the viewfinder's number of shots remaining before memory buffer fills display while the shutter-release button is held down. The example at right shows that at least 11 more images can be recorded without interruption. In continuous mode, shooting will continue to a maximum of 100 shots, although the frame rate will drop when  is displayed in the exposure-count display. The number of exposures remaining displayed is approximate. The number may vary depending upon shooting conditions. See "Memory Card Capacity and Image Quality/Size" ( 178) for more information regarding the number of photographs that can be recorded in the memory buffer.







Self-Timer and Remote Control Modes

The self-timer or optional Wireless Remote Control ML-L3 can be used for self-portraits.

- 1 Mount the camera on a tripod or place the camera on a stable, level surface.
- 2 Highlight **Release mode** in the Quick settings display ( 48) and select one of the following release modes.

At default settings, **Self-timer** is selected for Custom Setting 11 (/Fn button;  112), and the length of the self-timer delay can be changed by simply pressing /Fn.

Release mode		Description
 10s	Self-timer	Shutter released about ten seconds after camera has focused. The length of self-timer delay can be changed ( 114).
 2s	Delayed remote	Shutter released about two seconds after camera has focused.
	Quick-response remote	Shutter released when camera focuses.

- 3 Frame the photograph.

If the remote control is used with the camera in autofocus mode, press the shutter-release button halfway to focus. The shutter will not be released.

4 Shoot.

Self-timer: Press the camera shutter-release button halfway to focus, then press it the rest of the way down to start the self-timer. The self-timer lamp will start to blink, stopping two seconds before the photograph is shot.

The release mode is set to **Single frame** or **Continuous** after the shutter is released.

Remote control: From a distance of 5 m (16ft.) or less, aim the transmitter on the ML-L3 at the infrared receiver on the camera and press the shutter-release button on the ML-L3. In delayed remote mode, the self-timer lamp will light for about two seconds before the shutter is released. In quick-response remote mode, the self-timer lamp will flash after the shutter has been released.

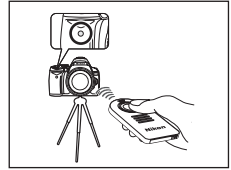
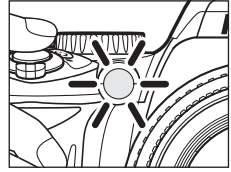
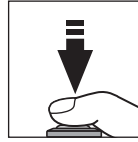

Eyepiece Cap

Attach the eyepiece cap to the viewfinder eyepiece with remote shooting. Remove Rubber Eyecup DK-20 and insert the supplied Eyepiece Cap DK-5 as shown at right. This prevents light entering via the viewfinder interfering with exposure. Hold the camera steady when removing the rubber eyecup.

Remove the Rubber Eyecup DK-20 when attaching other viewfinder eyepiece accessories (📖 155).

Rubber Eyecup DK-20

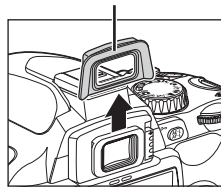

Eyepiece Cap DK-5

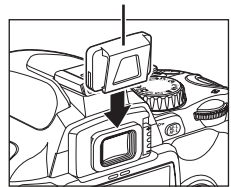

Turning off the Self-Timer

The self-timer mode is turned off when the camera is turned off. Single-frame or continuous release mode is automatically restored when self-timer mode ends.

More Information

For more information about changing the length of time the camera will wait for a signal from the remote before canceling delayed or quick-response remote modes, see Custom Setting 17 (**Remote on Duration**; 📖 115)

Focus Mode

Select **Focus mode** from the Quick settings display to adjust the setting (🔍 48).

Choose how the camera focuses. **AF-S** and **AF-C** are available only in **P**, **S**, **A**, and **M** modes.

AF-A Auto-servo AF (default setting)

Camera automatically selects single-servo autofocus when subject is judged to be stationary, continuous-servo autofocus when subject is judged to be moving.

AF-S Single-servo AF

For stationary subjects. Focus locks when the shutter-release button is pressed halfway.

AF-C Continuous-servo AF

For moving subjects. Camera focuses continuously while the shutter-release button is pressed halfway.

MF Manual focus

User focuses manually (🔍 61).

✔ Continuous-Servo AF

Priority is given to shutter response, meaning that shutter is released in wider range of focus than when single-servo AF is selected. Shutter may sometimes be released before in-focus indicator (●) is displayed in viewfinder. The same operation is performed when focus mode automatically switches from auto-servo AF to continuous-servo AF.



✍ Manual Focus

When **MF** is selected for **Focus mode** in any shooting mode, switching to another shooting mode does not affect the focus mode setting.

✍ More Information

For more information about the subject with which autofocus does not perform well, see “Getting Good Results with Autofocus” (🔍 38).

📷 The AF-Assist Illuminator

If the subject is poorly lit, the AF-assist illuminator will light automatically to assist the autofocus operation when the shutter-release button is pressed halfway. The AF-assist illuminator will not light in continuous-servo AF or manual focus mode, in  mode, or  mode, or if the center focus point is not selected or if **Off** has been selected for Custom Setting 9 (**AF assist**; 🔍 111). The illuminator has a range of about 0.5–3.0 m (1 ft. 8 in.–9 ft. 10 in.); when using the illuminator, use a lens with a focal length of 24mm to 200mm and remove the lens hood.

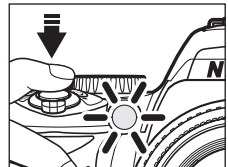

MENU 2 — Focus Mode







Focus mode can also be selected from the Custom Settings menu (🔍 109).

AF-Area Mode

Select **AF-area mode** from the Quick settings display to adjust the setting (48).

The D60 is equipped with three focus points (areas in which the camera focuses). Choose how the focus point is selected in autofocus mode.

Closest subject

Camera automatically selects focus point containing subject closest to camera. Default for **P**, **S**, **A**, and **M** modes; selected automatically when mode dial is rotated to , , , , , , or .

Dynamic area

User selects focus point manually, but if subject leaves selected focus point even briefly, camera will focus based on information from other focus points. Use with erratically moving subjects. Selected automatically when the mode dial is rotated to .

Single point

User selects focus point using the multi selector; camera focuses on subject in selected focus point only. Use with stationary subjects. Selected automatically when the mode dial is rotated to .

Viewfinder Display

AF-area mode is shown in the viewfinder as follows:

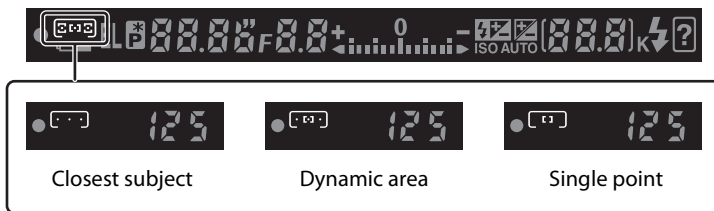

More Information

For more information about the subject with which autofocus does not perform well, see “Getting Good Results with Autofocus” (38).

AF Area Mode

When **MF** is selected for **Focus mode** (57), **AF-area mode** cannot be changed.

The AF-area mode selected in Digital Vari-Program modes is restored when the mode dial is rotated to another shooting mode.

3—AF-Area Mode

AF-area mode can also be selected from the Custom Settings menu (109).

Focus Point Selection

The focus point can be selected manually for composing photographs in which the main subject is not positioned at the center of the frame.

1 Highlight **AF-area mode** in the Quick settings display (📷 48).

2 To enable manual focus selection in these modes, select [1] (single point) or [1:1] (dynamic area) for **AF-area mode** (📷 58) in the Quick settings display.

At default settings, [1:1] (**Closest subject**) is selected automatically in **AUTO**, **📷**, **📷**, **📷**, **📷**, **📷**, **P**, **S**, **A**, and **M** modes.

3 Press the multi selector left or right to highlight the focus point in the viewfinder.

The selected focus point is highlighted again when the shutter-release button is pressed halfway.



The selected focus point is also shown in the Shooting information display or viewfinder.



Focus Lock

Focus lock can be used to change the composition after focusing, making it possible to focus on a subject that will not be in the one of three focus points in the final composition. Selecting **[]** (single point) or **[]** (dynamic area) for **AF-area mode** (58) is recommended when using focus lock.

1 Position the subject in the selected focus point and press the shutter-release button halfway to initiate focus.

Check that the in-focus indicator (●) appears in the viewfinder. Focus will lock automatically when the in-focus indicator appears, and remain locked while the shutter-release button is pressed halfway.

Focus point can be selected (59).

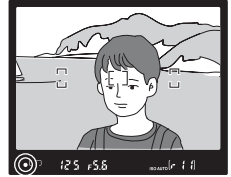
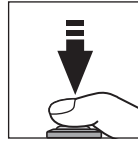

2 Recompose the frame while focus remains locked. Press the shutter-release button the rest of the way down to shoot.

When using focus lock, be sure that the distance between the camera and the subject on which focus was locked does not change.

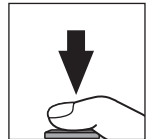
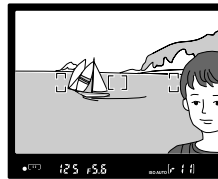

Focus Lock using **AE-L/AF-L**

Focus can also be locked by pressing **AE-L/AF-L** instead of holding the shutter-release button down halfway. Focus will lock when **AE-L/AF-L** is pressed while the shutter-release button is pressed halfway. Focus will remain locked while **AE-L/AF-L** is held down, even if you later remove your finger from the shutter-release button.

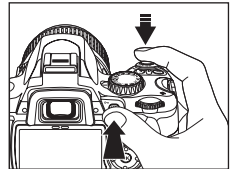

✓ Focus Lock

The shutter-release button cannot be used to lock focus in **mode** (37), **(continuous) release mode** (54), or **continuous-servo autofocus** (57), or when **continuous-servo autofocus** is selected in **auto-servo AF** (57). Use **AE-L/AF-L** to lock focus.

📷 Shooting While Focus Remains Locked

When focus is locked by pressing the shutter-release button halfway, release the shutter-release button only halfway after the shutter is released and press fully again to take the next picture. Focus will remain locked between shots. When focus is locked by pressing **AE-L/AF-L**, hold **AE-L/AF-L** down and press the shutter-release button all the way down for each shot.

🔧 12 — AE-L/AF-L (113)

This option controls the behavior of **AE-L/AF-L**.

Manual Focus

Use this option to focus manually or when the camera is unable to focus correctly using autofocus. To focus manually, display the Quick settings display and choose **Focus mode** (📷 48) and select **MF** (manual focus) for **Focus mode** (📷 57).

Adjust the lens focusing ring until the image displayed on the clear matte field in the viewfinder is in focus. Photographs can be taken at any time, even when the image is not in focus.

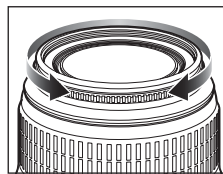

When using a lens that offers A-M selection, select M when focusing manually. With lenses that support M/A (autofocus with manual priority), focus can be adjusted manually with the lens set to M or M/A. See the documentation provided with your lens for details.

📷 The Electronic Rangefinder

If the lens has a maximum aperture of f/5.6 or faster, the viewfinder focus indicator can be used to confirm whether the portion of the subject in the selected focus point is in focus. After positioning the subject in the active focus point, press the shutter-release button halfway and rotate the lens focusing ring until the in-focus indicator (●) is displayed. Use Custom Setting 19 (**Rangefinder**; 📷 116) to display rangefinder, a scale indicating the focus distance for shooting in manual focus mode. Note that if the subject is one for which autofocus does not perform well (📷 38), the in-focus indicator (●) may be displayed even when the subject is not in focus. Confirm that the image in the viewfinder is in focus before shooting.

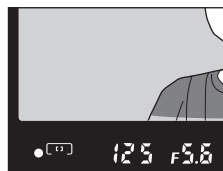

📷 Focal Plane Position

To determine the distance between your subject and the camera, measure from the focal plane mark (⊖) on the camera body. The distance between the lens mounting flange and the focal plane is 46.5 mm (1.83 in.).

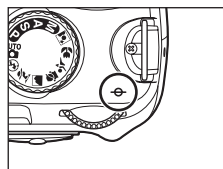









MENU 2 — Focus Mode

Focus mode can also be selected from the Custom Settings menu (📷 109).

Download from www.Somanuals.com. All Manuals Search And Download.

Metering

Select **Metering** from the Quick settings display to adjust the setting (🔑 48).

The metering method determines how the camera sets exposure. The following options are available when the mode dial is rotated to **P**, **S**, **A**, or **M** (matrix metering is always used in , , , , , , ,  modes).



Matrix (default setting)

Recommended in most situations. Camera meters a wide area of the frame and instantly sets exposure according to distribution of brightness, color, distance, and composition for natural results.



Center-weighted

Camera meters entire frame but assigns greatest weight to center area. Classic meter for portraits.



Spot

Camera meters exposure in active focus point only (if  **(Closest subject)** is selected for **AF-area mode** (🔑 58), camera will meter center focus point). Ensures that subject will be correctly exposed, even when background is much brighter or darker.

Metering



Metering is available with CPU lenses only. In matrix metering, exposure is set using a 420-pixel RGB sensor. Use a type G or D lens for results that include range information (*3D color matrix metering II*). With other CPU lenses, 3D range information is not included (*color matrix metering II*).

5 — Metering

Metering can also be selected from the Custom Settings menu (🔑 109).

Autoexposure Lock



If the subject is not in the metered area when center-weighted or spot metering is used, exposure will be based on lighting conditions in the background and the main subject may not be correctly exposed. This can be prevented by using autoexposure lock. Available in **P**, **S**, and **A** modes.

- 1 Select mode **P**, **S**, or **A** and choose  (center-weighted) or  (spot) for **Metering** (exposure lock has no effect in mode **M**).

 (matrix) is not recommended as AE lock may not be sufficiently effective.

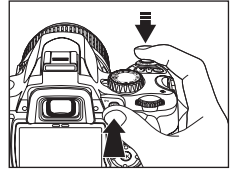
- 2 Position the subject in the selected focus point. Keeping the shutter-release button pressed halfway and the subject positioned in the selected focus point, press **AE-L/AF-L** to lock exposure.



Exposure is locked. While **AE-L/AF-L** is pressed, exposure is locked at the value metered in the selected focus point when  (spot) is selected, or at the value metered in the center area when  (center-weighted) is selected. Recomposing the frame does not affect the exposure.

While exposure lock is in effect, an **EL** indicator will appear in the viewfinder. When autofocus is used, focus will be also locked.

Confirm that the in-focus indicator () appears in the viewfinder when the shutter-release button is pressed.



- 3 Keeping **AE-L/AF-L** pressed, recompose the photograph and shoot.

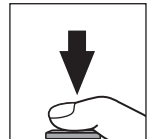

Adjusting Shutter Speed and Aperture

While exposure lock is in effect, the following settings can be adjusted by rotating the command dial without altering the metered value for exposure.

Programmed auto	Shutter speed and aperture (flexible program;  41)
Shutter-priority auto	Shutter speed
Aperture-priority auto	Aperture

Note that the metering method cannot be changed while exposure lock is in effect.

12—AE-L/AF-L (113)

This option controls the behavior of **AE-L/AF-L**.



13—AE Lock (113)

This option controls whether the shutter-release button locks exposure.







Download from www.Somanuals.com. All Manuals Search And Download.

Using the Built-in Flash

The camera supports a variety of flash modes for photographing poorly lit or backlit subjects.

Note that the built-in flash cannot be used, nor can the flash mode be changed, in , , or  mode.

Using the Built-in Flash: , , , , and  Modes

- 1 Rotate the mode dial to , , , , or .
- 2 Confirm or change the current flash mode ( 65).
Select  to prevent the flash from firing.

3 Frame a photograph and shoot.

The flash will pop up as required when the subject is poorly lit or backlit.
The flash mode can be changed after the flash pops up.
Press the shutter-release button all the way down to shoot.

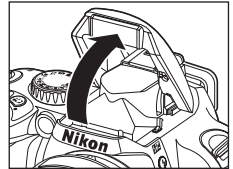
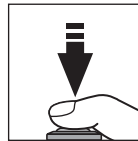



4 Lower the flash when it is no longer needed.

Using the Built-in Flash: **P**, **S**, **A**, and **M** Modes

- 1 Rotate the mode dial to **P**, **S**, **A**, or **M**.
- 2 Press  to raise the flash.

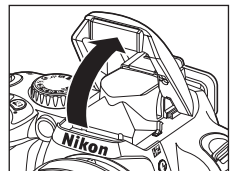
The flash will fire whenever a photograph is taken. To prevent the flash from firing, lower the flash.



- 3 Confirm or change the current flash mode ( 65).
- 4 Choose a metering method ( 62), adjust exposure, frame the photograph, and shoot.

Lowering the Built-in Flash

To save power when the flash is not in use, press it gently downward until the latch clicks into place.

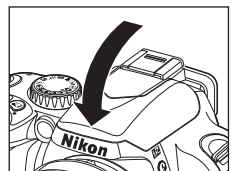

Changing the Flash Mode

Select **Flash mode** from the Quick settings display to adjust the setting (48). Change the flash output depending upon shooting conditions. The flash modes available depend upon the mode currently selected with the mode dial.

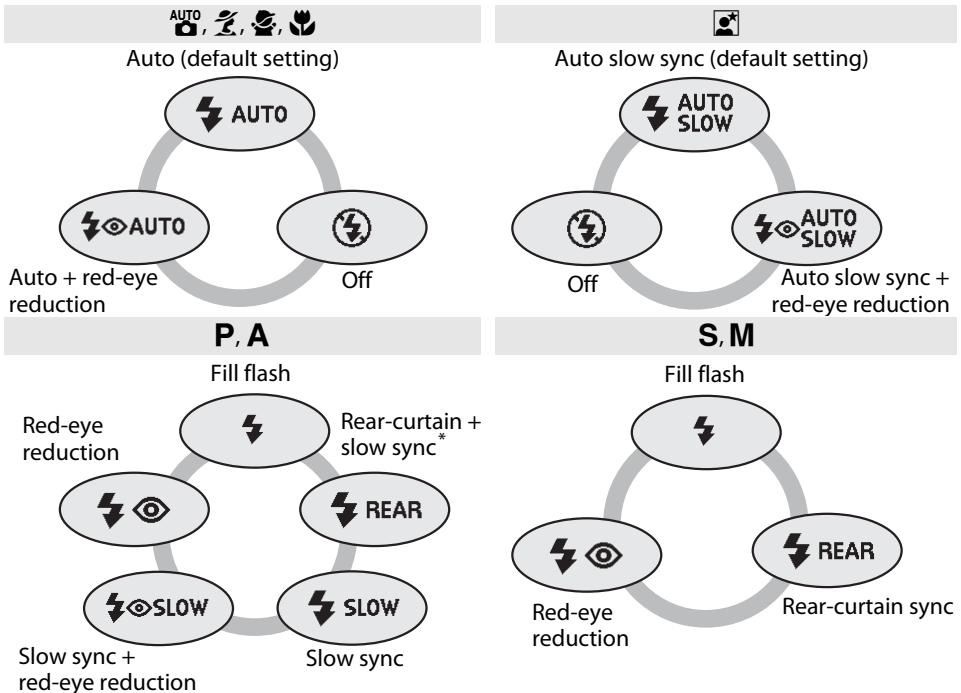

* **SLOW** is displayed after command dial is released.

Flash modes are described below.

- **AUTO** (auto flash): When lighting is poor or subject is backlit, flash pops up automatically when the shutter-release button is pressed halfway and fires as required.
- **Red-eye reduction** (red-eye reduction): Use for portraits. AF-assist lamp lights before flash fires, reducing "red-eye."
- **SLOW** (slow sync): Shutter speed slows automatically to capture background lighting at night or under low light. Use to include background lighting in portraits.
- **REAR** (rear curtain sync): Flash fires just before shutter closes, creating the effect of a stream of light behind moving subjects. If this icon is not displayed, flash will fire immediately after shutter opens.

Using the Command Dial

The flash mode can also be selected by rotating the command dial while pressing . Confirm that the flash mode display changes, according to the shooting mode currently selected in the Shooting information display, while selecting a flash mode. In **P, S, A,** and **M** modes, press to raise the flash. Press again and hold it down while rotating the command dial to select a flash mode.

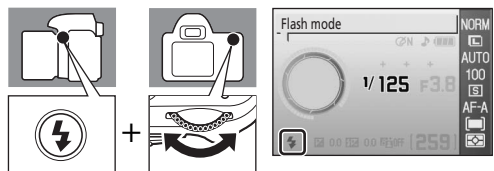

✓ The Built-in Flash

Use with CPU lenses with focal lengths of 18mm to 300mm or non-CPU lenses with focal lengths of 18mm to 200mm. Restrictions on focal length and shooting distance may apply with some lenses. See “Optional Accessories” (📖 145) for details. Remove lens hoods to prevent shadows. The flash has a minimum range of 60cm (2ft.) and cannot be used in the macro range of macro zoom lenses. If the flash fires in continuous release mode (📖 54), only one photograph will be taken each time the shutter-release button is pressed.

The shutter release may be briefly disabled to protect the flash after it has been used for several consecutive shots. The flash can be used again after a short pause.

For information on optional flash units (Speedlights), see “Optional Flash Units (Speedlights)” (📖 150).

In **P**, **S**, **A**, and **M** modes, flash output is controlled using flash compensation (📖 68). Output of the built-in flash can be adjusted manually from Custom Setting 14 (**Built-in flash**; 📖 113).

✎ Flash Mode Setting

The default flash setting for Digital Vari-Program modes is automatically restored when the mode dial is rotated to a new setting or the camera is turned off.

📷 Rear-Curtain Sync

Normally the flash fires as the shutter opens (“front curtain sync”; see below at left). In rear-curtain sync, the flash fires just before the shutter closes, creating the effect of a stream of light behind moving subjects.



Front-curtain sync



Rear curtain sync



✎ More Information

For more information about auto ISO control, see “ISO Auto” (📖 112).

For more information about flash control options, see Custom Setting 14 (**Built-in flash/Optional flash unit**; 📖 113).

Exposure Compensation

Select **Exposure comp.** from the Quick settings display to adjust the setting (🔧 48).

Exposure compensation is used to alter exposure from the value suggested by the camera, making photographs brighter or darker. It is available in **P**, **S**, and **A** modes and is most effective when used with  (center-weighted) or  (spot) metering (🔧 62).

Exposure compensation can be set to values between -5 to $+5$ in increments of $1/3$ EV. As a rule of thumb, positive compensation may be needed when the main subject is darker than the background, negative values when the main subject is brighter than the background.

Exposure compensation is shown in the Shooting information display. Normal exposure can be restored by setting exposure compensation to 0.0 . Exposure compensation is not reset when the camera is turned off.



-1EV



No exposure compensation



+2EV

Exposure Compensation in M Mode

- In **M** mode, photographs are taken at the shutter speed and aperture manually specified, even when exposure compensation has been applied.
- In **M** mode, the reference value shown in the electronic analog exposure display will change except when exposure compensation value is set to 0.0 .

Using the Command Dial

Exposure compensation can also be adjusted by rotating the command dial while pressing  only in **P**, **S**, and **A** modes. Check the value and electronic analog exposure display shown in the viewfinder or Shooting information display. The viewfinder display is illustrated at right.

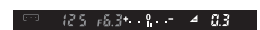
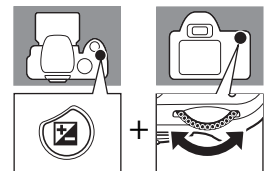

-0.3 EV



+2.0 EV

Flash Compensation

Select **Flash compensation** from the Quick settings display to adjust the setting (🔌 48). Flash compensation (available only in **P**, **S**, **A**, and **M** modes) is used to alter flash output, changing the brightness of the main subject relative to the background. Flash output can be increased to make the main subject appear brighter, or reduced to prevent unwanted highlights or reflections.

Flash compensation is shown in the Shooting information display.



Normal flash output can be restored by setting flash compensation to 0.0. Flash exposure compensation is not reset when the camera is turned off.

Flash compensation is also available with optional SB-400, SB-800, SB-600 (🔌 150), and SU-800 flash units (🔌 150).

🔌 Using the Command Dial

Flash compensation can also be adjusted by from -3EV to $+1\text{EV}$ in increments of $\frac{1}{3}\text{EV}$, by rotating the command dial while pressing ⚡ (🔌) and 📷 (🔌). Check the desired value shown in the viewfinder or Shooting information display. The viewfinder display is illustrated at right.

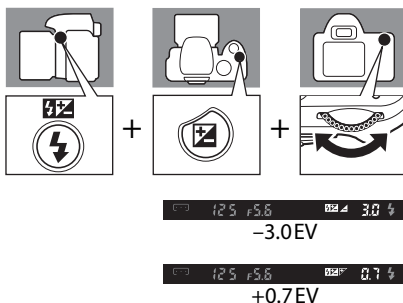

MENU 8—Flash Compensation

Active D-Lighting

Select **Active D-Lighting** from the Quick settings display to adjust the setting (🔑 48). When Active D-Lighting is enabled before shooting, the camera automatically applies Active D-Lighting compensation, which preserves details in highlights and shadows, creating photographs with natural contrast. Use for high contrast scenes, for example when shooting brightly lit outdoor scenery through a door or window or shooting of shaded subjects on a sunny day.



OFF



ON

🔧 Active D-Lighting

- Additional time is required to record images when Active D-Lighting is on.
- When Active D-Lighting is enabled, the camera evaluates various aspects of the scene and applies the appropriate processing. Exposure is first reduced with shooting, and then highlights, shadows, and mid-tones are adjusted, prior to recording, to achieve optimal brightness.

🔧 Metering

When Active D-Lighting is used in **P**, **S**, **A**, or **M** mode, select **Matrix** (default setting) for **Metering** (🔑 62).

🔧 “Active D-Lighting” versus “D-Lighting”

The **Active D-Lighting** option in the shooting menu adjusts exposure before shooting to optimize the dynamic range, while the **D-Lighting** option (🔑 132) in the retouch menu optimizes dynamic range in images after shooting.

🔧 Using the Command Dial

Active D-Lighting is enabled or disabled by rotating the command dial while pressing **Fn**. Check the Active D-Lighting indicator shown in the viewfinder or Shooting information display. The viewfinder display is illustrated at right.

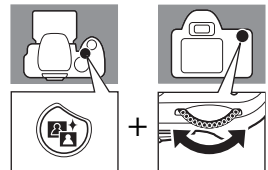



MENU Active D-Lighting

The Active D-Lighting option can also be set in the shooting menu (🔑 100).



Two-Button Reset

Flexible program and the camera settings that can be changed from the Quick settings display can be restored to default values by holding  and  down together for more than two seconds (these buttons are marked by a green dot). The monitor turns off briefly while settings are reset.

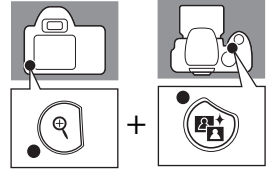

































Image quality  50)	JPEG normal	Metering  62)	Matrix
Image size  50)	Large	Flash mode  64)	
White balance  52)*	Auto	   	Auto
ISO sensitivity  53)			Auto slow sync
    	Auto	P, S, A, M	Fill flash
P, S, A, M	100	Exposure compensation  67)	0.0
Release mode  54)	Single frame	Flash compensation  68)	0.0
Focus mode  57)	AF-A	Active D-Lighting  69)	Off
AF-area mode  58)		Flexible program  41)	Off
    	Closest subject		
 P, S, A, M			
	Dynamic area		
	Single point		

* Fine-tuning  104) reset to 0 and the fluorescent option to cool-white fluorescent.

Default Settings

More on Playback

This chapter explains photograph playback in the camera monitor, and protection of photographs from accidental deletion.

Photographs can be edited from the retouch menu (🔑 129) during playback and recorded as separate files. The color tone of photographs can be modified, and multiple photographs can also be combined to create and play back a movie file.

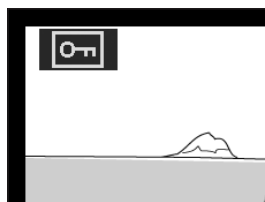
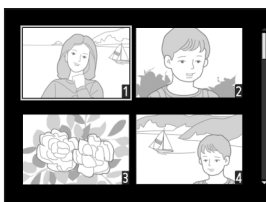
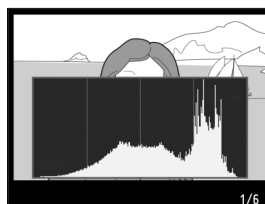

Viewing Photographs in Full-Frame Playback







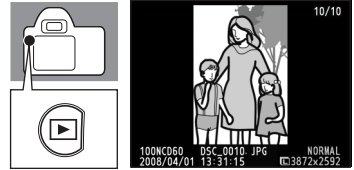













Full-Frame Playback

To view photographs in the monitor, press .



Photographs taken in “tall” (portrait) orientation are displayed in tall orientation as shown at right.



The following operations can be performed in full-frame playback.

Option	Use	Description
View additional photographs	 or 	Press the multi selector to right or rotate the command dial right to view photographs in order recorded. Press the multi selector left or rotate the command dial left to view photographs in reverse order.
View photo information		Press the multi selector up or down to view information about current photograph ( 73).
Zoom in on photograph		Zoom in on current photograph ( 77).
Delete photograph		Delete current photograph ( 34).
Protect photograph	 AE-L  AF-L	Protect current photograph ( 78).
View thumbnails		View multiple photographs ( 76).
Retouch photograph	OK	Display the retouch menu ( 129). When a movie file created from the Stop-motion movie option ( 141) is displayed, the movie can be played back by pressing OK . The same operations available during stop-motion playback ( 99) can be performed.
Exit to shooting mode	 or 	To return to shooting mode, press the shutter-release button halfway or press  .
View menus	MENU	View menus ( 94).

More Information

For more information about controlling whether photographs taken in “tall” orientation are rotated for display in the monitor during playback, see **Auto image rotation** in the playback menu ( 128) and **Rotate tall** in the setup menu ( 98).

For more information about choosing whether to display photographs as they are taken, see Custom Setting 07 (**Image review**;  111).

For more information about choosing how long the monitor remains on before turning off automatically to reduce the drain on the battery, see Custom Setting 15 (**Auto off timer**;  114).

Photo Information

Photo information is superimposed on images displayed in full-frame playback. Press the multi selector up or down to cycle through the following information.

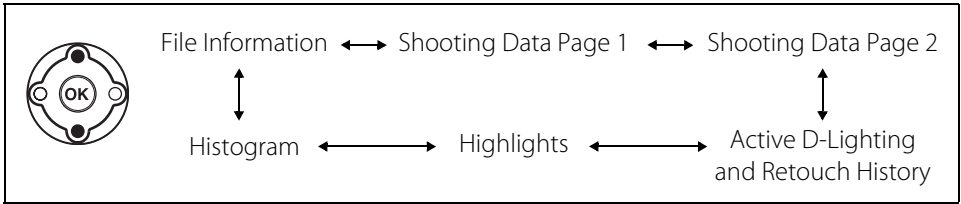

File Information

1	Retouch indicator.....	129
2	Protect status	78
3	Frame number/total number of images	
4	Folder name	125
5	File name	51
6	Image quality	50
7	Date of recording	21
8	Time of recording.....	21
9	Image size	50

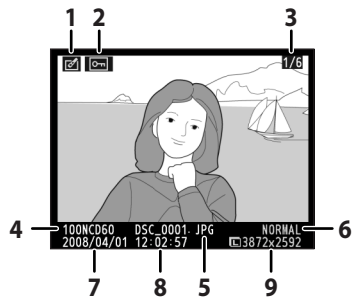

Shooting Data, Page 1

1	Retouch indicator.....	129
2	Protect status	78
3	Camera name	
4	Metering method.....	62
5	Shutter speed.....	40–46
6	Aperture	40–46
7	Exposure mode.....	6
8	Exposure compensation	67
9	Focal length	19
10	Flash mode	113, 150
11	Frame number/total number of images	

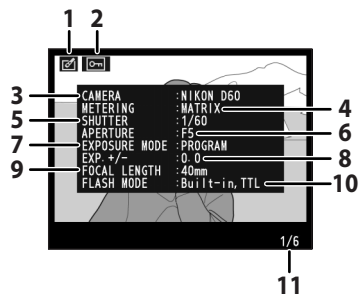

Shooting Data, Page 2

1	Retouch indicator.....	129
2	Protect status	78
3	Image optimization.....	101
4	ISO sensitivity ¹	53
5	White balance.....	52, 103
6	white balance fine tuning	104
7	Image size/image quality	50
8	Tone compensation.....	102
9	Sharpening	102
10	Color mode/hue	102
11	Saturation	102
11	Image comment ²	124
12	Frame number/total number of images	

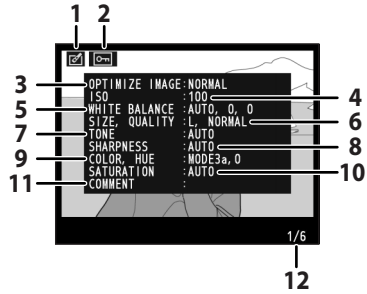

1. Displayed in red if ISO sensitivity was modified from selected value by the **ISO auto** option when **On** is selected for Custom Setting 10 (**ISO auto**,  111).
2. Though comments can be up to 36 characters in length, only the first 15 characters are displayed.

Active D-Lighting and Retouch History

1	Retouch indicator.....	129
2	Protect status	78
3	Active D-Lighting*	69
4	Retouch history: Lists changes made to image using options in retouch menu ( 129), starting with most recent change.	
5	Frame number/total number of images	

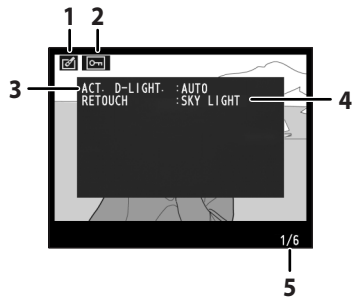

* "AUTO" will be displayed for photographs taken when **Active D-Lighting** is on.

Highlights

The brightest portions of the image (*highlights*) blink. Details may be lost (“washed out”) in areas of highlights that are overexposed. Use highlights as a guide when setting exposure.

- 1 Retouch indicator..... 129
- 2 Protect status78
- 3 Highlights (indicated by flashing border)
- 4 Frame number/total number of images

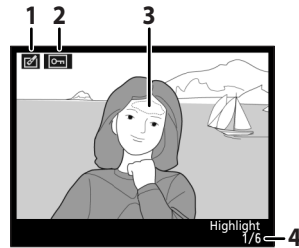

Histogram

A graph showing the distribution of tones in the image (*histogram*) is displayed*. The horizontal axis corresponds to pixel brightness, with dark pixels at the left and bright pixels at the right. The vertical axis shows the number of pixels of each brightness in the image.

- 1 Retouch indicator..... 129
- 2 Protect status78
- 3 Frame number/total number of images
- 4 Histogram

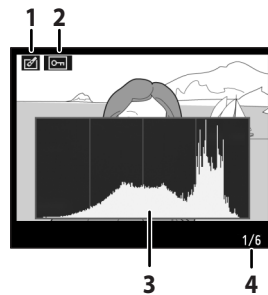

Some sample histograms are shown below:

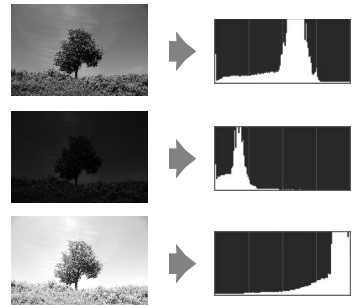

- If the image contains objects with a wide range of brightnesses, the distribution of tones will be relatively even.
- If the image is dark, tone distribution will be shifted to the left.
- If the image is bright, tone distribution will be shifted to the right.



Increasing exposure compensation shifts tone distribution to the right. Tone distribution shifts to the left when exposure compensation is decreased. If bright ambient lighting makes it difficult to see the display in the monitor, the histogram can be used to get an idea of overall exposure.







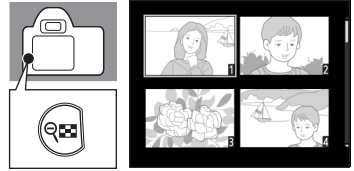





* Note that camera histograms are intended as a guide only and may differ from those displayed in imaging applications.

Viewing Multiple Photographs: Thumbnail Playback



To display images in “contact sheets” of four or nine images, press  in full-frame playback ( 72).



















The following operations can be performed while thumbnails are displayed.

Option	Use	Description
Display more images per page		Increase number of images displayed from one (full-frame playback) to four or from four to nine.
Display fewer images per page		Decrease number of images displayed from nine to four or from four to one (full-frame playback).
View photo	OK	View highlighted photograph full frame.
Highlight photographs	 or 	Use the multi selector or the command dial to highlight photographs.
Delete photograph		Delete highlighted photograph ( 34).
Protect photograph	AE-L / AF-L ()	Protect highlighted photograph ( 78).
Exit to shooting mode	 or 	To return to shooting mode, press the shutter-release button halfway or press  .
View menus	MENU	View menus ( 94).

Taking a Closer Look: Playback Zoom

Press  to zoom in to maximum of approximately 25× (large images), 19× (medium images) or 13× (small images) on a photograph in full-frame playback ( 72). The following operations can be performed.



Option	Use	Description
Zoom in		Press  to zoom in.
Zoom out		Press  to zoom out.
View other areas of image		<p>While photo is zoomed in, press the multi selector up, down, left, or right to view areas of image not visible in monitor. Keep the multi selector pressed to scroll rapidly to other areas of frame.</p> <p>Navigation window is displayed for a few seconds when zoom ratio is altered; area currently visible in monitor is indicated by yellow border. Press , , or the multi selector to display navigation window again.</p>
View other images		Rotate command dial to view same location in other images at current zoom ratio.
Cancel zoom	OK	Return to full-frame playback.
Delete photograph		Delete current photograph ( 34).
Protect photograph	AE-L/AF-L 	Protect current photograph ( 78).
Exit to shooting mode	 or 	To return to shooting mode, press the shutter-release button halfway or press  .
View menus	MENU	View menus ( 94).

Protecting Photographs from Deletion

In full-frame, zoom, and thumbnail playback, **AE-L/AF-L** (ⓘ) can be used to protect photographs from accidental deletion. Protected files cannot be deleted using **⏻** or the **Delete** option in the playback menu.

Note that protected files will be deleted when the memory card is formatted (⏻ 24).

1 Choose a photograph.

Display the desired photograph in full-frame, or use the multi selector to highlight it in the thumbnail list.

2 Press **AE-L/AF-L** (ⓘ) to protect the photograph currently displayed.

The photograph *will* be marked with a ⓘ icon.

To remove protection from the photograph so that it can be deleted, press **AE-L/AF-L** (ⓘ) again.



File Attribute

Protected files have DOS "read-only" status when viewed on a Windows computer.

Connecting to a Computer, Printer, or TV

This chapter explains connection of the camera to external devices such as computers, printers, or televisions using the supplied USB cable and the optional video cable. Photographs can be transferred to a computer for viewing, editing, and printing, or displayed on a TV screen, expanding the ways in which photographs are enjoyed.

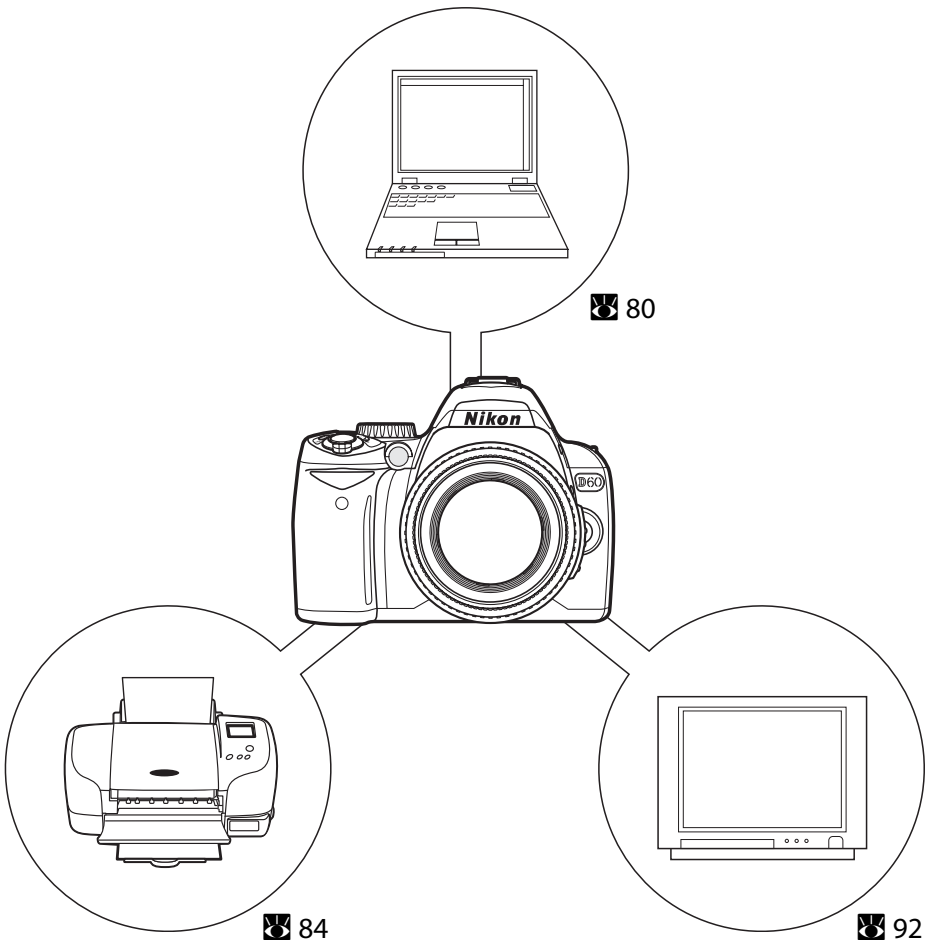

Connecting to a Computer

When the camera is connected to a computer using the supplied USB cable, photographs recorded with the camera can be copied (transferred) to the computer for storage using the Nikon Transfer software.

Before Connecting the Camera

Installing the Software

Before connecting the camera to a computer, software, including Nikon Transfer and ViewNX for viewing the transferred photographs, must be installed from the supplied Software Suite CD.

For more information on installing the software, refer to the *Quick Start Guide*.

Operating Systems Compatible with D60

Windows

Preinstalled versions of Windows Vista (32-bit Home Basic/Home Premium/Business/Enterprise/Ultimate editions), Windows XP Service Pack 2 (Home Edition/Professional) If your computer is running Windows 2000 Professional, use a card reader or similar device to transfer pictures stored on the memory card (📷 82).

Macintosh

Mac OS X (version 10.3.9, 10.4.10)

Refer to the Nikon website for the latest information on operating system compatibility.

📌 Notes on Power Source

When connecting the camera to a computer or printer, use batteries with adequate charge remaining to prevent the camera from turning off unexpectedly. To power the camera continuously for extended periods, use an optional AC Adapter EH-5a with Power Connector EP-5 (📷 156).

Download from [Www.Somanuals.com](http://www.Somanuals.com). All Manuals Search And Download.

Connecting the USB Cable

- 1 Start the computer to which Nikon Transfer has been installed.
- 2 Turn the camera off.
- 3 Connect the camera to the computer using the supplied USB cable.

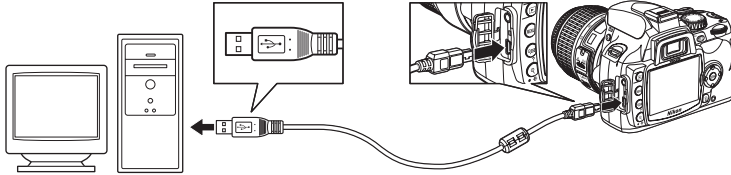

- 4 Turn the camera on.

Windows Vista

When the AutoPlay dialog is displayed, select **Copy pictures to a folder on my computer using Nikon Transfer**. Nikon Transfer will start. To bypass this dialog in the future, check **Always do this for this device**:

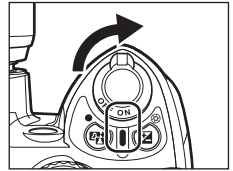

Windows XP

When the AutoPlay dialog is displayed, select **Nikon Transfer Copy pictures to a folder on my computer** and click **OK**. Nikon Transfer will start. To bypass this dialog in the future, check **Always use this program for this action**.

Mac OS X

Nikon Transfer will start automatically if **Yes** was selected in the Auto-Launch setting dialog when Nikon Transfer was first installed.

- 5 Transfer photographs using Nikon Transfer.

For more information on using Nikon Transfer, refer to help information contained in Nikon Transfer.

When transfer is complete, ViewNX will start automatically.

- 6 Turn the camera off and disconnect the USB cable when transfer is complete.

Connecting the USB Cable

- Be sure that the connectors are oriented correctly, and do not use force, to connect the USB cable. When disconnecting the USB cable, do not pull the connector at an angle.
- Connection may not be recognized when the camera is connected to a computer via a USB hub.

During Transfer

Do not turn the camera off or disconnect the USB cable while transfer is in progress.

Viewing Online Help

To view online help for Nikon Transfer or ViewNX, select **Nikon Transfer help**, or **ViewNX help**, from the application's **Help** menu.

Camera Control Pro 2

Camera Control Pro 2 (available separately;  156) can be used to operate the camera from a computer. When Camera Control Pro 2 is running, "PC" will appear in the viewfinder and Shooting information display.

Nikon Message Center automatically checks for updates if an Internet connection is detected at startup. Be sure to update to the latest version.

For Users of Windows 2000 Professional

Use a card reader or similar device to transfer the photographs stored on the memory card to the computer. Refer to the *Quick Start Guide* for details.

If the memory card has a capacity greater than 2 GB, or is SDHC-compliant, the intended device must support these features of the memory card.

- Do not connect the camera to the computer. If the camera is connected to the computer, the **Found New Hardware Wizard** dialog will be displayed. Select **Cancel**, close the dialog, turn the camera off, and disconnect the camera from the computer.

Connecting to a Printer

Photographs can be printed by any of the following methods:

- Connect the camera to a printer and print JPEG photographs directly from the camera (📖 84).
- Insert the camera memory card in a printer equipped with a card slot (see the printer manual for details). If the printer supports DPOF (📖 186), photographs can be selected for printing using **Print set (DPOF)** (📖 90).
- Take the camera memory card to a developer or digital printer center. If the center supports DPOF (📖 186), photographs can be selected for printing using **Print set (DPOF)** (📖 90).
- Transfer photographs (📖 80) and print them from a computer. For more information about how to print photographs from a computer, refer to the documentation provided with your printer and the software.

✔ Printing NEF (RAW) Photographs

NEF (RAW) photographs (📖 51) cannot be printed in the methods described above. Use JPEG-format copies created from NEF (RAW) photographs using **Quick retouch** or **NEF (RAW) processing** in the retouch menu (📖 129), or transfer them to a computer and print them using ViewNX (supplied) or Capture NX (available separately; 📖 156).

Printing Via Direct USB Connection

JPEG photographs can be printed directly from a camera connected to a PictBridge printer (📷 186). When shooting photographs for printing via direct USB connection in **P**, **S**, **A**, and **M** modes, choose **Ia (sRGB)** or **Illa (sRGB)** for the **Optimize image>Custom>Color mode** option (📷 102) in the shooting menu.

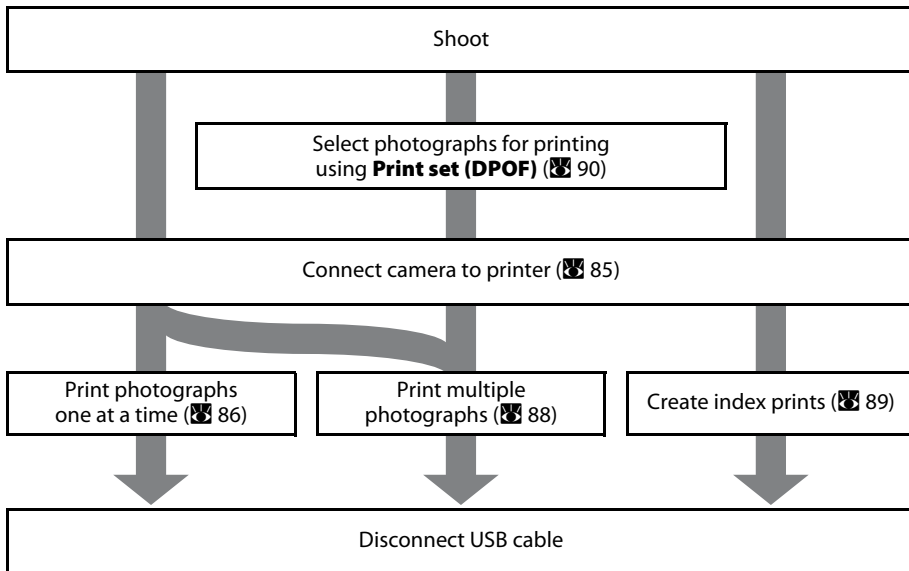

✔ Printing NEF (RAW) Photographs

Direct printing of NEF (RAW) photographs (📷 50) is not possible. Use JPEG-format copies created from NEF (RAW) photographs using **Quick retouch** or **NEF (RAW) processing** in the retouch menu (📷 129) to print via direct USB connection.

✔ Notes on Power Source

When connecting the camera to a computer or printer, use batteries with adequate charge remaining to prevent the camera from turning off unexpectedly. To power the camera continuously for extended periods, use an optional AC Adapter EH-5a with Power Connector EP-5 (📷 156).

Connecting the Printer

1 Turn the printer on.

2 Turn the camera off.

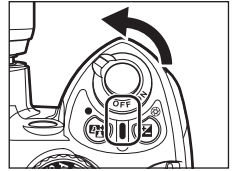

3 Connect the camera to the printer using the supplied USB cable.

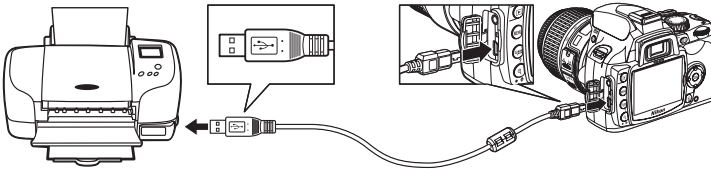

4 Turn the camera on.

When connected correctly, the PictBridge startup screen ① will be displayed in the camera monitor. Then the PictBridge playback display will be shown ②.

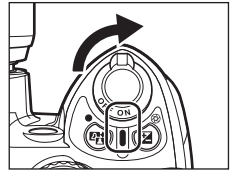

①

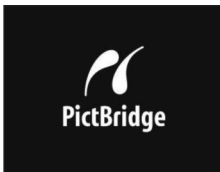

②



Connecting the USB Cable

Be sure that the connectors are oriented correctly, and do not use force, to connect the USB cable.

When disconnecting the USB cable, do not pull the connector at an angle.

Download from www.Somanuals.com. All Manuals Search And Download.

Printing Photographs One at a Time

- 1** Press the multi selector left or right in the PictBridge playback display (85) to choose a photograph.

To view six photographs at a time, press or press to display the highlighted photograph full frame.

Press to zoom in on the current photograph.

Photographs can be selected while checking details using the same operations available with playback zoom (77).

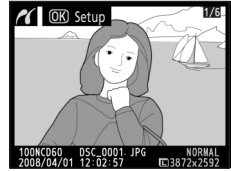

- 2** Press **OK**.

The menu shown at right will be displayed.

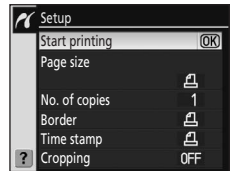

- 3** Set each option in **Setup**.

Press the multi selector up or down to highlight an option and press to the right to select.

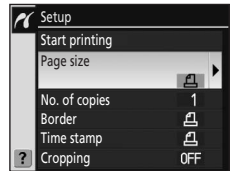

Page size

Press the multi selector up or down to choose page size. Only paper sizes supported by the current printer among **Printer default** (print at current printer settings), **3.5 × 5 in.**, **5 × 7 in.**, **100 × 150 mm**, **4 × 6 in.**, **8 × 10 in.**, **Letter**, **A3**, **A4** will be displayed. Press **OK** to select and return to the setup screen.

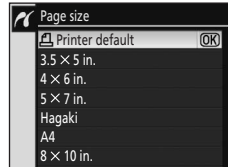

No. of copies

Press the multi selector up or down to choose number of copies (maximum 99), then press **OK** to select and return to the setup screen.

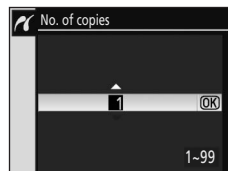

Border

Press the multi selector up or down to choose print style from **Printer default** (print at current printer settings), **Print with border** (print photo with white border), or **No border**, then press **OK** to select and return to the setup screen. **Border** can be selected only when supported by the current printer.

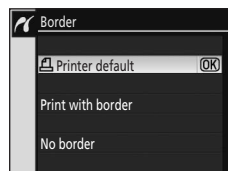

Time stamp

Press the multi selector up or down to choose **Printer default** (print at current printer settings), **Print time stamp** (print time and date of recording on photo), or **No time stamp**, then press **OK** to select and return to the setup screen.

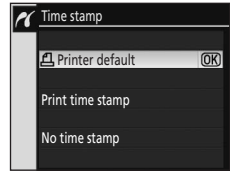

Cropping

To exit without cropping photograph, highlight **No cropping** and press **OK**. To crop photograph, highlight **Crop** and press the multi selector right.

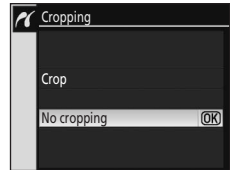

If **Crop** is selected, dialog shown at right will be displayed. Press to create larger crops or to create smaller crops. Use the multi selector up, down, left, or right to choose position of crop. Press **OK** to return to the setup screen.



4 Highlight **Start printing** and press **OK**.

Printing can be canceled by pressing **OK** while printing is in progress. The screen shown in step 1 will be displayed when printing is complete.

Cropping Photographs

Photographs printed at a size larger than they actually are will likely appear coarse or grainy.

Printing Date

Note the following when printing photographs on which the date has been imprinted using Custom Setting 18 (**Date imprint**, 115).

- Select **No time stamp** for **Setup>Time stamp**. When **Print time stamp** is selected, the date will be printed twice.
- When **No border** is selected for **Border**, or depending upon the **Cropping** setting, the date printed may extend beyond the edge of the paper.

Printing Error

If an error occurs during printing, the camera will display the dialog shown at right. After checking the printer, press the multi selector up or down to highlight **Continue** and press **OK** to resume printing. Select **Cancel** to exit without printing the remaining pages. Printing cannot be resumed with some errors.

Printing at Printer Default

When specifying the **Page size**, **Border**, or **Time stamp** setting, choose **Printer default** to print at current printer settings.

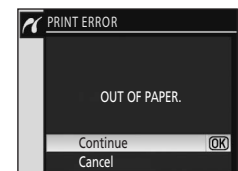
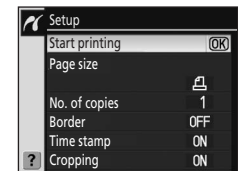

Printing Multiple Photographs

To print multiple photographs, press **MENU** in the PictBridge playback display (📷 85). The PictBridge menu shown at right will be displayed.

Print select

Print selected photographs.

Print (DPOF)

Print photographs for which a DPOF print order has been created from the **Print set (DPOF)** option (📷 90) in the playback menu.

Index print

Create index print of all JPEG photographs.

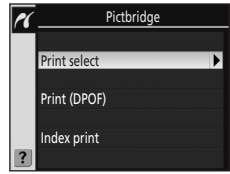

Selecting Photographs for Printing

Choosing **Print select** and then pressing the multi selector right displays the menu shown in step 1.

1 Scroll through photographs.

To display current photograph full screen, press and hold 🔍.

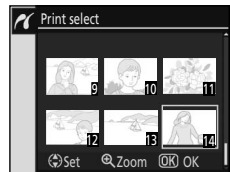

2 Select current photograph and set number of prints (up to 99).

Selected photographs are marked with 📄 and a numeral indicating the number of copies to be printed.

To deselect photograph, press the multi selector down when the number of prints indicated is one.

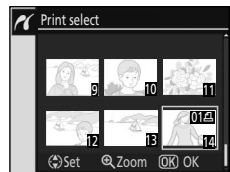

3 Repeat steps 1 – 2 to select additional photographs.

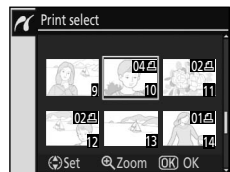

4 Display print options. Choose page size, border, and time stamp options as described in “Printing Photographs One at a Time” (📷 86). To start printing, highlight **Start printing** and press **OK**. PictBridge menu will be displayed when printing is complete.

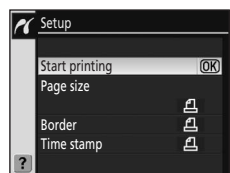

To cancel printing while printing is in progress, press **OK**.

Download from www.Somanuals.com. All Manuals Search And Download.

Creating an Index Print

Print “contact sheets” of small thumbnail images of all JPEG photographs.

- 1 Press **MENU** in the PictBridge playback display (85).

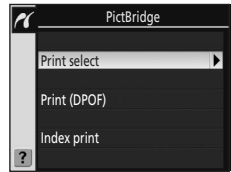

- 2 Select **Index print** and press the multi selector right to display the menu shown at right.

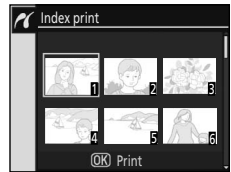

- 3 Press **OK**.

Display print options. Choose page size, border, and time stamp options as described in “Printing Photographs One at a Time” (86).

To start printing, highlight **Start printing** and press **OK**. PictBridge menu will be displayed when printing is complete.

To cancel printing while printing is in progress, press **OK**.

Contact sheets cannot be printed on some paper sizes. A warning will be displayed if selected page is too small.

Up to 256 photographs can be printed. Not all of photographs can be printed if there are 257 or more photographs recorded on the memory card.

A confirmation dialog will be displayed.

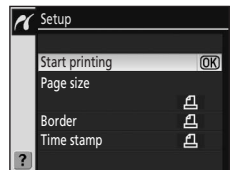

Creating a DPOF Print Order: Print Set

When printing from a memory card inserted in the printer's card slot or directly from the camera connected to a printer (🔍 84), or when having photographs printed by a professional developer or digital print center, photographs can be printed as indicated in the DPOF print order you have created for your photographs on the memory card. Note that the printer and digital print center must support the DPOF standard.

1 Selecting **Print set (DPOF)** from the playback menu (🔍 96).

See "Using Camera Menus" (🔍 94) for more information on using the camera menus.

Highlight **Select / set**.



2 Display selection dialog.

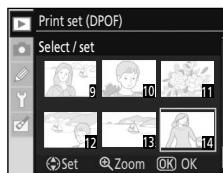

3 Scroll through photographs.

To display current photograph full screen, press and hold 🔍.



4 Select current photograph and set number of copies (up to 99).

Selected photographs are marked with 🖨️ and a numeral indicating the number of copies to be printed. To deselect photograph, press the multi-selector down when the number of print indicated is one.

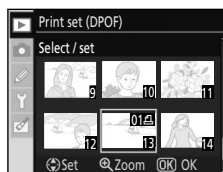

5 Repeat steps 3-4 to select additional photographs.

Once the number of copies has been specified for all selected photographs, proceed to step 6.

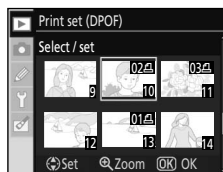

🔪 Printing NEF (RAW) Photographs

Direct printing of NEF (RAW) photographs (🔍 50) is not possible. Create a DPOF print order of JPEG-format copies created from NEF (RAW) photographs using **Quick retouch** or **NEF (RAW)**

6 Display options. Highlight option and press the multi selector right.

- **Data imprint:** Print shooting information (shutter speed and aperture) on all photographs in print order.
- **Imprint date:** Print date of recording on all photographs in print order.

To complete print order and exit, highlight **Done** and press **OK**.

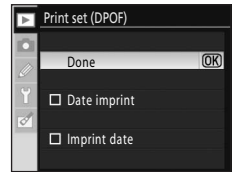

Canceling the Print Orders

To remove all photographs from the print order, select **Deselect all?** in the print set (DPOF) screen shown in step 1 and press **OK**. The dialog shown at right will be displayed and display will return to the playback menu.

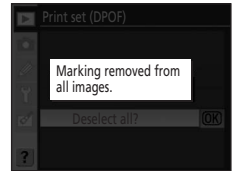

Printing the Current Print Order When the Camera is Connected to a PictBridge Printer

1 Connect the camera to a printer (83). Press **MENU** in the PictBridge playback display.

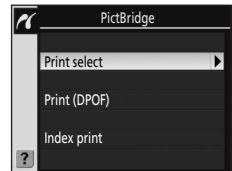

2 Select **Print (DPOF)** and press the multi selector right.

3 Follow the steps in "Selecting Photographs for Printing" to modify and print the current order (88).

DPOF date and data imprint options are not supported when printing via direct USB connection; to print the date of recording on photographs in the current print order, use the PictBridge **Time stamp** option.

✓ Date Imprint

- When Custom Setting 18 (**Date imprint**; 115) is enabled, the date and time can be imprinted on photographs printed from printers that do not normally support the printing of date and time. Only the **Date imprint** date and time will be printed, regardless of whether or not **Print set (DPOF)** is enabled for printing the shooting date and photo information (except when printing with direct connection of the camera to a printer).
- When printing photographs, on which date and time have been imprinted, with direct connection of the camera to a PictBridge-compatible printer, select **No time stamp** for **Time stamp** (87).

✓ Print Set

- The **Print set (DPOF)** option cannot be used if there is not enough space on the memory card to store the print order.
- Print orders may not print correctly if images are deleted using a computer after the print order is created.

Connecting to a Computer, Printer, or TV

Viewing Photographs on TV

A Video Cable EG-D100 (available separately;  156) can be used to connect the camera to a television or VCR for playback or recording.

- 1 **Turn the camera off.** Always turn the camera off before connecting or disconnecting the video cable.

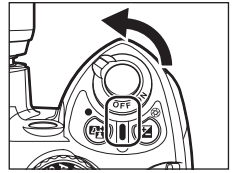

- 2 **Connect the camera to the TV using the video cable.**

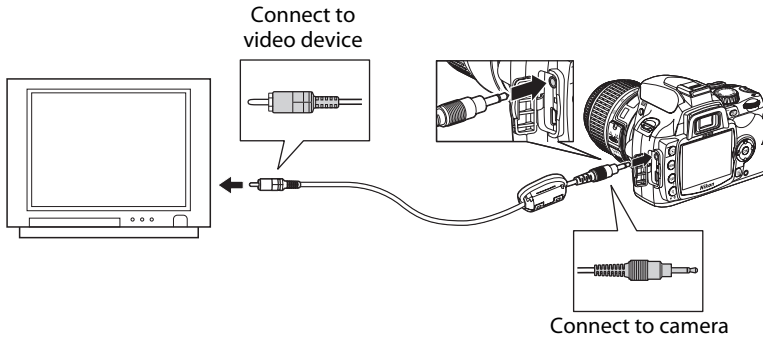

- 3 **Tune the television to the video channel.**

- 4 **Turn the camera on.**

Press  to begin playback. During playback, images will be displayed on the television or recorded to video tape.

Use the same operations for playing images back in the camera monitor to play them back on a television.

The camera monitor will remain off.

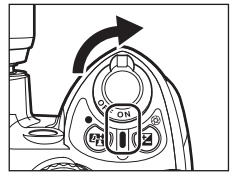

Notes on Power Source

When connecting the camera to a computer or printer, use batteries with adequate charge remaining to prevent the camera from turning off unexpectedly. To power the camera continuously for extended periods, use an optional AC Adapter EH-5a with Power Connector EP-5 ( 156).

Connecting the USB Cable

Be sure that the connectors are oriented correctly, and do not use force, to connect the USB cable. When disconnecting the USB cable, do not pull the connector at an angle.

Video Mode

Be sure that the camera's video mode setting conforms to the standard used by your television. The video mode setting is an option set in the setup menu > **Video mode** ( 123).

Menu Guide

This chapter explains the details and specification of five camera menus.

Playback Options: The Playback Menu (🔍 96)

- Delete (🔍 96)
- Playback folder (🔍 97)
- Rotate tall (🔍 98)
- Slide show (🔍 98)
- Print set (DPOF) (🔍 90)
- Stop-motion movie (🔍 99)

Shooting Options: The Shooting Menu (🔍 100)

- Optimize image (🔍 101, 102)
- Image quality (🔍 50)
- Image size (🔍 50)
- White balance (🔍 52, 103, 104, 105)
- ISO sensitivity (🔍 53)
- Noise reduction (🔍 108)
- Active D-Lighting (🔍 69)

Custom settings (🔍 109)

- R Reset (🔍 110)
- 01 Beep (🔍 110)
- 02 Focus mode (🔍 57)
- 03 AF-area mode (🔍 58)
- 04 Release mode (🔍 54)
- 05 Metering (🔍 62)
- 06 No memory card? (🔍 110)
- 07 Image review (🔍 111)
- 08 Flash compensation (🔍 68)
- 09 AF-assist (🔍 111)
- 10 ISO auto (🔍 111)
- 11 /Fn button (🔍 112)
- 12 AE-L/AF-L (🔍 113)
- 13 AE lock (🔍 113)
- 14 Built-in flash/
optional flash unit (🔍 113)
- 15 Auto off timers (🔍 114)
- 16 Self-timer (🔍 114)
- 17 Remote on duration (🔍 115)
- 18 Date imprint (🔍 115)
- 19 Rangefinder (🔍 116)

Basic Camera Settings: The Setup Menu (🔍 117)

- CSM/setup menu (🔍 118)
- Format memory card (🔍 24)
- Info display format (🔍 120)
- Auto shooting info (🔍 122)
- Shooting info auto off (🔍 123)
- World time (🔍 21)
- LCD brightness (🔍 123)
- Video mode (🔍 123)
- Language (🔍 123)
- Image comment (🔍 124)
- Folders (🔍 125)
- File no. sequence (🔍 126)
- Clean image sensor (🔍 126)
- Mirror lock-up (🔍 126)
- Firmware version (🔍 126)
- Dust off ref photo (🔍 127)
- Auto image rotation (🔍 128)

Creating Retouched Copies: The Retouch Menu (🔍 129)

- Quick retouch (🔍 132)
- D-Lighting (🔍 132)
- Red-eye correction (🔍 133)
- Trim (🔍 134)
- Monochrome (🔍 134)
- Filter effects (🔍 135)
- Small picture (🔍 136)
- Image overlay (🔍 138)
- NEF (RAW) processing (🔍 140)
- Stop-motion movie (🔍 141)
- Before and after (🔍 143)

Using Camera Menus

To view the menus, press **MENU**.

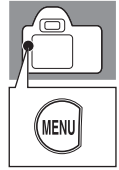

A list of menu options for the icon highlighted at far left is displayed. Menu items that are displayed in gray are not currently available.

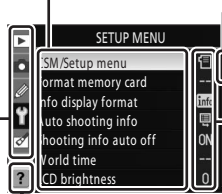

Slider indicates that the current menu contains two or more pages

Current setting for each option is shown by icon

If **[?]** icon is displayed, help for the current item can be viewed by pressing **[?]**

There are five major groups of menus.

	Playback	96
Adjust playback settings and manage photographs.		
	Shooting	100
Adjust shooting settings.		
	Custom Settings	109
Personalize camera settings.		
	Setup	117
Format memory cards and perform basic camera setup.		
	Retouch	129
Create retouched copies of existing photographs.		

The multi selector is used to navigate the camera menus. See the following page for basic instructions on navigating camera menus.

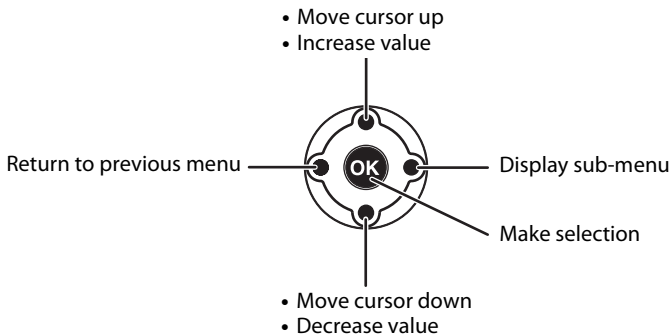

1 Display menus.

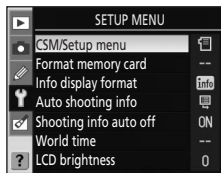
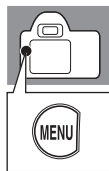

2 Highlight icon in yellow for current menu.

When a menu item is highlighted, the menu icon can be selected by pressing **MENU**.

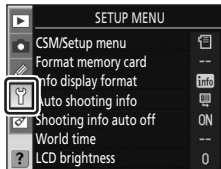

3 Select one of the five menus.

Choose from (playback), (shooting), (Custom Settings), (Setup), or (retouch) menu.



4 Position cursor in selected menu.

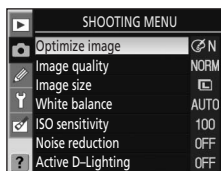

5 Highlight menu item.

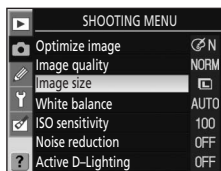

6 Display options for the selected item.

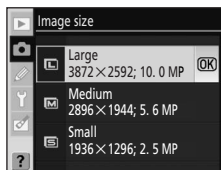

7 Highlight option and press **OK** to make selection.

Setting completes and the monitor returns to step 5. Press the multi selector left to return to the previous list of menu items without making selection.

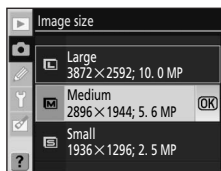

Press the shutter-release button halfway to exit the menu and return to shooting mode. The monitor will turn off.

Playback Options: The Playback Menu

The playback menu contains the following options.

See “Using Camera Menus” (📖 94) for more information on using the menus.



Delete

📖 96

Delete all or selected photographs.

Playback folder

📖 97

Choose folder for playback.

Rotate tall

📖 98

Rotate “tall” (portrait-orientation) photographs during playback.

Slide show

📖 98

Play photographs back in automatic slide shows.

Print set (DPOF)

📖 90

Select photographs for printing and number of copies for each.

Stop-motion movie*

📖 99

View movie files created with the **Stop-motion movie** option (📖 141) from the retouch menu.

* Can be selected only when the memory card contains one or more movie files.

Only selected options for **My menu** (📖 119) will be displayed if **My menu** is selected for the **CSM/Setup menu** option (📖 118) in the setup menu.

Delete

Delete selected photographs or all photographs. Photographs marked with the  icon are protected (📖 78) and cannot be deleted.



Selected

📖 97

Delete selected photographs.



All

Delete all photographs in the folder currently selected for playback.

If the number of photographs to be deleted is very large, some time may be needed to complete the operation.

Selecting Multiple Photographs for Deletion

1 Highlight photograph.

Press and hold  to enlarge display of the selected photograph.

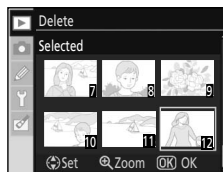

2 Select highlighted photograph.

Selection shown by  icon.

To deselect photograph marked with  icon, highlight and press the multi selector up or down.

Repeat steps 1-2 to select additional photographs.

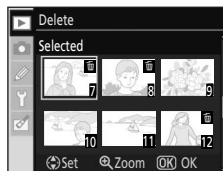

3 Confirmation dialog for deleting selected photographs will be displayed. Highlight **Yes** and press **OK**. To exit without deleting the photographs, highlight **No** and press **OK**.

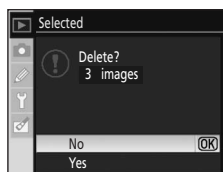

Playback Folder

Select the folder from which images will be played back.



Current (default setting)

Only photographs in the folder currently selected for **Folders** in the setup menu are displayed during playback.

All

Play back photographs in all folders on the memory card.

Playback Folder

- When a new picture is taken, **Current** is automatically selected even if **All** was previously selected. Select **All** again to play back photographs from all folders.
- To select the folder to which new photographs will be recorded, use the **Folders** option ( 125) in the setup menu.
- If a different memory card is inserted after **Current** is selected, a message stating that the folder contains no images will be displayed if  is pressed before any photographs have been taken and recorded to the current memory card. Select **All** to begin playback.

Download from [Www.Somanuals.com](http://www.Somanuals.com). All Manuals Search And Download.

Rotate Tall

Select **On** to rotate “tall” (portrait-orientation) photographs for display in the camera monitor. Default setting is **On**. Photographs taken with **Off** selected for **Auto image rotation** (📷 128) in the setup menu will be displayed in “wide” (landscape) orientation.

Slide Show

Create a slide show of the photographs in the current playback folder.

- Start**
Start slide show.
- Frame interval**
Choose how long each photograph will be displayed.

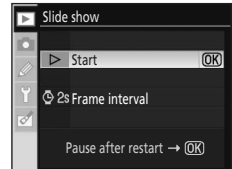

The following operations can be performed during a slide show.

Option	Use	Description
Skip back/skip ahead		Press the multi selector left to return to previous frame, right to skip to next frame.
View photo information		Display and change photo information (📷 73).
Pause slide show	OK	Pause slide show.
Return to playback menu	MENU	End slide show and return to playback menu.
Return to playback mode		End slide show and return to full-frame (📷 72) or thumbnail playback (📷 76).
Return to shooting mode	 or 	Press the shutter-release button halfway or 🔍 to return to shooting mode.







The dialog shown at right is displayed when the show ends or when **OK** is pressed to pause playback. Select **Restart** and press **OK** to restart the show or **Exit** and press **OK** to return to the playback menu.



Stop-Motion Movie

View movie files created with the **Stop-motion movie** option (141) from the retouch menu. A thumbnail list of existing stop-motion movies only is displayed in the monitor. Press the multi selector left or right to choose a file and press **OK** to play back.

Press the multi selector left or right during playback to choose a control at the bottom of the monitor, then press **OK** to perform the selected operation. The following operations are available.

Option	Use	Description
Rewind		Rewind movie. Playback resumes when OK is released.
Advance		Advance movie. Playback resumes when OK is released.
Pause		Pause playback*. While paused, use the multi selector to advance or rewind the stop-motion movie. The following operations can be performed while playback is paused.
		 Rewind movie by one frame. Rewind continues while OK is pressed.
		 Advance movie by one frame. Advance continues while OK is pressed.
		Resume playback.
End		End playback and return to a thumbnail list of stop-motion movies. Return to full-frame playback when stop-motion movie was played from full-frame playback mode.

* If no operations are performed for three minutes while movie is paused, playback ends and the monitor returns to the screen displayed just before playback starts.



During playback
Pausing

Stop-Motion Movies

The **Stop-motion movie** option cannot be selected when the memory card contains no stop-motion movie files.

Shooting Options: The Shooting Menu

The shooting menu contains the following options.

See “Using Camera Menus” (📖 94) for more information on using the menus.

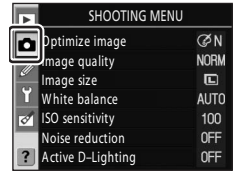

Optimize image* 📖 101, 102

Optimize images according to scene.

Image quality 📖 50

Choose image quality and file format.

Image size 📖 50

Choose image size.

White balance* 📖 52, 103, 104, 105

Adjust colors according to the light source. Fine tune white balance or choose a specific type of fluorescent lighting from the shooting menu.

ISO sensitivity 📖 53

Raise sensitivity when lighting is poor.

Noise reduction 📖 108

Reduce noise at high ISO sensitivities and slow shutter speeds.

Active D-Lighting 📖 69

Preserve details in highlights and shadows, creating photographs with natural contrast.

* Available in **P**, **S**, **A**, and **M** modes only.

Only selected options for **My menu** (📖 119) will be displayed if **My menu** is selected for the **CSM/Setup menu** option (📖 118) in the setup menu.

Optimize Image

Optimize contrast, sharpening, and other settings according to how photographs will be used or the type of scene.



Normal (default setting)

Recommended for most situations.



Softer

Softens outlines, producing natural results suitable for portraits or retouching on a computer.



Vivid

Enhances saturation, contrast, and sharpness to produce vivid images with vibrant reds, greens, and blues.



More vivid

Maximizes saturation, contrast, and sharpness to produce crisp images with sharp outlines.



Portrait

Lowers contrast while lending natural texture and rounded feel to skin of portrait subjects.



Black-and-white

Shoot in black-and-white.



Custom

Customize image optimization settings (🔧 102).

Optimize Image

- Use a type G or D lens for best results. Results are optimized for current shooting conditions and vary with exposure and the position of the subject in the frame.
- For consistent results over a series of photographs, select **Custom** and choose a setting other than **Auto** for image sharpening, tone compensation, and saturation.
- Settings other than **Custom** use the sRGB color space.

Customizing Image Enhancement Options: Custom

Select **Custom** to make separate adjustments to the following options. After adjusting settings, highlight **Done** and press **OK**.

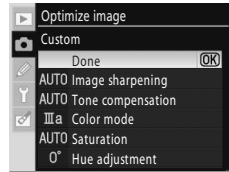



Image sharpening

Choose how much outlines are sharpened during shooting from **Auto, Normal, Low, Medium low, Medium high, High, or None**. Choose high settings for sharp outlines, low settings for softer outlines. Default setting is **Auto**.

Tone compensation

Choose the level of contrast control from **Auto, Normal, Less contrast, Medium low, Medium high, More contrast, or Custom**. Lower settings prevent loss of detail in highlights under harsh lighting or in direct sunlight. Higher settings preserve detail in misty landscapes and other low-contrast subjects. Default setting is **Auto**. Choose **Custom** to select a user-defined tone curve created using Camera Control Pro 2 (available separately;  156). See the documentation provided with Camera Control Pro 2 for details.

Color mode

Specify the way in which colors are reproduced from the following.

Ia (sRGB)

Photographs taken in this mode are adapted to the sRGB color space and are suited to printing or use "as is", with no further modification. Choose this option for portrait.

II (Adobe RGB)

Photographs taken in this mode are adapted to Adobe RGB color space, which supports a wider gamut of colors than sRGB. This option is the preferred choice for photographs that will be extensively processed or retouched.

IIIa (sRGB) (default setting)

Photographs taken in this mode are adapted to the sRGB color space and are suited to printing or use "as is", with no further modification. Choose this option for nature and landscape shots.

Saturation

Choose the level of saturation (color intensity) from **Auto, Normal, Moderate, or Enhanced**. Choose **Moderate** for less saturated colors, **Enhanced** for more vivid colors. Default setting is **Auto**.

Hue adjustment

Hue can be adjusted between -9° to $+9^\circ$ in increments of 3° (the degrees refer to the "color wheel" often used to express hue). Positive values make reds more orange, greens more blue, and blues more purple. Negative values make reds more purple, blues more green, and greens more yellow. Default setting is ± 0 .

Color Mode

- Modes Ia and IIIa are recommended for photos that will be printed without modification or viewed in applications that do not support color management.
- If the application supports color management, choose the Adobe RGB color space when opening photos taken in mode II. See the documentation provided with the application for details.



Color Space

The color space determines the gamut of colors available for color reproduction. sRGB is for general use, while Adobe RGB is used in publishing and commercial printing.

Hue Adjustment

Color consists of three elements, saturation, hue, and brightness. The **Hue adjustment** option is for adjusting one of these elements, hue. As color wheels are often used to express hue, with the degree of rotation of the color wheel indicating the level of hue adjustment, angular degrees are the units used.

White Balance

Change the white balance setting ( 52). In addition to the options available from the Quick settings display detailed in “White Balance”, a specific type of fluorescent lighting can be specified. White balance can also be fine tuned ( 104). If fine tuning is not necessary, set the fine tuning value to 0 and press **OK**.

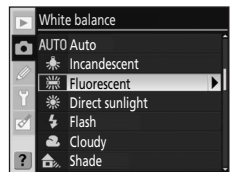

Specifying Fluorescent Lighting

Select **Fluorescent** to specify a specific fluorescent lighting from the following options.

1 Sodium-vapor lamps

For shooting under sodium-vapor lamps, such as those used in stadiums or gymnasiums.

2 Warm-white fl.

For shooting under warm-white fluorescent lighting.

3 White fluorescent

For shooting under white fluorescent lighting.

4 Cool-white fluorescent

For shooting under cool-white fluorescent lighting.

5 Day white fluorescent

For shooting under daylight white fluorescent.

6 Daylight fluorescent

For shooting under daylight fluorescent.













7 Mercury-vapor lamps

For shooting under mercury-vapor lamps.

Color Temperature

The perceived color of a light source varies with the viewer and other conditions. Color temperature is an objective measure of the color of a light source, defined with reference to the temperature to which an object would have to be heated to radiate light in the same wavelengths. While light sources with a color temperature in the neighborhood of 5,000– 5,500K appear white, light sources with a lower color temperature, such as incandescent light bulbs, appear slightly yellow or red. Light sources with a higher color temperature appear tinged with blue.

Approximate color temperatures for each white balance setting are given below (when fine tuned white balance setting is ± 0). Values may differ from color temperatures given by photo color meters.

White balance	Color temperature	White balance	Color temperature
AUTO Auto	3,500 K~8,000 K	 6 Daylight fluorescent	6,500 K
 Incandescent	3,000 K	 7 Mercury-vapor lamps	7,200 K
 1 Sodium-vapor lamps	2,700 K	 Direct sunlight	5,200 K
 2 Warm-white fl.	3,000 K	 Flash	5,400 K
 3 White fluorescent	3,700 K	 Cloudy	6,000 K
 4 Cool-white fluorescent	4,200 K	 Shade	8,000 K
 5 Day white fluorescent	5,000 K		

Fine-Tuning White Balance

Unless **Preset manual** is selected, white balance can be “fine tuned” to compensate for variations in the color of the light source or to introduce a deliberate color cast into an image.

1 Select a white balance option except **Preset manual**.

Select **White balance** in the shooting menu, then highlight a white balance option and press the multi selector right. If **Fluorescent** is selected, highlight a lighting type and press the multi selector right.

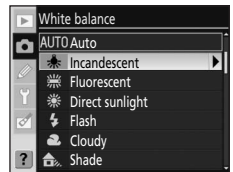

2 Fine tune white balance.

Use the multi selector to finetune white balance. White balance can be fine tuned on the amber (A)–blue (B) axis and the green (G)–magenta (M) axis. The horizontal (amber/blue) axis corresponds to color temperature, with each increment equivalent to about 5 mired. The vertical (green/magenta) axis has the similar effects to the corresponding color compensation (CC) filters.

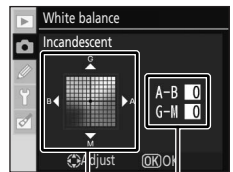

Adjustment Coordinates

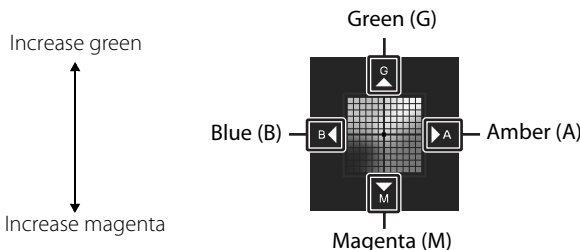

3 Press **OK**.

Press **OK** to select and return to the shooting menu.

At settings other than ± 0 , “*” will appear next to the white balance icon in the Shooting information display.

White Balance Fine Tuning

The colors on the fine-tuning axes are relative, not absolute. For example, moving the cursor to **B** (blue) when a “warm” setting such as  (incandescent) is selected for white balance will make photographs slightly “colder” but will not actually make them blue.

“Mired”

Any given change in color temperature produces a greater difference in color at low color temperatures than it would at higher color temperatures. For example, a change of 1,000 K produces a much greater change in color at 3,000 K than at 6,000 K. Mired, calculated by multiplying the inverse of the color temperature by 10^6 , is a measure of color temperature that takes such variation into account, and as such is the unit used in color-temperature compensation filters. E.g.:

- 4,000 K–3,000 K (a difference of 1,000 K)=83 mired
- 7,000 K–6,000 K (a difference of 1,000 K)=24 mired

Preset Manual

Preset manual can be used when the desired results cannot be achieved at other settings or to match white balance manually to the value used in an existing photograph. Two methods are available for setting preset white balance.

Measure

Neutral gray or white object is placed under lighting that will be used in final photograph and white balance is measured directly by camera.

Use photo

White balance is copied from existing photograph on memory card.

Measuring a Value for Preset White Balance

Note that only one photograph can be selected at a time as the white balance source for preset manual.

Be aware that each time new preset white balance data is measured by the camera, existing preset data is overwritten.

- 1 Place a neutral gray or white object under the lighting that will be used in the final photograph. A standard gray card can be used as a reference in studio settings.

- 2 Display the shooting menu and select **White balance**>
Preset manual, and then press the multi selector right.

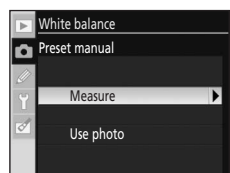

3 Highlight **Measure** and press the multi selector right.

The screen shown at right will be displayed; highlight **Yes** and press **OK**.

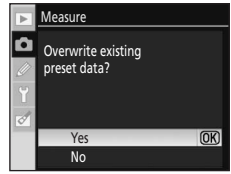

4 The message, **Take photo of white or gray object filling viewfinder under lighting for shooting.** will be displayed.

When the message clears from the display, the viewfinder and shooting information white balance displays will flash as shown at right.



5 Frame the reference object so that it fills the viewfinder and press the shutter-release button all the way down.

White balance can be measured even when the camera is not in focus.

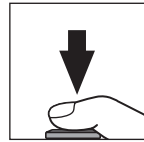

6 If the camera was able to measure a value for white balance, the message **Data acquired.** will be displayed.

White balance will automatically be set to the measured value.



If the warning shown at right is displayed, the camera was unable to measure white balance. Return to step 2 and measure white balance again.



✓ Measuring Value

- Note that if a new value is measured for white balance, white balance will be set to the measured value even if **Use photo** is currently selected.
- Use a standard "gray card", or other reflectivity card intended for white balance measurement, with 18% reflectivity (available separately) to measure a precise white balance value.
- Do not alter exposure from the value selected by the camera; when shooting in mode **M**, use the electronic analog exposure display to select optimum exposure.

✍ Other Ways to Measure a Value

The following methods can also be used to measure a value for preset white balance.

- To proceed directly to step 4 without displaying the shooting menu, select **Preset manual** for white balance in the Quick settings display (📷 52) and press **OK** for a few seconds.
- If **White balance** is selected for Custom Setting 11 (🔄/Fn button; 📷 112), pressing **Fn** for a few seconds when preset manual is in effect will display the indicators shown in step 4.

Copying White Balance from a Photograph

A white balance value copied from an existing photograph can be used for preset manual. Note that only one photograph can be selected at a time as a source for preset manual. Each time new preset data is acquired with **Use photo**, the existing preset data will be overwritten.

- 1 Select **White balance** > **Preset manual** in the shooting menu and press the multi selector right.

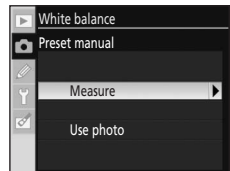

- 2 Highlight **Use photo** and press the multi selector right.

To use the current source photograph as preset data, highlight **This image** and press the multi selector right. The setting will be applied.

To choose a new photograph, highlight **Select image** and press the multi selector right. Proceed to step 3.

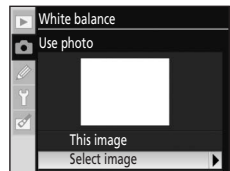

- 3 Press the multi selector up or down to highlight the folder containing the desired source photograph.

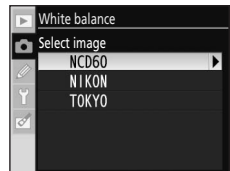

- 4 Press the multi selector right.

Images in the selected folder will be displayed.

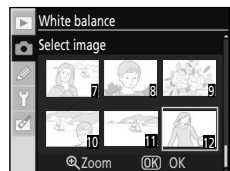

- 5 Press the multi selector left or right to highlight photograph.

Press and hold **Q** to enlarge display of the selected photograph.

Press **OK** to apply the setting. The display will return to shooting menu.

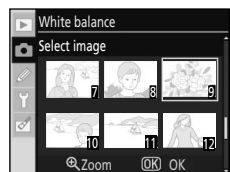

Source for Preset Manual

Images displayed may include those created with other cameras, but only photographs created with D60 can be used as source for preset manual.

Download from www.Somanuals.com. All Manuals Search And Download.

Noise Reduction

Photographs taken at high sensitivities or at shutter speeds of eight seconds or slower can be processed to reduce “noise” in the form of mottling or randomly-spaced, brightly-colored pixels. Choose from the following options.

Off (default setting)

Noise reduction turns off at ISO sensitivities of 800 or less. Minimal noise reduction is still performed at ISO sensitivities over 800.

On

Photographs taken at ISO sensitivities over ISO 400 or at shutter speeds of about eight seconds or slower are processed to reduce noise. In continuous release mode, frame rates will slow and the capacity of the memory buffer will drop. (At shutter speeds of eight seconds or slower, **⓪ⓑ ⓃⓇ** will blink at the bottom of the viewfinder for a period of time approximately equal to the current shutter speed. New photographs can be taken when **⓪ⓑ ⓃⓇ** is no longer displayed. Noise reduction will not be performed if the camera is turned off while **⓪ⓑ ⓃⓇ** is blinking in the viewfinder before processing is complete.)

Custom Settings

The Custom Setting menu contains the following options. See “Using Camera Menus” (📖 94) for more information on using the menus.

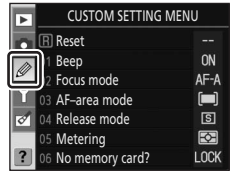

R Reset 📖 110

Restore all Custom Settings to default values.

01 Beep 📖 110

Turn on or off the beep that sounds when the camera focuses or when the self-timer or remote control is used.

02 Focus mode 📖 57

Choose the focus mode.

03 AF-area mode 📖 58

Choose how the camera selects the focus point.

04 Release mode 📖 54

Choose the manner in which the shutter is released.

05 Metering¹ 📖 62

Choose how the camera sets exposure.

06 No memory card? 📖 110

Enable or disable the shutter-release button when no memory card is inserted in the camera.

To display the following options, select **Full** for **CSM/Setup menu** (📖 118) in the setup menu.

07 Image review 📖 111

Choose whether photographs are displayed immediately after they are taken.

08 Flash compensation¹ 📖 68

Adjust flash level.

09 AF-assist² 📖 111

Enable or disable the AF-assist illuminator.

10 ISO auto¹ 📖 111

Choose the maximum ISO value used for auto sensitivity control.

11 Fn button 📖 112

Choose the function assigned to  Fn.

12 AE-L/AF-L 📖 113

Choose the function performed by .

13 AE lock 📖 113

Choose if exposure locks when the shutter-release button is pressed halfway.

14 Built-in flash/Optional flash unit¹ 📖 113

Choose a flash control option for the built-in flash or optional SB-400 Speedlight.
Download from www.Somanuals.com. All Manuals Search And Download.

15 Auto off timers 114

Choose how long the monitor and exposure meters remain on.

16 Self-timer 114

Choose the length of the self-timer delay.

17 Remote on duration 115

Select the length of time the camera will wait for a signal from the remote before canceling remote control mode.



18 Date imprint 115



Directly imprint photographs with the date or date and time of recording.

19 Rangefinder 116

Choose whether a scale indicating the focus distance with manual focus is displayed in the viewfinder, replacing the electronic analog exposure display, in all shooting modes except **M**.

¹ Available in **P**, **S**, **A**, and **M** modes.







² Available in all shooting modes except  and .

Only selected options for **My menu** ( 119) will be displayed if **My menu** is selected for the **CSM/Setup menu** option ( 118) in the setup menu.

R Reset

Select **Yes** to restore all Custom Settings to their default values. See the Appendix ( 176) for a complete list of default settings.



01 Beep

At the default setting of **On**, a beep will sound when the camera focuses in autofocus mode (when  is selected, when **AF-C** is selected or the subject is judged to be moving in **AF-A** autofocus mode ( 57), beep will not sound), while the release timer is counting down in self-timer and delayed remote modes ( 55), or when a photograph is shot in quick-response remote mode ( 55). The beep will not sound when **Off** is selected. The current setting is shown in the Shooting information display:  is displayed when the beep is on,  when it is off.

06 No Memory Card?

If **Release locked** (default setting) is selected, the shutter-release is disabled when no memory card is inserted. Choose **Enable release** to enable the shutter-release button when no memory card is inserted. Photographs will be displayed in the monitor with the word "Demo" but will not be saved to the memory card and cannot be printed.

07 Image Review (Displayed When **Full** Is Selected; 118)

If **On** (default setting) is selected, photographs will automatically be displayed in the monitor after shooting. The length of time photographs are displayed depends on the option selected for Custom Setting 15 (**Auto off timers**;  114). If **Off** is selected, photographs can be displayed in the monitor by pressing .

09 AF-assist (Displayed When **Full** Is Selected; 118)

If **On** (default setting) is selected and the subject is poorly lit, the AF-assist illuminator will light when required to assist the focus operation ( 57). Choose **Off** to disable the AF-assist illuminator. Note that when the illuminator is off, the camera may not be able to focus on poorly-lit subjects using autofocus.

10 ISO Auto (Displayed When **Full** Is Selected; 118)

Choose whether the camera automatically adjusts ISO sensitivity when optimal exposure cannot be achieved at ISO sensitivity selected by the user. ISO auto can be used with the flash. Available in **P**, **S**, **A**, and **M** modes.



Off (default setting)

ISO sensitivity will remain fixed at the value selected by the user ( 53).

On

ISO sensitivity will automatically be adjusted if optimal exposure cannot be achieved at the selected value (flash level is adjusted appropriately).

Max. sensitivity

Photographs taken at higher ISO sensitivities often appear “grainy”. Choose the maximum ISO sensitivity to prevent ISO auto from increasing the ISO sensitivity setting too much. ISO auto will not raise ISO sensitivity above the selected value.

Min. shutter speed

Choose the shutter speed at which ISO auto takes effect in modes **P** and **A**. In modes **P** and **A**, sensitivity will only be adjusted if underexposure would result at the shutter speed selected for this option (slower shutter speeds may be used if optimal exposure cannot be achieved at the value selected for maximum sensitivity).

When **On** is selected, the indicators appear in the viewfinder and Shooting information display as shown at right. When these indicators are displayed, photographs are taken at the ISO sensitivity selected by the user. Unless a flash is used, these indicators blink when sensitivity is altered from the value selected by the user. Note that noise is more likely at higher sensitivities.



Adjustments made to ISO sensitivity by ISO auto can be confirmed in the shooting data display (📷 73).

✏️ ISO Auto

Auto ISO control is not available when Digital Vari-Program modes are selected, or at an ISO sensitivity of **Hi 1**. When **Hi 1** is selected for **ISO sensitivity**, ISO sensitivity will not be adjusted even if **On** is selected for **ISO Auto**. Foreground subjects may be underexposed in photos taken with the flash at slow shutter speeds, in daylight, or against a bright background. Choose a flash mode other than slow sync or select mode **A** and choose a larger aperture.

11 🕒/Fn Button (Displayed When **Full** Is Selected; 📷 118)

Choose the function performed by 🕒/Fn.

🕒 Self-timer (default setting)

Press 🕒/Fn to select self-timer mode (📷 55).

📷 Release mode

Press 🕒/Fn and rotate the command dial to select release mode (📷 54).

QUAL Image quality/size

Press 🕒/Fn and rotate the command dial to select image quality (📷 50) and size (📷 50).

ISO ISO sensitivity

Press 🕒/Fn and rotate the command dial to select ISO sensitivity (📷 53).

WB White balance



Press 🕒/Fn and rotate the command dial to select white balance (**P**, **S**, **A**, and **M** modes only; 📷 52).

At settings other than **Self-timer** (default setting), the Shooting information display will show a **Fn** icon to the left of the setting that can be adjusted by pressing 🕒/Fn and rotating the command dial (when **Classic** is selected for **Info display format** in the setup menu only; 📷 120).

12 AE-L/AF-L (Displayed When **Full** Is Selected; 118)

Choose the function performed by .



AE/AF lock (default setting)

Both focus and exposure lock while  is pressed ( 60, 63).

AE lock only

Exposure locks while  is pressed. Focus is unaffected ( 63).

AF lock only

Focus locks while  is pressed. Exposure is unaffected ( 60).

AE lock hold

Exposure locks when  is pressed and remains locked until the button is pressed again or the exposure meters turn off ( 63).

AF AF-ON

 initiates autofocus. The shutter-release button cannot be used to focus ( 60).

13 AE Lock (Displayed When **Full** Is Selected; 118)

If **Off** (default setting) is selected, pressing the shutter-release button halfway does not lock exposure ( 63). If **On** is selected, exposure will lock when the shutter-release button is pressed halfway.

14 Built-in Flash/Optional Flash Unit

(Displayed When **Full** Is Selected;  118)

Choose a flash control mode for the built-in flash or the optional SB-400 Speedlight. Available in **P**, **S**, **A**, and **M** modes.

When an optional SB-400 Speedlight is attached, Custom Setting 14 is used to choose the flash control mode for the SB-400 and the name changes to **Optional flash unit**.

TTL TTL (default setting)

Flash output is adjusted automatically in response to shooting conditions.

M Manual

The flash fires at the level selected in the menu shown at right. At full power, the built-in flash has a Guide Number of 13/43 (ISO 100, m/ft., 20°C/68°F).

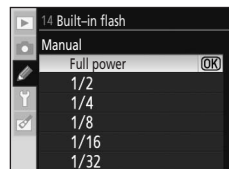

A  icon flashes in the viewfinder and Shooting information display when **Manual** is selected.



15 Auto off Timers (Displayed When **Full** Is Selected; 118)

If no operations are performed for the selected length of time, the monitor and the viewfinder will turn off to reduce the drain on the battery. Choose the time allowed to elapse before the monitor and exposure meters turn off.

The monitor and exposure meters turn off automatically in conjunction with auto meter-off.

SHORT Short

Monitor will turn off when no operations are performed for eight seconds during playback and while menus are displayed. Photographs are displayed in the monitor for four seconds after shooting. Exposure meters will turn off after four seconds.

NORM Normal (default setting)

Monitor will turn off when no operations are performed for 12 seconds during playback or while menus are displayed. Photographs are displayed in the monitor for four seconds after shooting. Exposure meters will turn off after eight seconds.

LONG Long

Monitor will turn off when no operations are performed for 20 seconds during playback or while menus are displayed. Photographs are displayed in the monitor for 20 seconds after shooting. Exposure meters will turn off after one minute.





Custom

Time settings for the following options can be specified individually. Once the setting has been specified, highlight **Done** and press **OK** to apply the setting.



Playback/menus: Choose how long the monitor remains on for menus and playback from **8 s, 12 s, 20 s, 1 min.**, or **10 min.**

Image review: Choose how long photographs are displayed in the monitor after shooting from **4 s, 8 s, 20 s, 1 min.**, or **10 min.**

Auto meter-off: Choose the length of time before the exposure meters turn off from **4 s, 8 s, 20 s, 1 min.**, or **30 min.**

When **On** (default setting) is selected for Custom Setting 07 (**Image review**;  111), the monitor and exposure meters will turn off in conjunction with the time specified for **Auto off timers**>**Custom**>**Image review**. When a remote control is used ( 55), the monitor and exposure meters remain on for the length of time selected for Custom Setting 17 (**Remote on duration**;  115).

Auto Off

- The longer the monitor and exposure meters remain on, the sooner the battery will be exhausted.
- Regardless of the setting chosen, the exposure meters do not turn off automatically when the camera is powered by an optional AC Adapter EH-5a with a Power Connector EP-5 ( 156).
- Monitor and viewfinder display do not turn off automatically when the camera is connected to a computer ( 80) or PictBridge printer ( 83).

16 Self-Timer (Displayed When **Full** Is Selected; 118)

Choose the length of the shutter-release delay in self-timer mode ( 55) from **2 s, 5 s, 10 s** (default setting), or **20 s**.

17 Remote on Duration (Displayed When **Full** Is Selected; 118)

Choose how long the camera will wait for a signal from the remote before cancelling delayed or quick-response remote modes ( 55) from **1 min.** (default setting), **5 min.**, **10 min.**, or **15 min.**

Remote control mode is cancelled if the length of time selected elapses without no photographs have been taken after selection of the remote control mode.

18 Date Imprint (Displayed When **Full** Is Selected; 118)

Date and time of recording can be imprinted on photographs.

Off (default setting)

Date and time are not imprinted on photographs.

Date

Date is imprinted on the bottom right corner of photographs taken while this option is in effect.

Date and time

Date and time are imprinted on the bottom right corner of photographs taken while this option is in effect.

Date counter (116)

Time stamp shows number of days between date of recording and selected date.

At settings other than **Off**, **DATE** appears in the Shooting information display.





Date is imprinted on photographs as shown below.

Photographs taken in "tall" (portrait) orientation with **On** selected for **Auto image rotation** ( 128)



Date Imprint

- Imprinted dates form a permanent part of image data and cannot be deleted.
- The date is recorded using the format selected in **Date** item ( 21).
- Date and time cannot be imprinted on photographs taken at image quality settings ( 50) of **RAW** or **RAW+B**.

Date Imprint and Print Set

When printing from DPOF-compatible printers which support printing of shooting date and photo information, the date and information can be printed on photographs without date and time imprinted on them, using options in the **Print set** menu ( 90).

Download from www.Somanuals.com. All Manuals Search And Download.

Date Counter

Photographs taken while this option is in effect are imprinted with the number of days remaining until, or the number of days elapsed since a specified date. Use it to track the growth of a child or count down the days until a birthday or wedding.

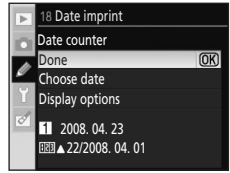

Choose date

When the date counter is applied for the first time, or the multi selector is pressed right after one of the three options has been selected, the **Set date** screen will be displayed. Enter a date (F 21, step 5), and press **OK**. Up to three dates can be recorded. To select a different date, choose an option and press **OK**.

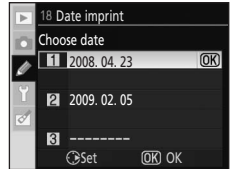

Display options

Choose **Number of days**, **Years and days**, or **Years, months, and days** and press **OK**.



Once the setting for each option has been selected, highlight **Done** and press **OK** to apply the setting.

Sample date counter time stamps are shown below.



Two days remaining



Two days elapsed

19 Rangefinder (Displayed When Full Is Selected; F 118)

In all shooting modes except **M**, selecting **On** with manual focus mode (F 61) enabled causes the electronic analog exposure display in the viewfinder to switch to the rangefinder display, a scale indicating focus distance. This option is useful when focusing manually.

Available when lens with maximum aperture of f/5.6 or faster is used.

Not available in **M** mode.

When shooting a subject with which autofocus does not perform well (F 38), the rangefinder may be unable to accurately measure focus distance.

Display	Description	Display	Description
	Subject inside the selected focus point is in focus.		Indicates focus on a point slightly behind the subject.
	Indicates focus on a point slightly in front of the subject.		Indicates focus on a point quite a distance behind the subject.
	Indicates focus on a point quite a distance in front of the subject.		Focus error. Unable to focus.

Basic Camera Settings: The Setup Menu

The setup menu contains the following options.

See “Using Camera Menus” (📖 94) for more information on using the menus.



CSM/Setup menu	📖 118–119
Choose the options displayed in the menus.	
Format memory card	📖 24
Format memory card.	
Info display format	📖 120–122
Choose a Shooting information display format.	
Auto shooting info	📖 122
Display shooting information when the shutter-release button is pressed halfway and released.	
Shooting info auto off	📖 123
Shooting information display will turn off automatically when looking through the viewfinder.	
World time	📖 21
Set camera clock and choose home and destination time zones.	
LCD brightness	📖 123
Adjust the brightness of the monitor.	
Video mode	📖 123
Adjust settings necessary for connection to television.	
Language	📖 123
Choose the language used for camera monitor display.	
Image comment	📖 124
Add a comment to photographs as they are taken.	

To display the following additional options, select **Full** for **CSM/Setup menu** (📖 118).

Folders	📖 125
Create or choose the folder in which new photographs will be recorded.	
File no. sequence	📖 126
Choose how the camera names files.	
Clean image sensor	📖 126
Remove dust from the image sensor.	
Mirror lock-up	📖 126
Lock the mirror in the up position when inspecting or cleaning the low-pass filter.	
Firmware version	📖 126
Display camera firmware version.	

Dust off ref photo

 127

Acquire reference data for the Image Dust Off option in Capture NX (available separately).

Auto image rotation

 128

Choose whether to record camera orientation with new photographs.



Only selected options for **My menu** ( 119) will be displayed if **My menu** is selected for the **CSM/Setup menu** option.

CSM/Setup Menu

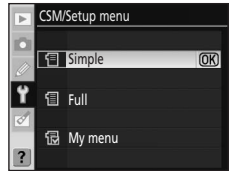
Choose the options displayed in the menus.



Simple (default setting)

Display only basic options in the Custom Settings ( 109) and setup menus ( 117). Other menus list all options.

Full

Display all options.

My menu

Display only selected options.

Choosing Menu Items for My Menu

1 Highlight **My menu** and press the multi selector right.

A list of menu names will be displayed.

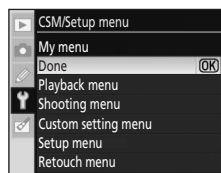

2 Highlight a menu name and press the multi selector right.

The items in the selected menu will be listed as shown at right (the illustration shows the items listed when the playback menu is selected).

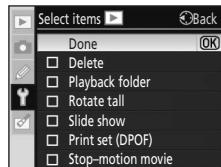

3 Press the multi selector up or down to highlight items and then press to the right to select or deselect.

Selected items are indicated by a check mark () . When the item is deselected, the check mark will be deleted () .

The **CSM/Setup menu** item in the setup menu cannot be selected.

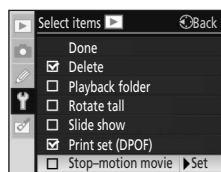

4 Highlight **Done** and press **OK** to return to the list of menu names shown in step 1.

Repeat steps 2–3 to edit additional menus.

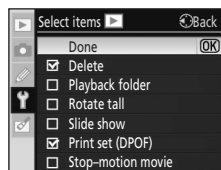

5 Highlight **Done** in the list of menu names and press **OK** to return setup menu.

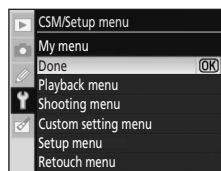

Info Display Format

Choose one of the following Shooting information display (8) formats for Digital Vari-Program (AUTO, P, S, A, M) modes and **P, S, A, and M** modes. Choose from the three formats, **Classic**, **Graphic**, or **Wallpaper**.

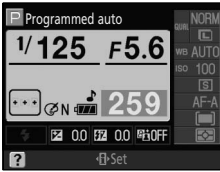

Classic (8) 121



Graphic (8) 8



Wallpaper (8) 122

Setting the Information Display Format

- 1 Highlight **Digital Vari-Program** or **P, S, A, M** and press the multi selector right.

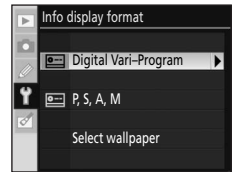

- 2 Highlight a Shooting information display format.

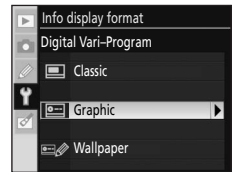

- 3 Highlight a background color or a font color and press **OK**.

When **Graphic** is selected, the background color can be selected from **White**, **Black**, or **Orange**.

When **Classic** is selected, the background color can be selected from **Blue**, **Black**, or **Orange**.

When **Wallpaper** is selected, the font color can be selected from **Dark on light** or **Light on dark**.

Classic

The information displayed in **Classic** format is shown below.

“Wide” (Landscape) Orientation

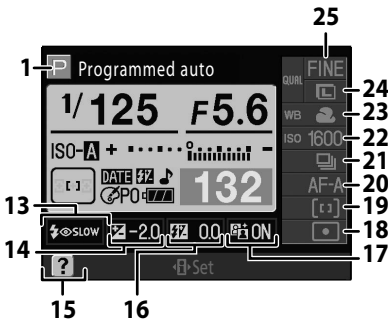

“Tall” (Portrait) Orientation

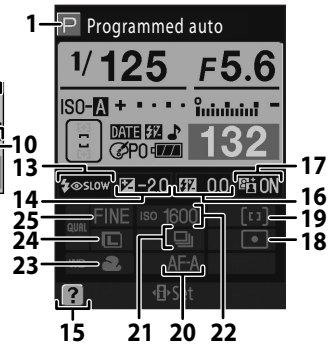

1	Shooting mode	6	11	Electronic analog exposure display	45
2	Shutter speed	40–46	12	Exposure compensation	67
3	ISO auto indicator	111	13	Aperture (f-number)	40–46
4	Date imprint indicator	115	14	Flash sync mode	65
5	Focus point display	26, 30, 58, 59, 60	15	Exposure compensation value	67
6	AF-area mode	58	16	Help indicator	13
7	Optimize image indicator	101	17	Flash compensation value	68
8	Battery indicator	28	18	Active D-Lighting indicator	69
9	“Beep” indicator	110	19	Metering mode	62
	Number of exposures remaining	28, 178	20	AF-area mode	58
	Preset white balance recording indicator	106	21	Focus mode	57
	PC mode indicator	81	22	Release mode	54
10	Manual flash control indicator	113	23	ISO sensitivity	53
	Flash compensation indicator for optional Speedlight	150	24	White balance mode	52, 103, 104
			25	Image size	50
				Image quality	50

Wallpaper

The design of the **Wallpaper** format is the same as the **Graphic** display except that a user-selected photograph is displayed in the background. The shutter speed and aperture displays, and the graphic display of the shooting mode (📷 9) do not appear.



To choose a photograph for the **Wallpaper** format:

- 1 Highlight **Select wallpaper** in the Info display format screen (📷 120, step 1) and press the multi selector right.**

The photographs on the memory card will be displayed.

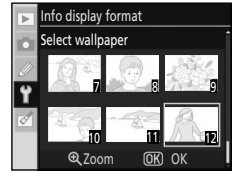

- 2 Press the multi selector left or right to highlight a photograph.**

Press and hold 🔍 to enlarge display of the selected photograph.

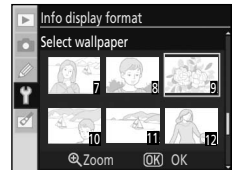

- 3 Press **OK** to select the highlighted photograph and return to the setup menu.**

The camera will record the new wallpaper and use it in the shooting display whenever **Wallpaper** is selected. Only one image is recorded for wallpaper. Any existing wallpaper (including the default image provided with the camera) is deleted when a new image is selected and cannot be restored. Wallpaper cannot be viewed during playback or copied to a memory card.

Auto Shooting Info

Select **On** to automatically display shooting information after the shutter-release button is released. If Custom Setting 7 (**Image review**) is off, shooting information will also be displayed after a photograph is taken. Turn **Auto shooting info** on if you find yourself frequently checking camera settings.

If **Off** is selected, the Shooting information display is not shown by pressing the shutter-release button halfway.

Available in Digital Vari-Program (📷, 📷, 📷, 📷, 📷, 📷, 📷, and 📷) modes or **P**, **S**, **A**, and **M** modes. Note that even if **On** is selected, the monitor will turn off while the shutter-release button is pressed.

Shooting Info Auto off

On (default setting)

The eye sensor under the viewfinder is activated when your face comes closer to the viewfinder while the exposure meters are on, turning the Shooting information display off and the viewfinder display on. The viewfinder display remains off while shooting information is displayed.

Off

The eye sensor function is disabled, and the viewfinder display remains on while shooting information is displayed.

LCD Brightness

Adjust monitor brightness.

LCD brightness

Choose from seven monitor brightness levels between -3 (darkest) and +3 (brightest). Default setting is 0.

Auto dim

When **On** (default setting) is selected, monitor brightness dims gradually while shooting information is displayed.

Video Mode

Choose **NTSC** when connecting the camera to an NTSC television or VCR. Choose **PAL** when connecting the camera to a PAL video device.

Language

Choose one of 15 languages for display of camera menus and messages.



De	Deutsch	German
En	English	English
Es	Español	Spanish
Fi	Suomi	Finnish
Fr	Français	French
It	Italiano	Italian
NI	Nederlands	Dutch
Pl	Polski	Polish

Pt	Português	Portuguese
Ru	Русский	Russian
Sv	Svenska	Swedish
繁	中文(繁體)	Traditional Chinese
簡	中文(简体)	Simplified Chinese
日	日本語	Japanese
한	한글	Korean

Image Comment

Create a comment beforehand and attach it to new photographs as they are taken. Comments can be viewed in Capture NX (available separately;  156) or ViewNX.

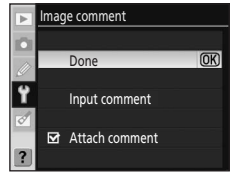



Done

Save changes and return to the setup menu.

Input comment

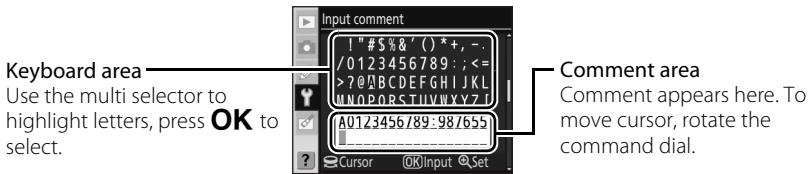
The following dialog will be displayed. Input a comment up to 36 characters in length, and press  to save.



The input comment will begin at the current cursor position in the comment area. Comments can be up to 36 characters long. Any additional characters will be deleted. To delete the character at the current cursor position, press . Press **MENU** to exit without changing the comment.

Attach comment

The comment is added to all photographs taken while this option is checked (). Highlight this option and press the multi selector right to toggle the check mark on or off. Select **Done** and press **OK** to apply the setting.

Folders (Displayed When **Full** Is Selected; 118)

Create new folders on the memory card and choose the folder to which new photographs will be recorded.

Folder names are comprised of a three-digit folder number and a five-digit folder name (e.g., "100NCD60"). Folder numbers are assigned automatically by the camera and folder names can be created by the user.

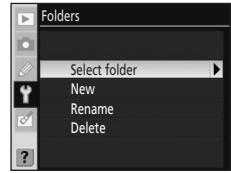

Select folder

Choose the folder in which subsequent photographs will be recorded.



* When the current folder is deleted using the **Delete** option, or a different memory card inserted in the camera, that folder will continue to be displayed as the current folder. If a picture is taken with this folder selected, a new folder with the same name will be created.

New

Create a new folder and name it. Press  to save changes and return to the setup menu.



The input comment will begin at the current cursor position in the name area. Folder names can be up to five characters long. Any additional characters will be deleted. To delete the character at the current cursor position, press . Press **MENU** to exit without creating a new folder or changing the folder name.

Rename

Select a folder from the list and rename it in the rename screen. Rename folders in the same manner with which new folders are named. The default folder cannot be renamed.

Delete

Delete all empty folders on the memory card.

Folder Names

Each folder can contain up to 999 photographs. During shooting, photographs are recorded in the highest-numbered folder for the selected name. For example, if the folder **NCD60** is selected for **Select folder** and there are two folders named "101NCD60" and "102NCD60", photographs are recorded in "102NCD60". If a photograph is taken when the current folder is full or contains a photograph numbered 9999, the camera will create a new folder by adding one to the current folder number (e.g., "101NCD60").

Download from www.Somanuals.com. All Manuals Search And Download.

File No. Sequence (Displayed When **Full** Is Selected;  118)

Choose how the camera names files.

Off (default setting)

File numbering is reset to 0001 when a new folder is created, the memory card is formatted, or a new memory card is inserted.

On

File numbering continues by adding one to the last number used after a new folder is created, the memory card is formatted, or a new memory card is inserted. The last file number is stored even when file numbering is switched from **On** to **Off**, and file numbering continues by adding one to the last number stored the next time file numbering is set to **On**. If a photograph is taken when the current folder contains a photograph numbered 9999, a new folder will be created and file numbering will begin again from 0001 regardless of the option selected.

Reset

As for **On**, except that file numbering is reset to 0001 with the next photograph taken (if the current folder already contains photographs, a new folder will be created).

 **File Numbering**

If the current folder is numbered 999 and contains 999 photographs or a photograph numbered 9999, the shutter release will be disabled and the message **Card is full** will be displayed in the monitor and **F**  will blink in the viewfinder. Select **Reset for File no. sequence** and format the memory card or insert another memory card in the camera.

Clean Image Sensor (Displayed When **Full** Is Selected;  118)

The camera automatically removes dust from the low-pass filter protecting the image sensor. See “Caring for the Optical Low-Pass Filter” ( 160) for details.

Mirror Lock-Up (Displayed When **Full** Is Selected;  118)

Lock the mirror in the up position when inspecting or cleaning the low-pass filter that protects the camera image sensor. See “Cleaning the Low-Pass Filter Manually” ( 162) for details.

Firmware Version (Displayed When **Full** Is Selected;  118)

View the current camera firmware version.

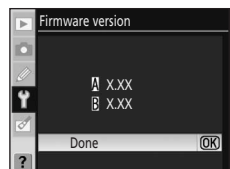

Dust off Ref Photo (Displayed When **Full** Is Selected; 118)

Acquire reference data for the Image Dust Off option in Capture NX (available separately;  156). Image Dust Off is used to reduce the effects of dust in NEF (RAW) photographs. For more information, see the documentation provided with Capture NX.

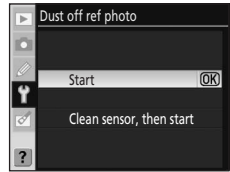

Acquiring Image Dust Off Reference Data

1 Highlight **Start** or **Clean sensor, then start** and press **OK**.

When acquiring image dust off reference data after photographs have been taken, select **Start**. The message shown at right will be displayed.

When taking photographs after acquiring image dust off reference data, select **Clean sensor, then start**. The message shown at right will be displayed after the image sensor is cleaned ( 160).

"**rEF**" will appear in the viewfinder.

Press **MENU** to exit without acquiring image dust off reference data.

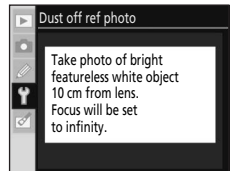

2 With the lens ten centimeters (four inches) from a well-lit, featureless white object, frame the object so that it fills the viewfinder and then press the shutter-release button halfway.

In autofocus mode, focus will automatically be set to infinity; in manual focus mode, set focus to infinity manually.

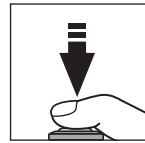

3 Press the shutter-release button the rest of the way down to acquire image dust off reference data.

The monitor turns off when the shutter-release button is pressed.

If the reference object is too bright or too dark, the camera may be unable to acquire image dust off reference data and the message shown at right will be displayed. Choose another reference object and repeat the process from step 1.

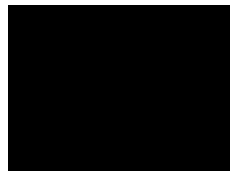

Notes on Image Sensor Cleaning



If photographs that will be processed with Image Dust Off have already been recorded, *DO NOT* clean the image sensor before acquiring image dust off reference data. If the image sensor is cleaned after photographs are taken, but before image dust reference data are acquired, Image Dust Off will be unable to locate dust and remove its effects. This camera automatically cleans the image sensor when the camera is turned on and off (default setting). Selecting **Cleaning off for Clean image sensor**>**Clean at** ( 161) in the setup menu is recommended when acquiring image dust off reference data.

Image Dust Off



Dust off ref photo is available with CPU lenses only. A lens with a focal length of at least 50mm is recommended ( 146). If using a zoom lens, zoom all the way in.

The same reference image can be used for photographs taken with different lenses or at different apertures. Reference images cannot be viewed using computer imaging software. A grid pattern is displayed when reference images are viewed on the camera; histograms and highlights are not displayed.

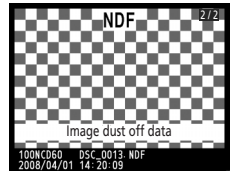

Auto Image Rotation (Displayed When **Full** Is Selected; 118)

Choose whether to record camera orientation with new photographs.

Photographs taken while **On** (default setting) is selected contain information on camera orientation, allowing them to be rotated automatically during playback ( 72) or when viewed in ViewNX or Capture NX (available separately;  156).

The following orientations are recorded:

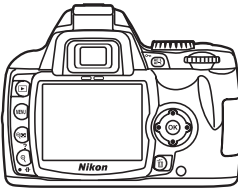

Landscape (wide) orientation

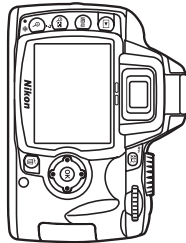

Camera rotated 90° clockwise

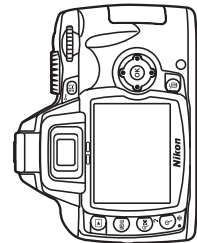

Camera rotated 90° counter-clockwise

In continuous mode ( 54), orientation recorded for first shot applies to all images in same burst, even if camera orientation is changed during shooting.

When photographs are taken with the lens pointing up or down, camera orientation information may not be accurately recorded.

Camera orientation is not recorded when **Off** is selected. With playback, photographs are always displayed in “wide” (landscape) orientation.

Creating Retouched Copies: The Retouch Menu

The options available in the retouch menu can be used to create cropped, resized, or retouched copies of photographs, or to create JPEG-format copies of NEF (RAW) photographs stored on the memory card.

Copies created using options in the retouch menu are recorded as separate files. The retouch menu contains the following options.

See “Using Camera Menus” (📖 94) for more information on using the menus.

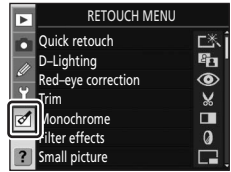

Quick retouch

📖 132

Create retouched copies in which contrast and saturation have been enhanced.

D-Lighting

📖 132

Brighten dark or backlit subjects or produce effects similar to the flash after photographs are taken.

Red-eye correction

📖 133

Correct “red-eye” caused by the flash.

Trim

📖 134

Create cropped copies of existing photographs.

Monochrome

📖 134

Copy photographs in black-and-white, sepia, or cyanotype.

Filter effects

📖 135

Create copies with color filter effects.

Small picture

📖 136

Create small copies of existing photographs.

Image overlay

📖 138

Combine two RAW photographs into a single image.

NEF (RAW) processing

📖 140

Create JPEG-format copies of NEF (RAW) photographs recorded at an image quality setting of **RAW** or **RAW+B** (📖 51).

Stop-motion movie

📖 141

Create a stop-motion movie from photographs on the memory card.



Before and after

📖 143

Compare a retouched copy to the source image by displaying them side-by-side. This option is displayed only when **OK** is pressed while a retouched copy, or the source image for a retouched copy, is displayed in full-frame playback.

Only selected options for **My menu** (📖 119) will be displayed if **My menu** is selected for the **CSM/Setup menu** option (📖 118) in the setup menu.

Retouching Copies

- The options in the retouch menu can each be applied once to existing copies, although this may result in loss of quality. Note the following:
 - The same option cannot be applied to the same copy more than once.
 - Copies created with **Quick retouch** cannot be further modified using **D-Lighting**.
 - Copies created with **D-Lighting** cannot be further modified using **Quick retouch**.
 - Copies created with **Trim** or **Small picture** cannot be further modified.
 - **Quick retouch**, **D-Lighting**, **Red-eye correction**, and **Filter effects** other than **Cross screen** cannot be applied to monochrome copies.
 - Copies created with any **Filter effects** option other than **Cross screen** cannot be further modified with **Filter effects** other than **Cross screen**.
 - Copies created with **NEF (RAW) processing > Optimize image > Black-and-white** cannot be further modified using **Quick retouch**, **D-Lighting**, **Red-eye correction**, **Monochrome**, or **Filter effects** other than **Cross screen**.
- **Quick retouch**, **D-Lighting**, **Red-eye correction**, **Monochrome**, and **Filter effects** other than **Cross screen** cannot be applied to photographs taken with **Black-and-white** selected for **Optimize image** ( 101).
- The D60 may be unable to display or retouch photographs that were created with other models of camera or that have been modified using a computer or other device.
- If no operations are performed for 12 seconds (default setting) while creating a retouched copy, the monitor will turn off and a retouched copy will not be saved. To increase the amount of time allowed to pass, select **Long** for Custom Setting 15 (**Auto off timers**;  114), or select **Custom** and specify a longer time for **Playback/menus**.

Creating Retouched Copies

1 Display the retouch menu and highlight menu item ( 94).

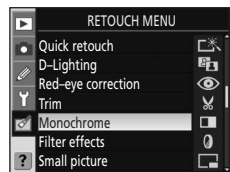

2 Display selection screen.

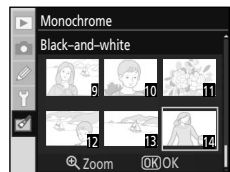

3 Highlight photograph.

Press and hold  to enlarge display of the selected photograph.

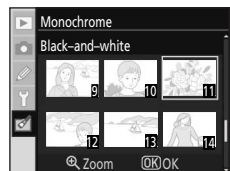

4 Display retouch options.

The screen specific to each retouch option will be displayed. See the section for each retouch option for further details.

To exit to full-frame playback mode without creating modified copy, press .



Creating Retouched Copies in Full-frame Playback

Except in the case of **Image overlay**, retouched copies can also be created by pressing **OK** after selecting photographs in full-frame playback.

1 Select photograph in full-frame playback (72).



2 Display retouch menu items.



3 Highlight menu item.

Image overlay is not available during full-frame playback.

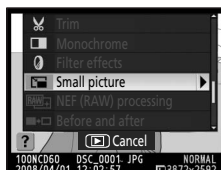

4 Display retouch options.

The screen specific to each retouch option will be displayed. See the section for each retouch option for further details. To exit to full-frame playback without creating modified copy, press .

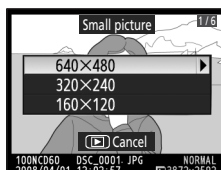

Quick Retouch

Easily create retouched copies in which contrast and saturation have been enhanced.

The camera automatically creates copies in which dark or backlit subjects are brightened using the D-Lighting option and the contrast and saturation (vividness) are enhanced. Press the multi-selector up or down to choose the amount of enhancement performed from **High**, **Normal**, or **Low**. The effects of enhancement can be previewed in the edit display.

Press **OK** to create a retouched copy and exit to full-frame playback.

Image Quality and Size

Retouched copies are recorded at the same image quality and size settings as those of the source images. However, if the source image was taken at an image quality setting of **RAW** or **RAW+B**, copies have an image quality of JPEG Fine and an image size of 3,872 × 2,592.

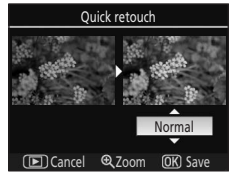

D-Lighting

D-lighting brightens shadows, making it ideal for dark or backlit photographs.



Before



After

Use the multi-selector to choose the amount of enhancement from **High**, **Normal**, or **Low** while viewing effects in the preview display. Press **OK** to copy the photograph and exit to full-frame playback.

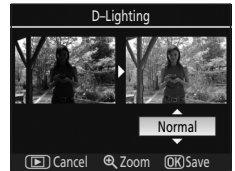

Image Quality and Size

Retouched copies are recorded at the same image quality and size settings as those of the source images. However, if the source image was taken at an image quality setting of **RAW** or **RAW+B**, copies have an image quality of JPEG Fine and an image size of 3,872 × 2,592.

Red-Eye Correction

The camera automatically detects “red eye” in photographs taken using the flash, and creates copies in which this phenomenon is reduced.

Selecting this option displays a preview image as shown below.

Red-eye correction is available only with photographs taken using the flash.

No copy will be created if the camera is unable to detect red eye.

Confirm the effects of red-eye correction and create a corrected copy as described in the following table. Note that red-eye correction may not always produce the expected results and may in very rare circumstances be applied to portions of the image that are not affected by red eye; check the preview thoroughly before proceeding.

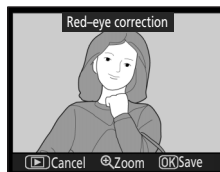

Option	Use	Description	
Zoom in		Press to zoom in.	<p>Navigation window is displayed for a few seconds while / or the multi selector is pressed; area currently visible in monitor is indicated by yellow border. Press , , or the multi selector to display navigation window again.</p>
Zoom out		Press to zoom out.	
View other areas of image		While photo is zoomed in, press the multi selector up, down, left, or right to view areas of image not visible in monitor. Keep the multi selector pressed to scroll rapidly to other areas of frame.	
Cancel zoom	OK	Press OK to cancel zoom.	
Create copy	OK	If the camera detects red eye in the selected photograph, a copy will be created that has been processed to reduce its effects and exit to full-frame playback.	

Image Quality and Size

Retouched copies are recorded at the same image quality and size settings as those of the source images. However, if the source image was taken at an image quality setting of **RAW** or **RAW+B**, copies have an image quality of JPEG Fine and an image size of 3,872 × 2,592.

Trim

Create cropped copies of selected photographs.

A preview of the portion of the photograph to be copied is displayed. The following operations can be performed.

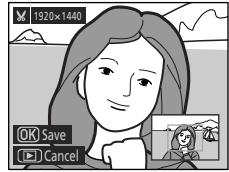

Option	Use	Description
Reduce the portion to be copied		Each time is pressed, the portion to be copied is reduced in the preview image.
Increase the portion to be copied		Each time is pressed, the portion to be copied is increased in the preview image.
View other areas of image		While photo is zoomed in, press the multi selector up, down, left, or right to view areas of image not visible in the monitor.
Create copy	OK	Save the area currently visible in the monitor as a separate file and exit to full-frame playback.

Image Quality and Size

Copies created from NEF (RAW) or NEF (RAW) + JPEG photographs have an image quality (50) of JPEG Fine; cropped copies created from JPEG photographs have the same image quality as the source images. Depending on the size of the crop, the copy may be 2,560 × 1,920, 1,920 × 1,440, 1,280 × 960, 960 × 720, or 640 × 480 pixels in size (50).

Monochrome

Choose from **Black-and-white**, **Sepia**, and **Cyanotype** (blue and white monochrome).

- Black-and-white**
Create black-and-white copies of selected photographs.
- Sepia**
Create sepia copies of selected photographs.
- Cyanotype**
Create blue-tinted monochrome copies of selected photographs.

Selecting **Sepia** or **Cyanotype** displays a preview of the selected image; press the multi selector up to increase color saturation, down to decrease. Press **OK** to create a monochrome copy and return to full-frame playback.

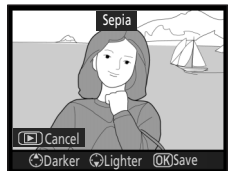

Image Quality and Size

Retouched copies are recorded at the same image quality and size settings as those of the source images. However, if the source image was taken at an image quality setting of **RAW** or **RAW+B**, copies have an image quality of JPEG Fine and an image size of 3,872 × 2,592.

Download from www.Somanuals.com. All Manuals Search And Download.

Filter Effects

Choose from the following options.



Skylight

Creates the effect of a sky light filter, making the photograph less blue.

Warm filter

Creates a copy with warm tone filter effects, giving the copy “warm” red cast.

Red intensifier

Intensifies reds.

Green intensifier

Intensifies greens.

Blue intensifier

Intensifies blues.

Cross screen

Just as with a cross screen filter, this produces a star pattern with lines radiating outward from bright objects. The following options can be adjusted.

Number of points: Choose number of cross points from three options.

Filter amount: Choose amount of filtering from three options.

Filter angle: Choose cross angle from three options.

Length of points: Choose length of cross points from three options.

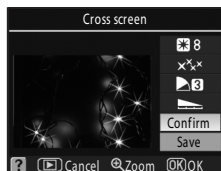

When you complete the setting, highlight **Confirm** and press **OK** to confirm the effect of the settings in the preview image. Highlight **Save** and press **OK** to create a copy and exit to full-frame playback.

Color balance

The monitor displays as shown at right. Press the multi selector up, down, left, or right to modify color balance as described below.

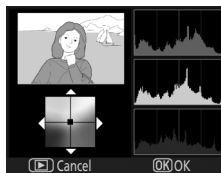
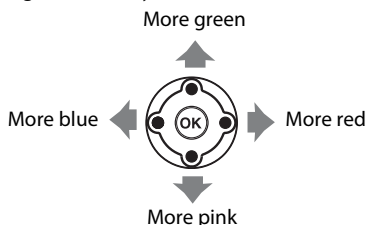

The effect is displayed in the monitor together with red, green, and blue histograms giving the distribution of tones in the copy (75).



After adjusting filter effects, press **OK** to copy the photograph and return to full-frame playback.

Image Quality and Size

Retouched copies are recorded at the same image quality and size settings as those of the source images. However, if the source image was taken at an image quality setting of **RAW** or **RAW+B**, copies have an image quality of JPEG Fine and an image size of 3,872 × 2,592.

Small Picture

Create a small copy of the selected photograph. Copies have an image quality of JPEG Fine. The following sizes are available.

-  **640×480**
Suited to television playback.
-  **320×240**
Suited to display on website.
-  **160×120**
Suitable for e-mail.

The small picture option can be used during full-frame playback as described in “Creating Retouched Copies in Full-frame Playback” (📖 131). The procedure for selecting photographs after choosing **Small picture** from the retouch menu, however, differs. Instead of selecting a single photograph and then choosing a photograph size, the user selects a photograph size first and then selects one or more photographs to copy at the selected size.

Selecting **Small picture** from the retouch menu displays the menu shown in step 1. Follow the steps below to create small copies of multiple photographs.

1 Highlight Choose size.

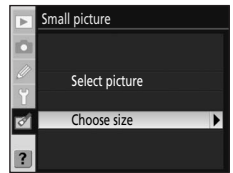

2 Display options.

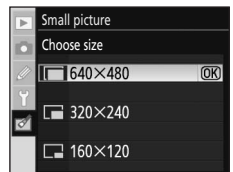

3 Highlight desired photograph size.

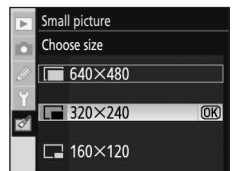

4 Make selection and the menu shown at right will be displayed.

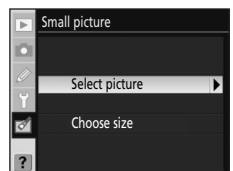

5 Highlight **Select picture**.

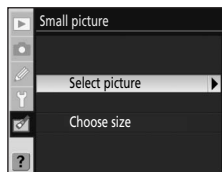

6 Display selection screen.

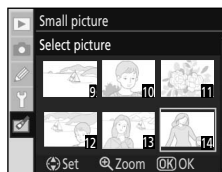

7 Press the multi selector left or right to select photograph, and up or down to mark the selected photograph with .

Press the multi selector up or down to deselect the photograph.

To view the highlighted photograph full frame, press and hold .

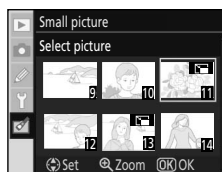

8 Confirmation dialog displayed.

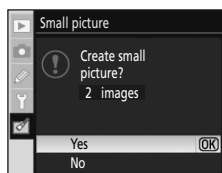

9 Highlight **Yes** and press **OK**.

Copy photos and exit to full-frame playback.

To select different photographs, highlight **No** and press **OK**. Monitor display returns to that shown in step 7. Press **MENU** to exit to retouch menu without creating copies.



Date Imprint

If the small picture option is applied to photographs on which the date has been imprinted using Custom Setting 18 (**Date imprint**;  115), the date may be difficult to read.

Viewing Small Pictures

- Small pictures are indicated by a gray border during full-frame playback, thumbnail playback, and when a photograph selection dialog is displayed.
- Playback zoom is not available when small pictures are displayed.

Image Overlay

Image overlay combines two existing RAW photographs to create a single photograph that is saved separately from the source images. Adjust image quality (🔍 50) and image size (🔍 50), to suit intent, from the Quick settings display (🔍 48), or from the shooting menu (🔍 100), before selecting **Image overlay** in the retouch menu. Image created using this option can be saved at the image quality and size settings applied from the Quick settings display, or the shooting menu, when creating overlay copies.

When an overlay image is saved at an image quality setting of **RAW**, it can be combined with another NEF (RAW) photograph to create a new overlay image.

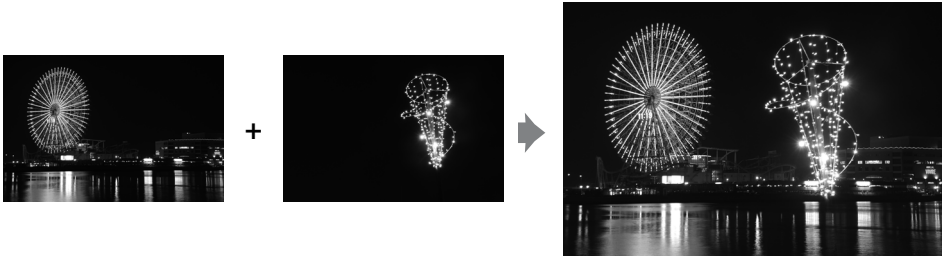

1 Highlight **Image overlay** in the retouch menu and press the multi selector right.

The preview dialog shown at right will be displayed with **Image 1** highlighted.



2 Press **OK**.

A photograph selection dialog will be displayed.

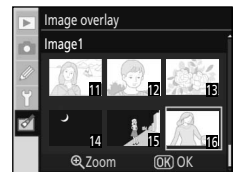

3 Press the multi selector left or right to highlight the first photograph in the overlay.

Press and hold 🔍 to enlarge display of the selected photograph.

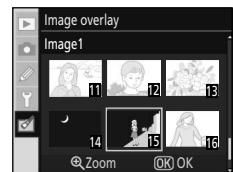

4 Press **OK** to select the highlighted image and return to the preview display.

The selected image will appear as **Image 1**.

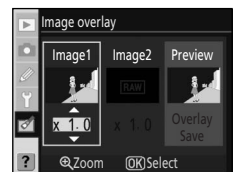

5 Optimize exposure for the overlay by pressing the multi selector up or down to select the gain for image 1 from between 0.1 and 2.0.

The default value is 1.0; selecting 0.5 cuts gain in half, while selecting 2.0 doubles gain. The effects of gain are visible in the **Preview** column.

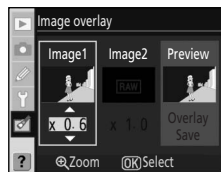

6 Press the multi selector left or right to highlight Image 2.

Press **OK** to display a photograph selection dialog again.

Repeat steps 3–5 to select the second photograph and adjust gain.

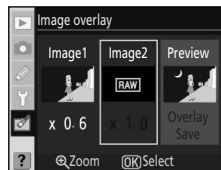

7 Press the multi selector left or right to highlight the Preview column.

When **Overlay** is selected and **OK** is pressed, a preview of the overlay image will be displayed. Proceed to step 8.

When **Save** is selected and **OK** is pressed, the overlay image will be saved without a preview having been displayed.

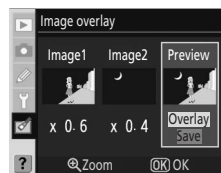

8 Check the preview image and press OK.

The overlay image will be saved and the monitor display will exit to full-frame playback.



Image Overlay

- Only RAW photographs created with the D60 can be selected for image overlay. Other images are not displayed on the selection screen.
- The overlay has the same photo info (including date of recording, metering, shutter speed, aperture, exposure mode, exposure compensation, focal length, and image orientation) and values for white balance and optimize image as the photograph selected for **Image 1**.

NEF (RAW) Processing

Create JPEG-format copies of NEF (RAW) photographs stored at image quality setting of **RAW** or **RAW+B** (51).

- 1 Highlight **NEF (RAW) processing** in the retouch menu and press the multi selector right.

A photograph selection dialog will be displayed.

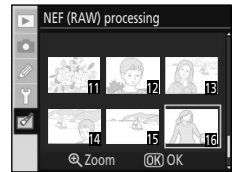

- 2 Press the multi selector left or right to highlight the NEF (RAW) photograph.

Press **OK** to select the highlighted photograph.

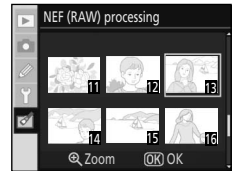

- 3 Adjust the **Image quality**, **Image size**, **White balance**, **Exposure comp.**, and **Optimize image** options as desired.

Image quality: Choose image quality from **JPEG fine**, **JPEG normal**, or **JPEG basic** (50).

Image size: Choose image size from **L** (large), **M** (medium), or **S** (small) (50).

White balance: Choose white balance setting.
 - White balance settings: 52
 - Specifying types of fluorescent lighting: 103
 - Fine tuning white balance: 104, step 2

Preset white balance values for NEF (RAW) photographs taken at a white balance setting of **Preset manual** can be fine tuned from the **Preset manual** option.

Exposure comp.: Adjust brightness from -3 to +3 EV.

Optimize image: Choose an optimize image option (51).

Highlight **EXE** when all settings have been adjusted.

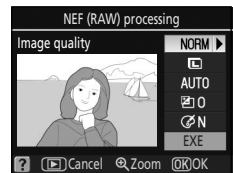

- 4 Press **OK**.

JPEG-format copy will be saved and display will exit to full-frame playback.

Press **MENU** or **▶** to exit without creating a copy.

NEF (RAW) Photographs

- The D60 can only create JPEG-format copies of NEF (RAW) photographs taken with the D60.
- **NEF (RAW) processing > White balance > Preset manual** cannot be selected for photographs taken at a white balance setting other than **Preset manual**.
- **White balance** cannot be selected for photograph created using the **Image overlay** option.
- **Exposure comp.** cannot be selected for photograph taken when **On** is selected for **Active D-Lighting**.
- **White balance** and **Optimize image** cannot be selected for photograph taken in **AUTO**, **SR**, **SR+L**, **SR+H**, and **SR+M** modes.

Stop-motion Movie

Create a stop-motion movie from photographs taken with the D60 and record as a movie file.

Create movie

Choose the photographs for stop-motion movie and create a movie file.

Frame size

Choose the frame size from **640 × 480**, **320 × 240**, or **160 × 120**.

Frame rate

Choose the frame rate from **15 fps**, **10 fps**, **6 fps**, or **3 fps**.

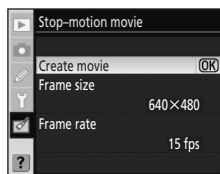

Creating a Stop-motion Movie

- 1 Highlight **Create movie** in the Stop-motion movie screen and press **OK**.

The screen shown at right will be displayed.

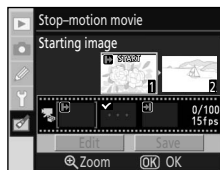

- 2 Press the multi selector left or right to highlight the starting image.

Hold down the multi selector to scroll rapidly through thumbnails. Press **OK** to select the highlighted photograph.

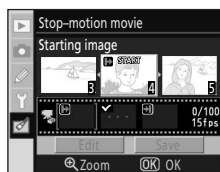

- 3 Press the multi selector left or right to highlight the ending image.

Hold down the multi selector to scroll rapidly through thumbnails. The starting image, ending image, and all images in between will be marked ✓. Up to 100 images can be used in a stop-motion movie.

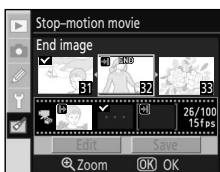

- 4 Press **OK**.

To create a stop-motion movie without editing or previewing the file, proceed to step 6.

To remove unwanted images, or edit the starting or ending images, select **Edit** and press **OK** to proceed to step 5.

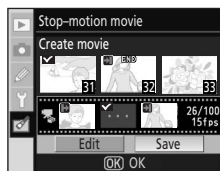

5 Highlight **Starting image**, **Middle image**, or **End image** and press **OK**.

When **Starting image** is selected, repeat step 2 to select the starting image. After the starting image is changed, the monitor will return to display shown in step 4.

When **End image** is selected, repeat step 3 to select the ending image. After the ending image is changed, the monitor will return to display shown in step 4.

When **Middle image** is selected, unwanted images can be removed from the stop-motion movie. Highlight unwanted images and press the multi selector up or down. The ✓ icon is removed. After unwanted images have been removed, press **OK**. The monitor will return to the display shown in step 4.

When creating a stop-motion movie without editing, highlight **Cancel** and press **OK**.



6 Highlight **Save** and press **OK**.

Select **Save** in the display shown at right and press **OK** to create and save the movie file. Once the movie file is saved, the starting image will be displayed in full-frame playback.

Select **Preview** to play back the stop-motion movie with settings applied before the file was saved. While previewing the movie, the same operations available with stop-motion playback, including pausing, rewinding, and advancing, can be applied (ⓧ 99).

Highlight **Frame rate** to change the rate at which the stop-motion movie is played back.

Highlight **Edit** to return to step 5.

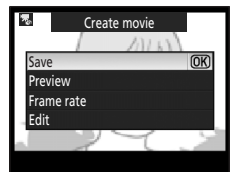

✓ **Stop-Motion Movies**

Photographs taken with cameras other than the D60, and copies created using the **Trim** and **Small picture** options, cannot be selected.

✍ **Playing Back Stop-Motion Movies**

- is displayed in full-frame or thumbnail playback mode. Stop-motion movie files can be played back by pressing **OK** in full-frame playback, or using the **Stop-motion movie** option in the playback menu (ⓧ 99).
- For more information on stop-motion movie file names, see "File Names" (ⓧ 51).

Before and after (Making a Side-by-Side Comparison)

Compare a retouched copy to the source image by displaying them side-by-side. This option is displayed only when **OK** is pressed while a retouched copy, or the source image for a retouched copy, is displayed in full-frame playback (131).

1 Select a source image or a retouched copy in full-frame playback mode and press **OK**.

Retouch menu items will be displayed.



2 Press the multi selector up or down to highlight **Before and after**.

This option is only available with retouched copies and source images for retouched copies.

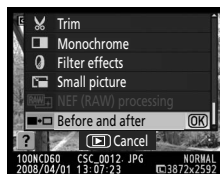

3 Press **OK**.

The source image is displayed on the left, the retouched copy on the right, with the options used to create the copy listed at the top of the display.

Press the multi selector in the direction indicated by the arrow adjacent to the image highlighted with a yellow border (▲, ▼, ◀, or ▶) to switch between the source image and the retouched copy.

- Press the multi selector left or right to switch between the source image and the retouched copy.
- If multiple retouched copies have been created from the same source image, select the retouched copy and press the multi selector up or down to display other retouched copies.
- If the copy was created from two images using **Image overlay**, press the multi selector up or down to view the other source image.

To view the highlighted photograph full frame, press and hold **Q**.

To exit to full-frame playback mode with the highlighted image displayed, press **OK**.

Options used to created copy

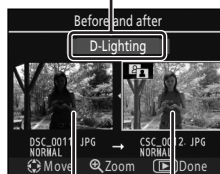

Source image Retouched copy

Optional Accessories

This chapter introduces the optional accessories available for the D60, as well as covering handling instructions.

- See our websites or product catalogs for up-to-date information on accessories for the D60.

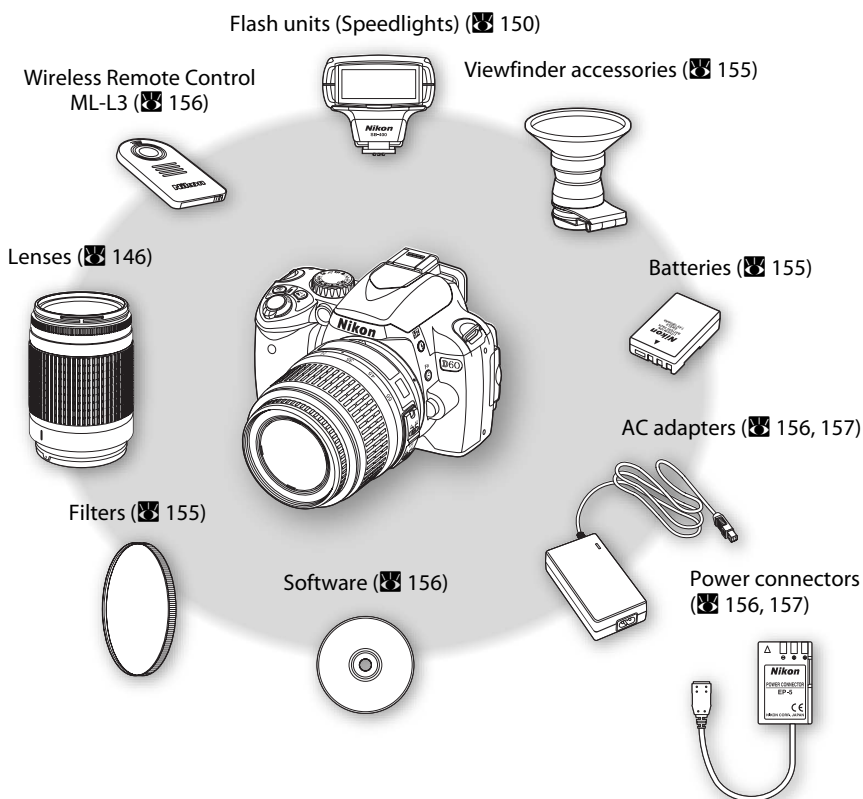



✔ Use Only Nikon Brand Electronic Accessories

Only Nikon brand accessories certified by Nikon specifically for use with your Nikon digital camera are engineered and proven to operate within its operational and safety requirements. THE USE OF NON-NIKON ACCESSORIES COULD DAMAGE YOUR CAMERA AND MAY VOID YOUR NIKON WARRANTY.

Compatible Lenses

Camera setting Lens/accessory		Focus mode			Shooting mode		Metering system		
		AF	M (with electronic rangefinder)	M	Digital Vari-Programs, P, S, A	M			 
							3D	Color	
CPU lenses ¹	AF-S, AF-I NIKKOR ²	✓	✓	✓	✓	✓	✓	—	✓ ³
	Type G or D AF NIKKOR ²	—	✓	✓	✓	✓	✓	—	✓ ³
	PC Micro 85mm f/2.8D ⁴	—	✓ ⁵	✓	—	✓	✓	—	✓ ³
	AF-S/AF-I Teleconverter ⁶	✓ ⁷	✓ ⁷	✓	✓	✓	✓	—	✓ ³
	Other AF NIKKOR (except lenses for F3AF)	—	✓ ⁸	✓	✓	✓	—	✓	✓ ³
	AI-P NIKKOR	—	✓ ⁹	✓	✓	✓	—	✓	✓ ³
Non-CPU lenses ¹⁰	AI- or AI-modified NIKKOR and Nikon Series-E ¹¹	—	✓ ⁹	✓	—	✓ ¹²	—	—	—
	Medical-NIKKOR 120mm f/4 (IF)	—	✓	✓	—	✓ ¹³	—	—	—
	Reflex-NIKKOR	—	—	✓	—	✓ ¹²	—	—	—
	PC-NIKKOR	—	✓ ⁵	✓	—	✓ ¹²	—	—	—
	AI-type Teleconverter ¹⁴	—	✓ ⁷	✓	—	✓ ¹²	—	—	—
	Bellows Focusing Attachment PB-6 ¹⁵	—	✓ ⁷	✓	—	✓ ¹²	—	—	—
	Auto extension rings (PK-series 11A, 12, or 13; PN-11)	—	✓ ⁷	✓	—	✓ ¹²	—	—	—

- 1 IX-NIKKOR lenses can not be used.
- 2 Vibration Reduction (VR) supported with VR lenses.
- 3 Spot metering meters selected focus point ( 62).
- 4 The camera's exposure metering and flash control systems do not work properly when shifting and/or tilting the lens, or when an aperture other than the maximum aperture is used.
- 5 Electronic rangefinder can not be used with shifting or tilting.
- 6 Can be used with AF-S and AF-I lenses only ( 148).
- 7 With maximum effective aperture of f/5.6 or faster.
- 8 When focusing at minimum focus distance with AF 80-200mm f/2.8, AF 35-70mm f/2.8, AF 28-85mm f/3.5-4.5, or AF 28-85mm f/3.5-4.5 <NEW> lens at maximum zoom, in-focus indicator may be displayed when image on matte screen in viewfinder is not in focus. Adjust focus manually until image in viewfinder is in focus.
- 9 With maximum aperture of f/5.6 or faster.
- 10 Some lenses can not be used ( 147).

- 11 Range of rotation for AI 80-200mm f/2.8 ED tripod mount is limited by camera body. Filters can not be exchanged while AI 200-400mm f/4 ED is mounted on camera.
- 12 Electronic analog exposure display is not available.
- 13 Can be used in manual exposure modes at shutter speeds slower than $\frac{1}{125}$ s. Electronic analog exposure display is not available.
- 14 Exposure compensation required when used with AI 28-85mm f/3.5-4.5, AI 35-105mm f/3.5-4.5, AI 35-135mm f/3.5-4.5, or AF-S 80-200mm f/2.8D. See teleconverter manual for details.
- 15 Hold the camera in "tall" (portrait) orientation when attaching the Bellows Focusing Attachment PB-6. Once the PB-6 is attached, the camera can be repositioned in "wide" (landscape) orientation if necessary.
 - Reprocopy Outfit PF-4 requires Camera Holder PA-4.

❑ Incompatible Accessories and Non-CPU Lenses

The following accessories and non-CPU lenses can NOT be used with the D60:

- AF Teleconverter TC-16A
- Non-AI lenses
- Lenses that require the Focusing Unit AU-1 (400mm f/4.5, 600mm f/5.6, 800mm f/8, 1200mm f/11)
- Fisheye (6mm f/5.6, 7.5mm f/5.6, 8mm f/8, OP 10mm f/5.6)
- 2.1cm f/4
- Extension Ring K2
- 180-600mm f/8 ED (serial numbers 174041-174180)
- 360-1200mm f/11 ED (serial numbers 174031-174127)
- 200-600mm f/9.5 (serial numbers 280001-300490)
- Lenses for the F3AF (AF 80mm f/2.8, AF 200mm f/3.5 ED, AF Teleconverter TC-16)
- PC 28mm f/4 (serial number 180900 or earlier)
- PC 35mm f/2.8 (serial numbers 851001-906200)
- PC 35mm f/3.5 (old type)
- Reflex 1000mm f/6.3 (old type)
- Reflex 1000mm f/11 (serial numbers 142361-143000)
- Reflex 2000mm f/11 (serial numbers 200111-200310)

✍ Lenses for Autofocus

Autofocus with this camera is supported only by AF-S and AF-I lenses. AF-S and AF-I lenses are equipped with an autofocus motor. Autofocus is not possible when any other type of lens is mounted, regardless of the autofocus capabilities of the lens itself.

✍ Lens f-number

The f-number included at the end of lens names (e.g., f/2.8 or f/3.5-5.6) is the maximum aperture of the lens.

✍ Recognizing CPU and Type G and D Lenses

CPU lenses can be identified by the presence of CPU contacts, type G and D lenses by a letter on the lens barrel. Type G lenses are not equipped with a lens aperture ring.

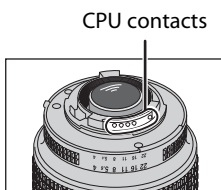

CPU lens

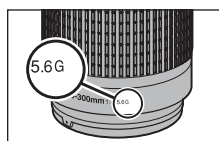

Type G lens

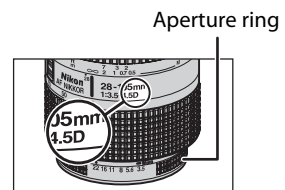

Type D lens

The AF-S/AF-I Teleconverter

The AF-S/AF-I teleconverter can be used with the following AF-S and AF-I lenses:

- AF-S VR 70-200mm f/2.8G ED
- AF-S 80-200mm f/2.8D ED
- AF-S VR Micro 105mm f/2.8G ED¹
- AF-S VR 200mm f/2G ED
- AF-S VR 200-400mm f/4G ED²
- AF-S VR 300mm f/2.8G ED
- AF-S 300mm f/2.8D ED II
- AF-S 300mm f/2.8D ED
- AF-I 300mm f/2.8D ED
- AF-S 300mm f/4D ED²
- AF-S NIKKOR 400mm f/2.8G ED VR
- AF-S 400mm f/2.8D ED II
- AF-S 400mm f/2.8D ED
- AF-I 400mm f/2.8D ED
- AF-S NIKKOR 500mm f/4G ED VR²
- AF-S 500mm f/4D ED II²
- AF-S 500mm f/4D ED²
- AF-I 500mm f/4D ED²
- AF-S NIKKOR 600mm f/4G ED VR²
- AF-S 600mm f/4D ED II²
- AF-S 600mm f/4D ED²
- AF-I 600mm f/4D ED²

1 Autofocus not supported.

2 Autofocus not supported when used with Teleconverter TC-17E II/TC-20 E II.

CPU Lens Aperture Ring

Lock the aperture ring on CPU lenses (except type G lenses) at the minimum aperture (highest f-number).

Non-CPU Lenses

Non-CPU lenses can be used only in **M** mode. Aperture can be confirmed and adjusted manually via the lens aperture ring. Exposure meters do not function. Flash photography in i-TTL mode is not supported.

Notes on AF-Assist Illuminator

The AF-assist illuminator has a range of about 0.5-3.0 m (1 ft. 8 in.-9 ft. 10 in.). When using the AF-assist illuminator, use a lens with a focal length of 24-200mm.

AF-assist illuminator is not available with the following lenses:

- AF-S VR 70-200mm f/2.8G ED
- AF-S 80-200mm f/2.8D ED
- AF-S VR 200mm f/2G ED
- AF-S VR 300mm f/2.8G ED
- AF-S VR 200-400mm f/4G ED
- AF-S NIKKOR 14-24mm f/2.8G ED

At ranges under 1 m (3ft. 3in.), the following lenses may block the AF-assist illuminator and interfere with autofocus when lighting is poor:

- AF-S VR 24-120mm f/3.5-5.6G ED
- AF-S 17-35mm f/2.8D ED
- AF-S DX VR 18-200mm f/3.5-5.6G ED
- AF-S DX 17-55mm f/2.8G ED
- AF-S 28-70mm f/2.8D ED
- AF-S VR Micro 105mm f/2.8G ED
- AF-S NIKKOR 24-70mm f/2.8G ED

Red-Eye Reduction

Lenses that block the subject's view of the AF-assist illuminator can interfere with red-eye reduction ( 65).

✓ The Built-in Flash

The built-in flash can be used with CPU lenses with focal lengths of 18mm to 300mm (ⓧ 66). The flash may be unable to light the entire subject and restrictions on focal length and shooting distance may apply with the following lenses.

Lens	Focal length	Min. range
AF-S DX 12-24mm f/4G ED	20mm	3.0 m/9 ft. 10 in.
	24mm	1.0 m/3 ft. 3 in.
AF-S DX NIKKOR 16-85mm f/3.5-5.6G ED VR	24mm or greater	No restrictions
AF-S 17-35mm f/2.8D ED	24mm	2.0 m/6 ft. 7 in.
	28mm	1.0 m/3 ft. 3 in.
	35mm	No restrictions
AF-S DX 17-55mm f/2.8G ED	28mm	1.5 m/4 ft. 11 in.
	35mm	1.0 m/3 ft. 3 in.
	45mm	No restrictions
AF 18-35mm f/3.5-4.5D ED	24mm	1.0 m/3 ft. 3 in.
	28mm or greater	No restrictions
AF-S DX 18-70mm f/3.5-4.5G ED	18mm	1.0 m/3 ft. 3 in.
	24mm or greater	No restrictions
AF-S DX 18-135mm f/3.5-5.6G ED	18mm	1.0 m/3 ft. 3 in.
	24mm or greater	No restrictions
AF-S DX VR 18-200mm f/3.5-5.6G ED	24mm	1.0 m/3 ft. 3 in.
	35mm or greater	No restrictions
AF 20-35mm f/2.8D	24mm	2.5 m/8 ft. 2 in.
	28mm	1.0 m/3 ft. 3 in.
	35mm	No restrictions
AF-S NIKKOR 24-70mm f/2.8G ED	35mm	1.5 m/4 ft. 11 in.
	50mm	1.0 m/3 ft. 3 in.
AF-S VR 24-120mm f/3.5-5.6G ED	24mm	1.0 m/3 ft. 3 in.
	28mm or greater	No restrictions
AF-S 28-70mm f/2.8D ED	35mm	1.5 m/4 ft. 11 in.
	50mm or greater	No restrictions
AF-S VR 200-400mm f/4G ED	250mm	2.5 m/8 ft. 2 in.
	300mm	2.0 m/6 ft. 7 in.

When AF-S NIKKOR 14-24mm f/2.8G ED is used, the flash is unable to light the entire subject at all focal lengths.

Optional Flash Units (Speedlights)

The accessory shoe allows SB-series Speedlights, including the SB-400, SB-800, SB-600, SB-80DX, SB-28DX, SB-28, SB-27, SB-23, SB-22S, and SB-29S to be mounted directly on the camera without a sync cable. It is equipped with a safety lock for Speedlights with a locking pin, such as the SB-800 and SB-600, which prevents the Speedlight from falling off accidentally. Before attaching an optional flash unit, remove the accessory shoe cover. The built-in flash will not fire when an optional Speedlight is attached.

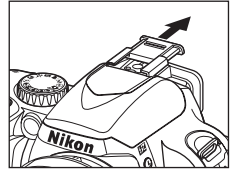

When used with compatible flash units such as the optional SB-400, SB-800, and SB-600 Speedlights, the D60 supports the advanced Nikon Creative Lighting System (CLS)*, which offers a number of features, including i-TTL flash control and Flash Color Information Communication. When the optional SB-800 Speedlight or SU-800 Wireless Speedlight Commander is mounted on the camera, the optional SB-600, a second SB-800 Speedlight, or the SB-R200 Wireless Remote Speedlight can be fired remotely. See the documentation provided with the Speedlight or wireless Speedlight commander for details.

* CLS is the latest flash control system for use with Nikon Speedlights and cameras. Various features are supported, including Flash Color Information Communication, with which flash output color temperature information is automatically transmitted to the camera for use in tuning white balance to achieve optimal results.

Nikon Speedlight SB-400

- The SB-400 is a high-performance flash unit with a guide number of 21/69 (ISO 100, m/ft, 20°C/68°F).
- The flash head can be rotated through 90° above the horizontal for bounce-flash photography.

Nikon Speedlight SB-800

- The SB-800 is a high-performance flash unit with a guide number of 38/125 (at the 35mm zoom-head position; ISO 100, m/ft, 20°C/68°F).
- The flash head can be tilted 90° up, 7° down, 180° to the left, and 90° to the right for bounce-flash or close-up photography.
- The SB-800 supports auto power zoom (24-105 mm), ensuring that the angle of coverage is adjusted in accordance with lens focal length, and has a built-in wide-flash adapter that increases the angle of coverage to match that of a 14mm or 17mm lens.
- The monitor and all buttons are illuminated to simplify operation in dark surroundings.
- Custom settings can be used to enable, disable, or adjust a variety of functions.

Nikon Speedlight SB-600

- The SB-600 is a high-performance flash unit with a guide number of 30/98 (ISO 100, m/ft) (at the 35mm zoom-head position, 20°C/68°F).
- The flash head can be tilted 90° up, 180° to the left, and 90° to the right for bounce-flash or close-up photography.
- The SB-600 supports auto power zoom (24-85mm), ensuring that the angle of coverage is adjusted in accordance with lens focal length, and has a built-in wide-flash adapter that increases the angle of coverage to match that of a 14mm lens.
- The monitor and all buttons are illuminated to simplify operation in dark surroundings.
- Custom settings can be used to enable, disable, or adjust a variety of functions.

Nikon Wireless Remote Speedlight SB-R200

This high-performance wireless remote Speedlight has a guide number of 10/32 (ISO 100, m/ft, 20°C/68°F). Although it cannot be mounted directly on the accessory shoe, it can be controlled using an optional SB-800 Speedlight or SU-800 Wireless Speedlight Commander. The SB-R200 can be hand-held, placed on the AS-20 Speedlight Stand, or attached to the front of the camera lens using the SX-1 Attachment Ring for remote control and close-up i-TTL photography.

Nikon Wireless Speedlight Commander SU-800

The SU-800 can be used as a commander unit for wireless remote triggering of the SB-800, SB-600, or SB-R200 flash units. The SU-800 itself is not a flash.

Guide Number

The guide number indicates the amount of light generated by the flash. The larger the number, the greater the flash output.

To calculate the range of the flash at full power, divide the Guide Number by the aperture. For example, at ISO 100 the SB-400 has a Guide Number of 21 m or 69 ft.; its range at an aperture of f/5.6 is $21 \div 5.6$ or about 3.7 meters (or in feet, $69 \div 5.6 = 12$ ft. 4 in.). For each twofold increase in ISO sensitivity, multiply the Guide Number by the square root of two (approximately 1.4). For example, when the SB-400 is used with the D60 at a sensitivity setting of ISO 200, the range of the SB-400, at an aperture of f/5.6 is $21 \div 5.6 \times 1.4 = 5.3$ meters, or $69 \div 5.6 \times 1.4 = 17$ ft. 5 in. (at ISO 200, 20°C/68°F, the angle of coverage is sufficient to light the picture angle of an 18mm lens).

Download from www.Somanuals.com. All Manuals Search And Download.

Optional Flash Units (Speedlights)

The following features are available with CLS-compatible flash units.

Speedlight		Single flash unit			Advanced Wireless Lighting				
					Commander		Remote		
		Flash mode/feature		SB-400	SB-800	SB-600	SB-800	SU-800 ¹	SB-800
i-TTL ²	i-TTL Balanced fill-flash for digital SLR	✓ ^{3,4}	✓ ³	✓ ³	✓ ⁵	✓	✓	✓	✓
	Standard i-TTL fill-flash for digital SLR	✓	✓	✓	—	—	—	—	—
AA	Auto aperture ²	—	✓ ⁵	—	✓ ⁶	✓ ⁶	✓ ⁶	—	—
A	Non-TTL auto	—	✓ ⁵	—	✓ ⁶	—	✓ ⁶	—	—
GN	Distance-priority manual	—	✓	—	—	—	—	—	—
M	Manual	✓ ⁴	✓	✓	✓	✓	✓	✓	✓
RPT	Repeating flash	—	✓	—	✓	✓	✓	✓	—
AF-assist for multi-area AF ²		—	✓	✓	✓	✓	—	—	—
Flash Color Information Communication		✓	✓	✓	✓	—	—	—	—
REAR	Rear-curtain sync	✓	✓	✓	✓	✓	✓	✓	✓
	Red-eye reduction	✓	✓	✓	✓	—	—	—	—
Auto zoom		—	✓	✓	✓	—	—	—	—
Auto ISO (Custom Setting 10)		✓	✓	✓	—	—	—	—	—

1 Only available when SU-800 is used to control other flash units. The SU-800 itself is not equipped with a flash.

2 CPU lens required.

3 Not available with spot metering. Standard i-TTL fill-flash for digital SLR is applied.

4 Can be selected from camera Custom Settings menu ( 113).

5 Select flash mode from the Speedlight's custom settings. Non-TTL auto is selected automatically when a non-CPU lens is attached.

6 Auto aperture is automatically applied when a CPU lens is mounted, regardless of the option selected in the Speedlight's custom settings. Non-TTL auto is selected automatically if non-CPU lens is attached.

The following Speedlights can only be used in non-TTL auto and manual modes at shutter speeds of $1/200$ s or slower. Flash charge state is shown by the Speedlight flash-ready indicator. In TTL mode, the shutter-release button will lock and no photographs can be taken.

Speedlight		SB-80DX, SB-28DX	SB-50DX ¹	SB-28, SB-26, SB-25, SB-24	SB-30, SB-27 ² , SB-22S, SB-22, SB-20, SB-16B, SB-15	SB-23, SB-29 ³ , SB-21B ³ , SB-29S ³
Flash mode						
A	Non-TTL auto	✓	—	✓	✓	—
M	Manual	✓	✓	✓	✓	✓
	Repeating flash	✓	—	✓	—	—
REAR	Rear-curtain sync ⁴	✓	✓	✓	✓	✓

1 In **P**, **S**, **A**, and **M** modes, lower built-in flash and use optional Speedlight only. To prevent the built-in flash from popping up automatically when lighting is poor, do not select Digital Vari-Program modes.

2 When mounted on D60, flash mode is automatically set to TTL and shutter release is disabled. Set Speedlight to A (non-TTL auto) mode.

3 Autofocus is available only with AF-S VR Micro 105 mm f/2.8G ED lens.





4 Available when camera is used to select flash mode.

ISO Auto

When the SB-400, SB-800, or SB-600 is used, the camera automatically adjusts ISO sensitivity to achieve optimal flash output if **On** is selected for Custom Setting 10 (**ISO auto**) or **Auto** is selected for **ISO sensitivity** in Digital Vari-Program modes. However, foreground subjects may be underexposed ( 111).

AUTO, , , , and Modes

When an optional Speedlight is attached, the built-in flash turns off.

- Auto flash mode is canceled, and the optional Speedlight will fire whenever a photograph is taken. If the flash mode is set to off, fill flash is automatically applied.
- When using an optional Speedlight in  or  mode, flash mode is automatically set to fill flash. Red-eye reduction mode can also be selected.
- When flash output is compensated using SB-800 or SB-600 Speedlight, or SU-800 Wireless Speedlight Commander,  (flash compensation indicator for optional Speedlight) will be displayed at the top of Shooting information display.
- The optional Speedlight will not fire when the mode dial is rotated to .

Use Only Nikon Flash Accessories

Use only Nikon Speedlights. Negative voltages or voltages over 250 V applied to the accessory shoe could not only prevent normal operation, but damage the sync circuitry of the camera or flash. Before using a Nikon Speedlight not listed in this section, contact a Nikon-authorized service representative for more information.

The Sync Terminal Adapter AS-15

When the Sync Terminal Adapter AS-15 (available separately) is mounted on the camera accessory shoe, flash accessories can be connected via a sync cable.

 **Notes on Optional Speedlights**

Refer to the documentation provided with Speedlight for details. If the Speedlight supports the Creative Lighting System, refer to the section on CLS-compatible digital SLR cameras. The D60 is not included in the “digital SLR” category in the SB-80DX, SB-28DX, and SB-50DX manuals.

The shutter will synchronize with an external flash at speeds of 1/200s or slower.

i-TTL flash control can be used at ISO sensitivities between 100 and 1600. Higher values may not produce the desired results at some ranges or apertures. If the flash-ready indicator blinks in the viewfinder for about three seconds after a photograph is taken in i-TTL or Non-TTL auto mode, the flash has fired at full power and the photograph may be underexposed.

The SB-400, SB-800, and SB-600 provide red-eye reduction, while the SB-800, SB-600, and SU-800 provide AF-assist illumination (the SU-800 does not provide AF-assist illumination in close-up mode).

Auto power zoom is available only with SB-800 and SB-600 Speedlights.

In the following modes, the maximum aperture (minimum f-number) varies with ISO sensitivity

 53).

       **P modes:**

ISO sensitivity	100	200	400	800	1600
Maximum aperture (minimum f-number)	4	4.8	5.6	6.7	8

 **mode:**

ISO sensitivity	100	200	400	800	1600
Maximum aperture (minimum f-number)	5.6	6.7	8	9.5	11

For each one-step increase in sensitivity (e.g., from 200 to 400), aperture is stopped down by half an f/-stop. If the maximum aperture of the lens is smaller than given above, the maximum value for aperture will be the maximum aperture of the lens.

When TTL Remote Cord SC-17, 28, or 29 is used for off-camera flash photography in i-TTL mode, correct exposure may not be achieved with i-TTL Balanced Fill-Flash control. We recommend that you select standard i-TTL flash control. Take a test shot and view the results in the monitor.

In i-TTL mode, use the flash panel or bounce adapter provided with the Speedlight. Do not use other panels such as diffusion panels, as this may produce incorrect exposure.

Other Accessories

Viewfinder eyepiece accessories

Remove the viewfinder eyepiece cup before attaching viewfinder eyepiece accessories. See “Eyepiece Cap” (📷 56) for more information on removing the rubber eyecup.

- **Dioptr adjustment viewfinder lenses:** This feature is helpful for those who are far-sighted or short-sighted. Lenses can be exchanged easily by inserting to the eyepiece. Lenses are available with diopters of -5 , -4 , -3 , -2 , 0 , $+0.5$, $+1$, $+2$, and $+3\text{ m}^{-1}$ (when the D60 diopter adjustment control is at the -1 m^{-1} position). Use diopter adjustment lenses only if the desired focus cannot be achieved with the built-in diopter adjustment control (-1.7 to $+0.5\text{ m}^{-1}$). Test diopter adjustment lenses before purchase to ensure that the desired focus can be achieved. The rubber eyecup cannot be attached when diopter adjustment viewfinder lenses used.
- **Eyepiece Magnifier DG-2:** Magnify the scene displayed in the center of the viewfinder for close-up photography, copying, telephoto lenses, and other tasks that require added precision. Eyepiece adapter required (available separately). When the Eyepiece Magnifier DG-2 is attached, the eye sensor does not respond appropriately. If necessary, select **Off** for **Shooting info auto off** (📷 123) in the setup menu.
- **Eyepiece Adapter DK-22:** Attach the Eyepiece Magnifier DG-2 to the D60.
- **Right-angle Viewing Attachment DR-6:** The DR-6 attaches at a right angle to the viewfinder eyepiece, allowing the image in the viewfinder to be viewed from above when the camera is in portrait orientation. When the Right-angle Viewing Attachment DR-6 is attached, the eye sensor does not respond appropriately. If necessary, select **Off** for **Shooting info auto off** (📷 123) in the setup menu.

Filters

- Nikon filters can be divided into three types: screw-in, slip-in, and rear-interchange. Use Nikon filters; other filters may interfere with autofocus or electronic range finding.
- The D60 cannot be used with linear polarizing filters. Use the C-PL circular polarizing filter instead.
- The NC and L37C filters are recommended for protecting the lens.
- Moiré may occur if a filter is used when the subject is framed against a bright light or when a bright light source is in the frame. Taking pictures without a filter is recommended.
- Center-weighted metering (📷 62) is recommended with filters with exposure factors (filter factors) over $1 \times$ (Y48, O56, R60, X0, X1, C-PL, ND4S, ND8S, A2, A12, B2, B8, B12). When matrix metering is selected, enough effect may not be expected. See the documentation provided with filters for details.

Batteries

- **Rechargeable Li-ion Battery EN-EL9:** Additional EN-EL9 batteries are available from local retailers and Nikon service representatives.

AC Adapter EH-5a/Power Connector EP-5

- **Power Connector EP-5**
- **AC Adapter EH-5a**

Use the AC Adapter EH-5a to power the camera for extended periods. The Power Connector EP-5 is required (available separately) to connect the AC adapter to the D60. The AC Adapter EH-5 can be used in place of the EH-5a. For more information about connecting the AC adapter to the camera using power connector, see "Connecting the Power Connector and the AC Adapter" (📖 157).

Body Cap BF-1A

The BF-1A keeps the mirror, viewfinder screen, and low-pass filter free of dust when a lens is not in place.

Video Cable

- **Video Cable EG-D100:** View photographs on TV or record them to video tape by connecting to television or VCR using video cable.

Wireless Remote Control ML-L3

Use as a remote shutter release for self-portraits or to prevent blur caused by camera shake. The ML-L3 uses a 3V CR2505 battery.

Replacing the Battery

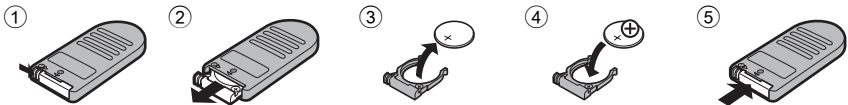

Software

- **Capture NX:** A complete photo editing package offering support for RAW images, as well as a variety of enhancement features, including those for editing white balance and applying Color Control Points. Be sure to update to the latest version.*
 - **Camera Control Pro 2:** Control the camera from a computer and save photographs to disk. Be sure to update to the latest version.*
- * Nikon Message Center automatically check for updates if an Internet connection is detected at startup.

Up to date information is available at Nikon websites or from our latest product catalogs.

Connecting the Power Connector and the AC Adapter

Turn off the camera before connecting the power connector and the AC adapter.

- 1** Open the battery-chamber **①** and power-connector **②** covers.

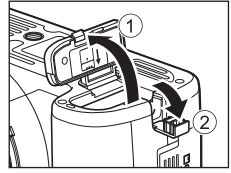

- 2** Insert the Power Connector EP-5 into the battery chamber as shown at right, making sure the "+" and "-" terminals are in the correct orientation.

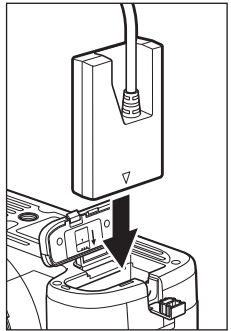

- 3** Guide the power cord into the opening left by the power connector cover and close the battery-chamber cover.

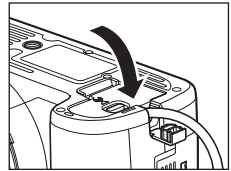

- 4** Connect the AC Adapter EH-5a plug to the AC inlet on the AC adapter **③** and the EH-5a DC plug to the EH-5 DC in connector **④**. When the camera is powered by the AC adapter, the battery-level indicator in the monitor will show .

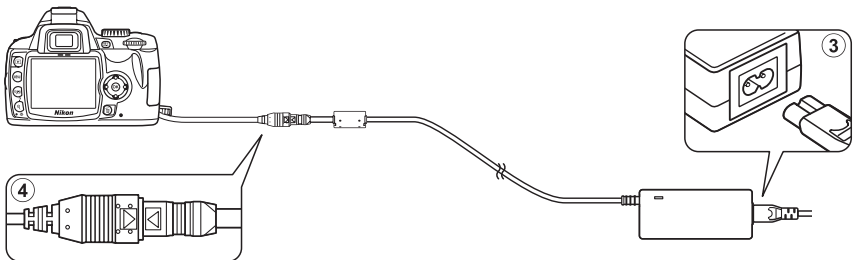

Approved Memory Cards

The following memory cards have been tested and approved for use in the D60. All cards of the designated make and capacity can be used, regardless of speed.

SanDisk	64MB, 128MB, 256MB, 512MB, 1GB, 2GB ¹ , 4GB ²
Toshiba	64MB, 128MB, 256MB, 512MB, 1GB, 2GB ¹ , 4GB ²
Panasonic	64MB, 128MB, 256MB, 512MB, 1GB, 2GB ¹ , 4GB ² , 8GB ²
Lexar	128MB, 256MB, 512MB, 1GB Platinum II: 512MB, 1GB, 2GB ¹ , 4GB ² Professional: 1GB, 2GB ¹

1 If the memory card will be used with a card reader or similar device, check that device supports 2GB cards.

2  SDHC compliant. If the memory card will be used with a card reader or similar device, check that device supports SDHC.

Operation is not guaranteed with other makes of card. Contact the manufacturer for details on the above cards.

Maximizing the Life of the Camera

Caring for the Camera

Storage

When the camera will not be used for an extended period, turn the camera off, remove the battery, and store the battery in a cool, dry area with the terminal cover in place. To prevent mold or mildew, store the camera in a dry, well-ventilated area. Do not store the camera with naphtha or camphor moth balls or in locations that:

- are poorly ventilated or subject to humidities of over 60%
- are next to equipment that produces strong electromagnetic fields, such as televisions or radios
- are exposed to temperatures above 50°C/122°F (for example, near a space heater or in a closed vehicle in a hot day) or below -10°C (14°F)

Cleaning

Camera body

Use a blower to remove dust and lint, then wipe gently with a soft, dry cloth. After using the camera at the beach or seaside, wipe off sand or salt with a cloth lightly dampened in distilled water and dry thoroughly. **Important:** *Dust or other foreign matter inside the camera may cause damage not covered under warranty.*

Lens, mirror, and viewfinder

These elements are made of glass and are easily damaged. Remove dust and lint with a blower. If using an aerosol blower, keep the can vertical to prevent the discharge of liquid. To remove fingerprints and other stains, apply a small amount of lens cleaner to a soft cloth and clean with care.

Monitor

Remove dust and lint with a blower. When removing fingerprints and other stains, wipe the surface lightly with a soft cloth or chamois leather. Do not apply pressure, as this could result in damage or malfunction.

✓ The Monitor

Should the monitor break, care should be taken to avoid injury caused by broken glass and to prevent liquid crystal from the monitor from entering your eyes or mouth.

✓ Servicing the Camera and Accessories

The D60 is a precision device and requires regular servicing. Nikon recommends that the camera be inspected by the original retailer or Nikon service representative once every one to two years, and that it be serviced once every three to five years (note that fees apply to these services). Frequent inspection and servicing are particularly recommended if the camera is used professionally. Any accessories regularly used with the camera, such as lenses or optional Speedlights, should be included when the camera is inspected or serviced.

Caring for the Optical Low-Pass Filter

Automatic Low-Pass Filter Cleaning (Clean Image Sensor)

The image sensor that acts as the camera's photograph element is fitted with a low-pass filter to prevent moiré. If you suspect that dirt or dust on the filter is appearing in photographs, you can clean the filter using the **Clean image sensor** option in the setup menu.

The filter can be cleaned at any time using the **Clean now** option, or cleaning can be performed automatically when the camera is turned on or off.

Cleaning from the Setup Menu Option

1 Place the camera base down.

Image sensor cleaning is most effective when the camera is placed base down as shown at right.

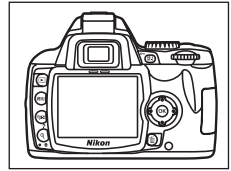

2 Display the Clean image sensor menu.

Highlight **Clean image sensor** in the setup menu and press the multi selector right.

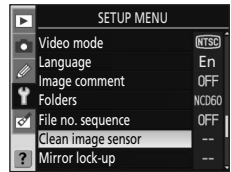

3 Select Clean now.

Highlight **Clean now** and press **OK** to start cleaning.

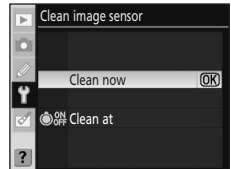

The message shown at right will be displayed while cleaning is in progress.

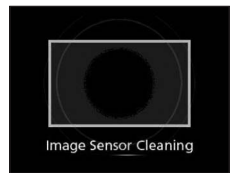





Image Sensor Cleaning

The following interrupt image sensor cleaning:

- Pressing the shutter-release button.
- Pressing , , , or .

Cleaning is performed by vibrating the image sensor. If dust cannot be fully removed using the options in the **Clean image sensor** menu, clean the image sensor manually ( 162) or consult a Nikon-authorized service representative.

If image sensor cleaning is performed several times in succession, image sensor cleaning may be temporarily disabled to protect the camera's internal circuitry. Cleaning can be performed again after a short wait.

Cleaning at Startup/Shutdown

1 Select **Clean at**.

Display the **Clean image sensor** menu as described in step 2 of "Cleaning from the Setup Menu Option" (160).

Highlight **Clean at** and press the multi selector right.

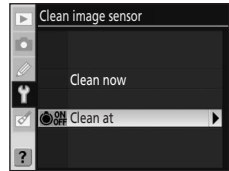

2 Select an option.

Highlight one of the following options and press **OK**.

ON Startup

The image sensor is automatically cleaned each time the camera is turned on.

OFF Shutdown

The image sensor is automatically cleaned during shutdown each time the camera is turned off.

ON **OFF** Startup and shutdown (default setting)

The image sensor is cleaned automatically at startup and shutdown.

Cleaning off

Automatic image sensor cleaning off.

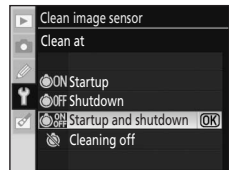

Cleaning the Low-Pass Filter Manually

If image sensor cleaning (🔍 160) is unable to completely remove dirt or dust from the filter, you can clean the filter as described below. Note, however, that the filter is extremely delicate and easily damaged. Nikon recommends that the filter be cleaned only by Nikon-authorized service personnel. To prevent the camera from powering off while the mirror is raised, use a fully-charged battery or an optional AC Adapter EH-5a with a Power Connector EP-5 (🔍 156).

1 Turn the camera off and remove the lens, and turn the camera on.

Do not turn the camera on until after the lens has been removed.

2 Select **Mirror lock-up** from the setup menu.

Note that this option is not available at battery levels of  or below.

3 Highlight **On** and press **OK**.

The message shown at right will be displayed. To restore normal operation without inspecting the low-pass filter, turn the camera off.

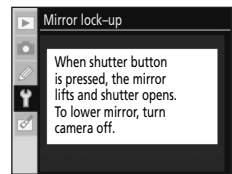

4 Press the shutter-release button all the way down.

The mirror will be raised and the shutter curtain will open, revealing the low-pass filter.

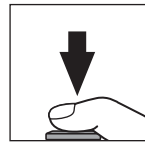

5 Holding the camera so that light falls on the low-pass filter, examine the filter for dust or lint.

If no foreign objects are present, proceed to step 7.

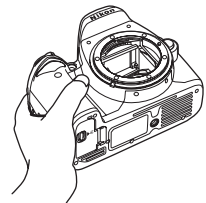

✔ Use a Reliable Power Source

The shutter curtain is delicate and easily damaged. If the camera turns off with the mirror raised, the curtain will close automatically. To prevent damage to the curtain, observe the following precautions:

- Do not turn the camera off until cleaning or inspection is complete. Do not remove or disconnect the power source while the mirror is raised.
- If the battery runs low while the mirror is raised, a beep will sound and the AF-assist illuminator will blink to warn that the shutter curtain will close and the mirror will be lowered after about two minutes. End cleaning or inspection immediately.

Download from [Www.Somanuals.com](http://www.Somanuals.com). All Manuals Search And Download.

6 Remove any dust and lint from the filter with a blower.

Do not use a blower-brush, as the bristles could damage the filter. Dirt that cannot be removed with a blower can only be removed by Nikon-authorized service personnel. **Under no circumstances should you touch or wipe the filter.**

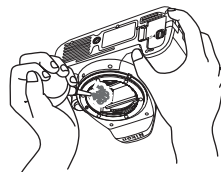

7 Turn the camera off.

The mirror will be lowered and the shutter curtain will close. Replace the lens or body cap.

✓ Foreign Matter on the Low-Pass Filter

Nikon takes every possible precaution to prevent foreign matter from coming into contact with the low-pass filter during production and shipping. The D60, however, is designed to be used with interchangeable lenses, and foreign matter may enter the camera when lenses are removed or exchanged. Once inside the camera, this foreign matter may adhere to the low-pass filter, where it may appear in photographs taken under certain conditions. To protect the camera when no lens is in place, be sure to replace the body cap provided with the camera, being careful to first remove all dust and other foreign matter that may be adhering to the body cap.

Should foreign matter find its way onto the low-pass filter, clean the filter as described above, or have it cleaned by authorized Nikon service personnel. Photographs affected by the presence of foreign matter on the filter can be retouched using Capture NX (available separately;  156) or the clean image options available in some third-party imaging applications.

Download from [Www.Somanuals.com](http://www.Somanuals.com). All Manuals Search And Download.

Caring for the Camera and Battery: Cautions

The Camera and Lens

Do not drop: The product may malfunction if subjected to strong shocks or vibration.

Keep dry: This product is not waterproof, and may malfunction if immersed in water or exposed to high levels of humidity. Rusting of the internal mechanism can cause irreparable damage.

Avoid sudden changes in temperature: Sudden changes in temperature, such as occur when entering or leaving a heated building on a cold day, can cause condensation inside the device. To prevent condensation, place the device in a carrying case or plastic bag before exposing it to sudden changes in temperature.

Keep away from strong magnetic fields: Do not use or store this device in the vicinity of equipment that generates strong electromagnetic radiation or magnetic fields. Strong static charges or the magnetic fields produced by equipment such as radio transmitters could interfere with the monitor, damage data recorded on the memory card, or affect the product's internal circuitry.

Do not leave the lens pointed at the sun: Do not leave the lens pointed at the sun or other strong light source for an extended period. Intense light may cause the image sensor to deteriorate or produce a white blur effect in photographs.

Do not touch the shutter curtain: The shutter curtain is extremely thin and easily damaged. Under no circumstances should you exert pressure on the curtain, poke it with cleaning tools, or subject it to powerful air currents from a blower. These actions could scratch, deform, or tear the curtain.

Handle all moving parts with care: Do not apply force to the battery-chamber, card-slot, or connector covers. These parts are especially susceptible to damage.

Lens contacts: Keep the lens contacts clean.

Turn the product off before removing or disconnecting the power source: Do not unplug the product or remove the battery while the product is on or while images are being recorded or deleted. Forcibly cutting power in these circumstances could result in loss of data or in damage to product memory or internal circuitry. To prevent an accidental interruption of power, avoid carrying the product from one location to another while the AC adapter is connected.

Cleaning: When cleaning the camera body, use a blower to gently remove dust and lint, then wipe gently with a soft, dry cloth. After using the camera at the beach or seaside, wipe off any sand or salt using a cloth lightly dampened in pure water and then dry the camera thoroughly.

The lens and mirror are easily damaged. Dust and lint should be gently removed with a blower. When using an aerosol blower, keep the can vertical to prevent discharge of liquid. To remove fingerprints and other stains from the lens, apply a small amount of lens cleaner to a soft cloth and wipe the lens carefully.

See "Cleaning the Low-Pass Filter Manually" (🔧 162) for information about cleaning the low-pass filter.

Storage: To prevent mold or mildew, store the camera in a dry, well-ventilated area. If the product will not be used for an extended period, remove the battery to prevent leakage and store the camera in a plastic bag containing a desiccant. Do not, however, store the camera case in a plastic bag, as this may cause the material to deteriorate. Note that desiccant gradually loses its capacity to absorb moisture and should be replaced at regular intervals.

To prevent mold or mildew, take the camera out of storage at least once a month. Turn the camera on and release the shutter a few times before putting it away.

Store the battery in a cool, dry place. Replace the terminal cover before putting the battery away.

Notes on the monitor: The monitor may contain a few pixels that are always lit or that do not light. This is common to all TFT LCD monitors and does not indicate a malfunction.

Images recorded with the product are unaffected.

Images in the monitor may be difficult to see in a bright light.

Do not apply pressure to the monitor, as this could cause damage or malfunction. Dust or lint on the monitor can be removed with a blower. Stains can be removed by wiping lightly with a soft cloth or chamois leather. Should the monitor break, care should be taken to avoid injury from broken glass and to prevent liquid crystal from the monitor touching the skin or entering the eyes and mouth.

The Battery

Dirt on the battery terminals can prevent the camera from functioning and should be removed with a soft, dry cloth before use. After removing the battery from the camera, be sure to replace the terminal cover.

Charge the battery before use. When taking photographs on important occasions, ready a spare EN-EL9 battery and keep it fully charged. Depending on your location, it may be difficult to purchase replacement batteries on short notice.

On cold days, the capacity of batteries tends to decrease. Be sure the battery is fully charged before taking photographs outside in cold weather. Keep a spare battery in a warm place and exchange the two as necessary. Once warmed, a cold battery may recover some of its charge.

Continuing to charge the battery after it is fully charged can impair battery performance. Batteries may leak or explode if improperly handled. Observe the following precautions when handling batteries:

- Turn the product off before replacing the battery.
- The battery may become hot when used for extended periods. Observe due caution when handling the battery.
- Use only batteries approved for use in this equipment.
- Do not expose the battery to flame or excessive heat.
- After removing the battery from the camera, replace the terminal cover.

Used batteries are a valuable resource. Please recycle used batteries in accord with local regulations.

Technical Notes

Troubleshooting

If the camera fails to function as expected, check the list of common problems below before consulting your retailer or Nikon representative. Refer to the page numbers in the right-most column for more information.

Display

Problem	Solution	
Viewfinder is out of focus.	Adjust viewfinder focus or use optional diopter adjustment lenses.	26, 155
Displays turn off without warning.	Choose a longer auto off delay in the auto off timers option in the Custom Settings menu.	114
Shooting information display will not turn on.	<ul style="list-style-type: none"> Shooting information is not displayed when the shutter-release button is pressed halfway and then released when Off is selected for Auto shooting info. 	122
	<ul style="list-style-type: none"> Shooting information is not displayed while the shutter-release button is pressed halfway. 	30
	<ul style="list-style-type: none"> The Shooting info auto off function is on and the eye sensor has been activated. 	123
	<ul style="list-style-type: none"> When On is selected for Custom Setting 07 (Image review), the monitor will turn off and shooting information is not displayed when no operations are performed while the photograph is displayed after shooting. 	111
	<ul style="list-style-type: none"> The battery is exhausted. 	16
Camera stops functioning.	See "A Note on Electronically-Controlled Cameras," below.	—
Display in viewfinder is unresponsive and dim.	The response times and brightness of the viewfinder display varies with temperature.	—
Viewfinder display will not turn on.	The viewfinder display turns off when shooting information is displayed if On is selected for Shooting info auto off and the eye sensor is activated. Select Off to turn on the viewfinder display when shooting information is displayed.	123

A Note on Electronically-Controlled Cameras

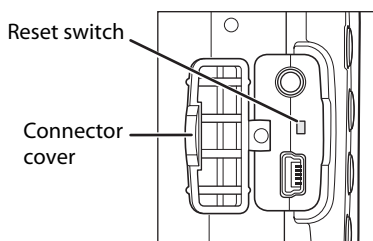

In extremely rare instances, a strong external static charge may cause the camera to stop functioning. Turn the camera off, remove and replace the battery (note that the battery may be hot) or disconnect and reconnect the AC adapter, and turn the camera on again. If the problem persists, turn the camera off and press the reset switch (see right; note that this resets the clock). Note that any data not recorded to the memory card at the time the problem occurred may be deleted. In the event of continued malfunction, contact your retailer or a Nikon-authorized service representative.



Shooting

All shooting modes

Problem	Solution	
Camera takes time to turn on.	Delete files or folders.	—
Shutter release is disabled.	<ul style="list-style-type: none"> • Memory card is full, locked, or not inserted. • Flash is charging. • Camera is not in focus. • CPU lens with aperture ring attached without locking aperture at highest f-number. • Non-CPU lens is attached: rotate camera mode dial to M. 	23, 25, 28, 33, 57, 19, 40, 146
Final photo is larger than area shown in viewfinder.	Viewfinder horizontal and vertical frame coverage is approximately 95%.	—
Image in viewfinder is not in focus.	<ul style="list-style-type: none"> • Manual focus selected: if AF-S or AF-I lens is attached, choose autofocus mode. Otherwise focus manually. • Camera unable to focus using autofocus: use manual focus or focus lock. • Lens is not AF-S or AF-I: use manual focus. 	61, 38, 60, 61, 146
Menu item is not displayed.	Select Full for CSM/Setup menu .	118
Image size cannot be changed.	Select an image quality setting other than RAW or RAW+B .	50
Cannot select focus point.	<ul style="list-style-type: none"> • Closest subject selected for AF-area mode: choose another mode. • Press the shutter-release button halfway to activate exposure meters. • Focus point cannot be selected when playing back photographs or displaying the menus. 	58, 33, —
Camera is slow to record photos.	<ul style="list-style-type: none"> • Turn Active D-Lighting off. • Turn noise reduction off. 	69, 108

Problem	Solution	
Randomly-spaced bright pixels ("noise") appears in photographs.	<ul style="list-style-type: none"> Lower ISO sensitivity or use noise reduction. Shutter speed is slower than 8s: use noise reduction. 	53, 108 108
AF-assist illuminator does not light.	<ul style="list-style-type: none"> Mode dial rotated to  or : select another mode. AF-assist lamp does not light for manual focus, continuous-servo autofocus, or when focus mode automatically switches from auto-servo AF to continuous-servo AF. Choose AF-S. Center focus point is not selected: select center focus point Choose On for Custom Setting 9 (AF-assist). Illuminator has turned off automatically. Illuminator may become hot with continued use; wait for lamp to cool down. 	6,36–37 57 59 111 —
No photo taken when remote control shutter-release button is pressed.	<ul style="list-style-type: none"> Replace battery in remote control. Choose remote control mode. Flash is charging. Time selected for Custom Setting 17 (Remote on duration) has passed: reselect remote control mode. Extreme backlighting may interfere with remote control shooting. 	156 55 33 115 —
Dirt or dust appears in photographs.	Clean lens and low-pass filter.	159, 162
Menu item cannot be selected.	Rotate mode dial to another setting or insert memory card.	6, 23
Date cannot be imprinted.	Date cannot be imprinted on photographs taken when RAW or RAW+B is selected for Image quality in the shooting menu.	50

P, S, A, and M modes

Problem	Solution	
Shutter release is disabled.	<ul style="list-style-type: none"> Non-CPU lens is attached: rotate camera mode dial to M. Mode dial rotated to S after shutter speed of "bulb" or "time" selected in mode M: choose new shutter speed. 	44, 146 42, 44

Troubleshooting

Problem	Solution	
Reddish areas appear in photos.	Reddish areas may appear in long time-exposures. Turn noise reduction on when taking pictures at shutter speeds of “bulb” or “time”.	46, 108
Full range of shutter speeds not available.	Flash in use.	179
Focus does not lock when shutter-release button is pressed halfway.	Use AF-L to lock focus in AF-C autofocus mode or when photographing moving subjects in AF-A mode.	57, 60
Colors are unnatural	<ul style="list-style-type: none"> Adjust white balance to match light source. Adjust Optimize image settings. 	52, 103, 104, 105, 101
Cannot measure white balance.	Subject is too dark or too bright.	105
Image cannot be selected as source for preset manual.	Image was not created with D60.	107
Inconsistent results with a series of photographs.	Select Custom in Optimize image and choose a setting other than Auto for image sharpening and tone compensation.	102
Metering cannot be changed.	Autoexposure lock in effect.	63
Only one shot taken each time shutter-release button is pressed in continuous release mode.	Continuous shooting is not available when built-in flash is required.	54, 64, 66

Playback

Problem	Solution	
RAW image is not played back.	When photo was taken at image quality of NEF + JPEG, only the JPEG image will be played back.	50
Some photos are not displayed during playback.	Select All for Playback folder . Note that Current will automatically be selected when next photo is taken.	97
Flashing areas appear in images.	Photo information, “Highlights” is displayed.	73, 75
Shooting data appear on images.	Photo information, “Shooting data” is displayed.	73, 74
A graph appears during playback.	Photo information, “Histogram” is displayed.	73, 75











Problem	Solution	
“Tall” (portrait) orientation photos are displayed in “wide” (landscape) orientation.	<ul style="list-style-type: none"> • Select On for Rotate tall. • Photo was taken with Off selected for Auto image rotation. • Camera orientation was changed while the shutter-release button was pressed in continuous release mode. • Camera was pointed up or down when photo was taken. 	98 128 128 128
Cannot delete photo.	Photo is protected: remove protection. Slide write-protect switch to “write” position.	78 25
Message displayed stating that no images are available for playback.	Select All for Playback folder . Note that Current will automatically be selected when next photo is taken.	97
Image not displayed after shooting.	Select On for Image review in Custom Settings menu.	111
Cannot retouch photo.	<ul style="list-style-type: none"> • Some retouch options cannot be applied to copies. • Photo created or modified with other device. 	130
Cannot change print order.	Memory card is full or locked.	25, 28
Cannot select photo for printing.	<ul style="list-style-type: none"> • Photo is in RAW (NEF) format. Create JPEG-format copy from NEF (RAW) photo using Quick retouch or NEF (RAW) processing in the retouch menu. • Transfer to computer and print using ViewNX or Capture NX. 	140 80, 83
Photo is not displayed on TV.	Choose correct video mode.	92, 123
Cannot transfer photographs to a computer.	If your computer is running Windows 2000 Professional, camera cannot be connected to the computer.	82
Cannot open images with Capture NX.	Update software to latest version.	51, 156
Cannot use Camera Control Pro 2.	Update software to latest version.	156

Others



Problem	Solution	
Date of recording is not correct.	Set camera clock.	21
Cannot select some items displayed in the menu screen.	Some menu items are not available depending on the current camera settings.	176
Menu item is not displayed.	Select Full for CSM/Setup menu .	118



Camera Error Messages and Displays

This section lists common warning indicators and error messages that appear in the viewfinder and monitor.





Message	Viewfinder	Solution	
Lock lens aperture ring at minimum aperture (largest f-number).	 (blinks)	Lock ring at minimum aperture (largest f-number).	19, 40
Lens not attached.	 (blinks)	<ul style="list-style-type: none"> No lens attached: attach lens. Attached lens is not CPU lens: select mode M. 	18
Attach a lens.	 (blinks)		40, 44, 62, 146
Shutter release disabled. Recharge battery.	 (blinks)	Turn camera off and recharge battery or replace with fully-charged spare battery.	16, 28
This battery cannot be used. Choose battery designated for use in this camera.	 (blinks)	Insert EN-EL9 battery.	16–17
Initialization error. Turn camera off and then on again.	 (blinks)	Turn camera off, remove and reinsert battery, and then turn camera on again.	6, 16–17
Battery level is low. Complete operation and turn camera off immediately.	—	End cleaning or inspection of low-pass filter and turn camera off immediately.	162
Clock not set.	 (blinks)	Set camera clock.	21
No SD card inserted.	 (blinks)	Insert memory card.	23–24
—	 (blinks)	Subject is not in focus. Recompose or focus manually.	61
Memory card is locked. Slide lock to “write” position.	 (blinks)	Slide card write-protect switch to “write” position.	23

Help

A blinking  is displayed in the monitor or a blinking  (warning indicator) displayed in the viewfinder indicates that a description of the current problem can be viewed by pressing .

Message	Viewfinder	Solution	
This memory card cannot be used. Card may be damaged. Insert another card.	[Err] (blinks)	<ul style="list-style-type: none"> • Use Nikon-approved card. • Card may be damaged. Format memory card again. If error persists, contact retailer or Nikon-authorized service representative. • If this message is displayed when creating a new folder, delete unwanted files. • Insert new memory card. 	158 23–24, 34, 96 23
This card is not formatted. Format the card.	[Err] (blinks)	Format memory card.	24
Card is full	Full (blinks)	<ul style="list-style-type: none"> • Make copies of any photographs you wish to keep and delete unwanted photographs. • Reduce image quality or size. • Delete photographs and/or reset sequential file numbering then format the memory card. • Insert new memory card. 	34, 80, 96 49–50 34, 96, 24 23
Subject is too bright.	Hi	<ul style="list-style-type: none"> • Choose lower ISO sensitivity. • Increase shutter speed. • Choose smaller aperture (larger f-number). • Use optional Neutral Density (ND) filter. 	53 40–46 40–46 155
Subject is too dark.	Lo	<ul style="list-style-type: none"> • Choose higher ISO sensitivity. • Use flash. • Decrease shutter speed. • Choose larger aperture (smaller f-number). 	53 64 40–46 40–46
—	 (blinks)	Flash has fired at full power. View photo; if underexposed, adjust settings and try again.	40–46, 53, 62, 68, 113, 179

Camera Error Messages and Displays

Message	Viewfinder	Solution	
—	 (blinks)	<ul style="list-style-type: none"> Built-in flash is lowered: raise built-in flash Reduce distance to subject, use larger aperture, or increase ISO sensitivity or flash range. Flash head on optional SB-400 Speedlight is in bounce-flash position. SB-400 is unable to fully illuminate subject at current lens focal length. Increase distance to subject (this warning is not displayed with other optional Speedlights). 	64 40–46, 53, 153, 179 150 150
Flash is in TTL mode. Choose another setting or use a CPU lens.	 (blinks)	<ul style="list-style-type: none"> Change flash control mode for optional Speedlight. Attach a CPU lens. 	153 146
No Bulb in S mode.	 (blinks) - - (blinks)	Change shutter speed or select mode M .	39–46
Unable to measure preset white balance. Please try again.	 (blinks)	Camera unable to measure a value for preset white balance. Adjust exposure settings and try again.	67, 105
FOLDER CONTAINS NO IMAGES.	—	<ul style="list-style-type: none"> Insert another memory card. Set Playback folder to All. 	23 97
FILE DOES NOT CONTAIN IMAGE DATA.	—	<ul style="list-style-type: none"> Image files edited on a computer do not support DCF (The Design Rule for Camera File Systems) and cannot be played back. Image file is damaged. 	—
CHECK PRINTER.	—	Insert new ink or toner cartridge in printer. If error occurs with ink remaining in printer, check printer status.	88

Message	Viewfinder	Solution	
Error. Press shutter release button again.	Err (blinks)	Press shutter-release button again. If error persists, consult with Nikon-authorized service representative.	32–33
Initialization error. Contact Nikon-authorized service representative.	Err (blinks)	Contact Nikon-authorized service representative.	

Available Settings and Defaults

The following defaults are restored with Custom Setting R (**Reset**).

Custom settings	AUTO								P	S	A	M
01 Beep	On											
02 Focus mode ¹	AF-A (Set to MF with some lenses)											
03 AF-area mode ^{1, 2}	Closest subject			Dynamic area	Single point	Closest subject						
04 Release mode ¹	Single frame											
05 Metering ¹	Matrix (fixed)									Matrix		
06 No memory card?	Release locked											
07 Image review	On											
08 Flash compensation ¹	—									0.0		
09 AF-assist	On	Off (fixed)	On	Off (fixed)	On							
10 ISO auto	—									Off		
11 Fn button	Self-timer											
12 AE-L/AF-L	AE/AF lock											
13 AE lock	Off											
14 Built-in flash	—									TTL		
15 Auto off timers	Normal											
16 Self-timer	10 s											
17 Remote on duration	1 min.											
18 Date imprint	Off											
19 Rangefinder	Off											

1 Reset with two-button reset (70).

2 Reset when the mode dial is rotated to new setting in or mode.

Defaults for other settings are listed below.

Playback menu	AUTO								P	S	A	M
Playback folder	Current											
Rotate tall	On											
Slide show > Frame interval	2 s											

Shooting menu	AUTO								P	S	A	M
Optimize image	—								Normal			
Image quality ¹	JPEG normal											
Image size ¹	Large											
White balance ¹	Auto (fixed)								Auto			
ISO sensitivity ¹	Auto								100			
Noise reduction									Off			
Active D-Lighting ¹									Off			

Setup menu	AUTO								P	S	A	M
CSM/Setup menu	Simple											
Info display format	Graphic (Background color: White)											
Auto shooting info	On											
Shooting info auto off	On											
World time	2008.01.01.00:00:00 (format and time zone vary with region of sale)											
LCD brightness	LCD brightness: 0, Auto dim: On											
Video mode	Varies with region of sale											
Language	Varies with region of sale											
Image comment	—											
Folders	NCD60											
File no. sequence	Off											
Clean image sensor > Clean at	Startup and shutdown											
Auto image rotation	On											

Other settings	AUTO								P	S	A	M
Focus point	—					Center		—				
Focus lock	Off											
Flexible program ^{1, 2, 3}	—								Off	—		
AE lock hold ¹	Off ⁴								Off		—	
Exposure compensation ¹	—								0.0			
Flash mode ¹	①	Off (fixed)	①	②	①	②	①	③	Fill flash			

1 Reset with two-button reset (70).

2 Reset when the mode dial is rotated to new setting.

3 Reset when the camera is turned off.

4 AE lock is not recommended as matrix metering is applied and AE lock may not be sufficiently effective.

① Auto (reset when the mode dial is rotated to new setting or the camera is turned off).

② Built-in flash does not fire, fill flash with optional Speedlight.

③ Auto slow sync (reset when the mode dial is rotated to new setting or the camera is turned off).

Memory Card Capacity and Image Quality/Size

The following table shows the approximate number of photographs that can be recorded on a 1 GB memory card at different image quality and size settings¹.

All figures are approximate; actual file size and memory card capacity may vary with scene recorded and make of memory card.

Image quality	Image size	File size (MB) ²	Number of images	Buffer capacity ³
RAW	—	9.0	79	6
FINE	L	4.8	129	100
	M	2.7	225	100
	S	1.2	487	100
NORMAL	L	2.4	251	100
	M	1.3	431	100
	S	0.6	888	100
BASIC	L	1.2	487	100
	M	0.7	839	100
	S	0.3	1500	100
RAW+BASIC	—/L	10.1 ⁴	70	6

1 When Panasonic PRO HIGH SPEED memory card is used.

2 All figures are approximate and assume average file size.

3 Maximum number of photographs that can be taken before shooting stops. Actual number of frames may vary with make of memory card. Additional photographs can be taken as soon as enough memory is available in memory buffer.

4 Combined NEF (RAW) and JPEG file sizes.

Exposure Program (Mode P)

The exposure program for mode P is shown in the following graph.

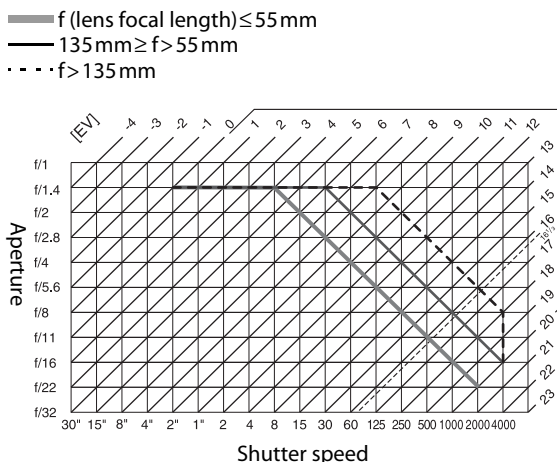

The maximum and minimum values for EV vary with ISO sensitivity; the above graph assumes an ISO sensitivity of ISO 100. When matrix metering is used, values over $16^{1/3}$ EV are reduced to $16^{1/3}$ EV.

Flash Control

Flash output is adjusted using one of the following systems when a CPU lens is used in combination with the built-in flash or optional SB-400, SB-800, or SB-600 Speedlights.

i-TTL Balanced Fill-Flash for Digital SLR





Flash output is adjusted for a natural balance between the main subject and the background.

Standard i-TTL Fill-Flash for Digital SLR

Flash output is adjusted for the main subject; the brightness of the background is not taken into account. Recommended for use with exposure compensation, for shots in which the main subject is emphasized at the expense of background details.

Standard i-TTL flash control is used with spot metering ( 62) or when selected with the optional Speedlight. i-TTL balanced fill-flash for digital SLR is used in all other cases.

Shutter Speeds Available with the Built-in Flash

Mode	Shutter speed
   P, A	$1/200$ – $1/60$ s
	$1/200$ – $1/125$ s
	$1/200$ –1 s

Mode	Shutter speed
S	$1/200$ –30s
M	$1/200$ –30s, Bulb

Aperture, Sensitivity, and Flash Range

Flash range varies with sensitivity (ISO equivalency) and aperture.

	ISO equivalent					Range (m/ft.)
	100	200	400	800	1600	
Aperture	1.4	2	2.8	4	5.6	1.0–8.5 (3ft. 3in.–27ft. 11in.)
	2	2.8	4	5.6	8	0.7–6.0 (2ft. 4in.–19ft. 8in.)
	2.8	4	5.6	8	11	0.6–4.2 (2ft.–13ft. 9in.)
	4	5.6	8	11	16	0.6–3.0 (2ft.–9ft. 10in.)
	5.6	8	11	16	22	0.6–2.1 (2ft.–6ft. 11in.)
	8	11	16	22	32	0.6–1.5 (2ft.–4ft. 11in.)
	11	16	22	32	—	0.6–1.1 (2ft.–3ft. 7in.)
	16	22	32	—	—	0.6–0.7 (2ft.–2ft. 4in.)

Specifications

Nikon D60 Digital Camera

Type	
Type	Single-lens reflex digital camera
Lens mount	Nikon F mount (with AF contacts)
Effective picture angle	Approx. 1.5 × lens focal length (Nikon DX format)
Effective pixels	
10.2 million	
Image sensor	
Image sensor	23.6 × 15.8 mm CCD sensor
Total pixels	10.75 million
Dust-reduction System	Image sensor cleaning, Image Dust Off reference data (optional Capture NX software required)
Storage	
Image size (pixels)	<ul style="list-style-type: none">• 3,872 × 2,592• 2,896 × 1,944• 1,936 × 1,296
File format	<ul style="list-style-type: none">• NEF (RAW): 12-bit compressed• JPEG: JPEG-Baseline compliant with fine (approx. 1 : 4), normal (approx. 1 : 8), or basic (approx. 1 : 16) compression• NEF (RAW)+JPEG: Single photograph recorded in both NEF (RAW) and JPEG formats
Media	SD (Secure Digital) memory cards, SDHC-compliant
File system	DCF (D esign R ule for C amera F ile System) 2.0, DPOF (D igital P rint O rders F ormat), Exif 2.21 (E xchangeable I mage F ile F ormat for Digital Still Cameras), PictBridge
Viewfinder	
Viewfinder	Eye-level penta-Dach mirror single-lens reflex viewfinder
Frame coverage	Approx. 95 % horizontal and 95 % vertical
Magnification	Approx. 0.80 × (50mm f/1.4 lens at infinity, -1.0 m ⁻¹)
Eyepoint	18 mm (-1.0 m ⁻¹)
Diopter adjustment	-1.7 – +0.5 m ⁻¹
Focusing screen	Type B BriteView Clear Matte screen Mark V
Reflex mirror	Quick return
Lens aperture	Instant return, electronically controlled

Lens	
Compatible lenses	<ul style="list-style-type: none"> • AF-S and AF-I NIKKOR: All functions supported • Type G or D AF NIKKOR not equipped with an autofocus motor: All functions supported except autofocus. • Non-Type G or D AF NIKKOR not equipped with an autofocus motor: All functions supported except 3D color matrix metering II and autofocus. • IX-NIKKOR and AF-NIKKOR for F3AF: Not supported. • Type D PC NIKKOR: All functions supported except some shooting modes. • AI-P NIKKOR: All functions supported except 3D color matrix metering II • Non-CPU: Autofocus not supported. Can be used in exposure mode M, but exposure meter does not function. • Lens with maximum aperture of f/5.6 or faster: Electronic rangefinder can be used.
Shutter	
Type	Electronically-controlled vertical-travel focal-plane shutter
Speed	$\frac{1}{4000}$ -30 s in steps of $\frac{1}{3}$ EV, Bulb, Time (optional Wireless Remote Control ML-L3 required)
Flash sync speed	$X=\frac{1}{200}$ s; synchronizes with shutter at $\frac{1}{200}$ s or slower
Release	
Release mode	Single frame, Continuous Self-timer, Remote control (optional Wireless Remote Control ML-L3 required)
Frame advance rate	Up to 3 fps (by selecting Manual focus mode, rotating the mode dial to Shutter-priority auto or Manual mode, selecting a shutter speed of $\frac{1}{250}$ s or faster, and using defaults for all other settings).
Self-timer	Can be selected from 2, 5, 10, and 20 s duration
Exposure	
Metering	TTL exposure metering using 420-segment RGB sensor
Metering method	<ul style="list-style-type: none"> • Matrix: 3D color matrix metering II (type G and D lenses); color matrix metering II (other CPU lenses) • Center-weighted: Weight of 75 % given to 8-mm circle in center of frame • Spot: Meters 3,5-mm circle (about 2,5 % of frame) centered on selected focus point (on center focus point when non-CPU lens is used)
Range (ISO 100, f/1.4 lens, 20°C/68°F)	<ul style="list-style-type: none"> • Matrix or center-weighted metering: 0–20 EV • Spot metering: 2–20 EV
Exposure meter coupling	Combined CPU

Exposure mode	Digital Vari-Programs (Auto, Auto (flash off), Portrait, Landscape, Child, Sports, Close up, Night portrait) Programmed auto with flexible program Shutter-priority auto Aperture-priority auto Manual
Exposure compensation	-5 – +5 EV in increments of $\frac{1}{3}$ EV
Exposure lock	Luminosity locked at detected value with AE-L
ISO sensitivity (Recommended Exposure Index)	ISO 100–1600 in steps of 1 EV. Can also be set to approx. 1 EV (ISO 3200 equivalent) above ISO 1600.
Active D-Lighting	Can be selected from On (auto) or Off
Focus	
Autofocus	Nikon Multi-CAM 530 autofocus sensor module with TTL phase detection, 3 focus points, and AF-assist illuminator (range approx. 0.5–3 m/1 ft. 8 in.–9 ft. 10 in.)
Detection range	-1 – +19 EV (ISO 100, 20°C/68°F)
Lens servo	<ul style="list-style-type: none"> Autofocus: Single-servo AF (S); Continuous-servo AF (C); Auto-servo AF (A) Predictive focus tracking automatically activated according to subject status in single- and continuous-servo AF. Manual focus: Electronic rangefinder can be used
AF-area mode	Single-point AF, dynamic-area AF, Closest subject AF
Focus lock	Focus can be locked by pressing the shutter-release button halfway (single-servo AF) or by pressing AE-L
Flash	
Built-in flash	<ul style="list-style-type: none"> Guide Number of 12/39 (m/ft, ISO 100, 20°C/68°F) or 13/43 in manual mode (m/ft, ISO 100, 20°C/68°F) Auto, Portrait, Child, Close up, and Night portrait modes: Auto flash with auto pop-up Programmed auto, Shutter-priority auto, Aperture-priority auto, and Manual modes: Manual pop-up with button release
Flash control	<ul style="list-style-type: none"> TTL for digital SLR using 420-segment RGB sensor i-TTL balanced fill-flash (with metering other than spot) and standard i-TTL flash (with spot metering) are available with built-in flash and SB-800, SB-600, or SB-400, and CPU lens Auto aperture: Available with SB-800 and CPU lens Non-TTL auto: Supported flash units include SB-800, SB-28, SB-27, SB-22S, SB-80DX, and SB-28DX Range-priority manual: Available with SB-800
Flash mode	Front curtain sync, slow sync, rear-curtain sync, red-eye reduction, red-eye reduction with slow sync
Flash compensation	-3 – +1 EV in increments of $\frac{1}{3}$ EV
Flash-ready indicator	Lights when built-in flash or Speedlight such as SB-800, SB-600, SB-400 is fully charged; blinks after flash is fired at full output

Accessory shoe	Standard ISO 518 hot-shoe contact with safety lock
Nikon Creative Lighting System (CLS)	<ul style="list-style-type: none"> Flash Color Information Communication supported with built-in flash and Nikon Creative Lighting System compatible Speedlight Advanced Wireless Lighting supported with SB-800, or SU-800 as commander
Sync terminal	Hot Shoe Sync Terminal Adapter AS-15 (available separately)
White balance	8 modes (when AUTO is selected, TTL white-balance with main image sensor and 420-segment RGB sensor is available); fine-tuning possible
Monitor	2.5-in., approx. 230k-dot, low-temperature polysilicon TFT LCD, brightness adjustment, and automatic off via eye sensor possible
Playback	Full-frame and thumbnail (four or nine images) playback with playback zoom, slide show, histogram display, highlights, auto image rotation, and stop-motion movies created with the D60
Interface	
USB	Hi-Speed USB Data transfer protocol: MTP, PTP
Video output	Can be selected from NTSC and PAL
Supported languages	Chinese (Simplified and Traditional), Dutch, English, Finnish, French, German, Italian, Japanese, Korean, Polish, Portuguese, Russian, Spanish, Swedish
Power source	
Battery	One EN-EL9 Rechargeable Li-ion Battery (supplied)
AC adapter	AC Adapter EH-5a (used with Power Connector EP-5) (available separately)
Tripod socket	$\frac{1}{4}$ in. (ISO 1222)
Dimensions/weight	
Dimensions (W × H × D)	Approx. 126 × 94 × 64 mm (5.0 × 3.7 × 2.5 in.)
Weight	Approx. 495 g (1lb. 1oz.) without battery, memory card, or body cap
Operating environment	
Temperature	0–40 °C (32–104 °F)
Humidity	Less than 85 % (no condensation)

- Unless otherwise stated, all figures are for a camera with a fully-charged battery operating at an ambient temperature of 20 °C (68 °F).

Specifications

Nikon reserves the right to change the specifications of the hardware and software described in this manual at any time and without prior notice. Nikon will not be held liable for damages that may result from any mistakes that this manual may contain.

Quick Charger MH-23

Rated input	AC 100–240 V (50/60 Hz)
Rated output	DC 8.4 V, 0.9 A
Supported batteries	Rechargeable Li-ion Battery EN-EL9
Charging time	Approx. 90 minutes when battery is fully discharged
Operating temperature	0–40 °C (32–104 °F)
Dimensions (W× H × D)	Approx. 82.5 × 28 × 65 mm (3.2 × 1.1 × 2.6 in.)
Length of cord	Approx. 1.8 m (5 ft. 11 in.)
Weight	Approx. 80 g (2.8 oz.), excluding power cable

Rechargeable Li-ion Battery EN-EL9

Type	Rechargeable lithium-ion battery
Rated capacity	7.4 V, 1000 mAh
Dimensions (W× H × D)	Approx. 36 × 56 × 14 mm (1.4 × 2.2 × 0.6 in.)
Weight	Approx. 51 g (1.8 oz.), excluding terminal cover

Battery Life

Battery life varies with charge state and shooting conditions. The number of shots that can be taken with a fully-charged EN-EL9 battery (1000mAh) is indicated below.

- AF-S DX NIKKOR 18-55mm f/3.5-5.6G ED II
Approximately 520 shots in single-frame release mode
Approximately 2,000 shots in continuous release mode
- AF-S DX NIKKOR 18-55mm f/3.5-5.6G VR with vibration reduction (VR) on
Approximately 500 shots in single-frame release mode
Approximately 1,850 shots in continuous release mode

Battery life for single-frame release mode is measured according to CIPA standards: lens cycled from infinity to minimum range and shutter released at default settings once every 30s; flash fired with every other shot. Battery life for continuous release mode is measured with image quality set to JPEG Basic, an image size of , a shutter speed of 1/250s, the shutter release pressed halfway for three seconds and focus then cycled from infinity to minimum range three times; after six shots, the monitor is turned on for five seconds and the camera not touched for six seconds after the monitor turns off; the cycle is repeated once exposure meters have turned off.

- Using the monitor
- Keeping the shutter-release button pressed halfway
- Repeated autofocus operations
- Taking NEF (RAW) photographs
- Slow shutter speeds
- Using vibration reduction with VR lenses

To ensure maximum battery performance:

- Keep the battery contacts clean. Soiled contacts can reduce battery performance.
- Use batteries immediately after charging. Batteries will lose their charge if left unused.
- The battery level displayed by the camera may vary with changes in temperature.

Lens

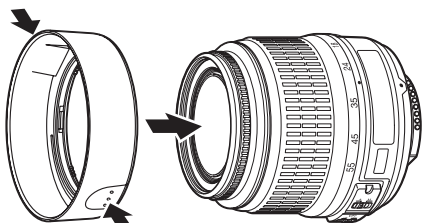
	AF-S DX Zoom-NIKKOR 18-55mm f/3.5-5.6G ED II Lens	AF-S DX NIKKOR 18-55mm f/3.5-5.6G VR Lens
Type of lens	G-type AF-S DX Zoom-NIKKOR lens with built-in CPU and Nikon bayonet mount (Specially designed for use with Nikon digital-SLR—Nikon DX-format—cameras)	
Focal length	18–55mm	
Maximum aperture	f/3.5–5.6	
Lens construction	7 elements in 5 groups (including 1 ED glass element and 1 aspherical element)	11 elements in 8 groups (1 aspherical lens element)
Picture angle	76°–28° 50′	
Focal length scale	18, 24, 35, 45, 55mm	
Distance information	Output to camera body	
Zoom control	Manually via separate zoom ring	
Focusing	Autofocus using a Silent Wave Motor; manually via separate focus ring	
Closest focus distance	0.28m (11 in.) at all zoom settings	
No. of diaphragm blades	7-blade (rounded)	
Aperture range	f/3.5 to f/22 (at 18mm), f/5.6 to f/38 (at 55mm)*	
Exposure measurement	Via full-aperture method	
Attachment size	52mm (P=0.75mm)	
Dimensions	Approx. 70.5 × 74 mm (2.8×3.0 in.) (extension from the camera's lens-mount flange)	Approx. 73 × 79.5 mm (2.9 × 3.1 in.) (extension from the camera's lens-mount flange)
Weight	Approx. 205 g (7.2 oz.)	Approx. 265 g (9.4 oz.)
Lens hood (available separately)	HB-45 (attaches as shown below) 	

* The minimum aperture available when these lenses are used with the D60 is f/36.

Specifications

























Nikon reserves the right to change the specifications of the hardware and software described in this manual at any time and without prior notice. Nikon will not be held liable for damages that may result from any mistakes that this manual may contain.

Download from www.Somanuals.com. All Manuals Search And Download.

Supported Standards

- **DCF Version 2.0:** The **D**esign Rule for **C**amera **F**ile Systems (DCF) is a standard widely used in the digital camera industry to ensure compatibility among different makes of camera.
- **DPOF: Digital Print Order Format** (DPOF) is an industry-wide standard that allows pictures to be printed from print orders stored on the memory card.
- **Exif version 2.21:** The D60 supports Exif (**Ex**changeable **I**mage **F**ile **F**ormat for Digital Still Cameras) version 2.21, a standard in which information stored with photographs is used for optimal color reproduction when the images are output on Exif-compliant printers.
- **PictBridge:** A standard developed through cooperation with the digital camera and printer industries, allowing photographs to be output directly to a printer without first transferring them to a computer.

Symbols

-  (auto) 28
-  Auto (flash off) 36
-  Portrait 36
-  Landscape 37
-  Child 37
-  Sports 37
-  Close up 37
-  Night portrait 37
- P** 41
- S** 42
- A** 43
- M** 44
-  (exposure compensation) button 4, 67, 68
-  (aperture) button 4, 44
-  (Active D-Lighting) button 4, 69, 70
-  (flash mode) button 4, 64, 65, 68
-  (flash compensation) button 4, 68
-  (self-timer) button 4, 54, 55
- Fn** FUNC. button 4, 112
-  **Fn** Button 112
-  (AE-L/AF-L) button 5, 60, 63, 78, 113
-  (protect) button 5, 78
-  (delete) button 5, 34
-  (playback zoom) button 5, 8, 48, 70, 77
-  (Information display/Quick settings display) button 5
-  (thumbnail/playback zoom out) button 5, 13, 76
-  (help) button 5, 13
- MENU** (menu) button 5, 94
-  (playback) button 5, 34, 72
-  (reset) button 4, 5, 70

A

- AC adapter 156, 157
- Accessories 155
- Accessory shoe 4, 150
 - cover 4, 150
- Active D-Lighting 69
 - indicator 9
- Active D-Lighting and retouch history 74
- AE-L/AF-L button 113
- AF-area mode 7, 9, 58
- AF-assist 111
- AF-assist illuminator 4, 57
- Aperture 7, 9, 40, 44

- display 9
- ring 40

- Aperture-priority auto 43
- Auto image rotation 128
- Auto meter off 31
- Auto off timers 114
- Auto shooting info 122
- Autoexposure (AE) lock 7, 63, 113
- Autofocus 18
- AVI 51

B

- Battery 155, 166
 - charging 16
 - indicator 7, 9, 28
 - inserting 16
 - level 29
- Battery-chamber cover 5, 17
 - latch 5, 17
- Beep 110
 - indicator 9
- Before and after 143
- Black-and-white 134
- Blue intensifier 135
- Body Cap BF-1A 156
- Border 86
- Built-in flash 4, 33, 64, 113
- Bulb 46

C

- Camera Control Pro 2 82, 156
- Capture NX 127, 156
- CHARGE lamp 17
- Clean image sensor 126, 160
- Closest subject 58
- Color
 - balance 135
 - mode 102, 103
 - space 103
 - temperature 104
- Command dial 5, 10
- Connector cover 4, 167
- Continuous 54
 - mode 54
- Cool-white fluorescent 103
- Cropping 87
- Cross screen 135

CSM/setup menu 118
 full 118
 my menu 119
 simple 118
Custom settings 109
Cyanotype 134

D

Date
 counter 116
 imprint 115
Date and time 21
Date imprint
 indicator 9
Day white fluorescent 103
Daylight fluorescent 103
Daylight saving time 21, 22
Default setting 70, 176
Delete 96
 current images 34
Diopter adjustment 26
 control 5, 26
D-Lighting 132
DPOF 186
Dust off ref photo 127
 indicator 7
Dynamic area 58

E

Electronic analog exposure display 7, 9, 45
Electronic rangefinder 61
Exif version 2.21 186
Exposure 40
Exposure compensation 7, 9, 67
 indicator 7
 value 7, 9
Eye sensor 5, 123
Eyelet for camera strap 4, 5
Eyepiece cap 56

F

File Information 73
File Names 51
File no. sequence 126
Filter 155
Filter effects 135
Firmware version 126
Flash
 control 179

 manual 113
 mode 65
 optional unit 113
 range 149, 179
 rear curtain sync 65, 66
 red-eye reduction 65
 slow sync 65
 sync mode 9
 TTL 113

Flash compensation 68
 button 4
 indicator 7, 9
 value 7, 9

Flash-ready indicator 7

Flexible program 41
 indicator 7

f-number 40, 44, 148

Focal
 length 20
 plane mark 4, 61

Focus 57
 indicator 7, 32, 38, 60, 61
 lock 38, 60
 points 7, 26, 30, 58, 59, 60

Focus mode 9
 auto-servo AF 57
 continuous-servo AF 57
 manual 38, 57, 61
 single-servo AF 57

Focus point display 9, 26, 30, 58, 59, 60

Folders 125

Frame interval 98

G

Green intensifier 135
Guide number 151

H

Help indicator 9, 172
Highlights 75
Histogram 75
Hue adjustment 102

I

Image
 overlay 138
 quality 9, 50, 178
 size 9, 50, 178
Image comment 124

Image review 111
 Index print 89
 Info display format 120
 classic 121
 wallpaper 122
 Infrared receiver 4, 56
 ISO auto 53, 111
 indicator 7, 9
 ISO sensitivity 9, 53
 Hi 1 53
 i-TTL balanced fill-flash for digital SLR 179

J

JPEG 50, 140
 JPG 51

L

Language 123
 LCD brightness 123
 Lens 19, 146, 149, 185
 attaching 18
 CPU 40, 62, 128, 146, 148
 mounting index 4, 18
 non-CPU 146, 147
 release button 4, 19
 Long time-exposures 46
 Low-pass filter 160, 162

M

Manual 44
 Manual flash control indicator 9
 Max. sensitivity 111
 Memory capacity 7, 9, 28, 55, 178
 large 7, 9, 29
 Memory card 23, 28, 158, 178
 access lamp 5, 23, 32
 formatting 24
 inserting 23
 removing 23
 slot cover 5, 23
 Mercury-vapor lamps 103
 Metering 62
 center-weighted 62
 matrix 62
 mode 9
 spot 62
 Min. shutter speed 111
 Mired 105
 Mirror lock-up 126, 162

Mode dial 4, 6
 Monitor 5, 8, 72, 123, 159, 165
 Monochrome 134
 Multi selector 5, 12

N

NDF 51
 NEF 51
 NEF (RAW) 51
 NEF (RAW) processing 140
 Nikon Transfer 80
 No memory card? 110
 No. of copies 86
 Noise reduction 108

O

Optimize image 101
 indicator 9

P

Page size 86
 PC connection indicator 7
 PC mode indicator 9
 Photo Information 73
 PictBridge 84, 85, 186
 Picture angle 20
 Playback
 folder 97
 full-frame 72
 thumbnail 76
 zoom 77
 Playback menu 96
 Power connector 156, 157
 cover 5, 157
 Power switch 4, 6
 Preset manual 105
 recording indicator 7, 9
 Print (DPOF) 88
 Print set (DPOF) 83, 90
 Printer 84, 85
 Programmed auto 41
 Protecting photographs 78

Q

Quick Charger MH-23 16, 184
 Quick retouch 132
 Quick settings display 48

R

Rangefinder 7, 116
 RAW+B 51
 Rechargeable Li-ion Battery EN-EL9 16, 184
 Red intensifier 135
 Red-eye
 correction 133
 reduction lamp 4, 65
 Release mode 9, 54
 Remote
 Control ML-L3 55, 56, 156
 control mode 55
 delayed 54, 55
 quick-response 54, 55
 Remote on duration 115
 Reset 110
 Reset switch 4, 167
 Retouch menu 129
 Rotate tall 98
 Rubber eyecup 56

S

Saturation 102
 Self-timer 54, 55, 114
 lamp 4, 56
 mode 55
 Sepia 134
 Setup menu 117
 Shooting data
 page 1 73
 page 2 74
 Shooting info auto off 123
 Shooting information display 48
 Shooting menu 100
 Shutter speed 7, 9, 40, 44, 179
 display 9
 Shutter-priority auto 42
 Shutter-release button 4, 13, 32
 half press 13
 Single frame 54
 Single point 58
 Skylight 135
 Slide show 98
 Small picture 136
 Sodium-vapor lamps 103
 Software Suite 80
 Speedlight 113, 150, 152, 153
 Standard i-TTL fill-flash for digital SLR 179
 Stop-motion movie (creation) 141

Stop-motion movie (playback) 99
 Strap 14

T

Terminal cover 16
 Time 46
 Time stamp 87
 Tone compensation 102
 Trim 134
 Two-button reset 70

U

USB cable 80, 81, 85, 92
 USB connector 4

V

Vibration reduction (VR) 20
 Video cable 92
 Video connector 4
 Video mode 123
 Viewfinder 7, 159
 eyepiece 5, 26
 eyepiece accessories 155
 ViewNX 80

W

Warm filter 135
 Warm-white fl. 103
 Warning indicator 7, 13, 172
 White balance 52, 103
 cloudy 52
 direct sunlight 52
 fine-tuning 104
 flash 52
 fluorescent 52
 incandescent 52
 mode 9
 preset manual 52
 shade 52
 White fluorescent 103
 World time 21
 Write protect switch 25

Z

Zoom
 ring 30



A series of horizontal dashed lines for handwriting practice, spanning the width of the page.

Nikon

No reproduction in any form of this manual, in whole or in part (except for brief quotation in critical articles or reviews), may be made without written authorization from NIKON CORPORATION.

NIKON CORPORATION

Fuji Bldg., 2-3 Marunouchi 3-chome,
Chiyoda-ku, Tokyo 100-8331, Japan



Printed in Europe
YP8A01(11)
6MB01411-01

Free Manuals Download Website

<http://myh66.com>

<http://usermanuals.us>

<http://www.somanuals.com>

<http://www.4manuals.cc>

<http://www.manual-lib.com>

<http://www.404manual.com>

<http://www.luxmanual.com>

<http://aubethermostatmanual.com>

Golf course search by state

<http://golfingnear.com>

Email search by domain

<http://emailbydomain.com>

Auto manuals search

<http://auto.somanuals.com>

TV manuals search

<http://tv.somanuals.com>