

Nikon

DIGITAL CAMERA

1 J2

User's Manual



1

En

Download from [Www.Somanuals.com](http://www.somanuals.com). All Manuals Search And Download.

Table of Contents

For Your Safety.....	4
Notices.....	7
Introduction	12
Package Contents.....	12
Parts of the Camera.....	13
First Steps.....	16
Auto Photo Mode	20
Taking Photos in Auto Photo Mode.....	20
Viewing Photographs.....	24
Deleting Pictures	25
Creative Mode.....	26
Choosing a Creative Mode.....	26
Choosing a Scene	27
Smart Photo Selector Mode	32
Taking Photos in Smart Photo Selector Mode	32
Viewing Photographs.....	34
Movie Mode	36
HD Movies.....	36
Slow Motion.....	40
Viewing Movies.....	42
Motion Snapshot Mode.....	44
Shooting in Motion Snapshot Mode.....	44
Viewing Motion Snapshots.....	47
Available Settings	48
More on Photography	52
Self-Timer and Remote Control Modes.....	52
The Built-in Flash	55
Using the Menus	58

Connecting to a Computer 63

Installing the Supplied Software..... 63

Viewing and Editing Pictures on a Computer..... 65

Technical Notes 68

Optional Accessories 68

Storage and Cleaning 71

Caring for the Camera and Battery: Cautions 72

Troubleshooting..... 76

Error Messages..... 79

Specifications..... 81

Index..... 90

Take pictures or movies in any of five modes.

Choose ①  **Motion Snapshot mode** (📖 44) to record both photographs and brief movie vignettes,

②  **Smart Photo Selector mode** (📖 32) to capture fleeting changes of expression and other hard-to-time shots,

③  **auto photo mode** (📖 20) to simplify photography by leaving the camera in charge of settings,

④  **creative mode** (📖 26) to use special effects, match settings to the scene, or shoot in exposure modes **P**, **S**, **A**, or **M**, or

⑤  **movie mode** (📖 36) to record high-definition or slow-motion movies.

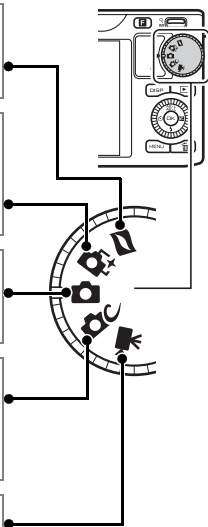

Thank you for your purchase of a Nikon digital camera. For a complete guide to using your digital camera, see the *Reference Manual* (on CD). To get the most from your camera, please be sure to read this *User's Manual* thoroughly and keep it where it will be read by all who use the product.

Camera Settings

The explanations in this manual assume that default settings are used.

Symbols and Conventions

To make it easier to find the information you need, the following symbols and conventions are used:



This icon marks cautions; information that should be read before use to prevent damage to the camera.



This icon marks notes; information that should be read before using the camera.



This icon marks references to other pages in this manual.

The lens generally used in this manual for illustrative purposes is a 1 NIKKOR VR 10–30mm f/3.5–5.6.

Digitutor

“Digitutor”, a series of “watch and learn” manuals in movie form, is available from the following website:

http://www.nikondigitutor.com/index_eng.html

For Your Safety

Before using the camera for the first time, read the safety instructions in “For Your Safety” (□ 4–6) and “Caring for the Camera and Battery: Cautions” (□ 72).

Product Documentation

The following documentation is supplied with the camera.

User's Manual (this manual)—Describes how to take and view pictures.

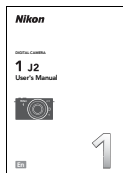

Reference Manual (on CD)—A complete guide to using your digital camera, included as a pdf file on the supplied Reference Manual CD-ROM.



The *Reference Manual* can be viewed using Adobe Reader or Adobe Acrobat Reader 5.0 or later, available for free download from the Adobe website.

- 1 Start the computer and insert the reference manual CD.
- 2 Double-click the CD (**Nikon 1 J2**) icon in Computer or My Computer (Windows) or on the desktop (Mac OS).
- 3 Double-click the **INDEX.pdf** icon to display a language selection screen and click a language to display the *Reference Manual*.

For Your Safety

To prevent damage to your Nikon product or injury to yourself or to others, read the following safety precautions in their entirety before using this equipment. Keep these safety instructions where all those who use the product will read them.

The consequences that could result from failure to observe the precautions listed in this section are indicated by the following symbol:



This icon marks warnings. To prevent possible injury, read all warnings before using this Nikon product.

■ WARNINGS

- ⚠ **Keep the sun out of the frame.** Keep the sun well out of the frame when shooting backlit subjects. Sunlight focused into the camera when the sun is in or close to the frame could cause a fire.
- ⚠ **Do not disassemble.** Touching the product's internal parts could result in injury. In the event of malfunction, the product should be repaired only by a qualified technician. Should the product break open as the result of a fall or other accident, remove the battery and/or AC adapter and then take the product to a Nikon-authorized service center for inspection.
- ⚠ **Turn off immediately in the event of malfunction.** Should you notice smoke or an unusual smell coming from the equipment or AC adapter (available separately), unplug the AC adapter and remove the battery immediately, taking care to avoid burns. Continued operation could result in injury. After removing the battery, take the equipment to a Nikon-authorized service center for inspection.
- ⚠ **Keep out of reach of children.** Failure to observe this precaution could result in injury. In addition, note that small parts constitute a choking hazard. Should a child swallow any part of this equipment, consult a physician immediately.
- ⚠ **Do not use in the presence of flammable gas.** Do not use electronic equipment in the presence of flammable gas, as this could result in explosion or fire.
- ⚠ **Do not place the strap around the neck of an infant or child.** Placing the camera strap around the neck of an infant or child could result in strangulation.

⚠ Do not remain in contact with the camera, battery, or charger for extended periods while the devices are on or in use. Parts of the device become hot. Leaving the device in direct contact with the skin for extended periods may result in low-temperature burns.

⚠ Do not aim the flash at the operator of a motor vehicle. Failure to observe this precaution could result in accidents.

⚠ Observe caution when using a flash.

- Using the camera with the flash in close contact with the skin or other objects could cause burns.
- Using a flash close to the subject's eyes could cause temporary visual impairment. Particular care should be observed when photographing infants, when the flash should be no less than one meter (39 in.) from the subject.

⚠ Avoid contact with liquid crystal. Should the displays break, care should be taken to avoid injury due to broken glass and to prevent the liquid crystal from the displays touching the skin or entering the eyes or mouth.

⚠ Observe proper precautions when handling batteries. Batteries may leak or explode if improperly handled. Observe the following precautions when handling batteries for use in this product:

- Use only batteries approved for use in this equipment.
- Do not short or disassemble the battery.
- Be sure the product is off before replacing the battery. If you are using an AC adapter, be sure it is unplugged.

- Do not attempt to insert the battery upside down or backwards.
- Do not expose the battery to flame or to excessive heat.
- Do not immerse in or expose to water.
- Replace the terminal cover when transporting the battery. Do not transport or store the battery with metal objects such as necklaces or hairpins.
- Batteries are prone to leakage when fully discharged. To avoid damage to the product, be sure to remove the battery when no charge remains.
- When the battery is not in use, attach the terminal cover and store in a cool, dry place.
- The battery may be hot immediately after use or when the product has been used on battery power for an extended period. Before removing the battery turn the camera off and allow the battery to cool.
- Discontinue use immediately should you notice any changes in the battery, such as discoloration or deformation.

⚠ Observe proper precautions when handling the charger:

- Keep dry. Failure to observe this precaution could result in fire or electric shock.
- Do not short the charger terminals. Failure to observe this precaution could result in overheating and damage to the charger.
- Dust on or near the metal parts of the plug should be removed with a dry cloth. Continued use could result in fire.
- Do not go near the charger during thunderstorms. Failure to observe this precaution could result in electric shock.
- Do not handle the plug or charger with wet hands. Failure to observe this precaution could result in electric shock.
- Do not use with travel converters or adapters designed to convert from one voltage to another or with DC-to-AC inverters. Failure to observe this precaution could damage the product or cause overheating or fire.

⚠ Use appropriate cables. When connecting cables to the input and output jacks, use only the cables provided or sold by Nikon for the purpose to maintain compliance with product regulations.

⚠ CD-ROMs: CD-ROMs containing software or manuals should not be played back on audio CD equipment. Playing CD-ROMs on an audio CD player could cause hearing loss or damage the equipment.

Notices

- No part of the manuals included with this product may be reproduced, transmitted, transcribed, stored in a retrieval system, or translated into any language in any form, by any means, without Nikon's prior written permission.
- Nikon reserves the right to change the specifications of the hardware and software described in these manuals at any time and without prior notice.
- Nikon will not be held liable for any damages resulting from the use of this product.
- While every effort has been made to ensure that the information in these manuals is accurate and complete, we would appreciate it were you to bring any errors or omissions to the attention of the Nikon representative in your area (address provided separately).

Notice for Customers in Canada

CAUTION

This Class B digital apparatus complies with Canadian ICES-003.

ATTENTION

Cet appareil numérique de la classe B est conforme à la norme NMB-003 du Canada.

Notice for Customers in Europe

CAUTION: RISK OF EXPLOSION IF BATTERY IS REPLACED BY AN INCORRECT TYPE. DISPOSE OF USED BATTERIES ACCORDING TO THE INSTRUCTIONS.

This symbol indicates that this product is to be collected separately.



The following apply only to users in European countries:

- This product is designated for separate collection at an appropriate collection point. Do not dispose of as household waste.
- For more information, contact the retailer or the local authorities in charge of waste management.

This symbol on the battery indicates that the battery is to be collected separately.



The following apply only to users in European countries:

- All batteries, whether marked with this symbol or not, are designated for separate collection at an appropriate collection point. Do not dispose of as household waste.
- For more information, contact the retailer or the local authorities in charge of waste management.

Notice for Customers in the U.S.A.

The Battery Charger

IMPORTANT SAFETY INSTRUCTIONS—SAVE THESE INSTRUCTIONS

DANGER—TO REDUCE THE RISK OF FIRE OR ELECTRIC SHOCK, CAREFULLY FOLLOW THESE INSTRUCTIONS

For connection to a supply not in the U.S.A., use an attachment plug adapter of the proper configuration for the power outlet if needed. This power unit is intended to be correctly oriented in a vertical or floor mount position.

Federal Communications Commission (FCC) Radio Frequency Interference Statement

This equipment has been tested and found to comply with the limits for a Class B digital device, pursuant to Part 15 of the FCC rules. These limits are designed to provide reasonable protection against harmful interference in a residential installation. This equipment generates, uses, and can radiate radio frequency energy and, if not installed and used in accordance with the instructions, may cause harmful interference to radio communications. However, there is no guarantee that interference will not occur in a particular installation. If this equipment does cause harmful interference to radio or television reception, which can be determined by turning the equipment off and on, the user is encouraged to try to correct the interference by one or more of the following measures:

- Reorient or relocate the receiving antenna.
- Increase the separation between the equipment and receiver.
- Connect the equipment into an outlet on a circuit different from that to which the receiver is connected.
- Consult the dealer or an experienced radio/television technician for help.



Nikon

1 J2

CAUTIONS

Modifications

The FCC requires the user be notified that any changes or modifications made to this device that are not expressly approved by Nikon Corporation may void the user's authority to operate the equipment.

Interface Cables

Use the interface cables sold or provided by Nikon for your equipment. Using other interface cables may exceed the limits of Class B Part 15 of the FCC rules.

Notice for Customers in the State of California

WARNING: Handling the cord on this product may expose you to lead, a chemical known to the State of California to cause birth defects or other reproductive harm. *Wash hands after handling.*

Nikon Inc., 1300 Walt Whitman Road, Melville, New York 11747-3064, U.S.A.
Tel.: 631-547-4200

Notice Concerning Prohibition of Copying or Reproduction

Note that simply being in possession of material that has been digitally copied or reproduced by means of a scanner, digital camera, or other device may be punishable by law.

• Items prohibited by law from being copied or reproduced

Do not copy or reproduce paper money, coins, securities, government bonds, or local government bonds, even if such copies or reproductions are stamped "Sample."

The copying or reproduction of paper money, coins, or securities which are circulated in a foreign country is prohibited.

Unless the prior permission of the government has been obtained, the copying or reproduction of unused postage stamps or post cards issued by the government is prohibited.

The copying or reproduction of stamps issued by the government and of certified documents stipulated by law is prohibited.

• Cautions on certain copies and reproductions

The government has issued cautions on copies or reproductions of securities issued by private companies (shares, bills, checks, gift certificates, etc.), commuter passes, or coupon tickets, except when a minimum of necessary copies are to be provided for business use by a company. Also, do not copy or reproduce passports issued by the government, licenses issued by public agencies and private groups, ID cards, and tickets, such as passes and meal coupons.

• Comply with copyright notices

The copying or reproduction of copyrighted creative works such as books, music, paintings, woodcuts, prints, maps, drawings, movies, and photographs is governed by national and international copyright laws. Do not use this product for the purpose of making illegal copies or to infringe copyright laws.

Disposing of Data Storage Devices

Please note that deleting images or formatting memory cards or other data storage devices does not completely erase the original image data. Deleted files can sometimes be recovered from discarded storage devices using commercially available software, potentially resulting in the malicious use of personal image data. Ensuring the privacy of such data is the user's responsibility.

Before discarding a data storage device or transferring ownership to another person, erase all data using commercial deletion software, or format the device and then completely refill it with images containing no private information (for example, pictures of empty sky). Care should be taken to avoid injury when physically destroying data storage devices.

AVC Patent Portfolio License

THIS PRODUCT IS LICENSED UNDER THE AVC PATENT PORTFOLIO LICENSE FOR THE PERSONAL AND NON-COMMERCIAL USE OF A CONSUMER TO (i) ENCODE VIDEO IN COMPLIANCE WITH THE AVC STANDARD ("AVC VIDEO") AND/OR (ii) DECODE AVC VIDEO THAT WAS ENCODED BY A CONSUMER ENGAGED IN A PERSONAL AND NON-COMMERCIAL ACTIVITY AND/OR WAS OBTAINED FROM A VIDEO PROVIDER LICENSED TO PROVIDE AVC VIDEO. NO LICENSE IS GRANTED OR SHALL BE IMPLIED FOR ANY OTHER USE. ADDITIONAL INFORMATION MAY BE OBTAINED FROM MPEG LA, L.L.C. SEE <http://www.mpegla.com>

Temperature Warnings

The camera may become warm to the touch during use; this is normal and does not indicate a malfunction. At high ambient temperatures, after extended periods of continuous use, or after several photographs have been taken in quick succession, a temperature warning may be displayed, following which the camera will turn off automatically to minimize damage to its internal circuits. Wait for the camera to cool before resuming use.

Use Only Nikon Brand Electronic Accessories

Nikon cameras are designed to the highest standards and include complex electronic circuitry. Only Nikon brand electronic accessories (including chargers, batteries, AC adapters, and flash accessories) certified by Nikon specifically for use with this Nikon digital camera are engineered and proven to operate within the operational and safety requirements of this electronic circuitry.

The use of non-Nikon electronic accessories could damage the camera and may void your Nikon warranty. The use of third-party rechargeable Li-ion batteries not bearing the Nikon holographic seal shown at right could interfere with normal operation of the camera or result in the batteries overheating, igniting, rupturing, or leaking.

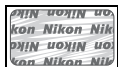

For more information about Nikon brand accessories, contact a local authorized Nikon dealer.

Use Only Nikon Brand Accessories

Only Nikon brand accessories certified by Nikon specifically for use with your Nikon digital camera are engineered and proven to operate within its operational and safety requirements. THE USE OF NON-NIKON ACCESSORIES COULD DAMAGE YOUR CAMERA AND MAY VOID YOUR NIKON WARRANTY.

Servicing the Camera and Accessories

The camera is a precision device and requires regular servicing. Nikon recommends that the camera be inspected by the original retailer or a Nikon-authorized service representative once every one to two years, and that it be serviced once every three to five years (note that fees apply to these services). Frequent inspection and servicing are particularly recommended if the camera is used professionally. Any accessories regularly used with the camera, such as lenses, should be included when the camera is inspected or serviced.

Before Taking Important Pictures

Before taking pictures on important occasions (such as at weddings or before taking the camera on a trip), take a test shot to ensure that the camera is functioning normally. Nikon will not be held liable for damages or lost profits that may result from product malfunction.

Life-Long Learning

As part of Nikon's "Life-Long Learning" commitment to ongoing product support and education, continually-updated information is available on-line at the following sites:

- **For users in the U.S.A.:** <http://www.nikonusa.com/>
- **For users in Europe and Africa:** <http://www.europe-nikon.com/support/>
- **For users in Asia, Oceania, and the Middle East:** <http://www.nikon-asia.com/>

Visit these sites to keep up-to-date with the latest product information, tips, answers to frequently-asked questions (FAQs), and general advice on digital imaging and photography. Additional information may be available from the Nikon representative in your area. For contact information, visit <http://imaging.nikon.com/>

Introduction

Package Contents

Confirm that the package contains the following items.



Nikon 1 J2 digital camera



BF-N1000 body cap

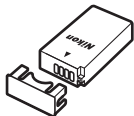

EN-EL20
rechargeable
Li-ion battery
(with terminal cover)



MH-27 battery
charger (AC wall
adapter or power cable
supplied in countries or
regions where required;
shape depends on
country of sale)

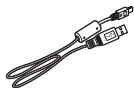

UC-E15
USB cable



Lens (supplied only if
lens kit is purchased with
camera; comes with front
and rear lens caps)

AN-N1000 strap

ViewNX 2/Short
Movie Creator CD

Warranty

User's Manual
(this manual)

Reference manual
CD (contains the
Reference Manual)

Memory cards are sold separately.

Parts of the Camera

Take a few moments to familiarize yourself with camera controls and displays. You may find it helpful to bookmark this section and refer to it as you read through the rest of the manual.



The Camera Body

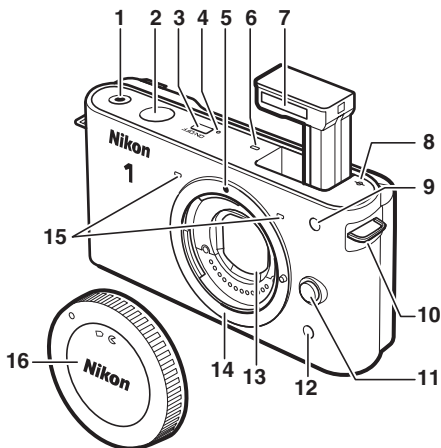

1 Movie-record button	37, 41	10 Eyelet for camera strap	16
2 Shutter-release button...	21, 33, 38, 45	11 Lens release button	
3 Power switch.....	18	12 Infrared receiver.....	53, 77
4 Power lamp	18	13 Dust shield	71
5 Mounting mark	18	14 Lens mount	18
6 Speaker		15 Microphone	
7 Built-in flash	55	16 Body cap	12
8 Focal plane mark (☉)			
9 AF-assist illuminator			
Self-timer lamp	53		
Red-eye reduction lamp	55		

The Camera Body (Continued)

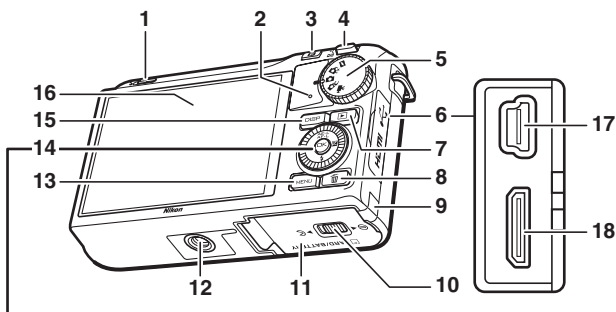

Press the multi selector up, down, left, or right (▲, ▼, ◀, or ▶), or rotate it as shown at right.



1 Flash pop-up control	55	12 Tripod socket	
2 Memory card access lamp	22	13 MENU (menu) button.....	58
3 F (feature) button	26, 39, 46	14 Multi selector.....	59
4 z (playback zoom/thumbnail) control	24, 42, 46	OK (OK) button	59
5 Mode dial.....	1	AE-L (AE-L/AF-L)	
6 Connector cover		☒ (exposure compensation)	
7 ▶ (playback) button	24, 34, 47	⚡ (flash mode).....	56
8 ⌫ (delete) button.....	25, 35, 43, 47	⌚ (self-timer).....	52
9 Power connector cover for optional power connector		15 DISP (display) button.....	19, 46
10 Battery-chamber/memory card slot cover latch.....	17	16 Monitor	15
11 Battery-chamber/ memory card slot cover	17	17 USB connector.....	65
		18 HDMI mini-pin connector	

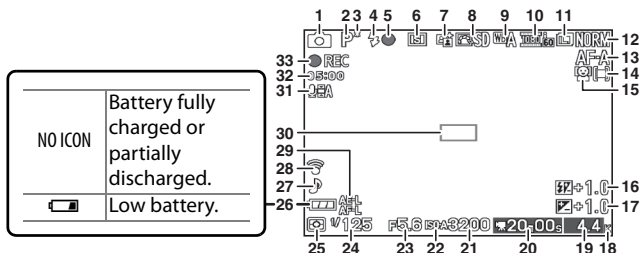

1 Shooting mode	1	19 Number of exposures remaining	
2 Exposure mode	29, 60	Number of shots remaining	
Scene	23, 27	before memory buffer fills	
3 Flexible program indicator		White balance recording indicator	
4 Flash mode	55	Card warning indicator	
5 Flash-ready indicator	55	20 Time available.....	37, 41
6 Self-timer/ remote control mode	52	21 ISO sensitivity *	61
Continuous mode *	60	22 ISO sensitivity indicator *	61
7 Active D-Lighting *	61	Auto ISO sensitivity indicator *	
8 Picture Control *	61	23 Aperture	
9 White balance *	61	24 Shutter speed	
10 Movie settings (HD movies) *	61	25 Metering *	61
Frame rate		26 Battery indicator *	
(slow motion movies) *	60	27 Sound settings *	62
11 Image size *	60	28 Eye-Fi indicator *	
12 Image quality *	60	29 Autoexposure (AE)/autofocus (AF)	
13 Focus mode *	61	lock indicator	
14 AF-area mode *	61	30 Focus area.....	21
15 Face-priority AF *	23	31 Microphone sensitivity *	61
16 Flash compensation	61	32 Time elapsed.....	37, 41
17 Exposure compensation		33 Recording indicator.....	37, 41
18 "K" (appears when memory remains		HDR indicator	30
for over 1000 exposures)			

* Available only in detailed display.

First Steps

1 Attach the camera strap.

Attach the strap securely to the two camera eyelets.

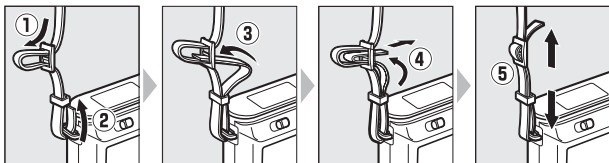

2 Charge the battery.

Insert the battery ① and plug the charger in ②. An exhausted battery fully charges in about two hours. Unplug the charger and remove the battery when charging is complete.

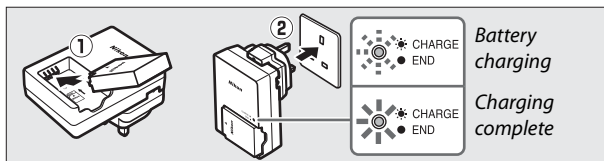

The Plug Adapter

Depending on the country or region of purchase, a plug adapter may be supplied with the charger. The shape of the adapter varies with the country or region of purchase. If a plug adapter is supplied, raise the wall plug and connect the plug adapter as shown at right, making sure the plug is fully inserted. Attempting to forcibly remove the plug adapter could damage the product.

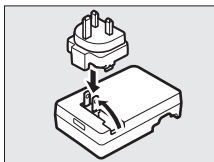

3 Insert the battery and a memory card.

Check to be sure the battery and card are in the correct orientation. Using the battery to keep the orange battery latch pressed to one side, slide the battery in until it latches, and then slide in the memory card until it clicks into place.

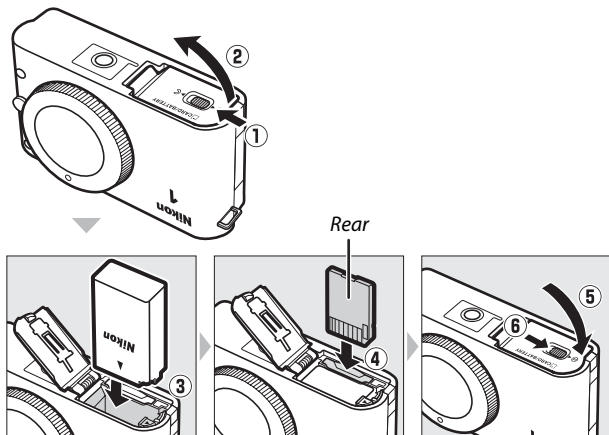

Formatting Memory Cards

If this is the first time the memory card will be used in the camera or if the card has been formatted in another device, select **Format memory card** in the setup menu and follow the on-screen instructions to format the card (▢ 62). *Note that this permanently deletes any data the card may contain.* Be sure to copy any photographs and other data you wish to keep to a computer before proceeding.

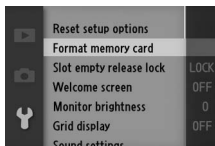

4 Attach a lens.

Be careful to prevent dust from entering the camera when the lens or body cap is removed.

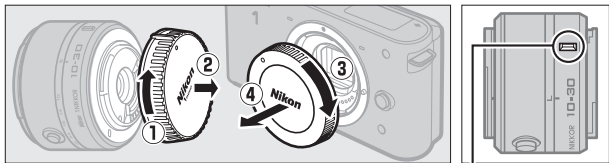

Mounting mark (lens)

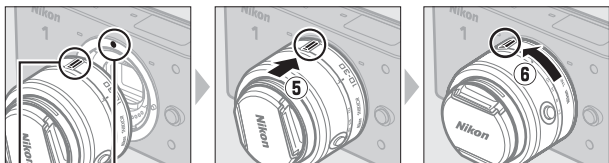

Mounting mark (camera)

Mounting mark (lens)

Keeping marks aligned, position lens on camera, then rotate until it clicks into place.

5 Turn the camera on.

Press the power switch to turn the camera on. The power lamp will briefly light green and the monitor will turn on. Be sure to remove the lens cap before shooting.

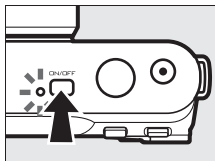

Turning the Camera Off

To turn the camera off, press the power switch again. The monitor will turn off.

Check the battery level and number of exposures remaining in the monitor (15).

Battery level

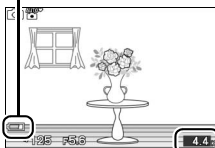

Exposures remaining

■ Choosing a Language and Setting the Camera Clock

A language-selection dialog will be displayed the first time the camera is turned on. Use the multi selector to choose a language, time zone, and date format, turn daylight saving time on or off, and set the camera's 24-hour clock, pressing **OK** after each step to proceed to the next dialog.



The DISP (Display) Button

Press DISP to cycle through shooting or playback indicators.

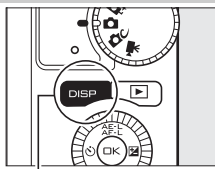

DISP button

■ The Framing Grid

A framing grid can be displayed by selecting **On** for **Grid display** in the setup menu (62).

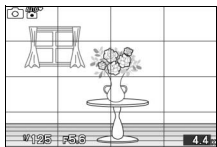

Auto Photo Mode

Auto photo mode is the mode generally used for taking photos.

Taking Photos in Auto Photo Mode

- 1 Select auto photo mode.
Rotate the mode dial to .

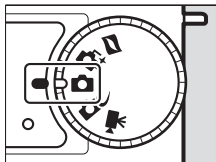

- 2 Ready the camera.

Hold the camera securely with both hands, being careful not to obstruct the lens, AF-assist illuminator, or microphone. Rotate the camera as shown at lower right when taking pictures in "tall" (portrait) orientation.

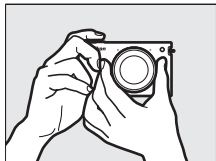

Shutter speeds slow when lighting is poor; use of the built-in flash ( 55) or a tripod is recommended.

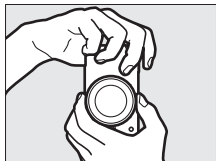

Available Settings

For information on the options available in auto photo mode, see page 48.

Movie Recording

In auto photo mode, movies can not be recorded and pressing the movie-record button has no effect.

3 Frame the photograph.

Position your subject in the center of the frame.

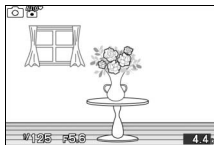

4 Focus.

Press the shutter-release button half-way to focus. If the subject is poorly lit, the AF-assist illuminator (📖 13) may light to assist the focus operation.



If the camera is able to focus, the selected focus area will be highlighted in green and a beep will sound (a beep may not sound if the subject is moving).

Focus area

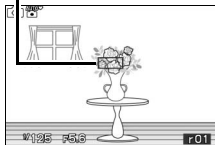

If the camera is unable to focus, the focus area will be displayed in red.

Using a Zoom Lens

Use the zoom ring to zoom in on the subject so that it fills a larger area of the frame, or zoom out to increase the area visible in the final photograph (select longer focal lengths on the lens focal length scale to zoom in, shorter focal lengths to zoom out).

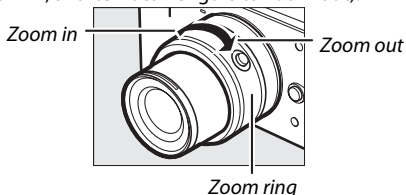

5 Shoot.

Smoothly press the shutter-release button the rest of the way down to release the shutter and record the photograph. The memory card access lamp will light and the photograph will be displayed in the monitor for a few seconds (the photo will automatically clear from the display and the camera will be ready to shoot when the shutter-release button is pressed halfway). *Do not eject the memory card or remove or disconnect the power source until the lamp has gone out and recording is complete.*

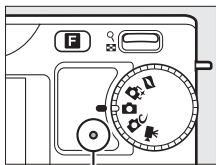

Memory card access lamp

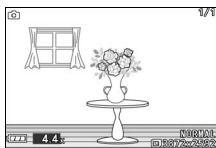

Lenses with Retractable Lens Barrel Buttons

Lenses with retractable lens barrel buttons can not be used when retracted. To unlock and extend the lens, keep the retractable lens barrel button pressed (①) while rotating the zoom ring (②). The camera will turn on automatically when the retractable lens barrel lock is released.

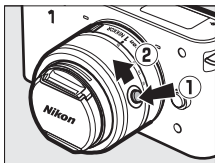

The lens can be retracted and the zoom ring locked by pressing the retractable lens barrel button and rotating the ring in the opposite direction. If the view through the lens is displayed or the monitor is off, the camera will turn off automatically when the lens barrel is locked (in the case of 1 NIKKOR VR 10–30mm f/3.5–5.6 and 1 NIKKOR VR 30–110mm f/3.8–5.6 lenses, firmware version 1.10 or later is required if locking the lens barrel is to turn the camera off when the monitor is off; for information on updating lens firmware, visit the Nikon website for your area). Be careful not to press the retractable lens barrel button while attaching or removing the lens. Retract the lens before removal.

Face-Priority AF

The camera detects and focuses on portrait subjects (face-priority AF). A double yellow border will be displayed if a portrait subject is detected facing the camera (if multiple faces, up to a maximum of five, are detected, the camera will select the closest subject). Press the shutter-release button halfway to focus on the subject in the double yellow border. The border will clear from the display if the camera can no longer detect the subject (because, for example, the subject has looked away).





Automatic Scene Selection

In auto photo mode, the camera automatically analyzes the subject and selects the appropriate scene. The selected scene is shown by an icon in the display.

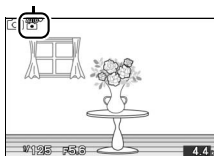
Scene icon



 **Portrait:** Human portrait subjects.

 **Landscape:** Landscapes and cityscapes.

 **Night portrait:** Portrait subjects framed against dark backgrounds.

 **Close up:** Subjects close to the camera.

 **Auto:** Subjects that do not fall into the categories listed above.

Auto Power Off

If no operations are performed for about 30 seconds, the displays will turn off and the power lamp start to flash (□ 18). The camera can be reactivated by operating the buttons, mode dial, or other camera controls. If no operations are performed for about three minutes after the displays have turned off, the camera will turn off automatically.

See Also

See page 62 for information on silencing the beep that sounds when the camera focuses or the shutter is released.



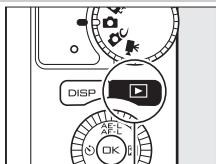

Viewing Photographs

Press  to display your most recent photograph full frame in the monitor (full-frame playback).



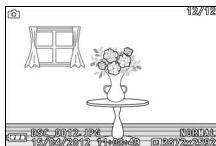

 button

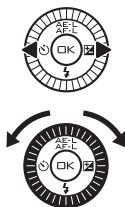

Press  or  or rotate the multi selector to view additional pictures.



To zoom in on the center of the current image, press the  control up. Press  down to zoom out. To view multiple images, press  down when the picture is displayed full frame.

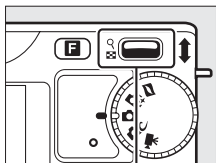

 control

To end playback and return to shooting mode, press the shutter-release button halfway.

See Also

See page 60 for slide show options.

Deleting Pictures

To delete the current picture, press . *Note that once deleted, pictures can not be recovered.*

1 Display the photograph.

Display the photograph you wish to delete as described on the preceding page.

2 Press .

A confirmation dialog will be displayed.

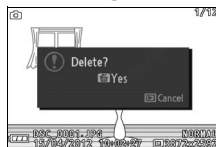
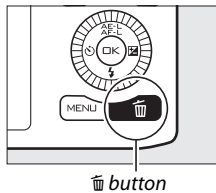

3 Delete the photograph.

Press again to delete the picture and return to playback, or press to exit without deleting the picture.

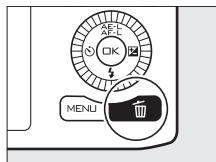

Deleting Multiple Pictures

The **Delete** option in the playback menu (60) can be used to delete selected pictures, all pictures, pictures taken on selected dates, or pictures previously selected as candidates for deletion.



Creative Mode

Choose creative mode when to take photos using special effects, match settings to the scene, or shoot in exposure modes **P**, **S**, **A**, or **M**.

Choosing a Creative Mode

1 Select creative mode.

Rotate the mode dial to .

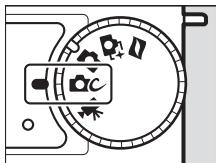

2 Choose a scene.

Press the **F** button and highlight a scene using the multi selector ( 27).

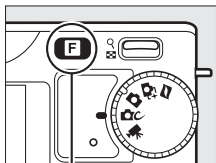

F button



Press  to select the highlighted scene. Your selection is indicated by an icon in the display.

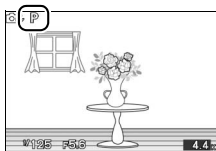

Choosing a Scene

Creative mode offers a choice of the following scenes:

Option	Description
P, S, A, M	Control the full range of camera settings and choose how the camera sets shutter speed and aperture (□ 29).
Night landscape (🌃)	Each time the shutter-release button is fully pressed, the camera takes a series of shots and combines them to capture low lighting in night scenes; during processing, a message is displayed and no pictures can be taken. The flash does not fire and the edges of photos are cropped out. Note that the desired results may not be obtained if the camera or subject moves during shooting; if the camera is unable to combine the images, a warning will be displayed and only one picture will be taken.
Night portrait (👤)	Each time the shutter-release button is fully pressed, the camera takes a series of shots, some with the flash and some without, and combines them to capture background lighting in portraits taken at night or under low light; during processing, a message is displayed and no pictures can be taken. Raise the built-in flash before shooting; no photograph will be taken if the flash is not raised. Note that the edges of photos are cropped out and that the desired results may not be obtained if the camera or subject moves during shooting; if the camera is unable to combine the images, a warning will be displayed and the camera will take a single picture using the flash.
Backlighting (🌅)	Photograph backlit subjects (□ 30).
Easy panorama (📷)	Shoot panoramas for later viewing on the camera (□ 31).

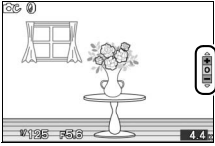
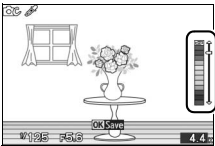

Option	Description
Soft (Q)	Shoot photographs with a soft filter effect. To choose the amount of softening, press OK when the view through the lens is displayed, highlight an option using the multi selector, and press OK to select. 
Miniature effect (M)	The top and bottom of each photo is blurred so that the subject appears to have been a diorama photographed at short range. Works best when shooting from a high vantage point.
Selective color (S)	Take photos in which only the hue chosen with the multi selector and OK button appears in color. 

Note that movies can not be recorded in creative mode and that pressing the movie-record button has no effect.

Available Settings

For information on the options available in creative mode, see page 50.

P, S, A, M

P, S, A, M mode lets you choose the exposure mode, which controls how the camera sets shutter speed and aperture.

■ ■ Exposure Mode

To choose the exposure mode, press the MENU button, highlight **Exposure mode** (📖 60) in the shooting menu, and press ► to display the options below, then highlight an option and press .

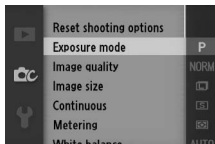

P Programmed auto	The camera sets shutter speed and aperture for optimal exposure. Recommended for snapshots and in other situations in which there is little time to adjust camera settings.
S Shutter-priority auto	You choose the shutter speed; the camera selects an aperture for best results. Use to freeze or blur motion.
A Aperture-priority auto	You choose the aperture; the camera selects a shutter speed for best results. Use to blur the background or bring both foreground and background into focus.
M Manual	You control both shutter speed and aperture.

Backlighting

The method used to capture details in shaded areas of back-lit subjects depends on the option selected for **HDR** in the shooting menu (📖 61).



On

Details in highlights and shadows are preserved using HDR (high dynamic range); **HDR** appears in the display. Each time the shutter-release button is fully pressed, the camera takes two shots in quick succession and combines them to preserve details in highlights and shadows in high-contrast scenes; the built-in flash does not fire. While the shots are combined, a message will be displayed and the shutter release will be disabled. The final photograph will be displayed when processing is complete.



*First exposure
(darker)*

+



*Second exposure
(brighter)*



*Combined HDR
image*

Off

The flash fires to “fill in” (illuminate) shadows in back-lit subjects. Only one shot is taken when the shutter-release button is fully pressed, and the flash fires with each shot. No pictures will be taken if the built-in flash is not raised; raise the flash before shooting.

Framing HDR Photographs

The edges of the image will be cropped out. The desired results may not be achieved if the camera or subject moves during shooting. Depending on the scene, shading may be uneven and shadows may appear around bright objects or halos around dark objects. If the camera is unable to successfully combine the two images, a single image will be recorded at normal exposure and Active D-Lighting will be applied.

Easy Panorama



Follow the steps below to shoot panoramas.

1 Set focus and exposure.

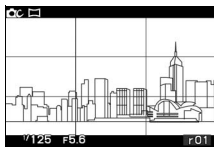
Frame the start of the panorama and press the shutter-release button halfway. Guides will appear in the display. 



2 Start shooting.

Press the shutter-release button the rest of the way down and then lift your finger from the button. \triangle , ∇ , \triangleleft , and \triangleright icons will appear in the display to indicate the possible pan directions. 



3 Pan the camera.

Slowly pan the camera up, down, left, or right as shown. Shooting will start when the camera detects the pan direction and a progress indicator will appear in the display. Shooting ends automatically when the end of the panorama is reached.

Progress indicator

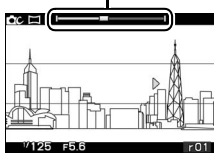

Without changing your position, pan the camera in a steady curve either horizontally or vertically.

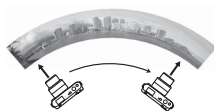

Viewing Panoramas

Panoramas can be viewed by pressing \odot when a panorama is displayed full frame. The camera will scroll through the picture in the original pan direction.

Smart Photo Selector Mode

Choose Smart Photo Selector mode for photos that capture a fleeting expression on the face of a portrait subject or other hard-to-time shots such as group photos in party scenes. Each time the shutter is released, the camera automatically selects the best shot and four best shot candidates based on composition and motion.

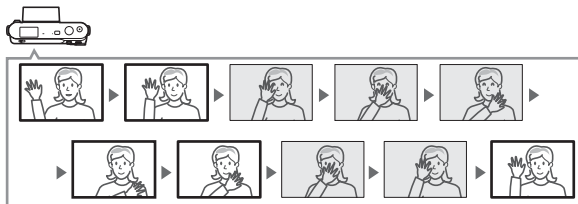

Taking Photos in Smart Photo Selector Mode

1 Select Smart Photo Selector mode.

Rotate the mode dial to .

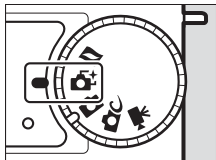

Available Settings

For information on the options available in Smart Photo Selector mode, see page 48.

2 Frame the photograph.

Compose the photograph with your subject in the center of the frame.



3 Begin buffering photographs.

Press the shutter-release button half-way to focus (📖 21). An icon will be displayed as the camera begins recording images to the memory buffer. The camera continuously adjusts focus to account for changes in the distance to the subject in the AF area brackets while the shutter-release button is pressed halfway.

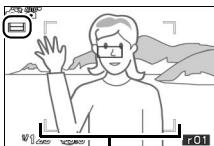

AF area brackets

4 Shoot.



Smoothly press the shutter-release button the rest of the way down. The camera will compare shots recorded to the buffer both before and after the shutter-release button was pressed, and select five to copy to the memory card. Note that some time may be required. The best picture is displayed in the monitor for a few seconds when recording is complete.



Smart Photo Selector Mode

The camera automatically chooses a scene mode appropriate to the subject. Movies can not be recorded, and pressing the movie-record button has no effect. The flash can not be used.

Viewing Photographs



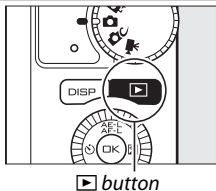

Press  and use the multi selector to display photographs taken with the Smart Photo Selector (book icon 24; pictures taken with the Smart Photo Selector are indicated by a  icon). Of the five photographs recorded by the Smart Photo Selector, only the best shot will be displayed (when you press the multi selector right to view the next picture, the camera will skip over the best shot candidates, with the result that the next picture displayed will not have a file number that immediately follows that of the current picture). To end playback and return to shooting mode, press the shutter-release button halfway.



 button





Choosing the Best Shot

When a photograph taken with the Smart Photo Selector is displayed, you can choose the best shot by pressing . Press  or  to view the other pictures in the sequence and press  to select the current picture as the best shot. To return to normal playback, press .



Deleting Pictures

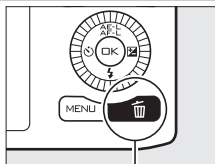

Pressing  when a picture taken with the Smart Photo Selector is selected displays a confirmation dialog; press  again to delete the best shot and the four best shot candidates, or press  to exit without deleting the pictures. *Note that once deleted, pictures can not be recovered.*

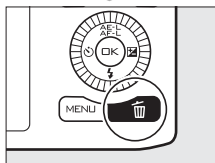
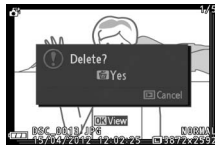

 button



Deleting Individual Photographs

Pressing the  button in the best shot selection dialog displays the following options; highlight an option using the multi selector and press  to select.

- **This image:** Delete the current photo (note that the picture currently selected as the best shot can not be deleted).
- **All except best shot:** Delete all photos in the sequence except the one currently selected as the best shot.

A confirmation dialog will be displayed; to delete the selected image or images, highlight **Yes** and press .



Movie Mode

Choose movie mode to shoot high-definition (HD) or slow-motion (40) movies using the movie-record button.

HD Movies

Record movies with sound at an aspect ratio of 16 : 9.

1 Select movie mode.

Rotate the mode dial to . An HD movie crop with an aspect ratio of 16 : 9 will appear in the display.

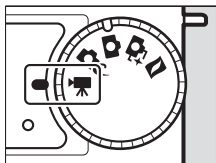

2 Frame the opening shot.

Frame the opening shot with your subject in the center of the display.

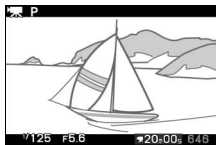

See Also

See page 61 for fade in/fade out and frame size and rate options.

The Icon

A  icon indicates that movies can not be recorded.

Available Settings

For information on the options available in movie mode, see page 48.

3 Start recording.

Press the movie-record button to begin recording. A recording indicator, the time elapsed, and the time available are displayed while recording is in progress.

Audio Recording

Be careful not to cover the microphone and note that the built-in microphone may record sounds made by the camera or lens. By default, the camera focuses continuously. The **Movie sound options** item in the shooting menu offers sensitivity and wind noise options for the built-in microphone (☞ 61).

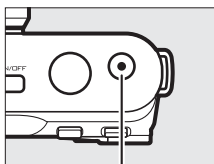

Movie-record button

*Recording indicator/
Time elapsed*

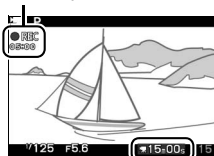

Time available

4 End recording.

Press the movie-record button again to end recording. Recording will end automatically when the maximum length is reached, the memory card is full, another mode is selected, the lens is removed, or the camera becomes hot (☞ 10).

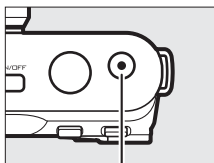

Movie-record button

Maximum Length

HD movies can be up to 4 GB in size and 20 minutes in length; note that depending on memory card write speed, shooting may end before this length is reached (☞ 70).

Exposure Lock

Exposure will lock while the AE-L/AF-ON (multi selector up) button is pressed.

■ Taking Photographs During HD Movie Recording

Press the shutter-release button all the way down to take a photograph without interrupting HD movie recording. Photographs taken during movie recording have an aspect ratio of 16 : 9.

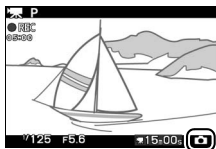

■ Taking Photographs During Movie Recording

Up to 15 photographs can be taken with each movie shot. Please note that photographs can not be taken with slow-motion movies.



■ Choosing the Movie Type

To choose between high definition and slow motion recording, press **F** and use the multi selector and **OK** button to choose from the following options:

- **HD movie:** Record movies in HD.
- **Slow motion:** Record slow-motion movies (☞ 40).

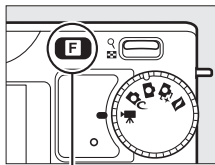

F button

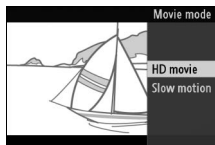

☑ Recording Movies

Flicker, banding, or distortion may be visible in the displays and in the final movie under fluorescent, mercury vapor, or sodium lamps or if the camera is panned horizontally or an object moves at high speed through frame (flicker and banding can be reduced in HD movies by choosing a **Flicker reduction** option that matches the frequency of the local AC power supply, but note that the slowest shutter speed available is $\frac{1}{100}$ at **50 Hz**, $\frac{1}{60}$ at **60 Hz**; ☞ 62). Bright light sources may leave after-images when the camera is panned. Jagged edges, color fringing, moiré, and bright spots may also appear. When recording movies, avoid pointing the camera at the sun or other strong light sources. Failure to observe this precaution could result in damage to the camera's internal circuitry.

Slow Motion

Record silent movies with an aspect ratio of 8 : 3. Movies are recorded at 400 fps and play back at 30 fps.

1 Select movie mode.

Rotate the mode dial to .

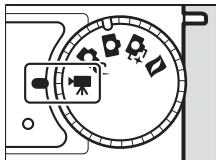

2 Select slow-motion mode.

Press the **F** button and use the multi selector and **OK** button to select **Slow motion**. A slow-motion movie crop with an aspect ratio of 8 : 3 will appear in the display.

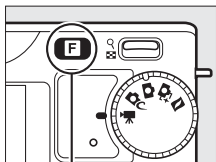

F button

3 Frame the opening shot.

Frame the opening shot with your subject in the center of the display.

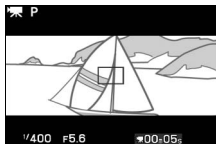

4 Start recording.

Press the movie-record button to begin recording. A recording indicator, the time elapsed, and the time available are displayed while recording is in progress. The camera focuses on the subject at the center of the display; face detection (📖 23) is not available.

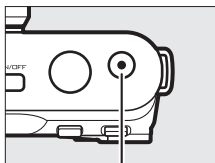

Movie-record button

*Recording indicator/
Time elapsed*

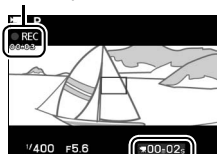

Time available

5 End recording.

Press the movie-record button again to end recording. Recording will end automatically when the maximum length is reached, the memory card is full, another mode is selected, the lens is removed, or the camera becomes hot (📖 10).

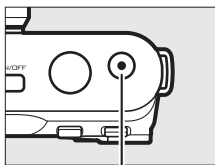

Movie-record button



Maximum Length

Up to 5 seconds or 4 GB of footage can be recorded; note that depending on memory card write speed, shooting may end before this length is reached (📖 70).

See Also

See page 60 for frame rate options.

Viewing Movies

Movies are indicated by a  icon in full-frame playback ( 24). Press  to start playback.

 icon/Length

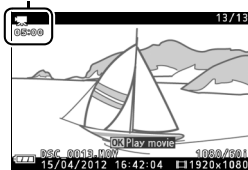













Movie playback indicator/
Current position/total length





Guide

Volume

The following operations can be performed:

To	Use	Description
Pause		Pause playback.
Play		Resume playback when the movie is paused or during rewind/advance.
Advance/ rewind	 / 	Press  to rewind,  to advance. Speed increases with each press, from 2x to 5x to 10x to 15x. If playback is paused, the movie rewinds or advances one frame at a time; keep the button pressed for continuous rewind or advance. You can also rotate the multi selector to rewind or advance when playback is paused.
Adjust volume	 	Press up to increase volume, down to decrease.
Return to full-frame playback	 / 	Press  or  to exit to full-frame playback.

Deleting Movies

To delete the current movie, press . A confirmation dialog will be displayed; press  again to delete the movie and return to playback, or press  to exit without deleting the movie. *Note that once deleted, movies can not be recovered.*

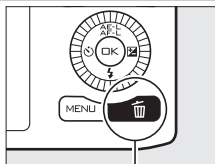

 button

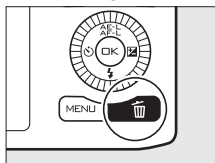

Motion Snapshot Mode

Choose Motion Snapshot mode to record brief movie vignettes with your photographs. Each time the shutter is released, the camera records a still image and about a second of movie footage. When the resulting "Motion Snapshot" is viewed on the camera, the movie will play back in slow motion over approximately 2.5 s, followed by the still image; playback is accompanied by a background track about 10 s long.

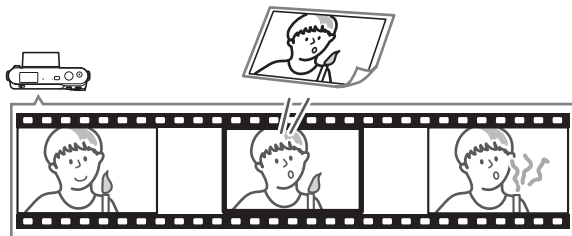

Shooting in Motion Snapshot Mode

1 Select Motion Snapshot mode.

Rotate the mode dial to .

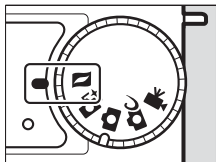

Available Settings

For information on the options available in Motion Snapshot mode, see page 48.

2 Frame the picture.

Compose the photograph with your subject in the center of the frame.



3 Begin buffering.

Press the shutter-release button half-way to focus (📖 21). An icon will be displayed as the camera begins recording footage to the memory buffer.



4 Shoot.

Smoothly press the shutter-release button the rest of the way down. The camera will record a photograph, together with about a second of movie footage beginning before and ending after the time the shutter-release button was pressed. Note that some time may be required. When recording is complete, the photograph will be displayed for a few seconds.



■ Choosing a Theme

To choose the background music for the movie, press **F** and use the multi selector and **OK** button to choose from **Beauty**, **Waves**, **Relaxation**, and **Tenderness**.

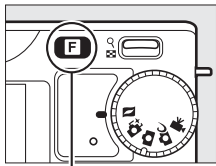

F button



To play the background music for the highlighted theme, press the **DISP** button and use the **Q** control to adjust volume.

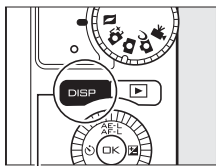





DISP button

Motion Snapshot Mode



Live audio is not recorded. Movies can not be recorded using the movie-record button and the flash can not be used.

Viewing Motion Snapshots

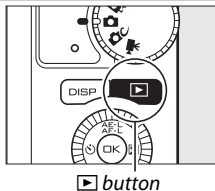
Press  and use the multi selector to display a Motion Snapshot ( 24; Motion Snapshots are indicated by a  icon). Pressing  when a Motion Snapshot is displayed plays back the movie portion in slow motion over a period of about 2.5 s, followed by the photo; the background track plays for about 10 s. To end playback and return to shooting mode, press the shutter-release button halfway.



Deleting Motion Snapshots

To delete the current Motion Snapshot, press . A confirmation dialog will be displayed; press  again to delete the photo and movie and return to playback, or press  to exit without deleting the file. *Note that once deleted, Motion Snapshots can not be recovered.*

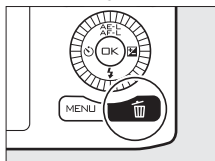
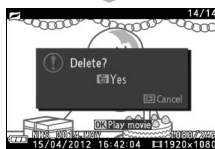
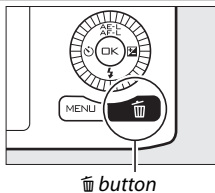

Available Settings

The following table lists the settings that can be adjusted in each mode.

Auto Photo,
 Smart Photo Selector,
 Movie, and
 Motion Snapshot Modes

			P	S	A	M	<small>SCENE</small>	P	S	A	M
Exposure mode ¹	—	—	✓	✓	✓	✓	✓	✓	✓	✓	✓
Image quality	✓	✓	—	—	—	—	—	—	—	—	—
Image size ²	✓	✓	—	—	—	—	—	—	—	—	—
Continuous	✓ ³	—	—	—	—	—	—	—	—	—	—
Frame rate	—	—	✓ ⁴	✓ ⁴	✓ ⁴	✓ ⁴	—	—	—	—	—
Movie settings	—	—	✓ ⁵	✓ ⁵	✓ ⁵	✓ ⁵	—	—	—	—	—
Metering	—	—	✓ ⁵	✓ ⁵	✓ ⁵	✓ ⁵	—	✓	✓	✓	✓
White balance	—	—	✓	✓	✓	✓	—	✓	✓	✓	✓
ISO sensitivity	—	—	✓	✓	✓	✓	—	✓	✓	✓	✓
Picture Control	—	—	✓	✓	✓	✓	—	✓	✓	✓	✓
Custom Picture Control	—	—	✓	✓	✓	✓	✓	✓	✓	✓	✓
Color space	—	✓	—	—	—	—	—	—	—	—	—
HDR	—	—	—	—	—	—	—	—	—	—	—
Active D-Lighting	—	—	—	—	—	—	—	—	—	—	—
Long exposure NR	—	—	—	—	—	—	—	—	—	—	—
High ISO noise reduction	—	✓	✓	✓	✓	✓	✓	✓	✓	✓	✓
Fade in/fade out	—	—	✓ ⁵	✓ ⁵	✓ ⁵	✓ ⁵	—	—	—	—	—
Movie sound options	—	—	✓ ⁵	✓ ⁵	✓ ⁵	✓ ⁵	—	—	—	—	—
Interval timer shooting	—	—	—	—	—	—	—	—	—	—	—
Vibration reduction ⁶	—	✓	✓	✓	✓	✓	✓	✓	✓	✓	✓
Focus mode	—	—	✓	✓	✓	✓	—	—	—	—	—
AF-area mode	—	—	✓ ⁵	✓ ⁵	✓ ⁵	✓ ⁵	—	✓	✓	✓	✓
Face-priority AF	—	—	✓ ⁵	✓ ⁵	✓ ⁵	✓ ⁵	—	✓	✓	✓	✓
Built-in AF assist	—	✓	—	—	—	—	✓	✓	✓	✓	✓
Flash compensation	—	—	—	—	—	—	—	—	—	—	—

Shooting menu

			P	S	A	M		P	S	A	M	
Other settings	Focus area selection	—	—	✓ ⁵	✓ ⁵	✓ ⁵	✓ ⁵	—	✓	✓	✓	✓
	Flexible program	—	—	—	—	—	—	—	—	—	—	—
	Autoexposure Lock	—	—	✓	✓	✓	—	—	✓	✓	✓	—
	Focus lock	—	—	✓	✓	✓	✓	—	✓	✓	✓	✓
	Self-timer	✓	—	✓	✓	✓	✓	—	—	—	—	—
	Exposure compensation	—	—	✓	✓	✓	—	—	✓	✓	✓	—
	Flash mode	✓	—	—	—	—	—	—	—	—	—	—
	Movie mode	—	—	✓	✓	✓	✓	—	—	—	—	—
	Theme	—	—	—	—	—	—	✓	✓	✓	✓	✓

1 Scene auto selector is available only in Motion Snapshot mode.

2 RAW images fixed at 3872 × 2592.

3 Electronic (Hi) is not available.







4 Slow motion selected in movie mode.

5 HD movie selected in movie mode.

6 VR lenses only.



Creative Mode

In the table below, creative modes are represented by the following icons:  night landscape,  night portrait,  backlighting,  easy panorama,  soft,  miniature effect, and  selective color.

	P, S, A, M										
	P	S	A	M							
Exposure mode	✓	✓ ¹	✓ ¹	✓ ¹	—	—	—	—	—	—	—
Image quality	✓	✓	✓	✓	✓ ²	✓ ²	✓ ²	✓ ²	✓ ²	✓ ²	✓ ²
Image size	✓ ³	✓ ³	✓ ³	✓ ³	✓	✓	✓	✓	✓	✓	✓
Continuous	✓	✓	✓	✓	—	—	—	—	—	—	—
Frame rate	—	—	—	—	—	—	—	—	—	—	—
Movie settings	—	—	—	—	—	—	—	—	—	—	—
Metering	✓ ⁴	✓ ⁴	✓ ⁴	✓ ⁴	—	—	—	—	—	—	—
White balance	✓	✓	✓	✓	—	—	—	—	—	—	—
ISO sensitivity	✓ ⁴	✓ ⁴	✓ ⁴	✓ ⁴	—	—	—	—	—	—	—
Picture Control	✓	✓	✓	✓	—	—	—	—	—	—	—
Custom Picture Control	✓	✓	✓	✓	—	—	—	—	—	—	—
Color space	✓	✓	✓	✓	✓	✓	✓	✓	✓	✓	✓
HDR	—	—	—	—	—	—	✓	—	—	—	—
Active D-Lighting	✓	✓	✓	✓	—	—	—	—	—	—	—
Long exposure NR	✓ ⁴	✓ ⁴	✓ ⁴	✓ ⁴	—	—	—	—	—	—	—
High ISO noise reduction	✓	✓	✓	✓	—	—	—	—	—	—	—
Fade in/fade out	—	—	—	—	—	—	—	—	—	—	—
Movie sound options	—	—	—	—	—	—	—	—	—	—	—
Interval timer shooting	✓ ⁴	✓ ⁴	✓ ⁴	✓ ⁴	—	—	—	—	—	—	—
Vibration reduction ⁵	✓	✓	✓	✓	✓	✓	✓	✓	✓	✓	✓
Focus mode	✓ ⁴	✓ ⁴	✓ ⁴	✓ ⁴	—	—	—	—	—	—	—
AF-area mode	✓ ⁶	✓ ⁶	✓ ⁶	✓ ⁶	—	—	—	—	—	—	—
Face-priority AF	✓ ⁶	✓ ⁶	✓ ⁶	✓ ⁶	—	—	—	—	—	—	—
Built-in AF assist	✓	✓	✓	✓	✓	✓	✓	✓	✓	✓	✓
Flash compensation ⁷	✓ ⁴	✓ ⁴	✓ ⁴	✓ ⁴	—	✓	✓ ⁸	—	✓	✓	✓

Shooting menu



		P, S, A, M										
		P	S	A	M							
Other settings	Focus area selection	✓ ⁶	✓ ⁶	✓ ⁶	✓ ⁶	—	—	—	—	—	—	
	Flexible program	✓	—	—	—	—	—	—	—	—	—	
	Autoexposure Lock	✓	✓	✓	—	✓	✓	✓	✓	✓	✓	
	Focus lock	✓	✓	✓	✓	✓	✓	✓	✓	✓	✓	
	Self-timer	✓ ⁴	✓ ⁴	✓ ⁴	✓ ⁴	✓	✓	✓	—	✓	✓	
	Exposure compensation	✓	✓	✓	—	✓	✓	✓	✓	✓	✓	
	Flash mode	✓ ⁴	✓ ⁴	✓ ⁴	✓ ⁴	—	✓	✓ ⁸	—	✓	✓	
	Movie mode	—	—	—	—	—	—	—	—	—	—	
	Theme	—	—	—	—	—	—	—	—	—	—	

1 P Programmed auto is selected automatically when **Electronic (Hi)** is selected for **Continuous**.

2 NEF (RAW) and **NEF (RAW) + JPEG fine** not available.

3 RAW images fixed at 3872 × 2592.

4 Not available when **Electronic (Hi)** is selected for **Continuous**.

5 VR lenses only.

6 Not available if a frame rate of 10 fps is chosen when **Electronic (Hi)** is selected for **Continuous**.

7 Available only when built-in flash unit is raised.

8 Not available when **HDR** is on.



More on Photography

Self-Timer and Remote Control Modes

The self-timer and optional ML-L3 remote control (📖 68) can be used to reduce camera shake or for self-portraits. The following options are available:

Off	Self-timer and remote control off. The shutter is released when the camera shutter-release button is pressed.
🕒 10s 10 s	The shutter is released 2, 5, or 10 seconds after the shutter-release button is pressed all the way down. Choose 2 s to reduce camera shake, 5 s or 10 s for self-portraits.
🕒 5s 5 s	
🕒 2s 2 s	
🕒 Delayed remote	The shutter is released 2 s after the shutter-release button on the optional ML-L3 remote control is pressed.
🕒 Quick-response remote	The shutter is released when the shutter-release button on the optional ML-L3 remote control is pressed.

Before Using the Remote Control

Before using the remote control for the first time, remove the clear plastic battery-insulator sheet.

1 Mount the camera on a tripod.

Mount the camera on a tripod or place the camera on a stable, level surface.

2 Display self-timer options.

Press ◀ (🕒) to display self-timer options.



3 Select the desired option.

Use the multi selector to highlight the desired option and press .

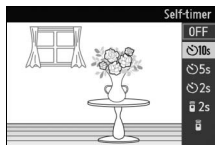

4 Frame the photograph and shoot.

Self-timer mode: Press the shutter-release button halfway to focus, and then press the button the rest of the way down. The self-timer lamp will start to flash and a beep will begin to sound. Two seconds before the photo is taken, the lamp will stop flashing and the beeping will become more rapid.

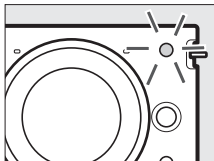

Remote control mode: Aim the ML-L3 at the infrared receiver on the camera ( 13) and press the ML-L3 shutter-release button (stand at a distance of 5 m/16 ft or less). In delayed remote mode, the self-timer lamp will light for about two seconds before the shutter is released. In quick-response remote mode, the self-timer lamp will flash after the shutter has been released.

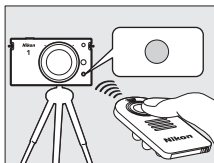

Note that the timer may not start or a photograph may not be taken if the camera is unable to focus or in other situations in which the shutter can not be released. Turning the camera off cancels self-timer and remote control modes. Remote control modes are cancelled automatically if no operations are performed for about five minutes after the mode is selected in Step 3.

Movie Mode

In self-timer mode, start and stop the timer by pressing the movie-record button instead of the shutter-release button. In remote control mode, the ML-L3 shutter-release button functions as the movie-record button.

Using the Built-in Flash

Slide the flash pop-up control to raise the flash before shooting. Shooting will be interrupted if the flash is raised while the self-timer or delayed-remote timer is counting down.

In remote control mode, the flash starts charging while the camera is waiting for the signal from the remote. The camera will only respond to the shutter-release button on the remote control when the flash is charged. If red-eye reduction ( 55) is used in quick-response remote mode, the shutter will be released about one second after the red-eye reduction lamp lights. In delayed remote mode, there will be about a two second delay after the shutter-release button on the remote control is pressed; the red-eye reduction lamp will then light for about one second before the shutter is released.

Tripod Mounting Spacer

Use an optional TA-N100 tripod adapter to prevent larger lenses coming into contact with the tripod head when the camera is mounted on a tripod ( 69).

See Also

See page 62 for options controlling how long the camera will wait for a signal from the remote and the beep that sounds when the self-timer or remote control is used.







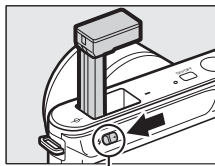

The Built-in Flash

To use the flash, raise it by sliding the flash pop-up control. Charging begins when the flash is raised; once charging is complete, a flash-ready indicator (●) will be displayed when the shutter-release button is pressed halfway. The following flash modes are available; choose a flash mode as described on the following page.



Flash pop-up control

 Fill flash	The flash fires with every shot. Use when the subject is poorly lit or with back-lit subjects to “fill in” (illuminate) shadows.
 Red-eye reduction	The red-eye reduction lamp lights before the flash fires, reducing “red-eye” caused by light reflecting from your subject’s retinas.
 Red-eye reduction + slow sync	Combines red-eye reduction with slow shutter speeds to capture background details at night or under low light. Use for portraits taken against a backdrop of night scenery.
 Fill flash + slow sync	Combines fill flash with slow shutter speeds to capture details of poorly-lit backgrounds.
 Rear curtain + slow sync	Combines rear-curtain sync (see below) with slow shutter speeds to capture poorly-lit background details.
 Rear-curtain sync	While in other modes the flash fires as the shutter opens, in rear-curtain sync the flash fires just before the shutter closes, creating streams of light that appear to follow moving light sources.



Choosing a Flash Mode

1 Display the flash mode options.

Press the multi selector down to display a list of flash modes. The modes available depend on the shooting or exposure mode (☞ 60).



Auto photo, Night portrait, Backlighting*, Soft, Miniature effect, and Selective color
shooting modes

Fill flash

Red-eye reduction

Exposure modes **S** and **M**

Fill flash

Red-eye reduction

Rear-curtain sync

*HDR off.

Exposure modes **P** and **A**

Fill flash

Red-eye reduction

Red-eye reduction + slow sync

Slow sync

Rear curtain + slow sync

2 Select a flash mode.

Use the multi selector to highlight a flash mode (☞ 55) and press to select.

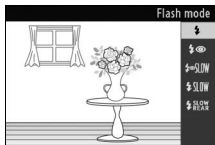

Lowering the Built-in Flash

To save power when the flash is not in use, press it gently downward until the latch clicks into place. *Do not use force.* Failure to observe this precaution could result in product malfunction.

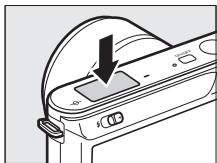

Using the Built-in Flash

The built-in flash can be used in auto photo mode and when **P, S, A, M, Night portrait, Backlighting, Soft, Miniature effect, or Selective color** is selected in creative mode. If the flash is fired multiple times in quick succession, the flash and shutter may be temporarily disabled to protect the flash. Shooting can be resumed after a brief pause.

Objects close to the camera may be overexposed in photographs taken with the flash at high ISO sensitivities.

To avoid vignetting, remove lens hoods and shoot at ranges of at least 0.6 m (2 ft). Some lenses may cause vignetting at greater distances or obstruct the red-eye reduction lamp, interfering with red-eye reduction. The following illustrations show the effect of vignetting caused by shadows cast by the lens when the built-in flash is used.

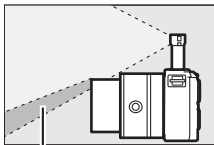

Shadow



Shadow

See Also

See page 61 for information on adjusting the flash level.



Using the Menu

Most shooting, playback, and setup options can be accessed from the camera menu. To view the menu, press the MENU button.

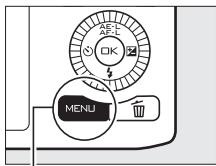

MENU button

Tabs

Choose from the following menus:

▶ Playback menu (60)

⚙ Setup menu (62)

📷 Shooting menu (60)

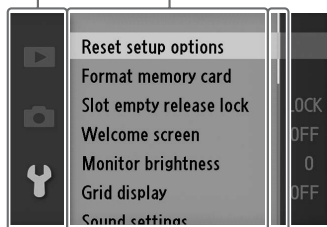

Menu options

Options in current menu.

Slider shows position in current menu.

■ Using the Menus

Use the multi selector to navigate the menus.

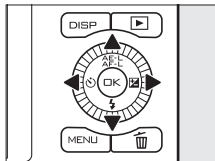

Multi selector

1 Press ▲ or ▼ to select the tab then press ► to display menu items.

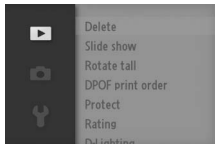

2 Highlight menu item and press ► to display options.

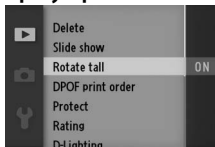

3 Highlight desired option and press **OK** to select.

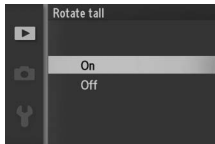

Using the Menus

The items listed may vary with camera settings. Items displayed in gray are not currently available (📖 48). To exit the menus and return to shooting mode, press the shutter-release button halfway (📖 21).

■ Playback Menu Options

Delete	Delete multiple images.
Slide show	View movies and photos in a slide show.
Rotate tall	Rotate “tall” (portrait-orientation) pictures for display during playback.
DPOF print order	Create digital “print orders”.
Protect	Protect pictures from accidental deletion.
Rating	Rate pictures.
D-Lighting	Brighten shadows in dark or back-lit photos, creating a retouched copy that is saved separately from the unmodified original.
Resize	Create small copies of selected pictures.
Crop	Create cropped copies of selected pictures.
Edit movie	Create copies of movies from which unwanted footage has been trimmed.

■ Shooting Menu Options

Reset shooting options	Reset shooting options to default values.
Exposure mode	Choose how the camera sets shutter speed and aperture.
Image quality	Choose a file format and compression ratio.
Image size	Choose a size for new photos.
Continuous	Take photos one at a time or in a burst.
Frame rate	Choose a frame rate for slow-motion movies (📖 40).



Movie settings	Choose HD movie frame size and frame rate (☐ 36).
Metering	Choose how the camera meters exposure.
White balance	Adjust settings for different types of lighting.
ISO sensitivity	Control the camera's sensitivity to light.
Picture Control	Choose how the camera processes pictures.
Custom Picture Control	Create custom Picture Controls.
Color space	Choose a color space for new pictures.
HDR	Enhance detail in highlights and shadows when photographing high-contrast scenes (☐ 30).
Active D-Lighting	Avoid loss of detail in highlights and shadows.
Long exposure NR	Reduce noise in long time-exposures.
High ISO noise reduction	Reduce noise at high ISO sensitivities.
Fade in/fade out	Shoot HD movies with fade in/fade out effects.
Movie sound options	Choose sound recording options.
Interval timer shooting	Take photos at a pre-selected interval.
Vibration reduction	Adjust settings for 1 NIKKOR lenses with vibration reduction.
Focus mode	Choose how the camera focuses.
AF-area mode	Choose how the focus area is selected.
Face-priority AF	Turn face-priority AF on or off.
Built-in AF assist	Control the built-in AF-assist illuminator.
Flash compensation	Control flash output.



■ Setup Menu Options

Reset setup options	Reset setup menu options to default values.
Format memory card	Format the memory card.
Slot empty release lock	Allow the shutter to be released when no memory card is inserted in the camera.
Welcome screen	Display a welcome message at startup.
Monitor brightness	Adjust monitor brightness.
Grid display	Display a framing grid.
Sound settings	Choose the sounds made during shooting.
Auto power off	Choose the auto power off delay.
Remote on duration	Choose how long the camera waits for a signal from a remote control.
Assign AE/AF-L button	Choose the role played by the ▲ (AE-L) button.
Shutter button AE lock	Choose whether exposure locks when the shutter-release button is pressed halfway.
HDMI device control	Choose whether remote controls for HDMI-CEC devices to which the camera is connected can be used to operate the camera.
Flicker reduction	Reduce flicker or banding.
Reset file numbering	Reset file numbering.
Time zone and date	Set the camera clock.
Language	Choose a language for the camera displays.
Auto image rotation	Record camera orientation with pictures.
Pixel mapping	Check and optimize the camera image sensor and image processors.
Firmware version	Display the current firmware version.





Connecting to a Computer

Installing the Supplied Software

Install the supplied software to copy pictures to your computer for viewing and editing pictures and creating short movies. Before installing the software, confirm that your system meets the requirements on page 64.

1 Insert the installer CD.

Start the computer and insert the ViewNX 2/Short Movie Creator CD. In Windows, the installer "Welcome" dialog will launch automatically; proceed to Step 2. Users of Mac OS must first double-click the CD icon () on the desktop and then double-click the **Welcome** icon ().

2 Select a language.

Select a language and click **Next**. If the desired language is not available, click **Region Selection** to choose a different region and then choose the desired language (region selection is not available in the European release).

3 Start the installer.

Click **Install** and follow the on-screen instructions.

4 Exit the installer.

Click **Yes** (Windows) or **OK** (Mac OS) when installation is complete. The following software is installed:

- ViewNX 2
- Short Movie Creator
- Apple QuickTime (Windows only)

5 Remove the installer CD from the CD-ROM drive.



System Requirements

The system requirements for the ViewNX 2 are:

Windows	
CPU	<ul style="list-style-type: none">• Photos/JPEG movies: Intel Celeron, Pentium 4, or Core series, 1.6 GHz or better• H.264 movies (playback): 3.0 GHz or better Pentium D• H.264 movies (editing): 2.6 GHz or better Core 2 Duo
OS	Pre-installed versions of Windows 7 Home Basic/Home Premium/Professional/Enterprise/Ultimate (64- and 32-bit editions; Service Pack 1), Windows Vista Home Basic/Home Premium/Business/Enterprise/Ultimate (64- and 32-bit editions; Service Pack 2), or Windows XP Home Edition/Professional (32-bit editions only; Service Pack 3).
RAM	<ul style="list-style-type: none">• Windows 7/Windows Vista: 1 GB or more (2 GB or more recommended)• Windows XP: 512 MB or more (2 GB or more recommended)
Hard-disk space	A minimum of 500 MB available on the startup disk (1 GB or more recommended)
Monitor	<ul style="list-style-type: none">• Resolution: 1024 × 768 pixels (XGA) or more (1280 × 1024 pixels (SXGA) or more recommended)• Color: 24-bit color (True Color) or more

Mac OS	
CPU	<ul style="list-style-type: none">• Photos/JPEG movies: Intel Core or Xeon series• H.264 movies (playback): Core Duo 2 GHz or better• H.264 movies (editing): 2.6 GHz or better Core 2 Duo
OS	Mac OS X version 10.6.8 or 10.7.3
RAM	512 MB or more (2 GB or more recommended)
Hard-disk space	A minimum of 500 MB available on the startup disk (1 GB or more recommended)
Monitor	<ul style="list-style-type: none">• Resolution: 1024 × 768 pixels (XGA) or more (1280 × 1024 pixels (SXGA) or more recommended)• Color: 24-bit color (millions of colors) or more

Motion Snapshots

ViewNX 2 is required to view Motion Snapshots on a computer.

Supported Operating Systems

See the websites listed on page 11 for the latest information on supported operating systems.

Viewing and Editing Pictures on a Computer

Transferring Pictures

1 Choose how pictures will be copied to the computer.

Choose one of the following methods:

- **Direct USB connection:** Turn the camera off and ensure that the memory card is inserted in the camera. Connect the camera to the computer using the supplied USB cable (do not use force or insert the connectors at an angle) and then turn the camera on.

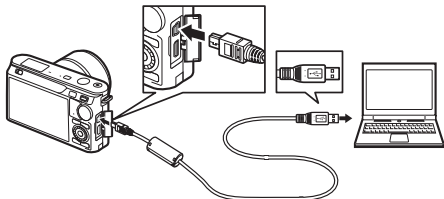

- **SD card slot:** If your computer is equipped with an SD card slot, the card can be inserted directly in the slot.
- **SD card reader:** Connect a card reader (available separately from third-party suppliers) to the computer and insert the memory card.

2 Start Nikon Transfer 2.

If a message is displayed prompting you to choose a program, select Nikon Transfer 2.

Windows 7

If the following dialog is displayed, select Nikon Transfer 2 as described below.

- 1 Under **Import pictures and videos**, click **Change program**. A program selection dialog will be displayed; select **Import File using Nikon Transfer 2** and click **OK**.



- 2 Double-click **Import file**.

3 Click Start Transfer.

At default settings, all the pictures on the memory card will be copied to the computer.



Click **Start Transfer**

4 Terminate the connection.

If the camera is connected to the computer, turn the camera off and disconnect the USB cable. If you are using a card reader or card slot, choose the appropriate option in the computer operating system to eject the removable disk corresponding to the memory card and then remove the card from the card reader or card slot.

Viewing Pictures

Pictures are displayed in ViewNX 2 when transfer is complete.

Starting ViewNX 2 Manually

- **Windows:** Double-click the ViewNX 2 shortcut on the desktop.
- **Mac OS:** Click the ViewNX 2 icon in the Dock.

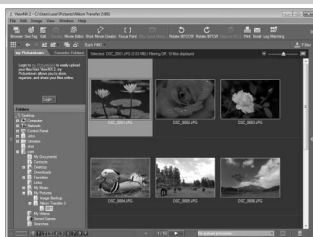

■ ■ Retouching Photographs

To crop pictures and perform such tasks as adjusting sharpness and tone levels, click the **Edit** button in the toolbar.



■ ■ Printing Pictures

Click the **Print** button in the toolbar. A dialog will be displayed, allowing you to print pictures on a printer connected to the computer.



For More Information

Consult online help for more information on using ViewNX 2.

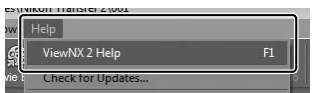

Technical Notes

Read this chapter for information on compatible accessories, cleaning and storing the camera, and what to do if an error message is displayed or you encounter problems using the camera.

Optional Accessories

At the time of writing, the following accessories were available for your camera.

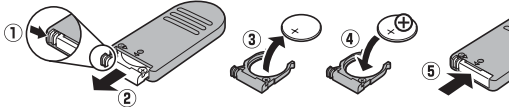
Lenses	1 mount lenses
Mount Adapter	Mount Adapter FT1
Power sources	<ul style="list-style-type: none">• Rechargeable Li-ion Battery EN-EL20 (□ 86): Additional EN-EL20 batteries are available from local retailers and Nikon-authorized service representatives.• Battery Charger MH-27 (□ 86): Recharge EN-EL20 batteries.• Power Connector EP-5C, AC Adapter EH-5b: These accessories can be used to power the camera for extended periods (EH-5a and EH-5 AC adapters can also be used). An EP-5C power connector is required to connect the camera to the EH-5b, EH-5a, or EH-5.
Remote controls	<p>Wireless Remote Control ML-L3 (□ 52): The ML-L3 uses a 3 V CR2025 battery.</p>  <p>Pressing the battery-chamber latch to the right (①), insert a fingernail into the gap and open the battery chamber (②). Ensure that the battery is in the correct orientation (④).</p>

Software	<p>Capture NX 2: A complete photo editing package offering such features as white balance adjustment and color control points.</p> <p>Note: Use the latest versions of Nikon software; see the websites listed on page 11 for the latest information on supported operating systems. At default settings, Nikon Message Center 2 will periodically check for updates to Capture NX 2 and other Nikon software and firmware while you are logged in to an account on the computer and the computer is connected to the Internet. A message is automatically displayed when an update is found.</p>
Body caps	<p>Body Cap BF-N1000: The body cap keeps the dust shield free of dust when a lens is not in place.</p>
Tripod adapters	<p>Tripod Adapter TA-N100: Prevents large lenses from coming into contact with the tripod head when the camera is mounted on a tripod.</p>



Approved Memory Cards

The following cards have been tested and approved for use in the camera. Cards with class 6 or faster write speeds are recommended for movie recording. Recording may end unexpectedly when cards with slower write speeds are used.

	SD cards	SDHC cards ²	SDXC cards ³
SanDisk	2 GB ¹	4 GB, 8 GB, 16 GB, 32 GB	64 GB
Toshiba			48 GB, 64 GB
Panasonic			—
Lexar Media	—	4 GB, 8 GB, 16 GB	—
Platinum II		4 GB, 8 GB, 16 GB, 32 GB	
Professional		4 GB, 8 GB, 16 GB	
Full-HD Video		4 GB, 8 GB, 16 GB	

- 1 Check that any card readers or other devices with which the card will be used support 2 GB cards.
- 2 Check that any card readers or other devices with which the card will be used are SDHC-compliant. The camera supports UHS-1.
- 3 Check that any card readers or other devices with which the card will be used are SDXC-compliant.  The camera supports UHS-1.

Other cards have not been tested. For more details on the above cards, please contact the manufacturer.



Storage and Cleaning

Storage

If the camera will not be used for an extended period, remove the battery and store it in a cool, dry area with the terminal cover in place. To prevent mold or mildew, store the camera in a dry, well-ventilated area. Do not store your camera with naphtha or camphor moth balls or in locations that:

- are poorly ventilated or subject to humidities of over 60%
- are next to equipment that produces strong electromagnetic fields, such as televisions or radios
- are exposed to temperatures above 50 °C (122 °F) or below -10 °C (14 °F)

Cleaning

Camera body	Use a blower to remove dust and lint, then wipe gently with a soft, dry cloth. After using the camera at the beach or sea-side, wipe off sand or salt with a cloth lightly dampened in distilled water and dry thoroughly. Important: <i>Dust or other foreign matter inside the camera may cause damage not covered under warranty.</i>
Lens	Lenses are easily damaged. Remove dust and lint with a blower. If using an aerosol blower, keep the can vertical to prevent the discharge of liquid. To remove fingerprints and other stains, apply a small amount of lens cleaner to a soft cloth and clean with care.
Monitor	Remove dust and lint with a blower. When removing fingerprints and other stains, wipe the surface lightly with a soft cloth or chamois leather. Do not apply pressure, as this could result in damage or malfunction.
Dust shield	The dust shield is easily damaged. Remove dust and lint with a blower.

Do not use alcohol, thinner, or other volatile chemicals.



Caring for the Camera and Battery: Cautions

Do not drop: The product may malfunction if subjected to strong shocks or vibration.

Keep dry: This product is not waterproof, and may malfunction if immersed in water or exposed to high levels of humidity. Rusting of the internal mechanism can cause irreparable damage.

Avoid sudden changes in temperature: Sudden changes in temperature, such as those that occur when entering or leaving a heated building on a cold day, can cause condensation inside the device. To prevent condensation, place the device in a carrying case or plastic bag before exposing it to sudden changes in temperature.

Keep away from strong magnetic fields: Do not use or store this device in the vicinity of equipment that generates strong electromagnetic radiation or magnetic fields. Strong static charges or the magnetic fields produced by equipment such as radio transmitters could interfere with the displays, damage data stored on the memory card, or affect the product's internal circuitry.

Do not leave the lens pointed at the sun: Do not leave the lens pointed at the sun or other strong light source for an extended period. Intense light may cause the image sensor to deteriorate or produce a white blur effect in photographs.

Keep the lens mount covered: Be sure to attach the body cap if the camera is without a lens.

Do not touch the dust shield: The dust shield covering the image sensor is easily damaged. Under no circumstances should you exert pressure on the shield or poke it with cleaning tools. These actions could scratch or otherwise damage the shield.

Turn the product off before removing or disconnecting the power source: Do not unplug the product or remove the battery while the product is on or while images are being recorded or deleted. Forcibly cutting power in these circumstances could result in loss of data or in damage to product memory or internal circuitry. To prevent an accidental interruption of power, avoid carrying the product from one location to another while the AC adapter is connected.



Cleaning: When cleaning the camera body, use a blower to gently remove dust and lint, then wipe gently with a soft, dry cloth. After using the camera at the beach or seaside, wipe off any sand or salt using a cloth lightly dampened in pure water and then dry the camera thoroughly.

Lenses are easily damaged. Dust and lint should be gently removed with a blower. When using an aerosol blower, keep the can vertical to prevent discharge of liquid. To remove fingerprints and other stains, apply a small amount of lens cleaner to a soft cloth and wipe the lens carefully.

Storage: To prevent mold or mildew, store the camera in a dry, well-ventilated area. If you are using an AC adapter, unplug the adapter to prevent fire. If the product will not be used for an extended period, remove the battery to prevent leakage and store the camera in a plastic bag containing a desiccant. Do not, however, store the camera case in a plastic bag, as this may cause the material to deteriorate. Note that desiccant gradually loses its capacity to absorb moisture and should be replaced at regular intervals.

To prevent mold or mildew, take the camera out of storage at least once a month. Turn the camera on and release the shutter a few times before putting it away.

Store the battery in a cool, dry place. Replace the terminal cover before putting the battery away.

Notes on the monitor: The monitor is constructed with extremely high precision; at least 99.99% of pixels are effective, with no more than 0.01% being missing or defective. Hence while these displays may contain pixels that are always lit (white, red, blue, or green) or always off (black), this is not a malfunction and has no effect on images recorded with the device.

Images in the monitor may be difficult to see in a bright light.

Do not apply pressure to the display, as this could cause damage or malfunction. Dust or lint on the displays can be removed with a blower. Stains can be removed by wiping lightly with a soft cloth or chamois leather. Should the monitor break, care should be taken to avoid injury from broken glass and to prevent liquid crystal from the display touching the skin or entering the eyes and mouth.

Moiré: Moiré is an interference pattern created by the interaction of an image containing a regular, repeating grid, such as the pattern of weave in cloth or windows in a building, with the camera image sensor grid. In some cases, it may appear in the form of lines. If you notice moiré in your photographs, try changing the distance to the subject, zooming in and out, or changing the angle between the subject and the camera.



Lines: Noise in the form of lines may in rare cases appear in pictures of extremely bright or backlit subjects.

Batteries: Batteries may leak or explode if improperly handled. Observe the following precautions when handling batteries:

- Use only batteries approved for use in this equipment.
- Do not expose the battery to flame or excessive heat.
- Keep the battery terminals clean.
- Turn the product off before replacing the battery.
- Remove the battery from the camera or charger when not in use and replace the terminal cover. These devices draw minute amounts of charge even when off and could draw the battery down to the point that it will no longer function. If the battery will not be used for some time, insert it in the camera and run it flat before removing it and storing it in a location with an ambient temperature of 15 to 25 °C (59 to 77 °F; avoid hot or extremely cold locations). Repeat this process at least once every six months.
- Turning the camera on and off repeatedly when the battery is fully discharged will shorten battery life. Batteries that have been fully discharged must be charged before use.
- The internal temperature of the battery may rise while the battery is in use. Attempting to charge the battery while the internal temperature is elevated will impair battery performance, and the battery may not charge or charge only partially. Wait for the battery to cool before charging.
- Continuing to charge the battery after it is fully charged can impair battery performance.
- A marked drop in the time a fully charged battery retains its charge when used at room temperature indicates that it requires replacement. Purchase a new EN-EL20 battery.
- Charge the battery before use. When taking photographs on important occasions, ready a spare EN-EL20 battery and keep it fully charged. Depending on your location, it may be difficult to purchase replacement batteries on short notice. Note that on cold days, the capacity of batteries tends to decrease. Be sure the battery is fully charged before taking photographs outside in cold weather. Keep a spare battery in a warm place and exchange the two as necessary. Once warmed, a cold battery may recover some of its charge.
- Used batteries are a valuable resource; recycle in accord with local regulations.



- Do not use the battery at ambient temperatures below 0°C (32°F) or above 40°C (104°F); failure to observe this precaution could damage the battery or impair its performance. Capacity may be reduced and charging times may increase at battery temperatures from 0°C (32°F) to 10°C (50°F) and from 45°C (113°F) to 60°C (140°F); the battery will not charge if its temperature is below 0°C (32°F) or above 60°C (140°F).

The battery charger: Charge the battery at ambient temperatures between 5°C (41°F) and 35°C (95°F). If the **CHARGE** lamp flashes quickly during charging, cease use immediately and take battery and charger to your retailer or a Nikon-authorized service representative.

Do not move the charger or touch the battery during charging. Failure to observe this precaution could in very rare instances result in the charger showing that charging is complete when the battery is only partially charged. Remove and reinsert the battery to begin charging again.

Use the charger with compatible batteries only. Unplug when not in use.

Memory Cards: The camera stores pictures on SD, SDHC, and SDXC memory cards (available separately; □ 70). Observe the following precautions when handling memory cards.

- Memory cards may be hot after use. Observe due caution when removing memory cards from the camera.
- Do not remove memory cards from the camera, turn the camera off, or remove or disconnect the power source during formatting or while data are being recorded, deleted, or copied to a computer. Failure to observe these precautions could result in loss of data or in damage to the camera or card.
- Do not touch the card terminals with your fingers or metal objects.
- Do not bend, drop, or subject to strong physical shocks.
- Do not apply force to the card casing. Failure to observe this precaution could damage the card.
- Do not expose to water, heat, high levels of humidity, or direct sunlight.
- Do not format memory cards in a computer.



✓ Servicing the Camera and Accessories

The camera is a precision device and requires regular servicing. Nikon recommends that the camera be inspected by the original retailer or Nikon-authorized service representative once every one to two years, and that it be serviced once every three to five years (note that fees apply to these services). Frequent inspection and servicing are particularly recommended if the camera is used professionally. Any accessories regularly used with the camera, such as lenses or optional flash units, should be included when the camera is inspected or serviced.

Troubleshooting

If the camera fails to function as expected, check this list of common problems before consulting your retailer or Nikon representative.

Display

The monitor is off:

- The camera is off (☐ 18) or the battery is exhausted (☐ 15, 16).
 - The monitor has turned off automatically to save power. The monitor can be reactivated by operating buttons or the mode dial.
 - The camera is connected to a computer or television.
-

The monitor turns off without warning:

- The battery is low (☐ 15, 16).
 - The monitor has turned off automatically to save power. The monitor can be reactivated by operating buttons or the mode dial.
 - The camera's internal temperature is high (☐ 10, 80). Wait for the camera to cool before turning it on again.
-

Indicators are not displayed: Press the DISP button.



Shooting (All Shooting and Exposure Modes)

The camera takes time to turn on: Delete files or format the memory card.

The shutter-release is disabled:

- The battery is exhausted (☐ 15, 16).
 - The memory card is locked or full (☐ 18).
 - The flash is charging (☐ 55).
 - The camera is not in focus (☐ 21).
 - You are currently filming a slow motion movie (☐ 38).
-

Only one picture is taken each time the shutter-release button is pressed in continuous release mode: Continuous shooting is not available if the flash is raised in **Continuous** mode.

No photo taken when remote control shutter-release button is pressed:

- Replace battery in remote control.
 - Choose a remote control mode (☐ 52).
 - The remote control standby timer has expired (☐ 62).
 - The remote is not pointed at the camera or the infrared receiver is not visible (☐ 13, 53).
 - The remote is too far from the camera (☐ 53).
 - Bright light is interfering with remote.
-

Smudges appear in photographs: Clean the front and rear lens elements or the dust shield (☐ 71).

Flicker or banding appears in movies or in the displays: Choose a **Flicker reduction** setting that matches the local AC power supply (☐ 62).

Menu items are unavailable: Some options are only available in particular shooting or exposure modes (☐ 48).

Movies

Cannot record movies: The movie-record button can only be used to record movies in movie mode (☐ 36).

No sound is recorded for movies:

- **Microphone off** is selected for **Movie sound options > Microphone** (☐ 61).
 - Live audio is not recorded with slow-motion movies (☐ 40) or Motion Snapshots (☐ 44).
-



Playback

“Tall” (portrait) orientation photos are displayed in “wide” (landscape) orientation:

- Select **On** for **Rotate tall** (☐ 60).
- The photos were taken with **Auto image rotation** off (☐ 62).
- Camera was pointed up or down when the photo was taken.
- Photo is displayed in image review.

Cannot hear movie sound:

- Press  up to raise the volume (☐ 42). If the camera is connected to a television, use the controls for the TV to adjust the volume.
- Live audio is not recorded with slow-motion movies (☐ 40) or Motion Snapshots (☐ 46).

Cannot delete images:

- Remove protection from the files before deletion.
- The memory card is locked.

Miscellaneous

The camera is unresponsive: In extremely rare instances, the display may not respond as expected and the camera may stop functioning. In most cases, this phenomenon is caused by a strong external static charge. Turn the camera off, remove and replace the battery, taking care to avoid burns, and turn the camera on again, or, if you are using an AC adapter (available separately), disconnect and reconnect the adapter and turn the camera on again. If the problem persists after the battery has been removed and replaced, contact your retailer or Nikon-authorized service representative.

The date of recording is not correct: Set the camera clock.

Menu items are unavailable: Some options are only available at particular settings (☐ 48) or when a memory card is inserted (☐ 17).



Error Messages

This section lists the error messages that appear in the display.

Message	Solution
(Shutter-speed or aperture display flashes)	If the subject is too bright, lower ISO sensitivity or choose a faster shutter speed or smaller aperture (higher f-number). If the subject is too dark, raise ISO sensitivity, use the built-in flash, or choose a slower shutter speed or larger aperture (lower f-number).
Keeping the zoom ring button pressed, rotate the zoom ring to extend the lens.	A lens with a retractable lens barrel button is attached with the lens barrel retracted. Press the retractable lens barrel button and rotate the zoom ring to extend the lens.
Check lens. Pictures can only be taken when a lens is attached.	Attach a lens.
Start-up error. Turn the camera off and then on again.	Turn the camera off, remove and replace the battery, and then turn the camera on.
The clock has been reset.	Set the camera clock.
No memory card.	Turn the camera off and confirm that the card is correctly inserted.
This memory card is not formatted. Format the memory card?	Select Yes to format the card, or turn the camera off and insert another memory card.
Memory card is locked (write protected).	Turn the camera off and slide the card write-protect switch to the "write" position.
Memory card is full.	<ul style="list-style-type: none">• You may be able to record additional images if you reduce image quality or size.• Delete unwanted images.• Insert another memory card.
This memory card cannot be used. Card may be damaged; insert a different card.	<ul style="list-style-type: none">• Use an approved card.• Format the card (□ 17). If the problem persists, the card may be damaged. Contact a Nikon-authorized service representative.• Insert a new memory card.



Message	Solution
Cannot create additional folders on memory card.	If the current folder is numbered 999 and contains either 999 photographs or a photograph numbered 9999, the shutter-release button will be disabled and no further photographs can be taken. Choose Yes for Reset file numbering and then either format the current memory card or insert a new memory card.
The movie-record button can not be used in this mode.	The movie-record button can only be used in movie mode.
Stills can not be taken when slow motion is selected.	The shutter-release button can not be used to take photographs while a slow-motion movie is being recorded.
Cannot shoot panorama with lens of this focal length.	Use a lens with a focal length of 6 to 30 mm to shoot panoramas. If you are using a zoom lens, choose a focal length between 6 and 30 mm.
The camera's internal temperature is high. The camera will now turn off.	Wait for the camera to cool.
Memory card contains no images.	To view pictures, insert a memory card containing images.
Cannot display this file.	The file has been created or modified on a computer or different make of camera, or is corrupt.
Cannot select this file.	















Specifications

Nikon 1 J2 Digital Camera

Type					
Type	Digital camera with support for interchangeable lenses				
Lens mount	Nikon 1 mount				
Effective angle of view	Approx. 2.7× lens focal length (35 mm format equivalent)				
Effective pixels					
	10.1 million				
Image sensor					
Image sensor	13.2 mm × 8.8 mm CMOS sensor (Nikon CX format)				
Storage					
Image size (pixels)	Still images (auto photo, Smart Photo Selector, and all creative modes other than Easy panorama; aspect ratio 3 : 2)				
	<table border="1"> <tr> <td>• 3872 × 2592</td> <td>• 2896 × 1944</td> </tr> <tr> <td>• 1936 × 1296</td> <td></td> </tr> </table>	• 3872 × 2592	• 2896 × 1944	• 1936 × 1296	
	• 3872 × 2592	• 2896 × 1944			
	• 1936 × 1296				
	Still images (Normal panorama, camera panned horizontally; aspect ratio 40 : 7)				
	• 3200 × 560				
	Still images (Normal panorama, camera panned vertically; aspect ratio 8 : 25)				
	• 1024 × 3200				
	Still images (Wide panorama, camera panned horizontally; aspect ratio 80 : 7)				
	• 6400 × 560				
	Still images (Wide panorama, camera panned vertically; aspect ratio 4 : 25)				
	• 1024 × 6400				
Still images (movie mode, aspect ratio 16 : 9)					
<table border="1"> <tr> <td>• 3840 × 2160 (1080/60i)</td> <td>• 1920 × 1080 (1080/30p)</td> </tr> <tr> <td>• 1280 × 720 (720/60p)</td> <td></td> </tr> </table>	• 3840 × 2160 (1080/60i)	• 1920 × 1080 (1080/30p)	• 1280 × 720 (720/60p)		
• 3840 × 2160 (1080/60i)	• 1920 × 1080 (1080/30p)				
• 1280 × 720 (720/60p)					
Still images (Motion Snapshot mode, aspect ratio 16 : 9)					
• 3840 × 2160					



Storage	
File format	<ul style="list-style-type: none"> • NEF (RAW): 12-bit, compressed • JPEG: JPEG-Baseline compliant with fine (approx. 1 : 4), normal (approx. 1 : 8), or basic (approx. 1 : 16) compression • NEF (RAW) + JPEG: Single photograph recorded in both NEF (RAW) and JPEG formats
Picture Control system	Standard, Neutral, Vivid, Monochrome, Portrait, Landscape; selected Picture Control can be modified; storage for custom Picture Controls
Media	SD (Secure Digital), SDHC, and SDXC memory cards
File system	DCF (Design Rule for Camera File System) 2.0, DPOF (Digital Print Order Format), Exif (Exchangeable Image File Format for Digital Still Cameras) 2.3, PictBridge
Shooting modes	
	 auto photo (3 : 2);  creative, with a choice of the following options: P, S, A, M (3 : 2),  night landscape (3 : 2),  night portrait (3 : 2),  backlighting (3 : 2),  easy panorama (normal horizontal 40 : 7, normal vertical 8 : 25, wide horizontal 80 : 7, wide vertical 4 : 25),  soft (3 : 2),  miniature effect (3 : 2) and  selective color (3 : 2);  Smart Photo Selector (3 : 2);  movie (HD 16 : 9, slow motion 8 : 3);  Motion Snapshot (16 : 9)
Shutter	
Type	Electronic shutter
Speed	1/16,000–30 s in steps of 1/3 EV; Bulb; Time (requires optional ML-L3 remote control)
Flash sync speed	Synchronizes with shutter at X=1/60 s or slower
Release	
Mode	<ul style="list-style-type: none"> • Single frame, continuous, Electronic (Hi) • Self-timer, delayed remote, quick-response remote, interval timer shooting

Release	
Frame advance rate	<ul style="list-style-type: none"> • Electronic (Hi): Approx. 10, 30, or 60 fps • Other modes: Up to 5 fps (auto photo mode or P, S, A, M chosen in creative mode with Continuous selected for Continuous, single AF or manual focus, S Shutter-priority auto or M Manual exposure mode, shutter speed $\frac{1}{250}$ s or faster, and other settings at default values)
Self-timer	2 s, 5 s, 10 s
Remote control modes	Delayed remote (2 s); quick-response remote
Exposure	
Metering	TTL metering using image sensor
Metering method	<ul style="list-style-type: none"> • Matrix • Center-weighted: Meters 4.5 mm circle in center of frame • Spot: Meters 2 mm circle centered on selected focus area
Mode	Programmed auto with flexible program; shutter-priority auto; aperture-priority auto; manual; automatic scene selection
Exposure compensation	-3 – +3 EV in increments of $\frac{1}{3}$ EV; available when P Programmed auto , S Shutter-priority auto , or A Aperture-priority auto is selected for Exposure mode
Exposure lock	Luminosity locked at metered value with AE-L/AF-L (AE-L/AF-L) button
ISO sensitivity (Recommended Exposure Index)	ISO 100–3200 in steps of 1 EV. Can be adjusted by user when P Programmed auto , S Shutter-priority auto , A Aperture-priority auto , or M Manual is selected for Exposure mode ; can also be set to approx. 1 EV (ISO 6400 equivalent) above ISO 3200; auto ISO sensitivity control (ISO 100–3200, 100–800, 100–400) available
Active D-Lighting	On, off



Focus	
Autofocus	Hybrid autofocus (phase detection/contrast-detect AF); AF-assist illuminator
Lens servo	<ul style="list-style-type: none"> • Autofocus (AF): Single AF (AF-S); continuous AF (AF-C); auto AF-S/AF-C selection (AF-A); full-time AF (AF-F) • Manual focus (MF)
AF-area mode	Single-point, auto-area, subject tracking
Focus area	<ul style="list-style-type: none"> • Single-point AF: 135 focus areas; the center 73 areas support phase-detection AF • Auto-area AF: 41 focus areas
Focus lock	Focus can be locked by pressing shutter-release button halfway (single AF) or by pressing AE-L/AF-L (AE-L/AF-L) button
Face-priority AF	On, off
Flash	
Built-in flash	Raised by sliding flash pop-up control
Guide Number (GN)	Approx. 5/16 (m/ft, ISO 100, 20 °C/68 °F)
Control	i-TTL flash control using image sensor available
Mode	Fill flash, slow sync, red-eye reduction, slow sync with red-eye reduction, rear-curtain sync, rear curtain with slow sync
Flash compensation	-3 - +1 EV in increments of $\frac{1}{3}$ EV
Flash-ready indicator	Lights when built-in flash unit is fully charged
White balance	
	Auto, incandescent, fluorescent, direct sunlight, flash, cloudy, shade, preset manual, all except preset manual with fine tuning
Movie	
Metering	TTL metering using image sensor
Metering method	<ul style="list-style-type: none"> • Matrix • Center-weighted: Meters 4.5 mm circle in center of frame • Spot: Meters 2 mm circle centered on selected focus area



Movie	
Frame size (pixels)/ recording rate	HD movies <ul style="list-style-type: none"> • 1920 × 1080/60i (59.94 fields/s*) • 1920 × 1080/30p (29.97 fps) • 1280 × 720/60p (59.94 fps)
	Slow-motion movies <ul style="list-style-type: none"> • 640 × 240/400 fps (plays at 30p/29.97 fps) • 320 × 120/1200 fps (plays at 30p/29.97 fps)
	Motion Snapshot
	1920 × 1080/60p (59.94 fps) (plays at 24p/23.976 fps)
File format	MOV
Video compression	H.264/MPEG-4 Advanced Video Coding
Audio recording format	AAC
Audio recording device	Built-in stereo microphone; sensitivity adjustable
* Sensor output is about 60 fps.	
Monitor	7.5 cm (3-in.), approx. 921k-dot, TFT LCD with brightness adjustment
Playback	Full-frame and thumbnail (4, 9, or 72 images or calendar) playback with playback zoom, movie and panorama playback, slide show, histogram display, auto image rotation, and rating option
Interface	
USB	Hi-Speed USB
HDMI output	Type C mini-pin HDMI connector
Supported languages	Arabic, Chinese (Simplified and Traditional), Czech, Danish, Dutch, English, Finnish, French, German, Greek, Hungarian, Indonesian, Italian, Japanese, Korean, Norwegian, Polish, Portuguese, Romanian, Russian, Spanish, Swedish, Thai, Turkish, Ukrainian
Power source	
Battery	One rechargeable Li-ion EN-EL20 battery
AC adapter	EH-5b AC adapter; requires EP-5C power connector (available separately)
Tripod socket	1/4-in. (ISO 1222)



Dimensions/weight	
Dimensions (W × H × D)	Approx. 106.0 × 61.0 × 29.8 mm (4.2 × 2.4 × 1.2 in.), excluding projections
Weight	Approx. 280 g (9.9 oz) with battery and memory card but without body cap; approx. 237 g/8.4 oz (camera body only)

Operating environment	
Temperature	0–40 °C (+32–104 °F)
Humidity	85% or less (no condensation)

- Unless otherwise stated, all figures are for a camera with a fully-charged battery operating at the temperature specified by the Camera and Imaging Products Association (CIPA): 23 ±3 °C (73.4 ±5.4 °F).
- Nikon reserves the right to change the specifications of the hardware and software described in this manual at any time and without prior notice. Nikon will not be held liable for damages that may result from any mistakes that this manual may contain.

MH-27 battery charger	
Rated input	AC 100–240 V, 50–60 Hz, 0.2 A
Rated output	DC 8.4 V/0.6 A
Supported batteries	Nikon EN-EL20 rechargeable Li-ion batteries
Charging time	Approx. 2 hours at an ambient temperature of 25 °C (77 °F) when no charge remains
Operating temperature	0–40 °C (+32–104 °F)
Dimensions (W × H × D)	Approx. 67.0 × 28.0 × 94.0 mm (2.6 × 1.1 × 3.7 in.), excluding plug adapter
Weight	Approx. 83 g (2.9 oz), excluding plug adapter

EN-EL20 rechargeable Li-ion battery	
Type	Rechargeable lithium-ion battery
Rated capacity	7.2 V, 1020 mAh
Operating temperature	0–40 °C (+32–104 °F)
Dimensions (W × H × D)	Approx. 30.7 × 50.0 × 14.0 mm (1.2 × 2.0 × 0.6 in.)
Weight	Approx. 41 g (1.4 oz), excluding terminal cover



1 NIKKOR VR 10–30mm f/3.5–5.6

Type	1 mount lens
Focal length	10–30 mm
Maximum aperture	f/3.5–5.6
Construction	12 elements in 9 groups (including 3 aspherical elements)
Angle of view	77°–29° 40'
Vibration reduction	Lens shift using voice coil motors (VCMs)
Minimum focus distance	0.2 m (0.7 ft) from focal plane at all zoom positions
Diaphragm blades	7 (rounded diaphragm opening)
Diaphragm	Fully automatic
Aperture range	<ul style="list-style-type: none">• 10 mm focal length: f/3.5–16• 30 mm focal length: f/5.6–16
Filter-attachment size	40.5 mm (P=0.5 mm)
Dimensions	Approx. 57.5 mm diameter × 42 mm (distance from camera lens mount flange when lens is retracted)
Weight	Approx. 115 g (4.1 oz)

1 NIKKOR 11–27.5mm f/3.5–5.6

Type	1 mount lens
Focal length	11–27.5 mm
Maximum aperture	f/3.5–5.6
Construction	8 elements in 6 groups (including 1 ED lens element and 1 aspherical lens element), 1 protective glass element
Angle of view	72°–32° 20'
Minimum focus distance	0.3 m (1.0 ft) from focal plane at all zoom positions
Diaphragm blades	7 (rounded diaphragm opening)
Diaphragm	Fully automatic
Aperture range	<ul style="list-style-type: none">• 11 mm focal length: f/3.5–16• 27.5 mm focal length: f/5.6–16
Filter-attachment size	40.5 mm (P=0.5 mm)
Dimensions	Approx. 57.5 mm diameter × 31 mm (distance from camera lens mount flange when lens is retracted)
Weight	Approx. 83 g (3.0 oz)

Specifications subject to change without notice. Nikon will not be held liable for damages that may result from any mistakes that this manual may contain.



Trademark Information

Macintosh, Mac OS, and QuickTime are registered trademarks of Apple Inc. in the United States and/or other countries. Microsoft, Windows, and Windows Vista are either registered trademarks, or trademarks of Microsoft Corporation in the United States and/or other countries. The PictBridge logo is a trademark. The SD, SDHC, and SDXC logos are trademarks of SD-3C, LLC. HDMI, the **HDMI** logo and High-Definition Multimedia Interface are trademarks or registered trademarks of HDMI Licensing LLC. All other trade names mentioned in this manual or the other documentation provided with your Nikon product are trademarks or registered trademarks of their respective holders.



Battery Life

The number of shots or movie footage that can be recorded with fully-charged batteries varies with the condition of the battery, temperature, the interval between shots, and the length of time menus are displayed. Sample figures for EN-EL20 (1020 mAh) batteries are given below.

- **Still images: Approximately 230 shots**
- **Movies: Approximately 50 minutes of HD footage at 1080/60i**

Measured according to CIPA standards at 23 ± 3 °C (73.4 ± 5.4 °F) with the camera at default settings, a fully-charged battery, a 1 NIKKOR VR 10–30mm f/3.5–5.6 lens, and a 16 GB Toshiba SD-E016GUX UHS-I SDHC card value for still images obtained under the following test conditions: NORMAL-quality photographs taken at intervals of 30 s with the flash fired with every other shot and the camera turned off and then on after every ten shots. Value for movies obtained under the following test conditions: a series of 20 minute movies with a file size of up to 4 GB were recorded; recording was only interrupted when temperature warning was displayed.

The following can reduce battery life:

- Keeping the shutter-release button pressed halfway
- Repeated autofocus operations
- Taking NEF (RAW) photographs
- Slow shutter speeds
- Using Eye-Fi cards
- Using vibration reduction mode with VR lenses
- Using zoom with power zoom lenses























To ensure that you get the most from rechargeable Nikon EN-EL20 batteries:

- Keep the battery contacts clean. Soiled contacts can reduce battery performance.
- Use batteries immediately after charging. Batteries will lose their charge if left unused.



Index

Symbols

 (Auto photo mode)	20
 (Creative mode)	26
 (Smart Photo Selector mode)	32
 (Movie mode)	36
 (Motion Snapshot mode)	44
P (Programmed auto)	29
S (Shutter-priority auto)	29
A (Aperture-priority auto)	29
M (Manual)	29
P, S, A, M	27, 29
 (Night landscape)	27
 (Night portrait)	27
 (Backlighting)	27, 30
 (Easy panorama)	27, 31
 (Soft)	28
 (Miniature effect)	28
 (Selective color)	28
MENU button	58
 (playback) button	24, 34, 47
 (delete) button	25, 35, 43, 47
DISP (display) button	19, 46
 (feature) button	26, 39, 46
 (OK) button	14, 34, 42, 47
 (self-timer)	52
 (playback zoom/thumbnaill) control	24, 42, 46
 2s (delayed remote)	52
 (quick-response remote)	52
 (red-eye reduction)	55
SLOW (slow sync)	55
REAR (rear curtain sync)	55
 (flash-ready indicator)	55

A

AC adapter	68
Accessories	68
Aperture-priority auto	29

Attaching the lens	18
Auto photo mode	20
Auto power off	23
Automatic scene selection	23
Available settings	48

B

Background track	46, 47
Backlighting	27, 30
Battery	16, 17, 86
Beep	21, 53
Best shot	32, 34
Body cap	12, 13, 69
Buffering	33, 45
Built-in Flash	55

C

Charging a battery	16
Compatible lens	68
Computer	63
Creative mode	26

D

Delayed remote	52
Delete	25, 35, 43, 47
Dust shield	13, 71

E

Easy panorama	27, 31
Exposure mode	29, 60

F

Face-priority AF	23
Fill flash	55
Flash	55
Flash mode	56
Flash-ready indicator	55
Focus area	21
Format memory card	17
Full-frame playback	24

G

Grid display 19

H

H.264 85

HD Movies 36

HDR 30

I

Infrared receiver 13, 53

L

Lens 18, 21, 22, 68, 87

M

Manual 29

Maximum aperture 87

Memory card 17, 70

Memory card access lamp 22

Microphone 37

Miniature effect 28

Mode dial 1, 14

Monitor 15

Motion Snapshot mode 44

Mount adapter 68

Movie mode 36

Movie type 39

Movie-record button 37, 41

Movies 36

Multi selector 14, 59

N

Night landscape 27

Night portrait 27

Nikon Transfer 2 65

P

Playback 24

Playback menu 60

Power connector 68

Power switch 18

Press the shutter-release button all
the way down 22Press the shutter-release button
halfway 21, 33, 45
Programmed auto 29**Q**

Quick-response remote 52

R

Rear-curtain sync 55

Red-eye reduction 55

Remote control 52

Retractable lens barrel button 22

S

Scene selection 27

SD card 70

Selective color 28

Self-timer 52

Setup menu 62

Shooting menu 60

Short Movie Creator 63

Shutter-priority auto 29

Shutter-release button 21, 33, 45

Size 81, 85

Slow motion 40

Slow sync 55

Smart Photo Selector mode 32

Soft 28

Speaker 13

Strap 16

System requirements 64

T

Temperature warnings 10

Theme 46

Tripod mounting spacer 54, 69

U

USB cable 65

V

ViewNX 2 63, 64

Volume 42



Z

Zoom ring	21
-----------------	----



No reproduction in any form of this manual, in whole or in part (except for brief quotation in critical articles or reviews), may be made without written authorization from NIKON CORPORATION.



Free Manuals Download Website

<http://myh66.com>

<http://usermanuals.us>

<http://www.somanuals.com>

<http://www.4manuals.cc>

<http://www.manual-lib.com>

<http://www.404manual.com>

<http://www.luxmanual.com>

<http://aubethermostatmanual.com>

Golf course search by state

<http://golfingnear.com>

Email search by domain

<http://emailbydomain.com>

Auto manuals search

<http://auto.somanuals.com>

TV manuals search

<http://tv.somanuals.com>