

Polycom® SoundPoint® IP 600 SIP 1.5

Quick Reference Guide

Written by: Customer Training and Documentation (CTD)
<http://customertraining.verizonbusiness.com>

Introduction	2
Installation	2
Connect the Network and Power Source	2
Connect Handset/Headset	3
Attach the Base	3
Features	4
Key Descriptions	5
Using the SoundPoint IP 600 SIP Phone	6
Place a Call	6
Answer a Call	6
Call Hold and Resume	7
General Key Use	7
Conferencing	7
Transfer a Call	8
Call Forwarding	8
Do Not Disturb	8
Shared Call Appearance	9
Multiple Lines	9
Multiple Keys Per Line	10
Multiple Call Appearance	10
Shared Lines	11
Access Voice Mail	11

Introduction

The Polycom SoundPoint IP 600 is a full-duplex, hands-free Session Initiation Protocol (SIP) phone. It provides telephony features, such as Shared Call Appearance, Call Hold, Call Transfer, and Do Not Disturb.

Installation

The following instructions provide basic installation instructions. Contact your system administrator for additional information or assistance.

Connect the Network and Power Source

AC Power Option

Connect the supplied network cable between the LAN jack on the phone and the LAN port on the wall or hub/switch device port.

Connect the DC plug on the AC wall adapter to the DC jack marked on the phone.

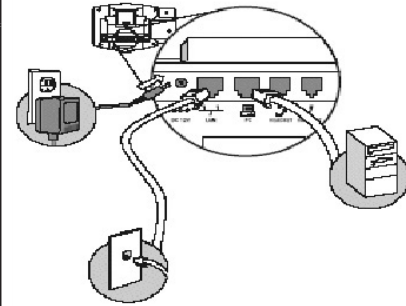

In-Line Power Option

Plug the supplied network cable between the LAN jack on the phone and an available Power and Data port on the in-line power switch if the phone is connected to a compatible Ethernet switch.

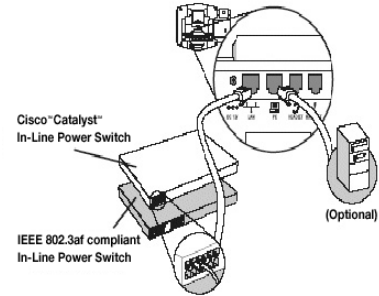

Connect Handset/Headset

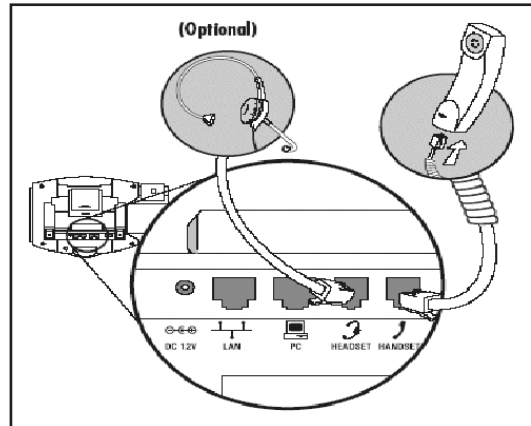

1. Connect the short, straight end of the phone cord to the handset, and the corresponding longer straight end of the cord to the HANDSET jack on the back of the phone.
2. Connect the headset (optional accessory) to the HEADSET jack on the back of the phone.

Attach the Base

Place the cords in the recessed area above the modular jacks as shown below.



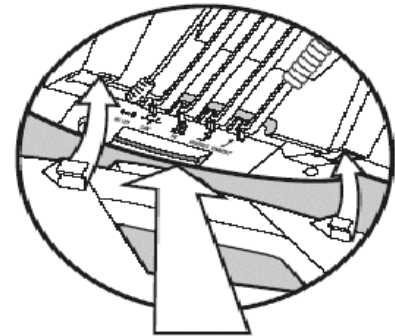
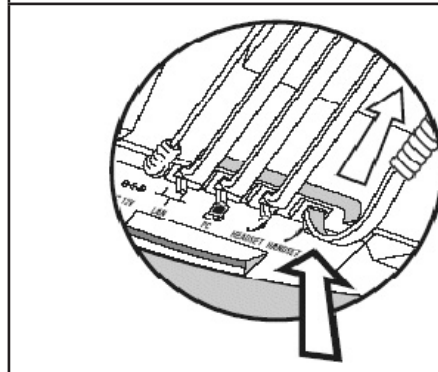



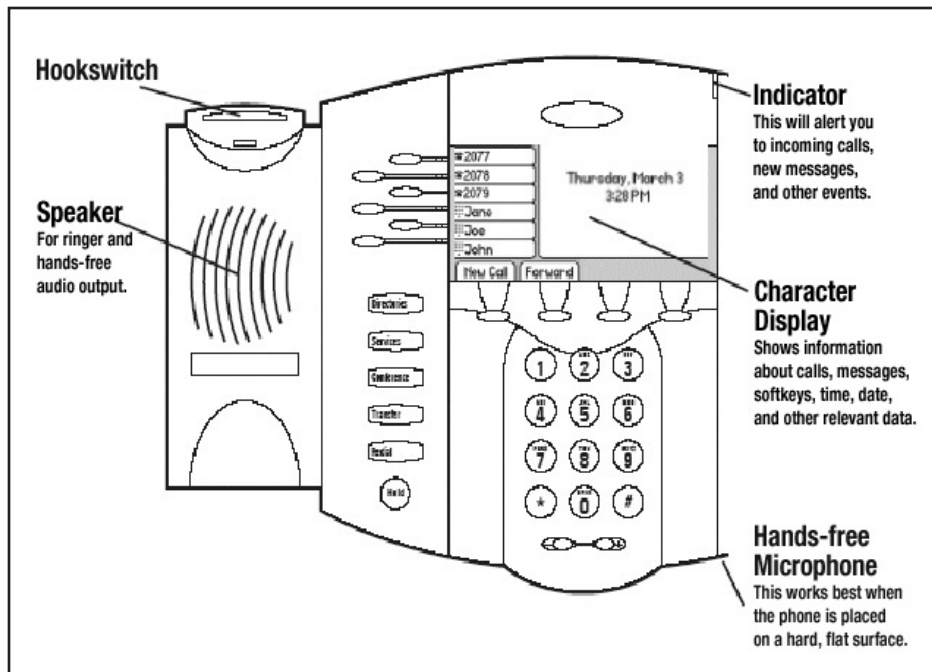
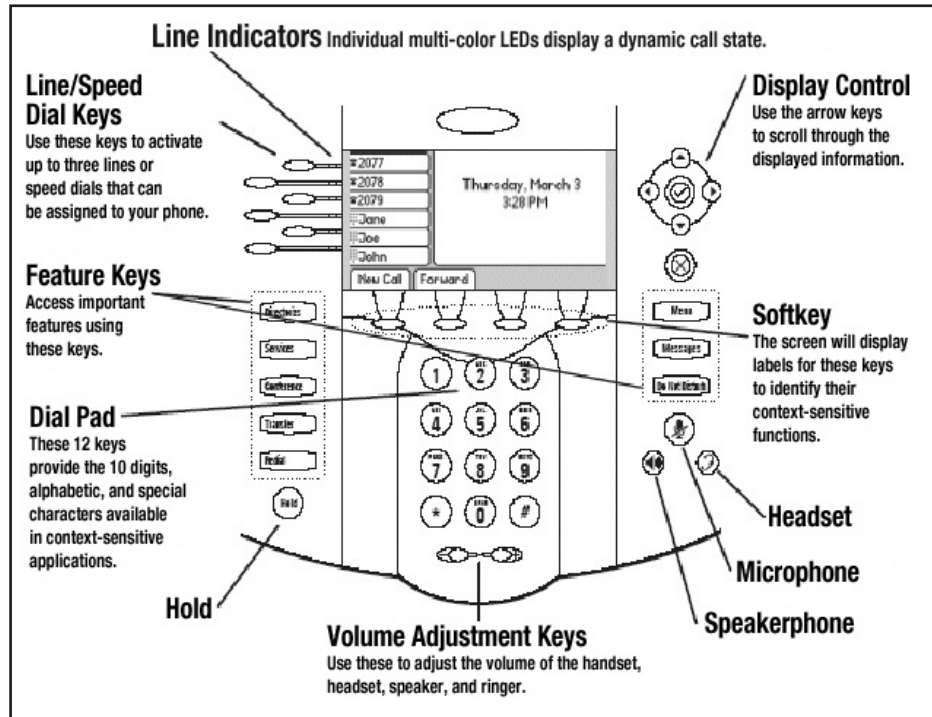





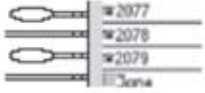

Align the two protrusions on the bracket with their corresponding holes in the phone and snap them together to lock the base to the phone.



Features





Key Descriptions

	<p>Allows for hands-free communication during calls</p>
	<p>Mutes audio transmission locally during calls</p>
	<p>Allows users to place and receive calls through an optionally connected headset</p>
	<p>Line or Speed Dial keys with LED indicators</p>
	<p>Access to local directories and call lists</p>
	<p>Access to special services</p>
	<p>Allows setup of a 3-way local conference</p>
	<p>Transfer of current call to third party</p>
	<p>Dials last connected party from the phone</p>
	<p>Places current active call in Hold state</p>
	<p>Cancels ringing and directs incoming calls to your voicemail (if supported)</p>
	<p>Place/receive text and voice messages</p>
	<p>Access local and server features</p>
	<p>Access local and server features</p>
	<p>Select and Delete controls for options and text within local menus</p>

Using the SoundPoint IP 600 SIP Phone

Place a Call

Users can alternate between handset, headset, or hands-free by pressing the  or  keys, or picking up the handset.

Using the Handset

1. Pick up the handset to obtain a dial tone.
2. Dial the number.

–or–

1. Dial the SIP URL/IP address (i.e., 10.3.0.42, joe@205.173.1.24, sip: jane@ polycom.com).
2. Press **Name** after obtaining the dial tone.
3. Enter the URL or IP (press * for “.” and # for “@”).
4. Press **Send** to complete the call.

Using the Hands-Free Speakerphone

1. Press any assigned line key,  or **NewCall** to obtain a dial tone with the handset on-hook.
2. Dial the number.

–or–



1. Dial by SIP, URL, or IP address.

Using the Headset

1. Press any assigned line key,  or **NewCall** to get a dial tone with the headset connected.
2. Dial the number.

–or–

1. Dial the SIP URL or IP address.

Note: You can dial directly from the dial pad without getting a dial tone first. Enter the number then lift the handset, press the Dial softkey, or press the  or  keys.

Answer a Call

After answering a call, it appears on the display showing the duration and destination.

1. Pick up the handset.

–or–

1. Press  to answer with the speakerphone.

–or–

1. Press the line key with the active indicator (with the handset on the hook).

–or–

1. Press the **Answer** softkey (with the handset on the hook).

–or–

1. Press  to answer through your connected headset.

Note: You can ignore incoming calls by pressing the Reject softkey or  while the phone is ringing. Do Not Disturb remains active after the call is dropped until you toggle it off.

Call Hold and Resume

1. Press  or the **Hold** softkey. The call is placed on hold and is indicated on the display.
2. Press the **Resume** softkey or the line button to retrieve the call.









Multiple Calls on Hold

You can use the arrow keys to switch between calls, then press the Resume softkey to retrieve a call when multiple calls are on hold on a single line. An indicator appears on the display if more than two calls are on hold on a single key. For example, "2/3" shows that this is the second call out of three calls.

The details of calls on any line key can be viewed by pressing that line key and holding it down for a few seconds if calls are on hold on more than one line. If a line key is pressed briefly, the first call on hold on that line is retrieved.

General Key Use

Following are tips to navigate through menus and enter data.

1. Use  and  to scroll through lists. In some lists, the  and  keys can be used as *Page Up* and *Page Down*.
2. Use  and  to move one level down or one level back up when menus have submenus.
3. Press the  key to exit from any menu.
4. Press the  key to exit from any directory.
5. Press the number keys one or more times to enter text using the dial pad. For example, for A press **2**, for C press **222**. The display title shows whether keys will generate numbers when in text entry mode.

Conferencing

You can create a conference with two other parties using the local conferencing feature. You can also create a conference between an active call and a call that is on hold on the same line by pressing the **Join** softkey.

1. Place a call to the first party.
2. Press  or the **Confnc** softkey to create a new call (the active call is placed on hold).
3. Dial the phone number of the second party.

–or–



1. Use the arrow keys to access speed dial numbers, missed, placed, and received call lists.
2. Press the **Dial** softkey.
3. Press  or the **Confnc** softkey again to join the parties in the conference.

–or–

1. Press the **Split** softkey to put the first call on hold and keep the second call as the active call.

Note: Ending a call on the originator's phone terminates the conference.

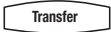
Transfer a Call

1. Press  during a call or the **Transfer** softkey. The active call is placed on hold.
2. Press the **Blind** softkey if you want to perform a blind transfer (without informing the party to whom you are transferring).
3. Dial the number to which you want to transfer the call or use the arrow keys to access speed dial numbers, missed, placed, and received call lists.
4. Press the **Dial** softkey.
5. Press  or the **Transfer** softkey again.

Call Forwarding

You can forward calls to another extension in your location.

1. Press the **Forward** softkey from the phone's idle display (select which line to forward if multiple lines are in use).
2. Enter the number or URL to which you want to forward.
3. Press the **Enable** softkey.

Disable Call Forwarding

1. Press the **Forward** softkey from the phone's idle display (select which line to forward if multiple lines are in use).
2. Press the **Disable** softkey.

Do Not Disturb

Calls that are received while *Do Not Disturb* is enabled are logged in the Missed Calls list. Do Not Disturb can be set on a line-by-line basis if multiple lines are in use.

Enable

1. Press  to prevent the phone from ringing when there is an incoming call. A flashing *X* appears beside the line indicator on the display.

Disable

1. Press  again to disable it.

Shared Call Appearance

Multiple Lines

The SoundPoint IP 600 SIP phone supports up to six lines that can be configured for private or shared use. Typically, the top-most line key is reserved for the principle directory number of the phone. Depending on how your phone is configured, the display would resemble one of the examples below:

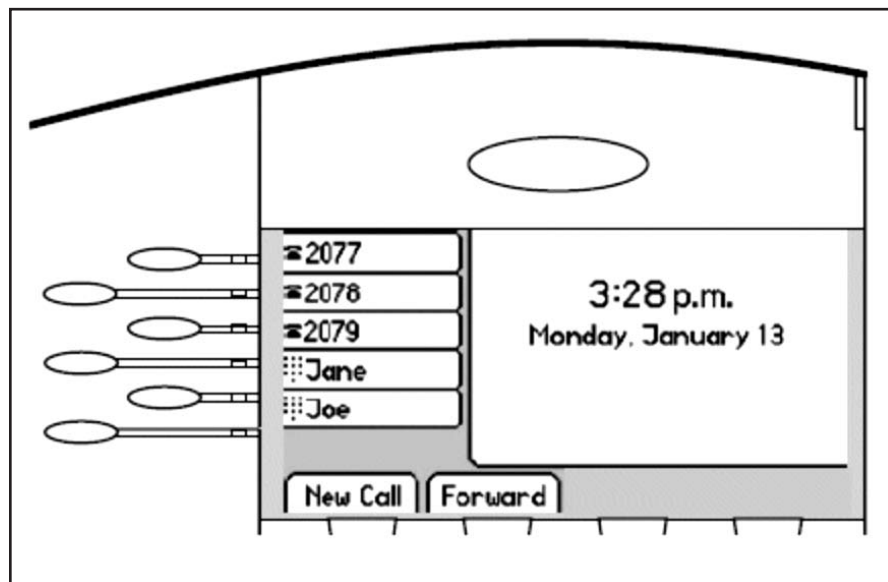
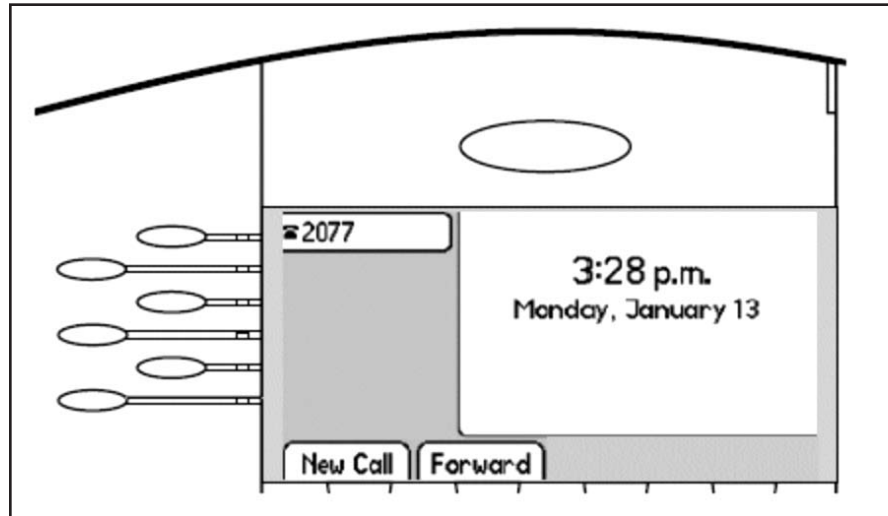

Multiple Keys Per Line

Each line on the phone can be configured to have more than one line key associated with it. In this case, the display would look like the following:

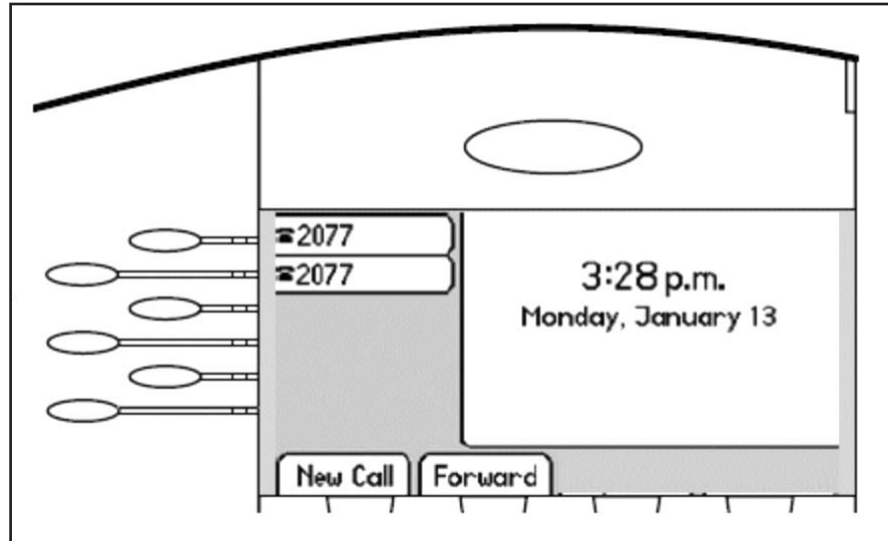

Multiple Call Appearance

Each line on the phone can be configured to have one or more call appearances. More than one call appearance is useful if there is an active call and an incoming call rings on the same line. In the first example on the right, extension 9301 is in an outbound call with 9304. The second example shows an incoming call from John Brown. To answer the call, put the original call on hold or press the  key to access the new call. Softkey labels are updated on the display with the following options:

- **Answer** the incoming call. This places the original call on hold and refreshes the softkey labels as shown in the third example. If more than two call appearances are in use, two appear on the display and the total number is indicated by a counter at the bottom right corner of the display. For example, "2/3" indicated that the highlighted call is the second one out of a total of three.
- **Reject** the incoming call.
- **Forward** the incoming call to another extension.

In the example, another outbound call can be placed on the same first line.

1. Press **Hold** during the first call.
2. Press **NewCall** to obtain a dial tone and a new call appearance for a second call.

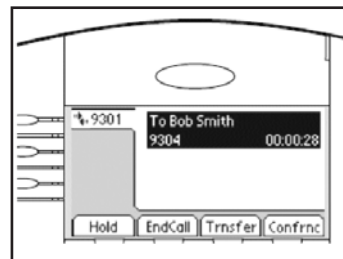

Example 1

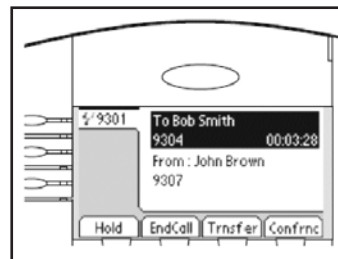

Example 2

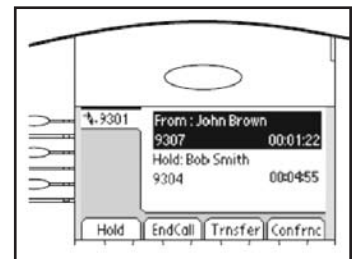

Example 3

Shared Lines

A shared line is indicated by a different line icon. In the example below, the first line is private and the second line is shared. An incoming call to that number causes both phones to ring if two phones share a line. The call can be answered on either phone but not both. If a shared line is in use on one of the phones, it cannot be used on the other one. The shared line icon changes to a moving icon, and the line LED turns red when it is in use remotely. Calls on shared lines can be transferred, put on hold, or added to a conference.

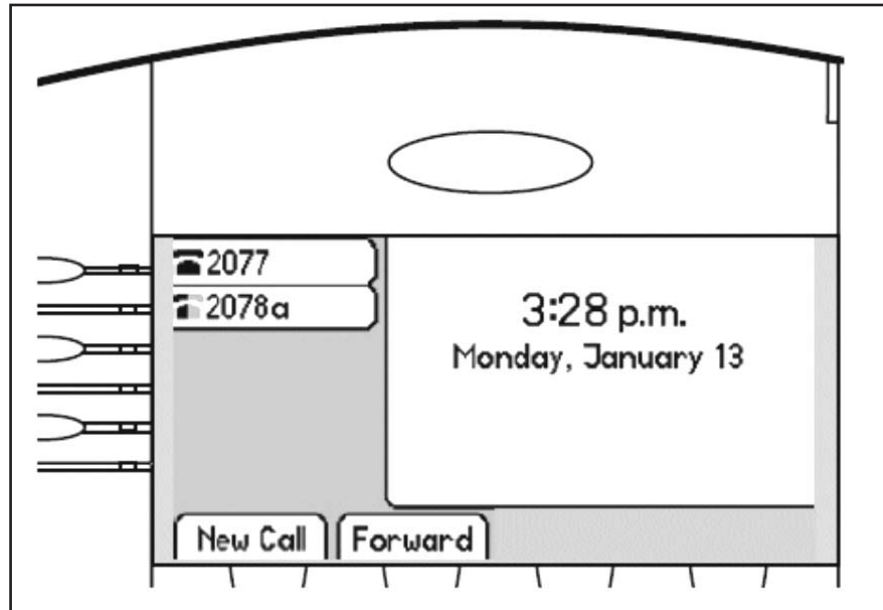

Some text is missing here.

Access Voice Mail

Received messages are indicated by a flashing Message Waiting Indicator LED on the front of the phone. Individual line indicators reflect voice or text messages left on that line (useful if multiple lines are in use). A stutter dial tone in place of a normal dial tone also indicates that one or more voice messages are in your message center.

Listen to Messages

1. Press **Messages**.
2. Select **Message Center**.
3. Select the line you want to retrieve messages from if multiple lines are in use. The display indicates the number of messages and their importance.
4. Press **Connect** to retrieve messages.

-or-

1. Press **Clear** to turn off the flashing LED without listening to messages.
2. Follow the voice prompts to listen to messages.



Free Manuals Download Website

<http://myh66.com>

<http://usermanuals.us>

<http://www.somanuals.com>

<http://www.4manuals.cc>

<http://www.manual-lib.com>

<http://www.404manual.com>

<http://www.luxmanual.com>

<http://aubethermostatmanual.com>

Golf course search by state

<http://golfingnear.com>

Email search by domain

<http://emailbydomain.com>

Auto manuals search

<http://auto.somanuals.com>

TV manuals search

<http://tv.somanuals.com>