

HDTV Monitor
with Pixel Plus™

Your Television's Directions for Use

55PP9753

60PP9753

- Pixel Plus™
- Digital Natural Motion™
- Philips HD Optics
- Active Control™ with ambient light sensor
- APAC™—Automatic Phosphor Aging Compensation
- Auto IntelliSense™ Focus
- HD DVI and Component inputs
- Dolby® Virtual Surround

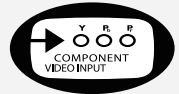

PHILIPS

Return your Warranty Registration card today to ensure you receive all the benefits you're entitled to.

Once your PHILIPS purchase is registered, you're eligible to receive all the privileges of owning a PHILIPS product. So complete and return the Warranty Registration Card enclosed with your purchase at once. And take advantage of these important benefits.

Warranty Verification

Registering your product within 10 days confirms your right to maximum protection under the terms and conditions of your PHILIPS warranty.

Owner Confirmation

Your completed Warranty Registration Card serves as verification of ownership in the event of product theft or loss.

Model Registration

Returning your Warranty Registration Card right away guarantees you'll receive all the information and special offers which you qualify for as the owner of your model.

Congratulations on your purchase, and welcome to the "family!"

PHILIPS



Dear PHILIPS product owner:

Thank you for your confidence in PHILIPS. You've selected one of the best-built, best-backed products available today. And we'll do everything in our power to keep you happy with your purchase for many years to come.

As a member of the PHILIPS "family," you're entitled to protection by one of the most comprehensive warranties and outstanding service networks in the industry.

What's more, your purchase guarantees you'll receive all the information and special offers for which you qualify, plus easy access to accessories from our convenient home shopping network.

And most importantly, you can count on our uncompromising commitment to your total satisfaction.

All of this is our way of saying welcome—and thanks for investing in a PHILIPS product.

Sincerely,

Lawrence J. Blanford
President and Chief Executive Officer

P.S. Remember, to get the most from your PHILIPS product, you must return your Warranty Registration Card within 10 days. So please mail it to us right now!

Know these
safety symbols



This "bolt of lightning" indicates uninsulated material within your unit may cause an electrical shock. For the safety of everyone in your household, please do not remove product covering.

The "exclamation point" calls attention to features for which you should read the enclosed literature closely to prevent operating and maintenance problems.

WARNING: TO PREVENT FIRE OR SHOCK HAZARD, DO NOT EXPOSE THIS EQUIPMENT TO RAIN OR MOISTURE.

CAUTION: To prevent electric shock, match wide blade of plug to wide slot, and fully insert.

ATTENTION: Pour éviter les chocs électriques, introduire la lame la plus large de la fiche dans la borne correspondante de la prise et pousser jusqu'au fond.

PHILIPS Visit our World Wide Web Site at <http://www.philips.com>

IMPORTANT SAFETY INSTRUCTIONS

Read before operating equipment

1. Read these instructions.
2. Keep these instructions.
3. Heed all warnings.
4. Follow all instructions.
5. Do not use this apparatus near water.
6. Clean only with a dry cloth.
7. Do not block any of the ventilation openings. Install in accordance with the manufacturers instructions.
8. Do not install near any heat sources such as radiators, heat registers, stoves, or other apparatus (including amplifiers) that produce heat.
9. Do not defeat the safety purpose of the polarized or grounding-type plug. A polarized plug has two blades with one wider than the other. A grounding type plug has two blades and third grounding prong. The wide blade or third prong are provided for your safety. When the provided plug does not fit into your outlet, consult an electrician for replacement of the obsolete outlet.
10. Protect the power cord from being walked on or pinched particularly at plugs, convenience receptacles, and the point where they exit from the apparatus.
11. Only use attachments/accessories specified by the manufacturer.
12.  Use only with a cart, stand, tripod, bracket, or table specified by the manufacturer, or sold with the apparatus. When a cart is used, use caution when moving the cart/apparatus combination to avoid injury from tip-over.
13. Unplug this apparatus during lightning storms or when unused for long periods of time.
14. Refer all servicing to qualified service personnel. Servicing is required when the apparatus has been damaged in any way, such as power-supply cord or plug is damaged, liquid has been spilled or objects have fallen into apparatus, the apparatus has been exposed to rain or moisture, does not operate normally, or has been dropped.
15. This product may contain lead and mercury. Disposal of these materials may be regulated due to environmental considerations. For disposal or recycling information, please contact your local authorities or the Electronic Industries Alliance: www.eiae.org
16. **Damage Requiring Service** - The appliance should be serviced by qualified service personnel when:
 - A. The power supply cord or the plug has been damaged; or
 - B. Objects have fallen, or liquid has been spilled into the appliance; or
 - C. The appliance has been exposed to rain; or
 - D. The appliance does not appear to operate normally or exhibits a marked change in performance; or
 - E. The appliance has been dropped, or the enclosure damaged.
17. **Tilt/Stability** - All televisions must comply with recommended international global safety standards for tilt and stability properties of its cabinet design.
 - Do not compromise these design standards by applying excessive pull force to the front, or top, of the cabinet which could ultimately overturn the product.
 - Also, do not endanger yourself, or children, by placing electronic equipment/toys on the top of the cabinet. Such items could unsuspectingly fall from the top of the set and cause product damage and/or personal injury.
18. **Wall or Ceiling Mounting** - The appliance should be mounted to a wall or ceiling only as recommended by the manufacturer.
19. **Power Lines** - An outdoor antenna should be located away from power lines.
20. **Outdoor Antenna Grounding** - If an outside antenna is connected to the receiver, be sure the antenna system is grounded so as to provide some protection against voltage surges and built up static charges.

Section 810 of the National Electric Code, ANSI/NFPA No. 70-1984, provides information with respect to proper grounding of the mast and supporting structure, grounding of the lead-in wire to an antenna discharge unit, size of grounding connectors, location of antenna-discharge unit, connection to grounding electrodes, and requirements for the grounding electrode. See Figure below.
21. **Object and Liquid Entry** - Care should be taken so that objects do not fall and liquids are not spilled into the enclosure through openings.

Note to the CATV system installer: This reminder is provided to call the CATV system installer's attention to Article 820-40 of the NEC that provides guidelines for proper grounding and, in particular, specifies that the cable ground shall be connected to the grounding system of the building, as close to the point of cable entry as practical.

Example of Antenna Grounding as per NEC - National Electric Code

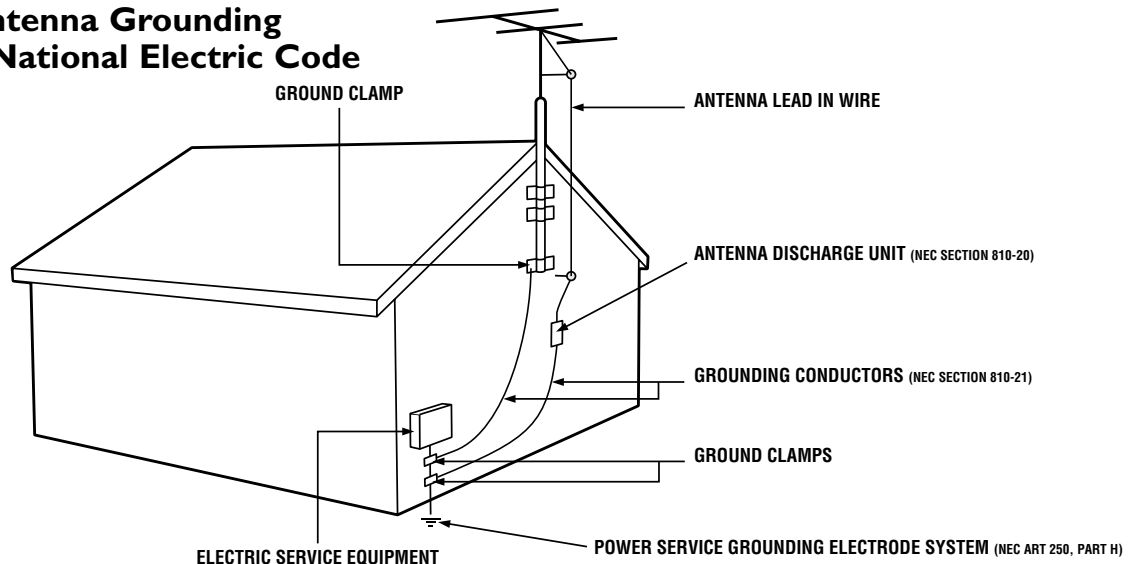

Contents

INTRODUCTION

Welcome/Registration of Your TV	2
Safety/Precautions	3
Features	5

CONNECTING ACCESSORY DEVICES TO YOUR TV

Descriptions of Jacks, Cables, and Connectors	6
Panel Jack Compatibility Information	7
Preconnection Recommendations	8
Connecting a VCR	9
Connecting a VCR and Cable Box	10
Connecting an S-Video Device	11
Connecting a Standard DVD Player	12
Connecting a Progressive-scan DVD Player	13
Connecting an HD Satellite Receiver to Y Pb Pr	14
Setting Color Space for HD input-AV 3	15
Connecting an HD Satellite Receiver to DVI	16
Connecting Surround Sound Equipment	17
Connecting to the Side Inputs: Video Game System	18
Labeling the Audio/Video Input Sources	19

USING THE REMOTE CONTROL

Programming the Remote Control	20–21
Programming the Remote Control: Set-up Codes	22–23
Operating Accessory Devices with the TV Remote	24–26
Using Active Control™ Plus+	27
Using AutoPicture	28
Using Active Display	29

USING THE ON-SCREEN MENUS

PICTURE

Adjusting/Setting the Picture Controls	30
Selecting a Digital Processing Option	31
Selecting a Dynamic Contrast Option	32
Selecting a DNR (Dynamic Noise Reduction) Option	33
Turning on Color Enhancement	34
Selecting a Picture Format Option	35–36

SOUND

Selecting an AutoSound™ Option	37
Selecting a TV Equalizer Option	38
Adjusting the TV and Headphone Volume	39
Turning Loudness on or off	40
Adjusting TV Speaker Balance	41
Selecting a Sound Mode Option	42

Using Alternate Audio (SAP)	43
Setting the TV for Stereo Programming	44
Turning the AVL (Audio Volume Leveler) on or off	45
Adjusting the Delta Volume	46
Adjusting TV Speakers and Audio Out	47



FEATURES

Setting the Sleptimer	48
Setting the On Timer	49
Using Zoom	50

CHANNELS

Using the Channel List	51
Removing Channels from the Channel List	52
Using Lock Channel	53
Using Lock After	54
Blocking Programming Based on TV Ratings	55
Blocking Programming Based on Movie Ratings	56
Turning the Antenna Attenuator on or off	57

GENERAL

Turning the Menu Background on or off	58
Using Surf	59
Selecting a PIP Format	60
Changing Channels or Input Sources in Dual Screen/PIP	61
Selecting a Picture Freeze Option	62
Resetting the Audio/Video Settings to Factory Default Values	63
Selecting Closed Captioning Option	64
Selecting an On-screen Display Option	65
Setting up or Changing a PIN (Personal Identification Number)	66
Setting the Clock—Auto Clock mode	67
Setting the Clock Manually	68
Selecting a Time Zone and Setting the Daylight Savings Control	69
 Manual Convergence	70
 Manual Convergence, Multipoint	71

ADDITIONAL INFORMATION

Cleaning the TV	72
Troubleshooting	73
Index	74
Factory Service Locations	75–76
Limited Warranty	80

Features

Pixel Plus™

Get more! More detail, more texture, more resolution, more high-definition-like images from any source. By doubling the number of lines and the number of pixels per line, Pixel Plus™ will take your viewing to new levels of enjoyment. Pixel Plus™ is only from Philips.

Digital Natural Motion™

Eliminates motion jitter from film-based sources such as DVDs for distortion-free, natural viewing.

Philips HD Optics

The Philips HD Optics gives extreme resolution HD with cutting-edge processing and display technology. Includes Philips wideband video amplifier, microphosphor CRTs, hybrid projection lenses, first-surface mirror, and fine-pitched lenticular screen.

Active Control Plus™

By continually adjusting picture settings over 60 times per second, Active Control Plus™ ensures that the viewing experience is always optimal. Changes in ambient light are even compensated for!

APAC—Automatic Phosphor Aging Compensation

Stationary images, particularly black bars that outline 4:3 programming on a widescreen TV, could eventually leave an after-image on the screen. APAC automatically shifts the image, just enough to blur after-image retention, which reduces the effect of stationary images.

Auto IntelliSense™ Focus

Automatically adjust picture convergence at the push of a button. Auto IntelliSense™ Focus responds to the natural and man-made magnetic field conditions where the projection TV is located, so you can easily enjoy a well-converged picture.

Dolby* Virtual Surround

Dolby processing circuitry for enhanced surround sound effect creates the sensation of Dolby Pro Logic without the hassle of additional rear speakers.

HD DVI and Component Inputs

DVI supports High-definition Copy-protected digital video input for connection to compliant set-top boxes. HD component connection (Y Pb Pr or RGB + HV) offers color purity, crisp color detail, and reduced color noise.

Items Included with This TV

As you unpack your TV, please note the included items:

- *Quick Use and Setup Guide* to help you set up your new TV.
- *Directions for Use* manual—contains information on safety, set maintenance, Factory Service Center locations, and product warranty
- Warranty Registration Card
- Remote Control (with supplied batteries).

Please take a few minutes to complete your registration card. The serial number for the TV is on the rear of the set. For your future reference, please write down the serial and model number of this television in the space provided on the warranty page at the back of this manual. (In the unlikely event you should need to place a service call, these numbers will be needed.)

End-of-Life Disposal

Your new television and its packing contain materials that can be recycled and reused. Specialized companies can recycle your product to increase the amount of reusable materials and minimize the amounts that need to be properly disposed of. Your product also uses batteries that should not be thrown away when depleted, but should be handed in and disposed of as small chemical waste.

When you replace your existing equipment, please find out about the local regulations regarding disposal of your old television, batteries, and packing materials.



As an Energy Star® Partner, Philips Consumer Electronics has determined this product meets the Energy Star® guidelines for energy efficiency.

Energy Star® is a U.S. registered mark. Using products with the Energy Star® label can save energy. Saving energy reduces air pollution and lowers utility bills.

*Manufactured under license from Dolby Laboratories. "Dolby", "Pro Logic" and the double-D symbol are trademarks of Dolby Laboratories.

Active Control, APAC, Digital Natural Motion, IntelliSense, and Pixel Plus are trademarks of Philips Consumer Electronics. Copyright 2003 Philips Consumer Electronics. All rights reserved.



Descriptions of Jacks, Cables, and Connectors

This page contains descriptions and illustrations of jacks, cables, and connectors you might use in making connections. The cables and connectors are not supplied with your TV, but you can purchase at your electronics dealer. Or you can order them by calling our Customer Care Center at 1-800-531-0039.

DVI-D Input Jack

Cable used: DVI-D

This jack works only with DVI TMDS (Transition Minimized Differential Signaling) digital video. Allows encrypted transmissions of uncompressed digital content. The DVI-D jack used in this product is not for computer connections.

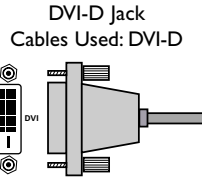

Signal Splitter

Allows you to route an antenna or cable TV signal to two inputs.

Signal Splitter
Cables Used: RF Coaxial (75Ω)

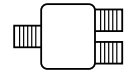

Component Video Input Jacks

Cables used: component video with RCA-type phono plugs

Allow you to connect accessory devices such as DVD players. Separating the video into three signals, these inputs provide excellent quality. Be sure to connect the left and right audio cables, because the Y, Pb, Pr jacks receive only the picture signal.

NOTE: See the "Helpful Hint" on page 12 for more information.

Component Video Jacks
Cables Used: Component Video with RCA-type Phono Plugs

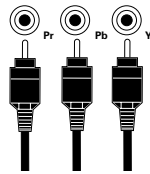

300- to 75-ohm Twin-lead Adapter

Accepts twin-lead wires from an antenna and allows connection to the antenna input on the TV. If your antenna is already equipped with an RF coaxial cable you will not need this adapter.

300- to 75-ohm
Twin-lead Adapter

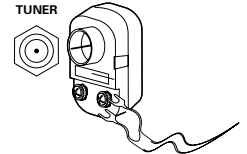

S-Video Input Jacks

Cable used: S-Video

Provide a higher quality picture than the Video (composite) jacks because the color part of the picture is separated from the black and white portion. Be sure to connect the left and right audio cables, because the S-Video jacks receive only the picture signal.

S-VIDEO Jack
Cable Used: S-Video

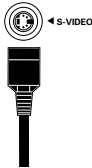

Audio Input Jacks

Cables used: Audio with RCA-type phono plugs

Provide sound for the video inputs. If your accessory device has only one output for audio, connect it to the left (color coded white) audio jack on the TV.

Your TV also has monitor output ("MON OUT") audio ("L" and "R") jacks and a subwoofer output ("SUB OUT") jack. Use an audio cable with RCA-type phone plugs to make connections.

Audio Jacks
Cables Used: Audio with RCA-type Phono Plugs

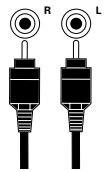

Video (called "CVBS" or "composite") Input Jacks

Cable used: Video with RCA-type phono plugs

Provide better picture performance than the antenna RF input. Be sure to connect the audio cables, because the video jacks receive only the picture signal.

Your TV also has a monitor output ("Output") video ("V") jack. Use a video cable with RCA-type phono plugs to make connections.

Video (Composite) Jack
Cable Used: Video with RCA-type Phono Plugs



3.5mm Stereo Mini Phone Plug to RCA Jack Adapter

Allows a connection between the 3.5mm stereo audio out jack on a computer and the left and right audio inputs on the television. Connect A/V cables with RCA-type phono plugs to the adapter, then to the TV.

3.5mm Stereo Mini Phone Plug to RCA Jack Adapter

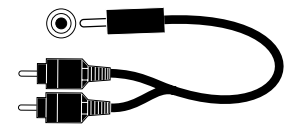

Center Channel Amp Speaker Terminals (+ and -)

Allow a connection from a surround sound receiver. Set the EXT/INT switch to EXT to use the TV speakers as the center speakers in a surround sound arrangement.

Center Channel Amp Speaker Terminals (for the connection of speaker wires)

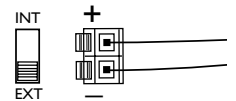

Tuner (RF) Input Jack

Cables used: RF coaxial cable (75Ω)

Allows you to connect an antenna, cable TV, or components having RF outputs to the antenna input on the TV. RF coaxial cables are available in push-on or screw-on type.

Antenna RF Jack
Cable Used: RF Coaxial (75Ω)

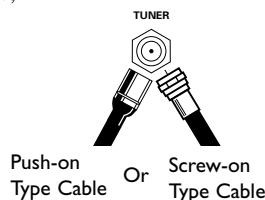

Panel Jack Compatibility Information



1 ANTENNA IN 75Ω Input Jack
Signals accepted: NTSC (480i).
Inputs available: 75Ω RF coaxial.
 This is for antenna or cable RF input.

2 INPUT-AV 1/Component Video (CVI) Jacks
Signals accepted: NTSC (480i).
Inputs available (three types): Y Pb Pr (component video), S-Video (super video), or Video (composite), plus audio left and right.
 Only one of the types of video inputs should be used at a time. For either an S-Video or Video connection, select the AV1 source in the on-screen display. For a Y Pb Pr connection, select CVI. For sound, connections must be made to the INPUT-AV1 audio inputs.

3 INPUT-AV 2 Jacks
Signals accepted: NTSC (480i).
Inputs available (two types): S-Video (super video) or Video (composite), plus audio left and right.
 Only one of the types of video inputs should be used at a time. For either an S-Video or Video connection, select the AV2 source in the on-screen display. For sound, connections must be made to the INPUT-AV 2 audio inputs.

4 HD INPUT-AV 3 Jacks
Signals accepted: 480p and 1080i, plus audio left and right.
Inputs available (two types): Y Pb Pr (component video) or RGB+HV sync, plus audio.
 For sound, connections must be made to the HD INPUT-AV 3 audio inputs.

5 HD INPUT-AV 4 Jacks
Signals accepted: Digital only (TMDS [Transition Minimized Differential Signaling] encoded, uncompressed); DVI 480p and 1080i, plus audio left and right.
Inputs available: DVI TMDS, plus audio.
 For sound, connections must be made to the HD INPUT-AV 4 audio inputs.

6 OUTPUT Jacks
 Provide video and left/right audio output signals from the input source currently being viewed on screen, except for HD INPUT-AV 3 or AV 4. When HD INPUT-AV 3 or AV 4 is used, only the audio is available through the OUTPUT audio L/R jacks. The OUTPUT audio is at a fixed volume level; changing the TV volume does not affect them. Adjust the volume at your external home cinema system.

7 CENTER CHANNEL AMP INPUT Click-fit Terminals
 Provides speaker-wire input terminals for connection of an external home-cinema surround-sound system amplifier. For this use, set the switch to "EXT," and the TV speakers become the center speakers for the home-cinema surround-sound system.
NOTE: If no audio is heard from the set, check to make sure the Center Channel Amp switch is in the INT position. This switch should be in the EXT position only when an external center channel input is connected to the Click-fit Terminals.

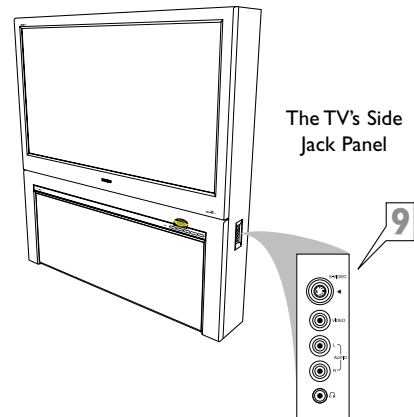
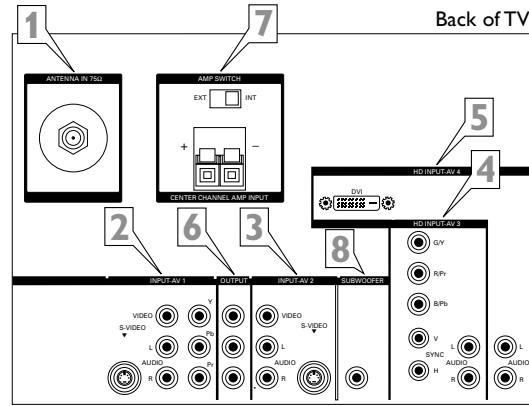

Why So Many Types of Inputs?

As better-quality signals have become available, new inputs have been designed into accessory devices (VCRs, DVD players, cable boxes, etc.) and TVs to carry them. The other inputs have been left in place to work with the installed base of older equipment. Here is a summary of the quality of signal offered by the different types of inputs:

Basic: ANTENNA IN 75Ω. May provide the only way to connect an antenna and some older cable boxes and VCRs.

Good: VIDEO (Composite) Input. A small step up in quality from the ANTENNA IN 75Ω input. Most cable boxes, VCRs, and DVD players have this type of connection.

Better: S-VIDEO (Super Video) Input. Separates the signal into color and brightness, improving image quality. Used with DVD players, digital cable boxes, satellite receivers, and some camcorders.

Best: Y Pb Pr (Component Video) Input. Carry potentially the best-quality signals. The video signal is split into three signals, two color and one brightness. Used primarily with DVD players.

8 SUBWOOFER
 Provides a signal to an external powered subwoofer.

9 SIDE JACK PANEL
Signals accepted: Analog NTSC (480i).
Inputs available (two kinds): S-Video (super video) and Video (composite), plus audio left and right.
Output available: Headphone.
 Only one of the inputs can be used at a time. Select the Side source, and the TV detects the input to which you have connected. For sound, connections must be made to the Side audio inputs.

HELPFUL HINT

Color Coding Used on Jacks and Plugs to simplify connections:
Yellow: VIDEO (Composite Video)
Green, Blue, Red: Y Pb Pr (Component Video)
Red: Right AUDIO
White: Left AUDIO.



Preconnection Recommendations

Before connecting accessory devices—VCR, DVD player, or HD satellite receiver, for example—please keep the following in mind.

Positioning the TV

- Allow 4 to 6 inches of space behind the TV for ventilation.
- Test various locations in the room to find the optimal spot to locate the set for best viewing.
- Do not place the TV in direct sunlight or near a heating appliance.
- Do not expose the TV to rain or moisture.
- To prevent any unsafe situations, do not place objects on top of the TV.

Providing Protection Against Power Surges

- Connect all accessory devices before you plug any of their power cords into the wall outlet or power strip. NEVER plug your TV into an outlet that is controlled by a wall switch.
- Turn off the TV and/or accessory devices before you connect or disconnect any cables.
- Ensure that all antennas and cables are properly grounded. See page 3, “Important Safety Instructions.”

Protecting Accessory Devices from Overheating

- Arrange accessory devices so that air can circulate freely around them.
- Don't stack the accessory devices. Arrange them to allow for good ventilation.
- If you connect an audio receiver or amplifier, place it on the top shelf so the heated air from it will not flow around other components.

Connecting Cables

Be sure to insert each cable firmly into the correct jack.

Using the Connection Examples in This Manual

The accessory device jack panels shown are for example purpose only. The jack panels on your accessory devices may look different. Also, note that connections can be made in various ways. The examples are presented only as guides.

For safety, do not set objects on top of the TV.

Situate the TV where it will not be exposed to heat or moisture.

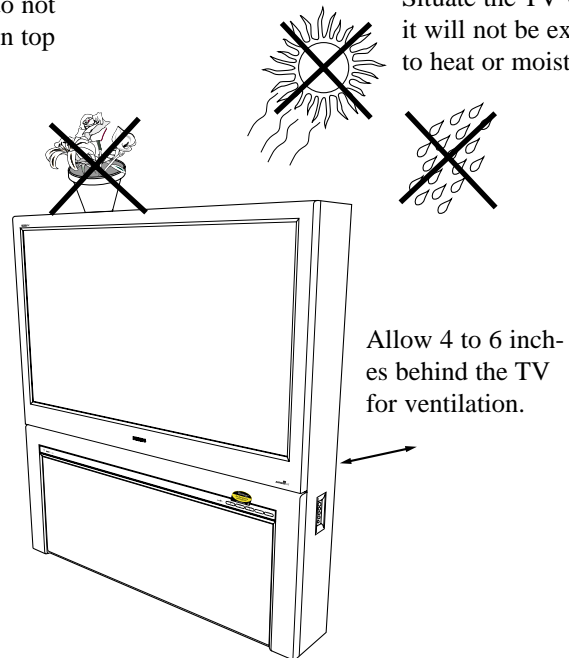

Connecting a VCR



- 1** Connect the incoming antenna or cable TV signal to the ANT IN jack on the back of the VCR.
- 2** Using a coaxial cable, connect the ANT OUT jack on the back of the VCR to the ANTENNA IN 75Ω jack on the back of the TV.
- 3** Using A/V cables, connect the AUDIO and VIDEO OUT jacks on the back of the VCR to the corresponding INPUT-AV 2 audio (L and R) and video (V) jacks on the back of the TV.
- 4** Press the Source button on the remote control to access the Source list.
- 5** Press the Cursor Up or Down button to select the AV2 input source.
- 6** Press the OK button to confirm your choice. The set is now switched to the AV2 input source for the viewing of programs from the VCR.

NOTE: Since you've connected the cable TV signal directly to the TV's tuner (step 2 above), you can watch the unscrambled programs by simply tuning to the desired channel. To store channels in the TV's memory, you must use Autoprogram, which you can access through "Install" in the TV's on-screen menu. See the Autoprogram section in the *Quick Use and Setup Guide* that came with the TV. If you use Autoprogram, you can select channels by pressing the CH + or - buttons on the TV remote control (in TV mode). Otherwise, you must press the digit (number) buttons to tune directly to the channel you desire.

Back of TV

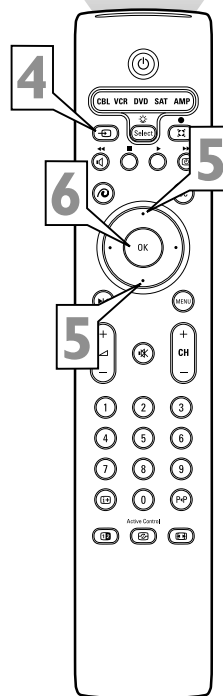
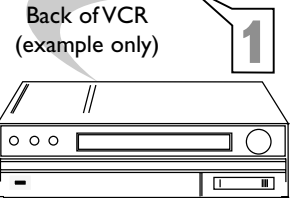
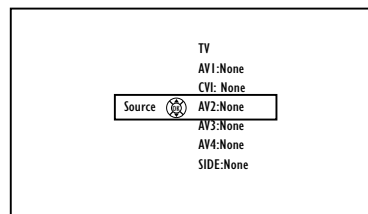
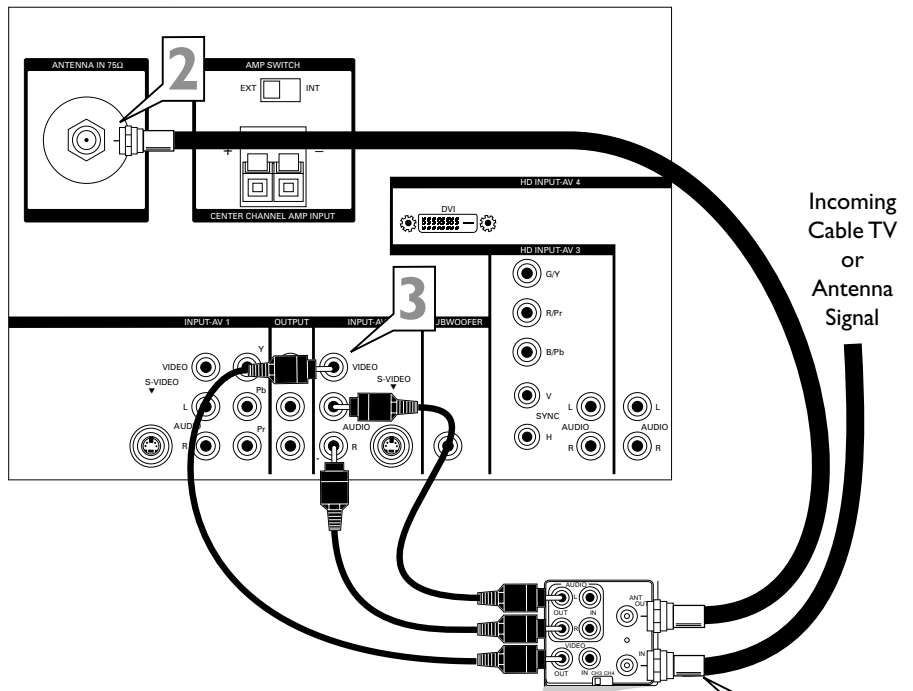

HELPFUL HINT

Color Coding Used on Jacks and Plugs to simplify connections:

- Yellow:** VIDEO (Composite Video)
- Red:** Right AUDIO
- White:** Left AUDIO.



Connecting a VCR and Cable Box

NOTE: A cable box with AUDIO OUT jacks such as the one used in the example on this page might pass stereo sound to the TV. Check with your cable TV company. The RF jack output jack on a cable box (commonly labeled “OUT TO TV,” “OUTPUT,” or “OUT”) will not pass stereo sound to your TV.

- 1** Connect the incoming cable TV signal to a two-way signal splitter. The signal splitter enables you to route the cable signal to the TV without using the OUT TO TV jack on the cable box, which will not pass stereo sound to the TV.
- 2** Using a coaxial cable, connect one of the connectors on the signal splitter to the ANTENNA IN 75Ω jack on the back of the TV.
- 3** Using a coaxial cable, connect the other connector on the signal splitter to the CABLE IN jack on the back of the cable box.
- 4** Using Audio/Video cables, connect the AUDIO and VIDEO OUT jacks on the back of the cable box and to the corresponding AUDIO and VIDEO IN jacks on the back of the VCR.
- 5** Using Audio/Video cables, connect the AUDIO and VIDEO OUT jacks on the back of the VCR to the corresponding AV2 audio (L and R) and video (V) input jacks on the back of the TV.
- 6** Press the Source button on the remote control to access the Source list.
- 7** Press the Cursor Up or Down button to select the AV2 input source.
- 8** Press the OK button to confirm your choice. The set is now switched to the AV2 input source for the viewing of programs from the cable box or the VCR.

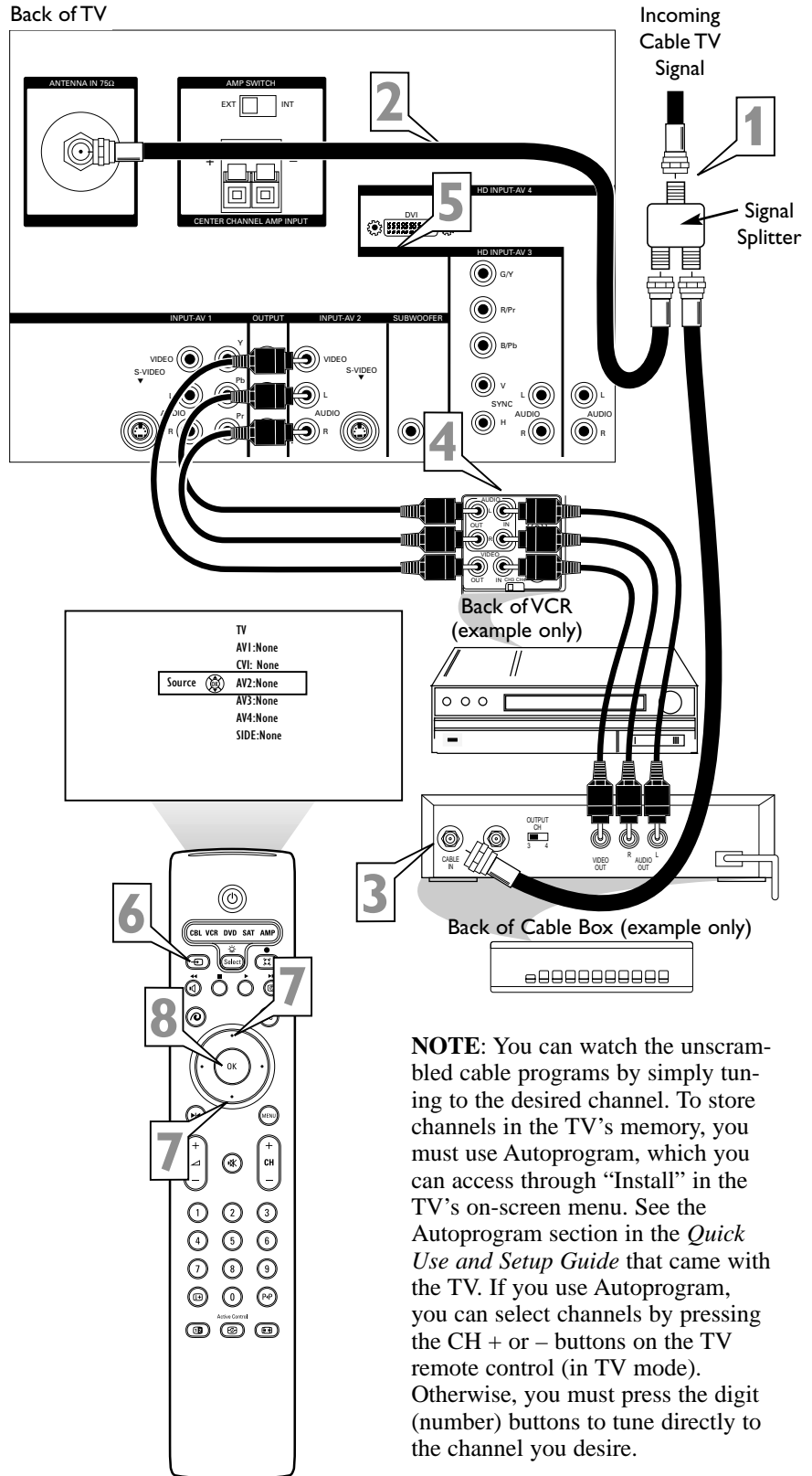

NOTE: You can watch the unscrambled cable programs by simply tuning to the desired channel. To store channels in the TV’s memory, you must use Autoprogram, which you can access through “Install” in the TV’s on-screen menu. See the Autoprogram section in the *Quick Use and Setup Guide* that came with the TV. If you use Autoprogram, you can select channels by pressing the CH + or – buttons on the TV remote control (in TV mode). Otherwise, you must press the digit (number) buttons to tune directly to the channel you desire.

HELPFUL HINT

Color Coding Used on Jacks and Plugs to simplify connections:

- Yellow:** VIDEO (Composite Video)
- Red:** Right AUDIO
- White:** Left AUDIO.

Connecting an S-Video Device



- 1** Using an S-Video cable, connect the S-Video output on the back of the S-Video device to the INPUT-AV 2 S-VIDEO input.
- 2** Using Stereo Audio cables, connect the AUDIO OUT jacks on the back of the S-Video device to the corresponding INPUT-AV 2 audio inputs (L and R).
- 3** Press the Source button on the remote control to access the Source list.
- 4** Press the Cursor Up or Down button to select the AV2 input source.
- 5** Press the OK button to confirm your choice. The set is now switched to the AV2 input source for the viewing of programs from the S-Video device.

Back of TV

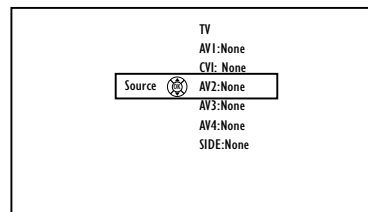
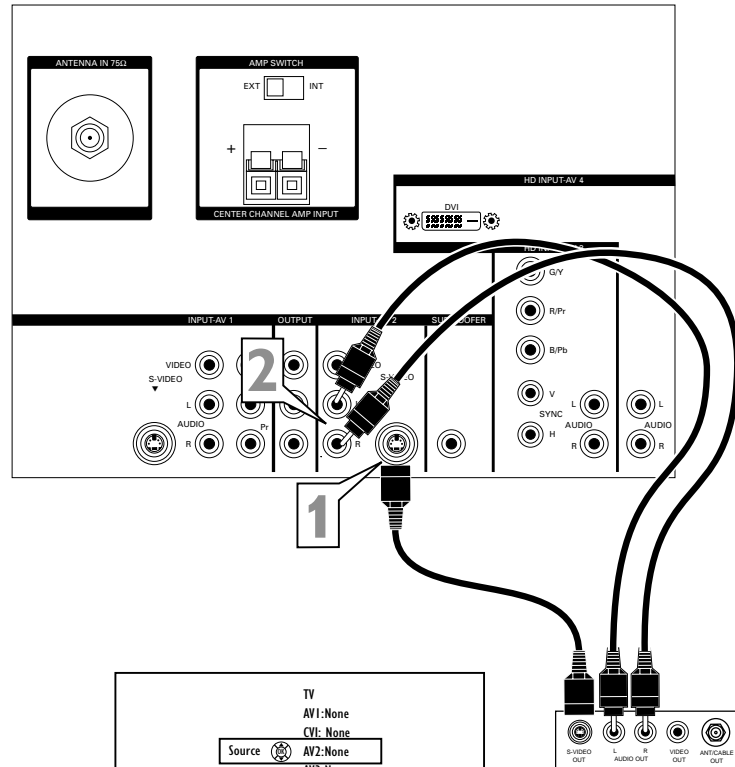

Back of Standard S-Video Device (example only)

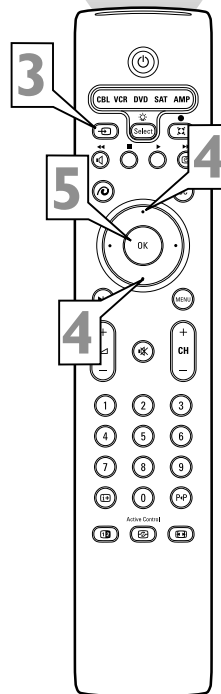

HELPFUL HINT

Color Coding Used on Jacks and Plugs to simplify connections:

Red: Right AUDIO

White: Left AUDIO.

An S-Video cable must be used to make the S-Video connection.

Connecting a Standard DVD Player

- 1** Using Audio/Video cables, connect the YPbPr jacks on the back of the standard DVD player to the Y Pb Pr jacks located under the INPUT-AV 1 label on the back of the TV.
- 2** Using Stereo Audio cables, connect the AUDIO OUT jacks on the back of the DVD player to the corresponding audio (L and R) jacks located under the INPUT-AV 1 label on the back of the TV.
- 3** Press the Source button on the remote control to access the Source list.
- 4** Press the Cursor Up or Down button to select the CVI (component video input) source.
- 5** Press the OK button to confirm your choice. The set is now switched to the CVI source for the viewing of programs from the DVD player.

HELPFUL HINTS

- To simplify making connections, the connectors on audio and video cables are often color coded to match the colors on TV jacks. Red for Right audio and White for Left audio.
- The names for the component video jacks may differ depending on the DVD player or accessory digital source equipment used. For example, besides Y Pb Pr, you may see R-Y/B-Y/Y; or Cr Cb Y. Although abbreviations and terms may vary, the letters *B* and *R* stand for the blue and red color component signal connectors, respectively, and *Y* indicates the luminance signal. If necessary, refer to the user manual for your DVD or digital accessory for more information.
- If you experience difficulties receiving sound with a DVD disc, check the sound settings through the DVD disc's menu.

Back of TV

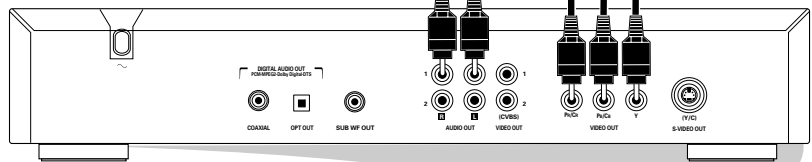
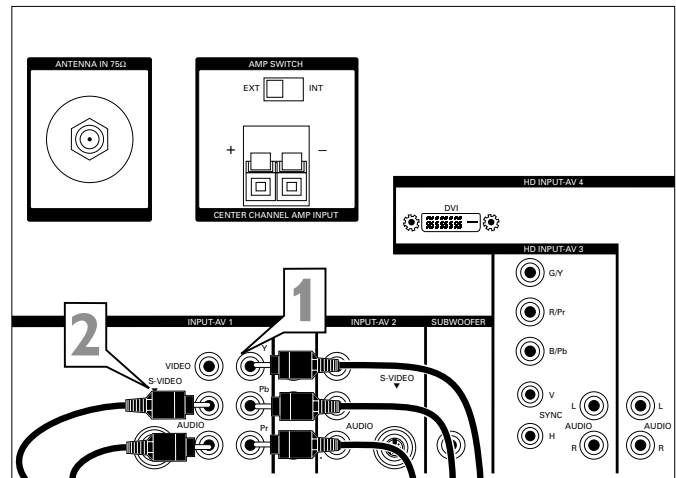

Back of Standard DVD Player (example only)

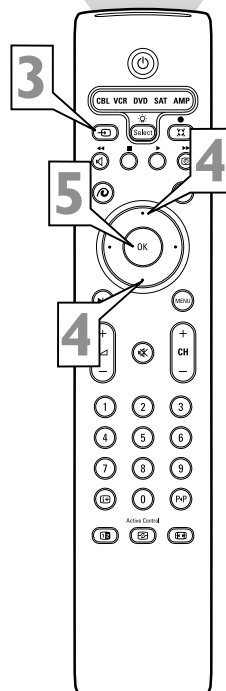
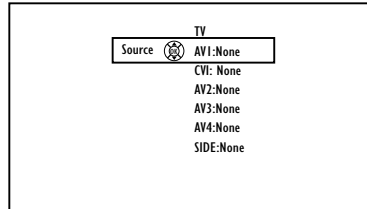

Connecting a Progressive-scan DVD Player



- 1** Using Audio/Video cables, connect the YPbPr jacks on the back of the progressive-scan DVD player to the HD INPUT-AV 3 Y Pb Pr jacks on the back of the TV.
- 2** Using Stereo Audio cables, connect the AUDIO OUT jacks on the back of the DVD player to the corresponding HD INPUT-AV 3 audio (L and R) jacks on the back of the TV.
- 3** If your DVD player has an I/P switch on the back, be sure it is set to the "P" position for progressive-scan mode. **NOTE:** Some DVD players have an I/P switch on the back, while others may allow the user to change the mode by pressing a button on the DVD player's remote control or by using the DVD player's on-screen menu. Also, some DVD players have dedicated progressive-scan output jacks that are labeled as such and require no switching by the user. See the user manual for your DVD player for more information on placing the player in progressive-scan mode.
- 4** Press the Source button on the remote control to access the Source list.
- 5** Press the Cursor Up or Down button to select the AV3 input source.
- 6** Press the OK button to confirm your choice. The set is now switched to the AV3 input source for the viewing of programs from the DVD player.

Back of TV

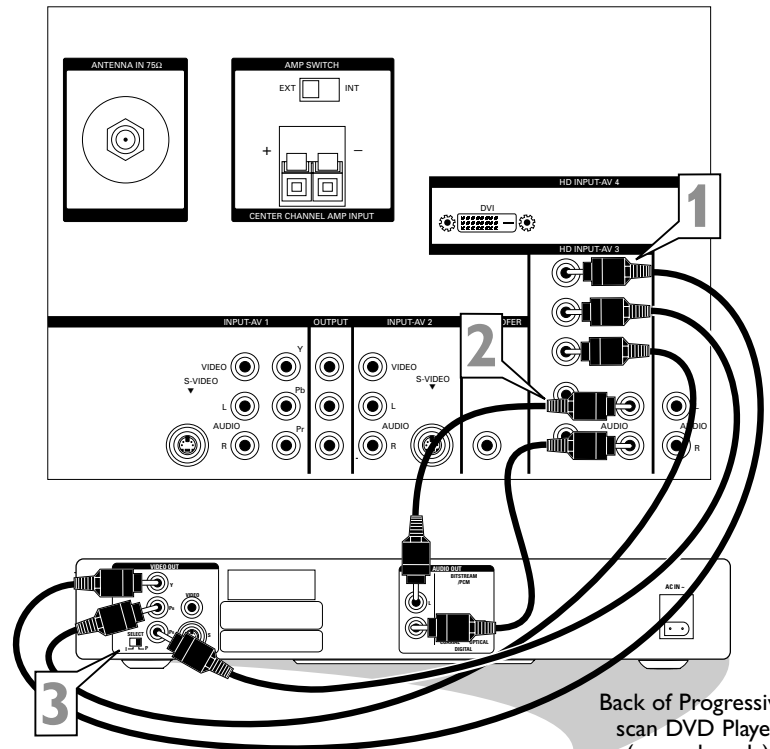

Back of Progressive-scan DVD Player (example only)

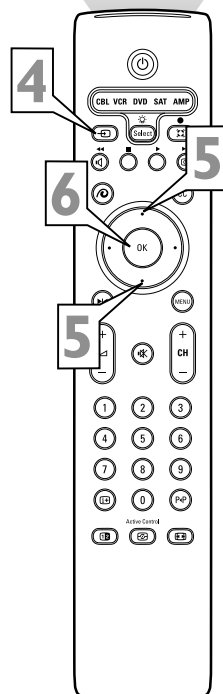
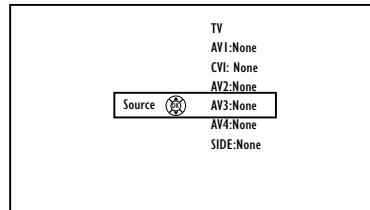

HELPFUL HINTS

- To simplify making connections, the connectors on audio and video cables are often color coded to match the colors on TV jacks.
- The names for the component video jacks may differ depending on the DVD player or accessory digital source equipment used. For example, besides Y Pb Pr, you may see R-Y/B-Y/Y; or Cr Cb Y. Although abbreviations and terms may vary, the letters *B* and *R* stand for the blue and red color component signal connectors, respectively, and *Y* indicates the luminance signal. If necessary, refer to the user manual for your DVD or digital accessory for more information.
- If you experience difficulties receiving sound with a DVD disc, check the sound settings through the DVD disc's menu.



Connecting an HD Satellite Receiver to Y Pb Pr

- 1** Using Component Video cables, connect the YPbPr jacks on the back of the HD satellite receiver to the corresponding AV3 YPbPr jacks on the back of the TV.
- 2** Using Stereo Audio cables, connect the AUDIO OUT jacks on the back of the HD satellite receiver to the corresponding AV3 audio (L and R) jacks on the back of the TV.
- 3** Refer to the user manual for the HD satellite receiver for information.
- 4** After completing HD satellite receiver connections and setup through the on-screen setup menus, press the Source button on the TV remote to access the Source list.
- 5** Press the Cursor Up or Down button to select the AV3 input source.
- 6** Press the OK button to confirm your choice. The set is now switched to the AV3 input source for the viewing of programs from the HD satellite receiver.

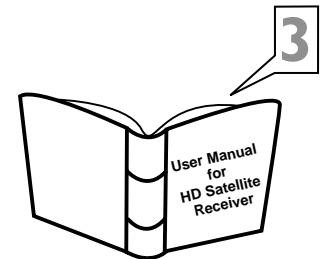
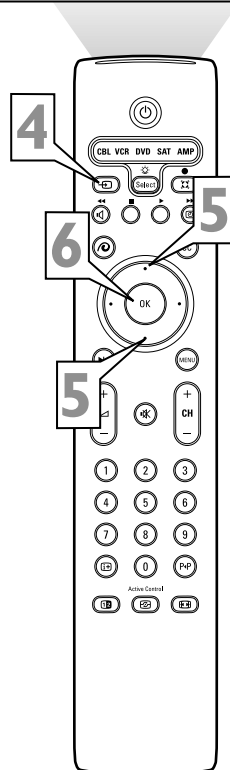
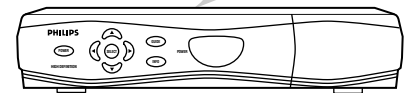
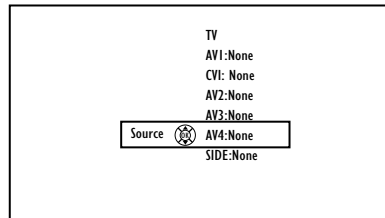
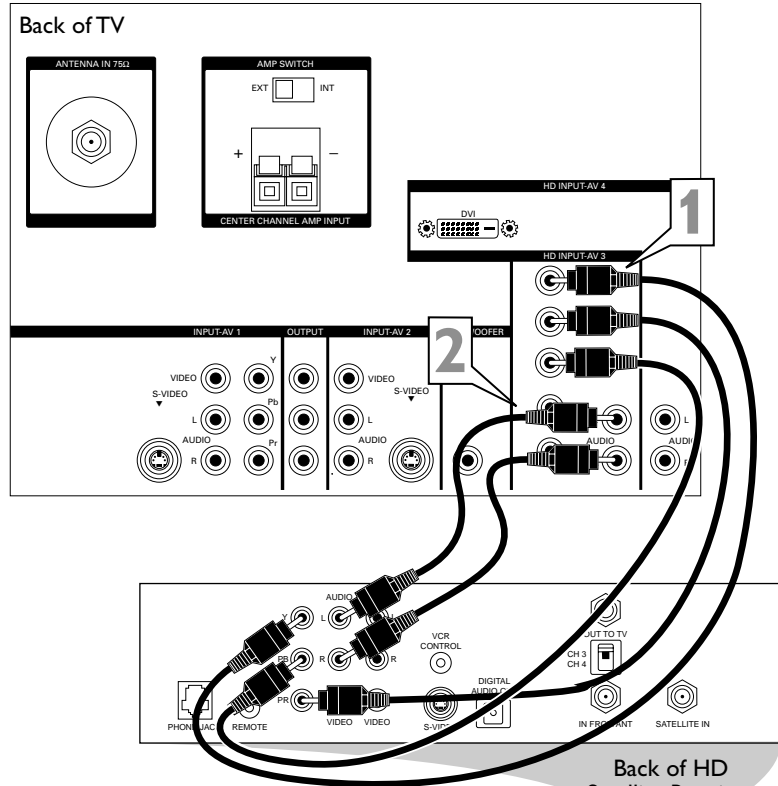

Setting Color Space for HD INPUT-AV 3



Color space refers to how colors are defined and appear on your TV. The INPUT-AV 3 color space needs to match the output of the accessory device you have connected to the output, either YPbPr or RGB. The default setting for HD INPUT-AV 3 is YPbPr. Change the setting to RGB if necessary for your accessory device.

- 1** Press the Menu button on the remote control to display the on-screen menu.
 - 2** Press the Cursor Down button to select "Settings."
 - 3** Press the Cursor Right button repeatedly to select the "Source" menu.
 - 4** Press the Cursor Down button repeatedly until "AV3 input" is selected. The current Color Space setting is highlighted.
- If you need to change the setting, press the Cursor Right button.
- 5** Press the Menu button to remove the on-screen menu from the TV screen.

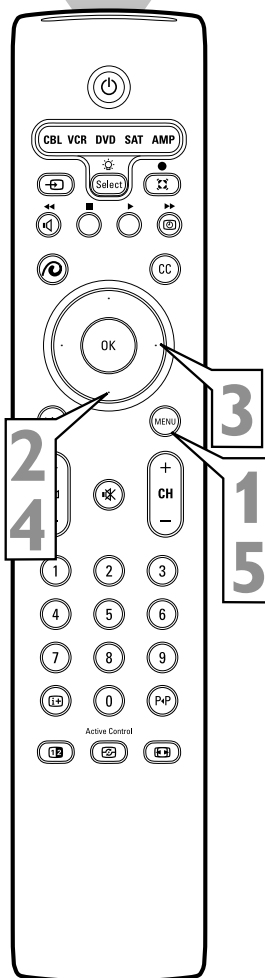
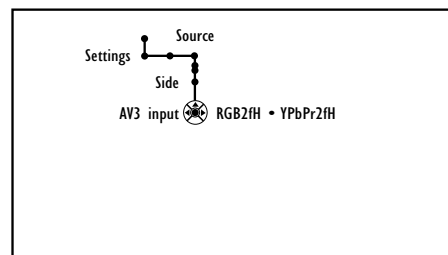
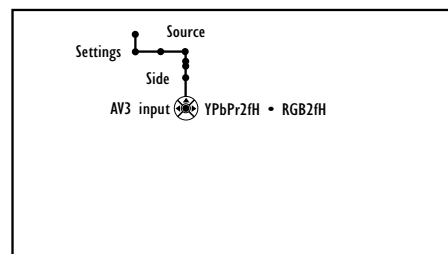
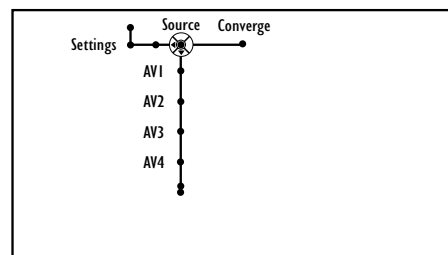
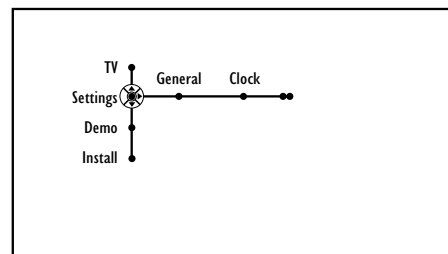
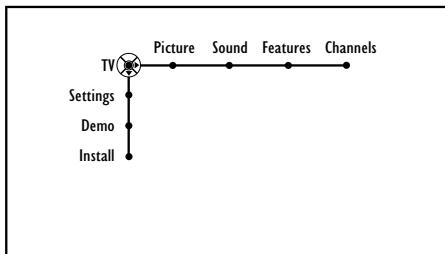



Connecting an HD Satellite Receiver to DVI

- 1** Using a DVI cable, connect the DVI jack on the back of the HD satellite receiver to the corresponding HD INPUT-AV 4 jack on the back of the TV.
- 2** Using Stereo Audio cables, connect the AUDIO OUT jacks on the back of the HD satellite receiver to the corresponding HD INPUT-AV 4 audio (L and R) jacks on the back of the TV.
- 3** Refer to the user manual for the HD satellite receiver for information.
- 4** After completing HD satellite receiver connections and setup through the on-screen setup menus, press the Source button on the TV remote to access the Source list.
- 5** Press the Cursor Up or Down button to select the AV4 input source.
- 6** Press the OK button to confirm your choice. The set is now switched to the AV4 input source for the viewing of programs from the HD satellite receiver.

Back of TV

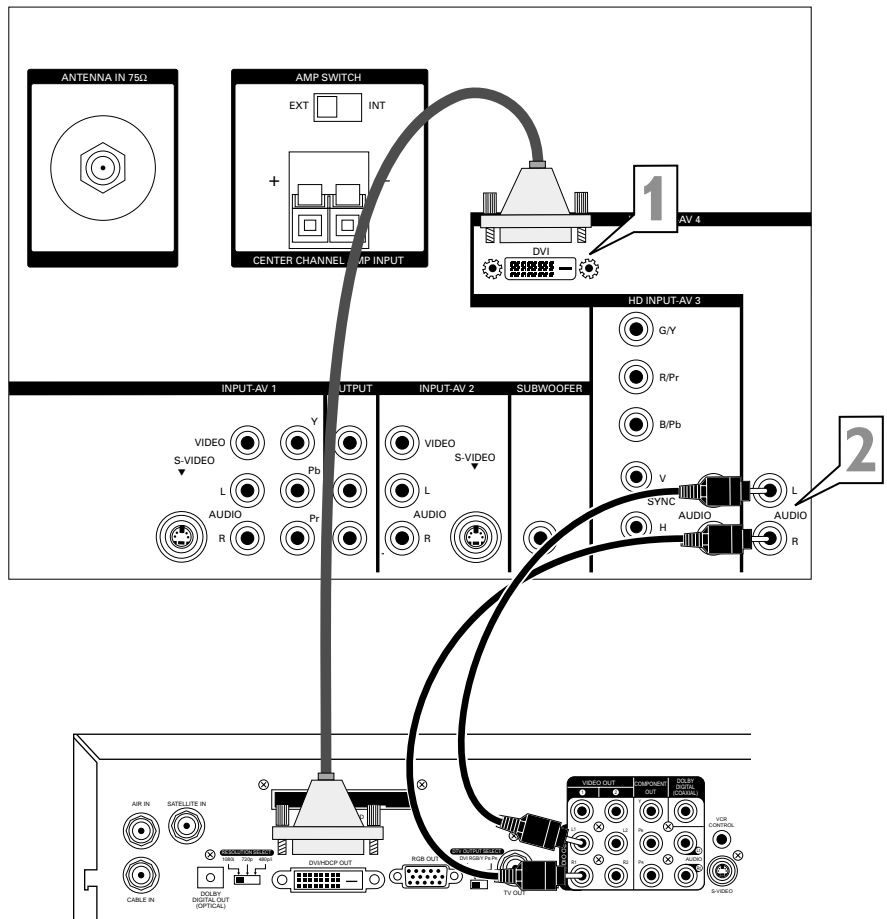

Back of HD Satellite Receiver (example only)

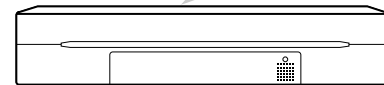

HELPFUL HINT

Because DVI is such new technology, the electronics industry is still working toward a single standard. Philips testing has determined that compatibility issues exist with respect to a limited number of high-definition receivers when they are connected to the DVI input on this television. If you should experience difficulties, please contact our Customer Care Center at 1-800-531-0039.

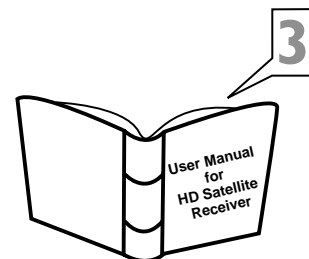
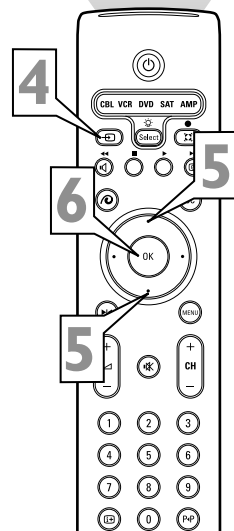
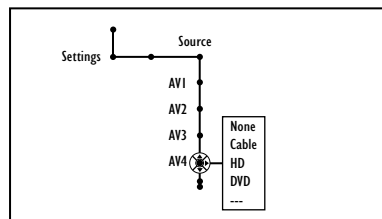

Connecting Surround Sound Equipment



- 1** Using speaker wires, connect the Center Speaker output terminals (+, -) on the back of the surround sound receiver to the corresponding (+, -) CENTER CHANNEL AMP terminals on the back of the TV.
- 2** Set the CENTER CHANNEL AMP INPUT switch to EXT. This allows the TV cabinet speakers to be used as the center speakers in a surround sound arrangement.
- 3** Using Stereo Audio cables, connect the MON OUT L and R jacks on the back of the TV to the corresponding TV IN jacks on the back of the receiver.
- 4** Using speaker wires, connect the R and L Front Speakers terminals to the corresponding terminals on the backs of the front speakers.
- 6** Using speaker wires, connect to the Surround Speakers terminals (+, -) on the back of the receiver and to the corresponding terminals (+, -) on the back of the surround speakers.

Back of TV

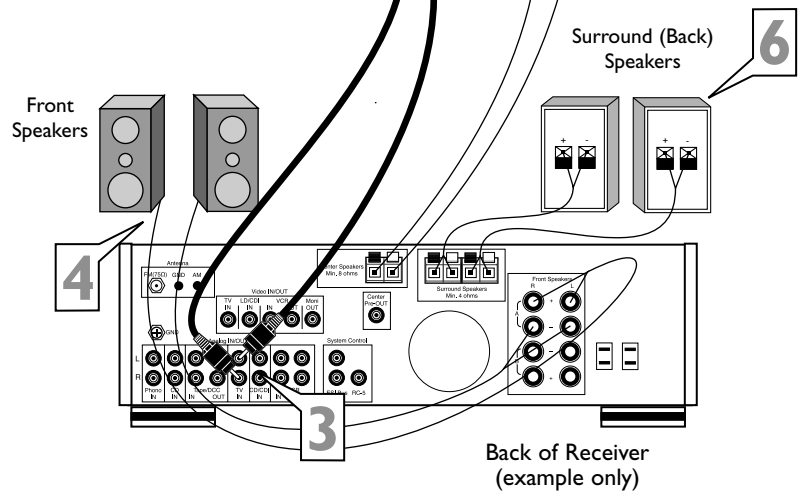
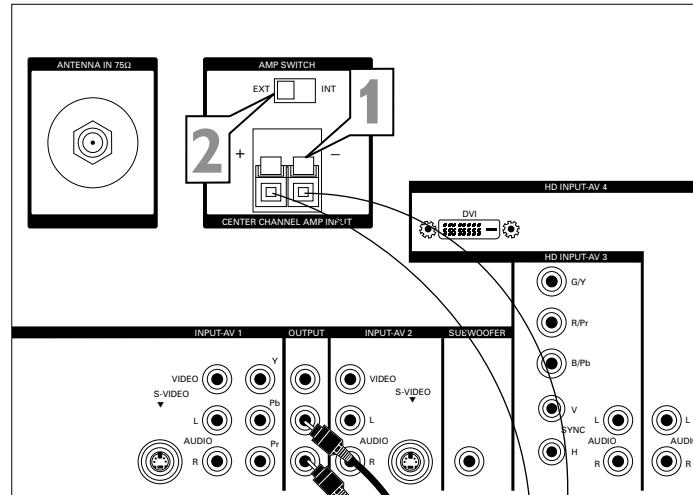

Using a Powered Subwoofer

You can connect a subwoofer to your TV to get a fuller, deeper sound.

- 1** Using an Audio Cable, connect the SUB OUT jack on the back of the TV to the Audio IN jack on the back of a powered subwoofer.

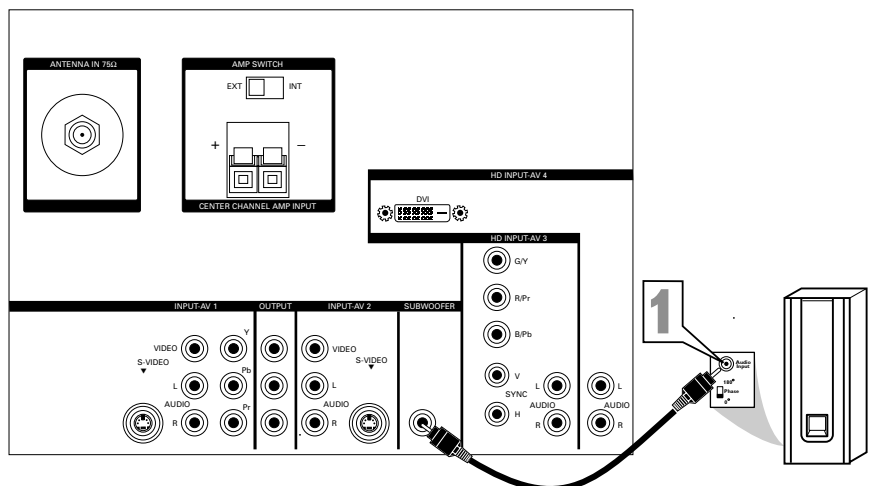



Connecting to the Side Inputs: Video Game System

- 1** Using the Audio/Video cable supplied with your video game system, connect to the back of the game system and to the corresponding S-VIDEO and AUDIO (L and R) jacks in the Side panel of the TV.
- 2** Press the Source button on the TV remote control to access the Source list.
- 3** Press the Cursor Up or Down button to select the Side input source.
- 4** Press the OK button to confirm your choice. The set is now switched to the Side input source for the viewing of your video game system.

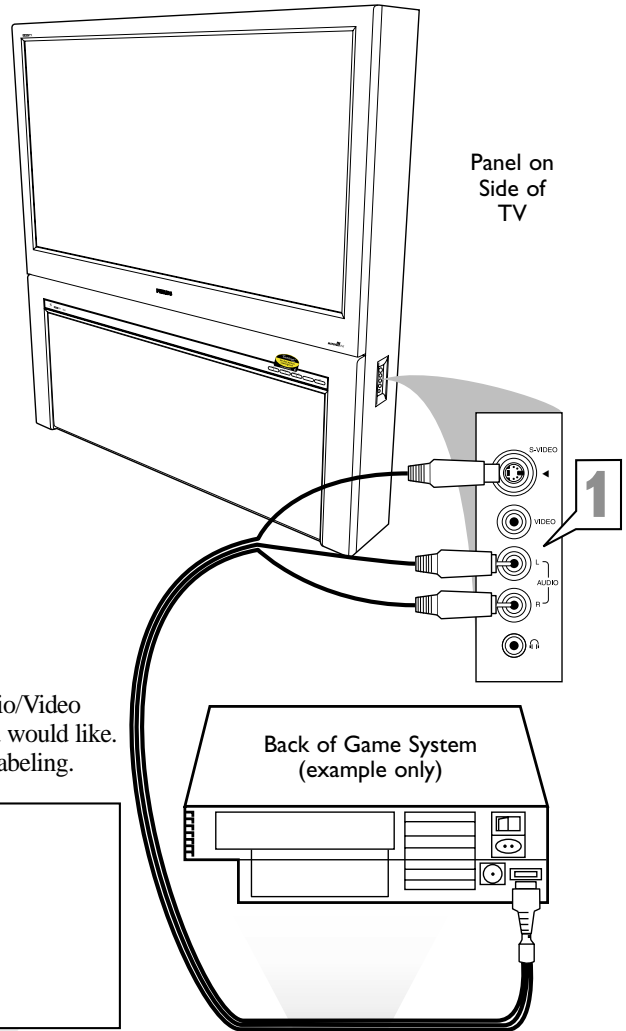

You can label the Side Audio/Video input source "Game" if you would like. See page 19 for details on labeling.

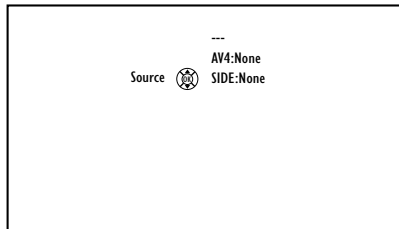

✓ CHECK IT OUT

You can press the Cursor Up or Down button to pan the screen up and down on your to see excluded parts of the picture. Use this feature with Super Zoom, Movie Expand 14:9, Movie Expand 16:9, and 16:9 Subtitle. See pages 35-36 for details on using the Picture Format options.

Left and right panning is possible with the Side input source when the source has been labeled "Game." See page 19 for details on labeling input sources.

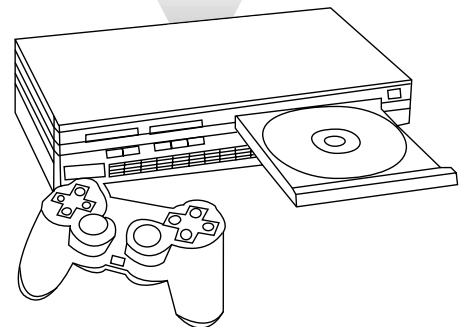
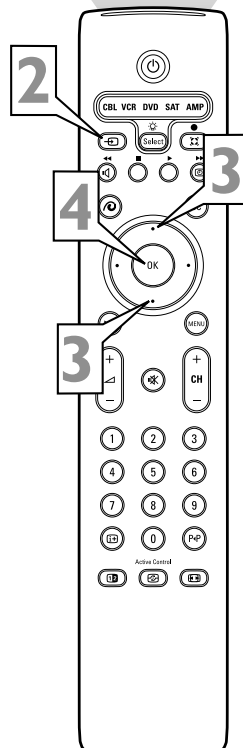

The side panel is also convenient for connecting equipment such as camcorders or cameras. If you use an S-Video connection (the preferred connection), you must also make an audio connection (L and R for stereo or L for mono) to receive sound. The S-Video cable does not carry a sound signal.

Camcorder

Labeling the Audio/Video Input Sources



You can label all the external Audio/Video input sources—AV1, AV2, AV3, AV4, and Side—according to the type of accessory device you have connected to each input.

After labeling, you can use the Source button on the remote control to cycle through and select your desired source.

- 1** Press the Menu button on the remote control to display the on-screen menu.
- 2** Press the Cursor Down button to select “Settings.”
- 3** Press the Cursor Right button repeatedly to select the “Source” menu.
- 4** Press the Cursor Down button repeatedly to select any of the AV Inputs. A list of labels will appear next to the selected AV input.
- 5** Press the Cursor Right button to enter the list.
- 6** Press the Cursor Up or Down button to scroll and select one of the labels in the list.
- 7** Press the Menu button on the remote control to remove the on-screen menu from the TV screen.
- 8** Press the Source button on the remote control to display the list of AV inputs and their labels.

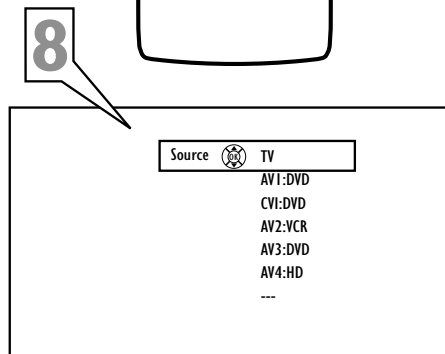
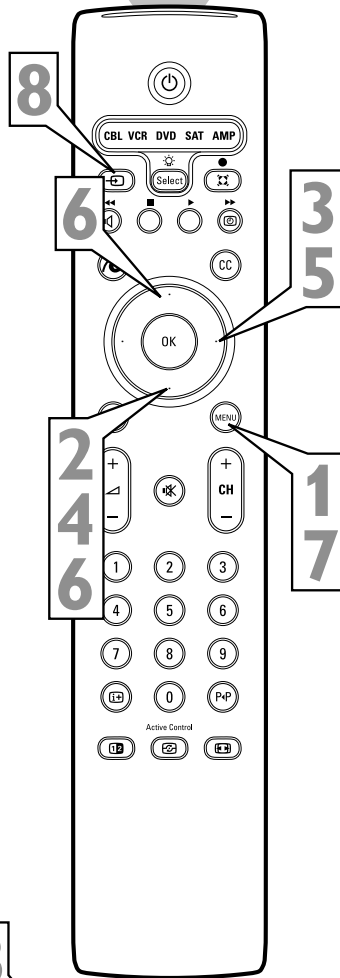
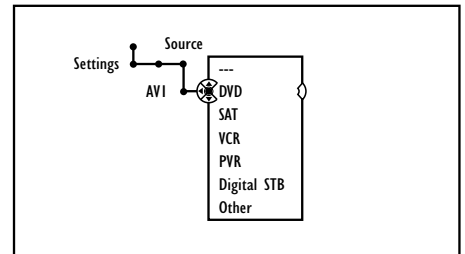
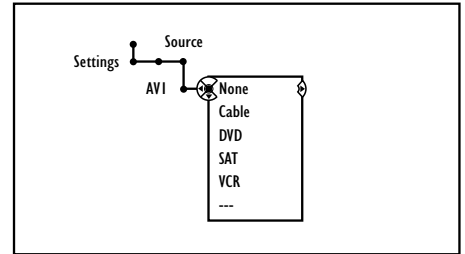
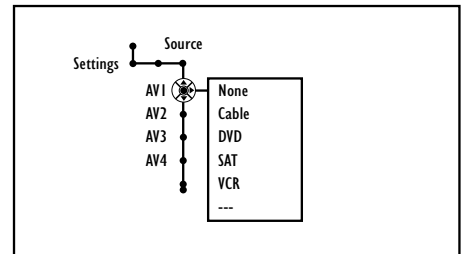
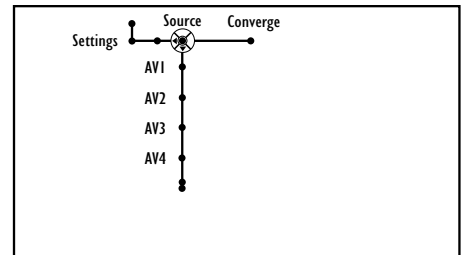
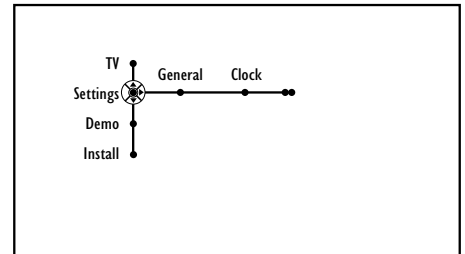
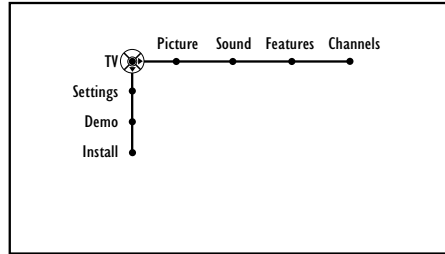

HELPFUL HINT
The CVI source shown in the list when you press the Source button will have the same label you apply to AV1.

This is just a sample of what the labeling might look like. Your Source Labels will depend on the options you choose to label the AV inputs.



Programming the Remote Control

The remote control supplied with your television will also operate a variety of infrared-controlled accessory devices such as cable boxes, VCRs, DVD players, satellite receivers, and amplifiers.

The TV remote's default mode at power up and after replacing the batteries is TV. You must press the Select button to switch the remote to one of the accessory modes—CBL, VCR, DVD, SAT, or AMP.

Depending on the accessory device you have, programming may not be necessary, because default codes for certain accessory devices have already been programmed into the remote. So before attempting to program, try this test:

- Press the Select button to cycle through the accessory modes—CBL, VCR, DVD, SAT, or AMP. The green light indicates the selected mode. Two seconds after selection, the accessory-mode light will begin to blink. The blinking light means the remote is in the selected accessory mode.
- Point the remote toward the accessory device, then press the Standby-On button to see if the accessory device responds. If not, follow the steps below to program the remote. **Suggestion:** The programming process is easy, but you may want to read the following steps first to familiarize yourself with what you'll be doing, then go back through the steps again, reading and performing them.

- 1** Press the Select and Standby-On buttons at the same time, then release.
- 2** **NOTE:** When inputting the digits as described below, you must not allow more than 20 seconds to pass between the input of each digit or you will need to return to step 1 and begin the programming process again.

Input the appropriate digit provided below for the type of accessory device you want to operate:

- 1 Cable (CBL)
- 2 VCR
- 3 DVD
- 4 Satellite (SAT)
- 5 Amplifier (AMP).

- 3** Input the 4-digit code for the type and brand of accessory device. The codes are listed on pages 22-23.

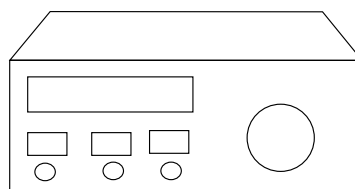

AMP

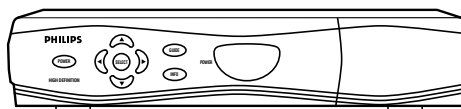

SAT

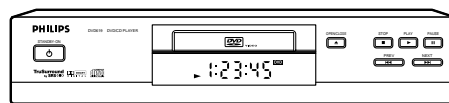

DVD

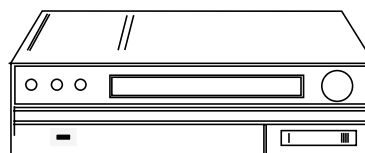

VCR

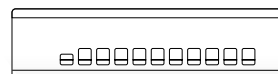

CBL

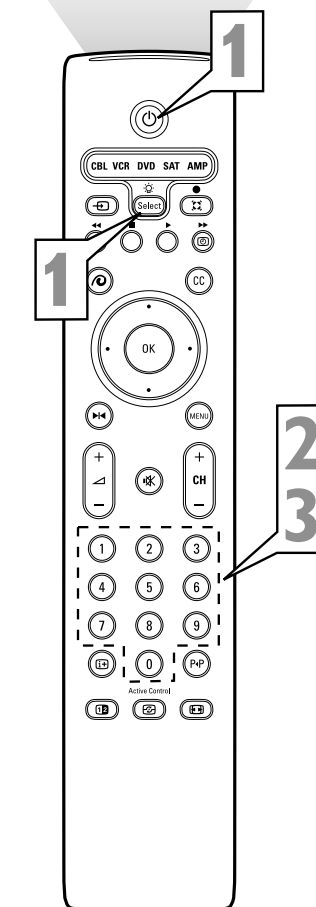



Continued from page 20.

4 The green light behind the Standby–On button will blink for 3 seconds to show that a valid code was input. If a valid code was not entered, the light will stay on continuously for 3 seconds. If that occurs, go back to step 1 and begin the programming process again.

5 Now you will try to use the TV remote with the accessory device.

Press the Select button on the remote to cycle across the accessory mode dial. Stop pressing the button when the mode you desire is lighted. The light will stay on for 2 seconds and then begin blinking. The blinking means that the remote is in the accessory mode you have selected.

6 Within 60 seconds from the time the blinking starts, point the remote toward the accessory device and press the Standby–On button.

If the device does not respond to the Standby–On command, follow the steps for programming the remote again using a different setup code for the type and brand of accessory device you wish to operate. Refer again to the code list on pages 22–23. If no more codes are listed for the type and brand of accessory device, the remote likely will not operate your particular model of accessory device. **NOTE:** Your TV remote is not necessarily capable of being programmed to operate **all models** of the brands of accessory devices listed on pages 22–23. You may want to try the programming process again. Try using the number(s) that are listed for your type and brand of device to be sure you did not make a mistake in inputting the digits during your first attempt at programming.

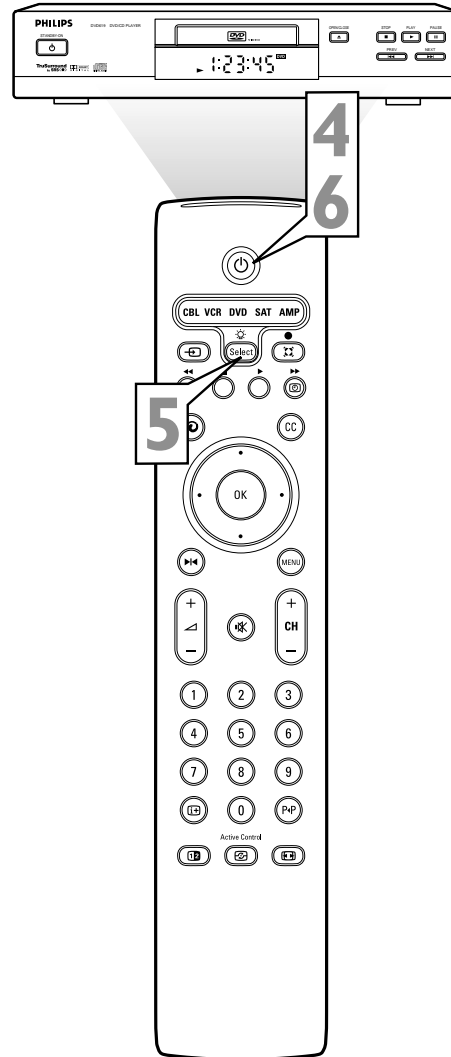

✓ CHECK IT OUT

You can change the duration of the time-out mode by simultaneously pressing the Select button and a digit button, 1–4. Using digit 1 will set the time-out to 15 seconds; digit 2, 30 seconds; digit 3, 60 seconds; and digit 4, 120 seconds. The default time-out setting after you replace the batteries in the remote is 60 seconds. All modes will have the same time-out setting.

HELPFUL HINT

If the remote control is in one of the accessory modes (a mode light is flashing)—CBL, VCR, DVD, SAT, AMP—and you don't press any of the remote buttons for sixty seconds, a "time-out" occurs, returning the remote to TV mode.



Programming the Remote Control: Setup Codes

Amplifier

Carver	.0296
Curtis Mathes	.0327
GE	.0105
JVC	.0358
Linn	.0296
Magnavox	.0296
Marantz	.0296
Optimus	.0422, 0327
Philips	.0296
Pioneer	.0327
Polk Audio	.0296
RCA	.0327
Realistic	.0422
Sony	.0716, 0247
Soundesign	.0105
Victor	.0358
Wards	.0105
Yamaha	.0381

Cable Box

ABC	.0030, 0034, 0035
Allegro	.0180, 0342
Americast	.0926
Archer	.0180, 0824
BellSouth	.0926
Century	.0180
Citizen	.0180, 0342
Comtronics	.0067
Contec	.0046
Emerson	.0824
Everquest	.0042, 0067
Focus	.0427
Garrard	.0180
Gemini	.0042
General Instrument	.0503, 0837
GoldStar	.0067, 0171
Goodmind	.0824
Hamlin	.0047, 0036, 0286, 0061
Hytex	.0034
Jasco	.0042, 0180, 0342
Jerrold	.0030, 0039, 0503, 0042, .0837
Memorex	.0027
Motorola	.1133
Movie Time	.0090
NSC	.0090
Oak	.0046, 0034
Optimus	.0048
Panasonic	.0048, 0134, 0027
Paragon	.0027
Philips	.0180, 0332, 0344
Pioneer	.0171, 0560, 0904
Popular Mechanics	.0427
Pulsar	.0027
Quasar	.0027
RCA	.0048
Radio Shack	.0042, 0910, 0342, 0824
Recoton	.0427
Regal	.0047, 0286
Runco	.0027
SL Marx	.0067
Samsung	.0067, 0171
Scientific Atlanta	.0035, 0504, 0904
Signal	.0042, 0067
Sprucer	.0048
Starcom	.0030, 0042
Stargate	.0067, 0042, 0824
Starquest	.0042
TV86	.0090

Televue	.0067
Tocom	.0039
Toshiba	.0027
Tusa	.0042
Unika	.0180
United Artists	.0034
Universal	.0180, 0218
Viewstar	.0090
Zenith	.0027, 0552, 0926
Zentek	.0427

Surround Sound Receiver

ADC	.0558
Aiwa	.0148
Capetronic	.0558
Carver	.0069, 1116, 1216
Casio	.0222
Clarinette	.0222
Denon	.1187, 1131
Fisher	.0069
Garrard	.0490
Harman/Kardon	.0137
JVC	.0101
Kenwood	.1054, 0069, 0213, 1340 .1596, 1597
Lloyd's	.0222
MCS	.0066
Magnavox	.0418, 1116, 0558, 1216 .0222
Marantz	.1116, 1216, 0066
Modulaire	.0222
Nakamichi	.0124
Onkyo	.0162
Optimus	.1050, 0213, 0558, 0069
Panasonic	.0066, 1545
Penney	.0222
Philips	.1116, 1216, 1296, 0418
Pioneer	.0177, 0558, 1050
Proscan	.1281
Quasar	.0066
RCA	.1281, 0558, 1050
Realistic	.0222
Sansui	.1116
Sharp	.0213
Sherwood	.0529
Sony	.1185, 1085, 1285
Sunfire	.1340
Teac	.0490
Technics	.0066, 1335, 1545, 1336
Thorens	.1216
Victor	.0101
Yamaha	.0203, 0213, 1203
Yorx	.0222

Satellite Receiver

AlphaStar	.0799
Echostar	.1032, 0802
Expressvu	.0802
GE	.0593
General Instrument	.0388, 0896, 0654
HTS	.0802
Hitachi	.0846
Hughes Network Systems	.0776
JVC	.0802
Jerrold	.0388, 0654
Magnavox	.0749, 0751
Memorex	.0751
Next Level	.0896
Panasonic	.0728
Philips	.1103, 0749, 0751
Primestar	.0654, 0388

RCA	.0593, 0170, 0419, 0882
Radio Shack	.0896
Samsung	.1136
Sony	.0666
Star Choice	.0896
Toshiba	.0776, 0817
Uniden	.0751, 0749
Zenith	.0883

VCR

Admiral	.0075, 0236
Adventura	.0027
Aiko	.0305
Aiwa	.0027, 0064
Akai	.0068
America Action	.0305
American High	.0062
Asha	.0267
Audiovox	.0064
Beaumarck	.0267
Bell & Howell	.0131
Broksonic	.0148, 0211, 0029, 0236, 0506
CCE	.0099, 0305
Calix	.0064
Canon	.0062
Carver	.0108
Cineral	.0305
Citizen	.0305, 0064
Colt	.0099
Craig	.0064, 0099, 0074, 0267, 0298
Curtis Mathes	.0062, 0068, 0087, 0189 .0787
Cybernex	.0267
Daewoo	.0305, 0072
Denon	.0069
Dynatech	.0027
Electrohome	.0064
Electroponic	.0064
Emerex	.0059
Emerson	.0211, 0029, 0236, 0305, .0148, 0506, 0027, 0064, .0070
Fisher	.0074, 0131
Fuji	.0062
Funai	.0027
GE	.0062, 0087, 0075, 0267, .0787
Garrard	.0027
Go Video	.0459, 0553
GoldStar	.0064, 0065
Gradiente	.0027
HI-Q	.0074
Harley Davidson	.0027
Harman/Kardon	.0065, 0108
Harwood	.0099
Hitachi	.0069, 0027, 0068
Hughes Network Systems	.0069
JVC	.0094, 0068
Jensen	.0068
KEC	.0064, 0305
KLH	.0099
Kenwood	.0068, 0094, 0065
Kodak	.0062, 0064
LXI	.0064
Lloyd's	.0027
Logik	.0099
MEI	.0062
MGA	.0070, 0267
MGN Technology	.0267
MTC	.0027, 0267
Magnasonic	.0305
Magnavox	.0062, 0108, 0027, 0066, 0176

Programming the Remote Control: Setup Codes



VCR (continued)

Magnin	.0267	Realistic	.0027, 0131, 0074, 0075, .0064, 0062	XR-1000	.0099, 0027, 0062
Marantz	.0108, 0062	ReplayTV	.0641, 0643	Yamaha	.0065
Marta	.0064	Runco	.0066	Zenith	.0066, 0027, 0236, 0506
Matsushita	.0062, 0189	STS	.0069		
Memorex	.0131, 0074, 0506, 0027	Samsung	.0072, 0267		
	.0064, 0075, 0062, 0267	Sanky	.0066, 0075		
	.0066, 0189, 0236, 1189	Sansui	.0068, 0506, 0027, 0094, 0236, 0298		
Minolta	.0069	Sanyo	.0074, 0131, 0267		
Mitsubishi	.0070, 0075, 0094	Scott	.0211, 0148, 0070, 0072		
Motorola	.0062, 0075	Sears	.0064, 0069, 0027, 0062, .0074, 0131		
Multitech	.0027, 0099	Semp	.0072		
NEC	.0065, 0068, 0094, 0131	Sharp	.0075		
Nikko	.0064	Shintom	.0099		
Noblex	.0267	Shogun	.0267		
Olympus	.0062	Singer	.0099		
Optimus	.0189, 1189, 0075, 0064, .0131, 0459	Sony	.0059, 0027, 0062, 0063		
Orion	.0506, 0029, 0211, 0236	Sylvania	.0062, 0108, 0027, 0070		
Panasonic	.0062, 0189, 1189, 0643	Symphonic	.0027		
Penney	.0062, 0267, 0064, 0069, 0065	TMK	.0267		
Pentax	.0069	Tatung	.0068		
Philco	.0062, 0236, 0506	Teac	.0027, 0068		
Philips	.0108, 0062, 0645	Technics	.0062, 0189		
Pilot	.0064	Teknika	.0027, 0062, 0064		
Pioneer	.0094	Thomas	.0027		
Polk Audio	.0108	Tivo	.0645, 0663		
Profitronic	.0267	Toshiba	.0072, 0070		
Proscan	.0087, 0787	Totevision	.0064, 0267		
Protec	.0099	Unitech	.0267		
Pulsar	.0066	Vector	.0072		
Quasar	.0062, 0189, 1189	Vector Research	.0065		
RCA	.0087, 0176, 0069, 0062, .0075, 0267, 0787	Video Concepts	.0072		
Radio Shack	.0027	Videosonic	.0267		
Radix	.0064	Wards	.0062, 0087, 0027, 0074, .0267, 0069, 0075, 0099		
Randex	.0064		.0108, 0176, 0787		
		White Westinghouse	.0099, 0305, 0236		

Digital Video Disc (DVD)

Apex	.0699
Denon	.0517
Fisher	.0697
GE	.0549
Hitachi	.0691
Hiteker	.0699
JVC	.0650, 0585
Kenwood	.0709, 0561
Konka	.0746, 0738, 0747, 0748
Magnavox	.0530, 0702
Marantz	.0566
Mitsubishi	.0548
Onkyo	.0530
Optimus	.0598
Oritron	.0678
Panasonic	.0517, 0659
Philips	.0566, 0530
Pioneer	.0598, 0552, 0659
Proscan	.0549
RCA	.0549, 0598
Samsung	.0600
Sharp	.0657
Sony	.0560
Technics	.0517
Theta Digita	.0598
Toshiba	.0530
Yamaha	.0517, 0572
Zenith	.0618, 0530



Operating Accessory Devices with the TV Remote

After having programmed your TV remote, use the illustrations on pages 25-26 as a reference to the functions of the remote buttons with accessory devices.

Before the remote will operate an accessory device, you must select the correct mode: CBL (cable box), VCR, DVD, SAT (satellite), or AMP (amplifier). Here's how:

- 1 Press the Select button to cycle across the accessory mode dial. Stop pressing the button when the mode you desire is lighted. The light will stay on for two seconds and then begin blinking. The blinking means that the remote is in the accessory mode you have selected.

NOTE: If you do not use the remote for 60 seconds from the time the accessory mode light begins blinking, the light will switch off, and the TV will go back to TV mode. Each time you press any of the remote buttons when an accessory mode light is blinking, a timer is reset to keep the remote in the accessory mode you have selected.

- 2 Point the front of the remote toward the front of the accessory device, then press the button to perform the desired function.

HELPFUL HINT

If the remote control is in one of the accessory modes (mode light flashing)—CBL, VCR, DVD, SAT, AMP—and you don't press any of the remote buttons for sixty seconds, a "time-out" occurs, returning the remote to TV mode.

✓ CHECK IT OUT

You can change the duration of the time-out mode by simultaneously pressing the Select button and a digit button, 1-4. Using digit 1 will set the time-out to 15 seconds; digit 2, 30 seconds; digit 3, 60 seconds; and digit 4, 120 seconds. The default time-out setting after you replace the batteries in the remote is 60 seconds. All modes will have the same time-out setting.

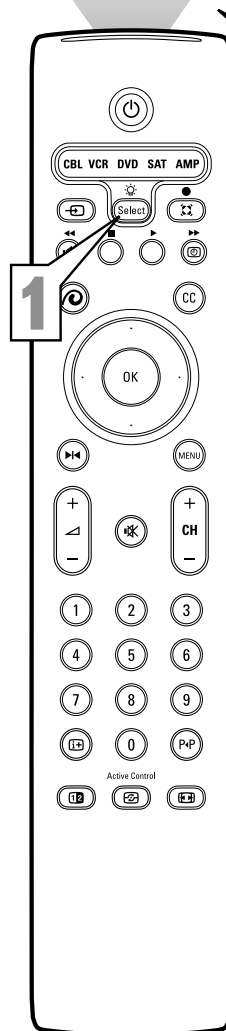
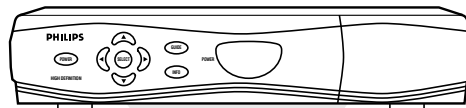

Point the front of the remote toward the front of the accessory device, then press the necessary buttons to perform the functions you desire. Refer to pages 25-26 to see the functions of the buttons in the respective accessory modes.

To backlight the remote control buttons, press and hold the Select button for two seconds. If you do not press any remote buttons for five seconds, the backlight switches off. Each time you press a remote button while the backlight is on, the five-second time-out function is reset. After the backlight switches off, you must press and hold the Select button for two seconds to turn it back on.



Operating Accessory Devices with the TV Remote



CBL (Cable) Mode

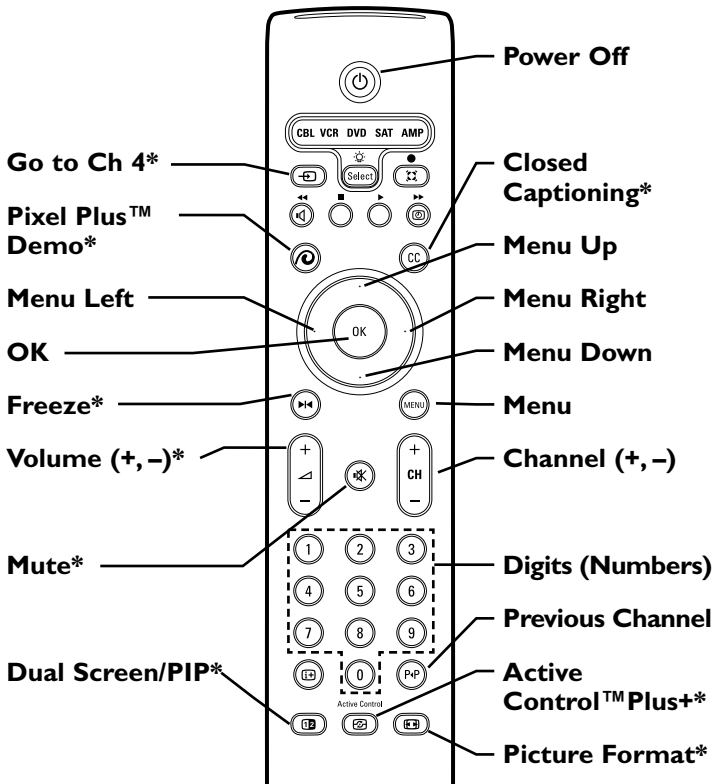

*Point remote at TV when using this button.

VCR Mode

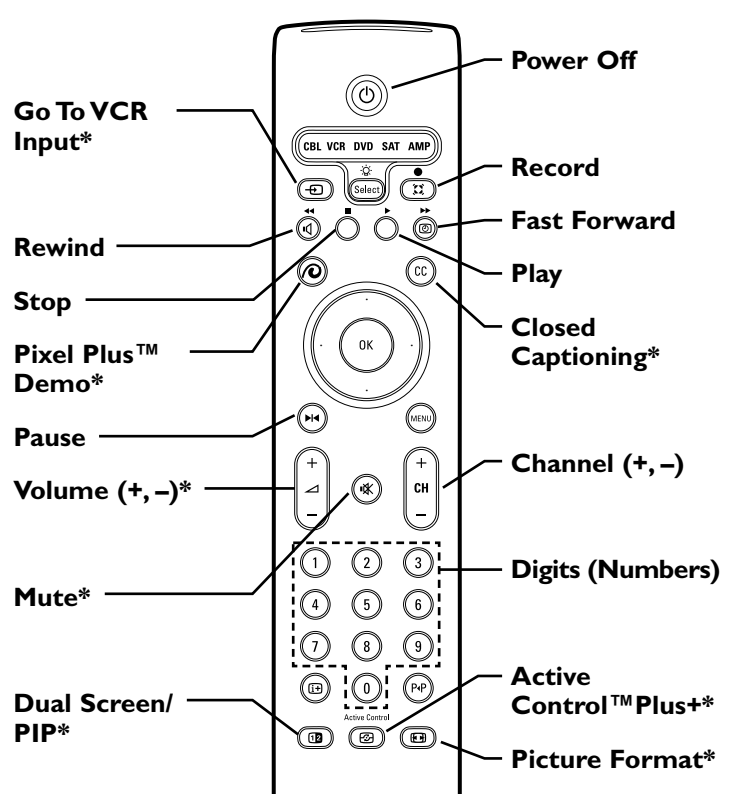

*Point remote at TV when using this button.

DVD Mode

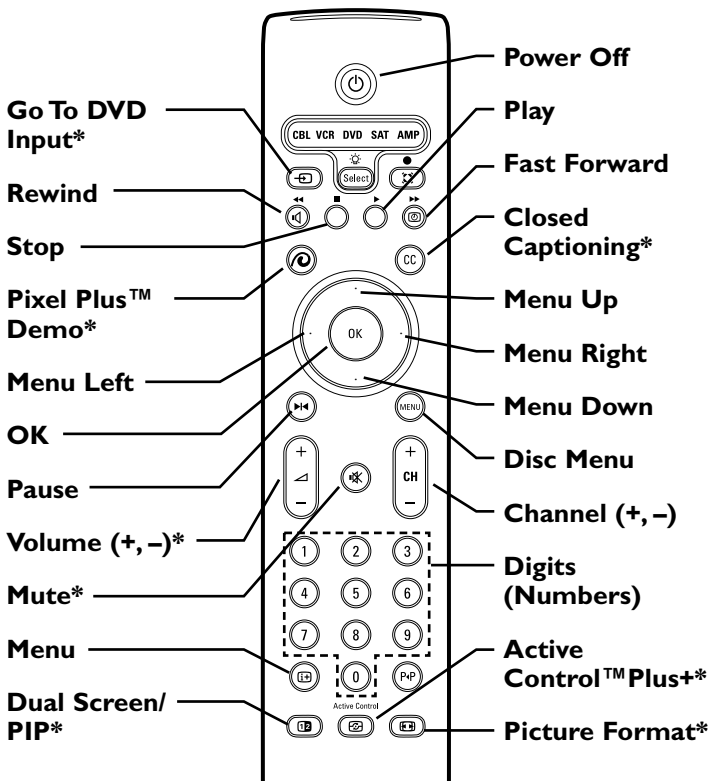

*Point remote at TV when using this button.

SAT Mode

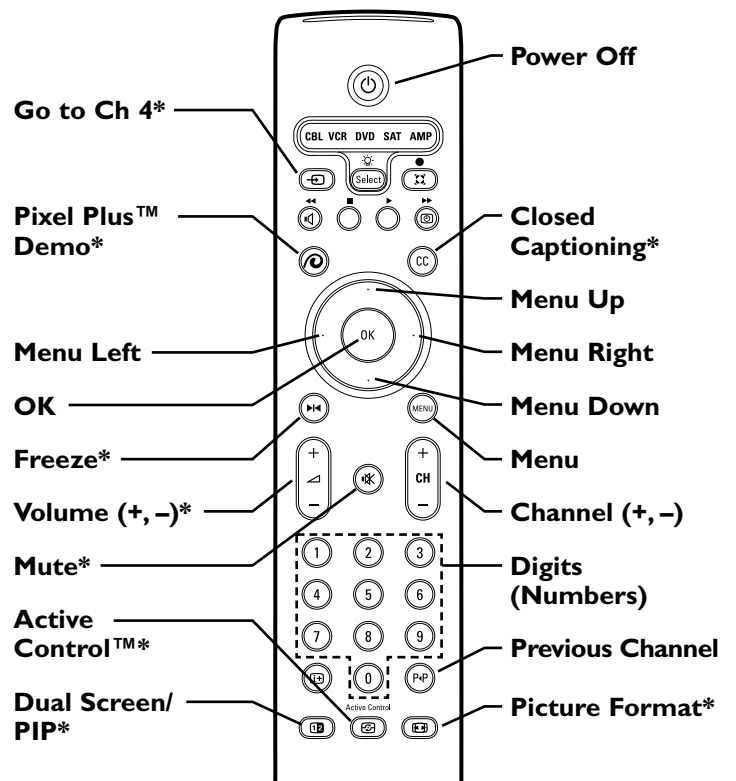

*Point remote at TV when using this button.



Operating Accessory Devices with the TV Remote

AMP mode

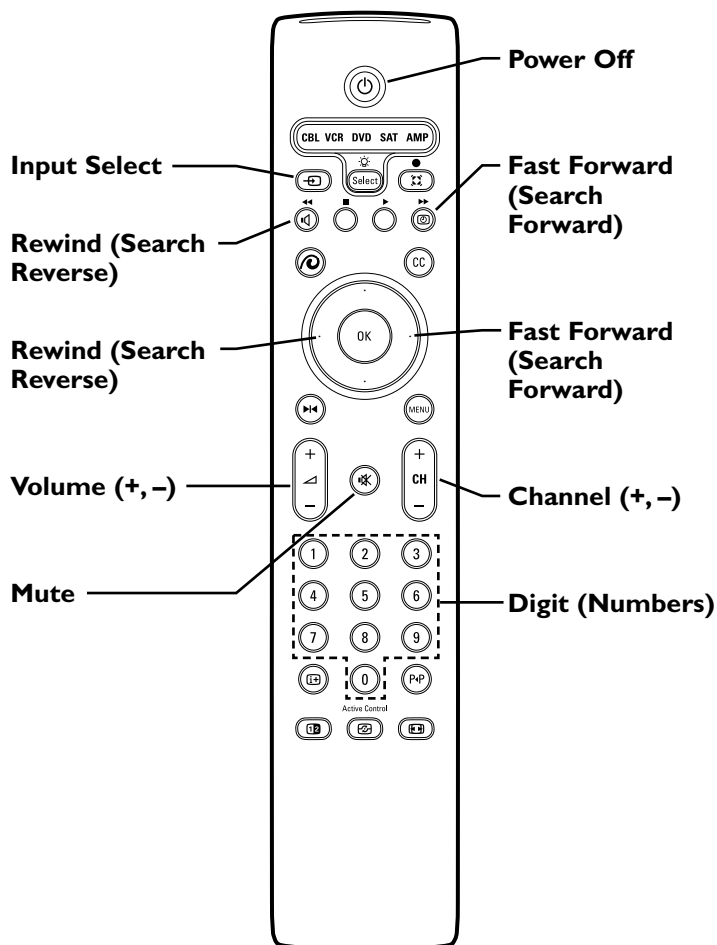



Active Control™ Plus+ monitors incoming video signals from the Tuner, AV1, AV2, and Side inputs and adjusts key picture settings for best picture quality. In addition to measuring picture noise, this feature uses an ambient light sensor (located on the front of the TV) to adjust the picture settings according to viewing conditions in the room. When you choose to turn Active Control™ Plus+ on, you have the options Minimum, Medium, or Maximum. Maximum is the recommended option.

NOTE: Active Control™ Plus is disabled with the AV3 and AV4 input sources.

- 1** Press the Active Control™ button on the remote control to display the “Active Control” menu.
 - 2** Press the Cursor Up or Down button to select one of the options: “Minimum,” “Medium,” “Maximum,” or “Off.”
- NOTE:** The Active Control™ values shown in the information window will be based on the current AutoPicture™ setting: Personal, Rich, Natural, Soft, Multimedia, or Eco.
- 3** Press the Active Control button to remove the on-screen menu from the TV screen.

Active Control	Active picture	Active display
Medium		
Contrast		0 63
Dynamic contrast		0 15
Color		0 36
Sharpness		0 52
DNR		0 20
Motion		0 04
Tint		0 44

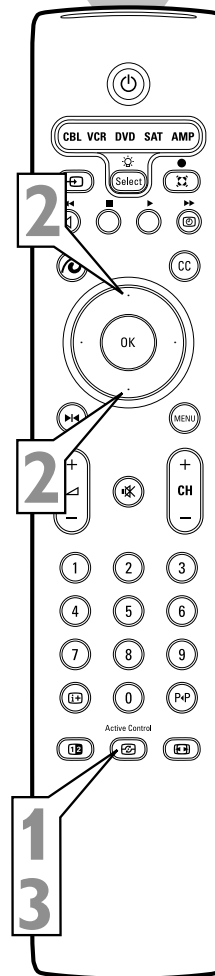

CHECK IT OUT

Active Control™ Plus+ Settings

Minimum—Sharpness, Dynamic Contrast, and Noise Reduction are controlled automatically.

Medium—Sharpness, Color, Dynamic Contrast, and Noise Reduction are controlled automatically.

Maximum—Sharpness, Color, Contrast, Dynamic Contrast, and Noise Reduction are controlled automatically.



Selecting an AutoPicture™ Option

Whether you're watching a movie or playing a video game, your TV has automatic video control settings to match your current program source or content. AutoPicture™ quickly resets your TV's video controls for a number of different types of programs and viewing conditions that you may have in your home. The Personal AutoPicture™ settings are the same as the Picture control adjustments made within the on-screen menu.

Active Control	Auto picture	Active display
	Medium	
Contrast		63
Dynamic contrast		15
Color		36
Sharpness		52
DNR		20
Motion		04
Tint		44

Active Control	Auto picture	Active display
	Personal	
Contrast		63
Dynamic contrast		15
Color		36
Sharpness		52
DNR		20
Motion		04
Tint		44

- 1** Press the Active Control™ button on the remote control to display the "Active Control" menu.
- 2** Press the Cursor Right button to select Auto picture
- 3** Press the Cursor Down button to select one of the AutoPicture™ options: "Personal," "Rich," "Natural," "Soft," "Multimedia," or "Eco."
- 4** Press the Menu button to remove the on-screen menu from the TV screen.

NOTE: You can also adjust the Auto picture in the on-screen menu.

- Press Menu to display the menu.
- Then use the cursor buttons to navigate to "Picture," and "Auto picture."
- Use the Cursor Up and Down buttons to select "Personal," "Rich," "Natural," "Soft," "Multimedia," or "Eco."

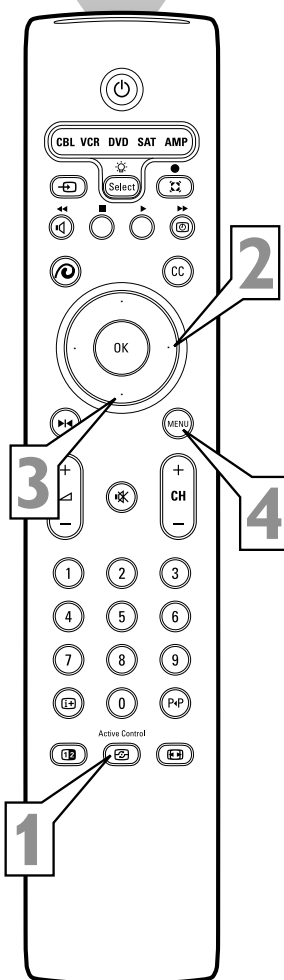

AutoPicture™ Options

Personal settings are based on your personal choice or viewer control preferences.

Rich emphasizes very vibrant colors, a good choice when used in a brightly lighted room.)

Natural sets picture controls at midlevel settings for consistent viewing conditions.

Soft emphasizes warm colors, a good choice for dimly lighted room. It gives a cinema-like effect when the light is switched off.

NOTE: This option can also be used with the Pixel Plus™ control to soften the appearance of harsh screen elements. See page 31 for information about Pixel Plus™.

Multimedia emphasizes soft colors, a good choice for playing computer games, for example.

ECO reduces brightness and contrast settings to low levels as a power consumption saving measure.

CHECK IT OUT

To view the picture without the menu bars, go to Active Display and select "Off."

Using Active Display



Use Active display to turn off the Active control Bars as well as view a sample of various display options.

- 1** Press the Active Control™ button on the remote control twice to display the “Active Control” menu.
- 2** Press the Cursor Right button to select Active Display
- 3** Press the Cursor Down button to select “Show Bars,” as well as a sample screen for “Dynamic Contrast,” “Pixel Plus,” or “Digital Natural Motion.” The last option is “Off,” which applies to the bars in the Active Control and Auto Picture displays. To turn the bars back on, select “Show bars.”
- 4** After selecting “Dynamic Contrast,” “Pixel Plus,” or “Digital Natural Motion” the menu will disappear and the screen will display a sample where one side has the feature turned off and the other has the feature turned on. Press Cursor Up or Down to active the menu
- 5** Press the Menu button to remove the on-screen menu from the TV screen.

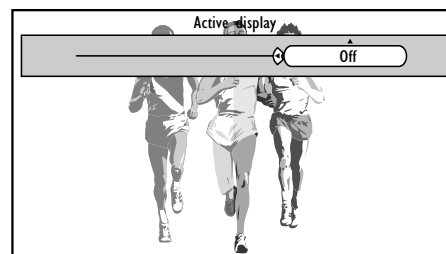
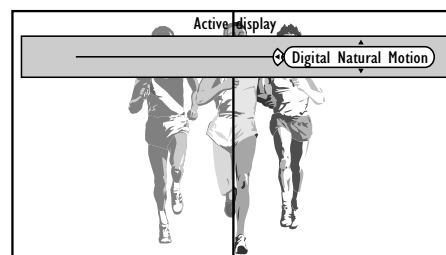
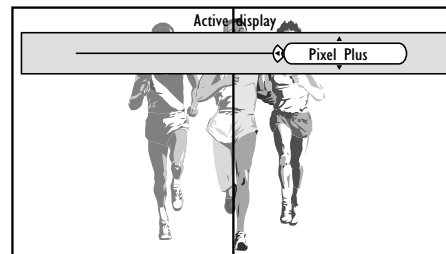
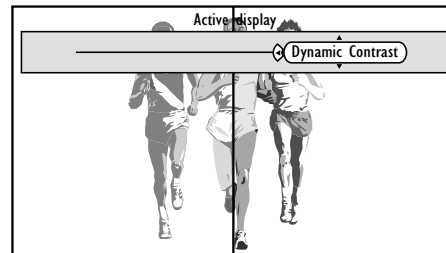
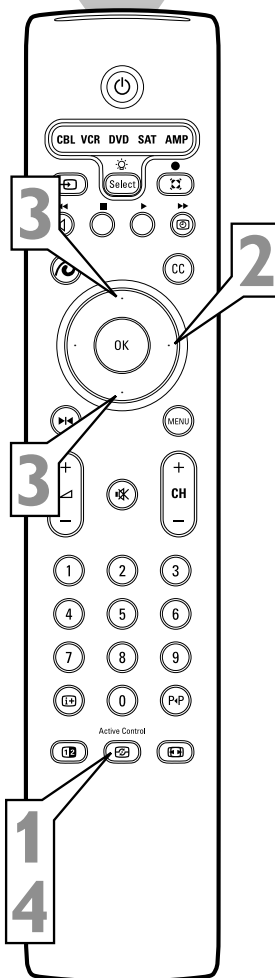
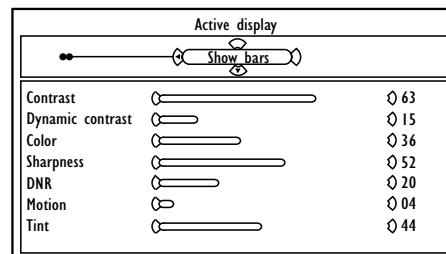
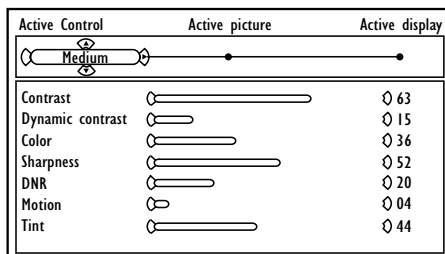

Adjusting/Setting the Picture Controls



To adjust your TV picture controls, select a channel and follow these steps.

- 1** Press the Menu button on the remote control to show the on-screen menu.
- 2** Press the Cursor Right button to select "Picture."
- 3** Press the Cursor Down button to select one of the picture adjustments: "Auto picture," "Contrast," "Brightness," "Color," "Sharpness," "Color temperature," "Digital processing," "Dynamic contrast," "DNR," "Color enhancement," "Tint," and "Picture format." Descriptions for some of these options are provided below. Pages that follow contain details about the other Picture menu options.
- 4** If the menu item has a sublist of items, press the Cursor Right button to enter the sublist, then press the Cursor Up or Down button to select the item.
If the item has a bar scale, press the Cursor Right or Left button to adjust.
- 5** Press the Menu button to remove the on-screen menu from the TV screen.

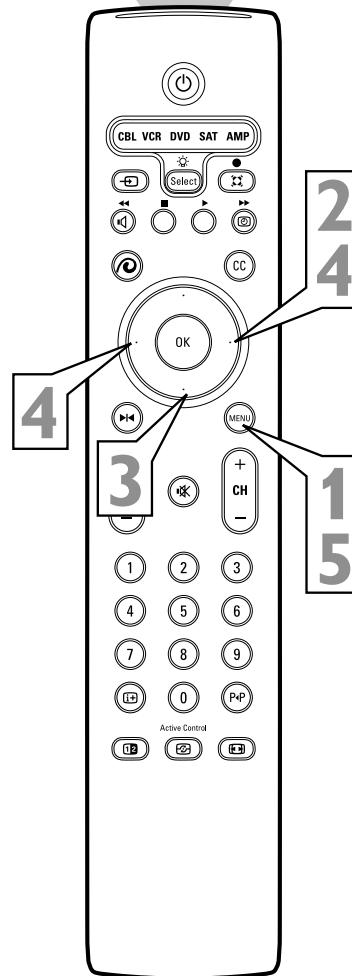
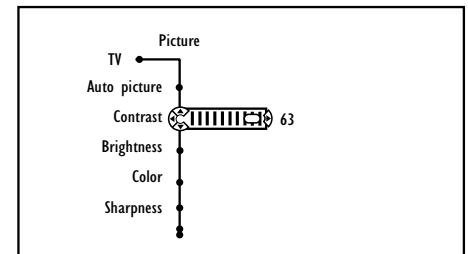
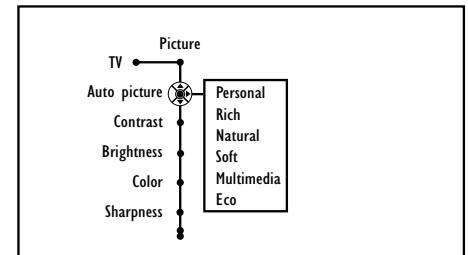
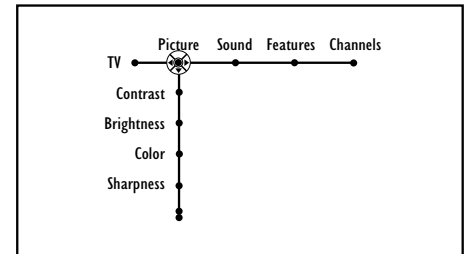
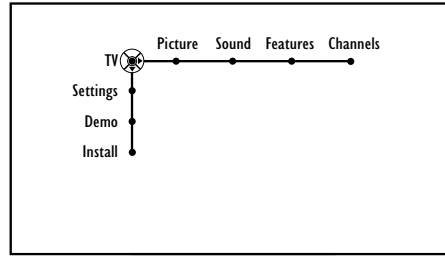

HELPFUL HINTS

- The tint control will not be available for adjustment when the TV is tuned to the AV3 or AV4 input sources.

Picture Control Settings

- **Contrast** adjusts the difference in brightness between the light and dark portions of the picture.
- **Brightness** adds or subtracts light from the darkest part of the picture.
- **Color** adds or eliminates color.
- **Sharpness** improves the detail in the picture.
- **Tint** adjusts the picture to obtain natural skin tones.
- **Color temperature** offers "Normal," "Cool," or "Warm" picture preferences.
- **Normal** keeps whites, white.
- **Cool** makes whites, bluish.
- **Warm** makes whites, reddish.

Selecting a Digital Processing Option



The Digital Processing control gives you a choice of different picture scanning modes.

Progressive Scan doubles the number of picture lines, eliminating line flicker and providing a jitter-free picture.

Movies Plus provides motion compensation to prevent bands of light (a halo effect) that may occur around moving images in the picture.

Pixel Plus improves the picture quality and appearance of on-screen images. The number of picture lines is increased along with the number of pixels per line, giving normal broadcast signals, DVD reproduction or Digital TV signals, unparalleled sharpness and depth. This gives the viewer near high-definition and natural-looking detail without the high-definition signal.

- 1** Press the Menu button on the remote to display the on-screen menu.
- 2** Press the Cursor Right button to select "Picture."
- 3** Press the Cursor Down button repeatedly until the "Digital processing" control is selected.
- 4** Press the Cursor Right button to enter the digital processing submenu.
- 5** Press the Cursor Up or Down button to select Progressive Scan or Pixel Plus.
- 6** Press the Menu button to remove the on-screen menu from the TV screen.

HELPFUL HINT

The Digital Processing control is not available for use with the AV3 or AV4 input sources.

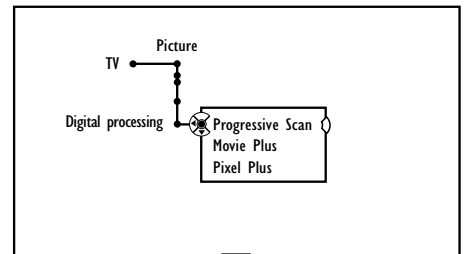
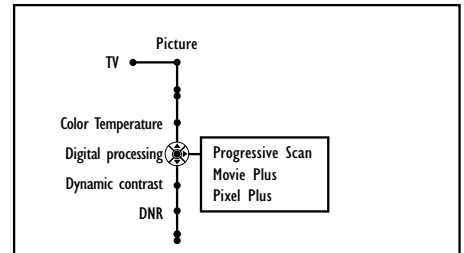
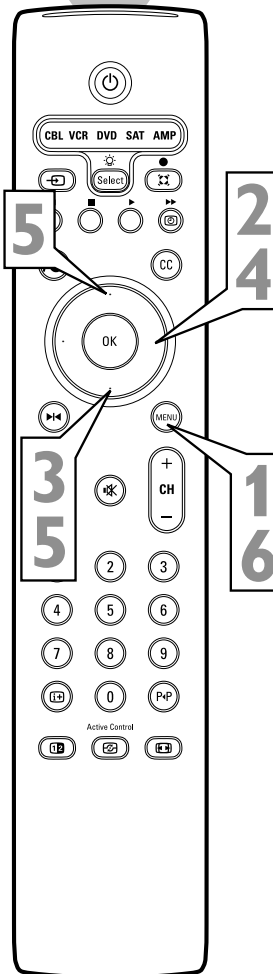
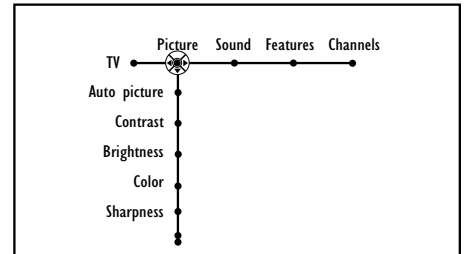
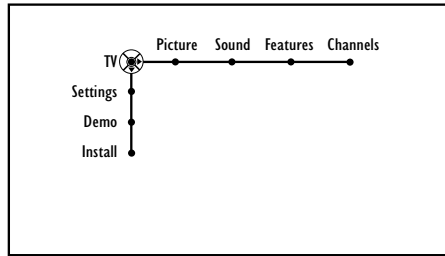

OR

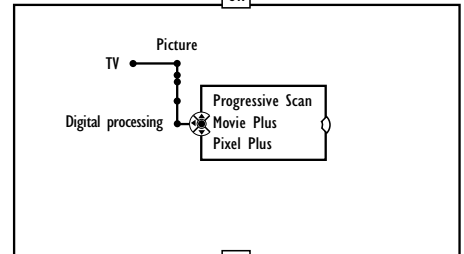

OR

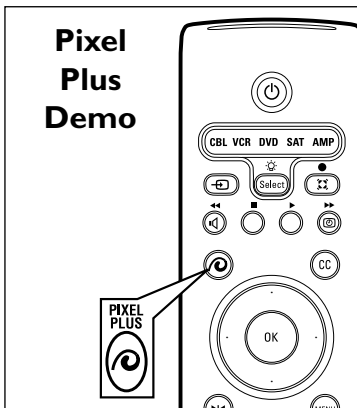
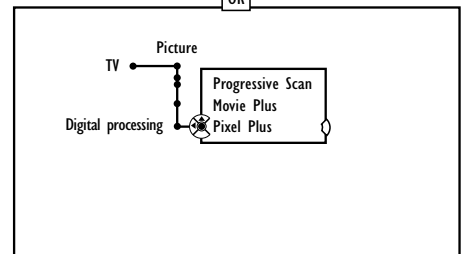

When Pixel Plus is on, the image is flicker free and sharper. Motion appears more natural.

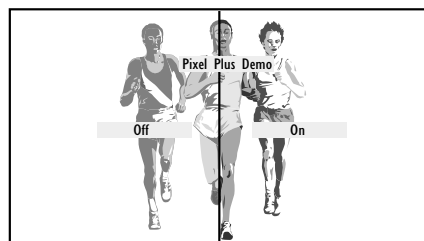

Selecting a Dynamic Contrast Option

The Dynamic Contrast control allows you to sharpen the picture quality by making dark portions of the picture darker and light portions of the picture more noticeable. Normally, you will probably want to select Medium. In certain circumstances, however, you may prefer Minimum or Maximum.

- 1 Press the Menu button on the remote to display the on-screen menu.
- 2 Press the Cursor Right button to select Picture.
- 3 Press the Cursor Down button repeatedly until the "Dynamic contrast" control is selected.
- 4 Press the Cursor Right button to enter the Dynamic Contrast submenu.
- 5 Press the Cursor Up or Down button to select one of the Dynamic Contrast options: "Off," "Minimum," "Medium," or "Maximum."
- 6 Press the Menu button to remove the on-screen menu from the TV screen.

HELPFUL HINT

The Dynamic Contrast control is not available for use with the AV3 or AV4 input sources.

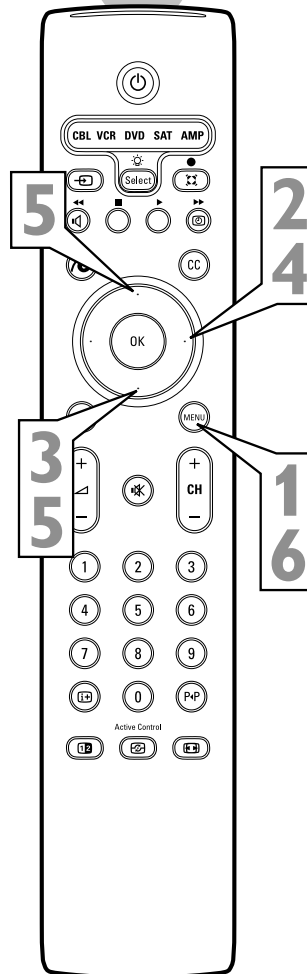
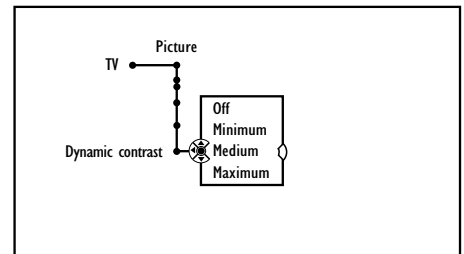
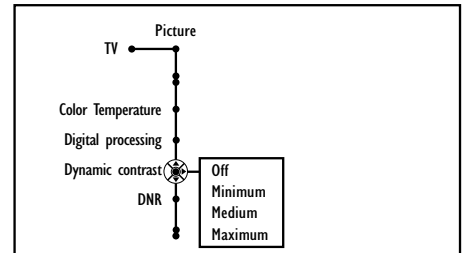
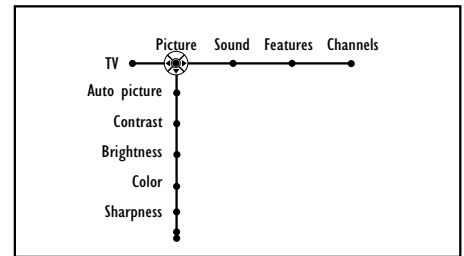
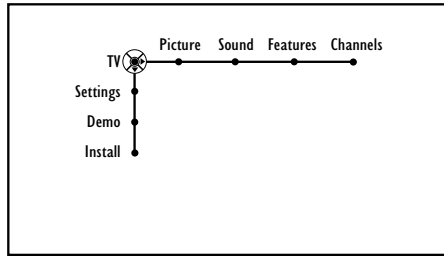

Selecting a DNR (Dynamic Noise Reduction) Option

For many reasons, one of which is poor cable reception, the picture can sometimes appear slightly “speckled” (an indication of signal noise in the picture). The DNR (Dynamic Noise Reduction) control can help eliminate this type of interference and improve the quality of the picture.

- 1** Press the Menu button on the remote to display the on-screen menu.
- 2** Press the Cursor Right button to select “Picture.”
- 3** Press the Cursor Down button repeatedly until the DNR control is selected.
- 4** Press the Cursor Right button to enter the DNR submenu.
- 5** Press the Cursor Up or Down button to select one of the DNR options: Off, Minimum, Medium, or Maximum.
- 6** Press the Menu button to remove the on-screen menu from the TV screen.

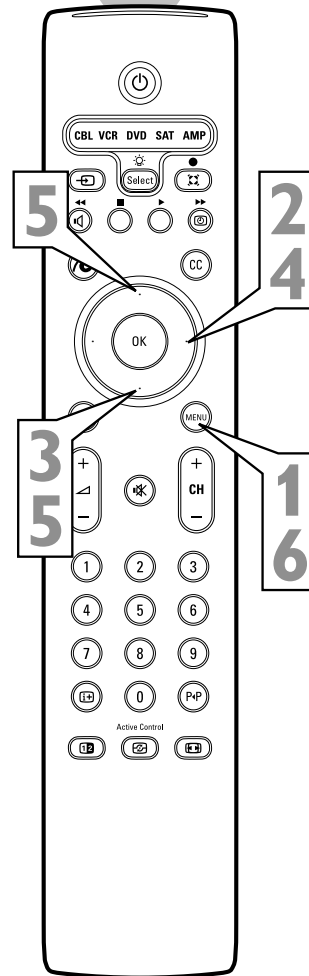
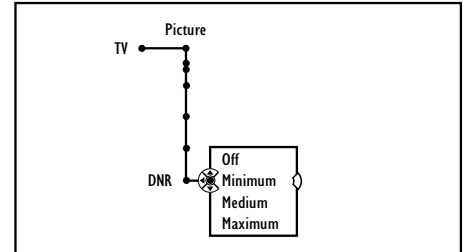
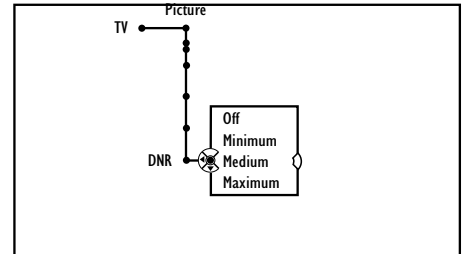
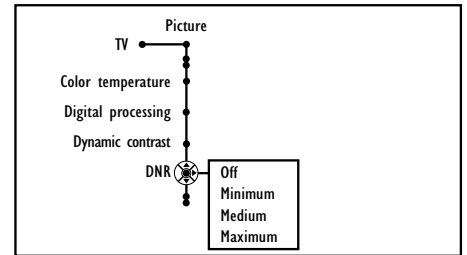
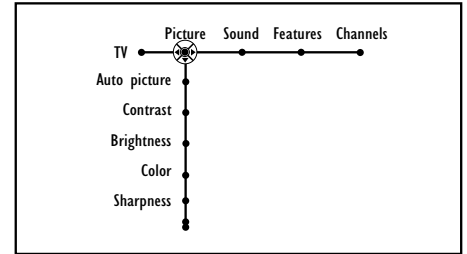
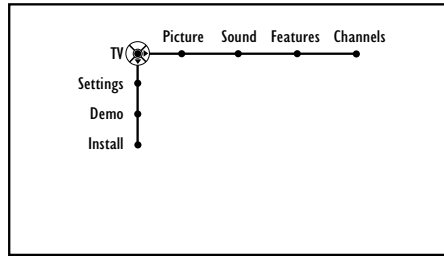

Turning on Color Enhancement



The Color Enhancement control can dramatically improve the picture quality of pictures with a high saturation of color. This control works in four ways:

Dynamic Blue Stretch corrects the white colors toward a more bluish-colored white without changing the other colors. Improves the sharpness of the picture.

Green Enhancement offers a more saturated green color in case of low green broadcasts, giving landscapes a fresher and brighter look.

Color-dependent Sharpness improves the sharpness of the picture through the color information. Gives the picture more details, especially in red colors.

Skin-tone Correction adjusts for over saturation of red that often appears in skin tones.

- 1** Press the Menu button on the remote to display the on-screen menu.
- 2** Press the Cursor Right button to select "Picture."
- 3** Press the Cursor Down button repeatedly until the "Color enhancement" control is selected.
- 4** Press the Cursor Right button to turn the color enhancement control on or off.
- 5** Press the Menu button to remove the on-screen menu from the TV screen.

HELPFUL HINT

The color enhancement control is not available for use with the AV3 or AV4 input sources.

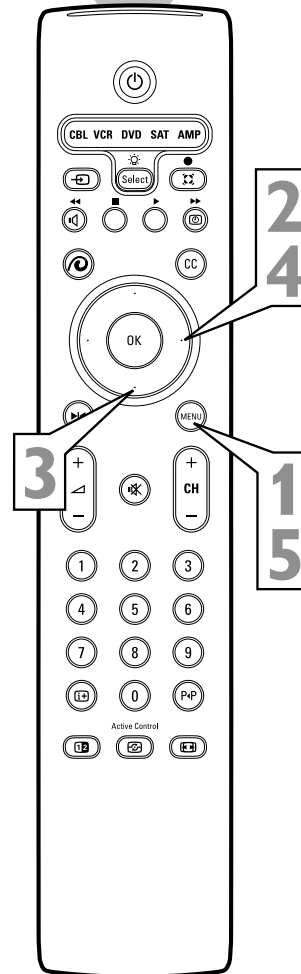
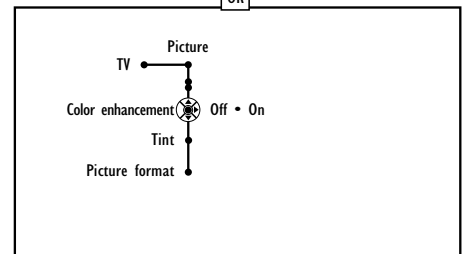
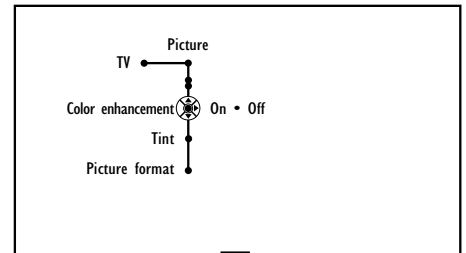
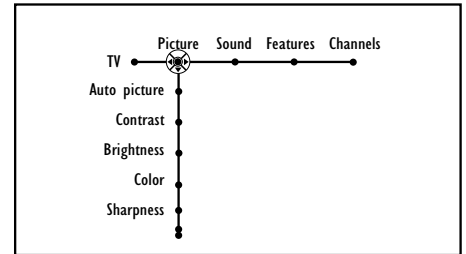
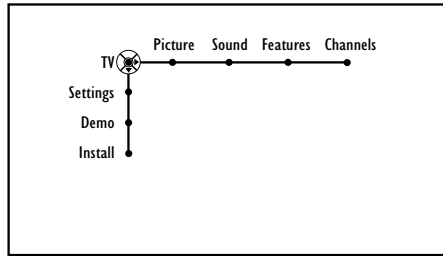



Selecting a Picture Format Option

Your TV's wide screen (16:9 aspect ratio) delivers a home-cinema experience that isn't possible with a conventional (4:3 aspect ratio) set. The 16:9 format of high-definition (HD) programs and other widescreen-format video sources appear more lifelike, dramatic, and theatrical. Black or gray bars are diminished or eliminated. As the television industry moves toward the high-definition format standard and more HD broadcasts become available, you will be able to see the broadcasts as they were intended—in 16:9 format.

For flexibility in viewing conventional 4:3-format video sources on your TV's wide screen, you have the options Automatic, "Super zoom," "Panoramic," "4:3," "Movie expand 14:9," "Movie expand 16:9," "16:9 subtitle," or "Wide screen."

Page 36 explains how to select a picture format option.

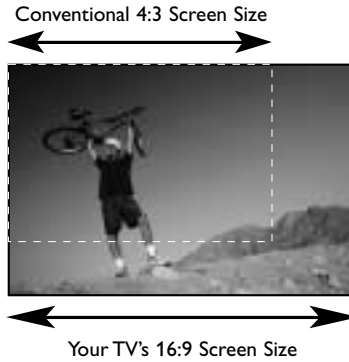

Your TV's Picture Format Options

Automatic

Makes the picture fill the screen as much as possible.



Panoramic

Evenly stretches the edges of the picture to fill the TV's wide screen.



4:3

Displays a conventional 4:3 picture without change. Black or gray bars will show at the left and right sides.



Movie expand 16:9

Alters the image both horizontally (stretched) and vertically (cropped) to fill the TV's wide screen. Part of the top and bottom portions of the picture will be excluded from the screen.



Wide screen

Evenly stretches the width of the picture to fill the screen.



Super zoom

Removes the black or gray bars on the sides of a 4:3-format picture with minimal distortion. Part of the top and bottom portions of the picture are excluded from the screen.



Movie expand 14:9

Expands the picture to 14:9 movie aspect ratio. Part of the top and bottom portions of the picture are excluded from the screen. Black or gray bars are shown at the left and right sides.



16:9 subtitle

Zooms the picture for a full view of subtitles or other information displayed at the bottom of the picture. Part of the top portion of the picture is excluded from the screen.

✓ CHECK IT OUT

You can press the Cursor Up or Down button to pan the screen up and down to see excluded parts of the picture. Use this feature with Super Zoom, Movie Expand 14:9, Movie Expand 16:9, and 16:9 Subtitle.

Left and right panning is possible with the Side input source when the source has been labeled "Game." See page 19 for details on labeling input sources.

HELPFUL HINT

The term *aspect ratio* refers to the relationship between the width and height of a TV screen. Historically, TV screen width has been 33 percent greater than its height, amounting to a 4:3 aspect ratio. The width of your widescreen TV, however, is nearly 80 percent greater than its height, which means its aspect ratio is 16:9. This screen corresponds well with the tendency of the eyes to feel more comfortable with fields of view and action planes that are horizontally oriented. The wide screen is also proportionally truer to the formats in which movies are filmed and presented in theaters.

Selecting a Picture Format Option



Choose a picture format size to match the type of program you're watching. Select the 4:3 aspect ratio or a variety of widescreen formats.

- 1** Press the Menu button on the remote to display the on-screen menu.
- 2** Press the Cursor Right button to select "Picture."
- 3** Press the Cursor Down button repeatedly until the "Picture format" control is selected.
- 4** Press the Cursor Right button to enter the picture-format submenu.
- 5** Press the Cursor Down button to select one of the seven screen formats: "Automatic," "Super zoom," "Panoramic," "4:3," "Movie expand 14:9," "Movie expand 16:9," "16:9 subtitle," or "Wide screen." The Automatic option senses the presence of black or gray bars around the picture and sets the picture to reduce or eliminate the bars.
- 6** Press the Menu button to remove the on-screen menu from the TV screen.
- 7** You can also select a picture format simply by pressing the Picture Format button on the remote control.

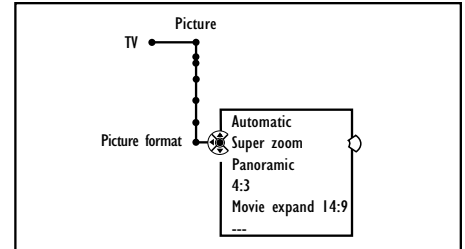
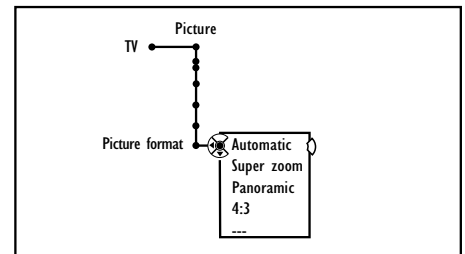
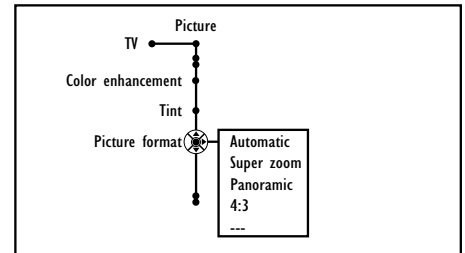
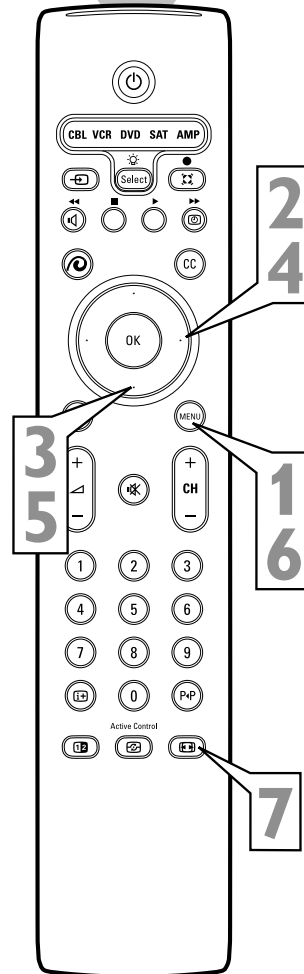
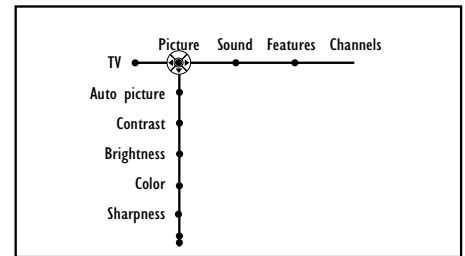
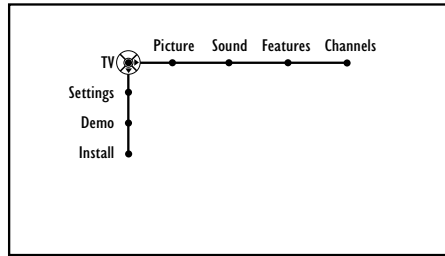

Selecting an AutoSound™ Option



AutoSound™ allows you to select from four factory-set controls and a personal control. The personal control consists of settings you adjust through the on-screen Sound menu. The four factory-set controls—Speech, Music, Movie, or Multimedia—enable you to tailor the TV sound to enhance the particular program you are watching. Follow these steps to select any of the options.

- 1** Press the Menu button on the remote to display the on-screen menu.
- 2** Press the Cursor Right button repeatedly to select “Sound.”
- 3** Press the Cursor Down button repeatedly until the “Auto sound” control is selected.
- 4** Press the Cursor Right button to enter the AutoSound™ submenu.
- 5** Press the Cursor Up or Down button to select an option: “Speech,” “Music,” “Movies,” “Multimedia,” or “Personal.”
- 6** Press the Menu button to remove the on-screen menu from the TV screen.

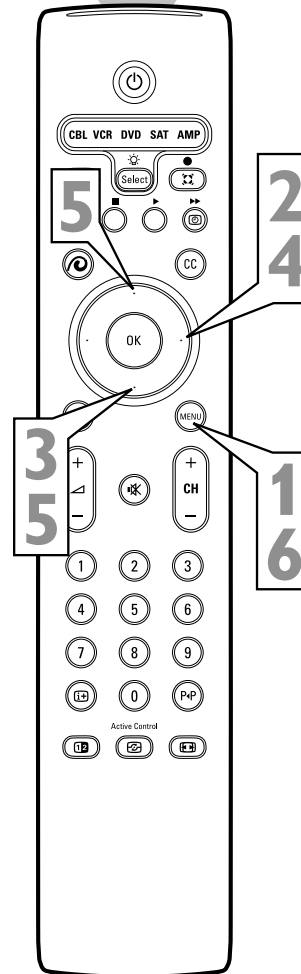
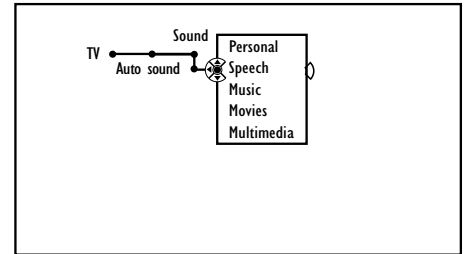
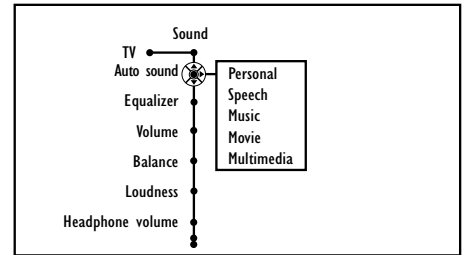
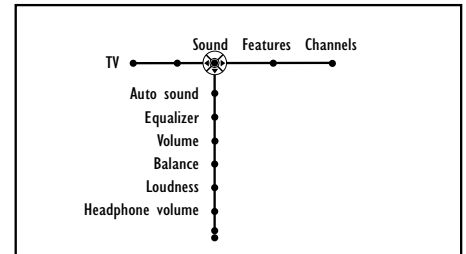
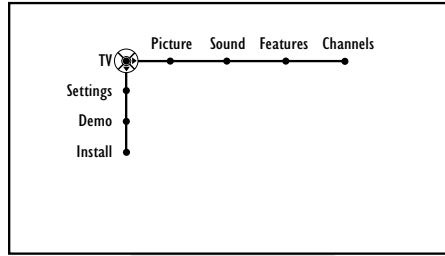

HELPFUL HINTS

AutoSound™ Options

Personal presents the TV’s sound according to the settings you make within the sound menu.

Speech brings voices to the forefront and emphasizes them. Moves music to the background.

Music emphasizes music over voices.

Movies provides a balance between voices and music.

Multimedia provides sound balance best suited for gaming consoles or interactive media.

Selecting a TV Equalizer Option



The Equalizer control will change the dynamics of the sound being heard through the TV. You can adjust the settings for the Personal Equalizer option. The other options have been preset at the factory and cannot be changed.

- 1** Press the Menu button on the remote to display the on-screen menu.
- 2** Press the Cursor Right button repeatedly to select "Sound."
- 3** Press the Cursor Down button repeatedly until the "Equalizer" control is selected.
- 4** Press the Cursor Right button to enter the equalizer submenu. Continue to press the Cursor Right button to select one of the options: "Speech," "Music," "Movie," "Multimedia," or "Personal."
- 5** If you select the Personal option and want to make adjustments, press the Cursor Down button to select an adjustment, then press the Cursor Left or Right button to adjust the slider control to the desired position.

NOTE: If you attempt to change the settings for the factory-preset options Speech, Music, Movie, or Multimedia, the Equalizer control will default to the Personal option.

- 6** Press the Menu button to remove the on-screen menu from the TV screen.

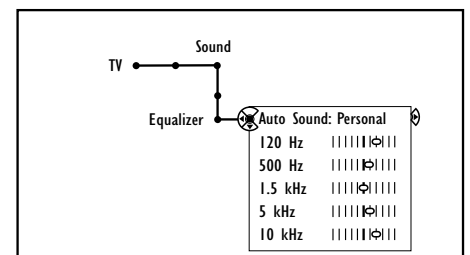
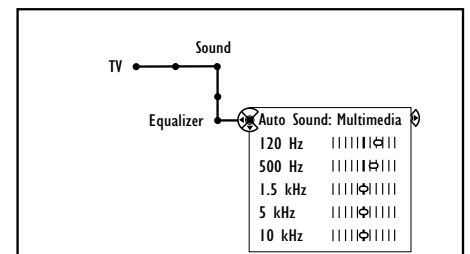
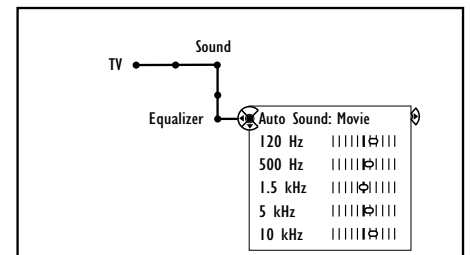
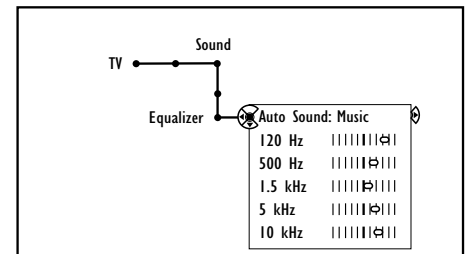
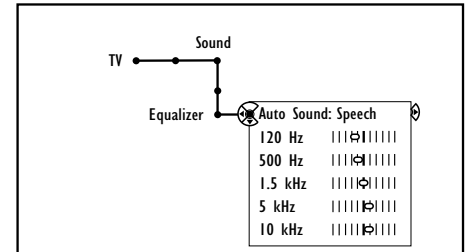
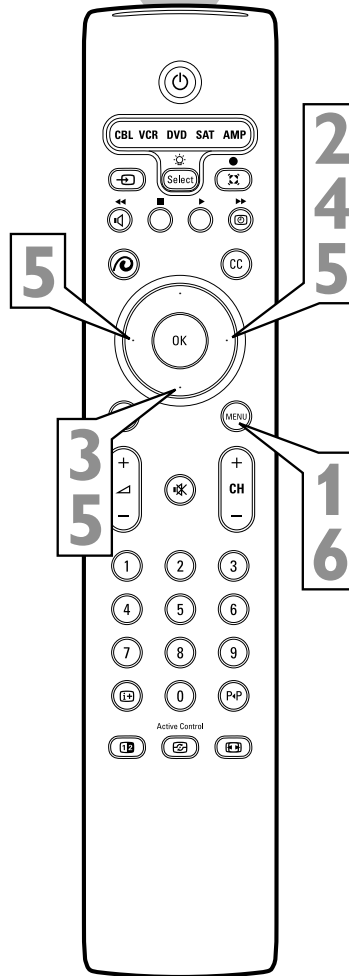
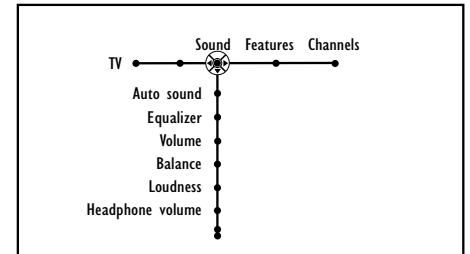
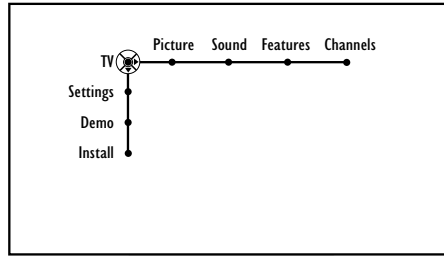



Adjusting the TV and Headphone Volume

Besides the normal volume level control, your TV also has a headphone volume control. This control can be adjusted when using headphones without having to adjust the main volume control for the TV cabinet speakers.

To control the television volume:

- 1 Press the Volume + button on the remote control to increase the television volume level.
- 2 Press the Volume - button on the remote control to decrease the television volume level.

NOTE: The Volume level can also be adjusted within the on-screen menu. Select the Sound menu and cursor down to the Volume control. Use the Cursor Left and Right buttons to adjust.

To control the Headphone volume:

- 3 Press the Menu button on the remote control to display the on-screen menu.
- 4 Press the Cursor Right button to select "Sound."
- 5 Press the Cursor Down button repeatedly until the "Headphone volume" control is selected.
- 6 Press the Cursor Right button to increase the headphone volume level.
- 7 Press the Cursor Left button to decrease the headphone volume level.
- 8 Press the Menu button on the remote control to remove the on-screen menu from the TV screen.

Television Volume



Headphone Volume

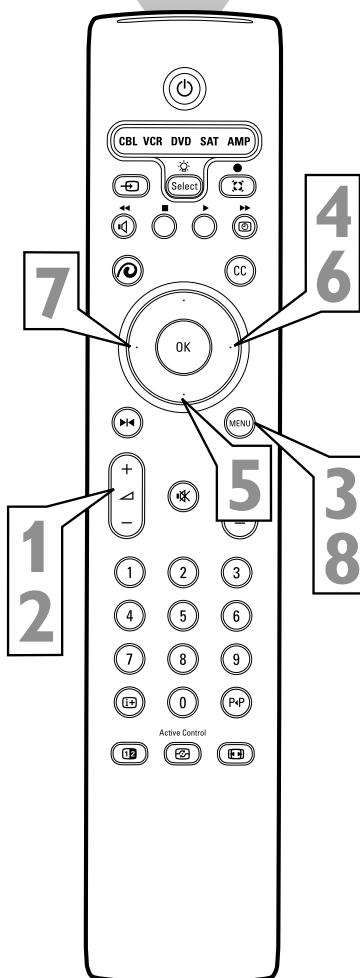
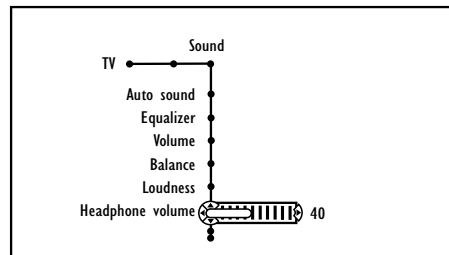
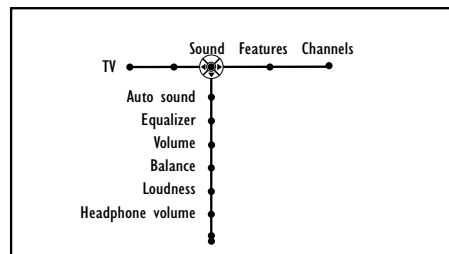
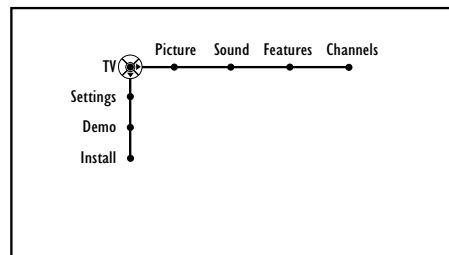

Plug your headphones into the headphone 3.5mm mini-jack in the TV's Side panel.

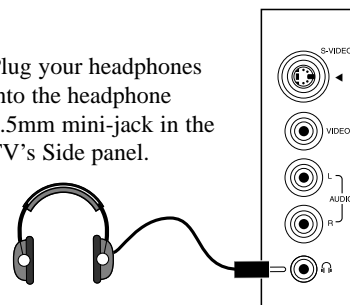

HELPFUL HINTS

When using headphones with PIP viewing, you will only be able to hear the audio for each PIP window if the primary window is a main signal, i.e. antenna or cable. If the primary window is from an aux source (VCR, DVD, etc.) you will only be able to hear the primary window.

Turning Loudness on or off



Turning the Loudness control on provides a volume-dependent bass-boost effect to the speakers. Follow the steps here to turn the Loudness control on.

- 1** Press the Menu button on the remote to display the on-screen menu.
- 2** Press the Cursor Right button repeatedly to select "Sound."
- 3** Press the Cursor Down button repeatedly until the "Loudness" control is selected.
- 4** Press the Cursor Right to toggle loudness on or off.
- 5** Press the Menu button to remove the on-screen menu from the TV screen.

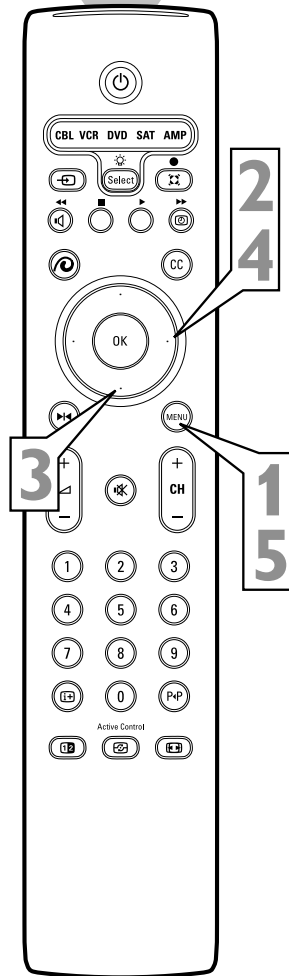
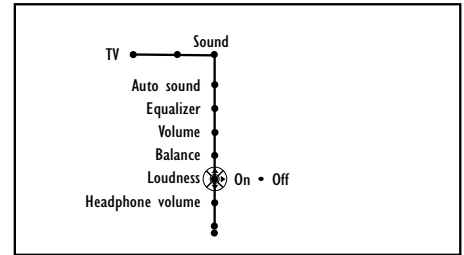
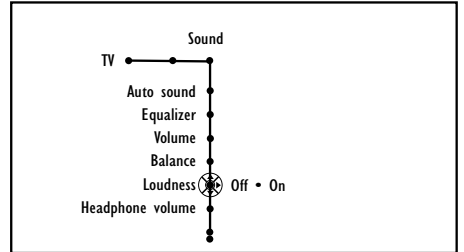
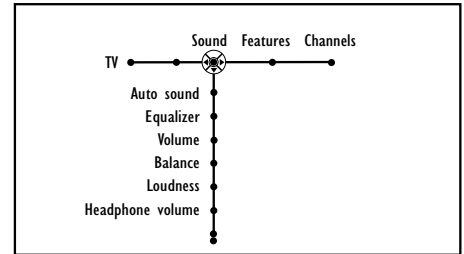
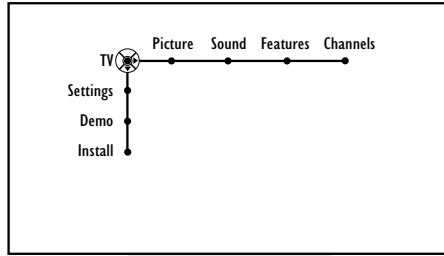

Adjusting TV Speaker Balance



You can adjust the balance of the TV speaker sound.

- 1** Press the Menu button on the remote to display the on-screen menu.
- 2** Press the Cursor Right button repeatedly to select "Sound."
- 3** Press the Cursor Down button repeatedly until the "Balance" control is selected.
- 4** Press the Cursor Right or Left button to adjust speaker balance.
- 5** Press the Menu button to remove the on-screen menu from the TV screen.

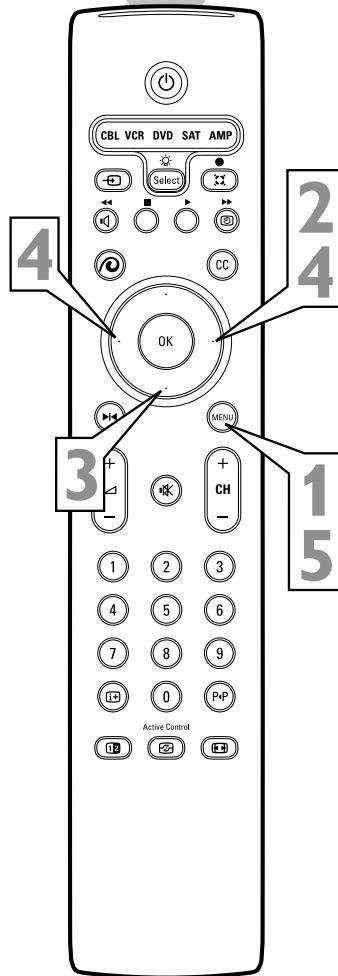
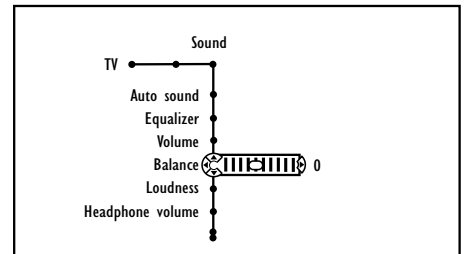
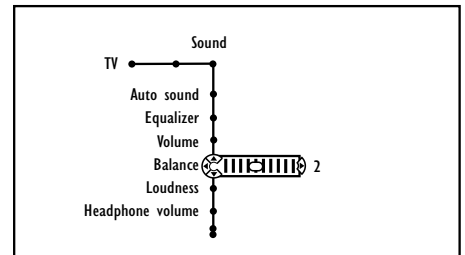
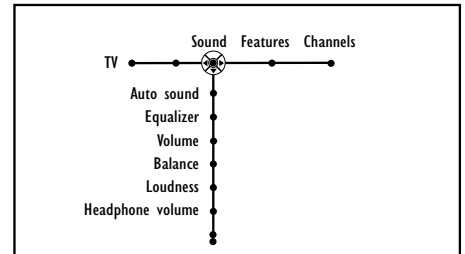
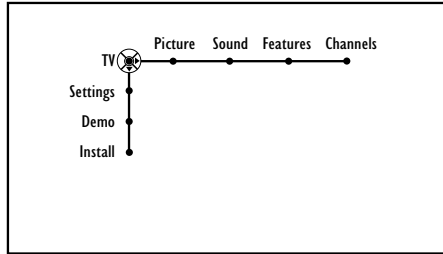



Selecting a Sound Mode Option

The Sound Mode control allows you to place the TV sound into either Incredible Surround™ or Dolby® Virtual mode. The steps below explain how to select one of those options.

- 1** Press the Menu button on the remote to display the on-screen menu.
 - 2** Press the Cursor Right button repeatedly to select “Sound.”
 - 3** Press the Cursor Down button repeatedly until the “Sound mode” control is selected.
 - 4** Press the Cursor Right button to enter the sound mode submenu.
 - 5** Press the Cursor Up or Down button to select one of modes, either “Incr. Surround” or “Dolby Virtual.”
- Incr. Surround** enhances stereo programs by making the sound broader and fuller.
- Dolby Virtual** creates a virtualized surround-sound experience from two speakers. Dolby Virtual retains all the original multichannel audio information and provides the listener with the sensation of being surrounded by additional speakers.
- 6** When finished, press the Menu button to remove the on-screen menu from the TV screen.
 - 7** You can also select a sound mode option simply by pressing the Surround Sound button on the remote control.

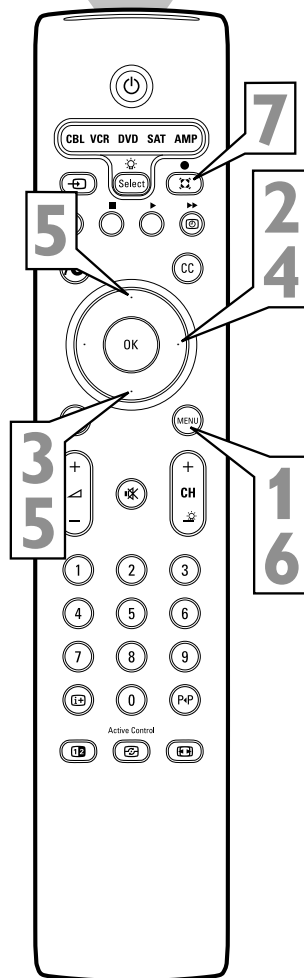
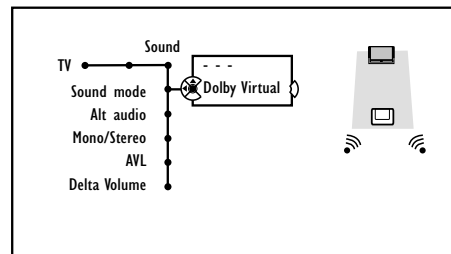
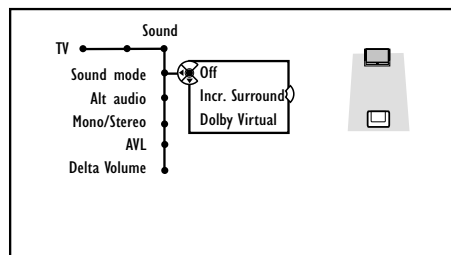
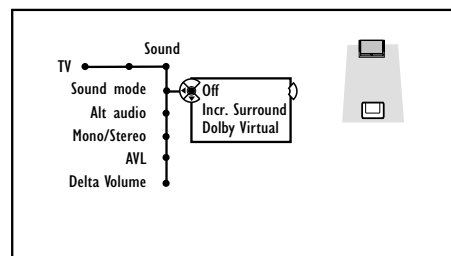
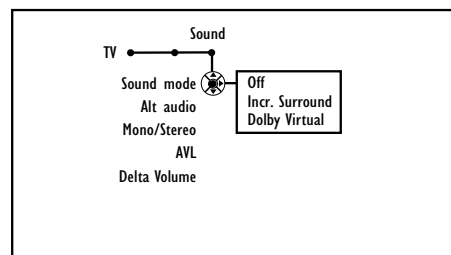
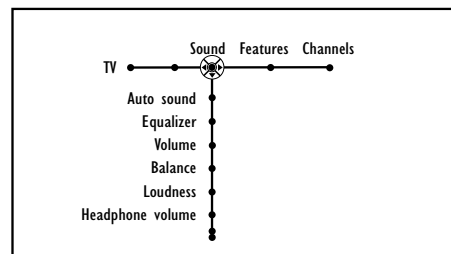
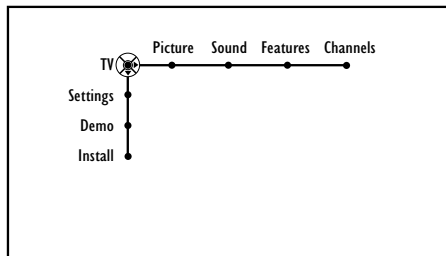

Incredible Surround is a trademark of Philips Consumer Electronics. Copyright 2003 Philips Consumer Electronics. All rights reserved.

Using Alternate Audio (SAP)



For broadcasts that contain SAP (Secondary Audio Program) information, the Alt Audio Control can be set to SAP. Sent as a third audio channel, SAP is an additional part of the stereo broadcast system that can be heard apart from the current TV program sound. TV stations are free to use SAP for any number of purposes.

If an SAP signal is not present with a selected program, the "Alt Audio" option in the TV's on-screen menu cannot be selected and will appear grayed out.

If SAP is available on the tuned channel:

- 1** Press the Menu button on the remote to display the on-screen menu.
- 2** Press the Cursor Right button repeatedly to select "Sound."
- 3** Press the Cursor Down button repeatedly until the Alt Audio control is selected.
- 4** Press the Cursor Right button to toggle and select either "Main" or "SAP."
- 5** Press the Menu button to remove the on-screen menu from the TV screen.
- 6** You can also select SAP by simply pressing the Alternate Audio button on the remote control.

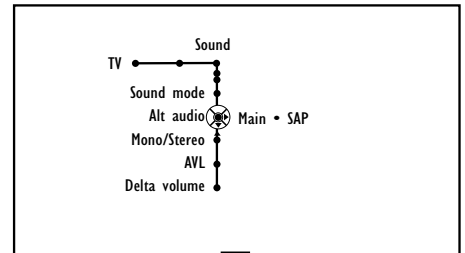
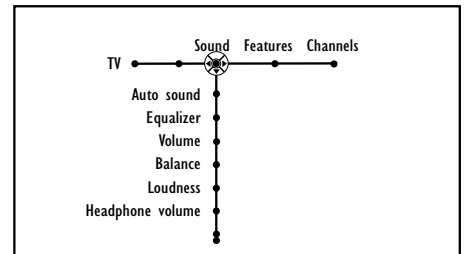
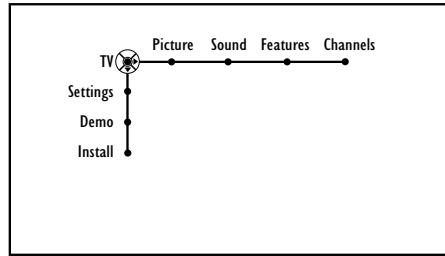

OR

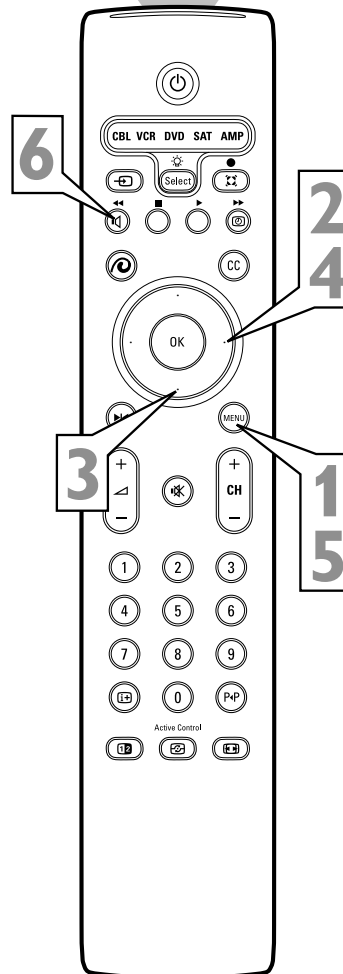
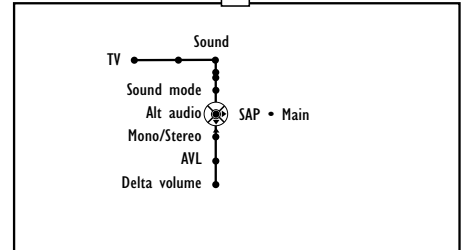



Setting the TV for Stereo Programming

Your TV can output stereo sound. It has both a Hi Fi Stereo amplifier and stereo two-way speakers through which the stereo sound can be heard.

- 1** Press the Menu button on the remote to display the on-screen menu.
- 2** Press the Cursor Right button repeatedly to select "Sound."
- 3** Press the Cursor Down button repeatedly until the "Mono/Stereo" control is selected.
- 4** Press the Cursor Right button to toggle and select either Mono or Stereo.

NOTE: If the signal being received is in mono, it cannot be set to Stereo. If, however, the signal is being received in Stereo, the TV can be placed in the Mono mode. (If you select the Mono option, remember to return the Mono/Stereo control back to Stereo when using the TV with stereo programming.)

- 5** Press the Menu button to remove the on-screen menu from the TV screen.

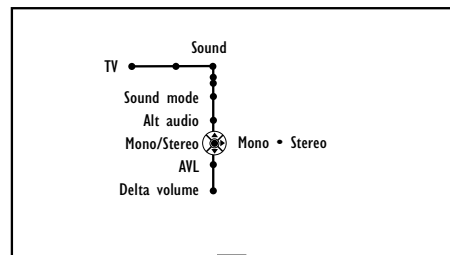
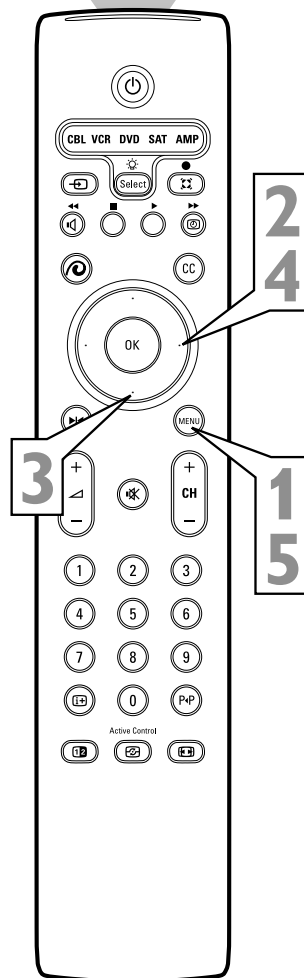
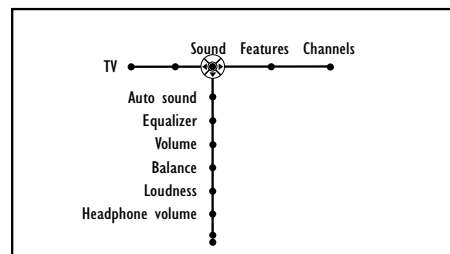
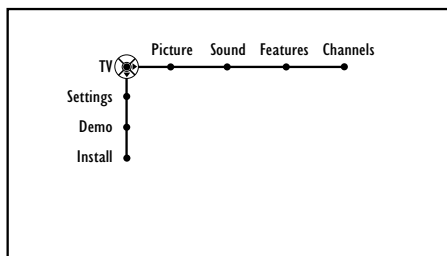

OR

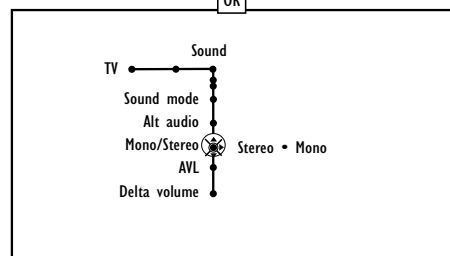

Turning the AVL (Audio Volume Leveler) on or off



You may have noticed the peaks and valleys of sound that occur between program changes or at commercial breaks. The volume levels often vary considerably. By turning on the AVL (Audio Volume Leveler) control, you can make your TV produce a more consistent volume level. Follow the steps below to turn AVL on.

- 1** Press the Menu button on the remote control to display the on-screen menu.
- 2** Press the Cursor Right button repeatedly to select "Sound."
- 3** Press the Cursor Down button repeatedly until AVL is highlighted.
- 4** Press the Cursor Right button to toggle the control on or off.
- 5** Press the Menu button to remove the menu from the TV screen.

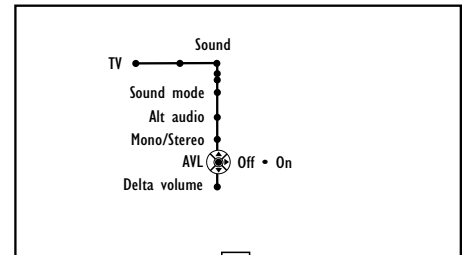
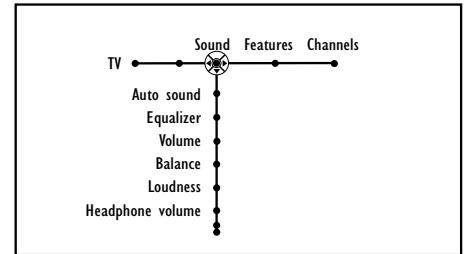
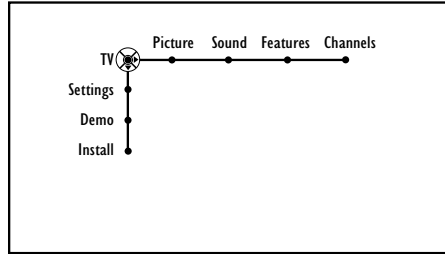

OR

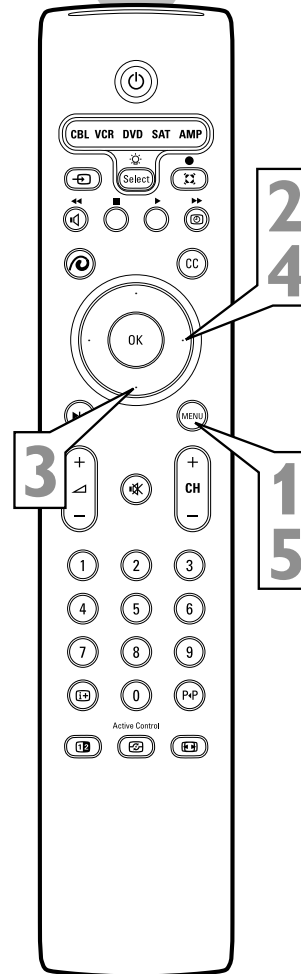
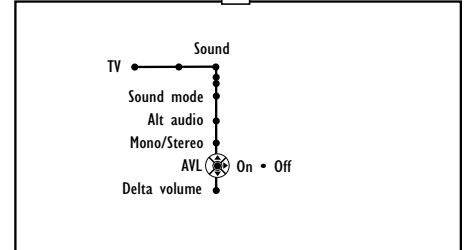



Adjusting the Delta Volume

The volume level coming from channel to channel and broadcast to broadcast can vary widely. The Delta Volume control will allow the volume to be increased for channels with weaker audio signals while allowing other channels with stronger signals to be reduced. When the Delta Volume control is adjusted or changed, it will affect only the currently tuned channel. The TV will store the setting for that channel in its memory and remember it when the channel is tuned again.

NOTE: The Delta Volume control does not work with the headphones.

- 1** Press the CH + or – button on the remote control to tune to a specific channel.
- 2** Press the Menu button on the remote control to show the on-screen menu.
- 3** Press the Cursor Right button repeatedly to select “Sound.”
- 4** Press the Cursor Down button repeatedly until “Delta volume” is highlighted.
- 5** Press the Cursor Left button to decrease the overall volume, or press the Cursor Right button to increase the overall volume for the tuned channel.

Repeat the steps above to adjust the delta volume for additional channels.

- 6** Press the Menu button to remove the on-screen menu from the TV screen.

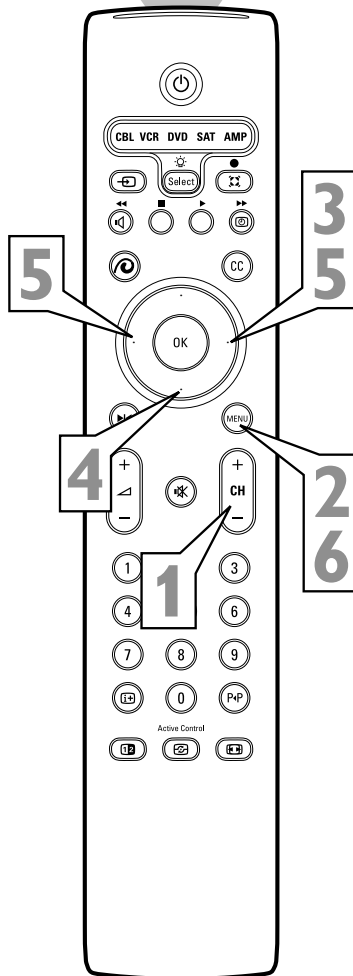
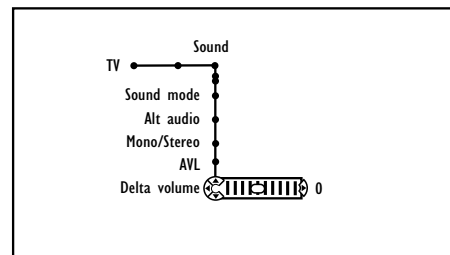
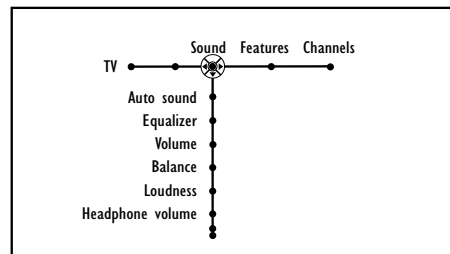
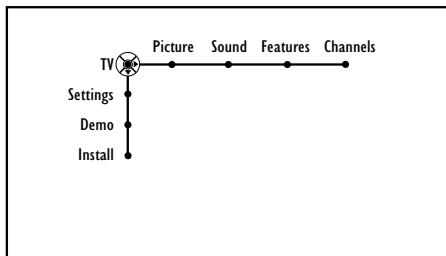

Adjusting Audio Out, TV Speakers



If you have connected the TV's AUDIO OUTPUT jacks to the AUDIO INPUT jacks on an external audio system, you can turn off the TV Speakers. Once the TV Speakers are off, you can adjust the Audio Out to either constant or variable output. With Variable output, adjustments made to the TV volume will change the level going to the external audio system.

NOTE: If TV Speakers are "On" then Audio Out is greyed out and cannot be selected. It is automatically set to "Constant." The TV Speakers must be "Off" to adjust Audio Out.

- 1 Press the Menu button on the remote control to display the on-screen menu.
- 2 Press the Cursor Right button repeatedly to select "Sound."
- 3 Press the Cursor Down button repeatedly until "Audio Out" or "TV Speakers" is highlighted.
- 4 Press the Cursor Right button to toggle the control On or Off for "TV Speakers", Constant or Variable for "Audio Out."
- 5 Press the Menu button to remove the menu from the TV screen.

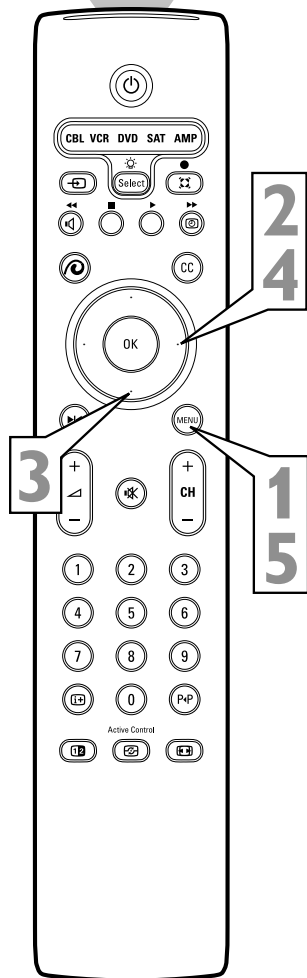
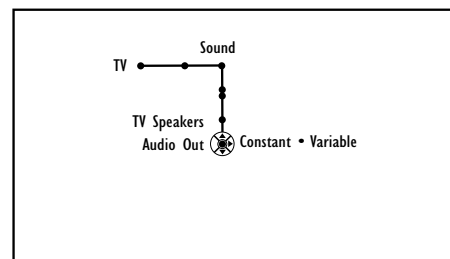
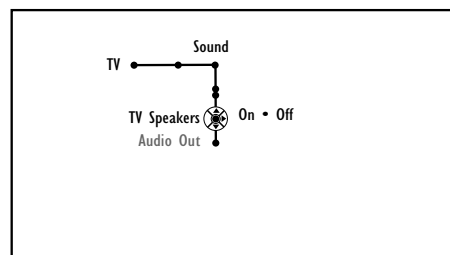
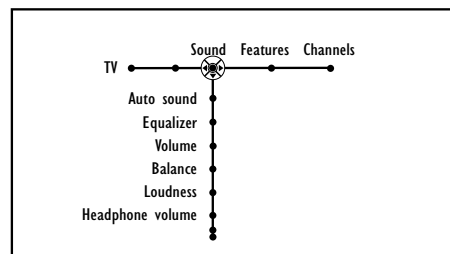
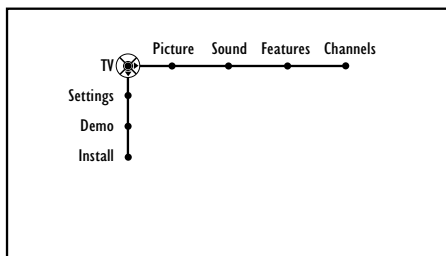



Setting the Sleptimer

The Sleptimer feature allows you to set a timer to automatically switch the TV off after a period of time you choose—5 minutes up to 180 minutes in 5-minute increments.

- 1** Press the Menu button on the remote control to display the on-screen menu.
- 2** Press the Cursor Right button repeatedly until “Features” is selected.
- 3** Press the Cursor Down button repeatedly to select “Sleptimer.”
- 4** Press the Cursor Right button to set the sleptimer in 5-minute increments, from 5 minutes to 180 minutes.
- 5** Press the Menu button to remove the on-screen menu from the TV screen.

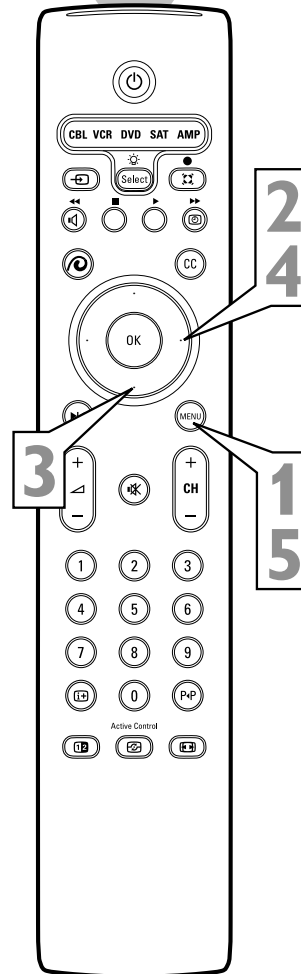
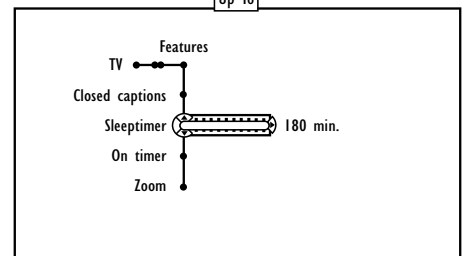
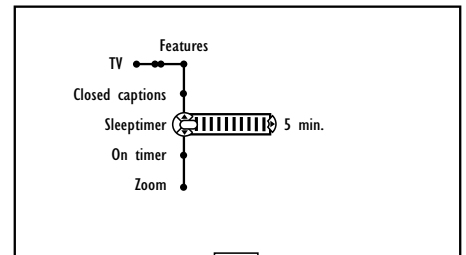
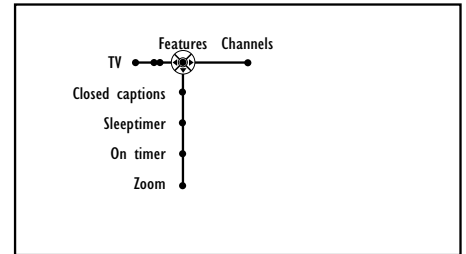
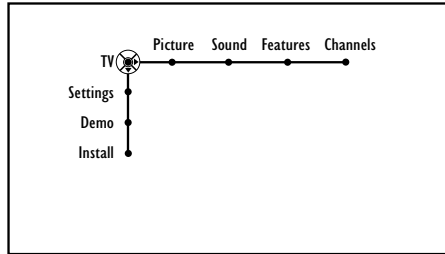

HELPFUL HINTS

- To see how many minutes remain before the TV shuts itself off, press the Information Plus+ button.
- An on-screen countdown will appear during the last minute before the TV shuts itself off. At this time, you may cancel the Sleptimer setting by pressing the OK button on the remote control.

During the last minute of a sleptimer setting, the TV will display a countdown screen that will allow you to cancel the setting.

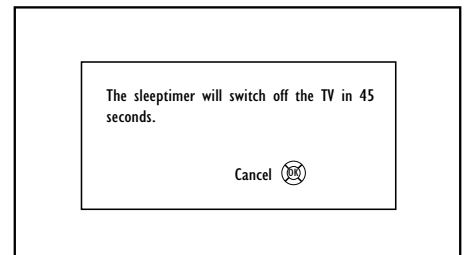

Setting the On Timer



The On Timer control allows you to set a time for the TV to come on automatically at a certain time of day. The on timer can be set to work once or daily at a time you specify.

- 1** Press the Menu button on the remote control to display the on-screen menu.
- 2** Press the Cursor Right button repeatedly to select "Features."
- 3** Press the Cursor Down button repeatedly to select the "On timer" control.
- 4** Press the Cursor Right button to enter the On Timer submenu.
- 5** Press the Cursor Up or Down button to select "On."
- 6** Press the Cursor Right button to shift the menu to the start-channel submenu.
- 7** Press the Cursor Up or Cursor Down button to select the channel you would like the TV to tune to when it turns on.
- 8** Press the Cursor Right button to shift the menu to the day/daily submenu.
- 9** Press the Cursor Up or Down button to select the day to turn on or select "Daily."
- 10** Press the Cursor Right button to enter the AM/PM submenu.
- 11** Press the Cursor Up or Down button to select "AM" or "PM."
- 12** Press the Cursor Right button to enter the start time.
- 13** Press the Number buttons to enter the time. Use "0" first if entering a signal digit (for example, input "0, 1, 3, 0" for 1:30).
- 14** Press the OK button to confirm.
- 15** Press the Menu button to remove the on-screen menu from the TV screen.

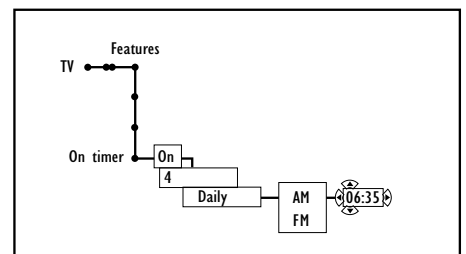
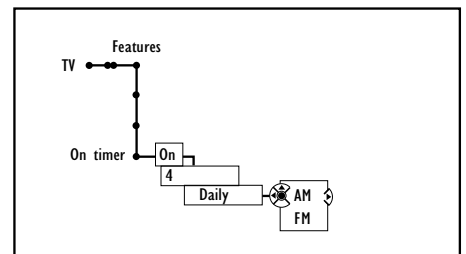
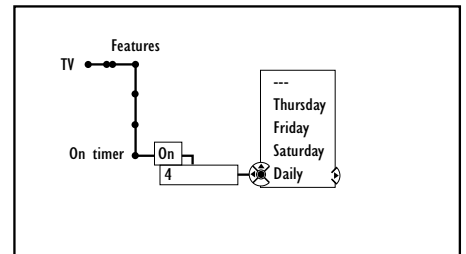
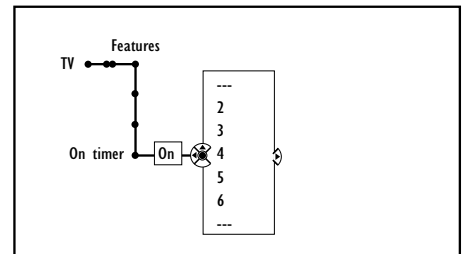
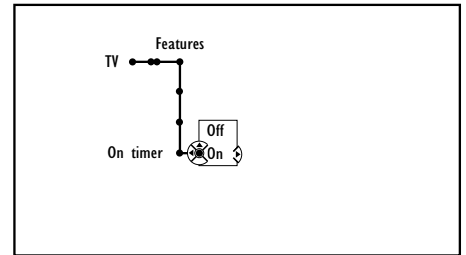
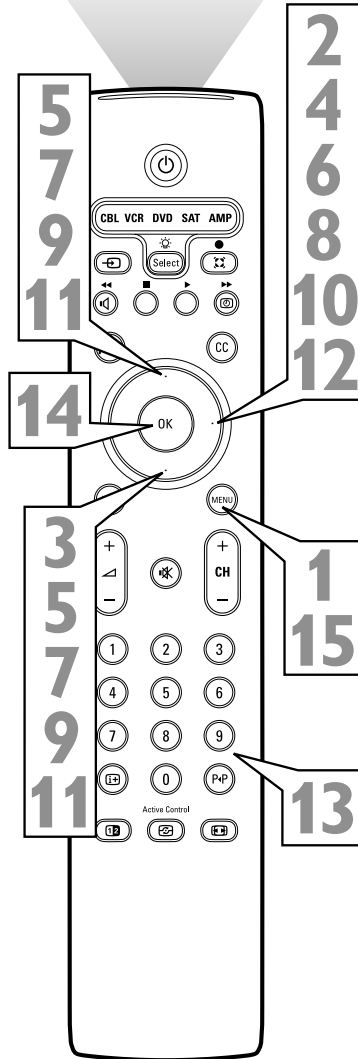
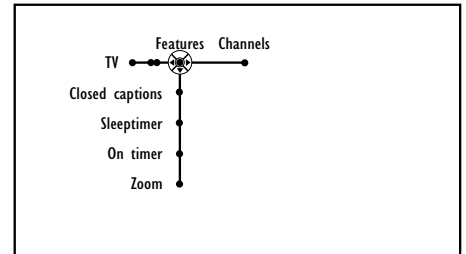
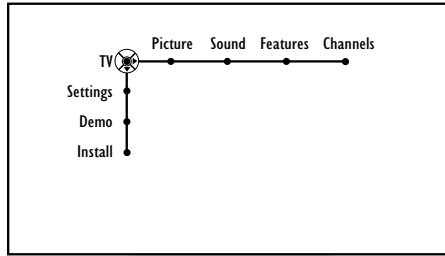

Using Zoom

The Zoom feature allows you to zoom the picture by a factor of 4x, 9x, and 16x.

- 1** Press the Menu button on the remote control to display the on-screen menu.
- 2** Press the Cursor Right button repeatedly until "Features" is selected.
- 3** Press the Cursor Down button repeatedly to select "Zoom."
- 4** Press the Cursor Right button display the Zoom controls.
- 5** Press the Cursor Buttons to place the crosshairs where you would like the enlarged picture to be centered.
- 6** Press Press OK to zoom to picture by 1x (no zoom), 4x, 9x, 16x, and back to 1x.
- 7** Press the Menu button to remove the on-screen menu from the TV screen.

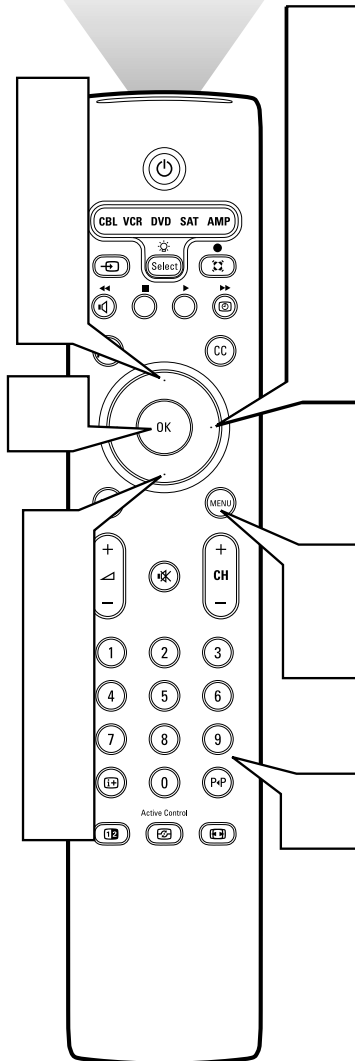
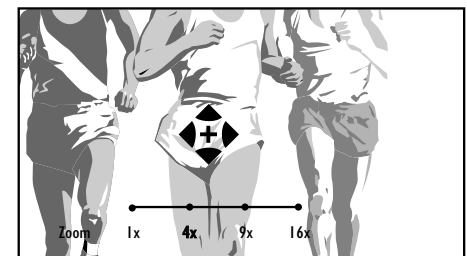
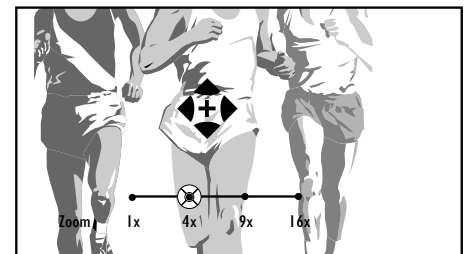
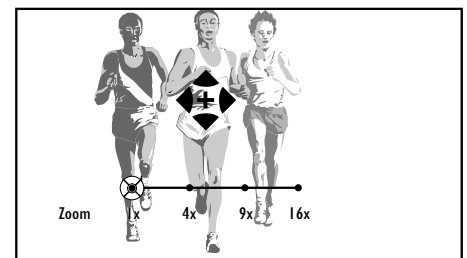
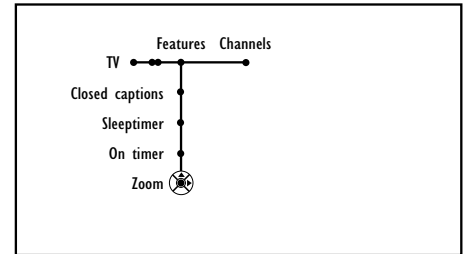
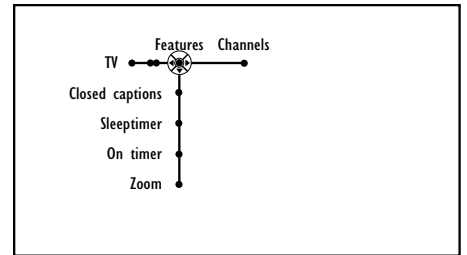
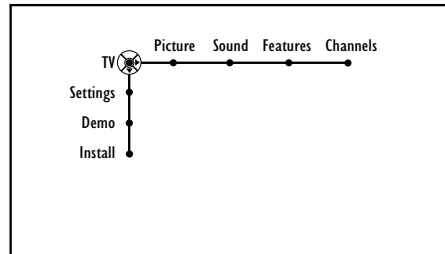

Using the Channel List

The Channel List control shows all the available channels that Auto Programming placed in the TV memory. The channels can be selected from this list.

- 1** Press the Menu button on the remote control to display the on-screen menu.
- 2** Press the Cursor Right button repeatedly to select "Channels."
- 3** Press the Cursor Down button to select the "Channel list" control.
- 4** Press the Cursor Right button to enter the Channel List submenu.
- 5** Press the Cursor Up or Down button to select a specific channel from the list.
- 6** Press the OK button. The television will tune to the selected channel.
- 7** Press the Menu button to remove the on-screen menu from the TV screen.

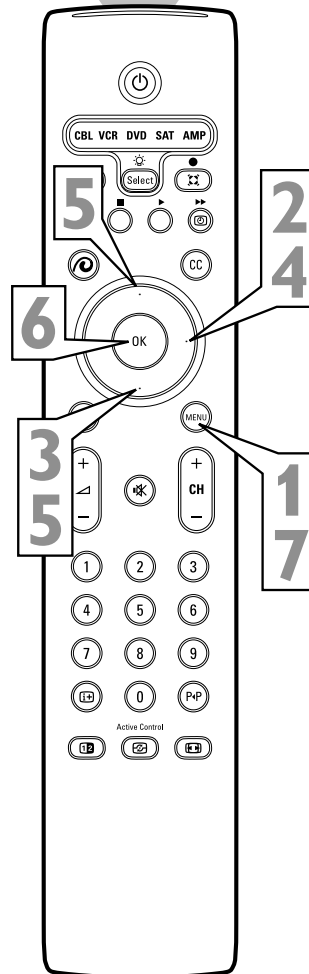
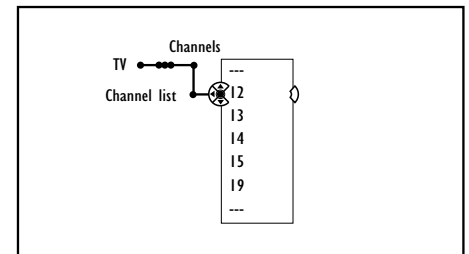
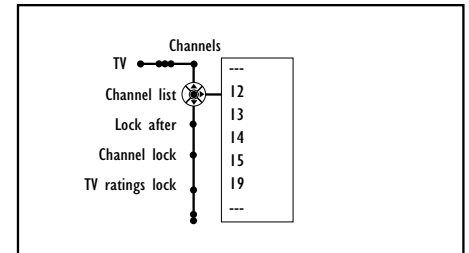
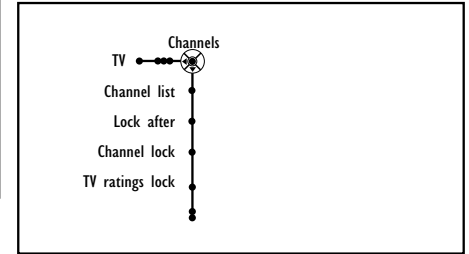
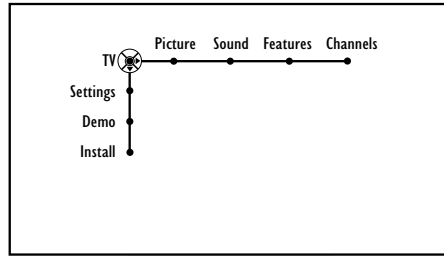

You can remove specific channels from the television's memory by using the Channel Remove control.

- 1** Press the Menu button on the remote control to display the on-screen menu.
- 2** Press the Cursor Right button repeatedly to select "Channels."
- 3** Press the Cursor Down button repeatedly to select the "Channel remove" control.
- 4** Press the Cursor Right button to enter the list of channels in the television's memory.
- 5** Press the Cursor Up or Down button to select a channel you want to remove.
- 6** Press the OK button to activate your choice. After you activate the Channel Remove control, the channel(s) highlighted will no longer be tuned when you press the CH + or - buttons.
- 7** Press the Menu button to remove the on-screen menu from the TV screen.

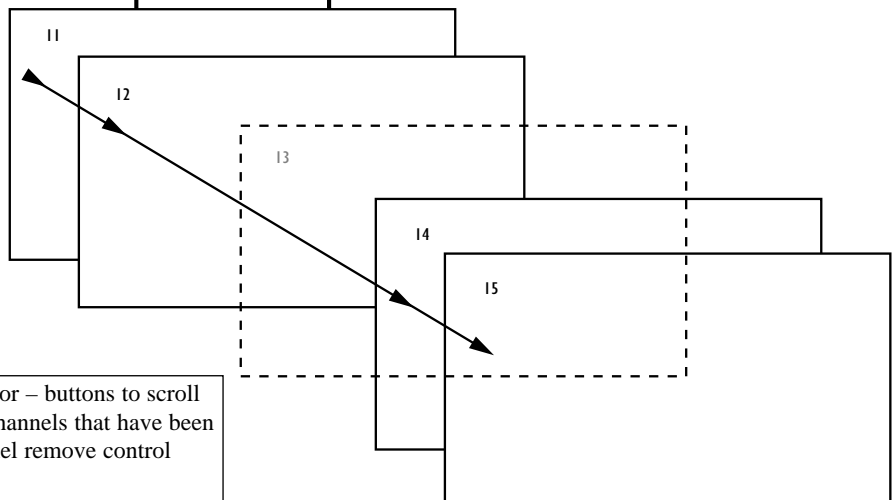
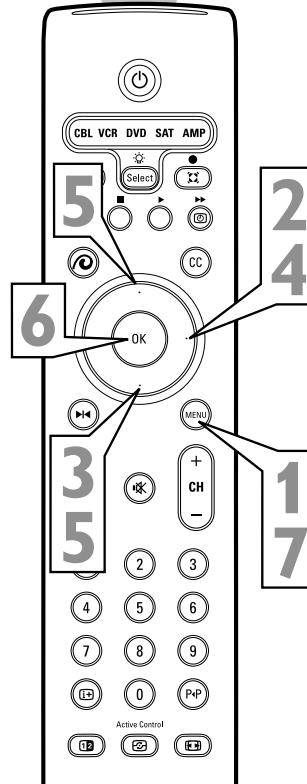
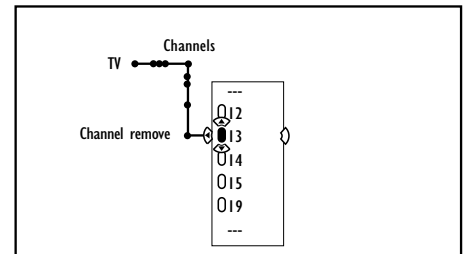
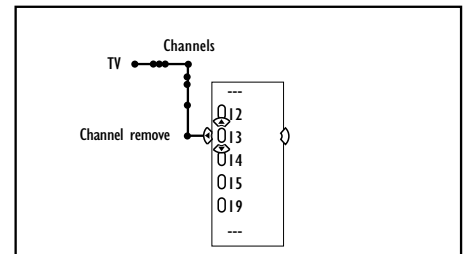
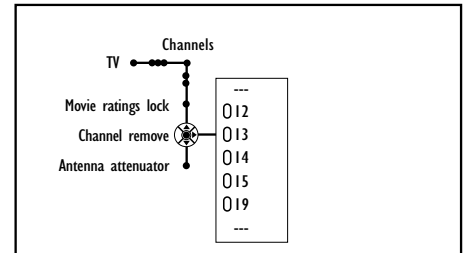
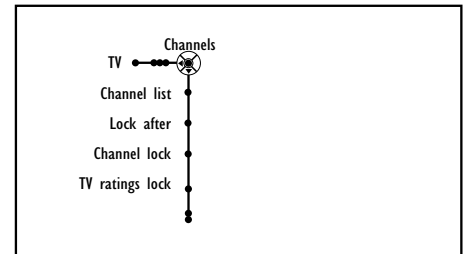
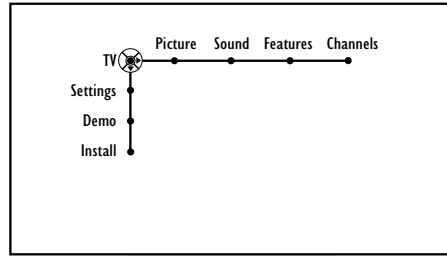

When you use the CH + or - buttons to scroll the available channels, channels that have been removed using the channel remove control will not appear.

For various reasons, you may want to block the viewing of materials on a specific channel or channels or through the audio/video (AV) inputs. Lock Channel provides this capability.

Before using the Lock Channel feature for the first time, you will be asked to enter the PIN number. Use the digit buttons on the remote control to enter the PIN you choose. All number combinations from 0000 to 9999 are valid. After you enter the number once, you will be asked to confirm the number, and then the number is stored.

To change your PIN number, see page 66.

- 1** Press the Menu button on the remote control to display the on-screen menu.
- 2** Press the Cursor Right button repeatedly to select "Channels."
- 3** Press the Cursor Down button repeatedly to highlight the "Channel lock" control.
- 4** Press the Cursor Right button to enter the channel lock submenu.
- 5** Press the Cursor Up or Down button to select a specific channel from the list.
- 6** Press the OK button. The oval in front of the channel number will change to yellow to show that the channel is locked.

Repeat steps 5 and 6 for other channels you want to lock.

- 7** Press the MENU button to remove the on-screen menu from the TV screen.

NOTE: To unlock a locked channel, enter your personal PIN number.

HELPFUL HINT

If you tune to a channel or input source that is locked and you enter your PIN, all locked channels or input sources will be unlocked until the television is shut off. When the television is turned back on again, previously locked channels or input sources will be locked again.

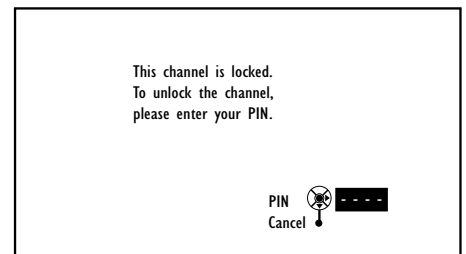
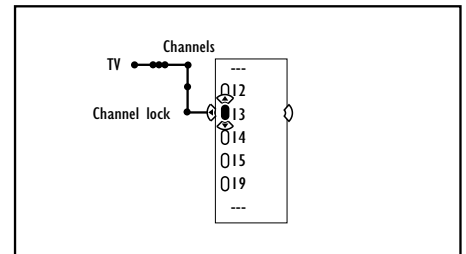
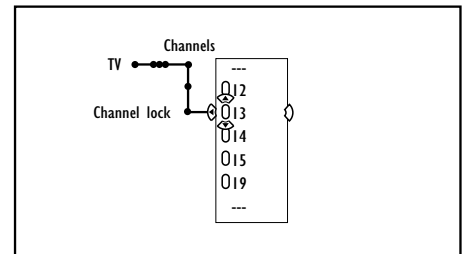
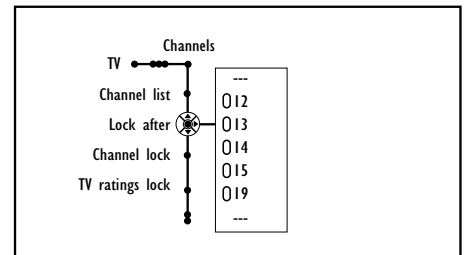
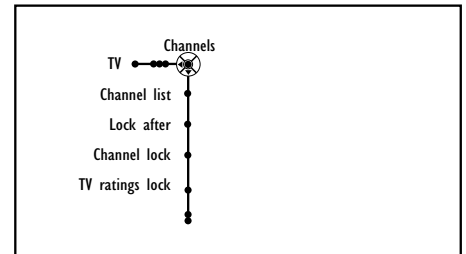
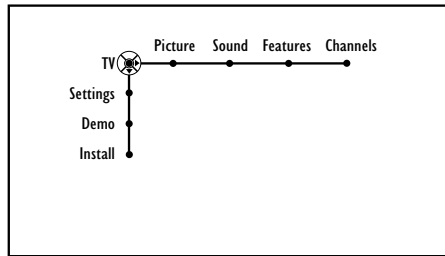

This screen will appear when tuned to a locked channel. To view the channel, enter your PIN.

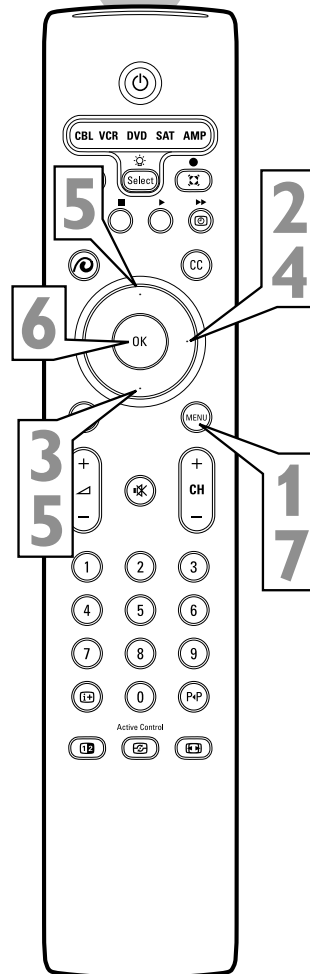

You may want to block programming after a certain time of day. This feature is excellent for limiting the amount of time your children watch TV or for preventing them watching unsuitable programs that are often shown at night.

NOTE: The set automatically unlocks after 3 a.m.

- 1** Press the Menu button on the remote control to display the on-screen menu.
- 2** Press the Cursor Right button repeatedly to select "Channels."
- 3** Press the Cursor Down button repeatedly to select the "Lock after" control.
- 4** Press the Cursor Right button to enter the Lock After submenu (with the options "Off" or "On").
- 5** Press the Cursor Up or Down button to select "On" from the submenu. A submenu with the options of "AM" or "PM" will appear.
- 6** Press the Cursor Right button to enter the AM/PM submenu. A box with the time (or area where the time can be entered) will appear.
- 7** Press the Cursor Up or Down button to select AM or PM.
- 8** Press the Cursor Right button to enter the Lock After time.
- 9** Press the Number buttons to enter the time you want the television to lock all channels.
- 10** Press the Menu button to remove the on-screen menu from the TV screen.

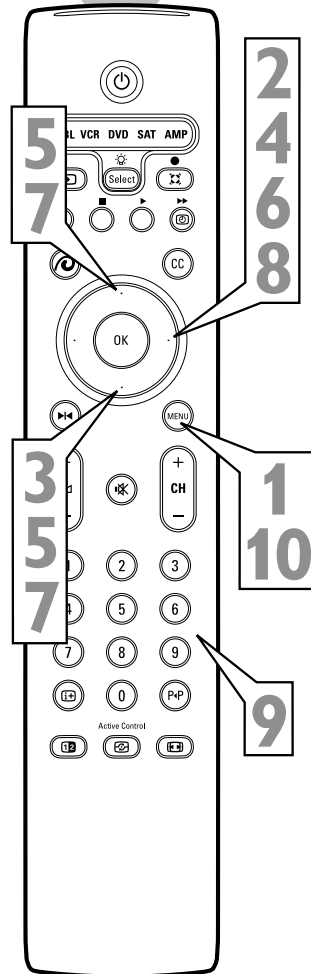
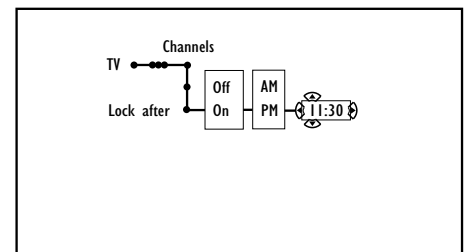
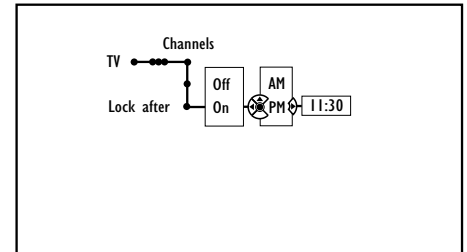
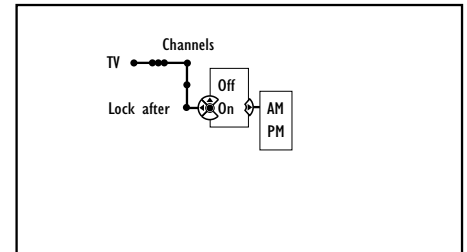
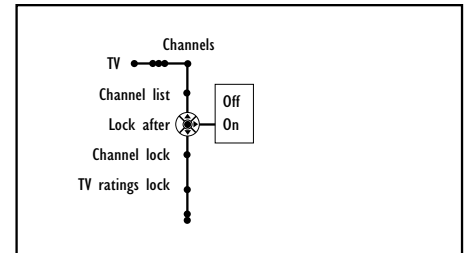
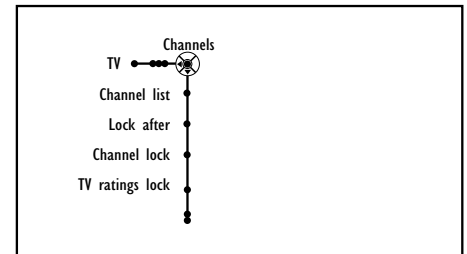
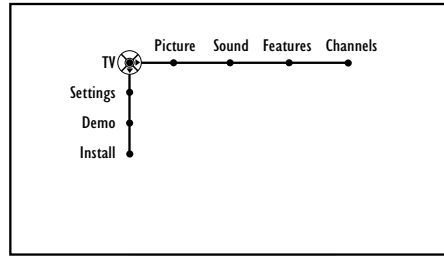

HELPFUL HINT

If you tune to a channel or input source that is locked and you enter your PIN, all locked channels or input sources will be unlocked until the television is shut off. When the television is turned back on again, previously locked channels or input sources will be locked again.

You can select specific TV Ratings to block broadcast signals that have unsuitable content.

- 1** Press the Menu button on the remote control to display the on-screen menu.
- 2** Press the Cursor Right button repeatedly to select "Channels."
- 3** Press the Cursor Down button repeatedly to select the "TV ratings lock" control.
- 4** Press the Cursor Right button to enter the TV Ratings Lock list of options.
- 5** Press the Cursor Up or Down button to select one of the ratings.
- 6** Press the OK button to activate your choice.

NOTE: Whenever a rating is turned on, all higher ratings (with their subratings) will also be turned on, or blocked.

NOTE: Some of the TV Rating options contain specific subratings. "TV-Y7" contains the "(FV) Fantasy Violence" subrating; "TV-PG" and "TV-14" contain "(D) Dialogue," "(L) Language," "(S) Sex," and "(V) Violence" subratings; "TV-MA" contains "(L) Language," "(S) Sex," and "(V) Violence" subratings.

- 7** Press the Menu button to remove the on-screen menu from the TV screen.

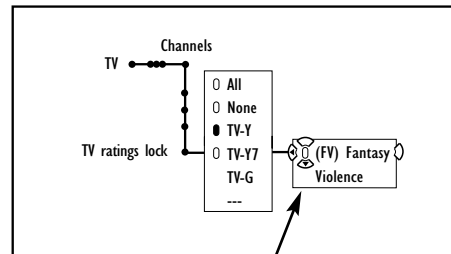
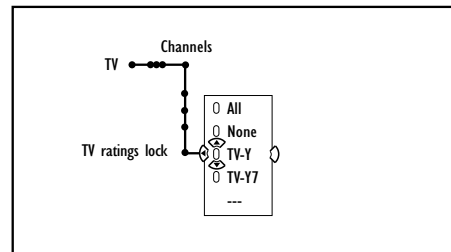
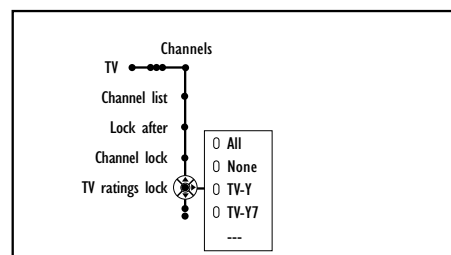
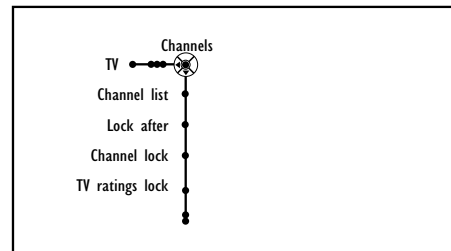
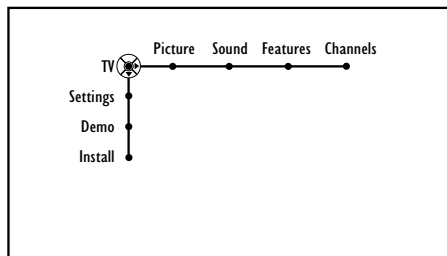

Some TV Ratings have subrating options.

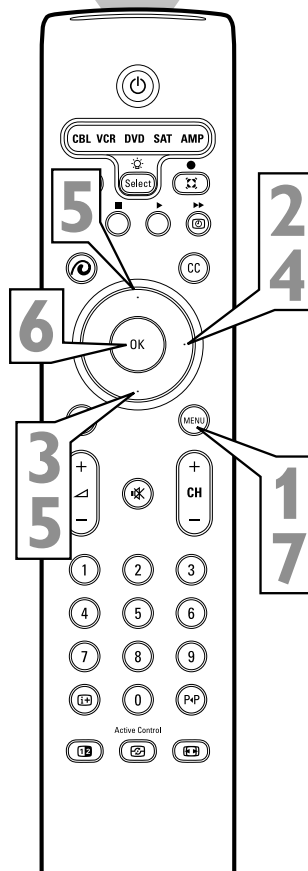

TV Ratings (from TV Broadcasters)

None—programs that are either rated "None" or have no content advisory. Selecting this option will block all such programs.



TV-Y (All Children)—programs designed to be appropriate for all children, especially ones ages 2–6. These programs are not expected to frighten younger children.



TV-Y7 (Directed to Older Children)—programs designed for children ages 7 and older. These programs may be more appropriate for children who have acquired the development skills needed to distinguish between make-believe and reality. Such programs may include mild fantasy and comic violence (FV).



TV-G (General Audience)—most parents will consider programs that are rated TV-G to be suitable for children of all ages. Such programs have little or no violence, no strong language, and little or no sexual dialogue or sexual situations.



TV-PG (Parental Guidance Suggested)—programs contain material that parents may find unsuitable for younger children. This type of programming has one or more of the following: moderate violence (V), some sexual situations (S), infrequent coarse language (L), or some suggestive dialogue (D).



TV-14 (Parents Strongly Cautioned)—programs contain material that many parents will find unsuitable for children under 14 years of age. These programs have one or more of the following: intense violence (V); intense sexual situations (S); strong, coarse language (L); or intensely suggestive dialogue (D).



TV-MA (Mature Audience Only)—specifically designed to be viewed by adults and therefore may be unsuitable for children under 17. Such programs have one or more of the following: graphic violence (V); explicit sexual situations (S); or crude, indecent language (L).

You can prevent the viewing of unsuitable programming based on movie ratings.

- 1** Press the Menu button on the remote control to display the on-screen menu.
- 2** Press the Cursor Right button repeatedly to select "Channels."
- 3** Press the Cursor Down button repeatedly to select the "Movie ratings lock" control.
- 4** Press the Cursor Right button to enter the Movie Ratings Lock list of options.
- 5** Press the Cursor Up or Down button to select the rating you want to lock.
- 6** Press the OK button to activate your choice.
NOTE: When a rating is turned on, all higher ratings (and subratings) will be turned on. (for example, if "R" is selected, "NC-17" and "X" will automatically turn on also.)
- 7** Press the MENU button to remove the on-screen menu from the TV screen.

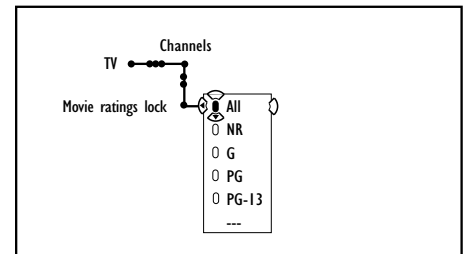
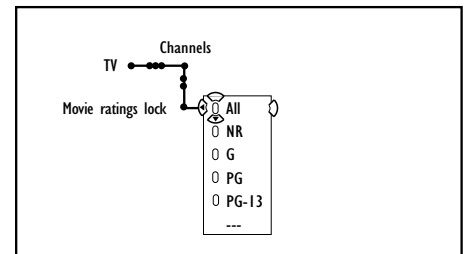
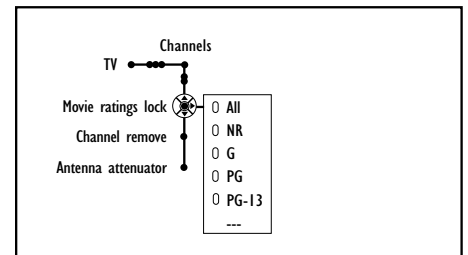
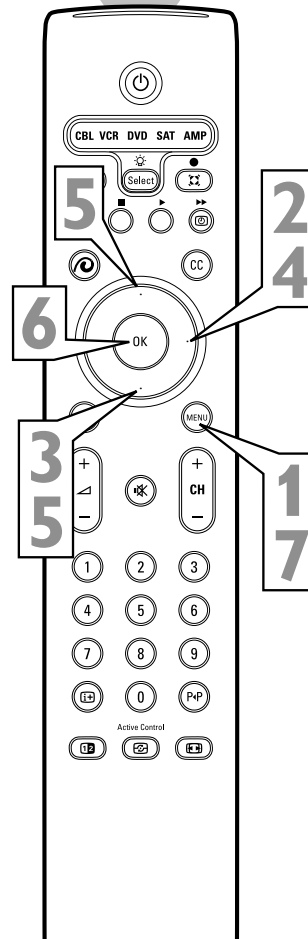
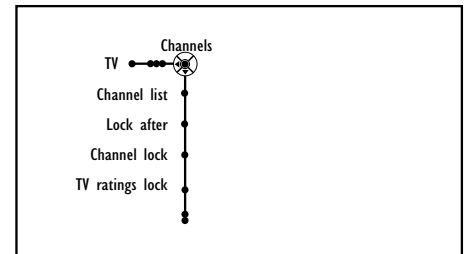
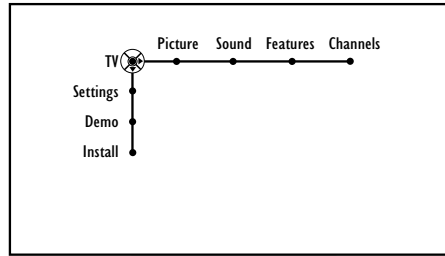

Movie Ratings (from the Motion Picture Association of America)

NR (Not Rated)—programs that the Motion Picture Association of America has chosen not to rate.

G (General Audience)—all ages admitted. Most parents will find programs that are rated G to be suitable for children of all ages. Such programs have little or no violence, no strong language, and little or no sexual dialogue or sexual situations.

PG (Parental Guidance Suggested)—contain material that parents may find unsuitable for younger children. These programs have one or more of the following: moderate violence, some sexual situations, infrequent coarse language, or some suggestive dialogue.

PG-13 (Parents Strongly Cautioned)—contain material that parents may find unsuitable for children under the age of 13. Programs that are rated PG-13 have one or more of the following: violence, sexual situations, coarse language, or suggestive dialogue.

R (Restricted)—specifically designed for adults. Anyone under the age of 17 should view programs that are rated R only with an accompanying parent or adult guardian. Such programs have one or more of the following: intense violence; intense sexual situations; strong, coarse language; or intensely suggestive dialogue.

NC-17 (No one under the age of 17 will be admitted)—should be viewed by adults only. These programs have graphic violence; explicit sex; or crude, indecent language.

X (Adults Only)—contain one or more of the following: very graphic violence, very graphic and explicit or indecent sexual acts, or very coarse and intensely suggestive language.

Turning the Antenna Attenuator on or off

If you live near a television station's transmitter tower, you may receive an interfering signal from the station while watching other TV channels. Your television's Antenna Attenuator control is designed to reduce the strength of such a signal in the presence of a strong main signal. The default setting for the Antenna Attenuator is "Off." If you need to use the feature, simply toggle it "On" in the on-screen menu.

- 1** Press the Menu button on the remote control to display the on-screen menu.
- 2** Press the Cursor Right button repeatedly to select "Channels."
- 3** Press the Cursor Down button repeatedly to select the "Antenna attenuator" control.
- 4** Press the Cursor Right button to toggle the control "On" or "Off."
- 5** Press the Menu button to remove the on-screen menu from the TV screen.

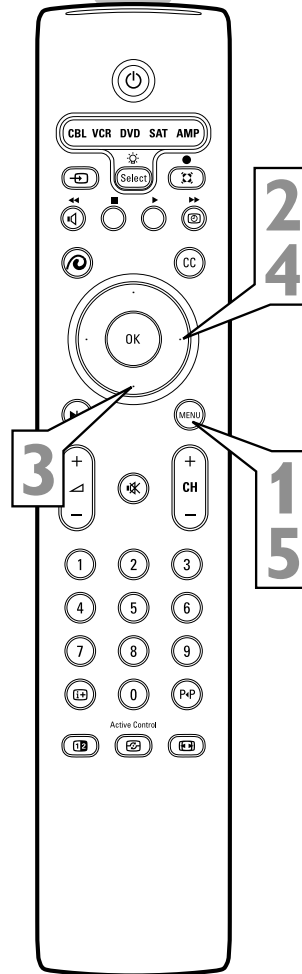
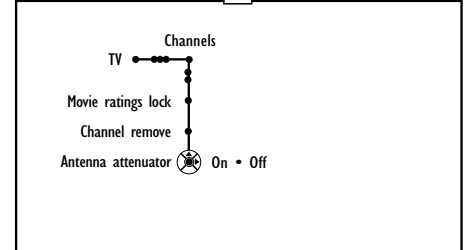
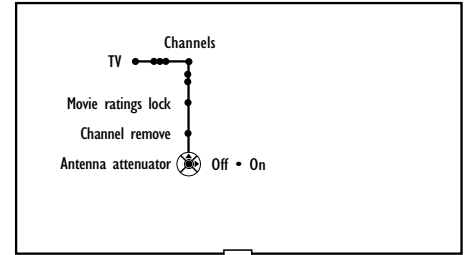
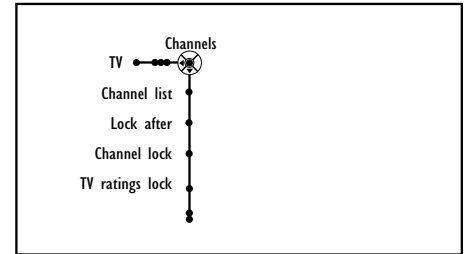
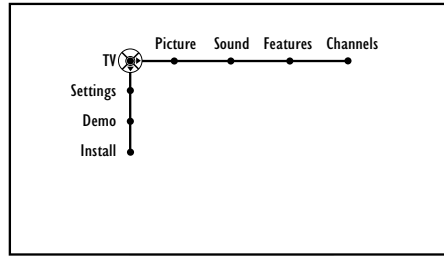

Turning the Menu Background on or off

You have the option of turning on a background that will make reading the on-screen menu easier. The Menu Background control places a light colored field behind the on-screen menu that makes it easier to see. When turned on, the menu background appears only while the on-screen menu is displayed on the TV screen.

- 1** Press the Menu button on the remote control to display the on-screen menu.
- 2** Press the Cursor Down button to select "Settings."
- 3** Press the Cursor Right button to select the "General" menu.
- 4** Press the Cursor Down button to select the "Menu background" control.
- 5** Press the Cursor Right button to toggle the menu background control "On" or "Off."
- 6** Press the Menu button to remove the on-screen menu from the TV screen.

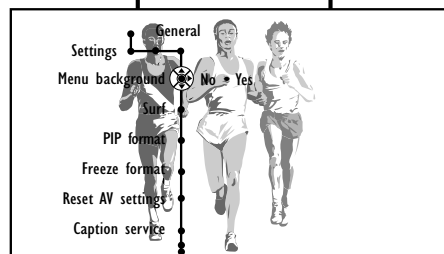
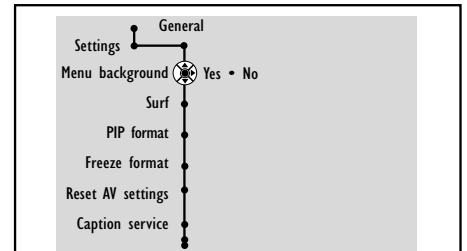
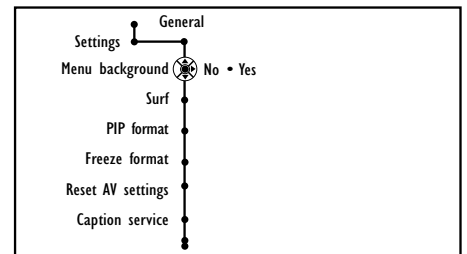
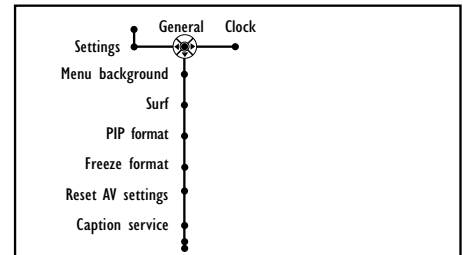
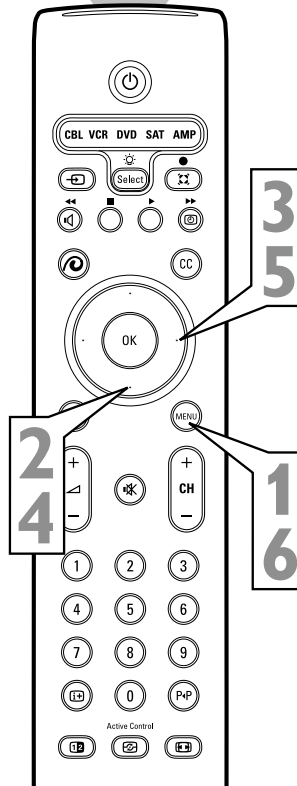
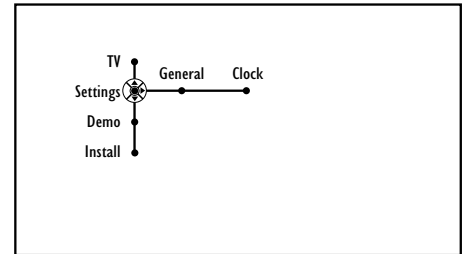
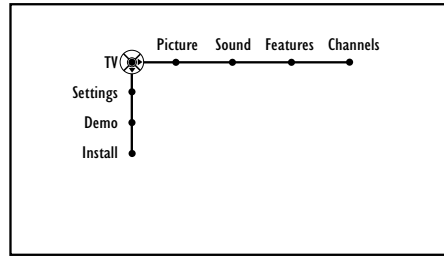

With Menu Background off

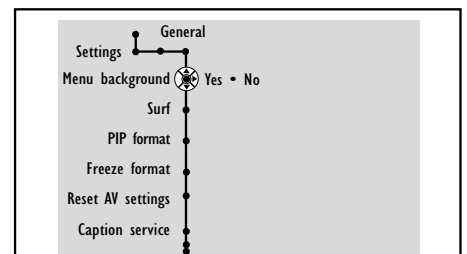

With Menu Background on

Using Surf

You can access a list of previously viewed channels with the Previous Program/Surf button (labeled "P◀P") on the remote control. With Surf you can easily switch between different TV channels that currently interest you. Surf allows you to set up the television to cycle through two or nine channels by pressing the Surf (P◀P) button on the remote control.

- 1** Press the Menu button on the remote control to display the on-screen menu.
- 2** Press the Cursor Down button to select "Settings."
- 3** Press the Cursor Right button to select the "General" menu.
- 4** Press the Cursor Down button repeatedly to select the "Surf" control.
- 5** Press the Cursor Right button to toggle the Surf control to "2 channels" or "9 channels."
- 6** Press the Menu button to remove the on-screen menu from the TV screen.

If you selected the "2 channels" Surf option, pressing the P◀P (Surf) button allows you to alternate between the currently viewed channel and the previously viewed channel.

If you selected the "9 channels" Surf option, pressing the P◀P (Surf) button displays a Surf list in which you can place up to 9 favorite channels. A/V sources also can be included in the list.

To add a channel to the list, tune to the channel, press the P◀P (Surf) button, then press the Cursor Right button.

If you attempt to add more than 9 channels to the list, the last channel will be automatically removed to make room for the newly added channel.

After you have placed your favorite channels in the list, press the P◀P (Surf) button as many times as necessary to tune to the desired favorite channel. Or, with the Surf list displayed, press the Cursor Down or Up buttons to tune to the desired channel.

To remove a channel from the list, press the P◀P (Surf) button to display the list, press the Cursor Down or Up buttons until you select the channel you want to remove, then press the Cursor Right button.

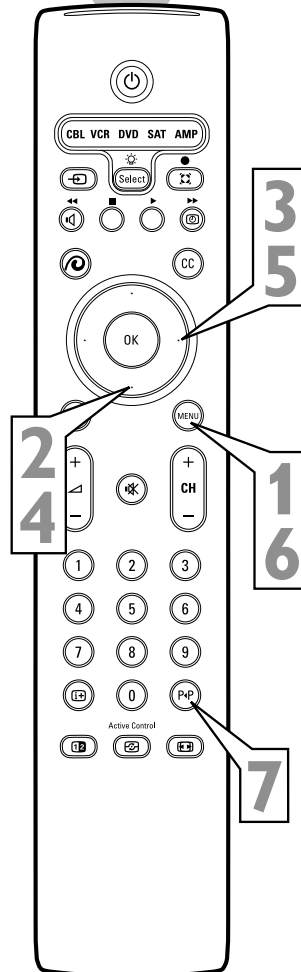
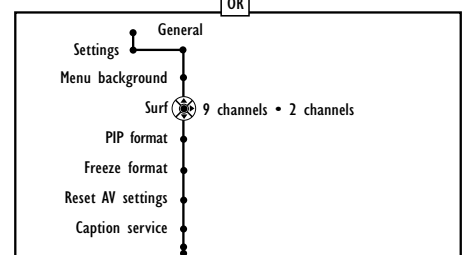
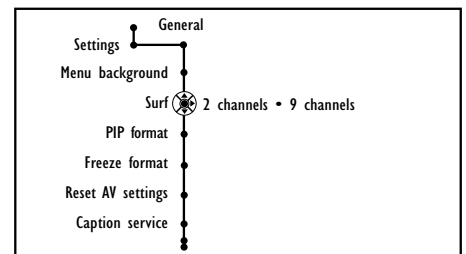
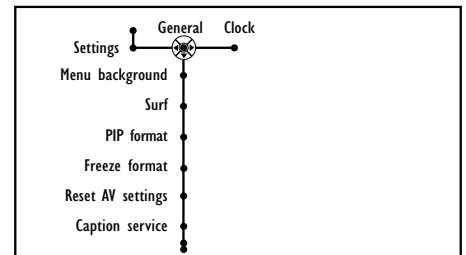
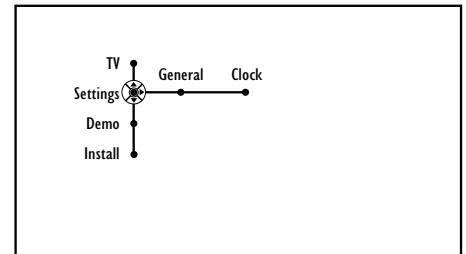
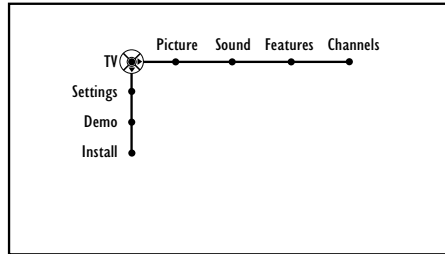

2 Channels Surf

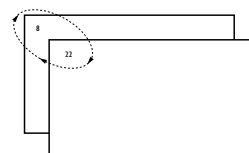

9 Channels Surf

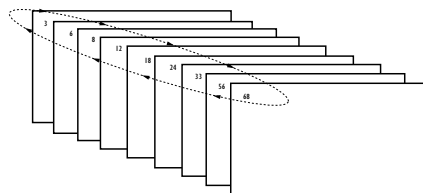

Using 9 Channels Surf, place up to 9 favorite channels in the Surf list.



If you decide you don't want a channel in the list, you can remove it.

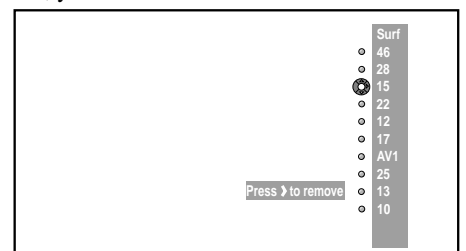

The Dual Screen feature, also referred to as Picture In Picture (PIP), will allow you to choose the size of the dual screen window to be displayed when the Dual Screen/PIP button is pressed on the remote control. The window can be set to Dual Screen, PIP, PIP 3, or PIP 6.

- 1** Press the Menu button on the remote control to display the on-screen menu.
- 2** Press the Cursor Down button to select "Settings."
- 3** Press the Cursor Right button to select the "General" menu.
- 4** Press the Cursor Down button repeatedly to select the "PIP Format" control. A submenu or list of options will appear.
- 5** Press the Cursor Right button to enter the list of options.
- 6** Press the Cursor Up or Down button to select the desired PIP format. Choose from "Dual screen," "PIP," "PIP 3," or "PIP 6."
- 7** Press the Menu button to remove the on-screen menu from the TV screen.
- 8** Press the Dual Screen/PIP button on the remote control to display the second video window in the format you have chosen.

Continuing to hold the Dual Screen/PIP button will cycle through the Dual Screen/PIP options.

Press the Dual Screen button again to return the television to the main video screen.

See the next page for information on changing channels or input sources in Dual Screen/PIP mode, and for re-positioning the PIP screens.

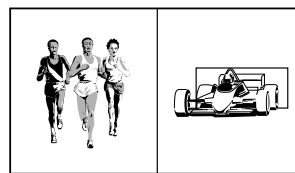
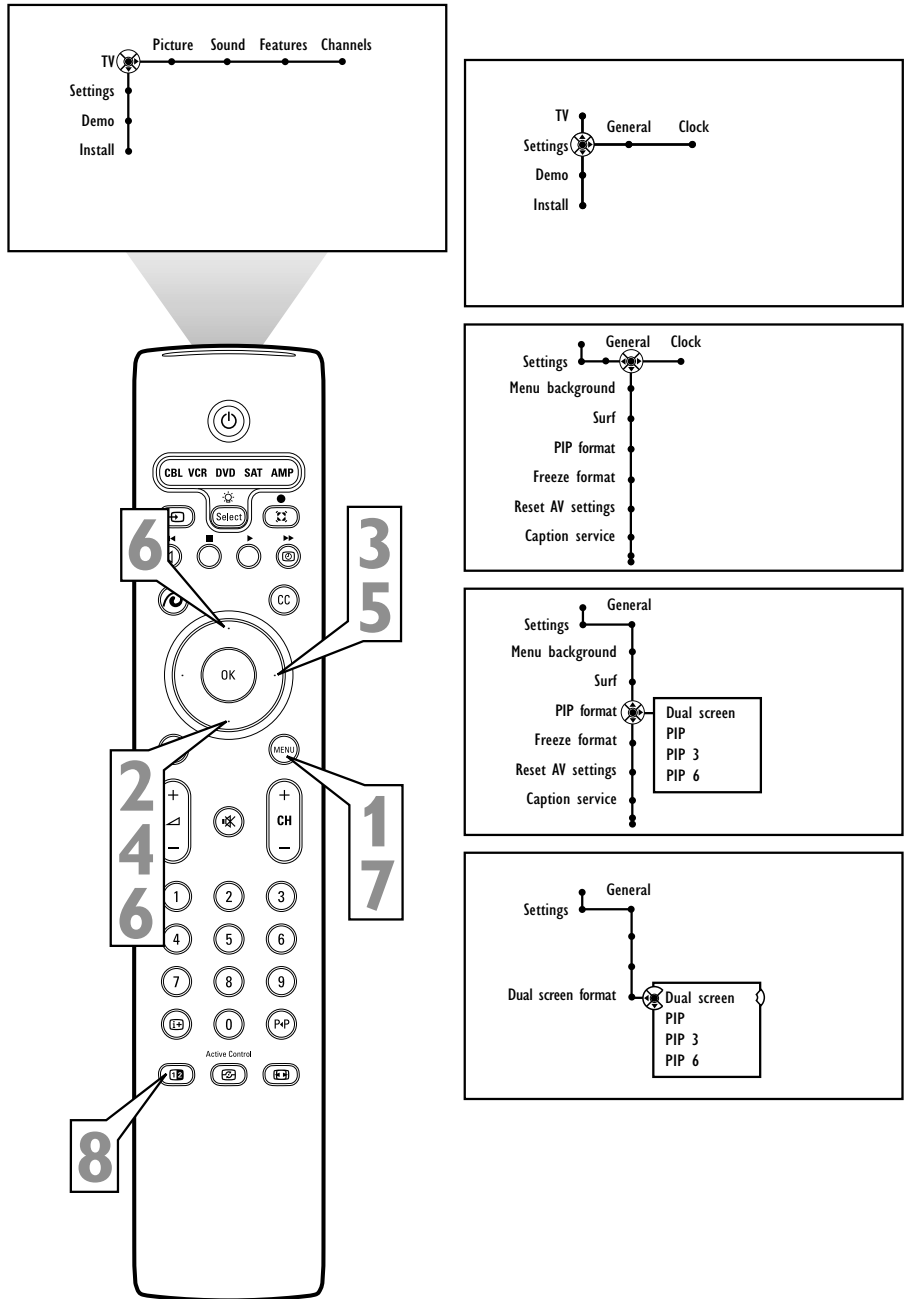

Dual Screen



PIP

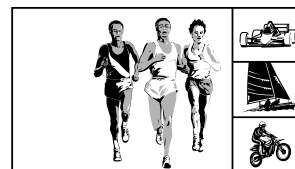

PIP 3



PIP 6

When using Dual Screen:

- 1** A light-colored border indicates the selected screen. If the screen whose channel or input source you want to change is not selected, press the Cursor Right or Left button to select the desired screen.
 - 2** To change channels in the selected screen, press the CH (Channel Selection) + or – buttons.
 - Or:
 - 3** To change the input source, first press the Source button. Then, within 6 seconds, press the Cursor Up or Down until your desired input source is highlighted. Press the OK button to confirm. The desired input source appears in the selected screen.
- NOTE:** If the list of input sources “times out” (leaves the screen) before you can make your selection, press the Source button again to display the list again.

When using PIP:

- 1** When the PIP window is on screen, press the Cursor Up or Down button to select either the main or PIP screen. A light-colored border surrounds the PIP screen when it is selected. The PIP screen must be selected before its channel or input source can be changed.
 - 2** To switch the PIP window and the main window press OK.
 - 3** To change channels in the PIP screen, press the CH (Channel Selection) + or – buttons.
 - Or:
 - 4** To select a different input source, first press the Source button. Then, within 6 seconds, press the Cursor Up or Down until your desired input source is highlighted. Press the OK button to confirm. The desired input source appears in the PIP screen.
- NOTE:** If the list of input sources “times out” (leaves the screen) before you can make your selection, press the Source button again to display the list again.

To reposition or resize the PIP screen:

- 5** Press the Cursor Down button to select Position or Size and press OK.
- 6** If you select Position, a direction indicator appears on the screen. If you select size a slider bar appears with 12 size options. Use Cursor Up, Down, Left, and Right to adjust the position or the Size slider bar.
- 7** Press OK to return to the PIP menu. The menu will disappear in several seconds.

When using PIP3 or PIP6:

To change channels when in PIP3 or PIP6 modes, press the Cursor Right, Left, Up, or Down buttons to select the screen whose channel or source you want to change. Then follow step 2 or 3 in either section above to change channels or input sources.

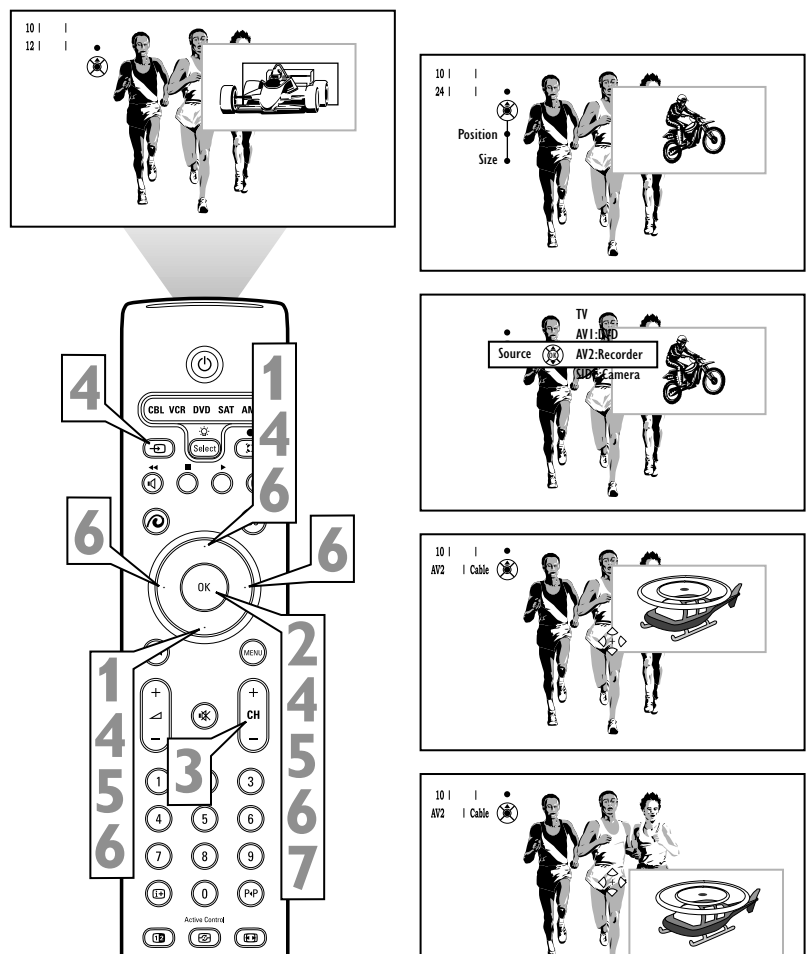
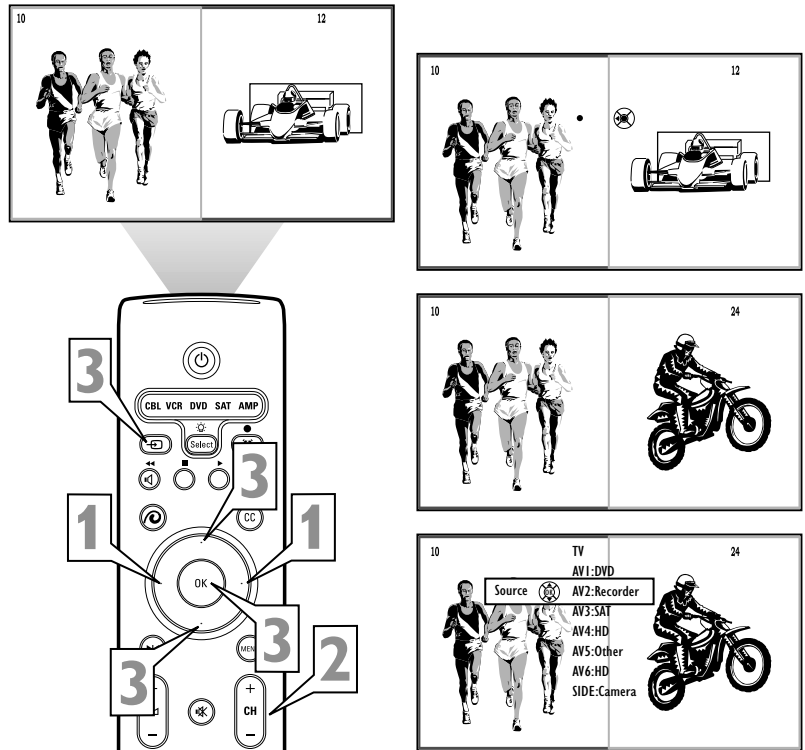

The Freeze control provides three ways for you to stop the action of programs. The Freeze control options allow you to get a better look at exciting sports plays or copy down broadcasted addresses or phone numbers. The steps below explain how to select an option.

- 1** Press the Menu button on the remote control to display the on-screen menu.
 - 2** Press the Cursor Down button to select "Settings."
 - 3** Press the Cursor Right button to highlight the "General" menu.
 - 4** Press the Cursor Down button repeatedly to highlight the "Freeze format" control. A submenu will appear.
 - 5** Press the Cursor Right button to enter the submenu.
 - 6** Press the Cursor Up or Down button to select the desired freeze format. Choose from "Freeze," "Replay," or "Photo finish."
 - 7** Press the Menu button to remove the on-screen menu from the TV screen.
 - 8** Press the Freeze Format button on the remote control to display the format you have chosen.
- NOTE:** Continuing to hold the Freeze Format button will cycle the TV through the Freeze modes.
- To return the television to the main video screen, press the Freeze button again.

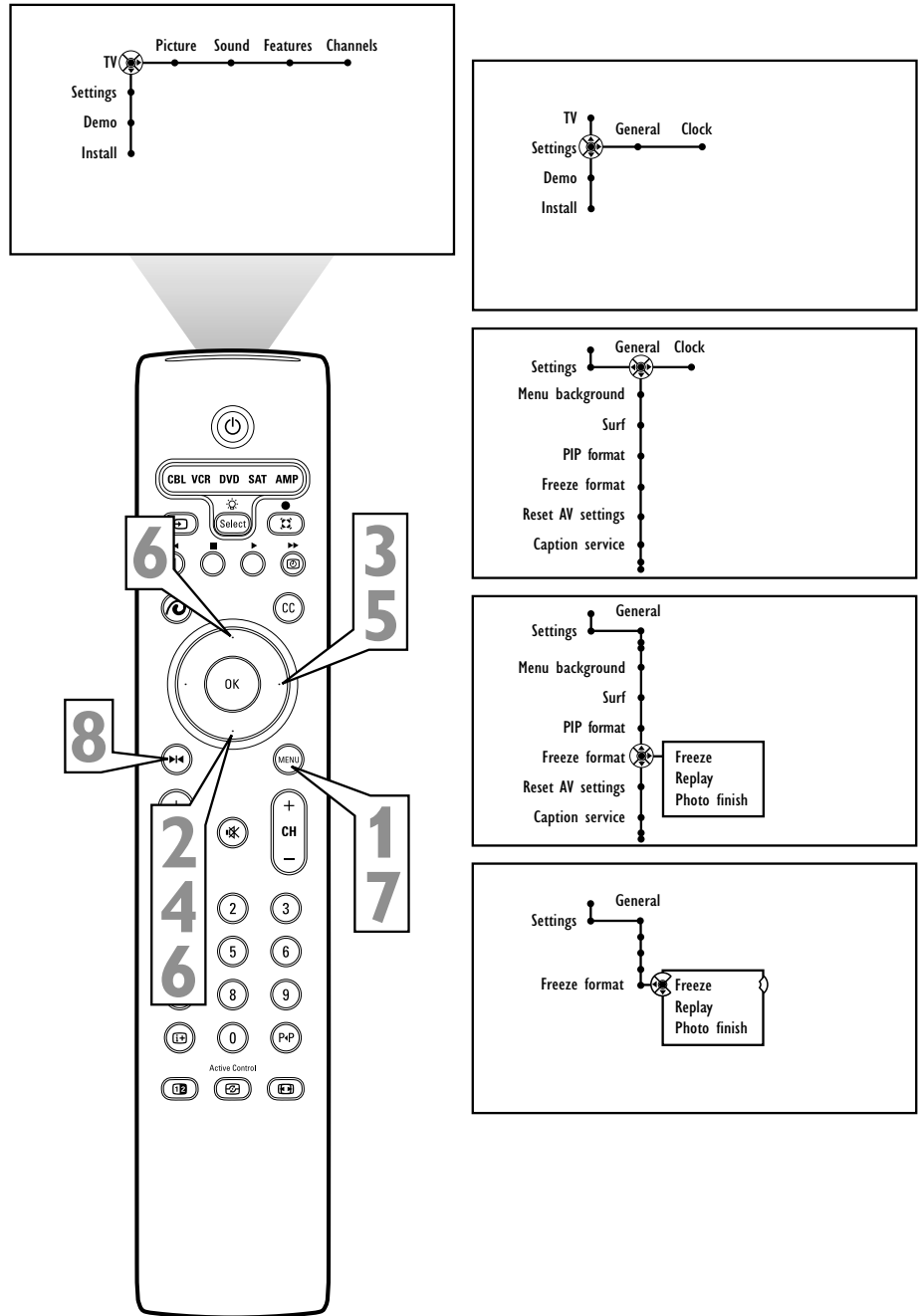

Freeze

Stops motion on the main screen.



Replay

Replays a few seconds of stored video.

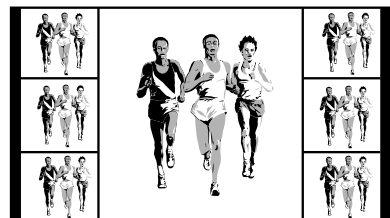

Photo finish

Displays six still frames from a TV picture while the current program continues to play on the main (center) screen.

NOTE: Frame order will vary.

Resetting the Audio/Video Settings to Factory Default Values

G

You can reset the TV's Sound and Picture settings to the factory default values.

- 1 Press the Menu button on the remote control to display the on-screen menu.
- 2 Press the Cursor Down button to select "Settings."
- 3 Press the Cursor Right button to select the "General" menu.
- 4 Press the Cursor Down button repeatedly to select the "Reset AV settings" control.
- 5 Press the OK button to reset the AV settings to factory values.
- 6 Press the Menu button to remove the on-screen menu from the TV screen.

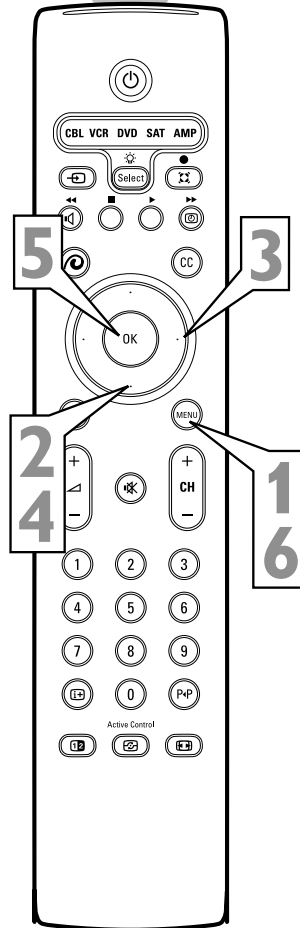
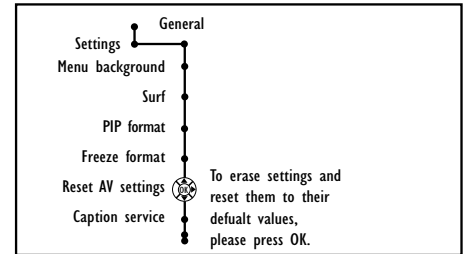
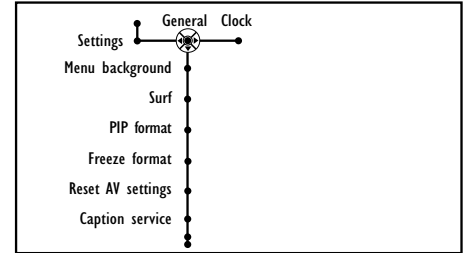
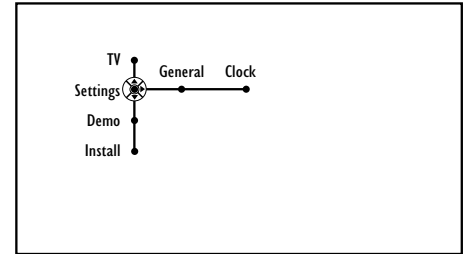
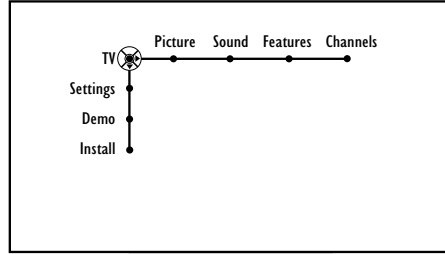

Using Closed Captioning

Closed Captioning (CC) allows you to read the voice content of television programs on the TV screen. Designed to help the hearing impaired, this feature uses on-screen text boxes to show dialogue and conversations while the TV program is in progress. Captions will appear on screen during captioned broadcasts.

Follow steps 1 through 7 to select a Closed Captioning option:

- 1 Press the Menu button on the remote control to display the on-screen menu.
- 2 Press the Cursor Down button repeatedly to select "Settings."
- 3 Press the Cursor Right button to select "General."
- 4 Press the Cursor Down button repeatedly to select "Caption service."
- 5 Press the Cursor Right button to enter the caption service submenu.
- 6 Press the Cursor Up or Down button to select one of the caption modes: **CC-1, CC-2, CC-3, or CC-4**—Dialogue (and descriptions) for the action on the captioned TV program shows on screen. CC-1 is used most frequently. CC-2 may be used for alternate languages if they are being transmitted. **T-1, T-2, T-3, or T-4**—Often used for a channel guide, schedules, bulletin board information for captioned programs, news, weather information, or stock market reports.

NOTES

- Text Modes (T-1 through T-4) appear on screen as boxes and may block portions of the TV screen.
- Not all caption services are necessarily being used by a TV channel during the transmission of a captioned program.

- 7 Press the Menu button to remove the on-screen menu from the TV screen.

To turn Closed Captioning on or off:

- 8 Press the CC button on the remote control.
- 9 Press the Cursor Up or Down button repeatedly to select "Off," "On," or "On during mute."
 - Off**—Closed captioning service will not be displayed on the TV screen.
 - On**—Closed captioning information (if available) will display on the TV screen.
 - On during mute**—Closed Captioning information will turn on only when the Mute button is pressed. Turns the Closed Captioning information off when the TV volume is restored.

- 10 Press the Menu button on the remote to remove the on-screen display from the TV screen.

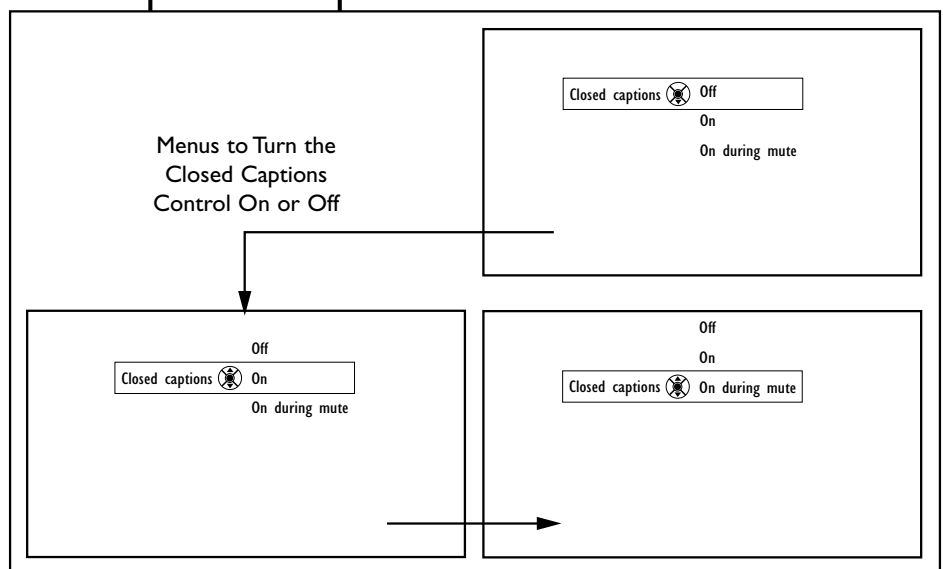
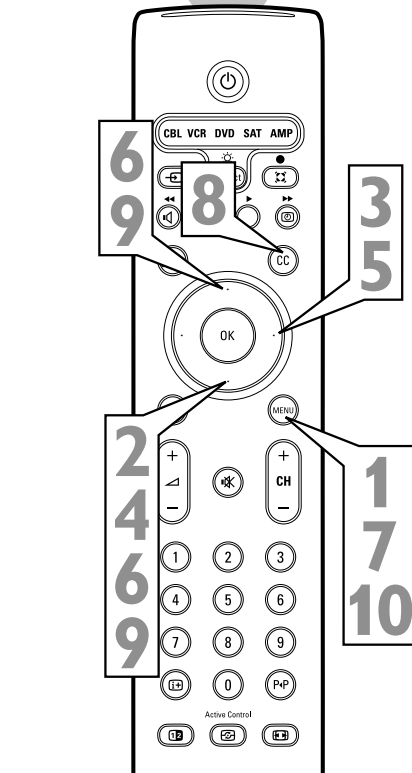
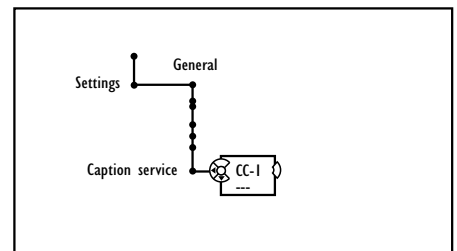
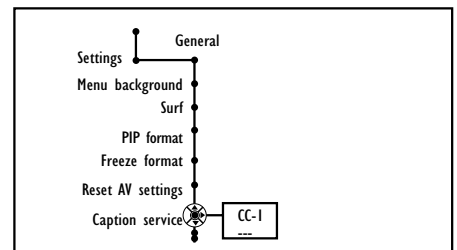
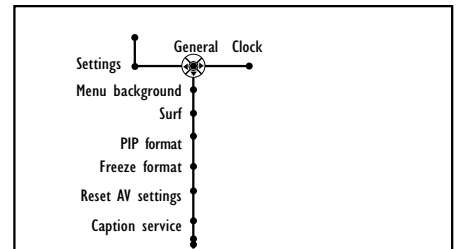
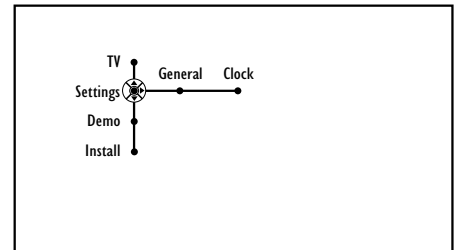
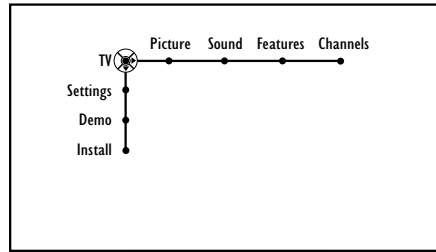

NOTES: • The captions do not always use correct spelling and grammar. • Not all TV programs and product commercials made for broadcast include Closed Captioning information. Refer to your area's TV program listings for the TV channels and times of shows with Closed Captioning. The captioned programs are usually noted in the TV listings with service marks such as "CC."

Selecting an On-screen Display Option

The television's on-screen display (OSD) can be set to show only the current channel number or the channel number with additional TV operating modes and status-screen information.

- 1** Press the Menu button on the remote control to display the on-screen menu.
- 2** Press the Cursor Down button to select "Settings."
- 3** Press the Cursor Right button to select the "General" menu.
- 4** Press the Cursor Down button repeatedly to select the "OSD" control.
- 5** Press the Cursor Right button to toggle between "Minimum" and "Normal."
In Normal mode the on-screen display stays on screen. In Minimum mode the on-screen display disappears after a few seconds.
- 6** Press the Menu button to remove the on-screen menu from the TV screen.

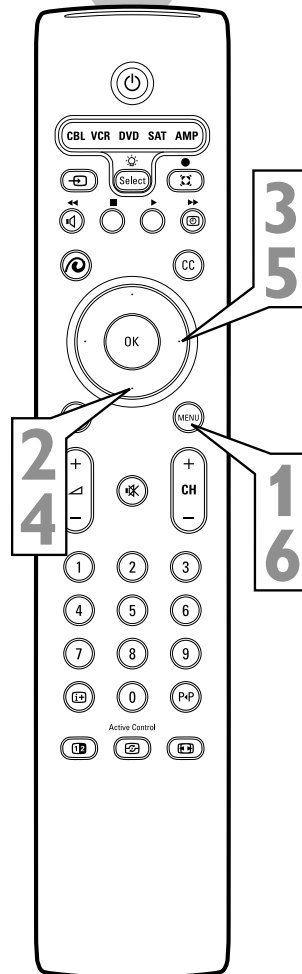
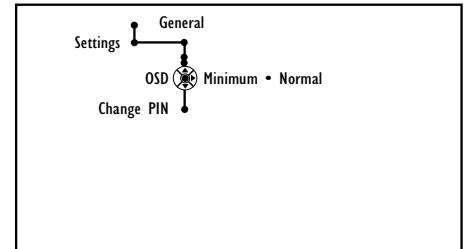
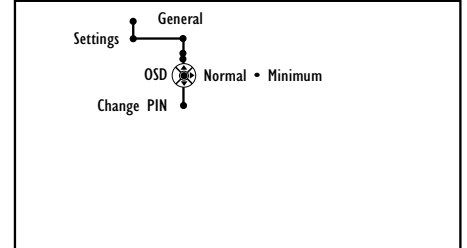
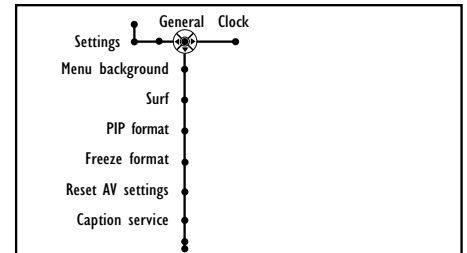
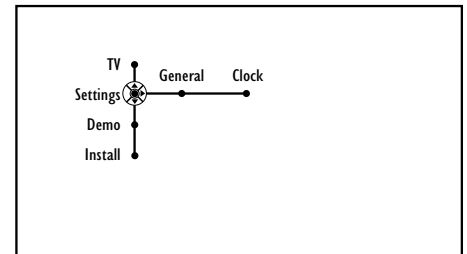
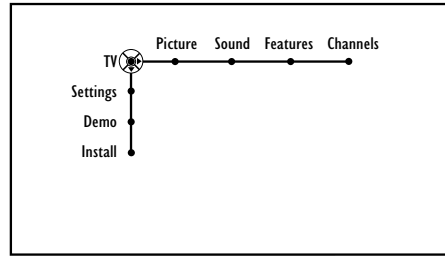
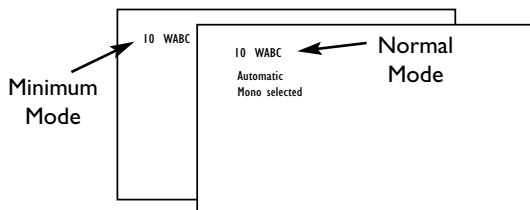

G Setting up or Changing a PIN (Personal Identification Number)

In the General menu, you can set up a new PIN number or change an existing one for the Lock Channel feature.

- 1 Press the Menu button on the remote control to display the on-screen menu.
- 2 Press the Cursor Down button to select "Settings."
- 3 Press the Cursor Right button to select the "General" menu.
- 4 Press the Cursor Down button repeatedly to select either "Set PIN" or "Change PIN."

NOTES:

- If no PIN exists yet, the menu will show "Set PIN." Simply follow the on-screen instructions to set your PIN.
- If a PIN has previously been entered, the menu will show "Change PIN."
- All number combinations from 0000 to 9999 are valid numbers.

- 5 Press the OK or Cursor Right button to begin the process.
- 6 Enter your current PIN using the Digit buttons on the remote control.
If you have forgotten your PIN, you can enter the overriding code 0-7-1-1.
- 7 Enter a new four-digit PIN.
- 8 Re-enter your new PIN using the Digit buttons to confirm the code. Your PIN is now changed.
- 9 Press the Menu button on the remote control to remove the on-screen menu from the TV screen.

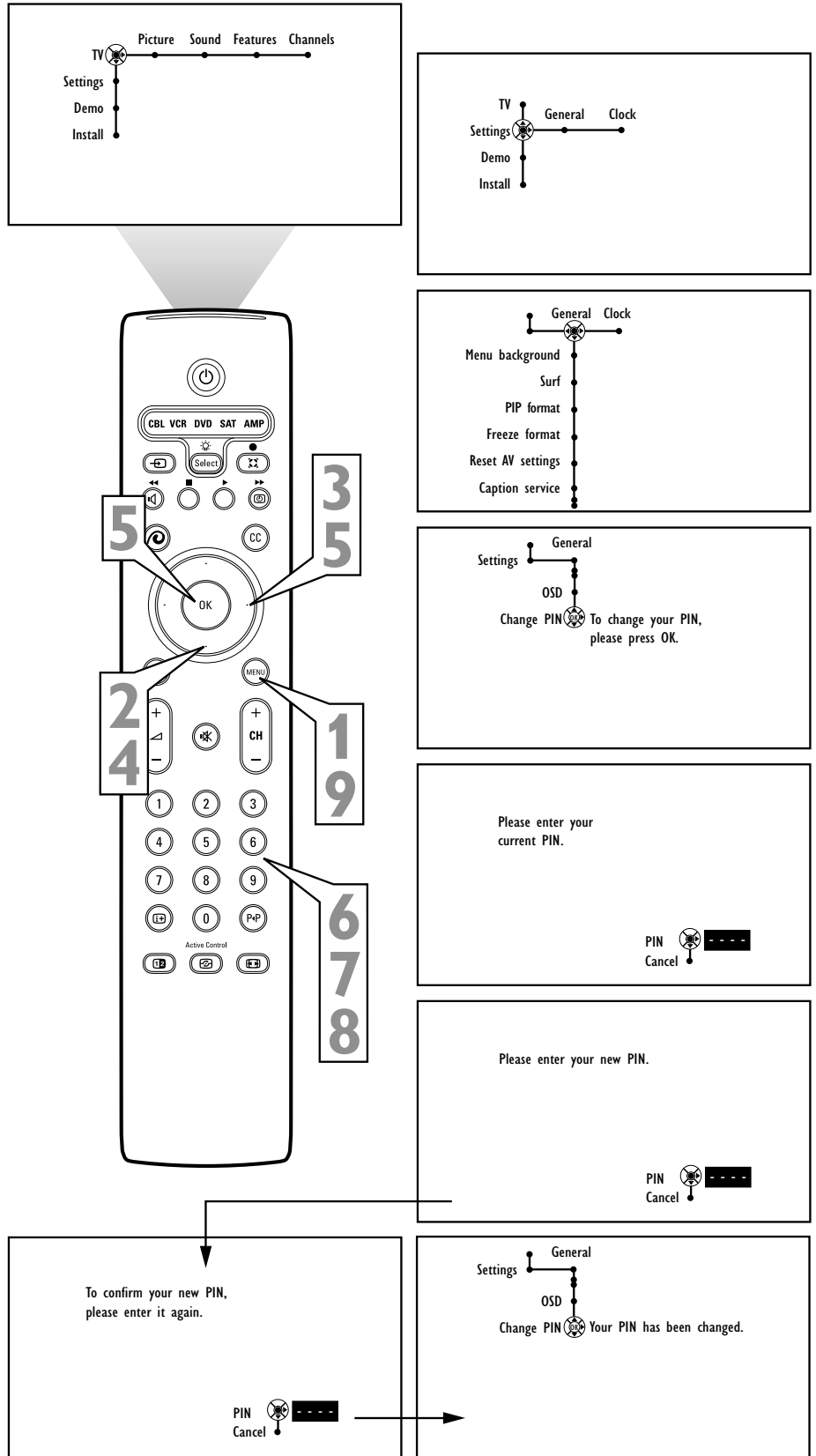

There are several features which require the TV clock to be set. You can either set the clock manually or have the TV acquire the time from the appropriate TV channel.

- 1** Press the Menu button on the remote control to display the on-screen menu.
- 2** Press the Cursor Down button to highlight “Settings.”
- 3** Press the Cursor Right button repeatedly to select the “Clock” menu.
- 4** Press the Cursor Down button to select Auto Clock Mode. Then Press Cursor Right Button to Select “Automatic” or “Manual.” Select Automatic to have the TV acquire the time from a the TV signal. Choose “Manual” to set the time yourself.

If you choose to set the time Automatically you will need to set the “AutoClock Channel” by continuing with steps 5-8 below. If you select manual you will need to make the correct settings by continuing on page 68.

Auto Clock Channel

- 5** After following steps 1-4 above, press the Cursor Down button to select Auto Clock Channel.
- 6** Press the Cursor Right button to enter the channel list. Select your local PBS channel by using the Cursor Up or Down buttons to scroll through the channel list or inputing the the channel using the number buttons.
- 7** Press the Menu button on the remote control to remove the on-screen menu from the TV screen.
- 8** Next Set the Time Zone and Daylight Savings Time. See page 69 for instructions.

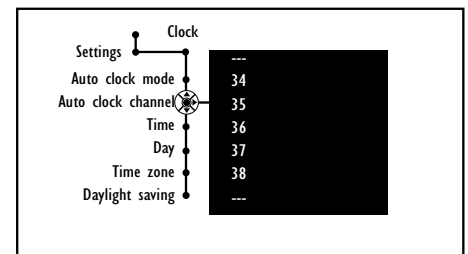
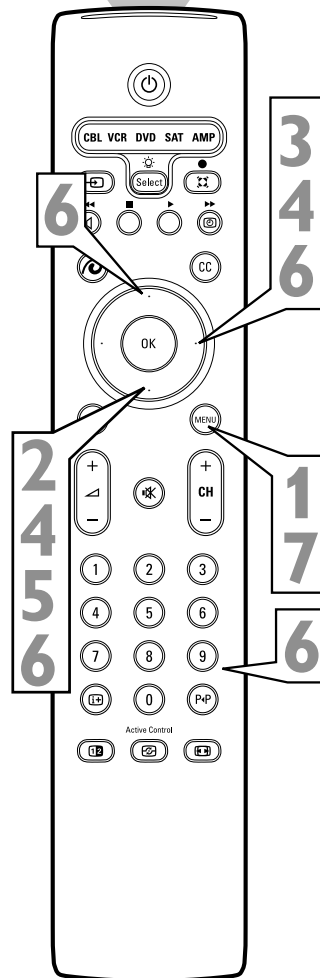
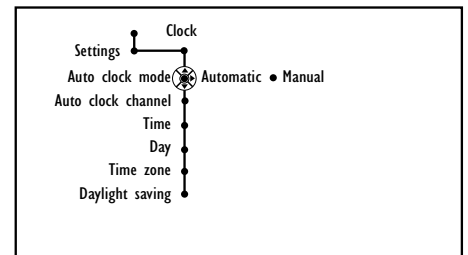
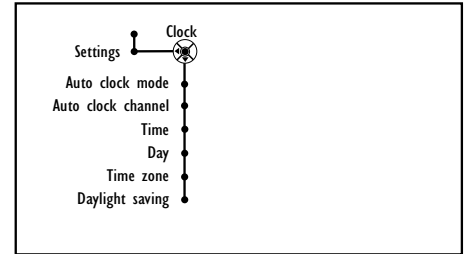
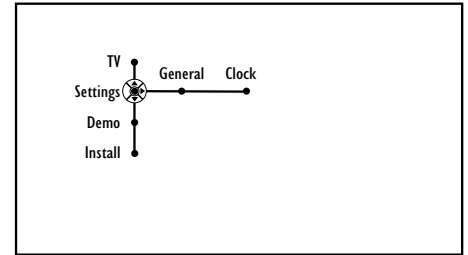
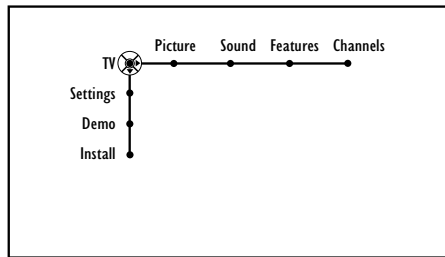

HELPFUL HINT

When the clock is set to “automatic” there will be a several second delay when the TV is turned on and off. During this delay the blue LED will blink. This is normal.

Setting the Clock Manually

If you select Manual in the Auto Clock Mode, you need to set the time manually.

- 1** Press the Menu button on the remote control to display the on-screen menu.
- 2** Press the Cursor Down button to highlight "Settings."
- 3** Press the Cursor Right button repeatedly to select the "Clock" menu.
- 4** Press the Cursor Down button to select Time.
- 5** Press the Cursor Right and Up or Down buttons to select AM or PM.
- 6** Press the Cursor Right button and use the number buttons to enter the current time. (For example, enter 0, 8, 3, and 0 if the time is 8:30 or 1, 2, 4, and 5 if the time is 12:45.) You can also use the Cursor buttons (Up, Down, Right, Left) and scroll through each number. Press Cursor Right to move to the next place.
- 7** Next press the Cursor Left button repeatedly to back out to the Clock Menu.
- 8** Press Cursor Down to select "Day". Then press Cursor Right to enter the list of days.
- 9** Press the Cursor Up or Down buttons to select the current day.
- 10** Press the Menu button on the remote control to remove the on-screen menu from the TV screen.
- 11** Next Set the Time Zone and Daylight Savings Time. See page 69 for instructions.

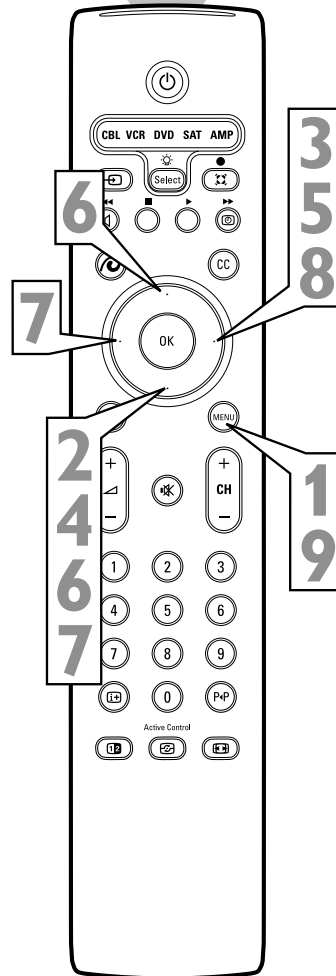
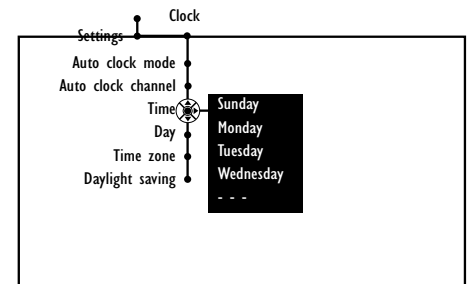
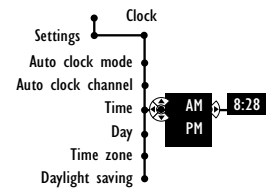
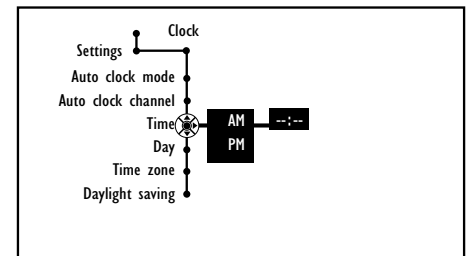
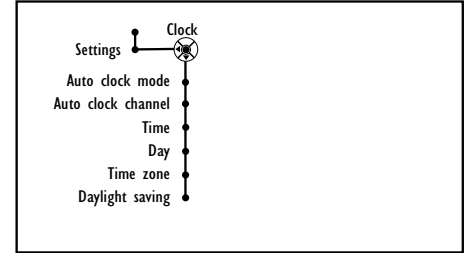
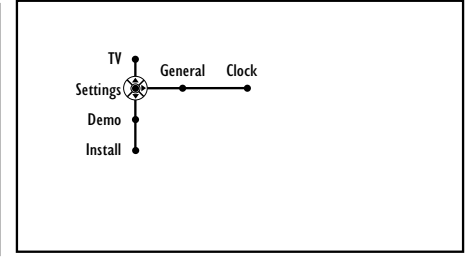
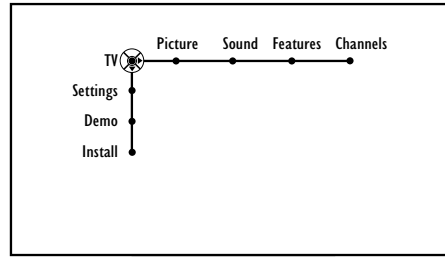

Selecting a Time Zone and Setting the Daylight Savings Control

Your television can acquire the current time from the signal being received. It needs to know your Time Zone, however, and whether or not you use Daylight Savings.

- 1** Press the Menu button on the remote control to display the on-screen menu.
- 2** Press the Cursor Down button to highlight "Settings."
- 3** Press the Cursor Right button repeatedly to select the "Clock" menu.
- 4** Press the Cursor Down button repeatedly to select the "Time Zone" control.
- 5** Press the Cursor Right button to enter the list of available time zones.
- 6** Press the Cursor Up or Down button to select your time zone.
- 7** Press the Cursor Left button, then press the Cursor Down button to select the "Daylight Savings" control.
- 8** Press the Cursor Right button to toggle "Daylight Savings" to "Automatic" for the TV to change to Daylight Savings Time automatically. Or select "Off."
- 9** Press the Menu button to remove the on-screen menu from the TV screen.

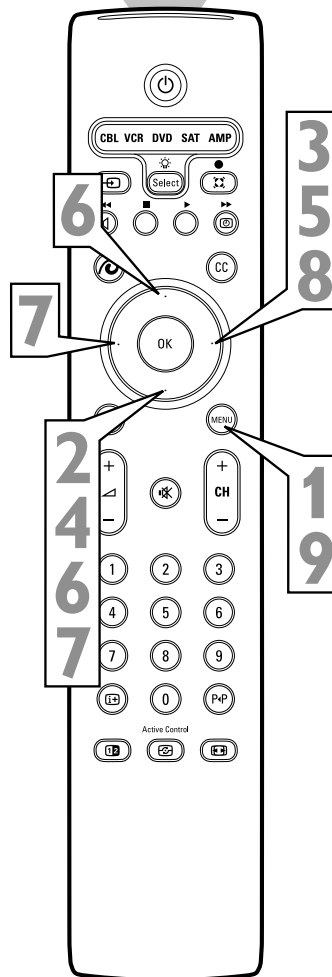
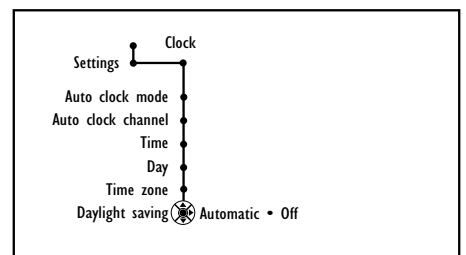
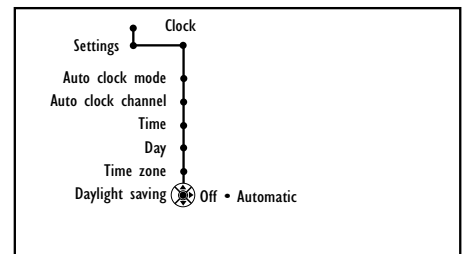
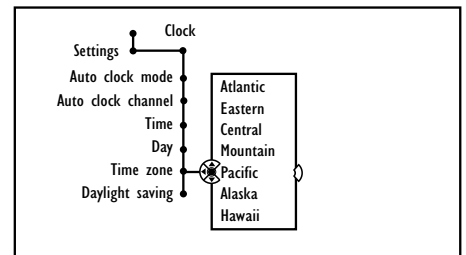
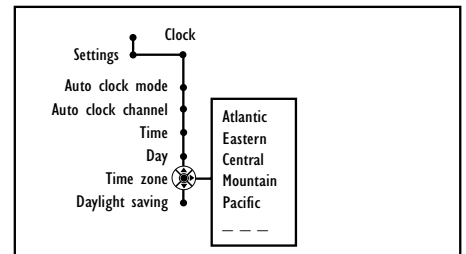
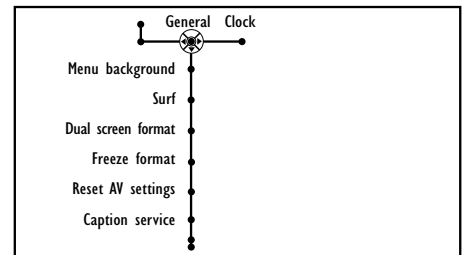
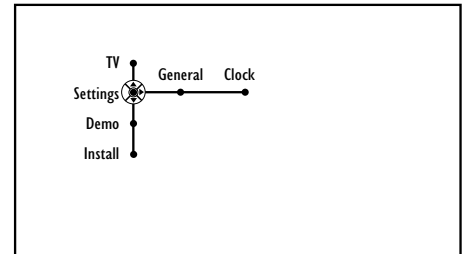
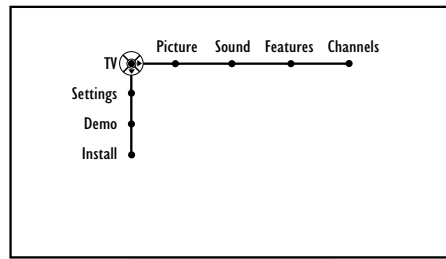

When the Red and Blue projections line up they are in Convergence. Sometimes the projections don't line up and images on the screen will have a red or blue fringe. You can use IntelliSense to correct convergence, but if it does not completely solve the problem, you will need to adjust convergence manually.

- 1** Press the Menu button on the remote control to display the on-screen menu.
- 2** Press the Cursor Down button to select "Settings."
- 3** Press the Cursor Right button to select the "Converge" menu.
- 4** Press the Cursor Down button repeatedly to select "Manual Convergence."
- 5** Press the Cursor Right button to enter the menu. Press the Cursor Down button to select Converge Red or Converge Blue (according to the color of the fringes) and press Cursor Right again to enter the adjust mode.
- 6** Press Cursor Up, Down, Left and Right to converge the Red or Blue cross with the golden center cross
- 7** Press MENU to return to the menu and make further adjustments if needed. Press the Menu button on the remote control to remove the on-screen menu from the TV screen.

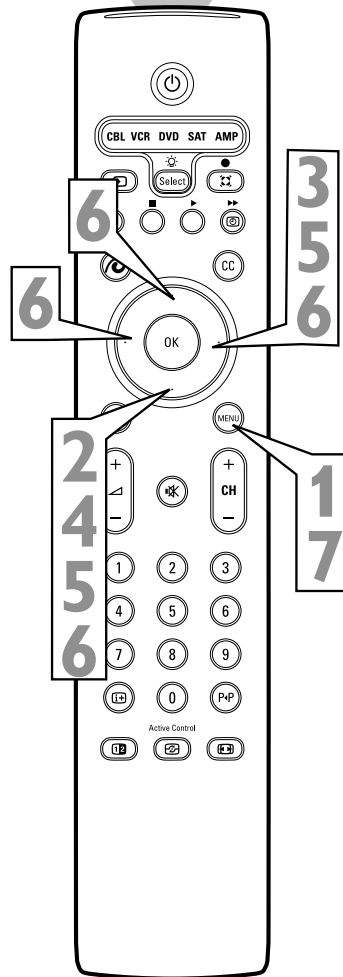
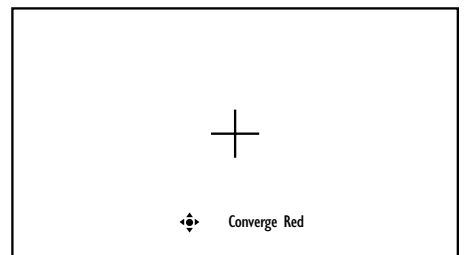
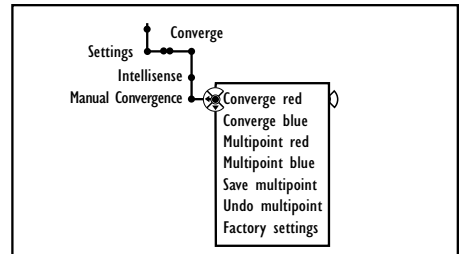
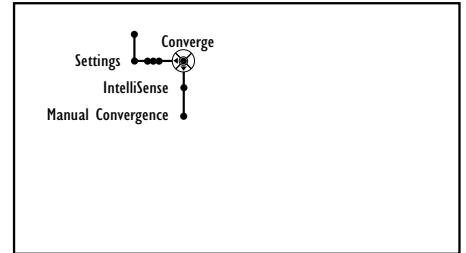
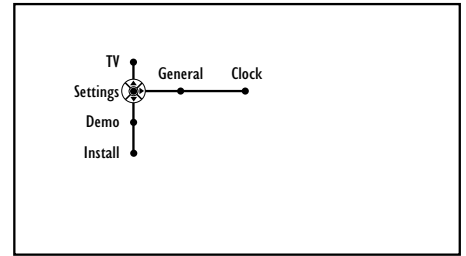
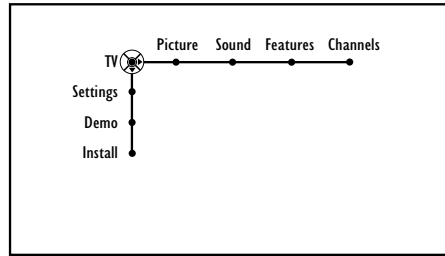

Manual Convergence, Multipoint

Sometimes the convergence is only out of alignment in one part of the screen. To correct convergence in a specific part of the screen, use Multipoint Red or Blue.

- 1** Press the Menu button on the remote control to display the on-screen menu.
- 2** Press the Cursor Down button to select "Settings."
- 3** Press the Cursor Right button to select the "Converge" menu.
- 4** Press the Cursor Down button repeatedly to select "Manual Convergence."
- 5** Press the Cursor Right button to enter the menu. Press the Cursor Down button to select Multipoint Red or Multipoint Blue (according to the color of the fringes) and press Cursor Right again to enter the adjust mode.
- 6** Press Cursor Up, Down, Left and Right to select the point on the screen to adjust.
- 7** Press **i+** then Cursor Up, Down, Left and Right to converge the small Red or Blue cross with the golden center cross.
- 8** Press **i+** to switch to navigate mode. Repeat steps 6-8 until the picture is converged.
- 9** Press the Menu button to return to the menu and make further adjustments if needed.

After changing the Multipoint convergence you can Save Multipoint, Undo Multipoint, or restore Factory Settings

- 10** In the Manual Convergence menu, use Cursor Up and Down to select Save Multipoint, Undo Multipoint, or Factory Settings. Press Cursor Right to activate your selection.
- 11** Press the Menu button again to remove the on-screen menu from the TV screen.

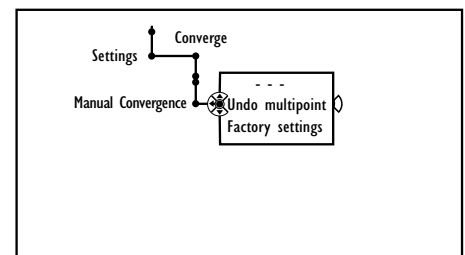
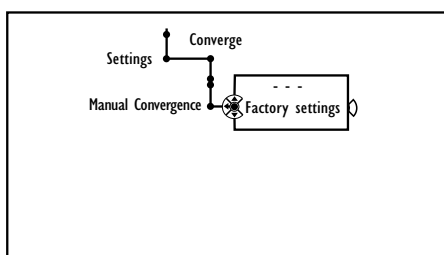
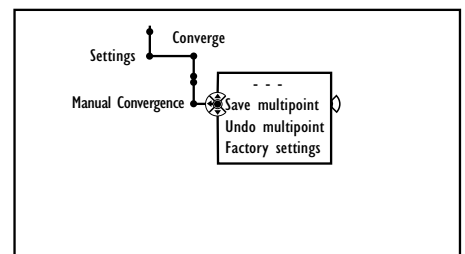
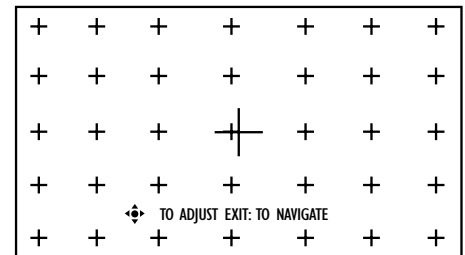
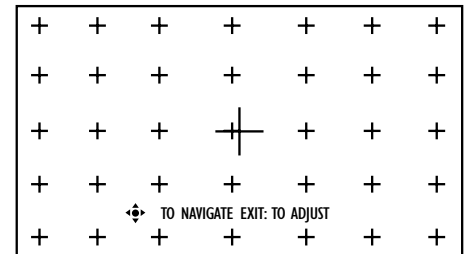
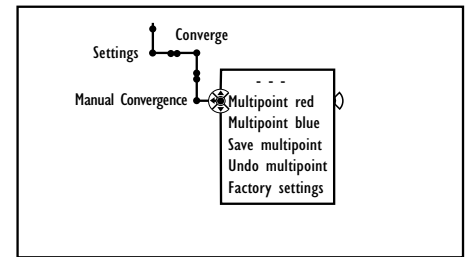
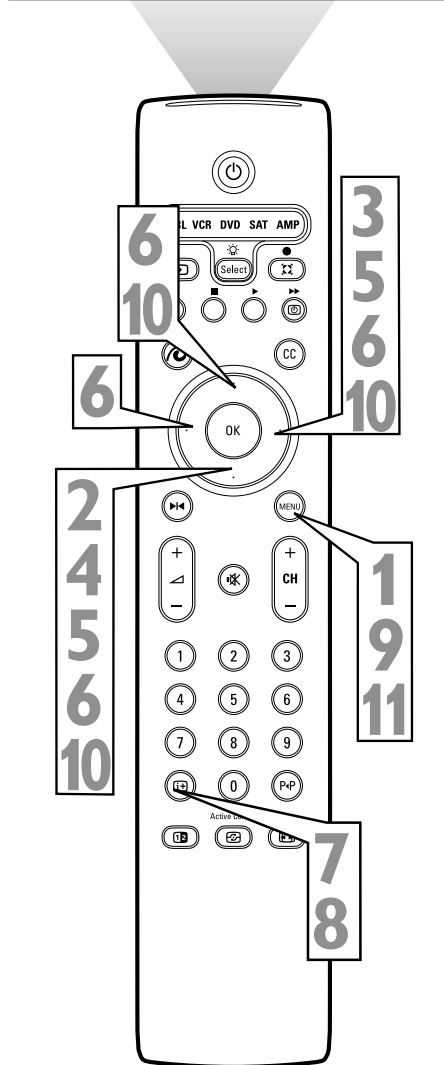
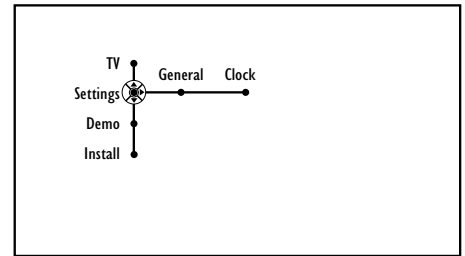
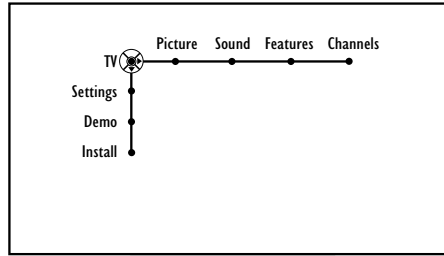



WARNING Concerning Stationary Images on the TV Screen:

Do not leave picture border bars or stationary images on screen for extended periods of time. This can cause uneven picture tube aging.

Normal use of the TV should involve the showing of pictures that contain constantly moving and changing images that fill the screen. Be careful not to leave nonmoving images on screen for extended periods of time, or to display the same images on screen too frequently, because subtle ghost images can be left on the picture tubes. Avoid showing pictures with border bars or the same stationary images more than 15 percent of your total viewing in any one week. Sources of stationary images may be broadcast channels, cable channels, satellite channels, digital television boxes, DVD discs, laser discs, video games, CD-i discs, videotapes, and others. **Here are some examples of stationary images (this is not an all-inclusive list; you may encounter others in your viewing):** **Border bars**—solid bars shown when viewing a standard (4:3) picture and some widescreen movies on your widescreen (16:9) TV; **DVD menus**—listings of DVD disc content; **Video-game images and scoreboards**; **Television station logos**—present a problem if they are bright and stationary; moving or low-contrast graphics are less likely to cause uneven aging of the picture tube; **Stock-market tickers**—presented at the bottom of the TV screen; **Shopping channel logos and pricing displays**—bright and shown constantly or repeatedly in the same location on the TV screen.

All picture tubes age with use, with their light output diminishing over time. But by maintaining normal use—mixing television picture types—you will create conditions in the tubes age at an even rate. The result will be a TV picture that is evenly bright over the entire screen.

WARNING

To avoid possible shock hazard, be sure the TV is unplugged from the electrical outlet before cleaning.

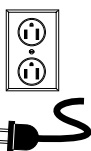

Be sure the TV is unplugged before cleaning it.

Cleaning the Cabinet

- Regularly dust the TV cabinet with a dry, nonscratching duster.
- Gently wipe the cabinet surfaces with a soft, clean cloth. Even if the surfaces are very dirty, do not apply cleaner to them directly. Soak the cloth in a solution of cool, clean water and mild soap or detergent. Wring out the cloth and wipe the cabinet surfaces clean. Then use a clean, dry cloth to dry the wiped surfaces.
- Occasionally vacuum the ventilation slots on the back cover of the set. See the next section on “Cleaning or Replacing the Filters.”
- Never use thinners, insecticide sprays, or other chemicals on or near the cabinet, as they might cause permanent marring of the cabinet finish.
- The television contains plastic parts. DO NOT use benzine, thinners, or other chemicals to clean. DO NOT use insecticide or other volatile substances nearby. DO NOT allow the TV to come into contact for extended periods of time with rubber or vinyl products.

Use a nonscratching duster.

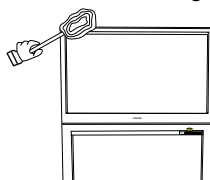

Soak the wiping cloth in cool, clean water and mild detergent. Then ring the cloth out before using.

Don't use chemicals on or near the TV.

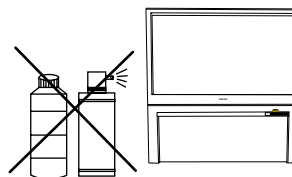

Cleaning the Screen

- Wipe the screen with a clean cloth dampened with water. Screen-cleaning kits with antistatic cleaners and cloths are available. Contact our Customer Care Center at 1-800-531-0039 to purchase the kit.

When cleaning the screen, take care not to scratch or damage the screen surface. Avoid wearing jewelry or using anything abrasive.

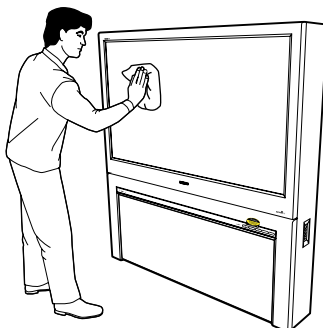

Avoid wearing jewelry that may scratch the TV.

Wipe with even, easy, vertical strokes.



Troubleshooting

Review This List of Symptoms and Checks Before Requesting Service

You may be able to solve the problem yourself. Charges for TV installation and adjustment of customer controls are not covered under your warranty.

If you need to call a customer service representative, please know the model number and serial number of your product before you call. This information is displayed on the back of the product. Our representative will be happy to assist you.

To reach our Customer Care Center, call 1-800-531-0039.

The TV won't switch on.

- Make sure the power plug is plugged in.
- If you're using the TV remote control to turn the TV on, be sure the remote is in TV mode.
- Plug something else in to be sure the wall outlet (or extension cord) is receiving power.
- The remote control could have a problem. See the troubleshooting section "Remote-related Checks" on the next page.

The TV switches off unexpectedly.

- The Sleep timer may have been set to turn the TV off. Turn the TV back on if desired.

The TV switches on unexpectedly.

- The On Timer may have been set.
- If the TV experienced a power outage, it will switch on when power is restored.

You have a picture but no sound.

- Make sure Mute is not on.
- The TV speakers may be turned off. Make sure the Center Channel Amp Switch on the back of the TV is in the INT position.

You have no picture.

- If you have made a connection to the TV's ANTENNA IN 75Ω jack, be sure to use Autoprogram. to program channels into the TV's memory.
- If you want to view materials from an accessory device (DVD player, VCR, or satellite receiver, for example) be sure you have selected the input source to which you have connected the device—AV1, AV2, AV3, AV4, or Side.
- Make sure you have made connections correctly.

You see scrolling images.

- Make sure you have made connections correctly.

The picture appears doubled or tripled.

- If you are using an antenna, be sure it is facing in the correct direction for proper reception. Also, check to see if it may be receiving signals that are being reflected off of mountains or buildings.

The picture shakes or is not clear.

- If you are using an antenna, make sure it is not broken or shorted, and make sure the antenna cable is connected properly and securely.
- If you are using a VCR and selecting channels on the TV, make sure the TV/VCR mode on the VCR is set to TV.

The picture has no colors or colors are not correct.

- Make sure you have made connections correctly.
- If you have connected accessory equipment, such as an HD satellite receiver, make sure the color space setting (either YPbPr or RGB) on the accessory equipment is correct. If you have connected to HD INPUT-AV 3, make sure the color space setting for the AV3 input in the TV's Sources submenu (within the Settings menu) matches that of the accessory equipment—either YPbPr or RGB. See the section in this manual on setting the color space for AV3, and refer to the user manual for the HD satellite receiver.

The TV sound has an unusual quality.

- Check the TV's Equalizer control to be sure it is set to the option you want.

The remote control does not work.

- Make sure nothing is blocking the path between the remote control and the TV or accessory device you want to operate.
- Make sure you point the remote directly at the TV or accessory device you want to operate.
- If you want to operate the TV, make sure the remote is in TV mode. If you want to operate an accessory device, program the remote to operate the device if necessary and make sure the remote is in the appropriate mode for the device.
- Make sure you have installed the batteries correctly.
- The batteries could be dead. When the batteries in the remote run low, the remote will send a "Battery Low" command to the TV. The TV will then display a message on the screen reminding you to replace the batteries as soon as possible.
- You may want to try taking the remote batteries out and then putting them back in. **NOTE:** After taking the batteries out, you may need to reprogram the remote for use with accessory devices.

*Q refers to the *Quick Use and Setup Guide* that came with your TV.



A

Active Control™ Plus+, 27
 Active Control™ Plus+ Window, *Q5
 Active Standby Window, *Q5
 Alternate Audio (SAP), 43
 Antenna Attenuator, 57
 Audio/Video Input Sources, Labeling, 19
 Audio Out, 47
 AutoPicture™ Options, 28
 AutoSound™ Options, 37
 AVL (Auto Volume Leveler), 45

B

Blocking Programs
 Based on TV Ratings, 55
 Based on Movie Ratings, 56

C

Cabinet
 Buttons, *Q5
 Windows, *Q5
 Channel List, 51
 Channels, Programming into the TV's
 Memory, *Q8
 Cleaning the TV, 72
 Clock
 Auto Clock Mode, 67
 Manual Setting, 68
 Time Zone and Daylight savings, 69
 Closed Captioning, 64
 Color Enhancement, 34
 Connections
 Camcorder, 18
 HD Satellite Receiver to DVI, 16
 HD Satellite Receiver to YPbPr, 14
 Progressive-scan DVD Player, 13
 Standard DVD Player, 12
 Surround Sound, 17
 S-Video, 11
 VCR, 9
 VCR and Cable Box, 10
 Video Game System, 18

D

Daylight Savings, Setting, 69
 Delta Volume, 44
 Digital Processing Options, 30
 Dolby** Virtual (See Sound Mode Options)

PIP Format
 Changing Channels or Input Sources, 61
 Selecting, 60
 DVI Input Jack, 6–7, 16
 Dynamic Contrast Options, 32
 Dynamic Noise Reduction Options, 33

F

Factory Service Locations, 75-76

H

Headphone Volume, Adjusting, 39

I

Incredible Surround™ (See Sound Mode
 Options)

J

Jacks/Cables/Connectors, Descriptions, 6

L

Language, Setting for the On-screen
 Menu, *Q8
 Lock After, 44
 Lock Channel, 53
 Loudness, 40

M

Menu Background, 58

O

On-screen Displays Options, 65
 On Timer, 49
 Overheating, Preventing, *Q1-2, 8

P

Panel Jacks, Compatibility Information, 6-7
 Panning the Screen (with Cursor Buttons),
 *Q6, 18, 35
 Picture Controls, 30
 Picture Format Options, 35–36
 Picture Freeze Options, 62
 PIN, Setting up or Changing, 66
 PIP, 60
 Power Surges, Protecting Against, 8
 Pre-connection Recommendations, 8
 Product End of Life Disposal, 5

R

Remote Control
 Programming, 22–23
 Using with the TV, *Q6, 24-26
 Using with Accessory Devices, 24-26
 Remote Sensor Window, *Q5
 RGB+HV Input Jack, 6-7

S

Safety Information/Instructions, *Q1, *Q2, 2,
 3, 8
 SAP (See Alternate Audio Control)
 Service (See Factory Service Locations)
 Signal Splitter, *Q4, 6, 10
 Sleptimer, 48
 Sound Mode Options, 42
 Stereo, Selecting, 44
 Subwoofer
 Output Jack, 6–7, 17
 Control (in on-screen menu), 17
 Surf Options, 59
 Surround Sound (See Connections and Sound
 Mode Options)
 S-Video Input Jacks, 6-7, 11

T

Time Zone, Selecting, 69
 Troubleshooting, 73
 Tuner (RF) Input Jack, *Q3–5, 7–8
 TV Equalizer Options, 38
 TV Signals
 Information on, 6
 Ways of Receiving, 6
 TV Speaker Balance, 41
 TV Speakers, 47
 Twin-lead Adapter, 8

V

Video Game System (See Connections)
 Volume, Adjusting
 Headphone, 39
 TV, 39

W

Warranty, 80
 Welcome, 2

Y

YPbPr Input Input Jacks, 6-7, 12-13

*Q refers to the *Quick Use and Setup Guide* that came with your TV.



Factory Service Locations

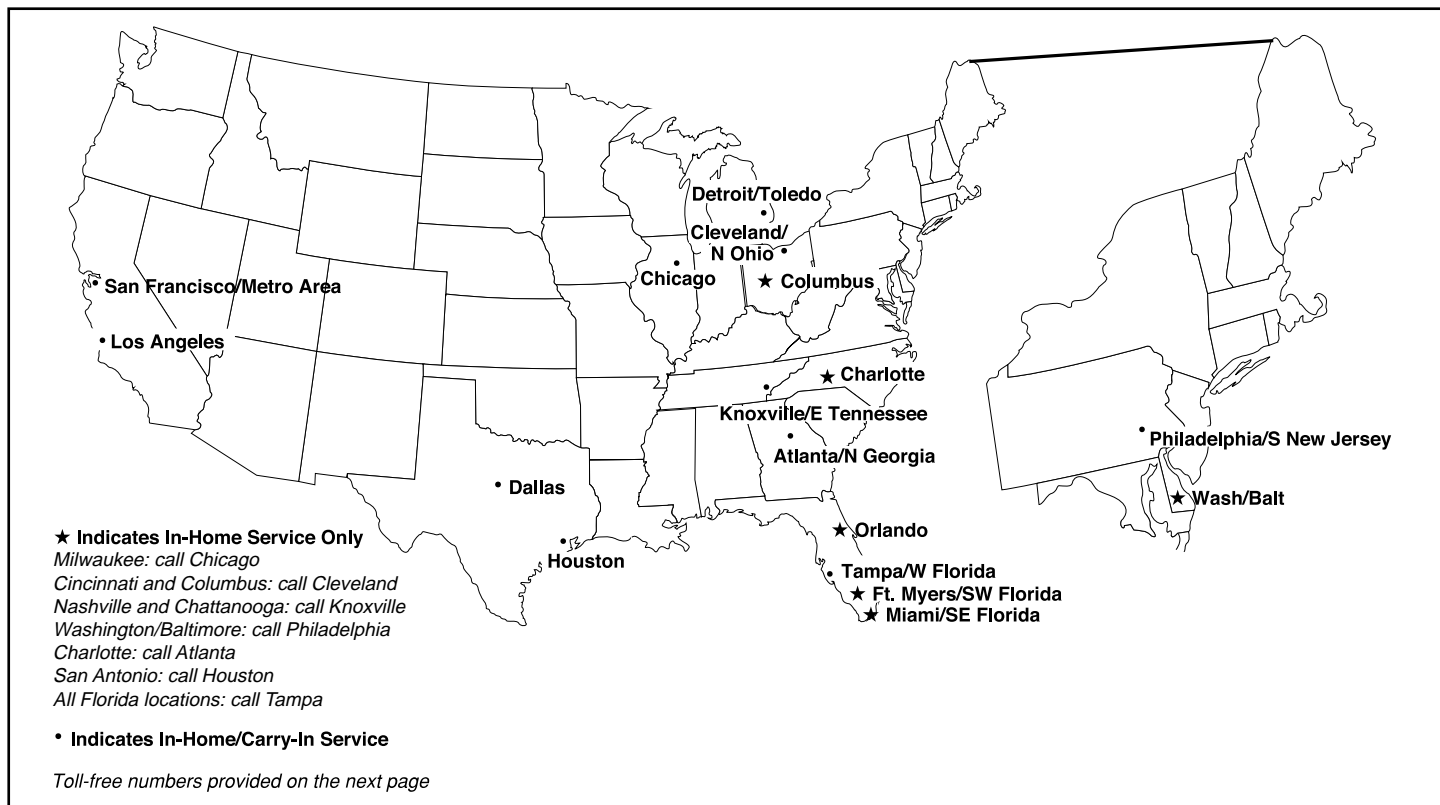

NOTE: If you reside in one of our Philips Factory Service Branch areas (see the directory on the next page), you can contact the nearest Service Branch to obtain efficient and expedient repair for your product. If your product is In-Warranty, you should have proof-of-purchase to ensure No Charge Service. For Out-of-Warranty service, call the location nearest you.

NOTA: Si vous résidez dans une des régions desservies par une succursale de service après vente du fabricant Philips (voir liste ci-dessous), vous pourrez contacter la branche de service après vente la plus près de chez vous pour obtenir un service après vente rapide et efficace. Si le produit est sous garantie, il suffira de présenter une preuve d'achat pour bénéficier d'un service sans frais. Pour les produits non couverts par la garantie, contactez le centre le plus près de chez vous.

NOTA: Si Ud. reside en una de nuestras zonas para sucursales Philips de servicio al de fábrica (ver directorio más abajo), Ud. puede comunicarse con la sucursal de servicio más cercana para obtener una reparación oportuna y eficaz de su producto. Si su producto está todavía bajo garantía, Ud. debe presentar comprobante de compra para no ocasionar ningunos cargos por servicio. Para servicio después del vencimiento de la garantía, llame al lugar más cercano de los abajo indicados.

In Canada

How you can obtain efficient and expedient carry-in, mail-in, or in-home service for your product

Please contact Philips at
 1-800-661-6162 (French speaking)
 1-800-531-0039 (English or Spanish speaking)

Au Canada

Comment obtenir le service après-vente pour les produits apportés ou envoyés par la poste à notre centre de service ou le service à domicile

Veillez contacter philips á:
 1-800-661-6162 (Francophone)
 1-800-531-0039 (Anglais ou Espagnol)

En el Canadá

Cómo recibir servicio eficiente para su producto, en persona, por correo o a domicilio

Favor de comunicarse con Philips al:
 1-800-661-6162 (francófono)
 1-800-531-0039 (Inglés o Español))

Factory Service Locations



QUALITY SERVICE IS AS CLOSE AS YOUR TELEPHONE! SIMPLY LOOK OVER THE LIST BELOW FOR THE NUMBER OF A FACTORY SERVICE CENTER NEAR YOU. YOUR PRODUCT WILL RECEIVE EFFICIENT AND EXPEDIENT CARRY-IN, MAIL-IN, OR IN-HOME SERVICE, AND YOU WILL RECEIVE PEACE OF MIND, KNOWING YOUR PRODUCT IS BEING GIVEN THE EXPERT ATTENTION OF PHILIPS' FACTORY SERVICE.

COMMENT OBTENIR NOTRE SERVICE APRÈS VENTE RAPIDE ET EFFICACE SOIT PAR COURRIER, À DOMICILE, OU EN SE PRÉSENTANT À UN CENTRE DE SERVICE PHILIPS. PLUS DE 600 CENTRES DE RÉCEPTION DE PRODUITS À RÉPARER À TRAVERS LE PAYS: CONTACTER LE CENTRE DE SERVICE AUX CONSOMMATEURS LE PLUS PROCHE POUR SAVOIR L'EMPLACEMENT DE CES DÉPÔTS DANS UN RAYON DE 50 À 75 MILES (80 KM À 120 KM) DU CENTRE DE SERVICE LOCAL.

CÓMO OBTENER UN SERVICIO OPORTUNO Y EFICIENTE POR CORREO, EN CASA O EN PERSONA PARA SU PRODUCTO A TRAVÉS DE UN CENTRO PHILIPS DE SERVICIO. MAS DE 600 SITIOS POR TODO EL PAIS PARA LA RECEPCION DE PRODUCTOS NECESITADOS DE REPARACIONES: COMUNICARSE CON EL CENTRO DE SERVICIO DE FABRICA MAS CERCANO PARA ESTOS LUGARES DENTRO DE UN RADIO DE 80 A 120 KM (50 A 75 MILLAS) DEL CENTRO DE SERVICIO LOCAL.

ATLANTA

Philips Factory Service
550 Franklin Road., Suite F
Marietta, GA 30067
800-273-1501

TAMPA

Philips Factory Service
1911 US Highway 301 North, Suite 100
Tampa, FL 33619
800-442-2027

SAN FRANCISCO

Philips Factory Service
681 East Brokaw Rd.
San Jose, CA 95112
800-300-9013

HOUSTON

Philips Factory Service
1110 N. Post Oak Rd., Suite 100
Houston, TX 77055
800-952-3254

CLEVELAND

Philips Factory Service
950 Keynote Circle
Brooklyn Heights, OH 44131
800-331-7037

DETROIT

Philips Factory Service
25173 Dequindre
Madison Heights, MI 48071
800-438-1398

DALLAS

Philips Factory Service
415 N. Main Street, #107
Euless, TX 76040
800-952-3254

LOS ANGELES

Philips Factory Service
20930 Bonita, Ste. V
Carson, CA 90746
800-300-9013

CHICAGO

Philips Factory Service
1279 W. Hamilton Pkwy.
Itasca, IL 60143
800-531-2922

KNOXVILLE

Philips Factory Service
One Philips Drive
Building 2
Knoxville, TN 37914
800-821-1767

PHILADELPHIA

Philips Factory Service
354 Dunks Ferry Rd.
Bensalem, PA 19020
800-847-9320

This page is intentionally left blank.

This page is intentionally left blank.

This page is intentionally left blank.



Limited Warranty

PHILIPS TELEVISION

One Year Free Labor

One Year Free Service on Parts

30 days Free Service on Television Screen

This product can be repaired in-home.

WHO IS COVERED?

You must have proof of purchase to receive warranty service. A sales receipt or other document showing that you purchased the product is considered proof of purchase.

WHAT IS COVERED?

Warranty coverage begins the day you buy your product. For one year thereafter (30 days for the TV screen), all parts will be repaired or replaced, and labor and transportation are free. After one year from the day of purchase, you pay for the replacement or repair of all parts and for all labor and transportation charges.

All parts, including repaired and replaced parts, are covered only for the original warranty period. When the warranty on the product expires, the warranty on all repaired and replaced parts also expires.

WHAT IS EXCLUDED?

Your warranty does not cover:

- labor charges for installation or setup of the product, adjustment of customer controls on the product, and installation or repair of antenna systems outside of the product.
- product repair and/or part replacement because of misuse, accident, unauthorized repair or other cause not within the control of Philips Consumer Electronics Company.
- reception problems caused by signal conditions or cable or antenna systems outside the unit.
- a product that requires modification or adaptation to enable it to operate in any country other than the country for which it was designed, manufactured, approved and/or authorized, or repair of products damaged by these modifications.
- incidental or consequential damages resulting from the product. (Some states do not allow the exclusion of incidental or consequential damages, so the above exclusion may not apply to you. This includes, but is not limited to, prerecorded material, whether copyrighted or not copyrighted.)
- a product used for commercial or institutional purposes.

WHERE IS SERVICE AVAILABLE?

Warranty service is available in all countries where the product is officially distributed by Philips Consumer Electronics Company. In countries where Philips Consumer Electronics Company does not distribute the product, the local Philips service organization will attempt to provide service (although there may be a delay if the appropriate spare parts and technical manual(s) are not readily available).

MAKE SURE YOU KEEP...

Please keep your sales receipt or other document showing proof of purchase. Attach it to this owner's manual and keep both nearby. Also keep the original box and packing material in case you need to return your product.

BEFORE REQUESTING SERVICE...

Please check your owner's manual before requesting service. Adjustments of the controls discussed there may save you a service call.

TO GET WARRANTY SERVICE...

Repair must be performed by an authorized service center or a factory service center. *If you do not live near a factory service center, contact your dealer.* If your dealer is an authorized service center, he will arrange repair. If your dealer is not an authorized service center, he will direct you to the authorized service center engaged by him to service the products he sells.

(In U.S.A., Puerto Rico and U.S. Virgin Islands, all implied warranties, including implied warranties of merchantability and fitness for a particular purpose, are limited in duration to the duration of this express warranty. But, because some states do not allow limitations on how long an implied warranty may last, this limitation may not apply to you.)

(In Canada, this warranty is given in lieu of all other warranties. No other warranties are expressed or implied, including any implied warranties of merchantability or fitness for a particular purpose. Philips is not liable under any circumstances for any direct, indirect, special, incidental or consequential damages, howsoever incurred, even if notified of the possibility of such damages.)

IF YOU HAVE QUESTIONS...

Please contact Philips at:

- 1-800-531-0039**, if calling from the USA (English or Spanish Speaking)
- 1-800-661-6162**, if calling from Canada (French Speaking)
- 1-800-531-0039**, if calling from Canada (English or Spanish Speaking).

REMEMBER...

Please record below the model and serial numbers found on the product. Also, please fill out and mail your warranty registration card promptly. It will be easier for us to notify you if necessary.

MODEL # _____
 SERIAL # _____

This warranty gives you specific legal rights. You may have other rights which vary from state/province to state/province.

Philips Consumer Electronics, P.O. Box 520890, Miami, FL 33152, (402) 536-4171

EL6551E001 / 3-03

Free Manuals Download Website

<http://myh66.com>

<http://usermanuals.us>

<http://www.somanuals.com>

<http://www.4manuals.cc>

<http://www.manual-lib.com>

<http://www.404manual.com>

<http://www.luxmanual.com>

<http://aubethermostatmanual.com>

Golf course search by state

<http://golfingnear.com>

Email search by domain

<http://emailbydomain.com>

Auto manuals search

<http://auto.somanuals.com>

TV manuals search

<http://tv.somanuals.com>