

Vortex EF2241 Reference Manual

Introduction.....	2
<i>Product Features</i>	3
Pre-Installation.....	5
<i>EF2241 Front and Rear Panels</i>	6
Installation	8
<i>Mounting the EF2241</i>	8
<i>Connecting the EF2241 to Other Equipment</i>	8
<i>Device IDs on the EF Bus</i>	10
<i>Connecting Multiple Vortex Devices</i>	10
<i>Factory Default Settings (Preset 0)</i>	11
<i>Check Surrounding Equipment</i>	13
Integrating the EF2241 Into Your System.....	15
<i>Input Settings</i>	15
<i>Calibration</i>	15
<i>Set up the Phone Interface</i>	17
<i>Build Your Echo Canceller Reference</i>	17
<i>Echo Canceller Reference for Multiple Vortex Devices</i>	17
<i>Configure the Automatic Microphone Mixer</i>	19
<i>Automixer Settings for Multiple Vortex Devices</i>	21
<i>Configure the Matrix Mixer</i>	22
<i>Building Your System with Multiple Vortex Devices</i>	22
The EF Bus	24
<i>Presets</i>	25
<i>Other EF2241 Features</i>	25
LCD Menu Structure	26
<i>System Menu</i>	28
<i>Phone Control</i>	29
<i>Inputs</i>	30
<i>Outputs</i>	31
<i>Automixer Menu</i>	31
<i>Matrix Menu</i>	34
<i>Parametric EQ Menu</i>	35
<i>Presets</i>	36
<i>Macros</i>	36
Troubleshooting.....	37
<i>Automatic Microphone Mixer</i>	37
<i>Matrix Mixer</i>	38
<i>Echo Canceller Reference</i>	38
<i>Residual Echo</i>	38
<i>Contacting Technical Support</i>	43
Technical Specifications.....	44
<i>Compliance</i>	45
Conference System Design.....	49
EF2241 Block Diagram	50
Connector Pinouts.....	51
<i>Connecting Unbalanced RCA to Balanced Mini Phoenix</i>	53
<i>Making an EF Bus Terminator</i>	53
<i>Additional Notes</i>	54
Warranty Information	55
Definition of Terms	57
Index	60

INTRODUCTION

Welcome

Congratulations on your purchase of the Vortex EF2241!

How to Use This Manual

This is a reference manual for your EF2241. It is structured to provide the information you need quickly and conveniently. The following is an overview of each section:

- *Introduction*
- *Pre-Installation* includes information about the contents of the box, tools needed for installation and front and rear panel descriptions.
- *Installation* covers connections of inputs/outputs and calibration of inputs of the EF2241.
- *Integrating the EF2241 Into Your System* describes adjustments to take into consideration when integrating the EF2241 with surrounding equipment in your system.
- *LCD Menu Structure* describes an overview of the LCD menu structure and also gives a system overview of features and options available.
- *Troubleshooting* helps to debug problems with installation.
- *Technical Specifications* provides the technical specifications of the EF2241.
- *Conference System Design* gives suggestions on topics to consider when designing your system.
- *EF2241 Block Diagram* shows the inside of the EF2241.
- *Connector Pinouts* shows pinout diagrams for EF2241 input and output connectors.
- *Warranty Information*
- *Definition of Terms* explains terms used in this manual, as well as terms used in our technology of echo cancellation, noise cancellation, and audio conferencing.

About the EF2241

The Vortex EF2241 is a companion to the Vortex EF2280, or a stand-alone solution for audio conferencing. It automatically mixes four microphones and other audio while cancelling acoustic echoes and annoying background noise, and features a built-in “phone add” to bring telephone calls into the conference. A total of 8 Vortex devices can be linked together (for instance, 8 EF2280s, or 2 EF2241s and 6 EF2280s).

The EF2241 has 4 mic/line inputs, 4 line inputs and 8 line outputs with 4 channels of acoustic echo and noise cancellation. It has matrix mixing and automatic microphone mixing capabilities, a single telephone line interface, and a single channel power amp.

It includes a total of 8 analog inputs (4 mic/line level inputs and 4 line level inputs), 8 analog outputs, and 5 digital expansion busses (one being dedicated to phone). Acoustic echo cancellation (AEC) and noise cancellation can be applied to each of the 4 mic/line level inputs, and each of these inputs can then be sent to one of the two internal automatic microphone mixers.

The system also contains a 23 x 17 main matrix, four 7 x 3 submatrices, and one 7 x 2 submatrix for transporting audio from the phone line. The 23 x 17 main matrix has the following inputs: Input channels 1-4 (gated or ungated), Input channels A-D, the internal signal generator, 3 mixes of each of the four digital busses (3 mixes times 4

busses equals 12 inputs), and 2 mixes of the P Bus for the telephone. The 23 x 17 main matrix has the following outputs: Outputs 1-4 and A-D, AEC Reference 1 and 2, W, X, Y, and Z outputs to the digital expansion bus, P output to the digital expansion bus, output to the power amplifier, and output to the phone line. The EF2241 has 24 bit resolution, 32-bit floating point computation, and a 48 kHz sampling rate.

Polycom's proprietary noise cancellation on each of the 4 mic/line inputs and the telephone line helps to keep overall ambient noise to a minimum. Polycom echo cancellers are the only ones on the market to feature this patented technology. Noise cancellation filters out ambient background noise such as noise from heating, ventilating and air conditioning (HVAC), LCD projectors, and road noise. Our noise cancellation technology is not a noise gate. It actually removes noise. Therefore, it enhances the operation and improves the sound quality of an automixer, for example, by preventing it from bringing the noise level up and down when microphones are gated on and off. By cancelling the noise picked up by each microphone, the overall signal to noise ratio (SNR) is preserved. The result is crystal clear speech over a greater decibel range than any other echo canceller. That means reduced listener fatigue and a higher quality audio conference.

Product Registration

Please take a moment to fill out and return your registration card. This information will help us to provide you with better customer support and will allow us to notify you with updated product features and software.

PRODUCT FEATURES

Product

- Front panel LCD for controlling and configuring the product without a computer
- 5-band equalizer on all Inputs and Outputs
- Echo cancellation on Inputs 1-4
- Noise cancellation up to 15 dB
- Two internal automatic microphone mixers for Inputs 1-4
- 23 x 17 full cross point matrix mixer with expansion bus
- Internal signal generator for calibration mode and noise masking applications
- 2 year warranty

AEC

- 24 bit resolution
- 48 kHz sampling rate, >20 kHz bandwidth
- 270 ms AEC tail length
- 40 dB/sec convergence rate
- Can function in rooms with more than 10 dB of room gain

LEC

- 32 ms LEC tail length
- 40 dB/sec convergence rate
- > 65 dB total cancellation

Inputs and Outputs

- 4 microphone/line level inputs with phantom power on each input
- 24 VDC Phantom Power
- 4 line level auxiliary inputs with nominal level of 0 dBu
- 8 line level outputs with default nominal level of 0 dBu
- Automatic Gain Control (AGC) on Inputs 1-4.

Remote Control

- RS-232 port for remote control
- Reconfigurable parallel logic input/output
- EF bus for linking multiple Vortex devices
- Digital bus with 5 audio busses, 48 kHz sampling rate
- Up to 8 Vortex devices can be linked, each device providing 4 audio signals on the bus and each EF2241 providing 1 phone audio signal on the bus

PRE-INSTALLATION

What's Included

The Vortex EF2241 product package includes the following items:

- Vortex EF2241 Reference Manual
- Vortex EF2241
- External power supply
- Cat 5 cable for EF Bus
- Telephone cable
- Rack mount screws (4)
- Phoenix connectors (16)
- Cable clamp and screw
- CDROM containing other manuals and Conference Composer software
- Product Registration Card

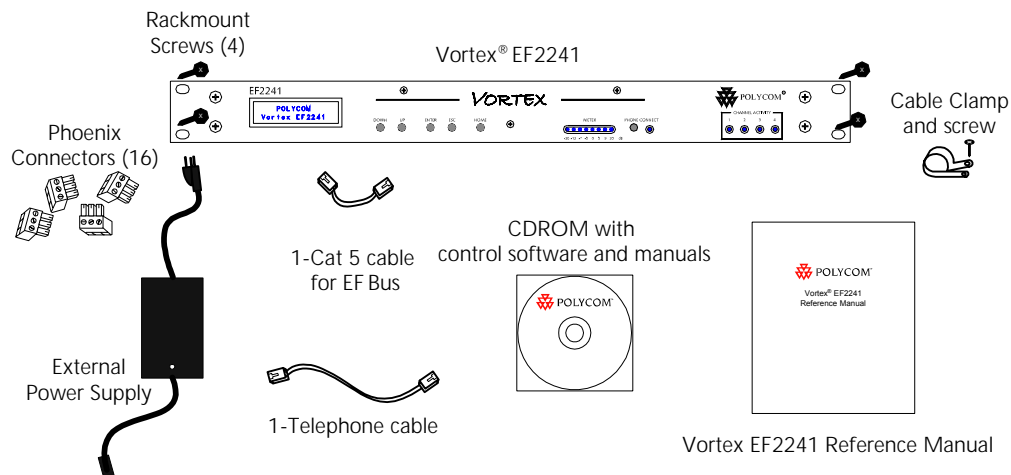

Figure 1. What's Included with your Vortex EF2241.

What's Not Included

The following equipment is not included with the EF2241 product package, but may be necessary to create a completely functional system:

- Microphones
- Loudspeakers
- Audio cables
- Videoconferencing codec or other four-wire interface (optional)
- RS-232 remote control device (optional)

Tools Needed for Installation

- Screwdriver to mount the EF2241 in your rack.
- Phoenix connector screwdriver

EF2241 FRONT AND REAR PANELS

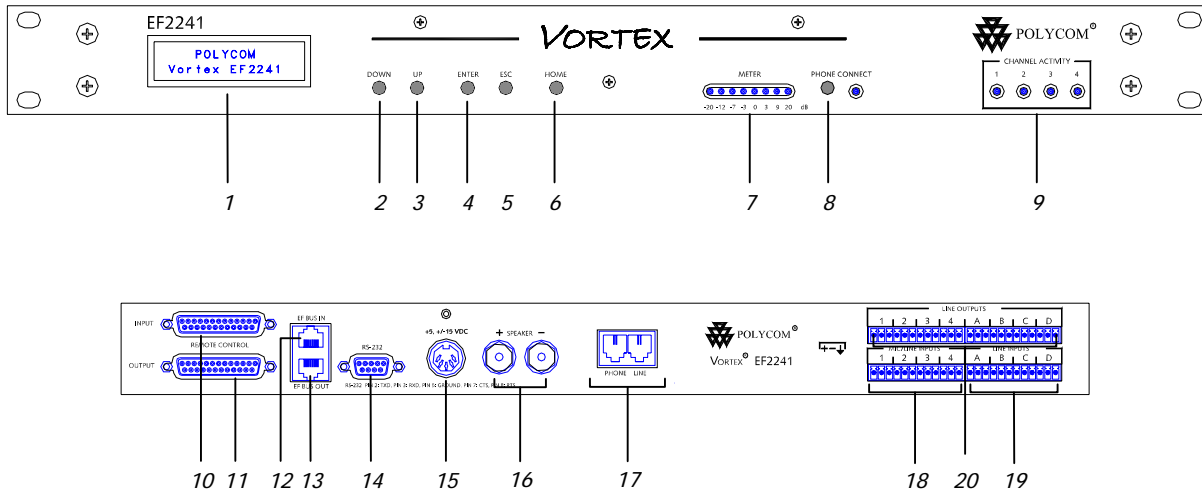

Figure 2. EF2241 Front and Rear Panels

1. LCD DISPLAY. Displays menu instructions for configuration and operation of the EF2241.
2. DOWN BUTTON. Scrolls backward through menu items at a particular level or decreases the value of a parameter.
3. UP BUTTON. Scrolls forward through menu items at a particular level or increases the value of a parameter.
4. ENTER. Enters the menu and allows you to select and change parameter values.
5. ESC. Returns to the next highest level of menus.
6. HOME. Returns to the top of the menu structure.
7. LEVEL INDICATOR. Indicates the level of the selected channel or parameter.
8. PHONE CONNECT. Takes the phone line on or off hook. If you have an analog handset connected to the PHONE jack on the back panel, pushing this button will disable the PHONE jack while enabling the LINE jack (see Item 17).
9. CHANNEL ACTIVITY LEDS. Indicates gating activity of the 4 mic/line channel inputs.

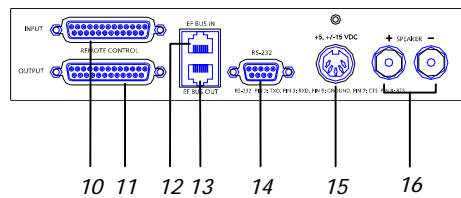

Figure 3. Parallel remote control, EF BUS, serial remote control, power supply input, and power amplifier output on back panel of the EF2241.

10. INPUT PARALLEL PORT. Parallel logic input.
11. OUTPUT PARALLEL PORT. Parallel logic output.
12. EF BUS IN. Connects to EF BUS OUT of another Vortex device.
13. EF BUS OUT. Connects to the EF BUS IN of another Vortex device.
14. RS-232 SERIAL PORT. Connect this to an optional RS-232 remote control device, such as a touch panel or personal computer COM port.
15. POWER SUPPLY INPUT. Connects to the external power supply provided with the EF2241.
16. POWER AMPLIFIER OUTPUT. Drives up to 10 W into 4-16 Ohm speakers.

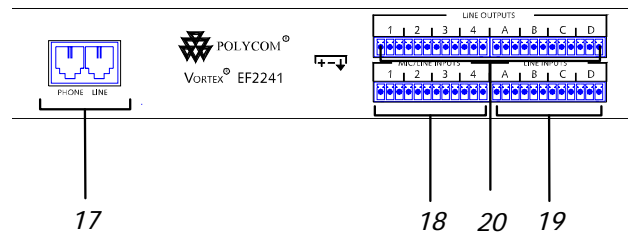

Figure 4. Inputs and outputs on back panel of the EF2241.

17. PHONE/LINE JACKS. Use the PHONE jack for connecting an analog handset to the system. Use the LINE jack for connecting to an analog telephone line.
18. MIC/LINE INPUTS. Connects to microphone at either mic or line level, with or without phantom power.
19. LINE INPUTS. Inputs A-D at line level.
20. LINE OUTPUTS. Outputs 1-4 and Outputs A-D at line level.

INSTALLATION

This equipment is intended to only be installed by qualified service personnel. The equipment shall be connected to a socket-outlet that provides a protective earthing connection.

North American Requirement

CAUTION-To reduce the risk of fire, use only No. 26 AWG or larger telecommunication line cord.

MOUNTING THE EF2241

The EF2241 can be mounted in a rack enclosure using four large screws (10-32x1/2") included with the unit. One EF2241 fits in a single rack space.

Recommendation For Easy Access

While not required, leave a single rack space in between the EF2241 and other units in your rack. This gives you easier access to the back panel.

Instructions for Securing Power Supply to Back of EF2241

- Locate the cable clamp on the back panel of the EF2241 above the power connector.
- Remove the screw and thread the power cord through the cable clamp.
- Attach the cable clamp to the back panel of the EF2241 and tighten the screw. Align the clamp so that the power cable does not interfere with the connectors on the EF2241 back panel.
- Plug in the power supply.
- We recommend that you also Ty-wrap the power supply to the rack. The purpose of securing the power supply to the back panel is so that if the power supply were to drop, it would pull where the cord is attached with the cable clamp and not pull the plug out of the EF2241.

Caution! *Do not use any other power supply other than the one provided with this unit.*

CONNECTING THE EF2241 TO OTHER EQUIPMENT

Grounding

The EF2241 has 4 mic/line inputs plus 4 line level inputs and 8 line level outputs. Each input/output is "Pin 1 compatible" — this means that the ground pin of each input/output is tied to chassis ground. Chassis ground is connected to the input power ground.

Typical EF2241 Connections

The EF2241 will typically be connected to other equipment in a single room setup as shown below in Figure 5 and Figure 6.

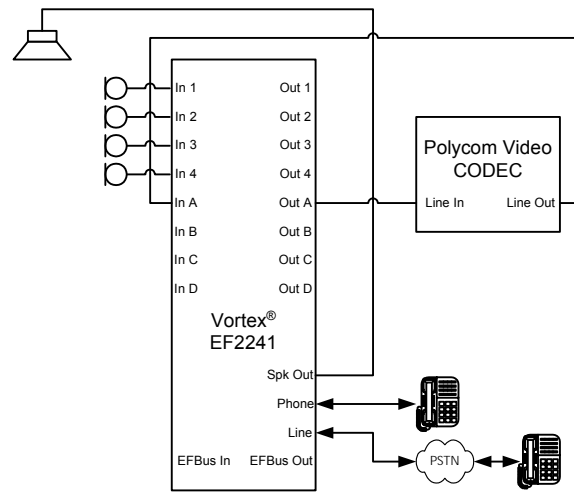

Figure 5. Block diagram of typical EF2241 connections: a single room using one EF2241.

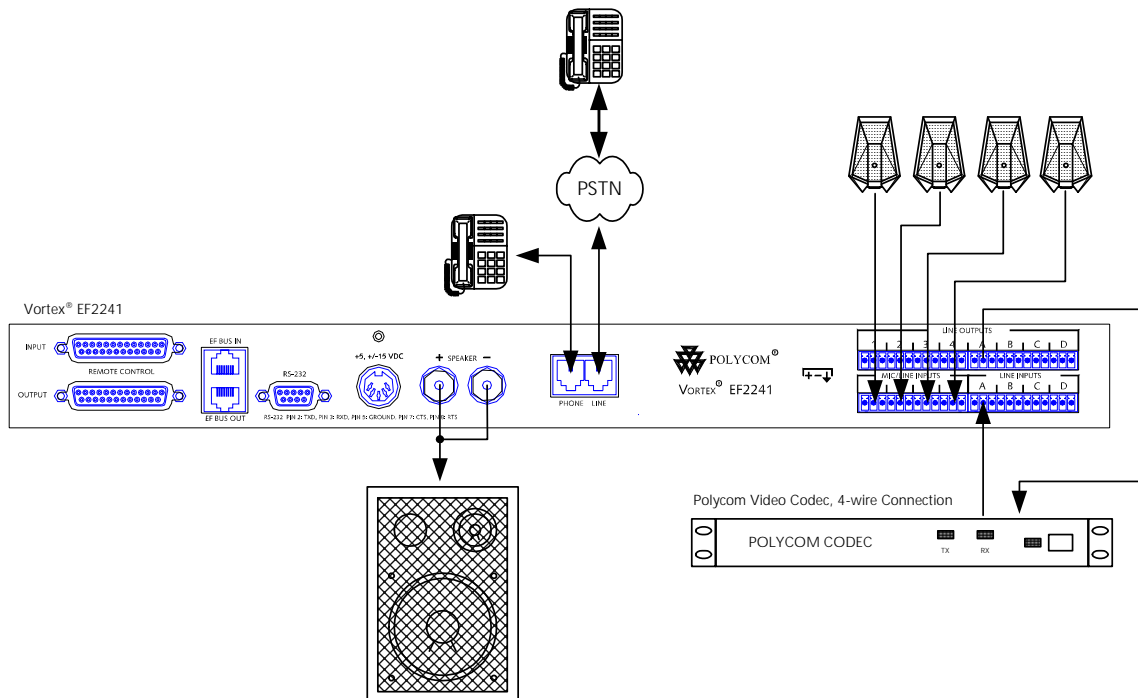

Figure 6. Typical EF2241 connections.

The following steps are typically used to set up the EF2241:

- Connect a microphone to each of the 4 mic/line level inputs. The mic/line input accepts mini-Phoenix connectors. See “Connector Pinouts” on page 51 for pinouts of Phoenix connectors.

- Connect speaker output to loudspeaker.
- If RS-232 remote control is desired, connect the RS-232 REMOTE CONTROL port of the EF2241 to the remote control device, such as an RS-232 interface to a touch panel or a COM port on a personal computer.
- Connect the LINE RJ11 jack to an analog telephone line.
- Connect the PHONE RJ11 jack to an analog telephone set (optional).
- Connect the external power supply to the POWER SUPPLY INPUT jack of the EF2241.
- Set the country code on the EF2241. By default the phone interface will be disabled until you select a country code for the telephony interface. This can either be done with the front panel LCD menu, or the RS-232 interface. The country code only needs to be selected the first time or when the country of the installation is changed.

DEVICE IDS ON THE EF BUS

When considering which Device IDs can be used for which Vortex device, decide how many devices have the ability to **transmit** on the W, X, Y, and Z busses, and how many have the ability to transmit on the P Bus. The EF2280, for example can only transmit on the W, X, Y, and Z busses while the EF2241 can transmit on the W, X, Y, and Z busses as well as the P bus. Up to 8 devices can transmit on the W, X, Y, and Z busses. Similarly, up to 8 devices can transmit on the P bus. Note that the EF2241 counts as one of both types. All devices that can transmit on W, X, Y, and Z must have unique device IDs. Vortex devices of the same type must have unique device IDs. If the device IDs of linked Vortex devices are the same, the front panel LCD screen will display “EFBus Error: Dev. ID Conflict”.

CONNECTING MULTIPLE VORTEX DEVICES

Up to 8 Vortex devices in combination can be linked together at one time (See Device IDs on the EF Bus above). Each unit in the chain must have a unique Device ID. Use the EF Bus to link multiple Vortex devices together.

The following steps should be followed to connect the EF Bus:

1. Set a unique Device ID for each Vortex device. The Device IDs range from 00 to 07.
2. Power off all units.
3. Connect the RS-232 remote control device to any Vortex device in the chain.
4. Connect the provided Cat-5 cable between the EF BUS OUT of the first device, and the EF BUS IN of the second device.

Note. The EF Bus must be connected so that the EF Bus In of one box is connected to the EF Bus Out of another. Connecting the EF Bus In to another EF Bus In (or Out to Out) will not work.

5. Connect another Cat-5 cable between the EF BUS OUT of the second device and the EF BUS IN of the third device, and so on.
6. Power on all units at the same time.

Terminating the EF2241

The EF2241 is self-terminating so if you are connecting multiple EF2241s, the EF Bus does NOT need to be terminated. However, if you are linking the EF2241 to EF2280s, terminate the EF Bus link.

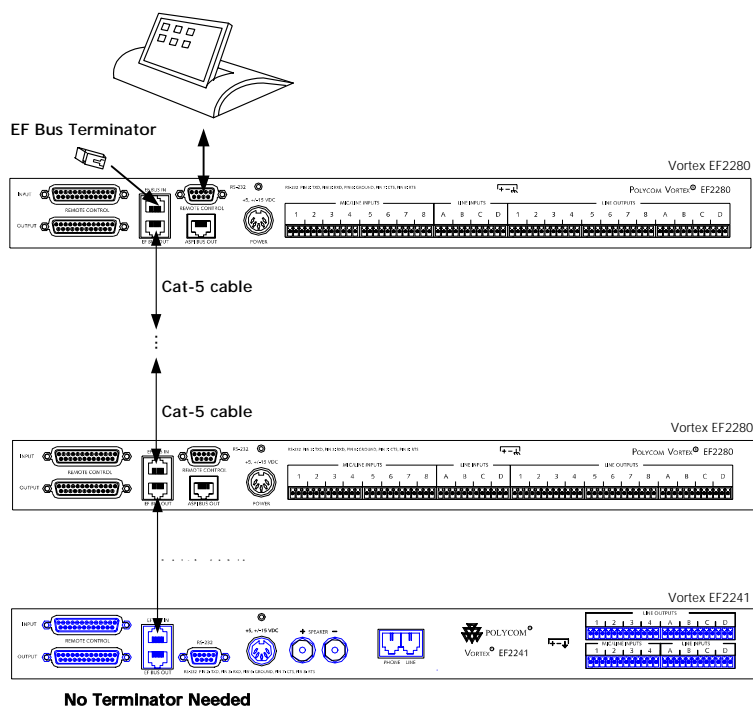

Figure 7. Only the EF2280 needs to be terminated when linked together with EF2241s.

FACTORY DEFAULT SETTINGS (PRESET 0)

The following is a list of the factory default settings of the EF2241. Since the microphones and other equipment in your application may have different nominal levels, you can start with a FACTORY PRESET (Presets 0-15), change it to match your environment and then save it within the EF2241 as a USER PRESET (Presets 16-47). Once you've saved a USER PRESET, set the POWER ON PRESET to that USER PRESET (or

whichever preset you want to come up after power up). The unit will need to be configured for your system.

PROGRAM PARAMETERS	FACTORY DEFAULT PRESET VALUE
SYSTEM PARAMETERS	
Preset	0
Device ID	0
AUTOMIX PARAMETERS	
Chairman Mode	Off
Decay Time	1000 ms
Hold Time	500 ms
Last Mic On Mode	On (on Automixer 1)
Max NOM per Automixer	4
Off Attenuation	-15 dB
INPUT CHANNELS	
Acoustic Echo Cancellation	On
Automatic Gain Control (AGC)	On
AGC Rate	1 dB/s
AGC Max Gain	3 dB
AGC Min Gain	-3 dB
Automixer	1
Echo Canceller Reference	Ref1
Filtering	Off
Gate Priority	1
Adaptive Threshold	10 dB
Gate Threshold	Adaptive
Gating	Auto

PROGRAM PARAMETERS	FACTORY DEFAULT PRESET VALUE
Input Gains	Mic Mode + 15 dB = 48 dB for Inputs 1-4 0 dB for Inputs A-D
Manual Threshold	60 dB
Mute	Off
Noise Cancellation	On
Noise Cancellation Level	10 dB
Phantom Power	On
OUTPUT CHANNELS	
Mute	Off
NOM Attenuation	On for Outputs 1-4 On for Outputs A-D
Output Gain	0 dB

Presets and Multiple Vortex Devices

PRESET 0 is preconfigured for a system with multiple Vortex devices. In Preset 0, microphones are bussed out to other units on the W Bus. Microphones are also input into each device on the W Bus (INPUT WM0 in the Matrix).

If you have multiple devices in your system, save settings to a user preset (Presets 16-47) on each device. Saving a preset will only save the preset on that particular unit. Also, remember to set the POWER ON PRESET to the User Preset that you have saved your settings to otherwise the device will revert back to Preset 0 (factory default) if power is lost.

CHECK SURROUNDING EQUIPMENT

Now that the physical connections to the EF2241 are set up, it may be necessary to check the surrounding equipment to make sure levels are set correctly. The following suggestions may be helpful in integrating the EF2241 into your system:

Pick a Standard Signal Level

A standard nominal signal level should be used throughout the audio system. Any equipment that does not operate at this standard level should be compensated for as close to the piece of equipment as possible. A 0 dB nominal level is a good standard signal level. For example, a consumer VCR will probably generate a -8 dBu level. As soon as the VCR signal arrives at an input with some gain control, the input gain should be adjusted so that you get a 0 dB level, i.e. adding 8 dB of gain.

Check Levels to the Codec

Configure the matrix mixer output to the codec input. The output gain of the matrix mixer should be set to match the nominal input level of the codec. For example, if the codec accepts -10 dBV (-8 dBu) inputs, 8 dB of attenuation should be applied at the matrix mixer output to the codec.

Configure the matrix mixer input from the codec output. The input gain of the matrix mixer should be set to match the nominal output level of the codec. For example, if the codec outputs a -10 dBV (-8 dBu) level, 8 dB of gain should be applied on the matrix mixer input. This will bring the codec level up to 0 dBu inside the matrix.

Verify Room Gain

After adjusting the loudspeaker level, verify the room gain in your system using the ROOM GAIN meter on the DIAGNOSTICS page of Conference Composer. The Room Gain measurement is only accurate when just the remote talkers are speaking. If local talkers are speaking too, the room gain meters are not accurate. See Figure 8 below. The meter shows the room gain, which is the relative level of the output level and the input level. While the EF2241 will operate in positive room gain conditions, the room gain should be around 0 dB or a negative value. If you have a positive room gain, make adjustments in the following areas:

1. Decrease the Input Gain of the microphone.
2. Decrease the Output Gain of the microphone.
3. OR adjust the placement of the microphone relative to the loudspeaker.

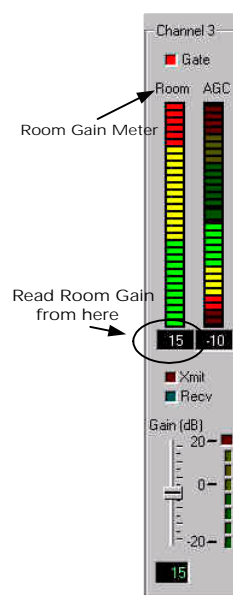

Figure 8. Room Gain Meter on the Diagnostics page of the Conference Composer control software.

Configure Program Audio Sources

Set the gains on the matrix mixer inputs from the program audio sources so that program audio is played into the room at a level similar to that of speech from the remote site. This should also ensure that the program audio levels are good when sent to the remote site.

INTEGRATING THE EF2241 INTO YOUR SYSTEM

Operating the EF2241

The EF2241 can be operated in two ways: through the LCD menu on the front panel or through RS-232. For control via RS-232, please refer to the EF2241 Programming Guide, which includes programming tips as well as the EF2241 RS-232 commands. For operation using the PC control software, Conference Composer, please refer to the Conference Composer User Guide.

Use Conference Composer software to easily configure the EF2241 with a PC, or refer to the Applications Guide for different configurations that are already programmed into factory presets.

INPUT SETTINGS

Set Inputs 1-4 for Mic or Line Level

Configure Inputs 1-4 for mic or line level using the LCD menu (See “Level” on page 30) or Conference Composer Control Software (See the Conference Composer User Guide).

Select Phantom Power for Inputs 1-4

Turn phantom power On or Off for Inputs 1-4 using the LCD menu (See “Phantom Power” on page 30) or Conference Composer Control Software (See the Conference Composer User Guide). Phantom power should be turned On for condenser and electret microphones.

CALIBRATION

When using the factory default, Preset 0, the following calibration can be used.

Set Mic/Line Input Channel Gains

In Preset 0, Automatic Gain Control (AGC) is On and the microphone gains on Inputs 1-4 are set to 15 dB. The AGC will compensate for the microphone gain. If you are using ceiling microphones, set the microphone gain to 28 dB.

Fine tune the Input Gain using the Automatic Gain Control (AGC) meter on Conference Composer Software. In the Conference Composer Software, go to the DIAGNOSTICS page. Watch the meter labelled AGC while someone is talking into the particular channel that you are adjusting. Watch the number in the box at the bottom of the AGC meter (See Figure 9 below). This is the amount of gain that the AGC is applying. The goal is to have the AGC meter on average staying around 0. If the level that you see in the box is negative, decrease the input gain by the average number that you see in the box because the AGC is attenuating the channel’s input gain because the level is too high. If the number in the box is positive, increase the input gain on that channel because the AGC is boosting the signal because it is too low. For example, if the meter is showing an average gain of -15 dB,

you should increase your input gain by 15 dB. If the meter shows an average gain of +10 dB, you should decrease your input gain by 10 dB.

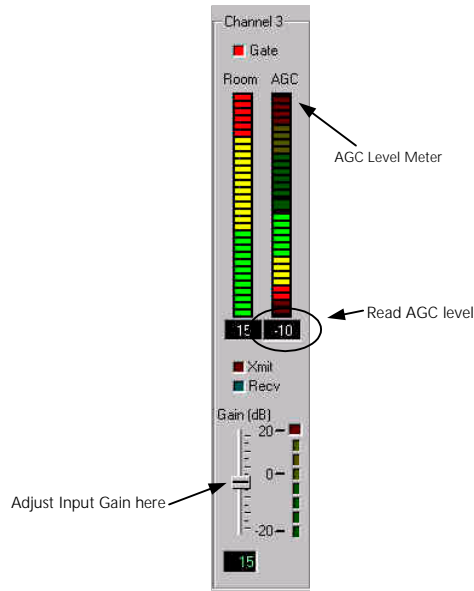

Figure 9. AGC Meter on the Diagnostics page of the Conference Composer software. The gain adjustment is the same gain control on the Mic/Line Inputs page in Conference Composer.

IF THE AGC METER SHOWS...	ADJUST THE INPUT GAIN IN THIS WAY.
positive gain	Increase gain by the level shown in the box.
negative gain	Decrease gain by the level shown in the box.
an average level of 0 dB	You've set the Input Gain to a good level!

Table 1: How to set the Input Gain using the AGC meter on the Conference Composer Diagnostics page.

Set Levels on Line Input Channels

Set the line input channel gains (Channels A-D) to match the nominal level of the incoming equipment. The line inputs have a maximum nominal level of 0 dBu. If your incoming line level inputs have a higher nominal level than 0 dBu you will want to use a pad to remove the level.

If you are connecting from equipment that has RCA plugs, you will most likely need 8 dB of gain on the Input and -8 dB of gain on the Output.

Customize Setting for Your Particular Application

The following sections will describe customizing parameters on the EF2241 for your particular application if you are not using Preset 0.

SET UP THE PHONE INTERFACE

The echo canceller reference of the EF2241 is by default set up with the phone input already assigned to it.

By default the phone interface will be disabled until you select a country code for the telephony interface. This can either be done with the front panel LCD menu, or the RS-232 interface. The country code only needs to be selected the first time or when the country of the installation is changed.

Send audio from the phone to the outputs on the same device by unmuting the cross-point of Input T on that output. Send audio from the phone to other linked devices by using the P bus output in the EF Bus. The linked devices can take the phone signal off the bus from the P Bus input.

BUILD YOUR ECHO CANCELLER REFERENCE

The acoustic echo canceller (AEC) reference should generally contain exactly the same audio signals as what is coming out of your loudspeaker(s), since the signal output from the loudspeaker is what is then picked up by the room's microphones causing acoustic echo. Note that this statement is a general statement. Conditions for this being true follow:

If your system does NOT have sound reinforcement,

- The AEC reference should contain exactly the same audio as the loudspeaker output: all far end audio, audio from the phone add, program audio, etc.
- If your system contains stereo inputs and outputs, the reference must contain a mix of both stereo inputs. For example, if your VCR audio is in stereo, the reference should contain both the left and right signals each attenuated by 3 dB, as well as any other audio that is going to your loudspeaker.
- If you are using crosspoint gains in the loudspeaker mix, apply the same gains to the signals in your reference.

If your system has sound reinforcement,

- Do NOT mix your room microphones into the reference, but include all other audio (program audio, remote audio, phone audio, etc.).

ECHO CANCELLER REFERENCE FOR MULTIPLE VORTEX DEVICES

In a system with multiple devices, we recommend that one device be designated as the unit that provides the EF bus reference for the acoustic echo cancellers. This unit takes one of its reference signals (either Ref 1 or Ref 2) and places it on the EF bus. All other units that are linked together may use the EF bus reference as the reference

The image shows a matrix page titled 'OUTPUTS' with a 'Safety Mute' button. The matrix has columns for IN (1-8), A, B, C, D, and various output channels (W, X, Y, Z, R1, R2, M1, M2, AEC). Rows include Mic 9-12, INPUTS (A-D), wM0-2, yM0-2, zM0-2, and PM0-1. A 'Signal Generator' row is at the bottom. At the bottom of the matrix are buttons for 'Find', 'Not Muted', 'Muted', 'Automixer 1', and 'Automixer 2'.

Figure 12. Matrix page of linked devices

If far end audio and program audio sources are on several Vortex devices.

1. Bus each far end audio and program audio source to each device. Do this by assigning each signal input to either the W, X, Y or Z bus.
2. Assign an echo canceller reference on each device that will include all far end audio and program audio sources.

CONFIGURE THE AUTOMATIC MICROPHONE MIXER

The EF2241 contains two independent automatic microphone mixers. Each input may be assigned to automatic mixer 1, automatic mixer 2, or neither (but not both). Assign all microphones to the same automixer when using all microphones in the same room but in different zones, so that a person does not activate microphones in two different zones (which they would tend to do if each zone had its own automatic mixer). Use both automatic mixers when the EF2241 is split to operate independently between two rooms. One automatic mixer is used in each room. The advantage of having two independent automatic mixers is that when used in two rooms, microphone signals in one room do not affect the gating behavior of microphones in the other room. Set an input channel to use neither automatic mixer if an input is not actually a microphone, but is a program audio input. For instance, if you only have 6 microphones and you have an extra stereo program audio source that you want automatic gain control (AGC) on and/or noise cancel, you could set its channels to be on neither automatic mixer.

If you have a PC, use the Conference Composer software (See the Conference Composer User Guide) to set the automixer parameters. If you would like to set automixer parameters using the LCD menus, see “Automixer Menu” on page 31 for instructions on setting automixer parameters.

Automixer Parameters

The following parameters configure how the EF2241 automatic microphone mixer operates. Parameters include the following: Decay Time, Hold Time, Camera Gating Threshold, Chairman Mode, Chairman Mic, Last Mic On Mode, Last Mic Number,

Local Max NOM, Global Max NOM, Off Attenuation, Threshold Type, Gating Mode, Adaptive Threshold, Manual Threshold, and Gate Priority.

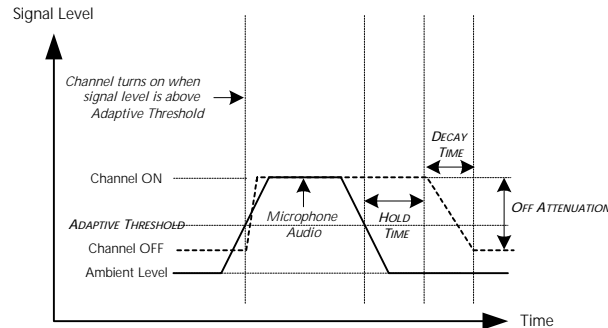

Figure 13. Off Attenuation, Hold Time, Adaptive Threshold, and Decay Time.

Global Settings.

Decay Time. Decay time is the amount of time the microphone audio takes to ramp down to the Off Attenuation level after Hold Time. Decay Time values range from 0 to 5000 msec. The default value is 1000 msec.

Hold Time. This is the amount of time the microphone stays On after the energy in the channel drops below the gating threshold. The default value is 500 msec. The range is 1 to 5000 msec. Microphone channels gating On and Off too frequently during short pauses in speech might be the result of setting the Hold Time too low while too many microphones gating on at the same time may be the result of Hold Time values that are too high.

Camera Gating Threshold. Specifies the hold time for camera gating information.

Mixer Settings.

Bus Mixer. This command is used to assign one of the two internal automixers to one of the EF Bus automixer groups. For example, consider three Vortex devices each of which has 2 microphones assigned to Automixer 1 and 2 microphones assigned to Automixer 2. Now, if each of these devices sets their Automixer 1 to use Bus Mixer 5 for example, then the three automixers (one from each device) will work as a single automixer containing 6 (3 x 2) microphones. Setting Bus Mixer to 0 means that the automixer is not grouped on the EF Bus and the automixers operate independently.

Chairman Mode. Enables or disables Chairman Mode for the specified automixer.

Chairman Mic. Sets the Chairman Microphone for the specified automixer.

Last Mic On Mode. Sets “Last Mic On” mode for the specified automixer.

Last Mic Number. Sets the microphone number that will remain on when “Last Mic On” mode is set to manual. Setting this value to 0 will cause the automixer to leave the last open microphone on. The last microphone number is specified for each automixer, but is only used in manual “Last Mic On” mode.

Local Max NOM. Sets the maximum number of open microphones (NOM) limit for the specified automixer. This NOM limit is a “local” limit, meaning that this limit applies only to the specific Vortex device that it is set on.

Global Max NOM. Sets the global maximum number of open microphones

(NOM) limit for each linked automixer. The maximum value for this command is 64. This NOM limit is a “global” limit, meaning that this limit applies to all linked automixers with the same Bus ID.

Off Attenuation. Sets the Off Attenuation (in dB) for the specified automixer. Setting this value to 18 would result in the microphone signals being attenuated by 18 dB when gated off. This value is set independently for each of the automixers.

Channel Settings.

Automixer (Inputs 1-4). This allows you to select which automatic microphone mixer (1 or 2) a particular microphone channel is assigned to. A microphone may only be assigned to automatic mixer 1, automatic mixer 2, or neither (but not both).

Threshold Type. Sets adaptive or manual automatic gating thresholds per input. The default is adaptive.

Gating Mode. Sets the automixer gating control mode for specified input channel. The possible modes are Normal Gating, Microphone Forced On, or Microphone Forced Off.

Adaptive Threshold. This is also referred to as the Adaptive Threshold. This allows you to determine when to gate a microphone on based on an estimate of the background noise level. The default value is to gate a channel on if it is more than 10 dB louder than the background noise level. Values range from 0 to 100 dB. To set the Adaptive Threshold, scroll through the Adaptive Threshold range and select the desired Adaptive Threshold by pressing ENTER.

Manual Threshold. Sets the automixer gating threshold for the specified input channel. This value is only used if the input set to Manual Gating via the THRESHOLD TYPE option.

Gate Priority. The priority of each microphone can be assigned a value ranging from 1 to 4. Priority 1 microphones have priority over priority 4 microphones for gating. The default is to have all microphones set to priority 1. If Chairman Mode is enabled, all microphones including ones with priority of 1 will be gated off when the Chairman mic gates on.

AUTOMIXER SETTINGS FOR MULTIPLE VORTEX DEVICES

When using more than one Vortex device in your room system, you have several possibilities for how you configure the automixer. Each device can operate as one of the following:

- One automixer, independent of other devices linked to it
- Two automixers, independent of other devices linked to it
- One large automixer, sharing automixer functions with other devices linked to it
- Two large automixers, sharing automixer functions with other devices linked to it

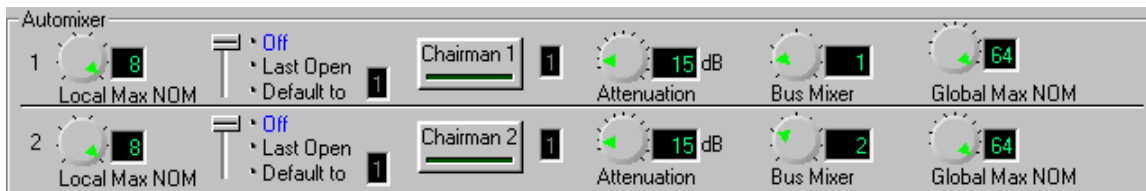

Figure 14. Vortex Automixer Settings in Conference Composer Software

Automixer and Bus Mixer Settings

To operate the Vortex device in any of the above possibilities, two global parameters need to be changed: the AUTOMIXER and the BUS MIXER (see Figure 14). The AUTOMIXER parameter chooses which automixer the input channel will be on (this is changed either on the AUTOMIXER page in Conference Composer or on the MATRIX MIXER page).

The BUS MIXER parameter is used to assign one of the two internal automixers to one of the EF Bus automixer groups. For example, consider three Vortex devices, each of which has 2 microphones assigned to Automixer 1 and 2 microphones assigned to Automixer 2. Now, if each of these devices sets their Automixer 1 to have Bus ID 5, then the three automixers (one from each device) will work as a single automixer containing 6 (3 x 2) microphones. Setting BUS MIXER to 0 means that the automixer is not grouped on the EF Bus.

Operating as an Independent Automixer

To set the Vortex device to operate as an independent automixer (or two), set the BUS MIXER parameter to 0, or to a number that is different from any other automixer group on the EF Bus.

Operating as One Automixer with Multiple Vortex Devices

To set the Vortex device to operate as one automixer across several devices, set the BUS MIXER parameter on all devices to the same automixer group.

Default Settings

In the default preset (Preset 0), the Bus Mixer for Automixer 1 is set to 1 and the Bus Mixer for Automixer 2 is set to 2. This means that in the default mode, all linked devices will work together as one complete automixer.

CONFIGURE THE MATRIX MIXER

The matrix mixer allows arbitrary crosspoint gains in 1 dB increments between any input and output signal.

If you have a PC, use the Conference Composer software (See the Conference Composer User Guide) to set the matrix parameters. If you would like to set matrix parameters from the LCD menus, see “Matrix Menu” on page 34 for descriptions and instructions on setting matrix mixer parameters.

BUILDING YOUR SYSTEM WITH MULTIPLE VORTEX DEVICES

The following is a checklist for building a system with multiple devices:

1. Assign Inputs.
2. Assign Outputs.
3. Configure submatrix (the EF Bus).
4. Configure your echo canceller reference.

1. Assign Inputs

Assign each audio source to an input. Remember to include the conferencing equipment such as a video codec and any program audio.

2. Assign Outputs

Try to assign as many outputs as you can to one Vortex device to make a simpler submatrix. Remember that Outputs 1-4 can also be used as outputs of the matrix. The bussing gets more complicated if you choose to spread your outputs over several units.

3. Configure the submatrix.

To link multiple devices together, use the submatrix on the EF Bus to configure which signals to receive from other devices that have put their signals on the Bus.

THE EF BUS

The EF Bus is a high speed, low delay digital bus that includes the W, X, Y, and Z audio busses, the P bus, as well as the echo canceller bus reference and remote control information (for other EF devices). It can link up to 8 Vortex devices. The W, X, Y, and Z busses include NOM information and can be used for sharing microphone inputs, or for sharing mono or stereo program information. On the EF Bus page in Conference Composer, the inputs coming in to each submatrix labelled WB0, WB1, ... WB7 correspond with the device ID of the bus that is transmitting. The “B” denotes Bus. The submixes themselves, denoted as WM0, WM1, and WM2 are mixes that are input into the main matrix. The “M” denotes Mix.

The P Bus. The P Bus is provided specifically to allow devices to share digital phone audio from the EF2241. The EF2241 can both transmit and receive signals on the P bus, while the EF2280 can only receive signals from the P bus.

Crosspoint Mix Minus Bus. Each Vortex device in the system can create four output mixes (W, X, Y, and Z) and place them on the bus. Each device also can create three input mixes each from the W, X, Y, and Z busses of the other devices (for a total of 12 mixes). The mixes can have crosspoint gains on the signals from the other devices. See Figure 15 below. All 12 mixes become inputs to the main matrix and can be mixed with the other inputs to create outputs 1-4, A-D, Ref 1, Ref 2, and W, X, Y, and Z bus outputs.

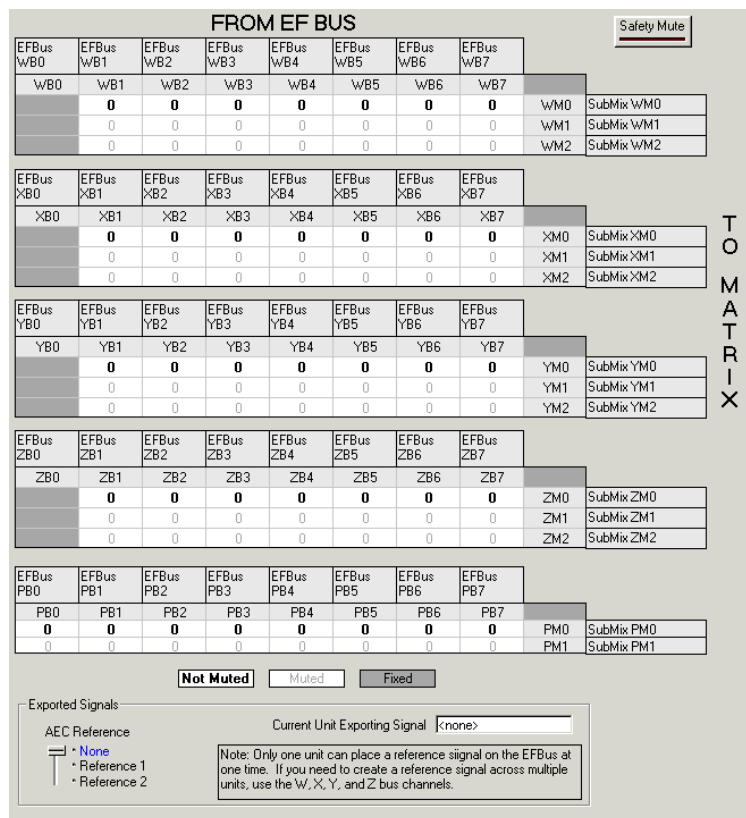

Figure 15. W, X, Y, and Z submatrices, the P submatrix, and Exported Bus Reference.

EF Bus Reference. In a system with multiple devices, if all devices need the same echo canceller reference, one device should be designated to put its echo canceller reference (either Ref 1 or Ref 2) on the EF bus to be used as the EF Bus Reference. All other devices may use the EF bus reference as the reference for their echo cancellers, or they can use their own internal references. The references may include a mix of any input, with crosspoint gains, including W, X, Y, and Z busses.

NOM Bus. The W, X, Y, and Z busses on the EF Bus contain NOM information. See “NOM Active” on page 31 for more information on how NOM attenuation is applied.

Note. *The EF Bus must be connected so that the EF BUS OUT of one Vortex device is connected to the EF BUS IN of another Vortex device. Connecting EF BUS IN to another EF BUS IN (or EF BUS OUT to EF BUS OUT) will not work. See “Connector Pinouts” on page 51 for pinout of Cat 5 cable.*

4. Configure Your Echo Canceller Reference

Review what inputs need to be included in your echo canceller reference — See “Build Your Echo Canceller Reference” on page 17. Remember that each microphone needs to have an echo canceller reference. If all microphones are in the same room and use the same reference, configure the echo canceller reference on one Vortex device and assign it to the EF Bus as the EF Bus Reference. Only one Vortex device out of multiple units linked together can put an echo canceller reference on the EF Bus. For each additional unit, assign the echo canceller reference to use the EF Bus Reference.

For systems with more than one room, you will need to use the W, X, Y, or Z sub-busses to share the echo canceller reference in your additional rooms if the EF Bus Reference has already been assigned to the EF Bus.

PRESETS

After configuring your Vortex device, save your settings to a User Preset (PRESETS 16-47). Also, set the POWER ON PRESET to the User Preset you have saved to. The POWER ON PRESET determines how the unit is configured upon power up.

If you have multiple Vortex devices in your system, save to a User Preset on each unit and set the POWER ON PRESET accordingly.

OTHER EF2241 FEATURES

For information on Macros, Logic Inputs, Logic Outputs, Input Filters and Output Filters, please refer to the Conference Composer User Guide.

LCD MENU STRUCTURE

LCD Menu Tree

The EF2241 LCD menu structure is made up of nine menu trees: SYSTEM, PHONE CONTROL, INPUTS, OUTPUTS, AUTOMIXER, MATRIX, PARAMETRIC EQ, PRESETS, and MACROS. Each menu tree is organized by levels and branches into multiple subcategories. The branches end with an adjustable parameter or value.

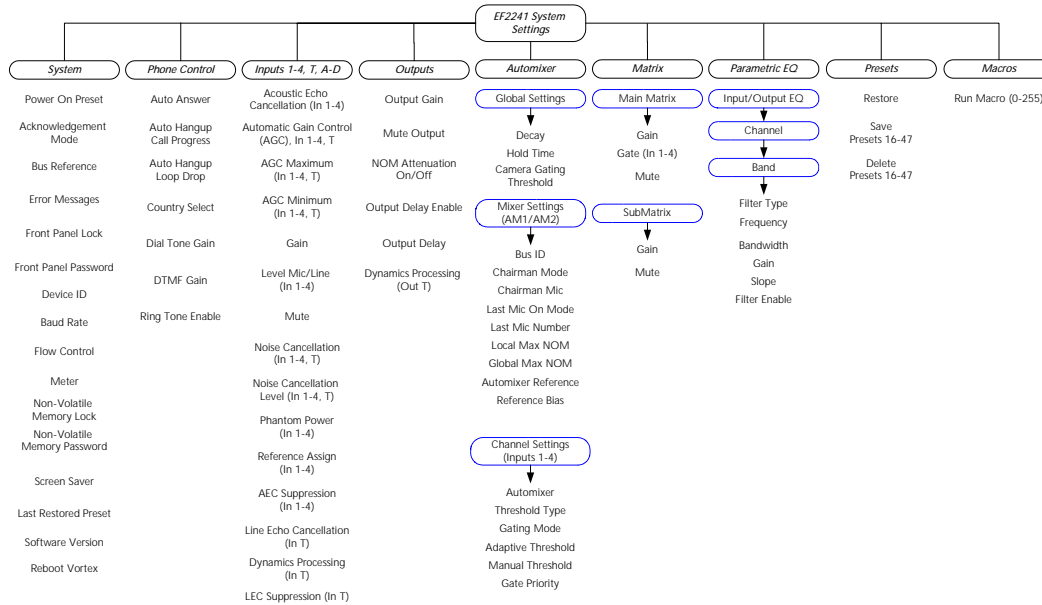

Figure 16. LCD Menu Tree.

DOWN	UP	ENTER	ESC	HOME
Scrolls backward through menu items at particular level or decreases the value of a parameter	Scrolls forward through menu items at particular level or increases the value of a parameter.	Enters the menu and allows you to select and change parameter values.	Returns to the top of the next highest level of menus	Returns to the top of the menu structure.

Table 2: Summary of button functions on the EF2241.

The EF2241 has five menu buttons on the front panel for navigation in the menu tree. Press the HOME button from anywhere in the menu tree to return to the top of the menu. The ENTER button enters the menu and the ESC button returns to the next highest level of menus. To scroll back through menu items at a particular level, use the DOWN button. To scroll forward through menu items at a particular level, use the UP button.

To adjust a parameter, first locate the parameter by scrolling to the appropriate menu (with combinations of the UP/DOWN and ENTER buttons). The display will show the parameter field and the parameter value. To change the parameter, the parameter

must be flashing. To make the parameter flash (assuming the front panel is not locked) press ENTER. Once the parameter is flashing, use the UP and DOWN buttons to adjust the parameter value. The parameter is instantly updated while it is being adjusted — you should hear changes as the parameter is changing. RS-232 control strings are also sent via the RS-232 port so your remote control device is instantaneously updated as well. Press ENTER to select and store the parameter value or press ESC to cancel the selected value and return to the old value. Pressing HOME has the effect of pressing ESC then HOME, so the selected value will be cancelled and the menu will return to the top of the menu tree.

Parameters that toggle or select among a list of options will wrap around when you reach the end, but parameters that adjust numeric values will not wrap around once the maximum or minimum value is reached. While adjusting a parameter, the UP/DOWN button must be held down briefly before the repeat rate increases.

SYSTEM MENU

<div style="border: 1px solid black; border-radius: 15px; padding: 2px 10px; display: inline-block; margin-bottom: 10px;">System</div> <ul style="list-style-type: none"> Power On Preset Acknowledgement Mode Bus Reference Error Messages Front Panel Lock Front Panel Password Device ID Baud Rate Flow Control LCD Contrast Meter Non-Volatile Memory Lock Non-Volatile Mem Password Screen Saver Last Restored Preset Software Version Reboot Vortex 	<p>The SYSTEM menu contains POWER ON PRESET, ACKNOWLEDGEMENT MODE, BUS REFERENCE, ERROR MESSAGES, FRONT PANEL LOCK, FRONT PANEL PASSWORD, DEVICE ID, BAUD RATE, FLOW CONTROL, LCD CONTRAST, METER, NON-VOLATILE MEMORY LOCK, NON-VOLATILE MEMORY PASSWORD, SCREEN SAVER, SOFTWARE VERSION, and REBOOT EF2241 configurations.</p> <p>Power On Preset. Choose the EF2241 Preset for power up.</p> <p>Acknowledgement Mode. This command controls whether or not status messages are sent.</p> <p>EF Bus Reference. This designates which EF2241 device, when multiple devices are linked together, will put one of their echo canceller references on the EF bus to be used as the EF bus reference.</p> <p>Error Messages. Turns error messages On or Off.</p> <p>Front Panel Lock. Locks or unlocks the front panel. When the front panel is locked, you can see the parameters but you cannot change them.</p> <p>The default passcode is <code>aspi</code> (case is important).</p> <p>Front Panel Passcode. Once the device has been unlocked, the passcode may be changed. At the FRONT PANEL PASSCODE menu, press ENTER and then enter a passcode and press ENTER until you reach the end of the screen.</p> <p>Device ID. Selects the Device ID of the unit.</p> <p>Baud Rate. Selects baud rate of the RS-232.</p> <p>Flow Control. Selects flow control between Hardware, None, or Auto.</p> <p>LCD Contrast. Controls the contrast level of the front panel liquid crystal display (LCD). Higher numbers result in darker characters on the display, lower numbers result in lighter characters.</p> <p>Meter. Selects which signal is displayed on the front panel LED meter.</p> <p>Non-Volatile Memory Lock. Controls the non-volatile lock feature. When the non-volatile memory is locked, you can query the settings but will get an error if you try to change them.</p> <p>Non-Volatile Memory Password. This feature sets or queries the non-volatile lock password. This password is used in conjunction with NON-VOLATILE MEMORY LOCK. The default password is <code>aspi</code> (case is important).</p> <p>Screen Saver. Enables or disables the screen saver on the LCD panel. You can also set the idle time.</p> <p>Last Restored Preset. Displays the last restored Preset.</p> <p>Software Version. Queries the software version.</p> <p>Reboot EF2241. Cycles power on the EF2241.</p>
--	---

Figure 17. EF2241 System submenu

PHONE CONTROL

Phone Control

Auto Answer

Auto Hangup
Call ProgressAuto Hangup
Loop Drop

Country Select

Dial Tone Gain

DTMF Gain

Ring Tone Enable

Auto Answer. Enables or disables auto answer.

Auto Hangup Call Progress. Enables or disables auto hangup based on call progress messages.

Auto Hangup Loop Drop. Enables or disables auto hangup based on loop drop.

Country Select. Selects the country where you are using the unit. This must be set before you can use the unit and does not need to be set again unless you use the unit in a different country.

Dial Tone Gain. Adjusts the gain of the dial tone.

DTMF Gain. Adjusts the gain of the DTMF tones.

Ring Tone Enable. Enables or disables ring tones.

Figure 18. EF2241
Phone Control sub-
menu

INPUTS

Inputs 1-4, T, A-D

Acoustic Echo Cancellation (In 1-4)

Automatic Gain Control (AGC), In 1-4, T

AGC Maximum (In 1-4, T)

AGC Minimum (In 1-4, T)

Gain

Level Mic/Line (In 1-4)

Mute

Noise Cancellation (In 1-4, T)

Noise Cancellation Level (In 1-4, T)

Phantom Power (In 1-4)

Reference Assign (In 1-4)

AEC Suppression (In 1-4)

Line Echo Cancellation (In T)

Dynamics Processing (In T)

LEC Suppression (In T)

Figure 19. EF2241 Inputs submenu

The input menu allows the user to adjust functions related to the input signals to the EF2241. This menu contains ACOUSTIC ECHO CANCELLATION, AUTOMATIC GAIN CONTROL, AGC MAXIMUM, AGC MINIMUM, GAIN ADJUST, LEVEL MIC/LINE, MUTE, NOISE CANCELLATION, NOISE CANCELLATION LEVEL, PHANTOM POWER, REFERENCE ASSIGN, and AEC SUPPRESSION. The menu is organized around the Inputs (1-4) and (A-D), so that you first select an input and then select settings for that input. You can also choose to apply the settings to all Inputs, Inputs 1-4, or Inputs A-D.

Acoustic Echo Cancellation. This allows you to enable or disable the acoustic echo canceller on a particular channel. The default is On.

Automatic Gain Control (Inputs 1-4, T). This enables automatic gain control (AGC) on Inputs 1-4 and T. The default is On.

AGC Max (Inputs 1-4, T). Sets the maximum gain value that the AGC can apply for Inputs 1-4 and T.

AGC Min (Inputs 1-4, T). Sets the minimum gain value that the AGC can apply for Inputs 1-4 and T.

Gain. This parameter adjusts the gain level of the 8 inputs. This is normally configured during the calibration process. **The default setting is 15 dB for microphone signals and 0 dBu for line level signals.** See “Level” above for setting mic/line level for Inputs 1-4. The LEVEL INDICATOR on the front panel automatically reflects the level of the channel whose gain is being adjusted.

Level. Use this parameter to select mic or line level on Inputs 1-4.

Mute. This selects which input channel (1-4, A-D) or the W, X, Y, or Z input is muted. The default is not muted.

Noise Cancellation (Inputs 1-4, T). This allows you to enable or disable noise cancellation.

Noise Cancellation Level (Inputs 1-4, T). Selects the level of noise cancellation. This ranges from 0 to 15 dB. The default is 10 dB.

Phantom Power. Use this parameter to turn phantom power On or Off for inputs 1-4.

Echo Canceller Reference. This parameter decides which reference is associated with which zone. Choose between REF1, REF2, or the external bus reference.

AEC Suppression. Sets the amount of double talk suppression used in the AEC. The values correspond to the following settings: 1 = No Suppression, 2 = Light Suppression, 3 = Heavy Suppression, 4 = Half-Duplex.

Line Echo Cancellation. Enables or disables the echo cancellation on the phone line.

Dynamics Processing. Enables or disables compression on Input T.

LEC Suppression. Sets the amount of suppression used the line echo canceller (LEC).

Phone Input Gain. This parameter adjusts the gain level of the Phone input.

Phone AGC. Enables or disables automatic gain control on the Phone.

OUTPUTS

The OUTPUT menu contains GAIN, NOM ACTIVE, and MUTE. As with the INPUT menus, this is done on a per channel basis.

Outputs

Output Gain

Mute Output

NOM Attenuation
On/Off

Output Delay Enable

Output Delay

Dynamics Processing

Figure 20. EF2241
Outputs submenu

Output Gain. Choose the gain applied to each output signal using this parameter. **The default setting is 0 dBu.** Though the EF2241 allows for positive output gain, you should always try to adjust input gains to a good level so that the output gain is 0 dB. If you find that you need a positive output gain from the EF2241, first check your input gain to make sure you are getting a good level (around 0dB). Keep the output gain at around 0 dBu. Then, for the best gain structure, use your amplifier to raise the volume in your system.

Mute Output. Use this to mute or unmute each Output.

NOM Active. This allows you to select whether the NOM attenuator is active for a particular output channel (Outputs 1-4, A-D). The NOM attenuator will attenuate the output signal by $10 \cdot \log_{10}(\text{NOM})$ where NOM is the number of open microphones in that particular output channel. NOM is calculated based on the number of open microphones for each signal that is in the output.

Output Delay Enable. This allows you to enable delay to each of the outputs.

Output Delay. Sets the amount of delay on the output. The default value is 0 ms. The range is 0 to 340.0 ms in 0.1 ms increments.

Dynamics Processing. Enables or disables compression on Output T.

AUTOMIXER MENU

Automixer

Global Settings

Mixer Settings

Channel Settings

Figure 21. EF2241
Automixer submenu

These parameters configure how the Vortex device automatic microphone mixer operates. Parameters include the following: DECAY TIME, HOLD TIME, CAMERA GATING THRESHOLD, BUS ID, CHAIRMAN MODE, CHAIRMAN MIC, LAST MIC ON MODE, LAST MIC NUMBER, LOCAL MAX NOM, GLOBAL MAX NOM, OFF ATTENUATION, AUTOMIXER, THRESHOLD TYPE, GATING MODE, ADAPTIVE

THRESHOLD, MANUAL THRESHOLD, and GATE PRIORITY.

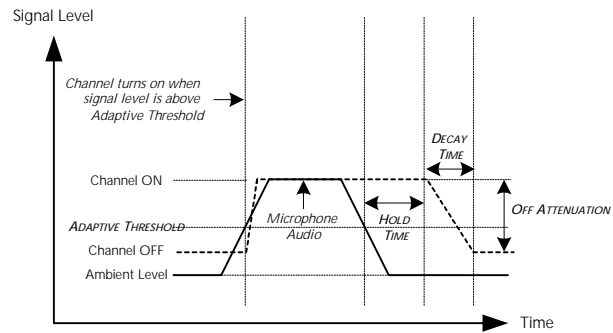

Figure 22. Automixer parameters.

Global Settings.

Decay Time. Decay time is the amount of time the microphone audio takes to ramp down to the Off Attenuation level after Hold Time. Decay Time values range from 0 to 5000 msec. The default value is 1000 msec.

Hold Time. This is the amount of time the microphone stays On after the energy in the channel drops below the gating threshold. The default value is 500 msec. The range is 1 to 5000 msec. Microphone channels gating On and Off too frequently during short pauses in speech might be the result of setting the Hold Time too low while too many microphones gating on at the same time may be the result of Hold Time values that are too high.

Camera Gating Threshold. Specifies the hold time for camera gating information.

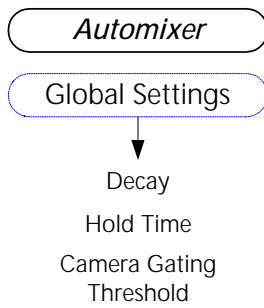

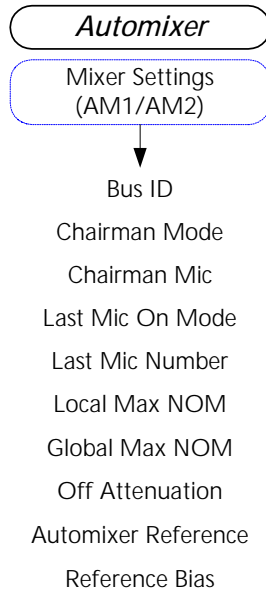

Mixer Settings.

Bus Mixer. This command is used to assign one of the two internal automixers to one of the EF Bus automixer groups. For example, consider three Vortex devices each of which has 2 microphones assigned to Automixer 1 and 2 microphones assigned to Automixer 2. Now, if each of these devices sets their Automixer 1 to have Bus Mixer 5, then the three automixers (one from each device) will work as a single automixer containing 6 (3 x 2) microphones. Setting Bus Mixer to 0 means that the automixer is not grouped on the EF Bus.

Chairman Mode. Enables or disables Chairman Mode for the specified automixer.

Chairman Mic. Sets the Chairman Microphone for the specified automixer.

Last Mic On Mode. Sets “Last Mic On” mode for the specified automixer.

Last Mic Number. Sets the microphone number that will remain on when “Last Mic On” mode is set to manual. Setting this value to 0 will cause the automixer to leave the last open microphone on. The last microphone number is specified for each automixer, but is only used in manual “Last Mic On” mode.

Local Max NOM. Sets the maximum number of open microphones (NOM) limit for the specified automixer. This NOM limit is a “local” limit, meaning that this limit applies only to the specific Vortex device that it is set on.

Global Max NOM. Sets the global maximum number of open microphones (NOM) limit for each linked automixer. The maximum value for this command is 64. This NOM limit is a “global” limit, meaning that this limit applies to all linked automixers with the same Bus ID.

Off Attenuation. Sets the Off Attenuation (in dB) for the specified automixer. Setting this value to 18 would result in the microphone signals being attenuated by 18 dB when gated off. This value is set independently for each of the automixers.

Automixer Reference. When enabled, the echo canceller reference becomes a muted input in the automix so that far end audio coming from the speakers does not gate on local microphones.

Reference Bias. Adjusts how much gain is applied to the Automixer Reference signal. The higher the gain, the harder it will be for local talkers to gate on a microphone.

Channel Settings.

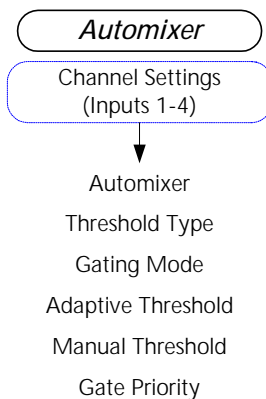

Automixer (Inputs 1-4). This allows you to select which automatic microphone mixer (1 or 2) a particular microphone channel is assigned to. A microphone may only be assigned to automatic mixer 1, automatic mixer 2, or neither (but not both).

Threshold Type. Sets automatic (also referred to as adaptive) or manual automatic gating thresholds per input.

Gating Mode. Sets the automixer gating control mode for specified input channel. The possible modes are Normal Gating, Microphone Forced On, or Microphone Forced Off.

Adaptive Threshold. This is also referred to as the Adaptive Threshold. This allows you to determine when to gate a microphone on based on an estimate of the background noise level. The default value is to gate a channel on if it is more than 10 dB louder than the background noise level. Values range from 0 to 100 dB. To set the adaptive threshold, scroll through the adaptive threshold range and select the desired adaptive threshold by pressing ENTER.

Manual Threshold. Sets the automixer gating threshold for the specified input channel. This value is only used if the input is set to Manual Gating via the THRESHOLD TYPE option.

Gate Priority. The priority of each microphone can be assigned a value ranging from 1 to 4. Priority 1 microphones have priority over priority 4 microphones for gating. The default is to have all microphones set to priority 1. If Chairman Mode is enabled, all microphones including ones with priority of 1 will be gated off when the Chairman mic gates on.

MATRIX MENU

The MATRIX contains commands for assigning input signals to output signals with appropriate gains applied or mutes applied. It also allows for Gating to be turned on for Inputs 1-4. This menu can apply gains to both the MAIN MATRIX and the SUBMATRIX.

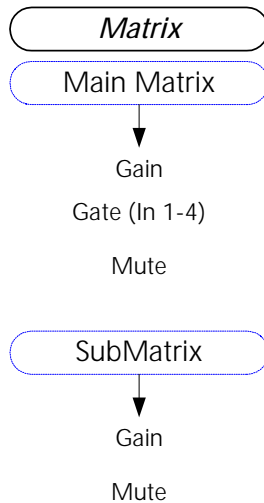

Crosspoint Gains. Assign input signals to output signals with appropriate gains applied.

Gate. Applies gating from Inputs 1-4 to an Output.

Mute. Applies mute to the crosspoint.

Figure 23. EF2241
Matrix submenu

PARAMETRIC EQ MENU

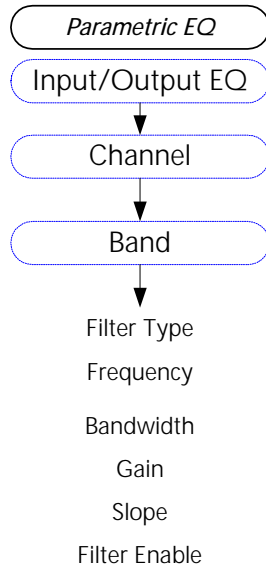

Figure 24. EF2241
Parametric EQ sub-
menu

The input equalizer is comprised of up to 5 bands of filtering. The whole group of filters for the channel can also be enabled/disabled without losing the settings for each band. For each band, you first select the type of filter from the following: Parametric/Peaking, High Shelf, Low Shelf, Lowpass, or Highpass.

Parametric/Peaking.

- Center Frequency: in Hz, between 20 Hz and 20,000 Hz in 1 Hz steps.
- Bandwidth: in octaves, between 0.05 and 2 octaves in 0.05 octave steps.
- Gain: in dB, between -20 and +20 in 1 dB steps.

High Shelf.

- Center Frequency: in Hz, between 20 Hz and 20,000 Hz in 1 Hz steps.
- Bandwidth: in dB/octave, between 1 and 24 dB/octave, but is always less than or equal to 1.2 x Gain.
- Gain: in dB between -20 and +20 in 1 dB steps.

Low Shelf.

- Center Frequency: in Hz, between 20 Hz and 20,000 Hz in 1 Hz steps.
- Bandwidth: in dB/octave, between 1 and 24 dB/octave, but is always less than or equal to 1.2 x Gain.
- Gain: in dB between -20 and +20 in 1 dB steps.

Lowpass.

- Cutoff Frequency: in Hz, between 20 Hz and 20,000 Hz in 1 Hz steps.

Highpass.

- Cutoff Frequency: in Hz, between 20 Hz and 20,000 Hz in 1 Hz steps.

Center frequency on Parametric/Peaking is the point with the most (or least) gain. Bandwidth is the width halfway up the peak (so if the peak is 10 dB, it is the width between the points where the gain is 5 dB).

Center frequency on shelving filters is the frequency where it crosses the point halfway between 0 dB and the gain of the filter, halfway up the slope.

PRESETS

Presets

Restore

Save
Presets 16-47

Delete
Presets 16-47

Restore. Restores the selected preset.

Save. Saves the selected user preset (Presets 16-47). Factory presets (Preset 0-15) cannot be overwritten.

Delete. Deletes the selected user preset (Presets 16-47). Factory Presets (Presets 0-15) cannot be deleted.

Figure 25. EF2241
Presets submenu

MACROS

Macros

Run Macro (0-255)

Run Macro (0-255). Allows you to run macros from the front panel menu.

Figure 26. EF2241
Macros submenu

TROUBLESHOOTING

AUTOMATIC MICROPHONE MIXER

No microphones are gating

- Check if the microphones are muted.
- Are microphones part of one of the 2 automixers?

Some microphones are not gating

- Check if the microphones are assigned to an automixer.
- Check if the microphones are muted.
- Check microphone levels. Are microphones set to the appropriate mic or line level? Is phantom power on where needed?
- The Hold Time may be too low. Microphone channels gating On and Off too frequently during short pauses in speech might be the result of setting the Hold Time too low.
- Check Gating settings. Are microphones Forced Off?
- Is Chairman Mode on? If you have assigned a Chairman Mic, all other microphones will gate Off once this microphone gates on.
- Check Gating Priority. If your inputs have a Gating Priority of 4, the microphones may not gate as frequently.
- Check Maximum Number of Open Microphones. This parameter sets the number of open microphones allowed at any time. If this parameter is set too low, the microphones may not gate as often as you wish.
- Adjust the Adaptive Threshold if the Gate Threshold is set to Adaptive or adjust the Manual Threshold if the Gate Threshold is set to Manual. For Adaptive Gate Threshold, set the Adaptive Threshold lower so that the microphone will gate On when lower level signals are present at the microphone. For Manual Gate Threshold, set the Manual Threshold to a lower absolute threshold.

Too many microphones are gating

- The Hold Time might be too high. Too many microphones gating on at the same time may be the result of Hold Time values that are too high.
- Assign a Chairman Mic. This will cause all other microphones to gate Off once this microphone gates on and will prevent too many microphones from gating.
- Set Gating Priority so that not all microphones have the same priority. The default value for each input is a Gating Priority of 1, which is the highest priority.
- Adjust the Adaptive Threshold if the Gate Threshold is set to Adaptive or adjust the Manual Threshold if the Gate Threshold is set to Manual. For Adaptive Gate Threshold, set the Adaptive Threshold higher so that the microphone will gate when only louder signals are present at the microphone. For Manual Gate Threshold, set the Manual Threshold to a higher absolute threshold.
- Using the Adaptive Gate Threshold is recommended for more accurate gating.

MATRIX MIXER

Don't hear output

- Make sure the output is not muted.
- Check that the input you're expecting to hear is included in the output that you're listening to.

ECHO CANCELLER REFERENCE

Room Audio Sounds Choppy

If you hear the local room's audio from the loudspeakers and it sounds choppy, you may have included the room's microphones in the echo canceller reference. The echo canceller reference should NOT include the local room's microphones -- it should only contain the remote end's audio and program audio. You can still add the local room's microphones to the local output with the matrix, but do not add them to the echo canceller reference. For more specific guidelines on what to include in your echo canceller reference, see "Build Your Echo Canceller Reference" on page 17.

RESIDUAL ECHO

You may hear residual echo if system levels are not set properly. Improper level settings anywhere in the audio path can introduce nonlinearities that hamper the operation of the EF2241. If you hear residual echo, one of the following conditions may be causing the problem.

Reverberation vs. Acoustic Echo

Do not confuse the residual echo of remote speech with the reverberation of local speech. Reverberation of local speech is caused when the speech signal arrives at the microphone via several paths (the direct path and multiple reflections from surfaces in the room). This is a local room phenomenon that gives the talker's voice a hollow or resonant sound (as heard at the remote end).

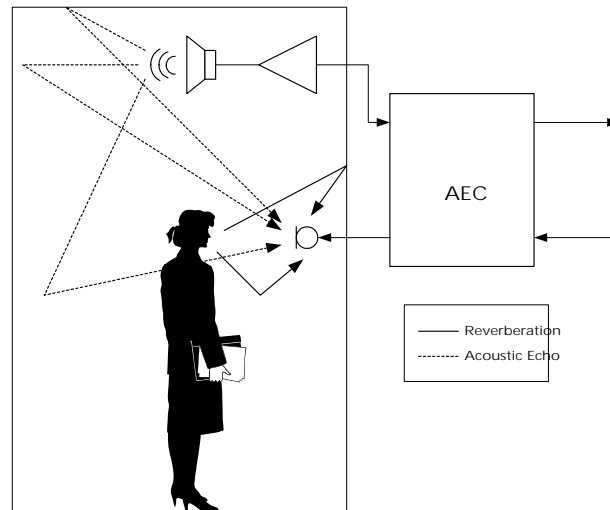

Figure 27. Reverberation vs. Acoustic Echo.

Reverberation is not an artifact of the echo canceller. It is mainly affected by the distance of the microphone from the speech source and by the resonances of the room. While reverberation can be unpleasant, it is not compensated for by the acoustic echo canceller (AEC), which only removes reflections of remote speech. If the remote end complains that they hear echo, ensure that they are referring to hearing their own voice and not echoes of local talkers.

You cannot remove the effects of reverberation by changing the EF2241's settings, but you can minimize reverberation by moving microphones closer to talkers and, if necessary, adding acoustical treatment to the room.

Finding the Source of Echo

Try muting one channel at a time to see if the echo that the remote end is hearing goes away when a particular channel is muted. If you find that the echo goes away when a particular channel is muted, the microphone may not be calibrated correctly. Check one or more of the following issues.

Room Gain

The most common cause of poor echo cancellation performance is incorrectly adjusted room gain. This may be explained as follows. The reference signal seen by the AEC is sent to a loudspeaker output, where it is amplified and sent to the room loudspeakers. The loudspeaker audio is coupled into the room microphones acoustically, through direct and reflected acoustic paths, and perhaps also through mechanical coupling. The microphone signal is then amplified and sent to the AEC as the local microphone input signal. The room gain of a microphone channel refers to the relative levels of the signal sent to the loudspeaker output (before any amplification)

and the level of this signal that is reflected as the microphone input (after microphone amplification).

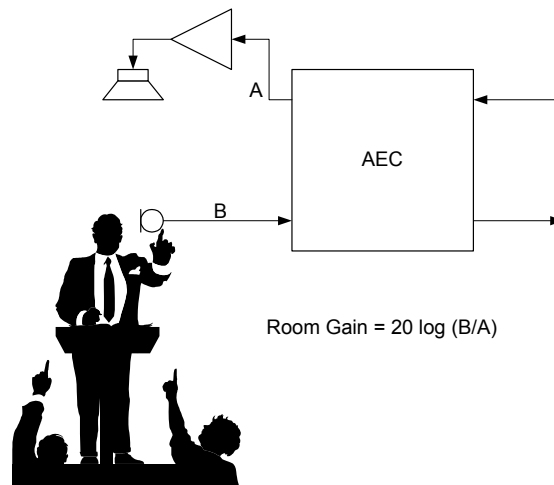

Figure 28. Room Gain.

If the electrical level of the reflected signal picked up by microphone is the same as the level of the electrical signal sent from the AEC to the loudspeaker output, the room gain of this microphone channel is said to be 0 dB. If the reflected signal picked up by the microphone is higher than the level of the signal sent to the loudspeaker output, that microphone channel has positive room gain. The more positive the room gain, the harder the AEC must work to determine which signal is an echo and which is a local speech signal.

Excessive Room Gain

Excessive room gain can be caused through a number of mechanisms:

1. The most common is excessive amplification of the remote (reference) signal at the local loudspeaker output. This may be explained as follows. If the reference signal is too low coming into the EF2241, i.e. the codec audio signal is too low, the room audio amplifier is usually used to compensate and bring the room audio to an acceptable level. For example, if the reference signal is 12 dB too low, the room audio will need to be amplified by approximately 12 dB to bring it to a reasonable listening level. This adds 12 dB to the room gain, which will most likely cause it to exceed the amplifier room gain limit (See “Verify Room Gain” on page 14). This situation can be remedied by applying enough gain to the codec, phone or program audio inputs (Inputs A-D) which will make up the Reference input signal so that the acoustic echo canceller (AEC) sees a good reference signal rather than trying to compensate at the amplifier.
2. Another common cause of room gain failure is excessive microphone amplification. For example, if a microphone is "hot" by 6 dB, then the reflections of the loudspeaker output signal which are picked up by the microphone will be amplified by 6 dB more than necessary. This adds 6 dB to the room gain, which may be sufficient to cause room gain problems. This situation could easily arise if, for example, the conferencing equipment is set up so that participants are too far from the microphone. In such a situation, after correct microphone setup the local microphone audio level may be too low because of the distance from the

talker to the microphone. The microphone audio will most likely also be muddy and reverberant. The installer or user may try to solve these microphone audio quality problems by turning up the microphone amplification, thus adding to the room gain. This problem can be remedied by proper microphone selection (pickup pattern, directionality) and placement, coupled with proper microphone input calibration.

3. A third common cause of room gain problems is excessive coupling between loudspeaker audio and microphones. This can be addressed by reducing the microphone coupling, either by positioning microphones so that their pickup patterns are biased away from the loudspeaker audio (and direct reflections of loudspeaker audio), repositioning loudspeakers, or reducing the loudspeaker amplification.

In summary, any amplification applied between the reference input and the microphone inputs can add to room gain problems. To avoid problems, ensure that the Reference input signal is not too low, and the microphone input signals are not too high. Run the built-in EF2241 Room Gain test to verify that you do not have room gain problems (See “Verify Room Gain” on page 14).

COMMON CAUSES OF EXCESSIVE ROOM GAIN	REMEDY
Excessive remote (reference) input amplification	Apply enough gain to the codec, phone or program audio inputs which will make up the Reference input signal.
Excessive microphone amplification	Select proper microphones for talker distance according to pickup pattern and directionality and properly calibrate mic inputs.
Excessive coupling between loudspeaker audio and microphones	Reduce mic coupling by repositioning mics or loudspeakers, or by reducing loudspeaker amplification.

Table 3: Summary of Excessive Room Gain.

In-Conference Quick Check

If you experience residual echo problems during a conference, you can quickly check that the reference and microphone levels are calibrated and not causing room gain problems by using the Room Gain parameter (See “Verify Room Gain” on page 14).

If this excessive coupling activity level is evident on only one microphone input channel, that microphone channel should either be redirected to reduce coupling to loudspeaker audio, or recalibrated as it will need to be turned down. If the excessive coupling activity is observed on all (or most) microphone channels, then this indicates either that the room audio is too loud or the reference signal may need to be recalibrated (this will be indicated by observing low activity levels on the SIGNAL LEVEL METER).

Excessive Microphone Amplification

For the EF2241 to adapt effectively, saturation (overload or clipping) must not occur at the A/D converter supplying the microphone input. Saturation introduces nonlinear signal distortions into what the AEC expects is a linearly echoed version of the remote speech.

Nonlinear distortion causes a degradation or divergence of the AEC's internal model of the room acoustics. In this situation, the EF2241 cannot effectively cancel room echoes and a substantial amount of echo may be heard by the remote party.

Excessive microphone amplification also increases room gain (See "Excessive Room Gain" on page 40.). You can check for excessive microphone amplification by observing the front panel LEVEL INDICATOR during a normal conference. The first yellow LED should illuminate frequently. If the second yellow LED is illuminated constantly during normal speech or if the red LED illuminates or even flickers, reduce the microphone input level.

Note. Before you readjust the microphone input levels, check to make sure you are looking at the correct channel on the LEVEL INDICATOR.

Note. If you adjust the MIC/LINE INPUT level, you will affect the room gain. Check to make sure that the room gain limit is not exceeded. See "Verify Room Gain" on page 14.

Insufficient Microphone Amplification

Grossly insufficient microphone gain degrades EF2241 performance and weakens the out-bound speech power level. This has the effect of reducing the signal-to-noise ratio of the microphone signal, which is analogous to raising the background noise level in the room. Because this noise is uncorrelated with the echoes within the room, the EF2241's ability to adapt and cancel echoes will be less than optimal.

A second effect of insufficient microphone gain is that the power of the microphone input signal may be substantially lower than that of the remote input signal. This reduces the ability of the decision logic to determine whether the AEC should be in transmit, receive, or double-talk mode. This effect may reduce the effectiveness of the EF2241 in canceling echoes.

You can check for insufficient microphone amplification by observing the front panel LEVEL INDICATOR during normal conferencing conversation. The first yellow LED should illuminate frequently. If the LEVEL INDICATOR never illuminates beyond one or two green LEDs during normal speech, increase the microphone's input level.

Note. Before you readjust the microphone input levels, check to make sure you are looking at the correct channel on the LEVEL INDICATOR.

Note. If you adjust the MIC/LINE INPUT level, you will affect the room gain. Check to make sure that the room gain limit is not exceeded. See "Room Gain" on page 39.

Nonlinearity

Overdriving the loudspeaker or inserting a dynamics processor before the EF2241 may distort the signal that the microphones see causing ineffective AEC operation. The EF2241 relies on the linearity of the acoustic feedback path — D/A, amplifier, loudspeaker, microphone, and A/D — to cancel acoustic echoes. If you overdrive the loudspeaker or insert a dynamics processor before the echo canceller, the acoustic reflections picked up by the microphone do not match the signal fed to the loudspeaker. They are distorted copies of this signal. The EF2241 cannot effectively cancel this distorted signal.

If you suspect the loudspeaker is introducing nonlinearities into the room acoustic path, take these steps to minimize its influence on the echo canceller.

- Keep the loudspeaker's volume level at less than three-eighths of full scale. If higher volume is required, the EF2241 should operate effectively at volume settings of up to 50 percent of full scale. At more than 50 percent, most audio systems and loudspeakers introduce significant nonlinearities. The EF2241 may not adapt under these conditions, and echoes may be heard.
- If the loudspeaker has a bass control, lower it. Excessive bass can cause a *boomy* effect that is nonlinear. In addition, excessive bass may cause substantial mechanical coupling to the microphone through vibrations induced in the housings and support structures.
- Increase the separation distance between microphones and the loudspeaker. The EF2241 handles up to 10 dB of room gain between the loudspeaker and the microphone. You may be exceeding this limit if the loudspeaker is pointed directly at the microphones or if the loudspeaker volume is excessive (loudspeaker placement is not critical, but it should not be pointed directly at the microphones).

CONTACTING TECHNICAL SUPPORT

If these troubleshooting guidelines don't resolve the problem you are experiencing with the EF2241, please check our web site (<http://www.polycom.com>) for the most current technical support information (go to Products & Services, then to Voice Products, then to Installed Voice Systems). If you have further questions, please contact us at:

Applications Engineering
Polycom Installed Voice Business Group
1720 Peachtree Street NW Suite 220
Atlanta, GA 30309-2439

Phone: (800) 932-2774
Fax: (404) 892-2512
Email: vortex@polycom.com

Before contacting us, please review the warranty and repair policy on page 55.

TECHNICAL SPECIFICATIONS

MECHANICAL SPECIFICATIONS

Dimensions	19" (483 mm) W x 9.6" (244 mm) L x 1.75" (45 mm) H (full rack unit)
Weight	4 lb. (1.8 kg) dry 5.5 lb. (2.5 kg) shipping
Connectors	Audio: Mini (3.5mm) quick connect terminal blocks RS-232: DB9F EF Bus In/Out: RJ45 Phone In/Out: RJ11 Control/Status: DB25F

ELECTRICAL SPECIFICATIONS

Power	110 - 240 VAC; 47-63 Hz
Power Consumption	30 W
Phantom Power	24 V, software selectable

AUDIO I/O

Microphone Input Level	-30 dBu to 0 dBu/-66 dBu to -33 dBu, nominal; software selectable
Line Input Level	-20 dBu to 0 dBu, nominal; software selectable
Line Output Level	-20 dBu to 0 dBu, nominal; software selectable
Input Impedance	>10 kOhms
Output Impedance	50 Ohms (drives 600 Ohms)
Headroom	20 dB, nominal
Loudspeaker Output, Power Amplifier	10 W, 4-16 Ohms

PERFORMANCE SPECIFICATIONS

Frequency Response	20 Hz to 22 kHz
Acoustic Echo Cancellation Span	270 ms
Total Cancellation of AEC	> 65 dB
Convergence Rate of AEC	40 dB/second
Line Echo Cancellation Span	32 ms
Total Cancellation of LEC	> 65 dB
Convergence Rate of LEC	40 dB/second
Noise Cancellation	0 dB to 15 dB, software selectable

Control Inputs	Contact closure
Status Outputs	5V, 20 mA each

COMPLIANCE

The Vortex EF2241 complies with the ITU G.167 Recommendation for AEC, FCC part 15, and CE requirements.

USA and Canada

This device complies with part 15 of the FCC Rules. Operation is subject to the following two conditions:

1. This device may not cause harmful interference, and
2. This device must accept any interference received, including interference that may cause undesired operation.

NOTE

This equipment has been tested and found to comply with the limits for a Class A digital device, pursuant to part 15 of the FCC Rules. These limits are designed to provide reasonable protection against harmful interference when the equipment is operated in a commercial environment. This equipment generates, uses, and can radiate radio frequency energy and, if not installed and used in accordance with the instruction manual, may cause harmful interference to radio communications. Operation of this equipment in a residential area is likely to cause harmful interference in which case the user will be required to correct the interference at his own expense.

In accordance with part 15 of the FCC rules, the user is cautioned that any changes or modifications not expressly approved by Polycom Inc. could void the user's authority to operate the equipment.

This Class [A] digital apparatus complies with Canadian ICES-003.

Cet appareil numérique de la classe [A] est conforme à la norme NMB-003 du Canada.

US Telco requirements

This equipment complies with part 68 of the FCC Rules. Please refer to the labeling on equipment for the following information:

- Registration Number
- Ringer Equivalence
- Grantee's Name
- Model Number
- Serial Number and/or Date of Manufacture
- Country of Origin

If requested this information must be provided to the telephone company

Notes

- *This registered equipment may not be used with party lines or coin lines.*
- *If trouble is experienced the customer shall disconnect the registered equipment from the telephone line to determine if the registered equipment is malfunctioning and that if the registered equipment is malfunctioning, the use of such equipment shall be discontinued until the problem has been corrected.*

- *If, in the unlikely event that this equipment causes harm to the network, the telephone company will notify you in advance that temporary discontinuance of service may be required. But if advance notice isn't practical, the telephone company will notify you as soon as possible. Also, you will be advised of your right to file a complaint with the FCC if you believe it necessary.*
- *The telephone company may make changes to its facilities, equipment, operations or procedures that could affect the operation of the equipment. If this happens the telephone company will provide advance notice so you can make the necessary modifications to maintain uninterrupted service.*

REN

The REN is used to determine the quantity of devices that may be connected to the telephone line. Excessive REN's on the telephone line may result in the devices not ringing in response to an incoming call. Typically the sum of REN's should not exceed five (5.0). To be certain of the number of devices that may be connected to a line (as determined by the total REN's) contact the local telephone company.

Automatic Dialing

WHEN PROGRAMMING EMERGENCY NUMBERS AND/OR MAKING TEST CALLS TO EMERGENCY NUMBERS

1. Remain on the line and briefly explain to the dispatcher the reason for the call.
2. Perform such activities in the off-peak hours, such as early morning or late evening.

Telco Connector

A FCC compliant telephone cord and modular plug is provided with this equipment. This equipment is designed to be connected to the telephone network or premises wiring using a compatible modular jack that is Part 68 complaint. See the rest of these installation instructions for details.

Canadian Telco Requirements

NOTICE: The Industry Canada label identifies certified equipment. This certification means that the equipment meets telecommunications network protective, operational and safety requirements as prescribed in the appropriate Terminal Equipment Technical Requirements document(s). The Department does not guarantee the equipment will operate to the user's satisfaction.

Before installing this equipment, users should ensure that it is permissible to be connected to the facilities of the local telecommunications company. The equipment must also be installed using an acceptable method of connection. The customer should be aware that compliance with the above conditions may not prevent degradation of service in some situations. Repairs to certified equipment should be coordinated by a representative designated by the supplier. Any repairs or alterations made by the user to this equipment, or equipment malfunctions, may give the telecommunications company cause to request the user to disconnect the equipment.

Users should ensure for their own protection that the electrical ground connections of the power utility, telephone lines and internal metallic water pipe system, if present, are connected together. This precaution may be particularly important in rural areas.

Caution: Users should not attempt to make such connections themselves, but should contact the appropriate electric inspection authority, or electrician, as appropriate.

NOTICE: The **Ringer Equivalence Number** (REN) assigned to each relevant terminal device provides an indication of the maximum number of terminals allowed to be connected to a telephone interface. The termination on an interface may consist of any combination of devices subject only to the requirement that the sum of the Ringer Equivalence Numbers of all the devices does not exceed 5.

NOTE *The term "IC:" before the certification/registration number only signifies that the Industry Canada technical specifications were met.*

Australia

Mains powered POT's Voice Telephony without Emergency 000 dialing

Warning

This equipment will be inoperable when
mains power fails

この装置は、情報処理装置等電波障害自主規制協議会（VCCI）の基準に基づくクラスA情報技術装置です。この装置を家庭環境で使用すると電波妨害を引き起こすことがあります。この場合には使用者が適切な対策を講ずるよう要求されることがあります。

Rest of World EMC CLASS A ITE

WARNING

This is a Class A product. In a domestic environment this product may cause radio interference in which case the user may be required to take adequate measures.

Installation Instructions*

Installation must be performed in accordance with all relevant national wiring rules.

L'Installation doit être exécutée conformément à tous les règlements nationaux applicable au filage électrique.

Plug acts as Disconnect Device*

The socket outlet to which this apparatus is connected must be installed near the equipment and must always be readily accessible

This page was intentionally left blank.

CE Mark R& TTE Directive

This EF2241 has been marked with the CE mark. This mark indicates compliance with EEC Directives 89/336/EEC, 73/23/EEC 1999/5/EC. A full copy of the Declaration of Conformity can be obtained from Polycom Ltd, 270 Bath Road, Slough, Berkshire, SL1 4DX, UK.

Declaration of Conformity:

Hereby, Polycom Ltd. declares that this EF2241 is in compliance with the essential requirements and other relevant provisions of Directive 1999/5/EC.

Konformitetserklæring:

Hermed erklærer Polycom Ltd., at indestående EF2241 er i overensstemmelse med de grundlæggende krav og de relevante punkter i direktiv 1999/5/EF.

Konformitätserklärung:

Hiermit erklart Polycom Ltd., dass der EF2241 die grundlegenden Anforderungen und sonstige maßgebliche Bestimmungen der Richtlinie 1999/5/EG erfüllt.

Δήλωση Συμμόρφωσης:

Δια του παρόντος, η εταιρεία Polycom Ltd. δηλώνει ότι η παρούσα συσκευή (δρομολογητής) EF2241 πληροί τις βασικές απαιτήσεις και άλλες βασικές προϋποθέσεις της Οδηγίας 1999/5/EK.

Vaatimustenmukaisuusvakuutus:

Polycom Ltd. vakuuttaa täten, että EF2241 on direktiivin 1999/5/EC keskeisten vaatimusten ja sen muiden tätä koskevien säännösten mukainen.

Déclaration de conformité :

Par la présente, Polycom Ltd. déclare que ce EF2241 est conforme aux conditions essentielles et à toute autre modalité pertinente de la Directive 1999/5/CE.

Dichiarazione di conformità:

Con la presente Polycom Ltd. dichiara che il EF2241 soddisfa i requisiti essenziali e le altre disposizioni pertinenti della direttiva 1999/5/CE.

Verklaring van overeenstemming:

Hierbij verklaart Polycom Ltd. dat diens EF2241 voldoet aan de basisvereisten en andere relevante voorwaarden van EG-richtlijn 1999/5/EG.

Declaração de Conformidade:

Através da presente, a Polycom Ltd. declara que este EF2241 se encontra em conformidade com os requisitos essenciais e outras disposições relevantes da Directiva 1999/5/CE.

Declaración de conformidad:

Por la presente declaración, Polycom Ltd. declara que este EF2241 cumple los requisitos esenciales y otras cláusulas importantes de la directiva 1999/5/CE.

Överensstämmelseförklaring:

Polycom Ltd. förklarar härmed att denna EF2241 överensstämmer med de väsentliga kraven och övriga relevanta stadganden i direktiv 1999/5/EG.

CONFERENCE SYSTEM DESIGN

Good audio or video conferencing is more than acoustic echo cancellation. Before installing the EF2241, you should consider how your whole conference system will work together. The goals of conference system design are the following:

- Transmit intelligible speech
- Reproduce received speech intelligibly
- Prevent echoes
- Interface properly with transmission equipment
- High quality program audio
- Intelligible sound reinforcement (if needed)

Noise and Reverberation

Intelligibility can be affected by noise and reverberation. Noise comes from various sources such as HVAC, computers, projectors, or traffic. Some ways to improve the Signal to Noise Ratio (SNR) in your system include placing microphones closer to the talkers, using electronic noise cancellation, and applying acoustical treatments. The EF2241 is a great way to reduce noise in your system and improve the SNR. Polycom's patent pending noise cancellation algorithm, included in the EF2241, removes up to 10 dB of ambient background noise and improves perceived quality as well as intelligibility.

Reverberation in a conference system can reduce intelligibility in a room. To reduce reverberation and increase intelligibility, use directional microphone and loudspeakers, place microphones closer to the talker, and use acoustical treatment.

Consider Room Gain

When planning your conferencing system, you should also consider the room gain that will occur as a result of your microphone and loudspeaker placement. Room gain refers to the relative level of the audio going to your amplifier (remote end speech or telephone speech) and the level of this audio being picked up by the microphone. We recommend a room gain of 0 dB or less for the best results. But for difficult acoustic environments, the EF2241, as well as any of the EF products, can handle up to 10 dB room gain, which means that it offers great flexibility in your conference system design.

To help you measure room gain, the EF2241 includes a room gain detector. You should check your room gain after you have set up the EF2241.

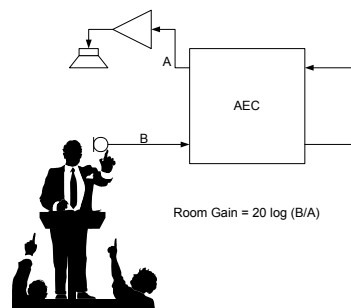
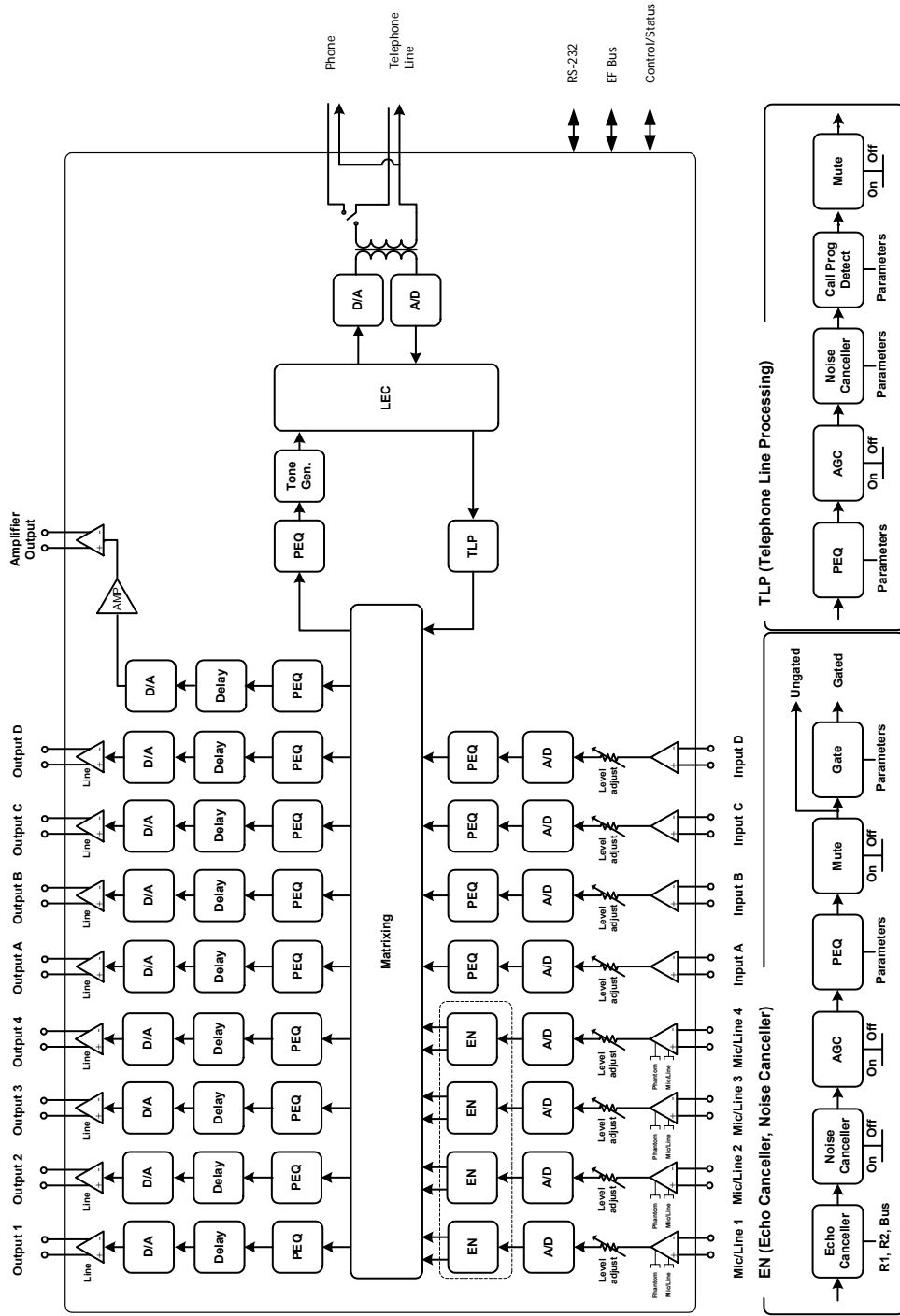

Figure 29. Room Gain.

EF2241 BLOCK DIAGRAM



Copyright (c) 2001, Polycom Inc. All Rights Reserved

Figure 30. Inside the EF2241

CONNECTOR PINOUTS

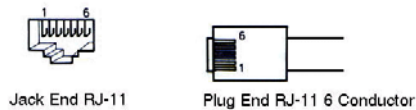
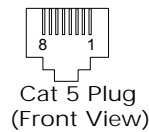
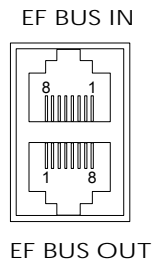

REMOTE CONTROL

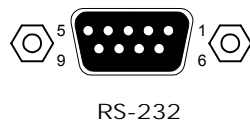

EF Bus

The EF Bus uses RJ45 connectors. These should be used with category five twisted-pair cable. The total distance of the EF Bus should be less than 4.5 m.

The EF Bus must be connected so that the EF Bus In of one box is connected to the EF Bus Out of another. Connecting the EF Bus In to another EF Bus In (or Out to Out) will not work.

Cat-5 Plug Pinout

- 1 - White/Orange
- 2 - Orange
- 3 - White/Green
- 4 - Blue
- 5 - White/Blue
- 6 - Green
- 7 - White/Brown
- 8 - Brown

RJ11 Plug Pinout

- 3 - Ring
- 4 - Tip

Note: Other pins are not connected. The DAA is not affected by Tip and Ring wiring reversal.

RS-232 Port (9600, 19200, 38400, 8-N-1)

The RS-232 port is wired as DCE. It accepts a male DB-9 connector. Only pins 2, 3, and 5 are required by the EF2241 but pins 7 and 8 are supported. Connect pins straight through (do not use null modem). 1 DCD; 2 TXD; 3 RXD 4 DSR; 5 ground; 6 DTR; 7 CTS; 8 RTS; 9 No connection

Baud rate is selectable at 9600, 19200, or 38400.

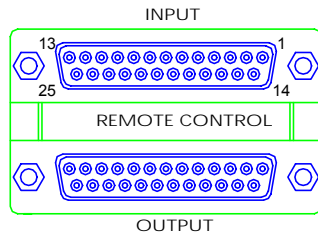

Input/Output Remote Control Port

Logic Input: Pins 1-24 are inputs 1-24, respectively. Pin 25 is ground.

Logic Output: Pins 1-20 are outputs 1-20, respectively. Pins 21-25 are ground. Each ground pin should be used with only 4 outputs. For example, outputs 1-4 could be connected to LEDs, which are connected to ground pin 1.

LEDs can be used without series resistors (we have provided series resistors in the circuitry). For best results, LEDs with $V_f=2.0$ V and $I_f=20$ mA should be used. Larger values may be used, but may result in dimmer LEDs. An LED with V_f less than 1.4 V should not be used without additional series resistance.

Power Supply Input

The power supply input accepts a 5-pin DIN male connector. Only use the power supply provided by Polycom. Use of other power supplies will void the warranty.

1 Ground; 2 Ground; 3 +5Vdc @ 3 A; 4 -15Vdc @ 0.3 A; 5 +15Vdc @ 1.2 A

+5, ±15 VDC

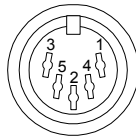

Mic/Line Inputs, Line Inputs, Line Outputs

These audio connectors accept a mini (3.5 mm) 3 conductor terminal block (provided). See Note below for manufacturer information.

From left to right the conductors are positive signal, negative signal, and shield ground.

Note *The information below lists manufacturer information for the Phoenix connector that is compatible with the parts we use:*

Manufacturer: Phoenix Contact
 Description: Mini-COMBICON 3-position plug, 3.5 mm pitch
 Type Number: MC 1,5/3-ST-3.5 or MC 1,5/3-ST-3,5
 Part Number: 1840379

CONNECTING UNBALANCED RCA TO BALANCED MINI PHOENIX

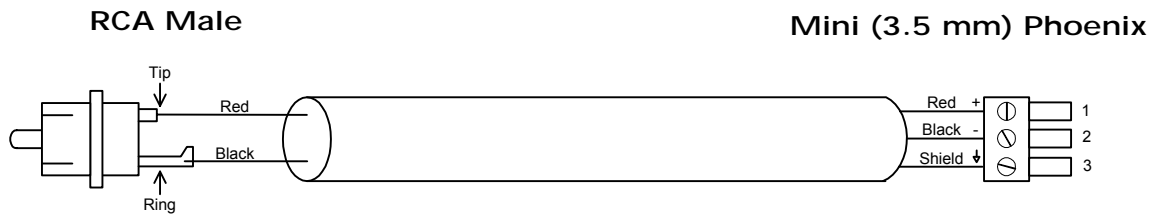

Figure 31. Cable construction for connecting unbalanced RCA to balanced mini Phoenix (3 conductor terminal block).

1. Connect RCA Tip to Phoenix pin 1.
2. Connect RCA Ring to Phoenix pin 2.
3. Connect Phoenix pin 3 to Shield, and leave Shield floating on RCA end.

Caution! Do NOT connect the shield at both ends.

Caution! On the EF2241, Phoenix pin 3 is connected to chassis ground. Under no circumstances should Phoenix pin 3 be connected to pin 1 or to pin 2. Doing so will add noise to the audio signal.

MAKING AN EF BUS TERMINATOR

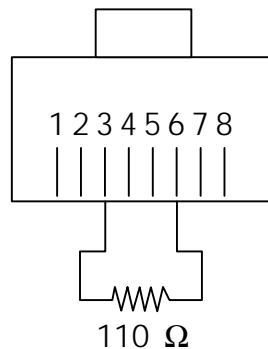

Figure 32. The terminator

Instructions

To make a terminator (for use when connecting EF2280s), use an RJ45 connector. Connect pin 3 to pin 6 with an 110 Ohm resistor. A terminator is not required for the EF2241 as it is built in.

ADDITIONAL NOTES

- Caution!** *Failure to use all four screws to attach the EF2241 to the rack may result in uneven loading and cause a safety hazard.*
- Caution!** *Ensure that the power supply is securely located such that it cannot become dislodged and fall. Such a fall could cause personal injury or equipment failure.*
- Caution!** *When mounting a EF2241 in a rack, consideration should be given to airflow and operating ambient temperatures inside the rack. To ensure safe operation of the EF2241, ambient operating temperatures inside the rack should not exceed 40 degrees Celsius. Allow 2 inches (51mm) of open space in front of the EF2241, 2 inches (51mm) on either side, and 4 inches (102 mm) behind the unit for proper ventilation. Equipment should not be installed in the rack in such a way as to interfere with the ventilation of the EF2241.*
- Caution!** *Consideration should be given to the connection of the equipment to the supply circuit and the effect that overloading of circuits could have an overcurrent protection and supply wiring. Appropriate consideration of equipment nameplate ratings should be used when addressing this concern.*
- Caution!** *Reliable earthing of rack-mounted equipment should be maintained. Particular attention should be given to supply connections other than direct connection to the Branch (use of power strips).*

WARRANTY INFORMATION

What is covered	Any defect in materials or workmanship.
For how long	Two years.
What we will do	<p>If your Vortex EF2241 product is defective and returned within two years of the date of purchase, we will repair or, at our option, replace it at no charge to you.</p> <p>If we repair your Vortex product, we may use new or reconditioned replacement parts. If we choose to replace your Vortex product, we may replace it with a new or reconditioned one of the same or similar design. The repair or replacement is warranted for either (a) 90 days or (b) the remainder of the original two-year warranty period, whichever is longer.</p>
Limitations	<p>Polycom shall not be responsible for special, incidental, indirect, or consequential damages resulting from any breach of warranty, or under any other legal theory, including but not limited to loss of profits, downtime, goodwill, damage to or replacement of equipment and property, and any cost of recovering, reprogramming, or reproducing any program or data stored in or used with Vortex products.</p> <p>Some states do not allow limitations on how long an implied warranty lasts, or the exclusion of incidental or consequential damages, so the above exclusions or limitations may not apply to you.</p>
What we ask you to do	<p>To obtain warranty service for your Vortex product, call us at (800) 932-2774 or fax us at (404) 892-2512 and we will issue a Return Material Authorization number (RMA#). Use the original packaging materials to return the product. Ship the product prepaid to:</p> <p style="padding-left: 40px;">Polycom Installed Voice Business Group Attention: Warranty Repair RMA# (<i>Must be on package</i>) 1720 Peachtree Street NW, Suite 220 Atlanta, Georgia 30309-2439 USA</p> <p>Please be sure to include your name, company, address, phone number, and a description of the problem. After repairing or replacing your Vortex product, we will ship it to you via a surface carrier of our choice at no cost to you. If you wish it shipped via a specific carrier at your cost, you must arrange it when you obtain the RMA#.</p> <p>Repair or replacement of your Vortex product is your exclusive remedy.</p>

What this warranty does not cover

This warranty does not cover defects resulting from accidents, damage while in transit to our service location, alterations, unauthorized repair, failure to follow instructions, misuse, fire, flood, lightning, acts of God, or use in those countries where such use violates Part 779 of the Export Administration Regulations of the United States Department of Commerce.

If your Vortex product is not covered by our warranty, call us at (800) 932-2774 or fax us at (404) 892-2512 for advice about whether we will repair your Vortex product and for other repair information, including charges. Polycom, at its sole discretion, may replace rather than repair your Vortex product with a new or reconditioned one of the same or similar design. The repair or replacement is warranted for 90 days.

The limited warranties and remedies set forth above are exclusive and in lieu of all other warranties, whether oral or written, express or implied. Polycom specifically disclaims any and all implied warranties, including, without limitation, the warranties of merchantability and fitness for a particular purpose.

No User Serviceable Parts

This product contains no user serviceable parts. Please contact Polycom Installed Voice Business Group for repairs. Attempts to repair this product by an unauthorized technician will void your warranty.

State Law Rights

This limited warranty gives you specific legal rights, and you may have other rights that may vary from state to state.

DEFINITION OF TERMS

Acoustic Echo	Acoustic echo occurs in a conferencing or distance learning system when the remote speech played in the loudspeakers is picked up by microphones in the room and is transmitted back to the remote end. This transmitted signal is a delayed version of the original, which causes the echo.
Acoustic Gain	Acoustic gain is a term used in conjunction with sound reinforcement. It refers to how much louder the audio is with sound reinforcement compared to without sound reinforcement.
Ambient Level	The ambient level, also referred to as noise floor, is the background noise heard in a room when no one on the near or remote end is talking.
Automatic Gain Control (AGC)	Automatic gain control increases or decreases the gain on an audio signal to an acceptable value.
Automatic Microphone Mixer	A microphone mixer that turns microphone channels on and off based on the signal level going into the microphone.
Convergence Rate	Convergence rate refers to the amount of echo a line or acoustic echo canceller can cancel per unit time, typically expressed in dB/sec. Better echo cancellers have a higher (faster) convergence rate. This term is typically used to quantify the time it takes to completely remove the echo from a conferencing system. Echo occurs due to a complete change of the acoustic environment such as the beginning of a phone call in a conference, a change of microphone-speaker placement, or speaker volume adjustment.
Crosspoint Mix Minus Bus	A mix minus bus allows each device (i.e., a Vortex device) to create a mix of signals without its own. Each device in the system can create four mixes (W, X, Y, and Z) and place them on the bus. Each device also can create three mixes each from the W, X, Y, and Z busses of the other devices (for a total of 12 mixes). One mix is hard-wired as a normal mix minus. That is, it is a unity gain mix of the signals from all other devices. The other two mixes can have crosspoint gains on the signals from the other devices.
Echo Canceller	An echo canceller estimates the echo in an audio signal by using a reference and pre-forms processing to eliminate the echo from the signal.

EF Bus	The EF Bus is a digital bus that includes the W, X, Y, and Z audio busses as well as the echo canceller reference and remote control information. It can be used to link multiple Vortex devices.
Equalization	Equalization is the process of adjusting frequency characteristics of an audio signal.
Line Echo	Line echo is caused by reflections of the audio signal from the telephone hybrid. The EF2241 is an example of a device that includes a line echo canceller.
Macros	An arbitrary set of commands that can be replayed.
Matrix Mixer	A matrix mixer allows you to choose which inputs are included in each output. Some matrix mixers allow you to assign crosspoint gains to the inputs.
Noise Cancellation	Noise cancellation is a digital signal process that removes noise from an audio signal corrupted by real-world interferences such as HVAC, office noise, crowd noise, or road noise. Generally, there are two parts of a noise cancellation algorithm: a method to detect the noise and a method to remove the noise. The Polycom noise cancellation algorithm (patent pending) is capable of removing 10 dB or higher of noise with no degradation at all to the resulting speech signal. This method does not attenuate speech, and removes noise during both speech and idle periods.
NOM	NOM refers to the number of open microphones in a system.
NOM Attenuation	NOM attenuation is the gain applied to the overall system gain to the microphone signals to compensate for how many microphones are open. The amount of attenuation is calculated by $10 \cdot \log_{10}(\text{NOM})$.
NOM Bus	A NOM bus carries signal information as well as NOM information (i.e., the number of open microphones in the system, NOM).
Presets	Presets correspond to configuration parameters that have been previously saved to EEPROM.
Room Gain	The room gain of a conferencing system refers to the relative levels of the signal sent to the line output to your amplifier (before any amplification) and the level of this signal that is reflected at the microphone input (after microphone amplification). If the electrical level of the reflected signal picked up by the microphone is the same as the level of the electrical signal sent from the AEC to the line output to your amplifier, the

room gain of this microphone channel is said to be 0 dB. If the reflected signal picked up by the microphone is higher than the level of the signal sent to the line output to your amplifier, that microphone channel has positive room gain. The more positive the room gain, the harder the AEC must work to determine which signal is an echo and which is a local speech signal.

INDEX

A

Acoustic Echo Cancellation, AEC	2, 12, 17, 30, 38, 40, 44, 49, 57
Automatic Gain Control (AGC)	4, 30, 57
Automixer, Adaptive Threshold	12, 21, 33
Automixer, Adaptive Threshold	37
Automixer, Automatic Microphone Mixer	2, 3, 19, 21, 31, 37, 57
Automixer, Camera Gating Threshold	20, 32
Automixer, Chairman Mic Mode	12, 20, 21, 33, 34, 37
Automixer, Decay Time	12, 20, 31, 32
Automixer, Gate Priority	12, 21, 34, 37
Automixer, Gating Mode	21, 33
Automixer, Global Max NOM	20, 33
Automixer, Hold Time	12, 20, 32, 37
Automixer, Last Mic On	12, 20, 33
Automixer, Local Max NOM	20, 33
Automixer, Manual Threshold	13, 21, 33, 37
Automixer, Off Attenuation	12, 20, 33
Automixer, Off Attenuation	21
Automixer, Threshold Type	21, 33

B

Bus Mixer	20, 22, 33
-----------------	------------

C

Calibration	15
Compliance	45
Conference Composer	5, 14, 15, 18, 19, 22, 25

D

Device ID	10, 12
Digital Bus	2, 4, 24, 58

E

Echo Cancellation	3, 30
EF Bus	5, 7, 10, 11, 17, 18, 20, 22, 23, 24, 25, 44, 51, 58
EF Bus Reference	25, 28
Equalization	58
Equalizer	3

F	
Factory Default Settings, Preset 0	11, 13, 15, 22
Front Panel Lock	28
G	
Ground	52
Ground, Chassis	53
Ground, Logic Input	52
Ground, Logic Output	52
Ground, Power Supply	52
Ground, RS-232	51
Grounding, Pin 1 Compatible	8
I	
Inputs	2, 3, 4, 6, 7, 8, 9, 15
L	
LCD Menu	3, 6, 15, 18, 26
Line Echo Cancellation, LEC	44
Line Echo Canceller, LEC	3, 58
Logic Input	7, 25, 52
Logic Output	7, 25, 52
M	
Matrix, Matrix Mixer	2, 3, 22, 34
Mic/Line Inputs, Line Inputs, Line Outputs	52
Mix Minus	24, 57
Multiple Vortex Devices	4, 10, 11, 13, 17, 21,
.....	22, 23, 25, 58
N	
Noise Cancellation	2, 3, 30, 44, 49, 58
NOM	24, 31, 58
NOM Attenuation	58
NOM Bus	25, 58
Non-volatile Memory Lock	28
O	
Outputs	31
P	
P Bus	3, 10, 17, 24
Parallel Remote Control	4, 7
Phantom Power	7, 15, 30, 44
Phoenix Connectors	5, 9, 52
Phone	2, 7, 10, 17, 18, 24, 44,

.....	58
Power Amplifier	2, 3, 7, 44
Power On Preset	13, 25
Presets	58
R	
Reference, AEC	3, 17–18, 24, 30, 57,58
Remote Control. See RS-232, Serial Remote Control or Parallel Remote Control.	
Reverberation	49
Room Gain	14, 39, 58
RS-232, Serial Remote Control	4, 5, 7, 10, 15, 24, 27,30, 44, 51
S	
Signal Generator	2, 3
Submatrix	2, 22, 24, 34
T	
Technical Support	43
Terminating the EF Bus, Terminators	11, 53
V	
Video Codec	18, 23

Polycom, Inc.
Installed Voice Business Group
1720 Peachtree Street NW, Suite 220
Atlanta, GA 30309-2439
Phone: (800) 932-2774, (404) 892-3200
Fax: (404) 892-2512
www.polycom.com

Technical Support:
(800) 932-2774
vortex@polycom.com

Polycom[®], Vortex[®], and the Polycom logo are registered trademarks of Polycom, Inc. in the United States and various countries. Copyright © 2002 Polycom, Inc. All rights reserved.

P/N 1725-80098-001 Rev C



Free Manuals Download Website

<http://myh66.com>

<http://usermanuals.us>

<http://www.somanuals.com>

<http://www.4manuals.cc>

<http://www.manual-lib.com>

<http://www.404manual.com>

<http://www.luxmanual.com>

<http://aubethermostatmanual.com>

Golf course search by state

<http://golfingnear.com>

Email search by domain

<http://emailbydomain.com>

Auto manuals search

<http://auto.somanuals.com>

TV manuals search

<http://tv.somanuals.com>