



Polycom® SoundPoint® IP 32x/33x User Guide

UC Software 4.0.0B | August 2011 | 1725-11241-001 Rev. G

Trademark Information

POLYCOM®, the Polycom “Triangles” logo and the names and marks associated with Polycom’s products are trademarks and/or service marks of Polycom, Inc. and are registered and/or common law marks in the United States and various other countries. All other trademarks are property of their respective owners. No portion hereof may be reproduced or transmitted in any form or by any means, for any purpose other than the recipient’s personal use, without the express written permission of Polycom.

Patent Information

The accompanying product is protected by one or more U.S. and foreign patents and/or pending patent applications held by Polycom, Inc.

Disclaimer

Some countries, states, or provinces do not allow the exclusion or limitation of implied warranties or the limitation of incidental or consequential damages for certain products supplied to consumers or the limitation of liability for personal injury, so the above limitations and exclusions may be limited in their application to you. When the implied warranties are not allowed to be excluded in their entirety, they will be limited to the duration of the applicable written warranty. This warranty gives you specific legal rights which may vary depending on local law.

Copyright Notice

Portions of the software contained in this product are:

Copyright © 1998, 1999, 2000 Thai Open Source Software Center Ltd. and Clark Cooper

Copyright © 1998 by the Massachusetts Institute of Technology

Copyright © 1998-2008 The OpenSSL Project

Copyright © 1995-1998 Eric Young (eay@cryptsoft.com). All rights reserved

Copyright © 1995-2002 Jean-Loup Gailly and Mark Adler

Copyright © 1996-2008, Daniel Stenberg, <daniel@haxx.se>

Permission is hereby granted, free of charge, to any person obtaining a copy of this software and associated documentation files (the “Software”), to deal in the Software without restriction, including without limitation the rights to use, copy, modify, merge, publish, distribute, sublicense, and/or sell copies of the Software, and to permit persons to whom the Software is furnished to do so, subject to the following conditions:

The above copyright notice and this permission notice shall be included in all copies or substantial portions of the Software.

THE SOFTWARE IS PROVIDED “AS IS”, WITHOUT WARRANTY OF ANY KIND, EXPRESS OR IMPLIED, INCLUDING BUT NOT LIMITED TO THE WARRANTIES OF MERCHANTABILITY, FITNESS FOR A PARTICULAR PURPOSE AND NONINFRINGEMENT. IN NO EVENT SHALL THE AUTHORS OR COPYRIGHT HOLDERS BE LIABLE FOR ANY CLAIM, DAMAGES OR OTHER LIABILITY, WHETHER IN AN ACTION OF CONTRACT, TORT OR OTHERWISE, ARISING FROM, OUT OF OR IN CONNECTION WITH THE SOFTWARE OR THE USE OR OTHER DEALINGS IN THE SOFTWARE.

© 2011 Polycom, Inc. All rights reserved. Polycom, Inc.

4750 Willow Road

Pleasanton, CA 94588-2708

USA

No part of this document may be reproduced or transmitted in any form or by any means, electronic or mechanical, for any purpose, without the express written permission of Polycom, Inc. Under the law, reproducing includes translating into another language or format.

As between the parties, Polycom, Inc., retains title to and ownership of all proprietary rights with respect to the software contained within its products. The software is protected by United States copyright laws and international treaty provision. Therefore, you must treat the software like any other copyrighted material (e.g., a book or sound recording).

Every effort has been made to ensure that the information in this manual is accurate. Polycom, Inc., is not responsible for printing or clerical errors. Information in this document is subject to change without notice.

Contents

Introduction	vii
About This Guide.....	vii
Who Should Read This Guide?	vii
How This Guide is Organized	vii
What's New in This Guide.....	viii
Conventions Used in This Guide	viii
Recommended References	x
Getting Help and Support	x
Customer Feedback	x
Chapter 1: Getting Started with Your Phone	1
Introducing Phone Components	2
Understanding the Phone Keypad	2
What Displays on the Screen?	4
<i>Phone Icons</i>	4
Navigating Menus, Lists, and Fields	5
Entering Data and Editing Fields	6
Registering the Phone	7
Troubleshooting Phone Issues	7
Using the Polycom Web Configuration Utility	8
Chapter 2: Using Your Phone	9
Calling and Answering.....	9
<i>Answering Calls</i>	10
Answering When Not in Another Call.....	10
Answering When in Another Call.....	11
Answering Calls When the Phone has Multiple Call Appearances	13
<i>Placing Calls</i>	13
Calling Using the Handset	14
Calling Using the Speakerphone	15
Calling Using a Headset.....	15
Calling Using the Dial Key.....	16
Calling from Directories	16
Calling by Speed Dialing	16
<i>Ending Calls</i>	16
<i>Using a Headset</i>	17
Enabling Headset Memory Mode	17
Using Electronic Hookswitch.....	18

While Your Phone Rings	18
<i>Ignoring Incoming Calls</i>	19
<i>Rejecting Incoming Calls</i>	19
During Calls	20
<i>Alternating Between Handset, Headset, and Speakerphone</i>	20
<i>Holding and Resuming Calls</i>	20
Handling Multiple Calls on Hold.....	21
<i>Transferring Calls</i>	21
Performing a Consultative Transfer	21
Performing a Blind Transfer	22
<i>Setting Up Conferences</i>	23
Hosting Conference Calls	23
Splitting Conference Calls	24
Holding and Resuming Conference Calls	24
Ending Conference Calls.....	24
Changing the Way Calls Are Answered	25
<i>Forwarding All Calls to Another Party</i>	25
<i>Rejecting Calls from a Contact</i>	26
<i>Diverting Calls from a Contact to Another Party</i>	27
<i>Temporarily Refusing All Calls (Do Not Disturb)</i>	27
Multiple Lines and Do Not Disturb.....	28
Working with Call Lists	28
<i>Managing Call Lists</i>	29
Working with Your Contact Directory.....	30
<i>Searching Your Contact Directory</i>	30
<i>Adding Contacts to Your Contact Directory</i>	30
Adding Contacts Manually	31
Adding Contacts from Call Lists.....	32
<i>Updating Your Contact Directory</i>	33
<i>Deleting Contacts from Your Contact Directory</i>	34
Working with Your Corporate Directory	35
<i>Searching Your Corporate Directory</i>	35
<i>Adding Corporate Directory Contacts to Your Contact Directory</i>	36
Controlling What is Heard.....	37
<i>Changing the Ring Tone</i>	37
Changing the Ring Tone for Your Phone.....	37
Setting Ring Tones for Contacts.....	38
<i>Changing the Speaker Volume</i>	38
<i>Changing the Ringer Volume</i>	38
<i>Muting the Microphone</i>	38
<i>Choosing Where You Hear Sound Effects</i>	38
Managing Speed Dials	39

<i>Assigning Speed Dial Indexes</i>	40
Accessing Voicemail	41
Working with Multiple and Shared Lines	42
<i>Supporting Multiple Lines</i>	42
<i>Supporting Multiple Line Keys Per Line</i>	42
<i>Supporting Multiple Call Appearances</i>	42
<i>Supporting Shared Lines</i>	43
Locking and Unlocking Your Phone	44
<i>About Your User Password</i>	45
<i>Locking and Unlocking Your Phone</i>	45
<i>Calling and Answering from a Locked Phone</i>	46
Logging Into Phones	47
<i>Logging In and Out of a Phone</i>	48
<i>Placing Calls from Phones that are in the Logged Out State</i>	50
<i>Changing Your User Password</i>	50
Chapter 3: Using the Advanced Features of Your Phone	53
SIP-B Automatic Call Distribution	53
<i>Logging Into and Out of ACD</i>	54
<i>Setting ACD Agent Availability</i>	54
Using Buddy Lists	55
<i>Updating Your Presence Settings</i>	55
<i>Managing Buddies</i>	55
Updating Your Buddy List	55
Blocking and Unblocking Your Buddies	56
<i>Integrating With Microsoft Live Communications Server 2005</i>	56
Broadcasting Messages Using Push-to-Talk and Group Paging	58
<i>Push-to-Talk Mode</i>	58
Sending and Receiving PTT Broadcasts	58
Sending PTT Broadcasts	59
Receiving PTT Broadcasts	60
Receiving PTT Broadcasts When You're Not in an Active Call	60
Receiving PTT Broadcasts During Active Calls	60
Replying to PTT Broadcasts	61
Ending PTT Broadcasts	61
Adjusting the Volume of PTT Broadcasts	61
Changing Where Broadcasts are Played	61
Updating the Default Channel	62
Updating Channel Subscriptions	62
Allowing PTT Broadcasts to Play During Active Calls	62
<i>Group Paging Mode</i>	63
Sending and Receiving Pages	63

Receiving Pages	64
Receiving Pages When You're Not in an Active Call	64
Receiving Pages During Active Calls	65
Adjusting the Volume of Pages	65
Changing Where Pages are Played	65
Updating the Default Paging Group	65
Updating Paging Group Subscriptions	66
Allowing Pages to Play During Active Calls	66
Updating Your Phone's Configuration	67
Restarting Your Phone	67
Chapter 4: Customizing Your Phone	69
Changing the Time and Date Display	69
Changing the Backlight	70
<i>Changing the Backlight Brightness</i>	<i>70</i>
<i>Changing the Backlight Timeout</i>	<i>71</i>
Changing the Language	72
Saving the Contact Directory Search Filter	72
Chapter 5: Troubleshooting Your Phone	75
Power and Startup Issues	75
Controls	76
Access to Screen and Systems	76
Calling	77
Display	78
Audio Issues	79
Productivity Suite	79
Testing Phone Hardware	79
Chapter 6: Polycom UC Software Menu System	81
Safety Notices	85
End-User License Agreement for Polycom® Software	88

Introduction

About This Guide

The Polycom® SoundPoint® IP 32x/33x User Guide provides instructions for using your SoundPoint IP 32x/33x phone. It will help you understand the phone's features and help you perform the following tasks:

- Basic tasks like placing and answering calls.
- Advanced tasks like using buddy lists and locking your phone.
- Troubleshoot common phone issues.

Who Should Read This Guide?

Phone users should read this guide to learn how to their SoundPoint IP 32x/33x phone. System administrators should read this guide to learn about the SoundPoint IP 32x/33x phone-specific features.

This guide describes user-level tasks.

How This Guide is Organized

This guide is organized into five chapters as follows:

- Chapter 1, "Getting Started with Your Phone", introduces the SoundPoint IP 32x/33x phone, running the latest Polycom UC Software.
- In Chapter 2, "Using Your Phone", you learn how to place and answering calls, hold and resume active calls, set up conference calls, and work with call lists, the contact directory, and the corporate directory. You also learn to manage speed dials and access voicemail.
- In Chapter 3, "Using the Advanced Features of Your Phone", you learn how to use buddy lists and broadcast messages, and how to update your phone's configuration.
- Chapter 4, "Customizing the Phone", provides instructions on how to make basic changes to the phone's display.
- Chapter 5, "Troubleshooting Your Phone", explains error messages and what to do if you have issues with your phone.









What's New in This Guide

The content in this guide has been reworked to make it more accessible and to provide more information to end users who are new to using the SoundPoint IP 32x/33x phone.

Conventions Used in This Guide

The following icons are used in this guide:

Table 1: Icons in this Guide

Name	Icon	Description
Note		The <i>Note</i> icon highlights information of interest or important information needed to be successful in accomplishing a procedure or to understand a concept.
Administrator Tip		The <i>Administrator Tip</i> icon highlights techniques, shortcuts, or productivity related tips.
Caution		The <i>Caution</i> icon highlights information you need to know to avoid a hazard that could potentially impact device performance, application functionality, or successful feature configuration.
Warning		The <i>Warning</i> icon highlights an action you must perform (or avoid) to prevent issues that may cause you to lose information or your configuration setup, and/or affect phone or network performance.
Web Info		The <i>Web Info</i> icon highlights supplementary information available online such as documents or downloads on support.polycom.com or other locations.
Timesaver		The <i>Timesaver</i> icon highlights a faster or alternative method for accomplishing a method or operation.
Power Tip		The <i>Power Tip</i> icon highlights faster, alternative procedures for advanced administrators already familiar with the techniques being discussed.
Troubleshooting		The <i>Troubleshooting</i> icon highlights information that may help you solve a relevant problem or to refer you to other relevant troubleshooting resources.

<i>Name</i>	<i>Icon</i>	<i>Description</i>
Settings		The <i>Settings</i> icon highlights settings you may need to choose for a specific behavior, to enable a specific feature, or to access customization options.

The following typographic conventions are used in this guide:

Table 2: Typographic Conventions

<i>Convention</i>	<i>Description</i>
Bold	Highlights interface items such as menus, soft keys, file names, and directories. Also used to represent menu selections and text entry to the phone.
<i>Italics</i>	Used to emphasize text, to show example values or inputs, and to show titles of reference documents available from the Polycom Support web site and other reference sites.
Blue	Used for cross-references to other sections, chapters, or parts in this document.
Underlined Blue	Used for URL links to external web pages or documents. If you click on text in this style, you will be linked to an external document or web page.
<code>Fixed-width-font</code>	Used for code fragments and parameter names.

The following writing conventions are used in this guide:

Table 3: Writing Conventions

<i>Convention</i>	<i>Description</i>
<MACaddress>	Indicates that you must enter information specific to your installation, phone, or network. For example, when you see <MACaddress>, enter your phone's 12-digit MAC address. If you see <installed-directory>, enter the path to your installation directory.
>	Indicates that you need to select an item from a menu. For example, Settings > Basic indicates that you need to select Basic from the Settings menu.

In this guide, SoundPoint IP 32x/33x refers to the SoundPoint IP 321, 331, and 335 phones.

Recommended References

You can find all referenced Technical Notifications on the Polycom Support Web site at http://support.polycom.com/PolycomService/support/us/support/voice/soundpoint_ip/VoIP_Technical_Bulletins_pub.html

You can find all Polycom phone documentation on the Polycom Support Web site at <http://support.polycom.com/voice/>

For other references, look for the Web Info icon: 

Getting Help and Support

The following related documents for SoundPoint IP 32x/33x phones are available:

- Quick Start Guides, which describe how to assemble phone
- Quick User Guides, which describe the basic phone features
- User Guides, which describe both basic and advanced phone features
- Technical Notifications, which describe workarounds to existing issues and provide expanded descriptions and examples

Customer Feedback

We are constantly working to improve the quality of our documentation, and we would appreciate your feedback. Please send email to VoiceDocumentationFeedback@polycom.com.



For support or service, please contact your Polycom reseller or visit support.polycom.com for software downloads, product document, product licenses, troubleshooting tips, service requests, and more.

Polycom recommends that you record the phone model numbers, software (both the Updater and UC Software), and partner platform for future reference.

Phone models: _____

Updater version: _____

UC Software version: _____

Partner Platform: _____

Chapter 1: Getting Started with Your Phone

This chapter includes overview information that you may find helpful when you're just starting to learn about your Polycom® SoundPoint® IP 32x/33x desktop phone, or when you have experience, but you need a quick refresher.



Note: Phone Features Not Available

Certain phone settings are configurable by your system administrator and may not be available on your phone.

The SoundPoint IP 32x/33x provides a powerful, yet flexible IP communications solution, delivering excellent voice quality. The graphic display supplies content for call information, multiple languages, directory access, and system status. The SoundPoint IP 32x/33x supports advanced functionality, including multiple call and flexible line appearances, presence, custom ring tones, local conferencing, HTTPS secure provisioning, and Polycom's superb voice quality. The SoundPoint IP 335 uses Polycom® HD™ Voice technology.

Topics in this chapter include:

- [Introducing Phone Components](#)
- [Understanding the Phone Keypad](#)
- [What Displays on the Screen?](#)
- [Navigating Menus, Lists, and Fields](#)
- [Entering Data and Editing Fields](#)
- [Registering the Phone](#)
- [Troubleshooting Phone Issues](#)
- [Using the Polycom Web Configuration Utility](#)

To customize your phone, see [Customizing Your Phone](#). To read about the phone's basic features, see [Using Your Phone](#). To read about the phone's advanced features, see [Using the Advanced Features of Your Phone](#).

If you require additional information or assistance with your new phone, contact your system administrator.

Introducing Phone Components

The following figure shows the phone's primary hardware features.

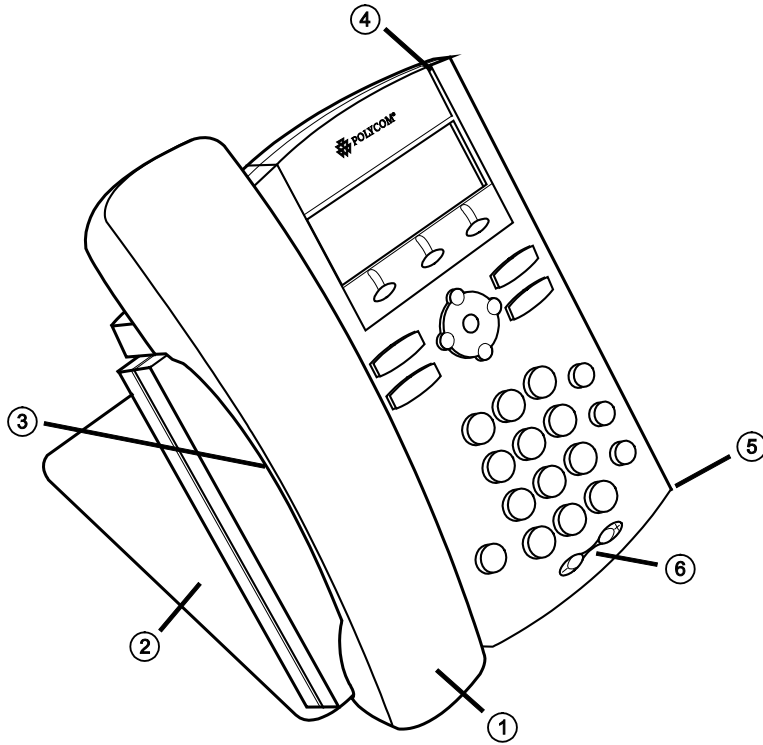

- 1 **Handset**—Provides audio output for calls that use the handset
- 2 **Deskmount**—Holds the phone at the appropriate level for use of the desk
- 3 **Speakerphone** (under Handset)—Provides ringer and handsfree audio output
- 4 **LED Indicator**—The LED flashes red to indicate the following:
 - The software is booting.
 - A message is waiting.
- 5 **Microphone**—Allows handsfree audio transmission during calls and conferences.
- 6 **Volume Keys** —Adjust the volume of the handset, headset, speaker, and ringer.

Understanding the Phone Keypad

The following figure shows the keys on the phone.

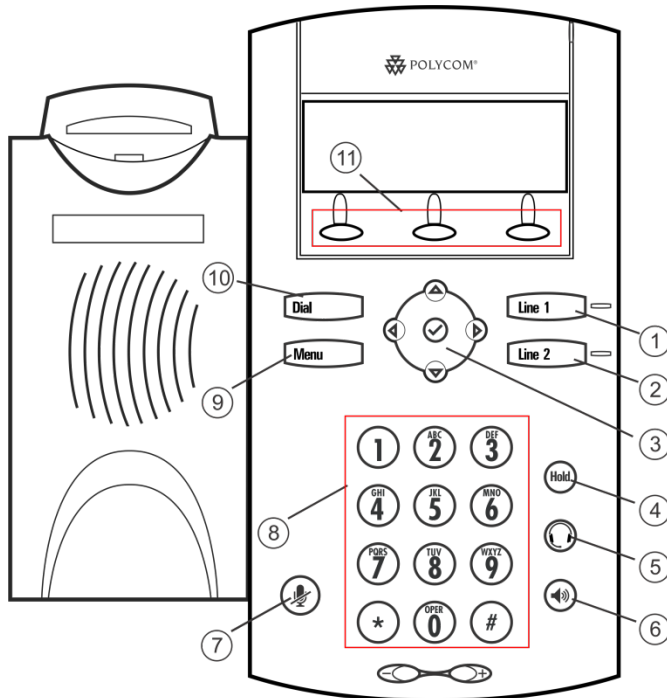

- 1 **Line Key 1**—Activate a line that can be assigned to your phone.
- 2 **Line Key** —Activate a line that can be assigned to your phone. This key cap can be switched with a Message key cap (included in shipping package).
Individual multi-color LEDs display the dynamic call state and remote user status (busy lamp field (BLF) and presence).
- 3 **Display Control Keys**—Use arrow keys to scroll through the displayed information. Use the **Select** key to select a field of displayed data or enter edit mode for some settings.
- 4 **Hold** —Holds an active call or resumes a held call.
- 5 **Headset** —Allows you to place and receive calls through an optionally connected headset.
- 6 **Speakerphone** —Allows for handsfree communication during calls.
- 7 **Microphone Mute** —Mutes local audio during calls.
- 8 **Dial Pad**—Provides the 10 digits, alphabetic characters, and special characters available in context-sensitive applications.
- 9 **Menu Key**—Access local and call server features.
- 10 **Dial Key**—Dials phone numbers or allows you to view the placed call list.
- 11 **Soft Keys**—The screen will display labels for these keys, to identify their context-sensitive functions.

What Displays on the Screen?





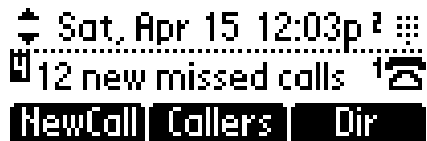
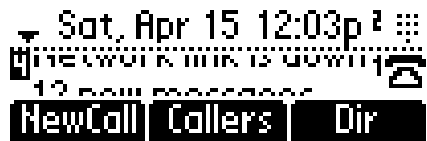
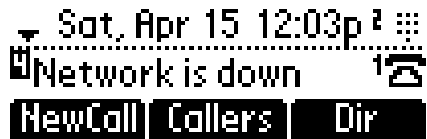



Your phone displays information about calls, messages, soft keys, time, date, and other relevant data.

Important messages appear on the idle screen through an animated scrolling list, which has precedence over the idle screen. The following figures show a phone with four messages. The messages continuously scroll over the screen.



Phone Icons

The following list describes the icons that display on the screen.

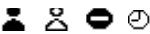
- 1 Registered line 
- 2 Registered shared line 
- 3 Unregistered line 
- 4 Voicemail/Messages 
- 5 Speed-Dial 
- 6 Ringing 
- 7 Call in progress/Conference 
- 8 Call Forward 
- 9 Do Not Disturb 
- 10 Presence/BLF 

Navigating Menus, Lists, and Fields

To navigate through menus and to enter data, you can:

- Press the **Menu** key to enter or exit any menu.
- Press the left arrow key repeatedly to exit any menu.
- Press the arrow keys to scroll through the lists.



Timesaver: Page Up and Page Down Shortcuts

Press the * key to page up. Press the # key to page down. These shortcuts can be used when lists appear on more than one page. However, these shortcuts do not work in the Contact Directory.

- Use the dial pad keys to navigate through and make selections in numbered menu lists.
- View the navigation guide icon in the top left-hand corner of the graphic display that shows which arrow keys can be used at a particular sublevel.

The following figure shows that the **Left** arrow, **Right** arrow, **Down** arrow, and **Select** keys can be used at this point.



Note: Automatically Exiting the Menu

After 40 seconds of inactivity, the menu system will also automatically exit to the idle screen unless an edit session is in progress.

- Press and hold (for one second) from the idle screen:
 - The **Line 2** Key to point to the contact where you can scroll through the individual fields.
 - The **Dial** Key to the Placed Calls list.

Pressing the **Dial** Key again will call the highlighted number.

Pressing the **Dial** Key while dialing will dial the current number.

Entering Data and Editing Fields

To enter text using the dial pad, press the number keys one or more times.

For example, for 'A' press '2' and for 'C' press '222'. The text that can be entered by a key is shown beneath the entry line. This is true for all languages that the phone can display. When in text entry mode, the title will show whether keys will generate numbers (1) or characters (a or A).

The type of text entry available is displayed in the title line as shown next.



Switch between alphabetic (with and without an uppercase letter first) and numeric text entry by pressing the # key. Special characters like * and _ are considered alphabetic and appear when you press *, 1, or 0.

Switch to uppercase by pressing the **Up** arrow key and to lowercase by pressing the **Down** arrow key.



Note: Entering URLs or IP addresses

Pressing # also allows for URL or IP address entry. These options are only available to system administrators in appropriate menu items. For example, when editing directory contacts use **Abc**, **abc**, or **123** and when editing server addresses use **URL**, **IP**, or **123**.



User Tip: Entering Special Characters

To enter the # character, use the * key to access the appropriate special character. # cannot be entered using its own key because it is used to change text entry modes.

Press the **Ok** soft key to save your changes. Press the **Cancel** soft key to clear your changes.

Press and hold the **Backspace** soft key to delete an entire field.



Note: All Capitals Not Supported

ABC mode is not supported on the SoundPoint IP 32x/33x phone. However, it is possible to enter an uppercase character by following these steps:

- 1 Select the abc or Abc soft key.
- 2 Enter the value in lower case.
- 3 While the letter is highlighted, press the arrow up key. It will convert to uppercase.

Registering the Phone

Generally, your phone will be deployed with multiple other phones. In this case, your system administrator will configure the phone parameters beforehand, so that after you set up your phone, the phone will be registered and ready to use.

If your phone is not part of a large phone deployment, your phone may not be registered after you set it up. Before you use your phone, you or your system administrator will have to register it.



Web Info: Registering Standalone Phones

For detailed information on how to register your phone after you install it, see [Quick Tip 44011: Register Standalone Polycom Phones](#).

Troubleshooting Phone Issues

If your phone is unable to operate or perform certain tasks, a warning icon will display.



Press the **Menu Key**, then select **Status > Diagnostics > Warnings**. You can press the **Details** soft key to obtain detailed information about the phone issue.

Press the **ClrIcon** soft key to remove the Warnings icon. If you clear the icon, you can still access the warnings from the list.

See [Troubleshooting Your Phone](#).

Using the Polycom Web Configuration Utility

You can update the phone's settings using the Polycom Web Configuration Utility.

The Web Configuration Utility enables you to view and configure phone behavior from a computer using any compatible Web browser. The utility provides a browser-friendly view of your phone's current settings. Using the utility, you can perform the same updates from your computer that you can perform using your phone's menu system.

You can access the utility using any compatible Web browser installed on a computer that is on the same network as your phone. Before you begin, you'll need to know the IP address of your phone, and the User Name and Password login credentials of the phone user or the phone administrator.



Web Info: Accessing, Navigating, and Using the Web Configuration Utility

For detailed information on accessing, navigating, and using the utility, see the Polycom Web Configuration Utility User Guide, available from the SoundPoint IP 32x/33x phone support page.

To access the Web Configuration Utility for your phone:

- 1 Launch the compatible Web browser from a computer on the same network as your phone. The supported browsers are:
 - Microsoft Internet Explorer (version 7.0 and higher)
 - Mozilla Firefox (version 3.0.X and higher)
 - Apple Safari (version 5 and higher)
 - Google Chrome
- 2 In the Address Bar of your Web Browser, enter the IP address of your phone.
The IP address is a set of four sets of numbers separated by periods. For example, if your phone's IP address is 123.22.3.4, enter 123.22.3.4 in the address bar.
- 3 Press the Enter key.
- 4 From the Web Configuration Utility login screen, select User, and then enter the User password.
The default password for a User is 123.
- 5 Click **Submit**.

The Web Configuration Utility Idle screen is displayed.

Chapter 2: Using Your Phone

Your Polycom® SoundPoint® IP 32x/33x phone is designed to be used like a regular phone on a public switched telephone network (PSTN). You can place calls, transfer a call to someone else, or conduct a conference call.

This chapter shows you how to use the basic features on your SoundPoint IP 32x/33x phone. The topics include:

- [Calling and Answering](#)
- [While Your Phone Rings](#)
- [During Calls](#)
- [Changing the Way Calls Are Answered](#)
- [Working with Call Lists](#)
- [Working with Your Contact Directory](#)
- [Working with Your Corporate Directory](#)
- [Controlling What is Heard](#)
- [Managing Speed Dials](#)
- [Accessing Voice Mail](#)
- [Working with Multiple and Shared Lines](#)
- [Locking and Unlocking Your Phone](#)
- [Logging Into Phones](#)

To read about the phone's basic features, see [Using the Advanced Features of Your Phone](#). To customize your phone, see [Customizing Your Phone](#).

If you require additional information or assistance with your new phone, contact your system administrator.

Calling and Answering

At any time, only one active call may be in progress on your phone. The active call is the one that has audio associated with it. There may be up to three other calls on hold or in an 'Incoming call' or 'Ringing' state on a particular line. Use the up and down arrow keys to switch between these calls. With two lines, there can be a maximum of eight calls or four conferences on your phone.

Calls are ordered using the following priorities: active, alerting, then held. Calls with the same priorities are ordered oldest first. If there are no current calls, this list is empty.

Your phone displays the active incoming call on the screen. You can access inactive calls (calls on hold, or incoming calls that you don't immediately answer) by pressing the right arrow key.

The following figure shows one active call and one on hold for Line 1.



Your phone distributes incoming calls for lines that have multiple Line Keys evenly across the two Line Keys.

To display and access the calls on another Line Key, press the appropriate Line Key. When you press the Line Key, the first call on hold in the inactive call group for that Line Key will automatically resume.

Line Keys have a status indicator that can be:

- Solid green—Indicating an active call is in progress.
- Fast flashing green—Indicating there is an Incoming (ringing) call.
- Flashing green—Indicating the call is held by the other party.
- Flashing red—Indicating the call is on hold.
- Solid red—Indicating the line is busy remotely (shared lines only).

This section provides the following instructions:

- [Answering Calls](#)
- [Placing Calls](#)
- [Ending Calls](#)
- [Using a Headset](#)

Answering Calls

By default, all incoming calls display on the screen. The Line Key status indicator associated with the call flashes green.



User Tip: Answering Calls While Your Phone is Locked

If your phone is locked, see [Locking and Unlocking Your Phone](#) for information on answering calls when your phone is locked.

Answering When Not in Another Call

When you're not in another call, you can answer a call in three ways:

- Using the handset
- Using the speakerphone
- Using the headset

In all cases, the active call displays on the screen showing call duration and destination.

If your phone is configured with multiple call appearances, see [Answering Calls When the Phone has Multiple Call Appearances](#).

To answer a call using the handset:

- Pick up the handset.

To answer a call using Handsfree Speakerphone mode:

- With the handset on-hook, do one of the following steps:
 - Press the **Speakerphone** Key.
 - Press the Line Key with the incoming call (where the line status indicator is flashing green).
 - Press the **Answer** soft key.

To answer a call using the headset:

- Press the **Handset** Key to answer the call through an optionally connected headset.

If Headset Memory Mode is activated, press the Line Key opposite the incoming call (where the line status indicator is flashing green) or the **Answer** soft key.

See [Using a Headset](#).

Answering When in Another Call

If you have an active call and an incoming call arrives (on the same or a different Line Key), the following happens:

- A call waiting tone beeps.
- If your phone is configured for a single Line Key per line:
 - The second call may cause a call waiting tone to beep and the second call appearance will display. The call waiting prompt identifying the incoming caller displays for 10 seconds. You can ignore, answer, or reject the call. (The **Reject** soft key on private lines only.)
 - After this point, the active call is in focus and you must scroll to the incoming call appearance to answer.

Tue, Feb 27 James... 12:36P 34161
 NewCall Callers Dir

- If your phone is configured for multiple Line Keys per line:
 - The second call will cause a call waiting tone to be played, the second Line Key indicator to fast flash green, and an incoming call icon displays. The call waiting prompt identifying the incoming caller appears for 10 seconds only. You can ignore, answer, or reject the call. (The **Reject** soft key on private lines only.)



- If your phone is configured for shared lines:
 - The second call will cause a call waiting tone to be played, the second Line Key indicator to fast flash green, and an incoming call icon appears on the second Line Key. The call waiting prompt identifying the incoming caller displays for 10 seconds.

To answer an incoming call on a line configured for a single Line Key:

- 1 Press the **Hold** key to place the original call on hold.
Soft key labels are updated on the display showing **Ignore**, **Answer**, and **Reject**.
- 2 Answer the incoming call.
The soft key labels are refreshed and the original call remains on hold.



Note: Using These Procedures

Use these procedures after the call prompt disappears. The call waiting prompt *interrupts* the active call for 10 seconds, where the incoming call can be immediately dealt with.

To answer an incoming call on a line configured for multiple Line Keys:

- Do one of the following steps:
 - Answer the call by pressing the Line Key associated with the incoming call.
The original call is put on hold and the incoming call is answered.
 - Press the **Hold** key to put the original call on hold.
Soft key labels are updated on the display showing **Ignore**, **Answer**, and **Reject**.
Answer the incoming call.
The soft key labels are refreshed and the original call remains on hold.

Answering a call on shared line is no different than on private line, except that there is no **Reject** soft key and another person on the shared line may answer the call.

Answering Calls When the Phone has Multiple Call Appearances

Each line on the phone can be configured to have one or more call appearances. More than one call appearances is useful if there is an active call and an incoming call arrives.

For example, the first figure shows Line 2 in a held call with Dean at extension 1703 and Line 1 has a call on hold.



The second figure shows Line 1 holding a call from Bob at extension 1701.

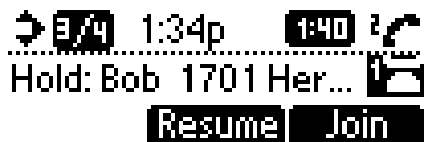

To answer an incoming call when configured for multiple call appearances:

- Do one of the following steps:
 - Press the **Hold** key to put the original call on hold and then answer the incoming call.

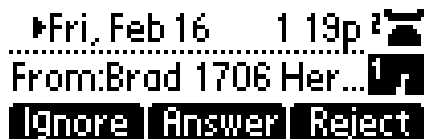

- Answer the incoming call during the Call Waiting prompt (first 10 seconds).
The soft key labels are updated with **Ignore**, **Answer**, and **Reject** soft keys.
- Wait for the Call Waiting prompt to disappear, use the **Down** arrow key to scroll to the incoming call, and then answer the incoming call.

This places the original call on hold and refreshes the soft key labels.

If two call appearances are in use, one will appear on the display and the total number will be indicated by a counter at the top right corner of the display. For example '1/2' indicates that the highlighted call is the first one out of a total of two.

Placing Calls

You can place a call in many ways using your phone:

- Using the handset
- Using the speakerphone
- Using the headset

- Using the **Dial** key
- Using one of the Line Keys

You can also dial the number first, and then choose the method you will use to speak to the other party.

To call a speed dial number, use the dial pad to enter the speed dial index followed by the # key, and then press the **Dial** key or pick up the handset to place a call.

You can search the local contact directory or the corporate directory and dial from the search results page.

During a call, you can alternate between Handset, Headset, or Handsfree Speakerphone by pressing the **Speakerphone** or **Headset** Keys, or picking up the handset.

Call duration on an active call is monitored through a local call timer. This is visible within the active call window on the graphic display. In the figure below, the call to James Dean has currently lasted 2 hours 48 minutes 23 seconds.



User Tip: Automatically Placing Calls After a Certain Number of Digits are Entered

Your system administrator sets up your phone to automatically place the call after you enter a certain number of digits. If your phone does not automatically place the call after you enter a phone number, press the **Dial** key.

If the call is placed before you enter all of the digits, contact your system administrator to (possibly) modify the dial plan associated with your phone.

Calling Using the Handset

To place a call using the handset:

- Do the following steps in any order:
 - Pick up the handset.

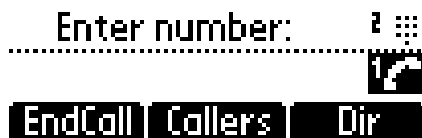

- Dial the desired number using the dial pad.



Note: URL or IP Dialing

URL or IP dialing is not supported on registered phones. If your phone is intentionally unregistered, the default dialing mode is by URL.

Calling Using the Speakerphone

To place a call using Handsfree Speakerphone mode:

- With the handset on-hook, do one of the following:
 - Press the Dial key, one of the Line Keys, the **Speakerphone** key, or the **NewCall** soft key.
Dial the desired number using the dial pad.
 - Dial the desired number using the dial pad.
Press the **Dial** key, one of the Line Keys, the **Speakerphone** key.



Note: Speakerphone Does Not Work

If your speakerphone doesn't work after you press the **Speakerphone** key, your system administrator has disabled the speakerphone on your phone. Handle calls using the handset or headset instead. If the system administrator disabled the speakerphone on your phone, 'Handsfree mode disabled' displays on the screen.

Calling Using a Headset

To place a call using a headset:

- Do one of the following:
 - With the optional headset connected, press the **Dial** key, one of the Line Keys, or the **NewCall** soft key.
Press the **Headset** key.
Dial the desired number using the dial pad.
 - With the optional headset connected, dial the desired number using the dial pad.
Press the **Headset** key.
 - Press the **Headset** key.
You will hear a dial tone. You can enter the desired number now.

See [Using a Headset](#).

Calling Using the Dial Key

To place a call using the Dial key:

- 1 Do one of the following steps:
 - Press the **Callers** soft key to view the Received Call list. You may need to press the **More** soft key first.
 - Press the **Dial** key to view the Placed Call list.
- 2 Use the up and down arrow keys to scroll through the list to find the contact you want to call.
- 3 Press the **Dial** key to complete the call.

Calling from Directories

To place a call from the local contact directory:

- 1 Press the **Dir** soft key.
- 2 Select the local contact directory if it does not appear automatically by pressing the **Select** key.
- 3 Search for the contact.
See [Searching Your Contact Directory](#).
- 4 Press the **Dial** key or lift the handset.

To place a call from the corporate directory:

- 1 Press the **Dir** soft key.
- 2 Select **Corporate Directory**.
- 3 Search for the contact.
See [Searching Your Corporate Directory](#).
- 4 Press the **Dial** key or lift the handset.

Calling by Speed Dialing

To call a speed dial number, use the dial pad to enter the speed dial index followed by the # key, and then press the **Dial** key or pick up the handset to place a call.

Ending Calls

To end a call:

- Do one of the following:
 - Press the **EndCall** soft key.
 - Replace the handset.

- If you're in handsfree speakerphone mode, press the **Speakerphone** key.
- If you're in headset mode, press the **Headset** key. See [Using a Headset](#).



Timesaver: Quickly Ending a Call

Your phone may be set up so that you can end calls by tapping the Line Key. If your system administrator has enabled this feature, you can end an active call by tapping the Line Key associated with the call.

Using a Headset

If you use a headset, you can set up your phone so that all calls use your headset. You can also use the hookswitch button on your headset to place, answer, and end calls.



Note: Using an RJ-9 Headset With Your Phone

If your headset has a RJ-9 modular connector, a separate Headset Jack Adapter (P/N 2457-11095-002) is required if you want to use it with SoundPoint IP 321 and 331 phones. To purchase the Headset Jack Adapter, contact your reseller.

Plug the headset RJ-9 jack into the adapter, and then plug the adapter into the 2.5mm port on the right side of the phone as shown below. The headset operates as before.



Troubleshooting: Dealing with Electrostatic Discharge

If headsets are deployed in high static environments where users frequently disconnect and re-connect the headset to the phone, it is possible that the phone can be damaged by electrostatic discharge (ESD).

You should take precautions to avoid excessive static buildup in your environment. This can include humidity control and removal of synthetic materials near the phone location. Antistatic spray applied to carpets in the workplace can reduce the level of static buildup.

Enabling Headset Memory Mode

This feature is especially useful for permanent or full-time headset users. You can set up your phone so that all incoming and outgoing calls use your headset. At any time, you can switch to handset or speakerphone mode.



Web Info: Supported Headsets

For a list of supported headsets, see [Technical Bulletin 37477: Polycom SoundPoint IP and VVX 1500 Headset Compatibility List](#).

To use Headset Memory Mode, enable, and then activate, Headset Memory Mode.

To enable Headset Memory Mode:

- 1 Press the **Menu** key.
- 2 Select **Settings > Basic > Preferences > Headset > Headset Memory**.



- 3 Select **Enabled** and press the **Select** key to enable Headset Memory mode.

Repeat steps 1 to 4 to select **Disabled** and turn Headset Memory Mode off.

To activate Headset Memory Mode:

- Press the **Speakerphone** key twice.

Pressing the Line Key or **Answer** soft key to receive a call will now connect to your headset automatically.

Using Electronic Hookswitch

If you use a headset that supports electronic hookswitch, you can place, answer, and end calls by pressing the hookswitch button on your headset.



Web Info: Detailed Informations on How to Use Electronic Hookswitch

For detailed information about how to use electronic hookswitch, see [Technical Bulletin 35150: Using an Electronic Hookswitch with Polycom SoundPoint IP and VVX 1500 Phones](#). To see a list of supported EHS headsets, see [Technical Bulletin 37477: Polycom SoundPoint IP and VVX 1500 Headset Compatibility List](#).

While Your Phone Rings

While your phone rings, you can do the following:

- Temporarily ignore the call before answering it. See [Ignoring or Silencing Incoming Calls](#).

- Terminate the call so you can't answer it. See [Rejecting Incoming Calls](#).

Ignoring Incoming Calls

Ignore a call to do the following:

- Minimize the incoming call window so it doesn't display on the screen.
- Stop your phone from ringing.

When you ignore a call, you stop your phone from ringing, but you can still answer the call (the call appearance still appears on the screen).

To ignore a call:

- While your phone rings, press the Ignore soft key (for private and shared lines).



User Tip: Answering a Call when Silent Ringing is Enabled

When your Polycom SoundPoint IP 32x/33x phone is configured for silent ring, press the incoming Line key or the **Answer** soft key to answer the call. If your handset is off-hook, the call is routed to the handset. If your handset is on-hook, the call is routed to the speaker.



Note: Using DTMF (touch tone) Signaling While You Have an Incoming Call

Dual-tone multi-frequency (DTMF) signaling is not available while a call is incoming. You may resume DTMF signaling by pressing the **Reject** soft key (for private lines) or the **Ignore** soft key (for private and shared lines). For more information, contact your system administrator.

Rejecting Incoming Calls

You can reject a call to stop your phone from ringing and end the call so you can't answer it. Rejected calls display in your Received Calls list. You cannot reject calls on shared lines.

To reject a call:

- While the phone rings, press the **Reject** soft key.

What the caller sees when you reject the call depends on how the system administrator has configured call rejection. By default, the caller will be asked to leave a voicemail.

During Calls

When you're in a call, you can do the following:

- Change the way you listen to calls. See [Alternating Between Handset, Headset, and Speakerphone](#).
- Place the call on hold. See [Holding and Resuming Calls](#).
- Transfer the call to another party. See [Transferring Calls](#).
- Set up a conference call with the call you're in and another party. See [Setting Up Conferences](#).

Alternating Between Handset, Headset, and Speakerphone

During a call, you can alternate between handset, headset, or speakerphone modes by picking up the handset, or pressing the Headset or Speakerphone key. For example, if you're using the handset, you can switch to headset mode by pressing the Headset key, or switch to speakerphone mode by pressing Speakerphone key.

Holding and Resuming Calls

To place a call on hold, press the **Hold** key. The held call is indicated on the screen by the hold icon as the line indicator (shown next).



Press the **Hold** key again or the **Resume** soft key to resume the call. The active audio icon (one of Handset, Headset, or Speakerphone) displays as the line indicator.

When a call has been on hold for an extended period of time, both visual and audible alerts appear. Contact your system administrator to determine if this feature is enabled/disabled, what the time period is, and what sound effects are available. When active on a call, the sound effects are played at a volume that is typically lower than the normal ringer volume.



User Tip: Muting Yourself During a Conference

Using the Hold feature generates music or a beeping tone; avoid placing a conference call on hold. If you're in a conference call and you don't want anyone to hear you, press the **Microphone Mute** key instead.

Handling Multiple Calls on Hold

If multiple calls are on hold, use the up and down arrow keys to switch between the calls, then press the **Resume** soft key to resume the desired call.

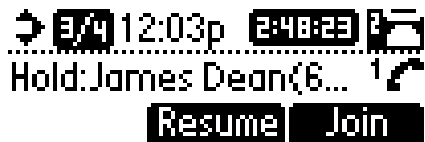

If two or more calls are on hold, an indication appears on the graphic display, for example '3/4', indicating that this is the third call out of four calls.

If calls are on hold on more than one Line Key, all calls are combined into a single call list. The Line Key that a call is associated with is indicated by the line icon in reverse colors. Pressing a Line Key with calls on hold will place the current active call on hold and resume the first call on that Line Key.

Transferring Calls

You can transfer a call in one of three ways:

- Consultative transfer—The party to whom you want to transfer the call answers their phone before you transfer the call or hang up. You can consult with them before completing the transfer.
See [Performing a Consultative Transfer](#).
- Blind transfer—The call is automatically transferred after you dial the number of the party to whom you want to transfer the call.
See [Performing a Blind Transfer](#).
- Attended transfer—The parties are automatically connected to each other after you exit the conference call.

Set up a conference call and then end your participation. For more information, see [Setting Up Conferences](#).

Performing a Consultative Transfer

Perform a consultative transfer if you want to talk to the party to whom you're transferring the call. Or, you can choose not to talk to the party. In this case, you wait for the party's ring-back sound, and then transfer the call.

To perform a consultative transfer:

- 1 During a call, press **Trans** soft key.
The active call is placed on hold.

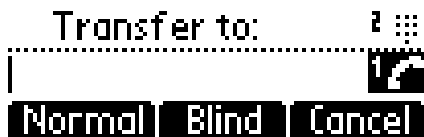

- 2 Do one of the following steps:
 - Enter the number to which you want to transfer the call. A normal (or consultative) transfer is assumed.
 - Press the **Normal** soft key to access the local contact directory, corporate directory, or received callers list. Then choose either the **Dir** or **Callers** soft key. Choose the number to which you want to transfer the call.
- 3 As soon as the ring-back sound is heard or after the party answers, press **Trans** soft key to complete the transfer.

You can talk privately to the party to which you are transferring the call before the transfer is completed.

If you are using a handset, you can complete the transfer by hanging up.

You can cancel the transfer before the call connects by pressing the **Cancel** soft key.

Performing a Blind Transfer

When you use a blind transfer, you transfer a call without speaking to the party to whom you're transferring the call. The call is automatically transferred as soon as you dial the party's number.

To perform a blind transfer:

- 1 During a call, press the **Trans** soft key.
- 2 Press the **Blind** soft key.

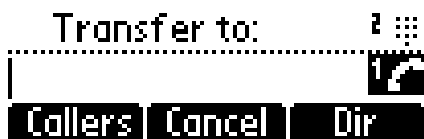

- 3 From the Blind Transfer to: screen, place a call to the party to whom you want to transfer the call. (See [Placing Calls](#).)
If you want to cancel the transfer (before the call is placed), and return to the original call, press the **Cancel** soft key.

The call automatically transfers to your specified party.

Setting Up Conferences

You can create a conference with other parties using the phone's local conference feature.

This section contains the following instructions:

- [Hosting Conference Calls](#)
- [Splitting Conference Calls](#)
- [Holding and Resuming Conference Calls](#)
- [Ending Conference Calls](#)

Hosting Conference Calls

You can set up a conference in one of two ways:

- Using the **Conf** soft key.
- Using the **Join** soft key, if you have an active call and one call on hold (on the same or another Line Key).

To set up a conference call using the Conf soft key:

- 1 Call the first party.



User Tip: Dialing a Phone Number

You can either dial the phone number directly or search for the number in the Contact Directory or Call Lists. For more information, see [Placing Calls](#), [Searching Your Contact Directory](#), or [Managing Call Lists](#).

- 2 Press **Conf** soft key to create a new call.

The active call is placed on hold.

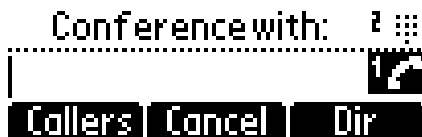

- 3 Call the second party.

- 4 When the second party answers, press the **Conf** soft key again to join all parties in the conference.



To set up a conference call using the Join soft key:

- When you are in an active call:
 - If you have one call on hold (on the same line or other line), use the down arrow key to go to the call on hold, then press the **Join** soft key.

A conference is created with the active call, the call on hold and yourself.
 - If you have more than one call on hold, use up and down arrow keys to switch to the desired call on hold, press the **Join** soft key.

A conference is created with the active call, the call on hold and yourself.

Splitting Conference Calls

When a conference is established, a **Split** soft key is available. When you split a conference, you end the conference and place all parties on hold. The **Split** soft key is available during conference calls, and when a conference call is on hold.

To split a conference call:

- Press the **Split** soft key to split the conference.

Both parties will be on hold.

Holding and Resuming Conference Calls

When you place a conference call on hold, you place all other conference participants on hold.

To place a conference call on hold:

- During a conference call, press the **Hold** soft key.

The other participants in the conference call are placed on hold.

To resume the conference call, press the **Resume** soft key.

Ending Conference Calls

You can end a conference, and your connection to the other participants, by pressing the **EndCall** soft key. By default, when you press the **EndCall** soft key, the other participants remain connected.



Timesaver: Quickly Ending a Conference Call

Your system administrator may have set up your phone so that you can end active calls by tapping the Line Key. If your phone is set up to do this, you can end an active conference call by pressing the Line Key associated with the conference call.

Your system administrator may have set up your phone so that when you press the **EndCall** soft key, all connections end.

To end a conference call:

- Press the **EndCall** soft key or hang up.
The other parties will continue to be connected.

Changing the Way Calls Are Answered

You can change the way calls are answered by doing the following:

- [Forwarding All Calls to Another Party](#)
- [Rejecting Calls from a Contact](#)
- [Diverting Calls from a Contact to Another Party](#)
- [Temporarily Refusing All Calls \(Do Not Disturb\)](#)

Forwarding All Calls to Another Party

You can configure your phone so that all incoming calls are forwarded to another party (known as static forwarding).

You can forward incoming calls to another party while Do Not Disturb is enabled on your phone.



Troubleshooting: I Cannot Forward a Call on a Shared Line

Call Forwarding is not available on shared lines.

This feature is local to the phone, and may be overridden by call server settings. For more information, contact your system administrator.

To enable call forwarding to another party:

- 1 Press the **Menu** key and select **Features > Forward**.



- 2 (Optional) If multiple lines are configured on your phone, select the line to forward from the list using the up and down arrow keys.
- 3 Using the **Up** and **Down** arrow keys, select the forwarding type you want to change and then press the **Select** key. The options are:
 - **Always**—Forward all incoming calls
 - **No Answer**—Forward incoming calls if not answered by a certain time
 - **Busy**—Forward when you are already in a call
- 4 Do one of the following:
 - If you select **Always**, enter a number to forward all future incoming calls to.
 - If you select **No Answer**, enter a number to forward all unanswered incoming calls to and how many rings to wait before forwarding (one ring is approximately six seconds). A value of 2 is recommended.
 - If you select **Busy**, enter a number to forward all future incoming calls to when you are in another call.
- 5 Select the **Enable** soft key to confirm call forwarding.

The idle screen returns with a moving arrow as the line label to confirm call forwarding is enabled.

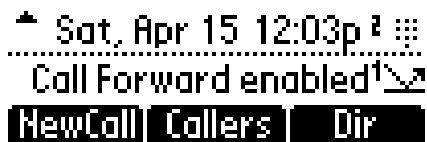

To disable call forwarding:

- 1 Press the **Menu** key and select **Features > Forward**.
- 2 (Optional) If multiple lines are configured on your phone, select the line to forward from the list using up and down arrow keys.
- 3 Using the up and down arrow keys, select the forwarding type you want to change and then press the **Select** soft key.
- 4 Press the **Disable** soft key to turn off call forwarding.

The idle screen returns and the regular icon display as the line indicator.

Rejecting Calls from a Contact

You can send all incoming calls from a particular contact to your voice and video mail system. (If you don't have one set up, the call will still ring on your phone.)



Troubleshooting: I Can't Reject Calls on a Shared Line

You can't reject calls on shared lines. You can only ignore them. For more information, see [Supporting Shared Lines](#).

To send incoming calls from a contact to your voicemail system:

- 1 Follow the instructions in [Updating Your Contact Directory](#).
- 2 Using the up and down arrow keys, scroll through the fields to find the Auto Reject field.
- 3 Press the **Edit** soft key.
- 4 Using the up and down arrow keys, select **Enabled**, then press the Ok soft key.
- 5 Press the left arrow key repeatedly to return to the idle screen.

Diverting Calls from a Contact to Another Party

You can transfer all incoming calls from a particular contact to a third party.

To divert incoming calls from a contact to a third party:

- 1 Follow the instructions in [Updating Your Contact Directory](#).
- 2 Using the up and down arrow keys, scroll through the fields to find the Divert Contact field.
- 3 Press the **Edit** soft key.
- 4 Enter the number of the party to whom you want to divert the call, then press the **Ok** soft key.
- 5 Using the up and down arrow keys, scroll through the fields to find the Auto Divert field.
- 6 Press the **Edit** soft key.
- 7 Using the up and down arrow keys, select **Enabled**, then press the **Ok** soft key.
- 8 Press the left arrow key repeatedly to return to the idle screen.

Temporarily Refusing All Calls (Do Not Disturb)

You can prevent the phone from ringing on incoming calls by pressing the **Menu** key, and then selecting **Features > Do Not Disturb**. A flashing icon and text on the graphic display indicates that Do Not Disturb is on.

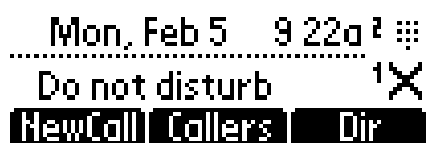

Calls received while Do Not Disturb is enabled are logged in the Missed Calls list unless configured to be forwarded to another party by your system administrator.

To disable Do Not Disturb, press the **Menu** key and then select **Features > Do Not Disturb** again.



Note: Enabling Do Not Disturb

This feature is local to the phone, and may be overridden by call server settings. For more information, contact your system administrator.

Enabling Do Not Disturb on shared lines disables ringing only. You will still see a visual notification of the call and have the option to answer the call.

Multiple Lines and Do Not Disturb

By default, the Do Not Disturb feature applies to all lines on your phone. Your system administrator can enable your phone so that you can enable Do Not Disturb on a line-by-line basis. When you enable Do Not Disturb for a particular line, a flashing 'X' displays beside the line indicator on the screen. You can still enable Do Not Disturb for all lines by enabling Do Not Disturb on all lines.

Working with Call Lists

Your phone maintains a list of all missed, answered, and placed calls. Missed and answered calls form a Received Calls list, and placed calls form a Placed Calls list. Each list can have up to 99 entries and displays the list title and first two calls in the list. Beside each entry in the Received Calls list, a symbol indicates whether the call was answered or missed.

Press the **Callers** soft key to view the Received Calls list (shown next).



Press the **Dial** key to view the Placed Calls list (shown next).





User Tip: Shortcuts to Call Lists

Press the right arrow key from the idle screen to access the Placed Calls list.
 Press the left arrow key from the idle screen to access the Received Calls list.
 Press the down arrow from the idle screen to access the Missed Calls list.
 You can use these shortcuts while placing calls or performing transferring and conferencing functions.

Managing Call Lists

From the Call Lists screen, you can choose the type of list to display. You can also clear entries in a call list, select an entry in a list and return the call, store the call details in your local Contact Directory, or view detailed information about the particular call.

To manage the listed calls:

- To get to the Call Lists screen:
 - Press the **Menu** key, then select **Features > Call Lists**. Select either **Received Calls** or **Placed Calls**.
- To return a call from a list:
 - Go to the appropriate entry, then press the **Dial** key.
- To store the contact to the local contact directory:
 - Go to the appropriate entry, press the **Select** key, and then press the **Save** soft key.



Note: Viewing Call Information

Press the **Info** soft key to see the call information. The name is displayed.
 Access the other information by using the **Up** and **Down** arrow keys.

- To delete a call from a list:
 - Go to the appropriate entry, then press the **Delete** soft key.



Note: Clearing Call Lists

When you restart the phone, call lists are automatically cleared. Or, you can manually clear the call lists through the Call Lists menu.

Working with Your Contact Directory

You can enter 99 contacts in your phone's local contact directory.

You can dial or search for a contact in this directory, or add, edit, and delete contacts.

You may have access to portions of your corporate directory through your phone. The contacts that you can see are determined by your system administrator. You can place calls to contacts in your corporate directory. You may be able to add contacts from the corporate directory to your local contact directory.

With your contact directory, you can:

- Dial contacts. See [Calling from Directories](#).
- Search for contacts. See [Searching Your Contact Directory](#).

If you can update your contact directory, you can also:

- Add contacts manually, from call lists, or from your Corporate Directory. See [Adding Contacts to Your Contact Directory](#).
- Update contact information. See [Updating Your Contact Directory](#).
- Delete contacts. See [Deleting Contacts from Your Contact Directory](#).

Searching Your Contact Directory

Search for a contact by scrolling through the directory, entering specific search criteria.

To search for a particular contact in the local contact directory:

- Press the **Dir** soft key.
- Select the local contact directory if it does not appear automatically by pressing the **Select** key.
- Search for a contact using the dial pad.

You can change the directory search parameter used. By default, it is the contact's last name. For more information, see [Saving the Contact Directory Search Filter](#).

The first time a dial pad key is pressed, the first entry whose last name starts with a character that matches the first letter on the key label will be retrieved. The second key press repeats the process using the second letter on the key and so on.

For example, to find a directory contact entry whose last name begins with J, press the 5 key twice. To find the first entry whose last name starts with R, press the 7 key three times.

Adding Contacts to Your Contact Directory

You can add contacts to your local Contact Directory in the following ways:

- Manually (if you have permission to update your local Contact Directory). See [Adding Contacts Manually](#).
- From a call list. See [Adding Contacts from Call Lists](#).

- From a Corporate Directory (if enabled). See [Adding Contacts to Your Contact Directory](#).

Adding Contacts Manually

You can add new entries to your contact directory manually.

To add a contact manually:

- 1 Press the **Dir** soft key.
- 2 Select your contact directory if it does not appear automatically by pressing the **Select** key.
- 3 Press the **Up** arrow key.

The Directory screen displays **<New Entry>** at the top of the list.



User Tip: Adding the First Contact

When adding the first contact, you do not need to press the **Up** arrow key.

- 4 Press the **Select** key to add a new entry.

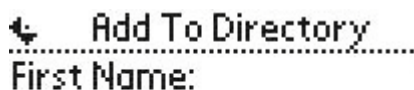

- 5 Press the **Select** key again to enter a first name.
Entry to this field is alphabetic as denoted by **Abc**.

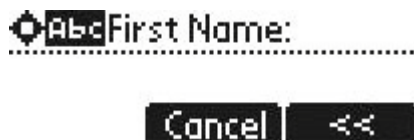

- 6 Enter the first name of the contact from the dial pad.



- 7 Press the **Ok** soft key to accept.
- 8 Press the **Down** arrow key to display the next field in the contact's entry.
- 9 Repeat steps 4 to 8 to enter the last name of the contact.
- 10 Repeat steps 4 to 8 to enter a contact number.
This is a required field and it must be unique (not already in the directory).
Entry to this field is number as denoted by **123**.

123 Contact:

Cancel <<

- 11 Repeat steps 4 to 8 to change the Speed Dial Index if desired.
It is automatically assigned to the next available index value.
For more information, see [Managing Speed Dials](#).
- 12 Repeat steps 4 to 8 to change any other fields if desired.
- 13 Press the **Left** arrow key to end the contact's data entry.

Confirmation
.....
Save Directory?
Cancel Resume Yes

- 14 Press the Yes **soft** key to accept changes.

Adding Contacts from Call Lists

You can save call information from a call list to your contact directory. The contact's first and last names (if available) and contact number are saved.

To add a contact from a call list:

- 1 Do one of the following steps:
 - o Press the **Callers** soft key to view the Received Calls list.
 - o Press the **Dial** key to view the Placed Calls list.
- 2 Use the **Up** and **Down** arrow keys to scroll through the list to find the contact.
- 3 Press the **Select** key to select the entry.

Placed Calls
.....
17 Bob Smith(5551234)
Delete Info Save

- 4 (Optional) Press the **Info** soft key.

The name is displayed. The number, time and date when the call started, and call duration are accessible using the **Down** arrow key.

⤵ Name:
.....
Bob Smith
Cancel

- 5 (Optional) Press the **Down** arrow key repeatedly to select the phone number.
- 6 Press the **Save** soft key to save the contact in the local contact directory.



User Tip: Verifying Contacts or Adding More Information

At this point, you may want to go to the contact directory and add missing fields.

Updating Your Contact Directory

You can update information for contacts in your contact directory.

To update a contact:

- 1 Press the **Dir** soft key.
- 2 Select your contact directory if it does not appear automatically by pressing the **Select** key.
- 3 Use the **Up** and **Down** arrow keys to scroll through the list to find the contact.
- 4 Press the **Select** key to select the entry.

⤵ Directory
.....
16 James Dean(612446...
Edit **New** **Delete**

- 5 Press the **Edit** soft key.

⤵ Edit Contact
.....
First Name:
James

- 6 Use the **Up** and **Down** arrow keys to scroll through the fields, then press the **Select** key to select the appropriate field.



- 7 Make the desired changes.

The **Ok** soft key is not displayed until a change has been made. The **Cancel** soft key in this context will cancel the edit session for the entry and return to the screen before the **Edit** soft key was selected (see step 3).

Press the left and right arrow keys to place the cursor either at the beginning or end of the item respectively. Press the **Down** arrow key to move to the next field.



- 8 Press the **Ok** soft key to accept changes.



Timesaver: Quickly Updating Contacts

You can also edit a contact associated with a speed dial key by pressing and holding that speed dial key and then following the steps 5 to 7 above.

Deleting Contacts from Your Contact Directory

You can delete contacts from your contact directory.

To delete a contact from the local contact directory:

- 1 Press the **Dir** soft key.
- 2 Select your contact directory if it does not appear automatically by pressing the **Select** key.
- 3 Use the **Up** and **Down** arrow keys to scroll through the list to find the contact.
- 4 Press the **Select** key to select the entry.



- 5 Press the **Delete** soft key.

The contact is deleted from the directory. The next entry in the directory displays.

Working with Your Corporate Directory

If your system administrator sets up your corporate directory on your phone, you may have read-only access to portions of your organization's Corporate Directory. You cannot update the contacts in your organization's Corporate Directory. Your system administrator determines which contacts you can see.

From Corporate Directory, you can do the following:

- Dial contacts. See [Calling from Directories](#).
- Search for contacts. See [Searching Your Corporate Directory](#).
- Add contacts to your local Contact Directory. See [Adding Corporate Directory Contacts to Your Contact Directory](#).

Searching Your Corporate Directory

When you access Corporate Directory, a search screen displays so you can search for a specific contact. You can perform a quick search or an advanced search.



User Tip: Saving Your Previous Corporate Directory Search Results

You can enable your phone to save Corporate Directory search results, and to remember the last person you viewed in the directory. Whenever you re-display Corporate Directory, the last person you viewed will display. If you searched for a person, the results of the last search you submitted will display. To enable this feature, press the **Menu** key, and then select **Settings > Basic > Preferences > Corporate Directory > View Persistency**. Select **Enabled**, press the **Select** soft key, and then press the **Menu** key to exit the menu.

To search for a particular contact in the corporate directory:

- 1 Press the **Dir** soft key.
- 2 Press the **Down** arrow key, then press the **Select** key to select the corporate directory.
- 3 Search for the contact in one of the following ways:
 - In the search line, enter the first few characters of the contacts's last name using the dial pad. For example, to search for James Woller, enter **wo** in the search line.

- Press the **Submit** soft key. In this example, James Woller appears in the search results.

```

⏪ Search:wo
Woller, James, 0445
Wong, Bob, 6044
    
```

- Press the **AdvFind** soft key, enter search values in the displayed fields. For example, enter **Smith** as the last name.

```

⏪ Advanced Find
.....
Last Name:
smith
    
```

- Press the **Submit** soft key. In this example, Bob Smith appears in the search results.

```

⏪ Corp Dir (Filtered)
.....
Smith, Bob, 61244244...
View Save Search
    
```

You can dial any successful matches from the resulting information on the phone's screen.

Adding Corporate Directory Contacts to Your Contact Directory

You can save any contact listed in your corporate directory to your contact directory. The contact's first and last names (if available) and contact number are saved.

To add a corporate directory contact to the contact directory:

- 1 Press the **Dir** soft key.
- 2 Press the **Down** arrow key, then press the **Select** key to select the corporate directory.
- 3 Search for the contact.

See [Searching Your Corporate Directory](#).

- 4 Press the **Select** key.

The contact's information appears on the phone's screen.

```

⏪ Corp Dir (Filtered)
.....
Dean, James, 61244244...
View Save Search
    
```

- 5 Press the **Save** soft key to save the contact in the local contact directory.

The 'Entry saved' message displays on the screen. Only the first name, last name, and phone number are saved.

If the contact already exists in the contact directory, the 'Entry already exists' message displays.

Controlling What is Heard

You can change what you hear by doing the following:

- [Changing the Ring Tone](#)
- [Changing the Speaker Volume](#)
- [Changing the Ringer Volume](#)
- [Muting the Microphone](#)
- [Choosing Where You Hear Sound Effects](#)

Changing the Ring Tone

You can select from the different ring types to distinguish between lines or to have a different ring from your neighbor's phone. You can set distinctive ring tones for contacts in your contact directory so you can identify callers when your phone rings.

Changing the Ring Tone for Your Phone

You can choose a distinctive ring tone for your phone to identify it when it rings. Or, you can choose distinctive ring tones for different lines.



Note: Using Silent Ring

If you configure your SoundPoint IP 32x/33x phone for silent ring, press the incoming Line key or the **Answer** soft key to answer the call. If your handset is off-hook, the call is routed to the handset. If your handset is on-hook, the call is routed to the speaker.

To change the incoming ring to a desired sound:

- 1 Press the **Menu** key.
- 2 Select **Settings > Basic > Ring Type**.
- 3 (Optional) If multiple lines are configured on your phone, select the line to change from the list using the **Up** and **Down** arrow keys.
- 4 Using the **Up** and **Down** arrow keys, select the desired ring type.

Press the **Play** soft key to hear the selected ring type.

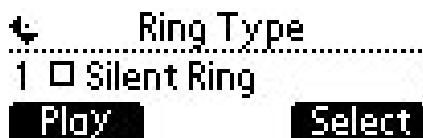

- 5 Press the **Select** soft key to change to the selected ring type.

Setting Ring Tones for Contacts

You can set a distinctive ring tone for each contact in your contact directory so you can distinguish callers.

To change the ring type field for a contact, see [Updating Your Contact Directory](#).

Changing the Speaker Volume

During a call, you can adjust the speaker volume by pressing the **Volume Up** or **Volume Down** keys.



Note: Preset Handset and Headset Volumes

To conform to regulatory requirements, handset and headset volume will return to a preset level after each call, but your system administrator can change this. Handsfree Speakerphone volume settings will be maintained across calls.

Changing the Ringer Volume

While you are not in a call, you can adjust the ringer volume by pressing the **Volume Up** or **Volume Down** keys.

Muting the Microphone

During a call, you can mute your microphone by pressing the **Microphone Mute** key. The Message Waiting Indicator LED turns red and a microphone displays on the screen, indicating that the other party (or parties) cannot hear you.

Microphone Mute applies to all modes: Handset, Headset, and Handsfree Speakerphone. You can still hear all other parties while mute is enabled.

To turn off Microphone Mute, press the **Microphone Mute** key again.

Choosing Where You Hear Sound Effects

You can choose whether you hear sound effects (all phone sounds except call audio) from the handset, headset, or speaker. For example, you can configure your phone to ring on your headset, instead of the speaker. By default, all sound effects are heard from the speaker.

To choose where you hear sound effects:

- 1 Press the **Menu** key, then select **Settings > Basic > Preferences > Audible Ringer**.
- 2 Press the **Select** key.
- 3 From the Audible Ringer screen, select where you want to hear sound effects:
 - To hear sound effects only from the phone's loudspeaker, select **Speaker**.
 - To hear sound effects only from the handset, select **Handset**.
 - To hear sound effects only from the headset, select **Headset**.
 - To hear sound effects only from the device you're currently using to hear call audio, select **Active**.

The default destination is **Speaker**.

Managing Speed Dials

You can associate a contact with the second line key for single touch dialing of a frequently used number.

For example in the figure below, pressing the second line key places a call to James.

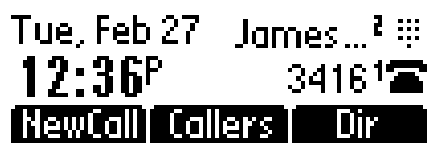

Note: Speed Dial Key on Screen

The contact with the lowest speed dial index will be associated with the **Line 2** key for single touch dialing.

You can also associate frequently used numbers with a speed dial index. To dial a contact associated with a speed dial index, enter the speed dial index followed by the # key using the dial pad, then press the Dial key or pick up the handset

You can access the Speed Dial list by pressing the **Menu** key and selecting **Features > Speed Dial** or by pressing the **Up** arrow key from the idle screen.

When a new entry is added to the Contact Directory, it is automatically assigned the next available speed dial index and the new entry appears at the bottom of the Speed Dial list.

Assigning Speed Dial Indexes

To add or edit a speed dial index for an existing contact:

- 1 Press the **Dir** soft key.
- 2 Use the **Up** and **Down** arrow keys to scroll through the list to find the contact.
- 3 Press the **Select** key to select the entry.



- 4 Press the **Edit** soft key.
- 5 Press the **Down** arrow key repeatedly until the speed dial index displays.
- 6 Press the **Select** key to select the speed dial index for edit.
- 7 Do one of the following steps:
 - Enter the next available speed dial index.
 - Delete the existing speed dial index by using the **Backspace** soft key, and then enter a new speed dial index.
- 8 Press the **Ok** soft key to accept changes.

To assign a new speed dial key:

- 1 Press and hold the second line key if unassigned.
A new empty entry in the contact directory is automatically opened allowing contact information to be added.
- 2 Press the **Select** key to enter a first name.
- 3 Enter the first name of the contact using the dial pad.
- 4 Press the **Ok** soft key to accept changes.
- 5 Press the **Down** arrow key to display the next field in the contact's entry.
- 6 Repeat steps 2 to 5 to enter the last name of the contact.
- 7 Repeat steps 2 to 5 to enter a contact number.
- 8 Repeat steps 2 to 5 to change the Speed Dial Index if desired.
The index can be any value between the next available index value and the maximum (99).



User Tip: Assigning Speed Dial Index Values

Polycom recommends that you assign speed dial index values consecutively. For example, the second Line Key is assigned to the speed dial index value "2".

- 9 Press the **Yes** soft key to accept changes.

Accessing Voicemail

Your voicemail is saved in a centralized location and may be accessed from your phone.

New Voicemail messages are indicated by a flashing red Message Waiting Indicator LED on the front of the phone and a visual notification on the phone's screen. If the phone is configured for multiple lines, an individual line indicator icon indicates Voice Mail messages left on that line.



A stutter dial tone indicates that one or more voice messages are waiting at the message center.



Note: Using Voicemail

Voicemail is an optional feature configured on the call server and may not be supported on your particular system. For more information, contact your system administrator.

Screen options may vary with your application. Voicemail may be accessible with a single key press. Contact your system administrator about this option.

To listen to voice messages:

- 1 Press the **Msgs** soft key or press the **Menu** key, select **Features > Messages**, and then press the **Select** key.



Timesaver: Quickly Accessing Voicemail

If your SoundPoint IP 32x/33x phone has a **Messages** key, press it to access your Voicemail.

- 2 Follow voice or visual prompts on the screen to retrieve your messages.

If multiple lines are configured on your phone, select the line you wish to retrieve your messages from.

Working with Multiple and Shared Lines

Your system administrator can customize your phone so that you have more than one Line Key or that your one line appears on two Line Keys. Your phone can also share a line with another phone.

Supporting Multiple Lines

Your SoundPoint IP 32x/33x phone can support up to 2 lines.

Typically, the top-most Line Key is reserved for the principal directory number (DN) of the phone.

Depending on how your phone is configured, the display could resemble one of the following figures:

```
Tue, Feb 27 James... 2 ☎
12:36P 3416 1 ☎
NewCall Callers Dir
```

```
Thu, Dec 21 3416 2 ☎
1 29P 3413 1 ☎
NewCall Callers Dir
```

Supporting Multiple Line Keys Per Line

Your system administrator can configure your phone to have more than one Line Key associated with it. This enhances call visualization and simplifies call handling. If this is the case, the display could resemble the following figure:

```
Thu, Dec 21 3416 2 ☎
1 29P 3416 1 ☎
NewCall Callers Dir
```

Incoming calls to this line will be distributed evenly among the available Line Keys. Similarly, outgoing calls will be distributed.

The SoundPoint IP 32x/33x combines the call appearances for multiple line keys into a single call list.

Supporting Multiple Call Appearances

Your system administrator can configured your phone to have one or more call appearances. More than one call appearances is useful if there is an active call and an incoming call arrives.

For example, the first figure shows Line 2 in a held call with Dean at extension 1703 and Line 1 has a call on hold.



The second figure shows Line 1 holding a call from Bob at extension 1701.

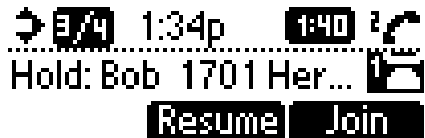

To answer an incoming call when configured for multiple call appearances:

- Do one of the following steps:
 - Press the **Hold** key to put the original call on hold and then answer the incoming call.

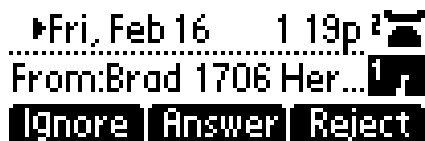

- Answer the incoming call during the Call Waiting prompt (first 10 seconds).
The phone's soft key labels are updated with **Ignore**, **Answer**, and **Reject**.
- Wait for the Call Waiting prompt to disappear, use the **Down** arrow key to scroll to the incoming call, and then answer the incoming call.

This places the original call on hold and refreshes the soft key labels.

If two or more call appearances are in use, one will appear on the display and the total number will be indicated by a counter at the top right corner of the display. For example "3/4" indicates that the highlighted call is the third one out of a total of four.

You can also place another outbound call on the same first line. Press the **Hold** key during the first call and press the **NewCall** soft key to obtain dial tone for a second call.

Supporting Shared Lines

Your SoundPoint IP 32x/33x phone supports shared lines. A shared line is indicated by a different line icon. In the following figure, the line 3413 is private and the line 3416 is shared.



If two phones share a line, an incoming call to that number will cause both phones to ring. The call can be answered on either phone but not both.

You can transfer, hold, or conference calls on shared lines.



Note: Using Shared Lines

Shared lines are an optional feature and may not be supported on your particular system. For more information, contact your system administrator.

Call Forwarding is not available on shared lines.

Do Not Disturb (DND) on shared lines disables the ringing option only, the call appearance still remains.

Locking and Unlocking Your Phone

Locking your phone enables you to do the following:

- Prevent unauthorized outgoing calls.
- Allow only authorized people to answer calls.
- Prevent people from viewing or modifying phone displays or information (for example, menus, directory lists, call records, and Speed Dial Keys).



Note: Phone Lock Features

Locking your phone is a feature that your system may not support. For more information, see your system administrator.

Your system administrator can set up your phone to automatically lock if the phone hasn't been used for a certain period of time, as well as block the phone's browser while the phone is locked.

When your phone is locked:

- You can only make an outgoing call to a number from a list of authorized numbers.
- You have to enter a password to answer incoming calls.
- All keys and soft keys are disabled, except those that allow you to unlock the phone, make an authorized call, redial a number, or view the browser (if enabled).

You unlock the phone by entering your user password. If your phone restarts for any reason while it is locked, it will be locked when the phone starts up again (unless your phone is configured to start up unlocked).

When your phone is locked, the 'The phone is locked' and 'Authorized calls only' messages scroll on the top line of the screen. Messages that displayed before the phone was locked don't display.

About Your User Password

You are assigned a user password so you can answer calls from your locked phone and unlock the phone. By default, your user password is 123. You can change your user password at any time.



Note: Changing Your User Password

To change your user password, you need to enter the administrator password, so contact your system administrator.

To change your user password:

- 1 Press the **Menu** key, then select **Settings > Advanced**.
- 2 When prompted, enter the administrative password, then press the **Enter** soft key.
- 3 Using the **Down** arrow key, find **Change User Password**.
- 4 Press the **Select** key.
- 5 Press the **Select** key to change your old password information.
Press the **Ok** soft key to accept changes.
- 6 Press the **Select** key to change your new password information.
Press the **Ok** soft key to accept changes.
- 7 Press the **Select** key to confirm your new password information.
Press the **Ok** soft key to accept changes.

Locking and Unlocking Your Phone

You can choose how you want your phone to handle incoming calls when it is locked. If you set up your phone to allow incoming calls when it is locked (the default setting), incoming calls will ring on your phone, and you can answer calls by entering your user password. If you set up your phone to ignore incoming calls, Do Not Disturb will be applied to all lines on your phone, and your phone will not ring.

To lock your phone:

- 1 Press the **Menu** key, then select **Settings > Basic > Lock Phone**.
- 2 Press the **Select** key.
- 3 Select how you want incoming calls handled when your phone is locked.
 - **Allow ringing when locked**—Select this option if you want your phone to ring when you have an incoming call. If you choose this option, you can answer a call by entering your password.

- **DND when locked**—Select this option if you don't want your phone to ring. You won't have the option to answer incoming calls. All incoming calls will go to your mail system (if enabled) and display in your Missed Calls list.

The default setting is **Allow ringing when locked**.



Note: Using DND When Locked

Enabling **DND when locked** on shared lines disables ringing only. You will still see a call appearance and have the option to answer it.

- 4 Press the left arrow key repeatedly to return to the idle screen.
- 5 Press the **Lock** soft key.
Your phone is now locked.

To unlock your phone:

- 1 From the idle screen, press the **Unlock** soft key.
- 2 Enter your password, then press the **Enter** soft key.

(For information on your user password, including what to do if you forget your user password, see [About Your User Password](#).)

The phone unlocks.

Calling and Answering from a Locked Phone

From a locked phone, anyone can dial the standard emergency number (for example, 911), and up to five authorized numbers that an administrator can set up. You cannot call any other numbers from a locked phone.



You can enable your phone to answer incoming calls while it's locked. If enabled, you can answer calls by entering your user password.

To call an authorized number from a locked phone:

- Do one of the following:
 - Press the **New Call** soft key. From the list of authorized numbers, select the number you want to call, and then press the **Dial** key.

The following figure shows an example of the Place an Authorized Call screen.



- Place a call to an authorized number by using the handset, headset, or speakerphone. For information on using the handset, headset, or speakerphone to place a call, see [Placing Calls](#).

If you try to place a call to an unauthorized number, the 'Unauthorized number' message displays. (To view a list of authorized numbers that you can call, press the **New Call** soft key from the idle screen when your phone is locked.)

The call is placed.

To answer a call on a locked phone:

- 1 While the phone rings, press the **Answer** soft key.
- 2 When prompted, enter your password, then press the **Enter** soft key.

If you press the **Cancel** soft key instead, the answer call screen disappears and the incoming call window displays again.

For information on your user password, including what to do if you forget your user password, see [About Your User Password](#).

The call connects.

Logging Into Phones

If your system administrator has set up the User Profile feature, you can view your personal phone settings from any phone in the organization. This means you can access your contact directory and speed dials, as well as other phone settings, even as you temporarily change work areas.

If you change any settings while you're logged in to a phone, the settings are saved and displayed the next time you log in to a phone. When you log out, your personal phone settings no longer display.

You can log in to a phone by entering your user ID and password. Default passwords are preset at the factory to the numerals 123.



Note: Placing Emergency Calls on a Locked Phone

If a phone is in the logged out state and requires a user login, you may be able to use the phone to place emergency calls to standard emergency numbers (such as 911) and other pre-configured phone numbers. These numbers are configured by your administrator. For information on how to place authorized calls, see [Placing Calls from Phones that are in the Logged Out State](#).

If the User Login feature is set up on your organization's phones, you'll need to know how to:

- Log in to a phone to access your personal phone settings.
- Log out of a phone after you finish using it.
- Place a call to an authorized number from a phone that is in the logged out state and requires a user login.
- Change your user password.

Logging In and Out of a Phone

If the User Profiles feature is enabled, you have the option to log in to the phone to use your personal phone settings. Otherwise, you'll use the phone's default profile.

Your system administrator may have configured your phone to require you to log in before you can use your personal settings. Contact your system administrator to see if this behavior is enabled.

While logged in, you'll have full access to your personal phone settings and your contact directory. After you log out of the phone, you'll no longer be able to view this information on the phone.

When finished using a phone, ensure to log out of the phone to prevent access to your personal settings.

To log in to a phone:

- 1 If the User Login screen is in view, go to step 2. If the User Login screen isn't in view, do one of the following:
 - Press the **Log in** soft key.
 - Press the **Menu** key, then select **Features > User Login > Log in**.

The User Login screen displays, as shown next.



- 2 Press the **Select** key, enter your user ID, and then press the **Ok** soft key.

The User Login screen redisplay, as shown next.



- 3 Press the **Down** arrow key.

The User Password screen displays, as shown next.

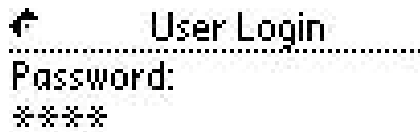

- 4 Press the **Select** key, enter your password, and then press the **Ok** soft key.
- 5 Press the left arrow key.

The Login Confirmation screen displays, as shown next.



- 6 Press the **Yes** soft key.

If your login credentials are accepted, the phone updates to display your personal phone profile, and the idle screen displays, as shown next.



If you don't know what your user ID and password are, ask your system administrator. Default passwords are preset at the factory to the numerals 123. However, your system administrator may have changed this for security reasons.

If your credentials are not accepted, the message 'User login failed' displays, and the User Login screen displays again. If you need to confirm your credentials, ask your system administrator.

To log out of a phone:

- 1 From the idle screen, do one of the following:
 - o Press the **Log out** soft key. You may need to press the **More** soft key first.
 - o Press the **Menu** key, then select **Features > User Login > Log out**.

The Logout screen displays with a confirmation message, as shown next.



- 2 Press the **Yes** soft key.

Your personal profile is no longer accessible, and the phone displays either the User Login screen for the next user login, or the default phone profile for anonymous users.

Placing Calls from Phones that are in the Logged Out State

If a phone doesn't require a user login, you can use the phone to place calls to any number, even though the phone may be in the logged out state.

If a phone requires a user login, you may be able to place calls to authorized numbers when the phone is in the logged out state. If your system administrator has set up emergency numbers on the phone, you can place calls to the standard emergency number (for example, 911) and up to five other authorized numbers. You won't be able to call any other numbers until you log in to the phone.

To place a call to an authorized number from a phone in the logged out state:

- 1 Press the **New Call** soft key.

The Place an Authorized Call screen displays, as shown next.



- 2 Select the number you want to call, then press the **Select** soft key or the **Dial** key.

The call is placed.

Changing Your User Password

You can change your password from any phone that you're logged in to.



Note: Changing the Default Password

By default, user passwords are factory preset to the numerals 123. Your administrator can change this default password if needed. Polycom recommends that you change your password when you first log in to a phone. Your system administrator manages your user ID, you cannot change it yourself.

To change your user password:

- 1 Log in to any phone on your network.
- 2 From the idle screen, press the **Menu** key, then select **Features > User Login > Change User Login Password**.

The Change User Login Password Old Password screen displays, as shown next.

← Change User Login Pa...
Old Password:

- 3 Press the **Select** key, enter your old password, and then press the **Ok** soft key.
- 4 Press the **Down** arrow key.

The Change User Login Password New Password screen displays, as shown next.

← Change User Login Pa...
New Password:

- 5 Press the **Select** key, enter your new password, and then press the **Ok** soft key.
- 6 Press the **Down** arrow key.

The Change User Login Password Confirm New Password screen displays, as shown next.

← Change User Login Pa...
Confirm New:

Your password is changed. The next time you log in to a phone, you'll need to enter this password.

Chapter 3: Using the Advanced Features of Your Phone

This chapter shows you how to use the advanced features on your Polycom® SoundPoint® IP 32x/33x phone. The topics include:

- [SIP-B Automatic Call Distribution](#)
- [Using Buddy Lists](#)
- [Broadcasting Messages Using Push-to-Talk and Group Paging](#)
- [Updating Your Phone's Configuration](#)
- [Restarting Your Phone](#)

To read about the phone's basic features, see [Using Your Phone](#). To customize your phone, see [Customizing Your Phone](#).

If you require additional information or assistance with your new phone, contact your system administrator.

SIP-B Automatic Call Distribution

Automatic call distribution (ACD) systems enable incoming phone calls to direct to a person who is able to talk at the earliest opportunity.





Troubleshooting: I Can't Access Automatic Call Distribution



ACD is not available on all call servers. For more information, contact your system administrator.

The phone allows:

- ACD login and logout
- ACD agent available and unavailable

When ACD is enabled on your phone, the line icon  displays. This is the default setting. No calls will be directed to your phone.

After you log in, the line icon changes to . You are now considered available and calls will be directed to your phone.

After you end a call, the line icon alternates between  and  showing you are now unavailable. You must set yourself to available for calls to be directed to you again.

Logging Into and Out of ACD

Calls may be directed to you, as an ACD agent, if you are logged in. Once you log out, calls cannot be directed to you.

To log into the ACD:

- 1 Press the **Menu** key.
- 2 Select **Features > ACD Login/Logout > Login**.

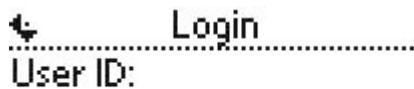

- 3 Press the **Select** soft key, enter your user ID, and then press the **Login** soft key.
- 4 Press the **Down** arrow key.
- 5 Press the **Select** key, enter your password, and then press the **Login** soft key.

To log out of the ACD:

- 1 Press the **Menu** key.
- 2 Select **Features > ACD Login/Logout > Logout**.

Setting ACD Agent Availability

Calls can be directed to you, as an ACD agent, if you are logged and available. Once you are unavailable, calls cannot be directed to you.

To set ACD agent availability:

- 1 Press the **Menu** key.
- 2 Select **Features > ACD Agent Availability**.



- 3 Use the **Left** and **Right** arrow keys to switch between **Available** and **Unavailable**.
- 4 Press the **Select** key to select the setting.

Repeat steps 1 to 4 to manually change the ACD agent availability.

Using Buddy Lists

Your phone combines interactive message services and status monitoring to complement messaging applications such as email.

Live interaction within a pool of phones is possible by monitoring the presence of the parties involved. Your phone can watch the status of up to eight other phones or buddies. These other phones form your buddy list. Your phone displays the status of your buddies in real time. Your phone can be watched by up to eight other phones.

If your phone is configured to work with Microsoft Live Communications Server 2005, the behavior of the presence setting and buddy lists is different. For more information, see [Integrating With Microsoft Live Communications Server 2005](#).

Updating Your Presence Settings

You can change your presence settings on your phone.

To view and change your presence settings:

- 1 Press the **Menu** key, then select **Features > Presence > My Status**.



- 2 Use the **Up** or **Down** arrow key to scroll through the list, then press the **Select** soft key to select your new status.

This affects information sent to phones watching you. Presence information will also be sent to watching phones when you go off-hook or enable Do Not Disturb.

Managing Buddies

You can select the buddies you want to monitor. These contacts form your buddy status list. You add contacts to your buddy status list from your contact directory.



Note: Buddies Behave Differently

If your call server is Microsoft Live Communications Server 2005, see [Integrating With Microsoft Live Communications Server 2005](#).

Updating Your Buddy List

You can add or delete buddies by updating your contact directory.

To add or delete a contact from your buddy status list:

- 1 Press the **Dir** soft key.
- 2 Use the **Up** or **Down** arrow keys to scroll through the list to find the contact.
- 3 Press the **Select** key.
- 4 Press the **Down** arrow key repeatedly until the *Watch Buddy* field displays.
- 5 Press the **Select** key.
- 6 Use the **Left** or **Right** arrow key to switch between **Enabled**.

When Watch Buddy is enabled, the contact is added to your buddy list. When Watch Buddy is disabled, the contact is removed from your buddy list.

The default for Watch Buddy is **Disabled**.

- 7 Press the **Ok** soft key to accept changes.

Blocking and Unblocking Your Buddies

If you don't want a contact to view your status, you can block them by updating your contact directory.

To block or unblock a contact from your buddy list:

- 1 Press the **Dir** soft key.
- 2 Use the **Up** or **Down** arrow keys to scroll through the list to find the contact.
- 3 Press the **Select** key.
- 4 Press the **Down** arrow key repeatedly until the *Block Buddy* field displays.
- 5 Press the **Select** key.
- 6 Use the **Left** or **Right** arrow key to switch between **Enabled**.

When Block Buddy is enabled, the contact cannot watch your phone. When Block Buddy is disabled, the contact can watch your phone.

The default for Block Buddy is **Disabled**.

- 7 Press the **Ok** soft key to accept changes.

Integrating With Microsoft Live Communications Server 2005

Your system administrator can configure your phone to work with Microsoft Live Communications Server 2005 and communicate with others using Microsoft Office Communicator and Windows Messenger. From your phone, you can invite, join, control, and monitor integrated multipoint audio and video conferences.

Any contacts added through your buddy status list will appear as a contact in Microsoft Office Communicator and Windows Messenger. Any contacts added as a contact in Microsoft Office Communicator and Windows Messenger will appear in your buddy status list.

To view and change your presence, see [Updating Your Presence Settings](#). For more information on integrating with Microsoft Live Communications Server 2005, contact your system administrator.

To add a contact to your buddy list:

- 1 Press the **Menu** key, then select **Features > Presence > Buddy Status**.
- 2 Do one of the following steps:
 - If the buddy list is empty, press the **Select** key to enter a new buddy's contact number.
 - If the buddy list is not empty, use the **Up** arrow key to scroll up the new entry, press the **Select** key to enter a new buddy's contact number.
 - If the buddy list is not empty, press the **Select** key to select an entry, then press the **Add** soft key to add a new entry.
- 3 Enter the desired contact number and press the **Ok** soft key.

You can also delete a contact or dial a contact from your buddy list.

To view and change your privacy list:

- 1 Press the **Menu** key, then select **Features > Presence > Privacy List**.
- 2 Use the **Up** or **Down** arrow keys to scroll through the list to find the contact.
- 3 Press the **Select** key.
- 4 Press **Edit** soft key.
- 5 Press the **Down** arrow key to scroll through the list to find the *Access* field.
- 6 Press the **Select** key.
- 7 For *Access*, use the **Left** or **Right** arrow key to select **Enabled**.

When you enable *Access*, you allow a contact to see your presence. When you disable *Access*, you block a contact from seeing your presence.

The default for access is **Disabled**.

You can also delete a contact or dial a contact from your privacy list.

For more information on contacting buddies, see [Placing Calls](#) or the Microsoft Office Communicator and Windows Messenger documentation.

Broadcasting Messages Using Push-to-Talk and Group Paging

The Group Paging feature enables you to make pages —one-way audio announcements — to users subscribed to a page *group*. The Push-to-Talk (PTT) feature is a collaborative tool that enables you to exchange broadcasts to users subscribed to a PTT *channel*, much like a walkie-talkie. Your system administrator can set up both features on your phone.

Your system administrator can define up to 25 Paging Groups or Channels. Your system administrator may assign a label to each group or channel that easily identifies the phones in the group or channel (for example, All, HR Dept, Shipping Staff, or Executives). Each group or channel will have one of the following priorities:

- **Normal**—By default, broadcasts sent to Groups/Channels 1 to 23 are considered Normal broadcasts. If two users begin a broadcast on the same group/channel at the same time, the phone with the lower serial number will continue to transmit while the other phone will enter the receiving state. By default, all phones are configured to receive broadcasts sent to Group/Channel 1.
- **Priority**—By default, broadcasts sent to Group/Channel 24 are considered Priority broadcasts. A Priority broadcast will interrupt Normal broadcasts or active calls. All phones receive Priority broadcasts unless Do Not Disturb is enabled. Phones play Priority broadcasts at the phone's current audio level.
- **Emergency**—By default, broadcasts sent to Group/Channel 25 are considered Emergency broadcasts. An Emergency broadcast will interrupt Normal broadcasts, Priority broadcasts, and active calls and plays out at near maximum volume even if Do Not Disturb (DND) is turned on.

Push-to-Talk Mode

Your system administrator can enable your phone to operate in a broadcast mode called Push-to-Talk (PTT). In order to send and receive PTT broadcasts, you have to subscribe to PTT channels.

PTT broadcasts are collaborative: you can transmit messages and listen to replies.

Sending and Receiving PTT Broadcasts

By default, you're subscribed to Channels 1, 24, and 25. This means that you can send and receive PTT broadcasts on Channels 1, 24, and 25.

When you end a PTT broadcast, the channel remains open and enters a waiting period. This waiting period gives people who received the broadcast a chance to respond. If no one responds within the waiting period, the channel closes.

Sending PTT Broadcasts

Before you can send a PTT broadcast, you need to choose a channel to broadcast on. Or, you can hold the **Talk** soft key to immediately begin broadcasting on Channel 1, the default channel.

You can change your default channel to any channel you want (see [Updating the Default Channel](#)). If you change your default channel, you'll need to make sure you're subscribed to that channel, or else the channel won't be available when you initiate a PTT broadcast. To subscribe to a channel, see [Updating Channel Subscriptions](#)).

To send a PTT broadcast:

- 1 Press the **Talk** soft key to select a channel to broadcast on.



Timesaver: Sending a PTT Broadcast to the Default Channel

To automatically send a PTT broadcast on the default channel, press and hold the **Talk** soft key, and then go to step 4.

- 2 From the PTT Channels List screen, select the channel to send the broadcast on as shown next.



The list displays the default channel, the most recent channel you sent a broadcast on, and other channels you can broadcast on.

In the above example, the default channel is 1.

- 3 To start a broadcast, press and hold the **Talk** soft key. (You need to press the **Talk** soft key throughout the entire broadcast.)

You'll hear a 'transmitting' beep, and the phone will display the channel information such as the channel label, shown next.



- 4 Begin speaking.

**Note: Using the Talk Soft Key"**

If you release the **Talk** soft key while you're sending a broadcast, the broadcast temporarily stops and enters a 10 second 'Waiting' period. During this period, the channel remains open to give people a chance to reply. At any time during the waiting period, you can resume your broadcast by pressing and holding the **Talk** soft key. If no one broadcasts during the waiting period, the channel closes and the broadcast ends.

5 When you finish your broadcast, do one of the following:

- Release the **Talk** soft key.
- Press the **End PTT** soft key.

After you tap the **End PTT** soft key, you can immediately initiate another broadcast on another channel, even if the previous broadcast is still in its waiting period.

Receiving PTT Broadcasts

To receive a broadcast sent on a particular channel, you need to subscribe to that channel. To subscribe to a channel, see [Updating Channel Subscriptions](#).

How you receive a PTT broadcast depends on the broadcast priority, whether you're in an active call, or if you're allowed to receive broadcasts during active calls.

You'll receive broadcasts on the channels you're subscribed to as well as Channel 24 (the default Priority channel) and Channel 25 (the default Emergency channel). If you've enabled **Do Not Disturb** on your phone, you'll only receive Emergency broadcasts. Non-emergency broadcasts won't display or play on your phone.

When a broadcast ends, your phone emits an 'end of transmission' beep and enters a 10 second waiting period. During this period, you can respond to the broadcast (see [Replying to PTT Broadcasts](#)).

Receiving PTT Broadcasts When You're Not in an Active Call

If you receive a broadcast and you're not in an active call, the broadcast displays in the center of your screen and immediately plays, regardless of the broadcast priority.

Receiving PTT Broadcasts During Active Calls

How you handle a broadcast when you're in an active call depends on the broadcast priority and if you're allowed to receive a broadcast when you're in an active call.

If the broadcast is a Normal broadcast:

- If your phone is enabled to receive broadcasts during active calls, the broadcast displays in the inactive call group as an active broadcast and immediately plays. You'll hear both the original call and the broadcast. To listen to only the broadcast, hold or end the call.

- If your phone isn't allowed to receive broadcasts during active calls, the broadcast displays in the inactive call group as a held broadcast, as shown next. To listen to the broadcast, hold or end the call.

If the broadcast is a Priority or Emergency broadcast, the broadcast displays in the inactive call group as an active broadcast and immediately plays. You'll hear both the original call and the broadcast. To listen to only the broadcast, hold or end the call.

Replying to PTT Broadcasts

When a broadcast ends, the broadcast enters a 10 second waiting period. During this period, the channel remains open to receive or send additional broadcasts.

During a waiting period, you can press and hold the **Talk** soft key and talk to all the people listening on the channel. When you finish talking, release the **Talk** soft key. The broadcast will enter another waiting period until someone broadcasts again. If no activity occurs within the waiting period, the channel closes and no more broadcasts can take place.

Ending PTT Broadcasts

You can end a PTT broadcast by releasing the **Talk** soft key, or by tapping the **End PTT** soft key. After you end a broadcast, the channel remains open so others can respond.

If you release the **Talk** soft key without pressing the **End PTT** soft key:

- You can resume the broadcast by pressing and holding the **Talk** soft key (if the broadcast is in a wait period).
- You can't initiate another broadcast on another channel until the waiting period ends.

If you press the **End PTT** soft key:

- You can't resume the broadcast by pressing and holding the **Talk** soft key.
- You can immediately initiate another broadcast on another channel.

Adjusting the Volume of PTT Broadcasts

You can adjust the volume of PTT broadcasts while they play. During a broadcast, press either **Volume Up** or **Volume Down** to raise or lower the volume of the broadcast.

If you adjust the volume of a non-emergency broadcast, your phone retains the adjusted volume for all subsequent non-emergency broadcasts. However, only system administrators can adjust the volume level of an Emergency broadcast.

Changing Where Broadcasts are Played

While you send a broadcast, you can pick up the handset or press the **Speakerphone** or the **Headset** key and continue speaking. You can also press the **Microphone Mute** key to mute your audio so that the people receiving your broadcast won't hear anything. This behavior is similar to a phone call.

When you listen to a broadcast, you can pick up the handset or press **Speakerphone** or the **Headset** key and continue listening to the broadcast.

Updating the Default Channel

If you press and hold the **Talk** soft key, your broadcast will automatically transmit on the default channel, Channel 1. If you want, you can change the default channel.

To update the default channel:

- 1 Press the **Menu** key, then select **Settings > Basic > Preferences > Paging/PTT Configuration > PTT Push To Talk**.
- 2 On the PTT Channel Configuration screen, select **Default Channel** and press the **Edit soft key**.
- 3 Use the dial pad to enter the default channel you want to use.
- 4 Press the **Ok** soft key.

Updating Channel Subscriptions

You can subscribe to any channel that has been enabled by the system administrator and appears in your channels list. When you subscribe to a channel, you can send and receive PTT broadcasts on that channel.

To subscribe to additional PTT channels:

- 1 Press the **Menu** key, then select **Settings > Basic > Preferences > Paging/PTT Configuration > PTT Push to Talk**.
- 2 From the PTT Channel Configuration screen, use the down arrow key to locate **Channels Subscriptions**, then press the **Select** key.
- 3 From the Channels Subscriptions screen, use the down arrow key to select a channel to subscribe to, then press the **Select** key.
- 4 Use the **Left** or **Right** arrow keys to select **Yes**, then press the **Ok** soft key.

Allowing PTT Broadcasts to Play During Active Calls

The **Accept While Busy** option enables PTT broadcasts to come in as active calls (if enabled) or held calls (if disabled).

If enabled, a PTT broadcast will interrupt telephone calls and you'll hear the audio of both the telephone call and the PTT broadcast. The party on the other end of the telephone call cannot hear the PTT broadcast unless that party has also enabled **Accept While Busy**.

If disabled, PTT broadcasts are held during an active call. To hear the broadcast, you have to resume the broadcast.

To allow or disallow PTT broadcasts to play during an active call:

- 1 Press the **Menu** key, then select **Settings > Basic > Preferences > Paging/PTT Configuration > PTT Push to Talk**.
- 2 From the PTT Channel Configuration screen, use the down arrow key to locate **Accept While Busy**, then press the **Select** key.
- 3 From the Accept While Busy screen, use the **Left** or **Right** arrow key to select **Enabled** or **Disabled**, then press the **Ok** soft key.

The default setting is **Disabled**. When enabled, your phone will accept and play broadcasts while you're in an active call. When disabled, your phone won't play broadcasts while you're in a call, but will hold them instead.

Group Paging Mode

Your system administrator may enable your phone to operate in a broadcast mode called Group Paging mode. In this mode, you broadcast one-way announcements to a specified group of phones, called a Paging Group. In Group Paging mode, users must subscribe to Paging Groups to send and receive pages.

Sending and Receiving Pages

To send and receive pages, you need to subscribe to certain Paging Groups. By default, you're subscribed to Paging Groups 1, 24, and 25. This means that you can send and receive pages to Paging Groups 1, 24, and 25.

Sending Pages

By default, when you send a group page, it's automatically sent to Paging Group 1. This is your default paging group.

You can change your default paging group to any group you want (see [Updating the Default Paging Group](#)). If you change your default paging group, you'll need to make sure you're subscribed to that group, or else the group won't be available when you initiate a page. To subscribe to a paging group, see [Updating Paging Group Subscriptions](#).

To send a page:

- 1 To send a page, press the **Paging** soft key. You may need to press the **More** soft key first.





Timesaver: Sending a Group Page to the Default Paging Group

To automatically send a page to the default paging group, press and hold the **Paging** soft key.

- From the Paging Groups List screen, select the paging group to send the page to as shown next.



The list displays the default paging group, the most recent group you paged, and other paging groups that you can page.

In the above example, the default paging group is **Group 1**.

- To begin a page, press the **Page** soft key.

Just before the page starts, you'll hear an alert tone, and then the page begins as shown next.



- Begin speaking.
- Press the **End Page** soft key to end your page.

Receiving Pages

To receive a page sent to a particular paging group, you need to subscribe to that group. To subscribe to a paging group, see [Updating Paging Group Subscriptions](#).

How you receive a page depends on the priority of the page, whether you're in an active call, or if you're allowed to receive a page during an active call.

You'll receive pages on the paging groups you're subscribed to as well as Group 24 (the default Priority pages) and Group 25 (the default Emergency pages). If you enabled **Do Not Disturb**, you'll only receive Emergency pages. Non-emergency pages won't display or play on your phone.

Receiving Pages When You're Not in an Active Call

If you receive a page and you're not in an active call, the page displays in the center of your screen and immediately plays, regardless of the paging priority.

While a page plays, you can:

- Hold the page.

- End the page. This ends the page at your phone only.
- Place a new call.

Receiving Pages During Active Calls

How you handle a page when you're in an active call depends on the page priority and if you're allowed to receive a page when you're in an active call.

If the page is a Normal:

- If your phone is allowed to receive pages during active calls, the page displays in the inactive call group as an active page and immediately plays. You'll hear both the original call and the page. To hear only the page, hold or end the call.
- If your phone isn't allowed to receive pages during active calls, the page displays in the inactive call group as a held page.

You can listen to the page by resuming it. This will place the active call on hold.

If page is a Priority or Emergency page, the page displays in the inactive call group as an active page and immediately plays. You'll hear both the original call and the page. To hear just the page, hold or end the call.

Adjusting the Volume of Pages

You can adjust the volume of pages while they play. During a page, press either **Volume Up** or **Volume Down** to raise or lower the page volume.

If you adjust the volume of a non-emergency page, your phone will use the adjusted volume for subsequent non-emergency pages. However, only your system administrator can change the volume of an Emergency page.

Changing Where Pages are Played

While you send a page, you can pick up the handset or press **Speakerphone** or the **Headset** key and continue speaking. You can also press the **Microphone Mute** key to mute your audio so that the people receiving your page won't hear anything. This behavior is similar to a phone call.

When you receive a page, the page is played through the phone's speakerphone.

Updating the Default Paging Group

If you press and hold the **Paging** soft key, your page will automatically go to the default paging group, Paging Group 1. If you want, you can change the default paging group.

To update the default Paging Group:

- 1 Press the **Menu** key, then select **Settings > Basic > Preferences > Paging/PTT Configuration > Group Paging**.
- 2 From the Group Paging Configuration screen, press the **Select** key.

The default paging group is 1.

- 3 Enter the number of the new default paging group, then press the **Ok** soft key.

Updating Paging Group Subscriptions

By default, you're subscribed to Paging Groups 1, 24, and 25. This means that you can send pages to and receive pages sent to these groups. You can change which groups you are subscribed to. However, you can't disable your subscriptions to Paging Groups 24 and 25.

To update your Paging Group subscriptions:

- 1 Press the **Menu** key, then select **Settings > Basic > Preferences > Paging/PTT Configuration > Group Paging**.
- 2 From the Group Paging Configuration screen, use the down arrow key to locate **Groups Subscriptions**, then press the **Select** key.
- 3 From the Group Subscription screen, use the down arrow key to select a group to subscribe to, then press the **Select** key.

For example, you may want to enable subscriptions to Paging Group 6, so you'll be able to send pages to, and receive pages sent to, this group.
- 4 Use the **Left** or **Right** arrow keys to select **Yes**, then press the **Ok** soft key.

Allowing Pages to Play During Active Calls

The Accept While Busy option enables pages to come in as active calls (if enabled) or held calls (if disabled).

If enabled, a page will interrupt telephone calls and you'll be able to hear the audio of both the telephone call and the page. The party on the other end of the telephone call cannot hear the page unless that party has also enabled Accept While Busy.

If disabled, pages are placed on hold during an active call. To hear the page, select the page, and then resume it.

To allow or disallow pages to play during an active call:

- 1 Press the **Menu** key, then select **Settings > Basic > Preferences > Paging/PTT Configuration > Group Paging**.
- 2 From the Group Paging Configuration screen, use the down arrow key to locate **Accept While Busy**, then press the **Select** key.
- 3 From the Accept While Busy screen, use the **Left** or **Right** arrow key to select **Enabled** or **Disabled**, then press the **Ok** soft key.

The default setting is **Disabled**. When enabled, your phone will accept and play pages while you're in an active call. When disabled, your phone won't play pages while you're in a call, but will hold them instead.

Updating Your Phone's Configuration

You can update your phone's configuration without restarting the phone.

To update your phone's configuration:

- 1 Press the **Menu** key, then select **Settings > Basic > Update Configuration**.
The 'Are you sure?' message displays.
- 2 Press the **Yes** soft key.
The configuration is updated. Your phone may restart, depending on the configuration parameters that you changed.
- 3 If the phone doesn't restart, press the **Menu** key to return to the idle screen.

Restarting Your Phone

Your system administrator may ask you to restart your phone if your phone malfunctions or to assist in troubleshooting.



Note: When to Restart Your Phone

Contact your system administrator before attempting to restart your phone. You may be able to restore normal operation without restarting the phone. In addition, your administrator may want to troubleshoot your phone before you restart it.

If you want to update your phone's configuration, don't restart the phone. See [Updating Your Phone's Configuration](#).

When your phone is restarted, your call lists are automatically cleared.

To restart the phone:

- 1 Press the **Menu** key, then select **Settings > Basic > Restart Phone**.
The 'Are you sure?' message displays.
- 2 If you still want to restart your phone, press the **Yes** soft key.
The restart process begins. The process ends when the idle screen displays.

Chapter 4: Customizing Your Phone

This chapter shows you how to customize your Polycom® SoundPoint® IP 32x/33x phone display by adjusting certain settings, such as time and date display, backlight intensity, and language.

The topics include:

- [Changing the Time and Date Display](#)
- [Changing the Backlight](#)
- [Changing the Language](#)
- [Saving the Corporate Directory Search Filter](#)

Changing the Time and Date Display

The time and date appears on the graphic display of the SoundPoint IP 32x/33x phone. If the phone cannot obtain a time and date from a configured SNTP server, the display will flash. Contact your system administrator if either the time or date is incorrect.

You can change the format of the time and date display and can enable or disable it. The default time and date format appears in the following figure.

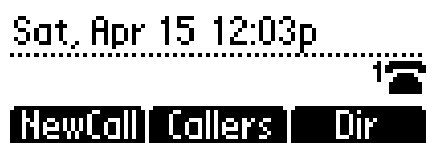

To configure the time and date:

- 1 Press the **Menu** key.
- 2 Select **Settings > Basic > Preferences > Time & Date**.
- 3 Select from **Clock Date**, **Clock Time**, **Clock Order**, or **Enable/Disable**.
- 4 Scroll through the options under each of these selections using the **Up** and **Down** arrow keys.
- 5 Press the **Select** key to confirm your choice.

For example, the following figure shows Clock Time.



Changing the Backlight

The backlight is available only on the SoundPoint IP 335.

You can adjust your phone's backlight by doing the following:

- Changing the brightness of the backlight.
- Changing the backlight timeout.

Changing the Backlight Brightness

The backlight brightness – or backlight intensity – has three components:

- **Backlight On Intensity**—The brightness of the screen when you press a key, have an incoming call, end or hold a call, or another party resumes a call. You can set it to high, medium, or low.
- **Backlight Idle Intensity**—The brightness of the screen after the phone has been idle for a certain number of seconds (as defined by the backlight timeout). You can set it to high, medium, or low.
- **Maximum Intensity**—The entire backlight intensity scale. For example, if you decrease the Maximum Intensity, the Low, Medium, and High values for the Backlight On Intensity and the Backlight Idle Intensity will decrease proportionally.

If you do not press any keys on the phone, after 20 seconds of the backlight turning on (the default backlight timeout), the backlight changes to the Backlight Idle Intensity. If one of the following phone events is taking place, the backlight changes to Medium:

- A call is in progress
- A call is on hold
- There is an incoming call (ringing)
- There is an outgoing call (ringing back)
- Any menu shows on the display

To modify the backlight intensity:

- 1 Press the **Menu** key.
- 2 Select **Settings > Basic > Backlight Intensity**.



- 3 Select **Backlight On Intensity**.

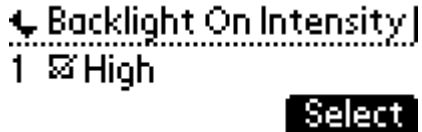

- 4 Use the **Up** or **Down** arrow keys to select high, medium, low, or off, then press the **Select** soft key.
The default level is High.

- 5 Select **Backlight Idle Intensity**.

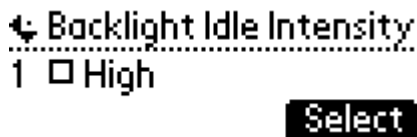

- 6 Use the **Up** or **Down** arrow keys to select high, medium, low, or off, and then press the **Select** soft key.
The default level is Low.

- 7 Select **Maximum Intensity**.



- 8 Press the **Up** or **Down** soft keys to increase or decrease the backlight intensity.
9 Press the **Ok** soft key to accept changes.

Changing the Backlight Timeout

You can change the length of time your phone is idle before the backlight changes to the Backlight Idle Intensity.

To change the backlight timeout:

- 1 Press the **Menu** key.
- 2 Select **Settings > Basic > Backlight Timeout**.
- 3 From the Backlight Timeout screen, scroll to the timeout you want, then press the **Select** soft key.
The default timeout is 40 seconds.

Changing the Language

Many languages are supported by the SoundPoint IP 32x/33x SIP phone.

To change the language:

- 1 Press the **Menu** key.
- 2 Select **Settings > Basic > Preferences > Language**.

The Language screen displays as shown next.



- 3 Scroll through the list of available languages.
- 4 Press the **Select** key to confirm your choices.

Text that appears on the screen will change to the language of your choice.

Saving the Contact Directory Search Filter

You can search the contact directory by first name or last name.

To change the directory search parameter:

- 1 Press the **Menu** key.
- 2 Select **Settings > Basic > Preferences > Directory search**.



- 3 Use the **Up** or **Down** arrow key to select the directory search parameter.
Last name is the default directory search parameter.



- 4 Press the **Select** key to select your choice.
- 5 Press the **Yes** soft key to accept changes.



User Tip: Contact Directory Reconfiguration

Depending on the size of your local contact directory, the reconfiguration may take a few minutes.

Your phone will restart to set the new directory search mode if you pressed the **Yes** soft key.

Chapter 5: Troubleshooting Your Phone

This chapter contains general troubleshooting information to help you solve any problems you might encounter when you use your Polycom® SoundPoint® IP 32x/33x phone. The tables in this chapter list possible trouble symptoms, the likely causes of these issues, and the recommended corrective actions to take.

- [Power and Startup Issues](#)
- [Controls](#)
- [Access to Screen and Systems](#)
- [Calling](#)
- [Display](#)
- [Audio Issues](#)
- [Productivity Suite](#)

To obtain more detailed troubleshooting information, you can access certain menus on your phone that test your phone hardware. For more information, see [Testing Phone Hardware](#).

If you require additional assistance, contact your system administrator.

Power and Startup Issues

Table 5-1: Power and Startup Issues

The phone has power issues or the phone has no power.

Determine if the problem is caused by the phone, the AC outlet, or the PoE switch. Do one of the following:

- Verify that no lights appear on the unit when it is powered up.
 - Check if the phone is properly plugged into a functional AC outlet.
 - Make sure that the phone isn't plugged into an outlet controlled by a light switch that is off.
 - If plugged into a power strip, try plugging directly into a wall outlet instead.
 - Try the phone in another room where the electricity is known to be working on a particular outlet.
 - If you are using POE, make sure the network switch is supplying power.
-

Controls

Table 5-2: Control

The dial pad does not work

If the dial pad on your phone does not respond, do one of the following:

- Check for a response from other feature keys or from the dial pad.
- Place a call to the phone from a known working telephone. Check for display updates.
- Check if the LAN port is active or inactive. Press the menu key, and then select **Status > Network > Ethernet**. From the **Ethernet** page, scroll to the **LAN port** field and verify that it is active.
- Check the termination at the switch or hub end of the network LAN cable. Ensure that the switch/hub port connected to the telephone is operational (if not accessible, contact your system administrator).
- Before restarting your phone (see [Restarting Your Phone](#)), contact your system administrator. Your system administrator may want to troubleshoot your phone in more detail before restarting the phone and losing current status information.

Access to Screen and Systems

Table 5-3: Screens and Systems

There is no response from feature key presses

If your phone is not in the active state, do one of the following:

- Press the keys more slowly.
- Check with your system administrator to see if the key has been mapped to a different function or is disabled.
- Place a call to the phone to check that inbound call display and ringing is normal. If successful, try to press feature keys within the call to access the Menu, for example.
- To confirm that the line is active, press the Menu key, and then select **Status > Lines > Line Information**. From the **Line Information** page, verify that your phone line is registered (the  icon displays).
- To attempt re-registration to the call server, restart your phone. Contact your system administrator.

The display shows the message *Network is Down*

If you see this message, the LAN cable is not properly connected. Do one of the following:

- Check termination at the switch or hub (furthest end of the cable from the phone).
- Check that the switch or hub is operational (flashing link/status lights) or contact your system administrator.
- Check if the LAN port is active or inactive. Press the menu key, and then select **Status > Network > Ethernet**. From the **Ethernet** page, scroll to the **LAN port** field and verify that it is active.
- To attempt re-registration to the call server, restart your phone. Contact your system administrator.

Calling

Table 5-4: Calling

There is no dial tone

If there is no dial tone, power may not be correctly supplied to the phone, try one of the following:

- Check that the display is illuminated.
- Make sure the LAN cable is inserted properly at the rear of the phone (try unplugging and re-inserting the cable).
- If using in-line powering, have your system administrator check that the switch is supplying power to the phone.

The dial tone is not present on one of the audio paths

If dial tone is not present on one of the audio paths, do one of the following:

- Switch between Handset, Headset (if present) or Hands-Free Speakerphone to see if dial tone is present on another path.
- If dial tone exists on another path, connect a different handset or headset to isolate the problem.

The line icon shows an unregistered line icon

If you see the following icon , your phone is unregistered. If your phone is not registered, contact your system administrator.

The phone does not ring

If there is a no ring tone, but the phone displays a visual indication when it receives an incoming call, do the following:

- Adjust the ring level from the front panel using the volume up/down keys.
- Check the status of handset, headset (if connected) and through the Hands-Free Speakerphone..

If outbound or inbound calling is unsuccessful:

- Place a call to the phone under investigation. Check that the display indicates incoming call information.
- Lift the handset. Ensure the dial tone is present and place a call to another extension or number. Check that the display changes in response.

If the ringer is turned off:

- During an incoming call, lift the handset, press the **Speakerphone** key or press the **Headset** key to obtain a dial tone.
 - Press the ringing Line Key or the **Answer** soft key to answer the call.
 - If the handset is off-hook when you press the **Answer** soft key or the Line Key, the call is routed to the handset.
 - If the handset is on-hook when you press the **Answer** soft key or Line Key, the call is routed to the speaker.
-

The *Service Unavailable* message displays on the screen

This message displays if you pressed the New Call soft key, dialed a number with the handset on-hook, attempted to make a call from the contact directory when the phone was not registered, or if you tried to place a call when available phone lines were in use.

If you see this message, contact your system administrator to see when your phone will be registered.

The speakerphone doesn't work after you press the Speakerphone key:

If the message *Handsfree mode disabled* displays on your phone screen, your system administrator has disabled the speakerphone on your phone. Handle calls using the handset or headset instead.

Display

Table 5-5: Display

There is no display or the display is incorrect

If there is no display, power may not be correctly supplied to the phone. Do one of the following:

- Check that the display is illuminated.
 - Make sure the power cable is inserted properly at the rear of the phone.
 - If using Power over Ethernet (PoE) powering, check that the PoE switch is supplying power to the phone.
 - Use the screen capture feature to determine if the display on the phone is incorrect. Contact your system administrator to determine the screen capture feature is enabled.
-

The display is too dark or too light

The phone contrast may be set incorrectly. To adjust the contrast, do one of the following:

- Adjust the contrast (See [Changing the Backlight](#)).
 - Restart the phone to obtain the default level of contrast.
 - Use the screen capture feature to determine if the display on the phone is incorrect. Contact your system administrator to determine the screen capture feature is enabled.
-

The display is flickering

Certain types of older fluorescent lighting cause the display to flicker. If your phone is in an environment lit with fluorescent lighting, do one of the following:

- Move your phone away from the lights.
 - Replace the lights.
-

Audio

Table 5-6: Audio Issues

There is no audio on the headset

If there is no audio on your headset, the connections may not be correct. Do one of the following:

- Ensure the headset is plugged into the jack marked Headset at the side of the phone.
- Ensure the headset amplifier (if present) is turned on and/or adjust the volume). If the amplifier uses batteries, ensure they are fully charged.
- Ensure that you have not picked up the handset.

There are audio or echo issues

If you experience echo issues:

- Press the Menu key, then select **Settings > Basic > Preferences > Headset > Echo Cancellation**.
 - Using the arrow keys, select Enabled, and then press the Select soft key.
 - Contact your system administrator or telephony provider.
-

Productivity Suite

Table 5-7: Productivity Suite Issues

One of the following features is not available on the phone:

- **Corporate Directory**
- **Conference Management**

Your system administrator must enable Corporate Directory and Conference Management support. If you cannot access any of the features, contact your system administrator.

Testing Phone Hardware

Your system administrator may ask you to access a diagnostics menu on your phone to test your phone hardware. From the diagnostics menu, you can test your phone's microphones, speaker, handset, third-party headset (if present), keypad mappings, and LCD display. See your system administrator for instructions on how to perform these tests.

To test your phone hardware, press the **Menu** key, and navigate to **Status > Diagnostics > Test Hardware**. From the **Test Hardware** menu, you can select **Audio Diagnostics**, **Keypad Diagnostics**, **Display Diagnostics**, or **LED Diagnostics**.

Chapter 6: Polycom UC Software Menu System

Features

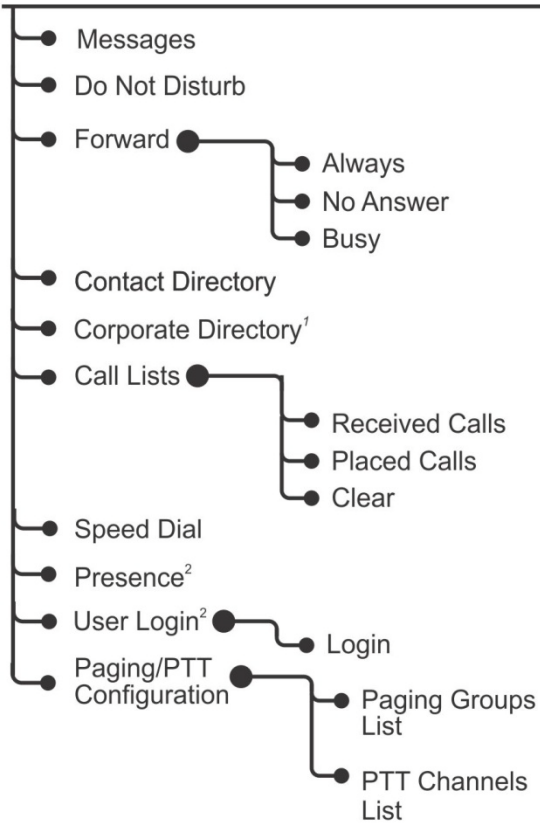

¹ If enabled and licenses available.

² If enabled.

Status

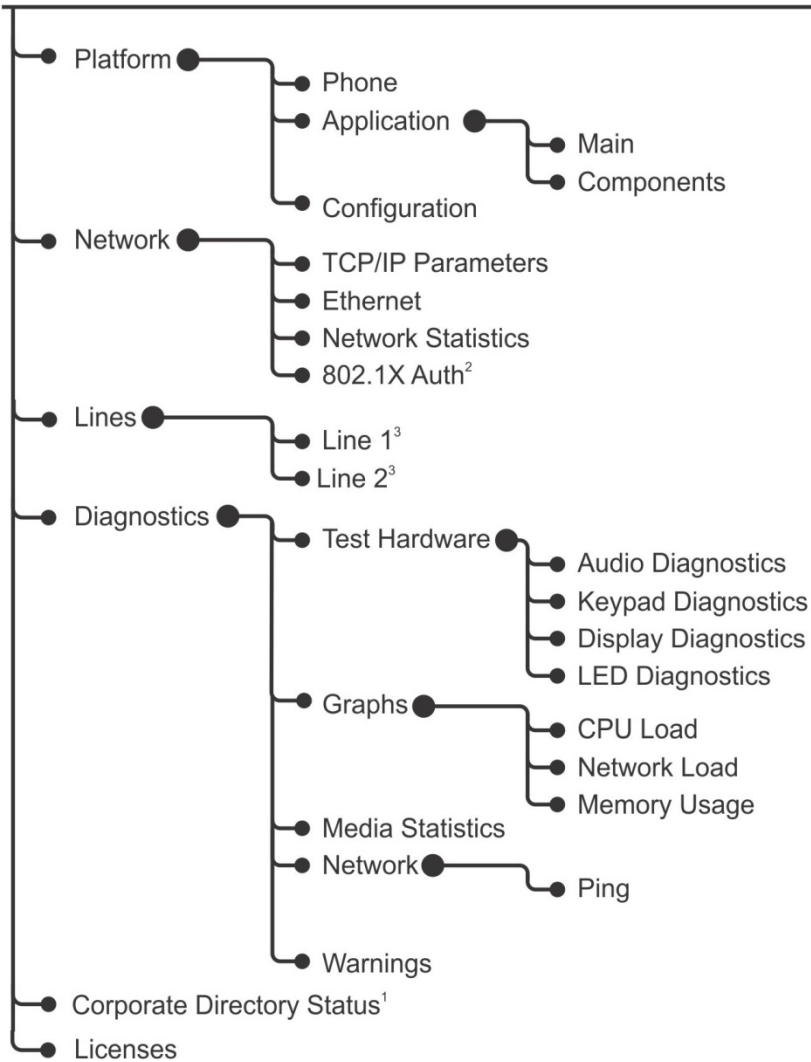

¹ If enabled and licenses available.

² If enabled.

³ If applicable.

Settings > Basic

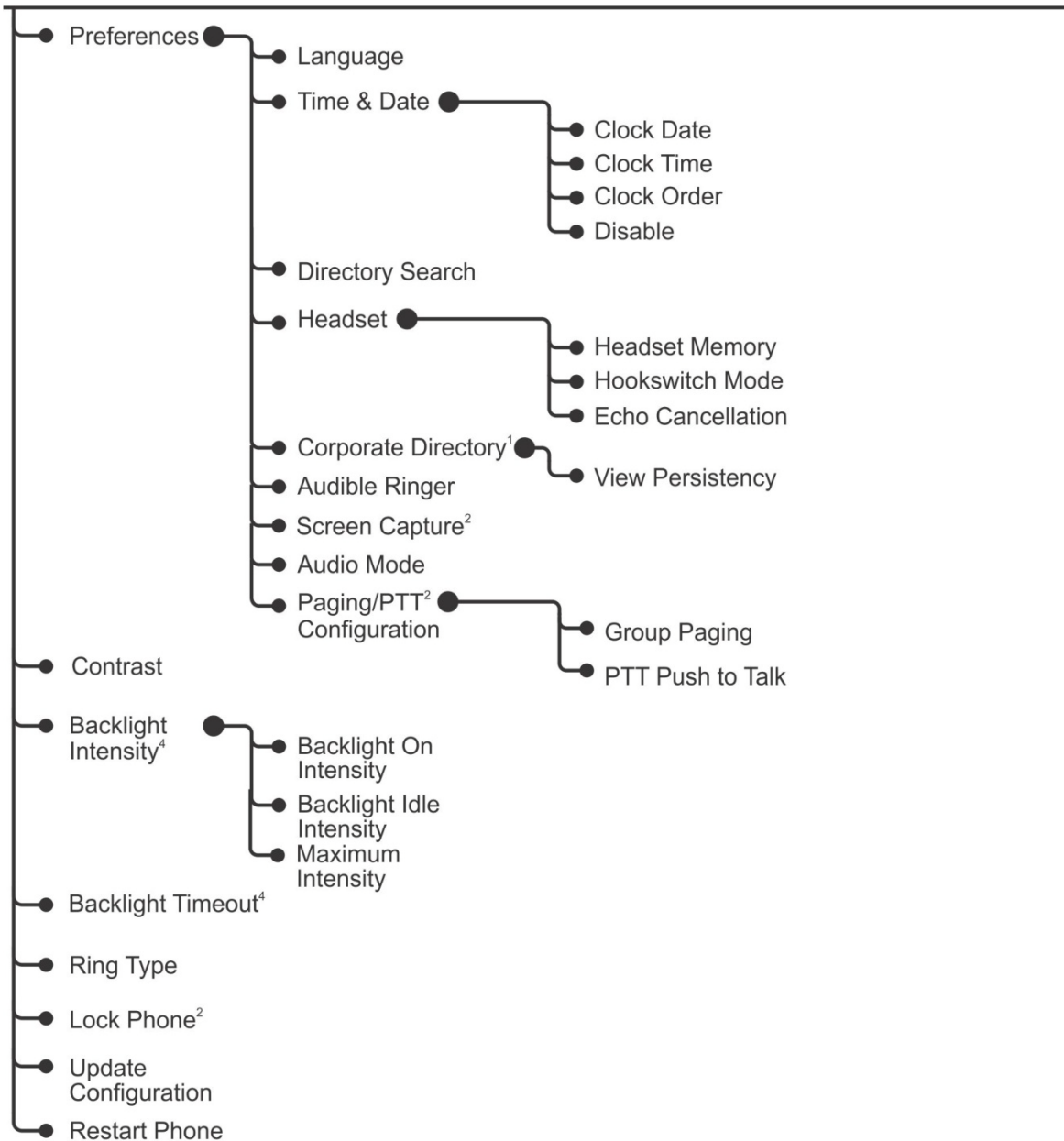

¹ If enabled and license available.

² If enabled.

⁴ Platform dependent.

Messages⁵

Applications⁵

⁵ *Organization dependent.*

Safety Notices

Service Agreements

Please contact your Polycom Authorized Reseller for information about service agreements applicable to your product.

Governing Law

This Limited Warranty and Limitation of Liability shall be governed by the laws of the State of California, U.S.A., and by the laws of the United States, excluding their conflicts of laws principles. The United Nations Convention on Contracts for the International Sale of Goods is hereby excluded in its entirety from application to this Limited Warranty and Limitation of Liability.

All rights reserved under International and Pan-American Copyright Conventions. No part of the contents of this manual may be copied, reproduced, or transmitted in any form or by any means, or translated into another language or format, in whole or part, without written consent from Polycom, Inc. Do not remove (or allow anybody else to remove) any product identification, copyright or other notices.

Limitations of Liability

LIMITATION OF LIABILITY. TO THE FULL EXTENT ALLOWED BY LAW, POLYCOM EXCLUDES FOR ITSELF AND ITS SUPPLIERS ANY LIABILITY, WHETHER BASED IN CONTRACT OR TORT (INCLUDING NEGLIGENCE), FOR INCIDENTAL, CONSEQUENTIAL, INDIRECT, SPECIAL, OR PUNITIVE DAMAGES OF ANY KIND, OR FOR LOSS OF REVENUE OR PROFITS, LOSS OF BUSINESS, LOSS OF INFORMATION OR DATA, OR OTHER FINANCIAL LOSS ARISING OUT OF OR IN CONNECTION WITH THE SALE, INSTALLATION, MAINTENANCE, USE, PERFORMANCE, FAILURE, OR INTERRUPTION OF ITS PRODUCTS, EVEN IF POLYCOM OR ITS AUTHORIZED RESELLER HAS BEEN ADVISED OF THE POSSIBILITY OF SUCH DAMAGES, AND LIMITS ITS LIABILITY TO REPAIR, REPLACEMENT, OR REFUND OF THE PURCHASE PRICE PAID, AT POLYCOM'S OPTION. THIS DISCLAIMER OF LIABILITY FOR DAMAGES WILL NOT BE AFFECTED IF ANY REMEDY PROVIDED HEREIN SHALL FAIL OF ITS ESSENTIAL PURPOSE.

Polycom Limited Warranty and Limitation Liability

LIMITED WARRANTY. Polycom warrants to the end user ("Customer") that this product is expected to be free from defects in workmanship and materials, under normal use and service, for one year from the date of purchase from Polycom or its authorized reseller.

Polycom's sole obligation under this express warranty is at Polycom's option and expense, to repair the defective product or part, deliver to Customer an equivalent product or part to replace the defective item, or if neither of the two foregoing options are reasonably available, Polycom may, on its sole discretion, refund to Customer the purchase price paid for the defective product. All products that are replaced will become the property of Polycom. Replacement products or parts may be new or reconditioned.

Polycom is expected to warrant any replaced or repaired product or part for ninety (90) days from shipment, or the remainder of the initial warranty period, whichever is longer. Products returned to Polycom must be sent prepaid and packaged appropriately for safe shipment, and it is recommended that they be insured or sent by a method that provides for tracking of the package. Responsibility for loss or damage does not transfer to Polycom until the returned item is received by Polycom. The repaired or replaced item will be shipped to Customer, at Polycom's expense, not later than thirty (30) days after Polycom receives the defective product, and Polycom will retain risk of loss or damage until the item is delivered to Customer.

The product software comes with 90-day software warranty, providing for software updates (minor releases/bug fixes). To continue to receive support, purchasing a maintenance contract is the most economical solution.

Exclusions

Polycom will not be liable under this limited warranty if its testing and examination disclose that the alleged defect or malfunction in the product does not exist or results from:

- Failure to follow Polycom's installation, operation, or maintenance instructions.

- Unauthorized product modification or alteration.
- Unauthorized use of common carrier communication services accessed through the product.
- Abuse, misuse, negligent acts or omissions of Customer and persons under Customer's control; or
- Acts of third parties, acts of God, accident, fire, lightning, power surges or outages, or other hazards.

Warranty Exclusive

IF A POLYCOM PRODUCT DOES NOT OPERATE AS WARRANTED ABOVE, CUSTOMER'S SOLE REMEDY FOR BREACH OF THAT WARRANTY SHALL BE REPAIR, REPLACEMENT, OR REFUND OF THE PURCHASE PRICE PAID, AT POLYCOM'S OPTION. TO THE FULL EXTENT ALLOWED BY LAW, THE FOREGOING WARRANTIES AND REMEDIES ARE EXCLUSIVE AND ARE IN LIEU OF ALL OTHER WARRANTIES, TERMS, OR CONDITIONS, EXPRESS OR IMPLIED, EITHER IN FACT OR BY OPERATION OF LAW, STATUTORY OR OTHERWISE, INCLUDING WARRANTIES, TERMS, OR CONDITIONS OF MERCHANTABILITY, FITNESS FOR A PARTICULAR PURPOSE, SATISFACTORY QUALITY, CORRESPONDENCE WITH DESCRIPTION, AND NON-INFRINGEMENT, ALL OF WHICH ARE EXPRESSLY DISCLAIMED. POLYCOM NEITHER ASSUMES NOR AUTHORIZES ANY OTHER PERSON TO ASSUME FOR IT ANY OTHER LIABILITY IN CONNECTION WITH THE SALE, INSTALLATION, MAINTENANCE OR USE OF ITS PRODUCTS.

Safety and Compliance

Part 15 FCC Rules

This device is compliant with Part 15 of the FCC Rules. Operation is subject to the following two conditions:

1. This device may not cause harmful interference, and
2. This device must accept any interferences received, including interference that may cause undesired operation.

Class B Digital Device or Peripheral

Note: This equipment is tested and complies with the limits for a Class B digital device, pursuant to Part 15 of the FCC Rules. These limits are designed to provide reasonable protection against harmful interference in a residential installation. This equipment generates, uses, and can radiate radio frequency energy and, if not installed and used in accordance with the instructions, may cause harmful interference to radio communications. However, there is no guarantee that interference will not occur in a particular installation. If this equipment does cause harmful interference to radio or television reception, which can be determined by turning the equipment off and on, the user is encouraged to try to correct the interference by one or more of the following measures:

1. Reorient or relocate the receiving antenna.
2. Increase the separation between the equipment and receiver.
3. Connect the equipment into an outlet on a circuit different from that to which the receiver is connected.
4. Consult the dealer or an experienced radio/TV technician for help.

Modifications

In accordance with Part 15 of the FCC Rules, the user is cautioned that any changes or modifications not expressly approved by Polycom, Inc. could void the user's authority to operate the equipment. This equipment may not be used on a coin service or party line.

Installation Instructions

Installation must be performed in accordance with all relevant national wiring rules.

L'Installation doit être exécutée conformément à tous les règlements nationaux applicable au filage électrique.

Plugs Acts as Disconnect Device

The socket outlet to which this apparatus is connected must be installed near the equipment and must always be readily accessible.

La prise électrique à laquelle l'appareil est branché doit être installée près de l'équipement et doit toujours être facilement accessible.

Industry Canada (IC)

This Class [B] digital apparatus complies with Canadian ICES-003.

Cet appareil numérique de la classe [B] est conforme à la norme NMB-003 du Canada.

CE and VCCI Mark

This SoundPoint IP 321, 331, or 335 SIP is marked with the CE mark. This mark indicates compliance with EEC directives 89/336/EEC and 73/23/EEC. A full copy of the Declaration of Conformity can be obtained from Polycom Ltd., 270 Bath Road, Slough, Berkshire, SL1 4DX, UK.

この装置は、情報処理装置等電波障害自主規制協議会（VCCI）の基準に基づくクラスB情報技術装置です。この装置は、家庭環境で使用することを目的としていますが、この装置がラジオやテレビジョン受信機に近接して使用されると、受信障害を引き起こすことがあります。
取扱説明書に従って正しい取り扱いをして下さい。

Russian Compliance

Ministry of Information Technologies & Communication of the Russian Federation - Declaration of Conformity. DoC # Д-СПД-2950. Expiry 22.06.2012.

Ministry of Information Technologies & Communication of the Russian Federation - Declaration of Conformity. DoC # Д-СПД-2948. Expiry 22.06.2012.

Ministry of Information Technologies & Communication of the Russian Federation - Declaration of Conformity. DoC # Д-СПД-2949. Expiry 22.06.2012.

Ministry of Information Technologies & Communication of the Russian Federation - Declaration of Conformity. DoC # Д-СПД-2947. Expiry 22.06.2012.

GOST-R

Certificate # POCC US.MJ05.B00987. Expiry 21.06.2012.

New Zealand Telepermit

Polycom SoundPoint IP321, 331, and 335 VoIP Telephone PTC 220/08/063

PTC General Warning

The grant of a Telepermit for any item of terminal equipment indicates only that Telecom has accepted that the item complies with minimum conditions for connection to its network. It indicates no endorsement of the product by Telecom, nor does it provide any sort of warranty. Above all, it provides no assurance that any item will work correctly in all respects with another item of Telepermitted equipment of a different make or model, nor does it imply that any product is compatible with all of Telecom's network services.

The Use of IP Networks through the PSTN

Internet Protocol (IP) by its nature introduces delay into speech signals as each data packet is formulated and addressed. Telecom Access Standards recommends that suppliers, designers and installers using this technology for calls to or from the PSTN refer to ITU E Model requirements in the design of their networks. The overall aim is to minimise delay, distortion and other transmission impairments, particularly for those calls involving cellular and international networks, which already suffer extensive delay.

The Use of Voice Compression through the PSTN

Because of the extensive delay already experienced when calling cellular and international networks, some of which is already caused by their use of voice compression technologies. Telecom Access Standards will only approve G711 voice technology for use on the PSTN. G711 is an 'Instantaneous Speech encoding Technique' whereas G729 and all its variants are considered 'Near Instantaneous' introducing additional delay into the speech signal.

Echo Cancellation

Echo cancellers are not normally required in the Telecom PSTN because geographic delays are acceptable where CPE return loss is maintained within Telepermit limits. However, those private networks making use of Voice over IP technology are required to provide echo cancellation for all voice calls. The combined effect of audio / VoIP conversion delay and IP routing delay can cause the echo cancellation time of 64 mS to be required.

Modification of this Polycom SoundPoint IP321, 331, and 335 VoIP Telephone for the New Zealand Network

All samples of Polycom SoundPoint IP321, 331, and 335 VoIP Telephones connected to the Telecom network shall be equipped with the following software batch Rev 3.0.2.0917. Equipped with this software batch the IP telephone is known to comply with the New Zealand speech transmission plan.

End-User License Agreement for Polycom® Software

This End-User License Agreement (“Agreement”) is a legal agreement between you (either an individual or a single entity) and Polycom, B.V for the Polycom Software Product licensed by Polycom B.V in Europe, the Middle East, Africa, and Asia Pacific or Polycom, Inc., for the Polycom Software Product licensed by Polycom, Inc. in the rest of the world (collectively, “Polycom”). The Software Product includes the computer software included herewith and may include associated media, printed materials and online or electronic documentation (“Software Product”). By clicking ‘I agree’ or by installing, copying, or otherwise using the Software Product, you agree to be bound by the terms of this Agreement. If you do not agree to the terms of this Agreement, do not install or use the Software Product, and return it to your place of purchase for a full refund.

The Software Product is protected by copyright laws and international copyright treaties, as well as other intellectual property laws and treaties. The Software Product is licensed (not sold) to you, and its use is subject to the terms of this Agreement.

1. GRANT OF LICENSE.

Subject to the terms of this Agreement, Polycom grants to you a nonexclusive license to install and use the Software Product included with the Polycom product that incorporates or uses the Software Product (the “Product”). You may use the Software Product only in connection with the use of the Product. You are not permitted to lease, rent, distribute or sublicense the Software Product or to use the Software Product in a time-sharing arrangement or in any other unauthorized manner. Further, no license is granted to you in the human readable code of the Software Product (source code). Except as provided below, this License Agreement does not grant you any rights to patents, copyrights, trade secrets, trademarks, or any other rights in respect to the Software Product.

2. DESCRIPTION OF OTHER RIGHTS AND LIMITATIONS.

2.1 Limitations on Reverse Engineering, Decompilation, and Disassembly. You may not reverse engineer, decompile, or disassemble the Software Product, except and only to the extent that such activity is expressly permitted by applicable law notwithstanding this limitation. The Software Product is licensed as a single product. Its component parts may not be separated for use on more than one Product.

2.2 Backup. Except as expressly provided for under this Agreement, you may not copy the Software Product, except, however, you may keep one copy of the Software Product and, if applicable, one copy of any previous version for back-up purposes, only to be used in the event of failure of the original. All copies of the Software Product must be marked with the proprietary notices provided on the original

Software Product. You may not reproduce the supporting documentation accompanying the Software Product.

2.3 Modifications. You may not modify, translate, or create derivative works of the Software Product.

2.4 Proprietary Notices. You may not remove or obscure any proprietary notices on or in the Software Product or the supporting documentation.

2.5 Software Transfer. You may permanently transfer all of your rights under this Agreement provided you retain no copies, you transfer all of the Software Product (including all component parts, the media, any printed materials, any upgrades, this Agreement, and, if applicable, the Certificate of Authenticity), and any recipient agrees to the terms of this Agreement. If the Software Product is an upgrade, any transfer must include all prior versions of the Software Product. However, if the Software Product is marked “Not for Resale” or “NFR,” you may not resell it or otherwise transfer it for value.

2.6 Copyright. All title and copyrights in and to the Software Product (including, but not limited to, any images, photographs, animations, video, audio, music, text, and “applets” incorporated into the Software Product), the accompanying printed materials, and any copies of the Software Product are owned by Polycom or its suppliers. The Software Product is protected by copyright laws and international treaty provisions. Title, ownership rights, and intellectual property rights in the Software Product shall remain in Polycom or its suppliers. Title and related rights in the content accessed through the Software Product is the property of such content owner and may be protected by applicable law. This Agreement gives you no rights in such content.

2.7 Confidentiality. The Software Product contains valuable proprietary information and trade secrets of Polycom and its suppliers and you shall protect the confidentiality of, and avoid disclosure and unauthorized use of, the Software Product.

2.8 Dual-Media Software. You may receive the Software Product in more than one medium. Regardless of the type or size of medium you receive, you may use only one medium that is appropriate for your single Product. You may not use or install the other medium on another Product.

2.9 Reservation. Polycom reserves all rights in the Software Product not expressly granted to you in this Agreement.

3. SUPPORT SERVICES.

Polycom may provide you with support services related to the Software Product (“Support Services”). Use of Support Services is governed by the Polycom policies and programs described in the Polycom-provided materials. Any supplemental software code provided to you as part of the Support Services is considered part of the Software Product and is subject to the terms and conditions of this Agreement. With respect to technical information you provide to Polycom as part of the Support Services, Polycom may use such information for its business purposes, including for product support and development. Polycom will not utilize such technical information in a form that personally identifies you.

4. TERMINATION.

Without prejudice to any other rights, Polycom may terminate this Agreement if you fail to comply with any of the terms and conditions of this Agreement. In such event, you must destroy all copies of the Software Product and all of its component parts. You may terminate this Agreement at any time by destroying the Software Product and all of its component parts.

5. UPGRADES.

If the Software Product is labeled as an upgrade, you must be properly licensed to use the software identified by Polycom as being eligible for the upgrade in order to use the Software Product. A Software Product labeled as an upgrade replaces and/or supplements the software that formed the basis for your eligibility for the upgrade. You may use the resulting upgraded Software Product only in accordance with the terms of this Agreement. If the Software Product is an upgrade of a component of package of software programs that you licensed as a single product, the Software Product may be used and transferred only as part of that single Software Product package and may not be separated for use on more than one Product.

6. WARRANTY AND WARRANTY EXCLUSIONS.

6.1 Limited Warranty. Polycom warrants that (a) the Software Product will perform substantially in accordance with the accompanying documentation for a period of ninety (90) from the date of receipt by you, and (b) any Support Services provided by Polycom shall be substantially as described in applicable written materials provided to you by Polycom, and Polycom support engineers will make commercially reasonable efforts to solve any problem issues. Polycom does not warrant that your use of the Software Product will be uninterrupted or error free, or that all defects in the Software Product will be corrected. Polycom's sole obligation under this express warranty shall be, at Polycom's option and expense, to refund the purchase price paid by you for any defective software product which is returned to Polycom with a copy of your receipt, or to replace any defective media with software which substantially conforms to applicable Polycom published specifications. Any replacement Software Product will be warranted for the remainder of the original warranty period or thirty (30) days, whichever is longer.

6.2 Warranties Exclusive. If this Software Product does not operate as warranted above, your sole remedy for breach of that warranty shall be repair, replacement, or refund of the purchase price paid, at Polycom's option. TO THE FULL EXTENT ALLOWED BY LAW, THE FOREGOING WARRANTIES AND REMEDIES ARE EXCLUSIVE AND ARE IN LIEU OF ALL OTHER WARRANTIES, TERMS OR CONDITIONS, EXPRESS OR IMPLIED, EITHER IN FACT OR BY OPERATION OF LAW, STATUTORY OR OTHERWISE, INCLUDING WARRANTIES, TERMS OR CONDITIONS OF MERCHANTABILITY, FITNESS FOR A PARTICULAR PURPOSE, SATISFACTORY QUALITY, CORRESPONDENCE WITH DESCRIPTION, AND NON-INFRINGEMENT, ALL OF WHICH ARE EXPRESSLY DISCLAIMED. POLYCOM NEITHER ASSUMES NOR AUTHORIZES ANY OTHER PERSON TO ASSUME FOR IT ANY OTHER LIABILITY IN CONNECTION WITH THE SALE, INSTALLATION, MAINTENANCE, OR USE OF THIS SOFTWARE PRODUCT.

POLYCOM SHALL NOT BE LIABLE UNDER THIS WARRANTY IF ITS TESTING AND EXAMINATION DISCLOSE THAT THE ALLEGED DEFECT OR MALFUNCTION IN THE SOFTWARE PRODUCT DOES NOT EXIST OR WAS CAUSED BY YOUR OR ANY THIRD PERSON'S MISUSE, NEGLIGENCE, IMPROPER INSTALLATION OR TESTING, UNAUTHORIZED ATTEMPTS TO MODIFY THE PRODUCT, OR ANY OTHER CAUSE BEYOND THE RANGE OF THE INTENDED USE, OR BY ACCIDENT, FIRE, LIGHTNING, POWER CUTS OR OUTAGES, OTHER HAZARDS, OR ACTS OF GOD.

7. LIMITATION OF LIABILITY.

TO THE MAXIMUM EXTENT PERMITTED BY APPLICABLE LAW, IN NO EVENT SHALL POLYCOM OR ITS SUPPLIERS BE LIABLE FOR ANY SPECIAL, INCIDENTAL, INDIRECT, OR CONSEQUENTIAL DAMAGES WHATSOEVER (INCLUDING, WITHOUT LIMITATION, DAMAGES FOR LOSS OF BUSINESS PROFITS, BUSINESS INTERRUPTION, LOSS OF BUSINESS INFORMATION, OR ANY OTHER PECUNIARY LOSS) ARISING OUT OF THE USE OR INABILITY TO USE THE SOFTWARE PRODUCT OR THE PROVISION OF OR FAILURE TO PROVIDE SUPPORT SERVICES, EVEN IF POLYCOM HAS BEEN ADVISED OF THE POSSIBILITY OF SUCH DAMAGES. IN ANY CASE, POLYCOM'S ENTIRE LIABILITY SHALL BE LIMITED TO THE GREATER OF THE AMOUNT ACTUALLY PAID BY YOU FOR THE SOFTWARE PRODUCT OR U.S. \$5.00; PROVIDED, HOWEVER, IF YOU HAVE ENTERED INTO A POLYCOM SUPPORT SERVICES AGREEMENT, POLYCOM'S ENTIRE LIABILITY REGARDING SUPPORT SERVICES SHALL BE GOVERNED BY THE TERMS OF THAT AGREEMENT.

8. DISCLAIMER.

Some countries, states, or provinces do not allow the exclusion or limitation of implied warranties or the limitation of incidental or consequential damages for certain products supplied to consumers, or the limitation of liability for personal injury, so the above limitations and exclusions may be limited in their application to you. When the implied warranties are not allowed to be excluded in their entirety, they will be limited to the duration of the applicable written warranty. This warranty gives you specific legal rights which may vary depending on local law.

9. EXPORT CONTROLS.

The Software Product may not be downloaded or otherwise exported or re-exported (i) into (or to a national or resident of) Cuba, North Korea, Iran, Syria, Sudan, or any other country to which the U.S. has embargoed goods; or (ii) to anyone on the U.S. Treasury Department's List of Specially Designated Nationals or the U.S. Commerce Department's Table of Denial Orders. By downloading or using this Software Product, you are agreeing to the foregoing and you are representing and warranting that you are not located in, under the control of, or a national or resident of any such country or on any such list. If you obtained this Software Product outside of the United States, you are also agreeing that you will not export or re-export it in violation of the laws of the country in which it was obtained.

10. MISCELLANEOUS.

10.1 Governing Law. This Agreement shall be governed by the laws of the State of California, as such laws are applied to agreements entered into and to be performed entirely within California between California residents, and by the laws of the United States. The United Nations Convention on Contracts

for the International Sale of Goods (1980) is hereby excluded in its entirety from application to this Agreement.

10.2 General. This Agreement represents the complete agreement concerning this license and may amended only by a writing executed by both parties. If any provision of this Agreement is held to be unenforceable, such provision shall be reformed only to the extent necessary to make it enforceable.

10.3 Contact. If you have any questions concerning this Agreement, or if you desire to contact Polycom for any reason, please contact the Polycom office serving your country.

10.4 U.S. Government Restricted Rights. The software and documentation provided by Polycom pursuant to this Agreement are “Commercial Items,” as the term is defined at 48 C.F.R. §2.101, consisting of “Commercial Computer Software” and “Commercial Computer Software Documentation,” as such terms are used in 48 C.F.R. §12.212 or 48 C.F.R. §227.7202, as applicable. Consistent with 48 C.F.R. §12.212 or 48 C.F.R. §§227.7202-1 through 227.7202-4, as applicable, the Commercial Computer Software and Commercial Computer Software Documentation are licensed to United States Government end users (1) only as Commercial Items and (2) with only those rights as are granted to all other users pursuant to the terms of this Agreement.

www.polycom.com

Corporate Headquarters: 4750 Willow Road, Pleasanton, CA 94588,
USA
Phone: 925.924.6000

Israel Office: 94 Derech Em Hamoshavot P.O.B. 3654,
Petach-Tikva 49130, Israel
Phone: +972 3 925 1444
Fax: +972 3 921 1571

Netherlands Office: Tarnspolis Park, Siriusdreef 41, 2132 Wt
Hoofddorp Netherlands
Phone: 31-0-230-2600

Free Manuals Download Website

<http://myh66.com>

<http://usermanuals.us>

<http://www.somanuals.com>

<http://www.4manuals.cc>

<http://www.manual-lib.com>

<http://www.404manual.com>

<http://www.luxmanual.com>

<http://aubethermostatmanual.com>

Golf course search by state

<http://golfingnear.com>

Email search by domain

<http://emailbydomain.com>

Auto manuals search

<http://auto.somanuals.com>

TV manuals search

<http://tv.somanuals.com>