



LUMBERJACK[®]

60/72

TREE CUTTER

Revised 02-02

Effective Serial No. LJ 60-10001 Through Current

P/N 00772058C

Effective Serial No. LJ 72- 10330 Through Current

OPERATOR'S MANUAL



This Operator's Manual is an integral part of the safe operation of this machine and must be maintained with the unit at all times. **READ, UNDERSTAND, and FOLLOW** the Safety and Operation Instructions contained in this manual before operating the equipment. If the Operator's Manual is not with the equipment, contact your local dealer or Servis-Rhino (800-446-5158) to obtain a free copy before operating the equipment. (Some shipping and handling charges may apply)

ATENCIÓN!

LEA EL INSTRUCTIVO

Si No Lee Ingles, Pida Ayuda a Alguien
Que Si Lo Lea Para Que le Traduzca las
Medidas de Seguridad.

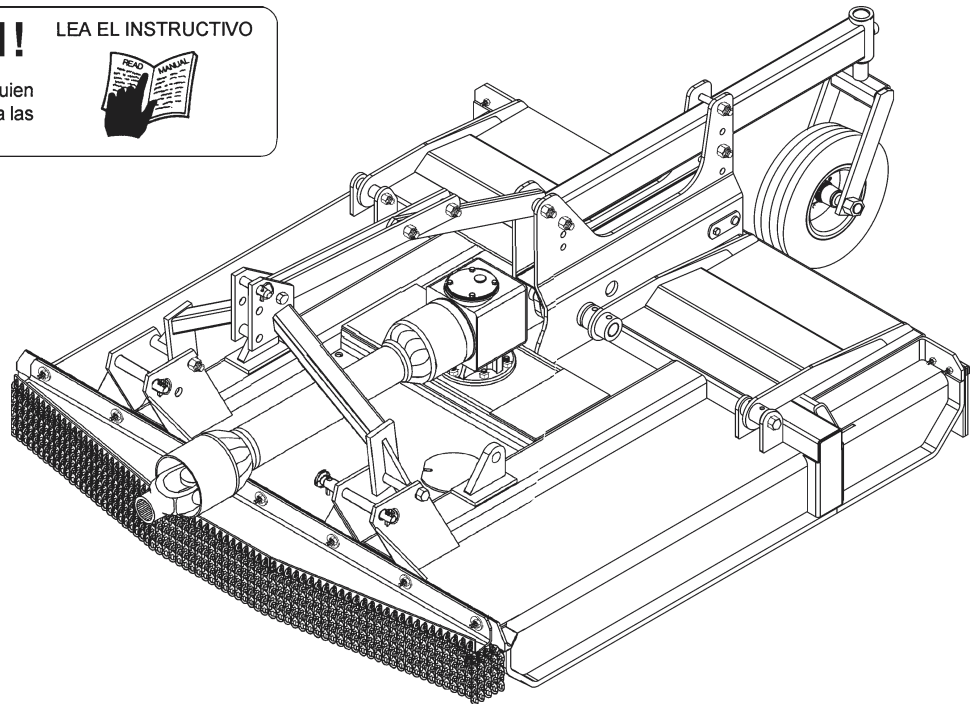

RHINO[®]

1020 S. Sangamon Ave.
Gibson City, IL 60936
800-446-5158

Email: parts@servis-rhino.com

© 2004 Alamo Group Inc.



\$0.00

TO THE OWNER/OPERATOR/DEALER

All implements with moving parts are potentially hazardous. There is no substitute for a cautious, safe-minded operator who recognizes the potential hazards and follows reasonable safety practices. The manufacturer has designed this implement to be used with all its safety equipment properly attached to minimize the chance of accidents.



BEFORE YOU START!!

Read the safety messages on the implement and shown in your manual.
Observe the rules of safety and common sense!

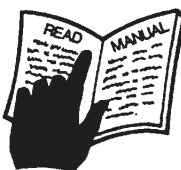

DANGER

FAILING TO FOLLOW SAFETY MESSAGES AND OPERATING INSTRUCTIONS CAN CAUSE SERIOUS BODILY INJURY OR EVEN DEATH TO OPERATOR AND OTHERS IN THE AREA.

<p>1.</p> 	<p>2. NO RIDERS. NO CHILDREN OPERATORS.</p> 	<p>3. USE SAFETY SHOES, HARD HAT, SAFETY GLASSES, SEAT BELTS, ROPS & OPS</p> 	<p>4. BLOCK UP SECURELY BEFORE WORKING UNDER.</p> 
---	---	---	---

1. Study and understand Operator's Manuals, Safety Decals, and Instructional Decals for tractor and implement to prevent misuse, abuse, and accidents. Practice before operating in a confined area or near passersby.
● Learn how to stop engine suddenly in an emergency. Be alert for passersby and especially children

2. Allow no children on or near folding mower or tractor. Allow no riders on tractor or implement. Falling off may cause serious injury or death from being run over by tractor or mower or contact with rotating blades.

3. Operate only with tractor having Roll-Over Protective Structure (ROPS) and with seat belt securely fastened to prevent injury and possible death from falling off or tractor overturn.
● Personal Protective Equipment such as Hard Hat, Safety Glasses, Safety Shoes, & Ear Plugs are recommended.

4. Block up or support raised machine and all lifted components securely before putting hands or feet under or working underneath any lifted component to prevent crushing injury or death from sudden dropping or inadvertent operation of controls. Make certain area is clear before lowering or folding

5. Before transporting, put Lift Lever in detent or full-lift position. Install Transport Safety Devices securely on folding mowers. Put Booms securely in Transport Rest.
● Folding and Boom Mowers have raised center of gravity. Slow down when turning and on hillsides.

6. Make certain that SMV sign, warning lights, and reflectors are clearly visible. Follow local traffic codes.

7. Never operate with Cutting Head or Folding Section raised if passersby, bystanders, or traffic are in the area to reduce possibility of injury or death from objects thrown by Blades under Guards or mower structure.

8. Before dismounting, secure implement in transport position or lower to ground.
● Put tractor in park or set brake, disengage PTO, stop engine, remove key, and wait until noise of rotation has ceased to prevent crushing by entanglement in rotating parts which could cause injury or death.
● Never mount or dismount a moving vehicle. Crushing from runover may cause serious injury or death.

<p>5. TRANSPORT SAFELY, LOCK UP.</p> 	<p>6. USE SMV, LIGHTS, & REFLECTORS.</p> 	<p>7. DO NOT OPERATE WITH CUTTER OR WING RAISED.</p> 	<p>8. DO NOT MOUNT OR DISMOUNT WHILE MOVING.</p> 
--	--	---	--

02067827

WARRANTY INFORMATION:

Read and understand the complete Warranty Statement found in this Manual. Fill out the Warranty Registration Form in full and return it within 30 Days. Make certain the Serial Number of the Machine is recorded on the Warranty Card and on the Warranty Form that you retain. The use of "will-fit" parts will void your warranty and can cause catastrophic failure with possible injury or death.

➤ **BE SAFE!**

➤ **BE ALERT!**

➤ **BE ALIVE!**

➤ **BE TRAINED
before operating
the Mower!**

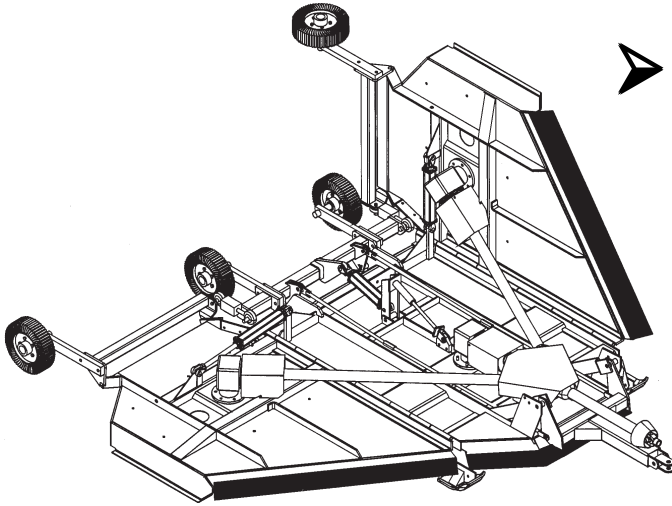

M&W



*Safety Training
Makes the Difference*

In order to reduce accidents and enhance the safe operation of mowers, *Alamo Group Ag Division*, in cooperation with other industry manufacturers has developed the AEM/FEMA Industrial and Agricultural Mower Safety Practices video and guide book.

The video will familiarize and instruct mower-tractor operators in safe practices when using industrial and agricultural mowing equipment. It is important that Every Mower Operator be educated in the operation of their mowing equipment and be able to recognize the potential hazards that can occur while operating a mower. This video, along with the mower operator's manual and the warning messages on the mower, will significantly assist in this important education.

Your Authorized *Alamo Ag Dealer* may have shown this video and presented you a DVD Video when you purchased your mower. If you or any mower operator have not seen this video, **Watch the Video, Read this Operator's Manual, and Complete the Video Guidebook** before operating your new mower. If you do not understand any of the instructions included in the video or operator's manual or if you have any questions concerning safety of operation, contact your supervisor, dealer or *Alamo Group Ag*.

If you would like a VHS video tape of the video, please email AEMVideo@alamo-group.com or Fax AEM VHS Video at (830) 372-9529 or mail in a completed copy of the form on the back of this page to AEM VHS Video 1502 E Walnut Street, Seguin, TX 78155. and request the VHS video version. Please include your name, mailing address, mower model and serial number.

Every operator should be trained for each piece of equipment (Tractor and Mower), understand the intended use, and the potential hazards before operating the equipment.

Alamo Group Ag. Division is willing to provide one (1) AEM Mower Safety Practices Video

- Please Send Me: VHS Format – AEM/FEMA Mower Operator Safety Video
- DVD Format – AEM/FEMA Mower Operator Safety Video
- Mower Operator’s Manual
- AEM Mower Operator’s Safety Manual

Requester Name: _____ Phone: _____

Requester Address: _____

City _____

State _____

Zip Code _____

Mower Model: _____ Serial Number: _____

Date Purchased: _____ Dealer Salesperson: _____

Dealership Name: _____ Dealership Location: _____

Mail to:

AEM Video Services
1502 E Walnut street
Seguin, TX 78155

Or Fax to:

(830) 372-9529

Or Email to:

AEMVideo@alamo-group.com

TABLE OF CONTENTS

SAFETY SECTION	1-1
Safety Information	1-2
Safety Decal Location	1-11
Safety Decals	1-12
Federal Laws And Regulations	1-14
INTRODUCTION SECTION	2-1
ASSEMBLY SECTION.....	3-1
A-Frame Assembly.....	3-2
Gearbox Shield.....	3-3
Driveline Attachment.....	3-3
Front Chainguard Assembly.....	3-5
OPERATION SECTION	4-1
MAINTENANCE SECTION.....	5-1
Lubrication	5-2
Gearbox	5-3
Tail Wheel Assembly	5-3
Driveline	5-4
Blade	5-5
Slip Clutch.....	5-6
Storage	5-8
Recommended Torque	5-8

SAFETY SECTION

SAFETY

A safe and careful operator is the best operator. Safety is of primary importance to the manufacturer and should be to the owner/operator. Most accidents can be avoided by being aware of your equipment, your surroundings, and observing certain precautions. The first section of this manual includes a list of Safety Messages that, if followed, will help protect the operator and bystanders from injury or death. Read and understand these Safety Messages before assembling, operating or servicing this implement. This equipment should only be operated by those persons who have read the Manual, who are responsible and trained, and who know how to do so safely and responsibly.

The Safety Alert Symbol combined with a Signal Word, as seen below, is used throughout this manual and on decals which are attached to the equipment. The Safety Alert Symbol means: **“ATTENTION! BECOME ALERT! YOUR SAFETY IS INVOLVED!”** The Symbol and Signal Word are intended to warn the owner/operator of impending hazards and the degree of possible injury faced when operating this equipment..

Practice all usual and customary safe working precautions and above all---remember safety is up to YOU. Only YOU can prevent serious injury or death from unsafe practices.

CAUTION!

The lowest level of Safety Message; warns of possible injury. Decals located on the Equipment with this Signal Word are Black and Yellow.



WARNING!

Serious injury or possible death! Decals are Black and Orange.



DANGER!

Imminent death/critical injury. Decals are Red and White. (SG-1)



READ, UNDERSTAND, and FOLLOW the following Safety Messages. Serious injury or death may occur unless care is taken to follow the warnings and instructions stated in the Safety Messages. Always use good common sense to avoid hazards.

(SG-2)

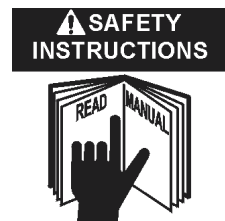

SAFETY

PELIGRO!



Si no lee Ingles, pida ayuda a alguien que si lo lea para que le traduzca las medidas de seguridad. (SG-3)

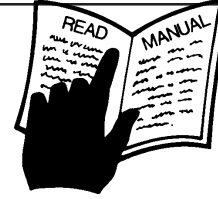

¡LEA EL INSTRUCTIVO!

DANGER!



Never operate the Tractor or Implement until you have read and completely understand this Manual, the Tractor Operator's Manual, and each of the Safety Messages found in the Manual or on the Tractor and Implement. Learn how to stop the tractor engine suddenly in an emergency. Never allow inexperienced or untrained personnel too operate the Tractor and Implement without supervision. Make sure the operator has fully read and understood the manuals prior to operation. (SG-4)

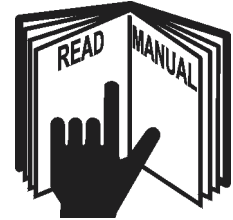

WARNING!



Always maintain the safety decals in good readable condition. If the decals are missing, damaged, or unreadable, obtain and install replacement decals immediately. (SG-5)

WARNING!



Make certain that the "Slow Moving Vehicle" (SMV) sign is installed in such a way as to be clearly visible and legible. When transporting the Equipment use the Tractor flashing warning lights and follow all local traffic regulations. (SG-6)



WARNING!



Operate this Equipment only with a Tractor equipped with an approved roll-over-protective system (ROPS). Always wear seat belts. Serious injury or even death could result from falling off the tractor--particularly during a turnover when the operator could be pinned under the ROPS. (SG-7)



WARNING!



Do not modify or alter this Implement. Do not permit anyone to modify or alter this Implement, any of its components or any Implement function. (SG-8)

DANGER!



BEFORE leaving the tractor seat, always engage the brake and/or set the tractor transmission in parking gear, disengage the PTO, stop the engine, remove the key, and wait for all moving parts to stop. Place the tractor shift lever into a low range or parking gear to prevent the tractor from rolling. Never dismount a Tractor that is moving or while the engine is running. Operate the Tractor controls from the tractor seat only. (SG-9)

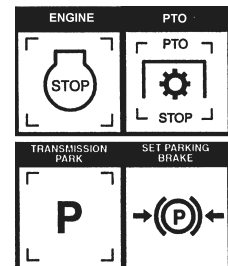

DANGER!



Never allow children or other persons to ride on the Tractor or Implement. Falling off can result in serious injury or death. (SG-10)



SAFETY

SAFETY

DANGER!



Never allow children to operate or ride on the Tractor or Implement. (SGM-11)



WARNING!



Do not mount the Tractor while the tractor is moving. Mount the Tractor only when the Tractor and all moving parts are completely stopped. (SG-12)



DANGER!



Start tractor only when properly seated in the Tractor seat. Starting a tractor in gear can result in injury or death. Read the Tractor operators manual for proper starting instructions. (SG-13)



DANGER!



Never work under the Implement, the framework, or any lifted component unless the Implement is securely supported or blocked up to prevent sudden or inadvertent falling which could cause serious injury or even death. (SG-14)



DANGER!



Do not operate this Equipment with hydraulic oil leaking. Oil is expensive and its presence could present a hazard. Do not check for leaks with your hand! Use a piece of heavy paper or cardboard. High-pressure oil streams from breaks in the line could penetrate the skin and cause tissue damage including gangrene. If oil does penetrate the skin, have the injury treated immediately by a physician knowledgeable and skilled in this procedure. (SG-15)



WARNING!



The operator and all support personnel should wear hard hats, safety shoes, safety glasses, and proper hearing protection at all times for protection from injury including injury from items thrown by the equipment. (SG-16)

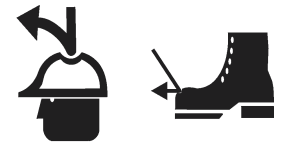

CAUTION!



PROLONGED EXPOSURE TO LOUD NOISE MAY CAUSE PERMANENT HEARING LOSS! Tractors with or without an Implement attached can often be noisy enough to cause permanent hearing loss. We recommend that you always wear hearing protection if the noise in the Operator's position exceeds 80db. Noise over 85db over an extended period of time will cause severe hearing loss. Noise over 90db adjacent to the Operator over an extended period of time will cause permanent or total hearing loss. *Note:* Hearing loss from loud noise [from tractors, chain saws, radios, and other such sources close to the ear] is cumulative over a lifetime without hope of natural recovery. (SG-17)



SAFETY

WARNING!



Transport only at safe speeds. Serious accidents and injuries can result from operating this equipment at unsafe speeds. Understand the Tractor and Implement and how it handles before transporting on streets and highways. Make sure the Tractor steering and brakes are in good condition and operate properly.

Before transporting the Tractor and Implement, determine the safe transport speeds for you and the equipment. Make sure you abide by the following rules:

1. Test the tractor at a slow speed and increase the speed slowly. Apply the Brakes smoothly to determine the stopping characteristics of the Tractor and Implement. As you increase the speed of the Tractor the stopping distance increases. Determine the maximum safe transport speed for you and this Equipment.
2. Test the equipment at a slow speed in turns. Increase the speed through the turn only after you determine that it is safe to operate at a higher speed. Use extreme care and reduce your speed when turning sharply to prevent the tractor and implement from turning over. Determine the maximum safe turning speed for you and this equipment before operating on roads or uneven ground.
3. Only transport the Tractor and Implement at the speeds that you have determined are safe and which allow you to properly control the equipment.

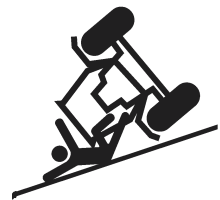

SAFETY

Be aware of the operating conditions. Do not operate the Tractor with weak or faulty brakes. When operating down a hill or on wet or rain slick roads, the braking distance increases: use extreme care and reduce your speed. When operating in traffic always use the Tractor's flashing warning lights and reduce your speed. Be aware of traffic around you and watch out for the other guy. (SG-19)

WARNING!



Never attempt to lubricate, adjust, or remove material from the Implement while it is in motion or while tractor engine is running. Make sure the tractor engine is off before working on the Implement. (SG-20)



WARNING!



Periodically inspect all moving parts for wear and replace when necessary with authorized service parts. Look for loose fasteners, worn or broken parts, and leaky or loose fittings. Make sure all pins have cotter pins and washers. Serious injury may occur from not maintaining this machine in good working order. (SG-21)



WARNING!



Always read carefully and comply fully with the manufacturers instructions when handling oil, solvents, cleansers, and any other chemical agent. (SG-22)



DANGER!



Never run the tractor engine in a closed building or without adequate ventilation. The exhaust fumes can be hazardous to your health. (SG-23)

LJ60/72 02-02

Safety Section 1-5

SAFETY

SAFETY

DANGER!



KEEP AWAY FROM ROTATING ELEMENTS to prevent entanglement and possible serious injury or death. (SG-24)



DANGER!



Never allow children to play on or around Tractor or Implement. Children can slip or fall off the Equipment and be injured or killed. Children can cause the Implement to shift or fall crushing themselves or others. (SG-25)

WARNING!



Do not exceed the rated PTO speed for the Implement. Excessive PTO speeds can cause Implement driveline or blade failures resulting in serious injury or death. (SG-26)

DANGER!



NEVER use drugs or alcohol immediately before or while operating the Tractor and Implement. Drugs and alcohol will affect an operator's alertness and coordination and therefore affect the operator's ability to operate the equipment safely. Before operating the Tractor or Implement, an operator on prescription or over-the-counter medication must consult a medical professional regarding any side effects of the medication that would hinder their ability to operate the Equipment safely. **NEVER** knowingly allow anyone to operate this equipment when their alertness or coordination is impaired. Serious injury or death to the operator or others could result if the operator is under the influence of drugs or alcohol. (SG-27)



DANGER!



Operate the Tractor and/or Implement controls only while properly seated in the Tractor seat with the seat belt securely fastened around you. Inadvertent movement of the Tractor or Implement may cause serious injury or death. (SG-29)

WARNING!



Mow only in conditions where you have clear visibility in daylight or with adequate artificial lighting. Never mow in darkness or foggy conditions where you cannot clearly see at least 100 yards in front and to the sides of the tractor and mower. Make sure that you can clearly see and identify passersby, steep slopes, ditches, drop-offs, overhead obstructions, power lines, debris and foreign objects. If you are unable to clearly see this type of items discontinue mowing. (SGM-1)

DANGER!



There are obvious and hidden potential hazards in the operation of this Mower. **REMEMBER!** This machine is often operated in heavy brush and in heavy weeds. The Blades of this Mower can throw objects if shields are not properly installed and maintained. Serious injury or even death may occur unless care is taken to insure the safety of the operator, bystanders, or passersby in the area. Do not operate this machine with anyone in the immediate area. Stop mowing if anyone is within 100 yards of mower. (SGM-2)



SAFETY

DANGER!



All Safety Shields, Guards and Safety devices including (but not limited to) - the Deflectors, Chain Guards, Steel Guards, Gearbox Shields, Hydraulic Tank Shields, and Retractable Door Shields should be used and maintained in good working condition. All safety devices should be inspected carefully at least daily for missing or broken components. Missing, broken, or worn items must be replaced at once to reduce the possibility of injury or death from thrown objects, entanglement, or blade contact. (SGM-3)

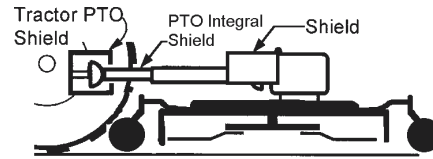

DANGER!



The rotating parts of this machine have been designed and tested for rugged use. However, they could fail upon impact with heavy, solid objects such as steel guard rails and concrete abutments. Such impact could cause the broken objects to be thrown outward at very high velocities. To reduce the possibility of property damage, serious injury, or even death, never allow the cutting blades to contact such obstacles. (SGM-4)

WARNING!



Extreme care should be taken when operating near loose objects such as gravel, rocks, wire, and other debris. Inspect the area before mowing. Foreign objects should be removed from the site to prevent machine damage and/or bodily injury or even death. Any objects that cannot be removed must be clearly marked and carefully avoided by the operator. Stop mowing immediately if blades strike a foreign object. Repair all damage and make certain rotor or blade carrier is balanced before resuming mowing. (SGM-5)



WARNING!



Many varied objects, such as wire, cable, rope, or chains, can become entangled in the operating parts of the mower head. These items could then swing outside the housing at greater velocities than the blades. Such a situation is extremely hazardous and could result in serious injury or even death. Inspect the cutting area for such objects before mowing. Remove any like object from the site. Never allow the cutting blades to contact such items. (SGM-6)

WARNING!



Mow at the speed that you can safely operate and control the tractor and mower. Safe mowing speed depends on terrain condition and grass type, density, and height of cut. Normal ground speed range is from 0 to 5 mph. Use slow mowing speeds when operating on or near steep slopes, ditches, drop-offs, overhead obstructions, power lines, or when debris and foreign objects are to be avoided. (SGM-7)

WARNING!



Avoid mowing in reverse direction when possible. Check to make sure there are no persons are behind the mower and use extreme care when mowing in reverse. Mow only at a slow ground speed where you can safely operate and control the tractor and mower. Never mow an area in the reverse direction that you have not inspected and removed debris or foreign material. (SGM-8)

WARNING!



Do not put hands or feet under mower decks. Blade Contact can result serious injury or even death. (SGM-9)



SAFETY

SAFETY

DANGER!



Replace bent or broken blade with new blades. NEVER ATTEMPT TO STRAIGHTEN BLADES SINCE THIS WILL LIKELY CRACK OR OTHERWISE DAMAGE THE BLADE WITH SUBSEQUENT FAILURE AND POSSIBLE SERIOUS INJURY FROM THROWN BLADES. (SGM-10)

WARNING!



Do not mow with two machines in the same area except with Cab tractors with the windows closed. (SGM-11)

DANGER!



Rotary Mowers are capable under adverse conditions of throwing objects for great distances (100 yards or more) and causing serious injury or death. Follow safety messages carefully



STOP MOWING IF PASSERSBY ARE WITHIN 100 YARDS UNLESS:

- Front and Rear Deflectors, Chain Guards, or Bands are installed and in good, workable condition;
- Mower sections or Wings are running close to and parallel to the ground without exposed Blades;
- Passersby are outside the existing thrown-object zone;
- All areas have been thoroughly inspected and all foreign material such as rocks, cans, glass, and general debris has been removed.

NOTE: Where there are grass and weeds high enough to hide debris that could be struck by the blades, the area should be: inspected and large debris removed, mowed at an intermediate height, inspected, closely with any remaining debris being removed, and mowed again at desired final height. (This will also reduce power required to mow, reduce wear and tear on the Mower drivetrain, spread cut material better, eliminate streaking, and make the final cut more uniform.) (SRM-1)

WARNING!



Do not let the Blades turn when the Mower Deck is raised for any reason, including clearance or for turning. Raising the Mower deck exposes the Cutting Blades which creates a potentially serious hazard and could cause serious injury or even death from objects thrown from the Blades. (SRM-7)

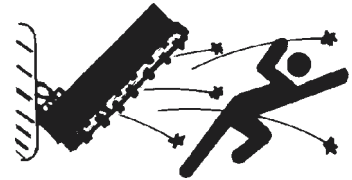

WARNING!



Never leave Tractor and Implemented unattended while the implement is in the lifted position. Accidental operation of lifting lever or a hydraulic failure may cause sudden drop of unit with injury or death by crushing. To properly park the implement when disconnecting it from the tractor, lower the stand and put the retaining pin securely in place, or put a secure support under the A-Frame. Lower the implement carefully to the ground. Do not put hands or feet under lifted components. (S3PT-1)

WARNING!



Be particularly careful when transporting the Implement with the Tractor. Turn curves or go up hills only at a low speed and using a gradual steering angle. Rear mounted implements move the center of gravity to the rear and remove weight from the front wheels. Make certain, by adding front ballast, that at least 20% of the tractor's weight is on the front wheels to prevent rearing up, loss of steering control or Tractor tip-over. Slow down on rough or uneven surfaces to prevent loss of steering control which could result in property damage or possible injury. Do not transport unless 3-Point lift lever is fully raised and in the latched transport position. Dropping implement in transport can cause serious damage to the tractor and/or Implement and possibly cause the operator or others to be injured or killed. (S3PT-2)

SAFETY

DANGER!



There are obvious and hidden potential hazards in the operation of this Implement as in all power-driven or pulled equipment. **REMEMBER!** This machine is often operated in rough terrain conditions that include tall grass, weeds, gullies, holes, slopes, hidden obstructions and the like. Serious injury or even death may occur unless care is taken to assure the safety of the operator and bystanders in the area. Do not operate this machine with anyone in the immediate area. (S3PT-7)

DANGER!



Make sure the PTO shield is installed when using PTO-driven equipment. Always replace the PTO shield if it is damaged or missing. (S3PT-8)



WARNING!



Relieve hydraulic pressure prior to doing any maintenance or repair work on the Implement. Place the Implement on the ground or securely blocked up, disengage the PTO, and turn off the tractor engine. Push and pull the Remote Cylinder lever in and out several times prior to starting any maintenance or repair work. (S3PT-9)



WARNING!



The rotating parts of this machine continue to rotate even after the PTO has been turned off. The operator should remain in his seat for 60 seconds after the brake has been set, the PTO disengaged, the tractor turned off, and all evidence of rotation has ceased. (S3PT-10)

“Wait a minute...Save a life!”

DANGER!



Always disconnect the main PTO Driveline from the Tractor before performing service on the Implement. Never work on the Implement with the tractor PTO driveline connected and running. Rotating Parts, Blades or Drivelines could turn without warning and cause immediate entanglement, injury or death. (S3PT-11)

DANGER!



This Implement is wider than the Tractor. Be careful when operating or transporting this equipment to prevent the Implement from running into or striking sign posts, guard rails, concrete abutments or other solid objects. Such an impact could cause the Implement and Tractor to pivot violently resulting in loss of steering control, serious injury, or even death. Never allow the Implement to contact obstacles. (S3PT-12)

SAFETY

SAFETY

WARNING!



Follow these guidelines to reduce the risk of equipment and grass fires while operating, servicing, and repairing the Mower and Tractor:

- Equip the Tractor with a fire extinguisher in an accesible location.
- Do Not operate the Mower on a Tractor with an underframe exhaust.
- Do Not smoke or have an open flame near the Mower and Tractor.
- Do Not drive into burning debris or freshly burnt areas.
- Ensure slip clutches are properly adjusted to prevent excessive slippage and plate heating.
- Never allow clippings or debris to collect near drivelines, slip clutches, and gearboxes. Periodically shut down the Tractor and Mower and clean clippings and collected debris from the mower deck. (SGM-12)



WARNING!



Do not mow with two machines in the same area except with Cab tractors with the windows closed. (SGM-11)

DANGER!



Replace bent or broken blade with new blades. NEVER ATTEMPT TO STRAIGHTEN OR WELD ON BLADES SINCE THIS WILL LIKELY CRACK OR OTHERWISE DAMAGE THE BLADE WITH SUBSEQUENT FAILURE AND POSSIBLE SERIOUS INJURY FROM THROWN BLADES. (SGM-10)

In addition to the design and configuration of this Implement, including Safety Signs and Safety Equipment, hazard control and accident prevention are dependent upon the awareness, concern, prudence, and proper training of personnel involved in the operation, transport, maintenance, and storage of the machine. Refer also to Safety Messages and operation instruction in each of the appropriate sections of the Tractor and Equipment Manuals. Pay close attention to the Safety Signs affixed to the Tractor and Equipment. (SG-18)

PARTS INFORMATION

Servis-Rhino mowers use balanced and matched system components for blade carriers, blades, cuttershafts, knives, knife hangers, rollers, drivetrain components, and bearings. These parts are made and tested to Servis-Rhino specifications. Non-genuine "will fit" parts do not consistently meet these specifications. The use of "will fit" parts may reduce mower performance, void mower warranties, and present a safety hazard. Use genuine Servis-Rhino mower parts for economy and safety. (SPRM-1)

SEE YOUR SERVIS-RHINO DEALER

SAFETY

SAFETY

NOTE: Rhino supplies safety decals on this product to promote safe operation. Damage to the decals may occur while in shipping, use, or reconditioning. Rhino cares about the safety of its customers, operators, and bystanders, and will replace the safety decals on this product in the field, free of charge (Some shipping and handling charges may apply). Contact your Rhino dealer to order replacement decals.

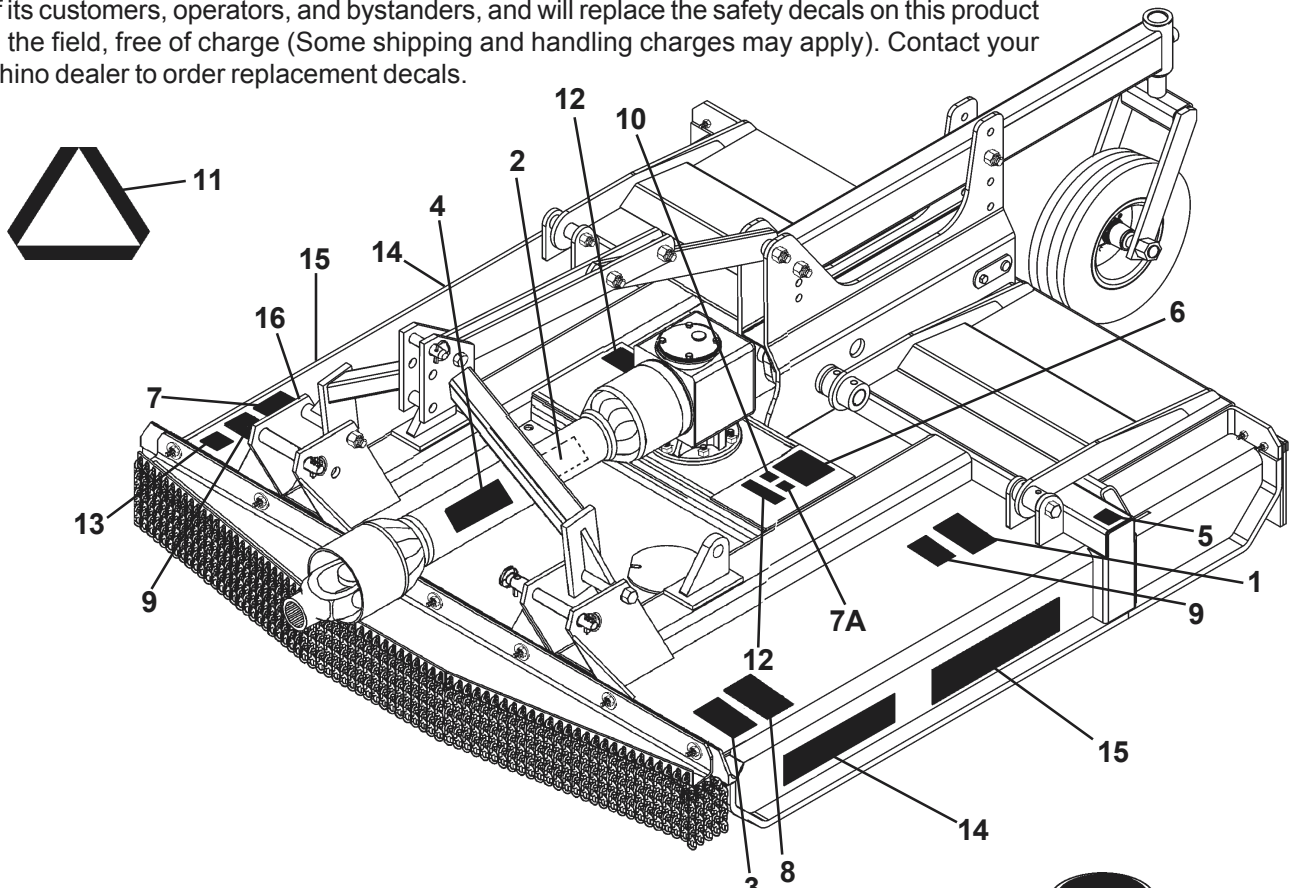

ITEM	PART NO.	QTY	LEVEL	DESCRIPTION
1	00749117	1	DANGER	Multi-Hazard
2	00756004	(*1)	DANGER	D/L Shield missing
3	00725746	1	PELIGRO	Translate Safety Material
4	00756005	(*1)	DANGER	Rotating Driveline
5	02962764	2	DANGER	Pinch Point
6	00756494	(1)	DANGER	Driveline Hazards
7	00760657	1	IMPORTANT	Genuine Rhino Parts
7A	00773723	1	PELIGRO	Rotating Driveline Translation
8	00769736	1	WARNING	Use/Repair Shields & Guards
9	00769737	2	DANGER	Blades/Thrown Objects
10	D103	[(1)]	WARNING	540 RPM Operation
	D114	[(1)]	WARNING	1000 RPM Operation
11	03200347	*1	REFLECT	SMV Emblem
12	00763613	(1)	INSTRUCT	Slip Clutch Adjustment
13	00763977	1	INSTRUCT	Notice To Owner
14	D303	2	DECAL	Rhino
15	00771818	2	DECAL	Lumberjack
16	NFS	1	SRLPLT	Serial Plate
17	00756059	1	DECAL	Oil Leak
18	00776481	1	INSTRUCT	Operators Manual Inside (Decal)
19	00776031	1	-----	Canister, Operators Manual
20	00772058C	1	-----	Operators Manual
21	10058000	3	-----	Bolt
22	00024100	6	-----	Flatwasher
23	02959924	3	-----	Locknut

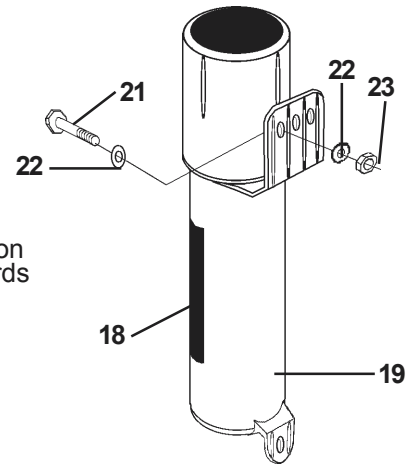

* Furnished by Supplying Manufacturer
 [()] Select one or the other on Mech Models only
 () Mechanical Models Only
 [] Select one or the other

SAFETY

SAFETY



2 - 00756004



4 - 00756005

1 - - 00749117 - Not Shown
(See Inside Front Cover of Manual)
11 - - 03200347 SMV Reflector



3 - 00725746

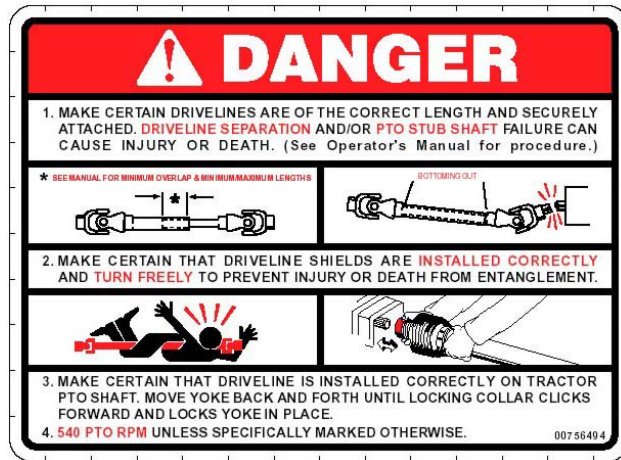

6 - 00756494



7 - 00760657

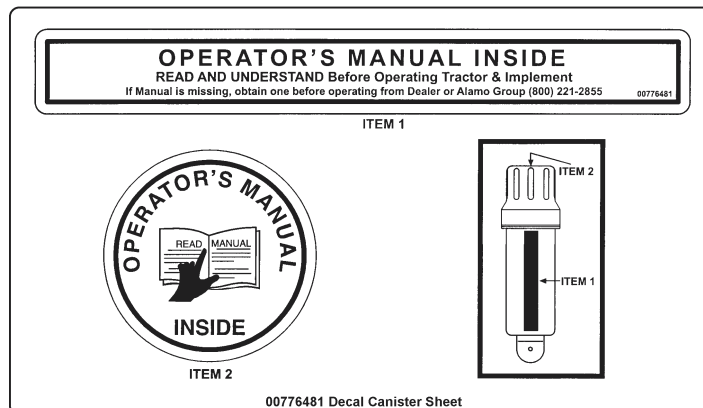

18 - 00776481

SAFETY

WARNING

PINCH POINTS

02962764

5 - 02962764



14 - D303

WARNING

OPERATE THIS MACHINE AT 540 RPM TRACTOR PTO SPEED ONLY

Overspeeding PTO may cause component failure with resulting injury. D103

10 - D103

WARNING

FAILURE TO USE AND MAINTAIN SHIELDS AND DEFLECTORS IN GOOD CONDITION MAY LEAD TO INJURY OR DEATH FROM ENTANGLEMENT WITH ROTATING PARTS, BEING HIT BY OBJECTS THROWN WITH GREAT FORCE BY BLADES, OR BY BLADE CONTACT.

- Always replace Guards which have been removed for maintenance. Never operate with Guards missing or broken.
- Chain Guards, Gearbox & Driveline Shields, Rubber-Fabric Deflectors, and Solid Band Enclosures are subject to wear and lost or broken parts and must be repaired or replaced as soon as damage is found.
- Safety Shielding must be installed and in good condition to reduce the possibility of thrown objects any time this machine is operated in any area where thrown objects could cause property damage or bodily injury.

ROTARY 00769736

8 - 00769736

WARNING

OPERATE THIS MACHINE AT 1000 RPM TRACTOR PTO SPEED ONLY

Overspeeding PTO may cause component failure with resulting injury. D114

10 - D114

ATTENTION

Do not operate PTO until All Slip Clutches are properly adjusted and checked to make certain that **NONE ARE FROZEN** and that **ALL WILL SLIP** under excessive load. See Operator's Manual for complete instructions.

00763613

12 - 00763613

NOTICE TO OWNER

An OPERATOR'S MANUAL (with Repair Parts Listing) and a WARRANTY REGISTRATION CARD were attached to this implement during final inspection at the factory. If they were not attached at the time of purchase, please contact your selling dealer at once.

1. Read and understand Manual before operating the implement.
2. Complete, sign, and mail the Warranty Registration Card in today.

00763977

13 - 00763977

DANGER

KEEP AWAY - THROWN OBJECTS

- Inspect the area before mowing for potential mower hazards. Remove or avoid all foreign objects such as wire, cable, metal objects, and all other foreign material.
- Foreign material can be thrown from the mower and cause serious bodily injury to the operator and passersby.

- Do Not let rotating blades contact solid objects like rocks, posts, curbs or guard rails.

- Operate only if all Guards-Deflectors are in place and in good condition.
- Do Not operate with Mower or Wing raised off the ground.
- Stop mowing if Passersby enter the area of thrown objects. (See Operator's Manual)

- Stay away from rotating blades. Keep hands and feet away from rotating blades.
- Do Not approach mower until all motion has stopped.

00769737

9 - 00769737

PELIGRO

Un manual de la seguridad de la línea de conducción n/p 00773776 está disponible en español. Llame el número enumerado para una copia gratis.

LÍNEA DE CONDUCCIÓN GIRATORIA- EL CONTACTO PUEDE CAUSAR LA MUERTE ¡MANTENERSE LEJOS! NO FUNCIONE SIN QUE-

- Todos los protectores de la línea de conducción, alimentador y blindajes del equipo estén en su lugar.
- Las líneas de conducción estén conectadas con seguridad en ambos extremos.
- Los protectores de la línea de conducción den vuelta libremente en la línea de conducción.

00773723

7A - 00773723

LUMBERJACK

15 - 00771818

SAFETY

SAFETY

FEDERAL LAWS AND REGULATIONS

This section is intended to explain in broad terms the concept and effect of federal laws and regulations concerning employer and employee equipment operators. This section is not intended as a legal interpretation of the law and should not be considered as such.

Employer-Employee Operator Regulations

U.S. Public Law 91-596 (The Williams-Steiger Occupational and Health Act of 1970) OSHA

This Act Seeks:

"...to assure so far as possible every working man and woman in the nation safe and healthful working conditions and to preserve our human resources..."

DUTIES

Sec. 5 (a) Each employer-

(1) shall furnish to each of his employees employment and a place of employment which are free from recognized hazards that are causing or are likely to cause death or serious physical harm to his employees;

(2) shall comply with occupational safety and health standards promulgated under this Act.

(b) Each employee shall comply with occupational safety and health standards and all rules, regulations and orders issued pursuant to this Act which are applicable to his own actions and conduct.

OSHA Regulations

OSHA regulations state in part: "At the time of initial assignment and at least annually thereafter, the employer shall instruct every employee in the safe operation and servicing of all equipment with which the employee is, or will be involved."

Employer Responsibilities:

To ensure employee safety during Tractor and Implement operation, it is the employer's responsibility to:

1. Train the employee in the proper and safe operation of the Tractor and Implement.
2. Require that the employee read and fully understand the Tractor and Implement Operator's manual.
3. Permit only qualified and properly trained employees to operate the Tractor and Implement.
4. Maintain the Tractor and Implement in a safe operational condition and maintain all shields and guards on the equipment.
5. Ensure the Tractor is equipped with a functional ROPS and seat belt and require that the employee operator securely fasten the safety belt and operate with the ROPS in the raised position at all times.
6. Forbid the employee operator to carry additional riders on the Tractor or Implement.
7. Provide the required tools to maintain the Tractor and Implement in a good safe working condition and provide the necessary support devices to secure the equipment safely while performing repairs and service.
8. Require that the employee operator stop mowing if bystanders or passerbys come within 100 yards.

Child Labor Under 16 Years of Age

Some regulations specify that no one under the age of 16 may operate power machinery. It is your responsibility to know what these regulations are in your own area or situation. (Refer to U.S. Dept. of Labor, Employment Standard Administration, Wage & Home Division, Child Labor Bulletin #102.)



Safety Manual

*For Operators
and Mechanics*

Industrial/ Agricultural Mower

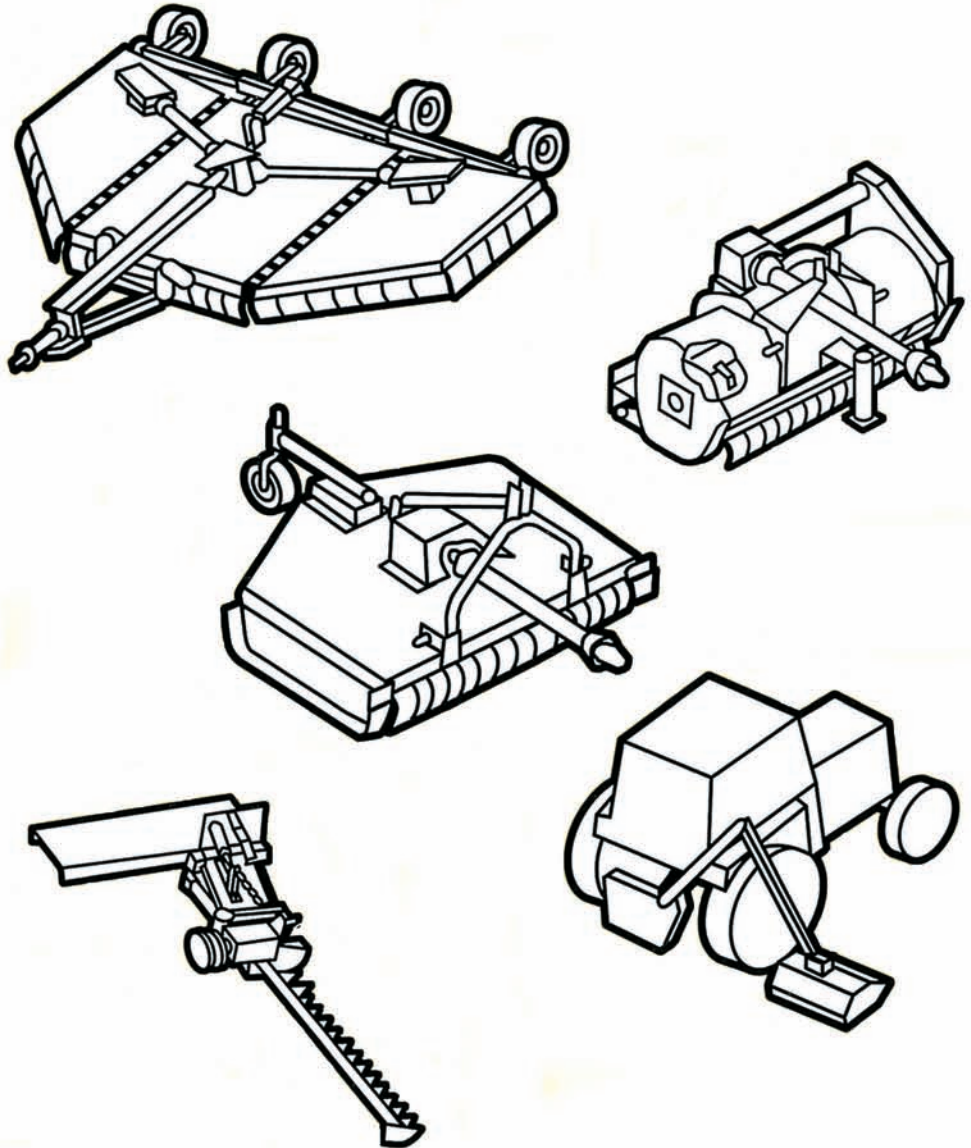

111 E. Wisconsin Avenue • Milwaukee, Wisconsin 53202 U.S.A.
www.aem.org

Contents

Acknowledgement	2
Forward	3
A Word to the User	3
Safety Alert Symbol	4
Industrial/Agricultural Mower Types	4
Be a Responsible Operator	5
Safety Management of Hazards and Risks	6
Follow a Safety Program	11
Safety-Before Operation	11
Safety-Starting and Testing	13
Safety-During Operation	14
Safety-During Shutdown	18
Safety-During Maintenance	19
One Final Word	21

Acknowledgement

We wish to acknowledge the contributions of the members of the Association of Equipment Manufacturers to the preparation of this Safety Manual.

Copyright
© 2000 AEM (formerly Equipment Manufacturers Institute). Revised 08.2003. All rights reserved.

Forward

This Safety Manual is intended to point out some of the basic safety situations which may be encountered during the normal operation and maintenance of your machine and to suggest possible ways of dealing with these conditions. This manual is NOT a substitute for the manufacturer's manual(s).

Additional precautions may be necessary, or some instructions may not be applicable, depending on the equipment, attachment devices, and conditions at the worksite or in the service area. The manufacturer has no direct control over machine application, operation, inspection, lubrication, or maintenance. Therefore, it is **YOUR** responsibility to use good safety practices in these areas.

The information provided in this manual supplements the specific information about your machine that is contained in the manufacturer's manual(s). Other information which may affect the safe operation of your machine may be contained on safety signs or in insurance requirements, employer's safety and training programs, safety codes, local, state/provincial and national laws, rules and regulations.

IMPORTANT: *If you do not have the manufacturer's manual(s) for your particular machine, get a replacement manual from your employer, equipment dealer, or the manufacturer of your machine. Keep this safety manual and the manufacturer's manual(s) with your machine.*

A Word to the User

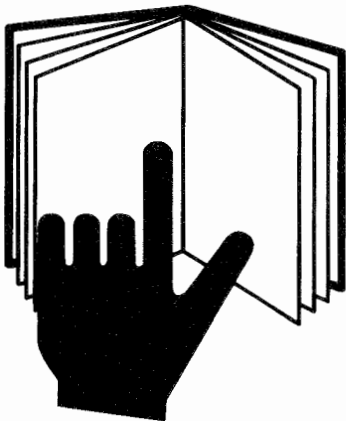

It is your responsibility to read and understand this safety manual and the manufacturer's manual(s) before operating this machine. This safety manual takes you step-by-step through your working day. The safety manual, manufacturer's manual(s), safety signs (decals) and safety precautions must be explained to those users or operators who cannot read the material.

In addition to equipment design and configuration, **HAZARD CONTROL** and **ACCIDENT PREVENTION** are dependent upon the owner's and operator's awareness, concern, prudence, and proper training in the operation, transport, maintenance and storage of equipment.

Remember that **YOU** are the key to safety. Good safety practices not only protect you but also protect the people around you. Study this manual and the manufacturer's manual(s) for your specific machine. Make them a working part of your safety program. Keep in mind that this safety manual is written only for industrial and agricultural mowers.

Practice all usual and customary safe working precautions and above all – remember safety is up to YOU. Only YOU can prevent serious injury or death from unsafe practices.

Safety Alerts

Symbol

This Safety Alert Symbol means:

**“ATTENTION! BECOME ALERT!
YOUR SAFETY IS INVOLVED!”**

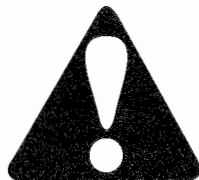

The Safety Alert Symbol identifies important safety messages on equipment, safety signs, in manuals or elsewhere. When you see this symbol, be alert to the possibility of death or personal injury. Follow the instructions in the safety message.

Signal Words

Signal words are distinctive words that will typically be found on safety decals on this equipment or other equipment on the worksite. These words are intended to alert the viewer to the existence and relative degree of a hazard.



This signal word indicates an imminently hazardous situation which, not avoided, will result in death or serious injury.



This signal word indicates a potentially hazardous situation which, if not avoided, could result in death or serious injury.



This signal word indicates a potentially hazardous situation exists which, if not avoided, may result in minor or moderate injury.

- ACCIDENTS DISABLE AND KILL.
- ACCIDENTS COST.
- ACCIDENTS CAN BE AVOIDED.

Industrial/Agricultural Mowers

A mower for pasture clipping, crop residue shredding, heavy brush cutting for land clearing, waterways, right-of-ways, road side or highway mowing.

INDUSTRIAL/AGRICULTURAL MOWER TYPES:

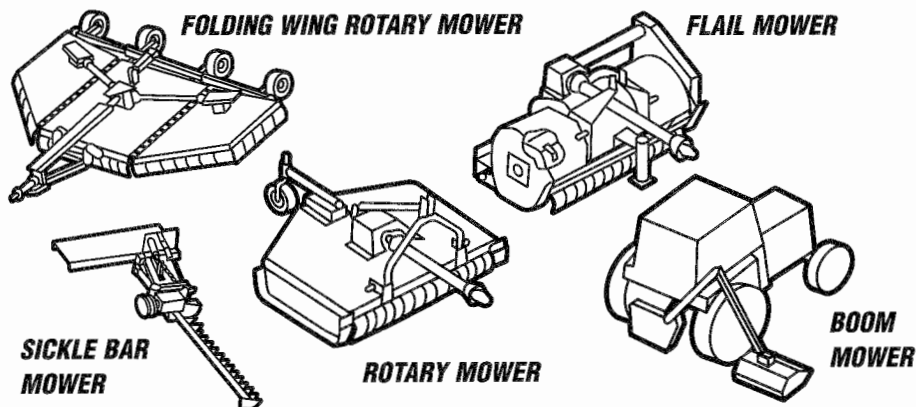

Be a Responsible Operator



DON'T
Drink & Drive



DON'T
Take
Drugs & Drive

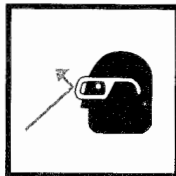
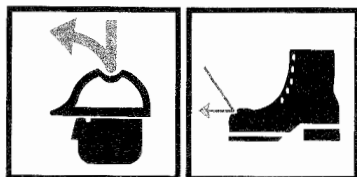

PROTECT
Yourself



CALL
For Assistance

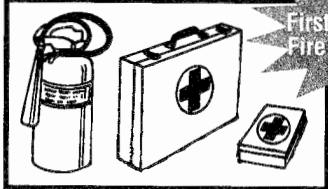

LOCATE
First Aid Kits and
Fire Extinguisher

For safe operation of your equipment, you must be a responsible operator. A responsible operator must clearly understand the written instructions supplied by the manufacturer, be trained—including actual operation of the equipment and know the safety rules and regulations for the worksite.

Drugs and alcohol will affect an operator's alertness and coordination and therefore affect the operator's ability to operate the equipment safely. An operator should **NEVER** use drugs which affect alertness, judgement and coordination or alcohol while operating motorized equipment, including tractors and mowers. An operator on prescription or over-the-counter medication must consult a medical professional regarding any side effects of the medication that would hinder his or her ability to operate this equipment safely. **NEVER** knowingly allow anyone to operate this equipment when their alertness, judgement or coordination is impaired.

Protect Yourself

Wear all the protective clothing and personal safety devices issued to you or called for by job conditions.

You may need:

- Hard hat
- Safety shoes
- Safety glasses with side shields, goggles or face shield
- Heavy gloves
- Hearing protection
- Reflective clothing
- Wet weather gear
- Respirator or filter mask

Wear adequate clothing for the job conditions.

Always know where to get assistance in the case of an emergency. Know where to find and how to use a first aid kit and fire extinguisher/fire suppression system.

**Stay alert. Avoid accidents.
Don't learn safety the hard way.**

Safety Management of Hazards and Risks

In addition to equipment design and configuration, **HAZARD CONTROL** and **ACCIDENT PREVENTION** are dependent upon the owner's and operator's awareness, concern, prudence, and proper training in the operation, transport, maintenance and storage of equipment.

SAFETY MANAGEMENT OF HAZARDS AND RISKS IS ESSENTIAL TO RESPONSIBLE OWNERS AND OPERATORS OF TRACTORS AND MOWERS.

REVIEW THE FOLLOWING SAFETY MANAGEMENT OF LISTED HAZARDS AND RISKS:

Thrown Object Hazard

POSSIBLE THROWN OBJECT INJURY RISKS EXIST FOR MOWER OPERATORS AND BYSTANDERS DURING MOWER OPERATIONS FROM THE FOLLOWING:

DISCHARGED OBJECTS (ROCKS, DEBRIS, BROKEN MOWER BLADES, BLADE BOLTS, CABLES, CHAINS, WIRE, ETC....) FROM THE MOWER.

Equipment Protective Devices And Recommended Safety Practices

The mower deck and protective devices cannot prevent all objects or debris from escaping the blade enclosure area in every mowing condition. It is possible for objects to escape and travel several hundred (300) feet.

RECOMMENDED SAFETY PRACTICES

Read manufacturer's operator manual(s) for recommended operating safety practices. Explain the practices to users or operators who cannot read.

TO HELP PREVENT SERIOUS INJURY OR DEATH FROM OBJECTS STRIKING OPERATOR OR OTHER PERSONS DO THE FOLLOWING:

BYSTANDERS SAFETY

- Keep bystanders several hundred (300) feet from mowing area.

EQUIPMENT PROTECTIVE DEVICES SAFETY

To contain, deflect or reduce thrown objects from blade enclosure area:

- Keep chain, flexible or solid deflector shields in place on the front and rear of the mower deck and in good repair.
- Do not operate with damaged or missing thrown object shielding.

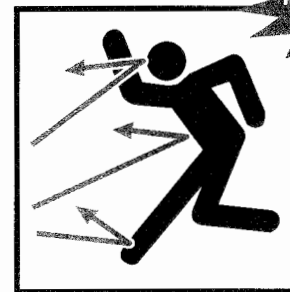
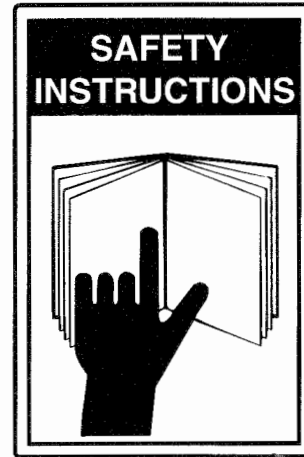

THROWN Object Hazard

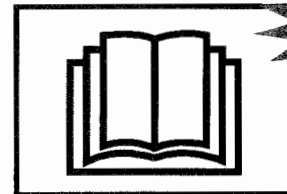

READ Manuals

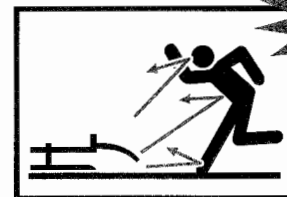

KEEP Bystanders Away

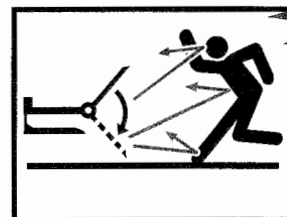

THROWN Object Hazard

**USE ROPS
Enclosed Cabs
or Protective
Enclosures**

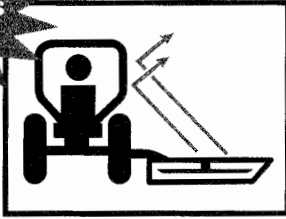

**USE Proper
PTO Speed**

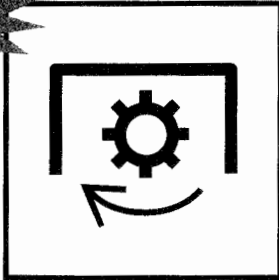

**MAINTAIN
Equipment**



OPERATOR SAFETY

Raised wings, side mount and boom type mower operations may reduce the mower's thrown object shielding effectiveness for the mower operator's protection.

Do the following to increase operator protection from thrown objects during these mowing operations:

- Use enclosed ROPS cabs, special protective enclosures, screens or other operator shielding devices when performing these operations.

EXCEEDING RECOMMENDED PTO SPEEDS

Do not exceed manufacturer's recommended PTO speeds.

Excessive PTO speeds may cause:

- Blade failures
- Higher velocity objects escaping or broken blades being thrown from mower blade enclosures.
- Potential 540 rpm driveline failures operating at 750 to 1000 rpm speeds.

OTHER SAFETY PRACTICES:

- Never operate mower with broken, bent, missing, or severely worn blades.
- Before mowing, remove debris and foreign objects to avoid them being picked up and thrown out by the mower.
- * Do not operate the mower in transport or in raised wing positions.

RECOMMENDED MAINTENANCE PRACTICES

Read manufacturer's operator manual(s) inspection and maintenance instructions for chain guards, flexible or solid deflector shielding:

- Replace worn or damaged guards and other shielding before mowing.
- Use only manufacturer's replacement guards and shielding. Other guarding or shielding sources may not fit or have inadequate materials to meet the strength requirements of the equipment.
- Replace worn or damaged decals and warning instructions.
- Explain the inspection and maintenance instructions to those users or operators who cannot read.

Rotating Blades and Driveline Hazards and Risks

A POSSIBLE INJURY RISK EXISTS TO MOWER OPERATORS AND BYSTANDERS DURING MOWING OPERATIONS FROM THE FOLLOWING:

- BODY CONTACT WITH ROTATING BLADES.
- BODY ENTANGLEMENT WITH ROTATING DRIVELINES AND PARTS.

Equipment Protective Devices and Recommended Safety Practices

RECOMMENDED SAFETY PRACTICES

Read manufacturer's operator manual(s) for recommended operating safety practices. Explain the practices to those users or operators who cannot read. To help prevent serious injury or death from moving blade contact, driveline or parts entanglement of operators or other persons do the following:

BYSTANDERS SAFETY

- Do not operate near bystanders.
- Keep other persons several hundred (300) feet from the mowing area.

OPERATOR SAFETY PRACTICES

- Do not allow riders on tractor or mower. Securely fasten seat belt when mowing.
- Use proper equipment shutdown practice before servicing, adjusting, cleaning or unclogging the mower.
- Keep clear of rotating blades, parts, and drivelines.
- Never start tractor engine while standing beside equipment.
- Only start tractor engine while sitting in operator's seat with seat belt fastened.

RECOMMENDED GUARDS, DRIVELINE GUARDS AND SHIELDING SAFETY PRACTICES

- Keep guards, driveline and other shielding in place and in good repair.
- Do not operate mower with missing or damaged guards, driveline guards or other shielding.

RECOMMENDED MAINTENANCE PRACTICES

Read manufacturer's operator manual(s) inspection and maintenance instructions for guards, driveline guards and other shielding:

- Replace worn or damaged guards, driveline guards and other shielding before mowing.
- Use only manufacturer's replacement guards and shielding. Other guarding or shielding sources may not fit or have inadequate materials to meet the strength requirements of the equipment.
- Replace worn or damaged decals and warning instructions.
- Explain the inspection and maintenance instructions to those users or operators who cannot read.

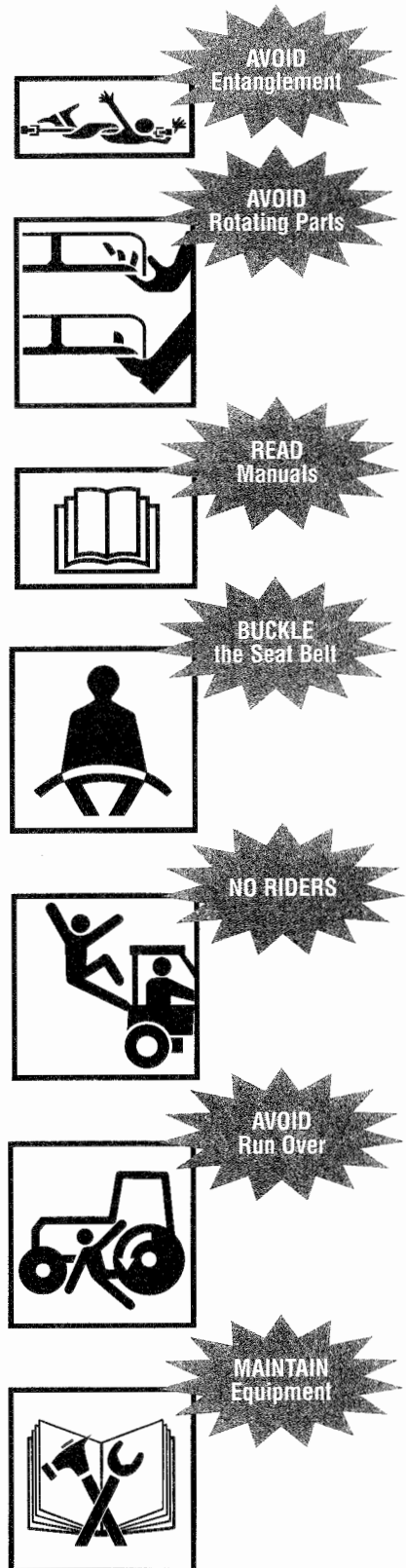

Tractor and Mower Rollover or Overturn Hazards and Risks

A POSSIBLE ROLLOVER OR OVERTURN INJURY RISK EXISTS TO MOWER OPERATORS DURING MOWING OPERATIONS FROM THE FOLLOWING:

- ROUGH TERRAIN, STEEP SLOPES, HOLES, BUMPS, RUTS, ROCKS, STUMPS OR OTHER OBSTRUCTIONS THAT COULD OVERTURN TRACTOR AND MOWER.
- EXCESSIVE GROUND SPEEDS FOR THESE TERRAIN CONDITIONS.

Equipment Protective Devices and Recommended Safety Practices

When possible remove stumps, stones, etc.. or mark them and other obstructions clearly to avoid upsets, breakdowns, and dangerous driving conditions. Use extreme care to maintain control over the equipment when operating in these terrain conditions.

RECOMMENDED-TRACTOR ROPS

A tractor equipped with ROPS or enclosed ROPS cab and seat belt for operator safety is essential for additional operator protection when operating mower in these terrain conditions.

RECOMMENDED-TRACTOR STABILITY ADJUSTMENTS

Read the tractor operator's manual for adjustments to increase tractor stability:

- Adding front and rear wheel weights or ballast.
- Adjusting wheel spacing to maximum width .
- Adding off-side counter ballast to side-mounted and boom mowers.
- Explain adjustments to those users or operators who cannot read.

RECOMMENDED SAFETY PRACTICES

Read manufacturer's operator manual(s) for recommended operating safety practices. Explain the practices to those users or operators who cannot read. **To help prevent serious injury or death to the operator from tractor and mower overturns, do the following:**

- Securely fasten seat belt when mowing with ROPS equipped tractors.
- Avoid excessive ground speed for terrain conditions.
- Avoid sudden starts, stops and turns when operating up, down or across slopes.
- Avoid slippery ground conditions.
- Make wide and gradual turns.
- Plan to mow down hill on steep slopes to avoid overturning.

Falling Mower or Parts Crushing Hazards and Risks

A POSSIBLE CRUSHING INJURY RISK EXISTS FOR MOWER OPERATORS AND OTHERS DURING MOWING OPERATIONS FROM THE FOLLOWING:

- FALLING MOWER OR EQUIPMENT FROM HYDRAULIC SYSTEM FAILURE.
- FAILURE TO SECURELY SUPPORT, BLOCK-UP OR LOCK-UP LIFTED MOWER OR EQUIPMENT PARTS.

**AVOID
Rollover**

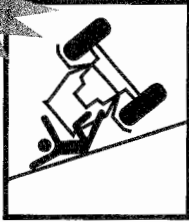

**USE
Tractor ROPS**



**READ
Manuals**

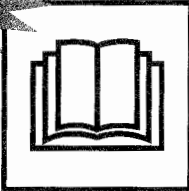

**ADD
Ballast**



**WIDEN
Wheel Spacing
and ADD Off-Side
Ballast**



**BUCKLE
the Seat Belt**



**AVOID
CRUSHING
Lock-Up Wing**



Equipment Protective Devices and Recommended Safety Practices

Read manufacturer's operator manual(s) for recommended operating safety practices. Explain the practices to those users or operators who cannot read. **To help prevent serious injury or death to operators and other from alling mower or equipment parts, do the following:**

RECOMMENDED SAFETY PRACTICES

Before working near or underneath lifted mower or equipment parts:

- Use proper equipment shutdown practices before servicing, adjusting, cleaning or unclogging the mower.
- Securely support or block-up raised mower or equipment parts.
- Securely support, block-up or lock-up wings with locking devices on wing type mowers or lower mower or equipment parts to the ground.
- Use transport locks when transporting mower on public roads.

High Pressure Hydraulic Fluid Leak Hazards and Risks

A POSSIBLE HIGH PRESSURE FLUID SKIN INJECTION INJURY AND GANGRENE RISK EXISTS FOR MOWER OPERATORS AND OTHERS FROM HIGH PRESSURE HYDRAULIC OR DIESEL OIL LEAK INJECTION INTO THE SKIN.

TO AVOID GANGRENE, INJECTED FLUID MUST BE SURGICALLY REMOVED WITHIN A FEW HOURS BY A DOCTOR FAMILIAR WITH THIS TYPE OF INJURY.

RECOMMENDED SAFETY PRACTICES

Read manufacturer's operator manual(s) for recommended operating safety practices. Explain the practices to those users or operators who cannot read. High pressure fluid pinhole leaks can be almost invisible.

To help prevent serious injury or death, do the following:

- Search for leaks with cardboard or wood.
- Do not use hands to check for leaks.
- Relieve system pressure before disconnecting lines.
- Before applying system pressure:
 - Check for damaged lines, pipes, and hoses.
 - Check to insure tight connections.
- Before operating pressurized systems:
 - Purge air from system.
 - Refer to the manufacturer's operator manual(s) for instructions.
 - Explain the procedures to those users or operators who cannot read.

Tractor Refueling Hazards and Risks

To avoid serious injury or death from fire during refueling:

- Shut off engine and ignition.
- Never fill fuel tank near open flames.
- Never smoke while refueling.
- Avoid static electricity sparks by grounding fuel nozzle against tank filler neck.
- Avoid overfilling tank or spilling fuel.
- Clean up any spilled fuel immediately.
- Always replace fuel cap.

To avoid serious injury or death from engine exhaust fumes:

- Adequately ventilate enclosed spaces before starting the engine.

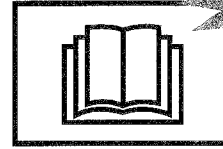

**READ
Manuals**

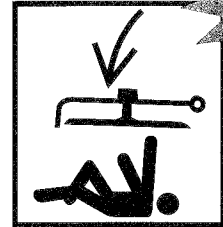

**AVOID
CRUSHING
Block-Up or
Securely Support
Mower**

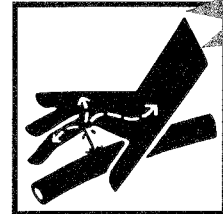

**HIGH
PRESSURE FLUID
Can Inject
into the Body**



**READ
Manuals**

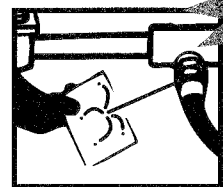

**AVOID
INJECTION
Use Cardboard
Not Hands**



**AVOID
Fires and
Explosions**

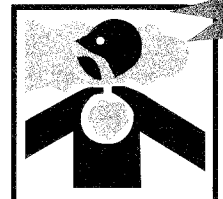

**AVOID
Exhaust Fumes**

Follow A Safety Program

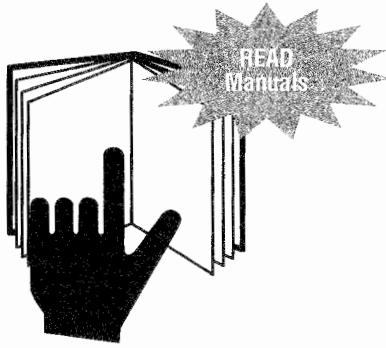

SAFETY IS IMPORTANT TO RESPONSIBLE OWNERS AND OPERATORS OF TRACTORS AND MOWERS. DO THE FOLLOWING FOR YOUR SAFE MOWING OPERATION:

BE A QUALIFIED OPERATOR BY:

- Reading, understanding and obeying the manufacturer's written instructions in operator manual(s) and safety signs on mower and tractor.
- Receiving operational training with mower and tractor.
- Asking your equipment dealer or supervisor to explain things you do not understand.
- Explaining the written instructions in the operator manual(s) and safety signs (decals) on the mower and tractor to those users or operators who cannot read.

Safety Before Operation

Know Job Site Safety Rules And Regulations

Ask your supervisor about equipment operation safety rules you will be expected to obey.

Some basic rules for your's and others' safety:

- A ROPS and seat belt equipped tractor is required for operator protection during mowing operations.
- Know mower and tractor operating capacity and characteristics.
- Never alter or remove safety equipment.
- Never allow children or unqualified persons to operate mower or tractor.
- Never allow riders on mower or tractor.
- Keep others away from mowing operation.
- Use proper equipment shutdown practice before dismounting tractor.
- Allow all moving parts to stop before making equipment inspections, repairs, or adjustments.
- Securely support or block-up mower before working beneath mower or lifted components.
- Wear personal protective clothing and safety devices issued to you or recommended by the equipment manufacturer.



Know Tractor And Mower Controls

Know the following about your tractor and mower:

- Function, purpose and use of controls.
- Safe operating speeds.
- Safe slope and uneven terrain capabilities.
- Braking and steering characteristics.
- Tractor and mower operating clearances.
- How to stop equipment quickly in an emergency.

Use All Available Equipment Safety Devices

To help keep you and others around you safe:

- Make certain manufacturer's recommended guards, shields and safety signs are installed on equipment and in good condition.
- Keep all protective devices in place and securely fastened.
- **NEVER** operate your equipment with missing, disconnected or damaged safety devices.
- Use ballast and weight required for equipment operational stability.

Check The Mower And Tractor Equipment

Before beginning your work day:

- Check for loose, broken, missing or damaged tractor and mower parts.
- Repair or replace these parts when needed.
- Check for proper tractor and mower attachments.
- Check for proper tractor and mower PTO rpm rating match.
- Check mower blades condition. Sharpen or replace per manufacturer's recommendation. Blade modifications, such as welding or hard surfacing cutting edges by welding or straightening bent blades, can reduce blade strength and adversely affect blade properties and safety.
- Check that all guards and shields are in place and that all equipment is in good operating condition. This includes PTO driveline, gearbox and implement guards and shields that are used for operator protection.
- Check for properly latched driveline yoke end locking devices.
- Check for damaged or leaky tractor and mower hydraulic systems.
- Check and read safety signs and warning instructions.
- Explain the safety signs and warning instructions to those users or operators who cannot read.

Check The Work Area

Inspect, identify and avoid hazardous conditions in the work area:

- Rough terrain, drop-offs, ditches, potholes steep slopes, stumps, standing water, mud soft soil, slippery conditions, debris and foreign objects.
- Inspect mowing area and remove or mark all foreign objects and debris to be avoided by mower.

Analyze mowing area to determine:

- Best and safest mowing procedure.
- Material type and height to be mowed.
- Operating terrain conditions.
- Using forward travel mowing pattern when possible.

Look Out For The Safety of Others

Before starting equipment:

- Walk around the equipment.
- Check for anyone under, on or near the equipment.
- Clear everyone from these areas.
- Sound a warning.



USE ROPS
and Seatbelt

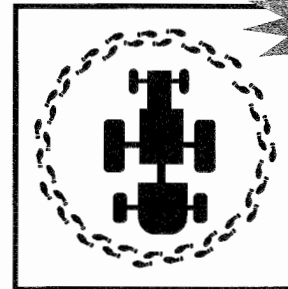

WALK AROUND
Inspection

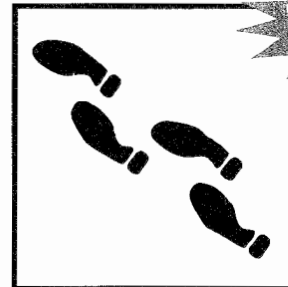

WALK AROUND
the Worksite

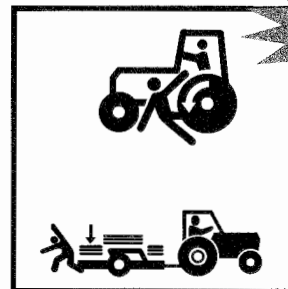

LOOK OUT
For Others

Safety – Starting & Testing

USE Three Point Contact



USE ROPS and Seatbelt



USE Proper PTO speed

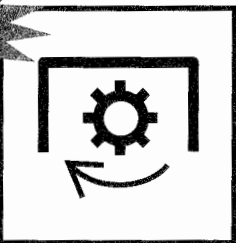

Mounting Tractor Safely

Before mounting:

- Clean shoes and wipe hands.

During mounting and dismounting:

- Use handholds and step plates.
- Never grab steering wheels or controls for handholds.
- Never mount or dismount from a moving tractor.

Tractor And Mower Controls Safety Test

Before starting:

- Fasten and adjust seat belt on your ROPS-equipped tractor.
- Check parking brake for engagement.
- Check PTO disengagement.
- Check all controls for Neutral or Park position.
- Warn others in area before starting tractor.
- Follow tractor manufacturer's recommended starting procedures.

After starting:

- Check all instruments, gauges and indicator lights for normal operation.
- Check all tractor controls, steering and brakes for proper function.
- Repair improperly functioning tractor before using.
- Raise and lower mower for driveline bottoming out or engagement problems.
- Check your equipment for excessive vibration and unusual noises.
- Use proper equipment shutdown practices before inspecting equipment.

Power Takeoff System And Mower Safety

Tractors with dual-speed (540 or 1000 rpm) shiftable PTO systems.

To avoid serious injury or death from failed parts due to mower over speed:

- Be sure to position PTO selector to mower's rated PTO rpm speed.

Tractors with transmission-driven PTO systems.

A rotary mower will have a significant flywheel effect which may continue to propel a tractor with a transmission-driven PTO system.

The tractor should be equipped and operated as follows:

- Install an over-running clutch.
- Give yourself sufficient maneuvering room and time by anticipating turns, stops and speed reductions.

Safety – During Operation

Hitching Mower To Tractor Safety

Three-point hitch-mounted mower safety:

- Refer to mower and tractor manufacturers' manuals.
- Place tractor's hydraulic power lift (rockshaft) selector lever in down position to avoid unexpected movement.
- Explain the hitching procedures to those users or operators who cannot read.

Pull-type hitch-mounted mower safety:

- Refer to mower and tractor manufacturers' manuals.
- Attach only to drawbar hitch.
- Do not attach to tractor's rear axle or three-point hitch arms.
- Adjust tractor drawbar length for 540 or 1000 rpm PTO operation.

Make The Right Start In Mower Safety

Mow only in daylight or good artificial light conditions.

To avoid serious injury or death from mower thrown objects or blade contact:

- Keep chain shields, flexible or solid deflector shields or discharge chutes in place and in good repair.
- Keep everyone several hundred (300) feet from mowing operation.
- Never direct mower discharge toward anyone.
- Keep hands, feet and other body parts away from rotating parts, blades and discharge openings.
- Do not operate mower in transport position.

Mower PTO drive engagement:

- Raise mower to maximum cutting height.
- Engage PTO at low engine rpm.
- Increase engine rpm to mower rated rpm PTO speed.
- Lower mower to desired cutting height.
- Stop and shut down immediately if the mower strikes an obstruction.
- Inspect and repair any mower damage before resuming mowing.
- Do not operate mower with severe vibrations or with unusual noise.

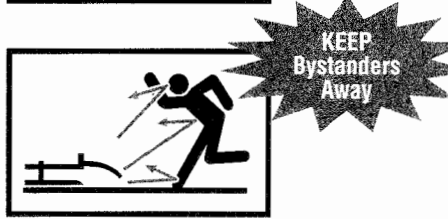
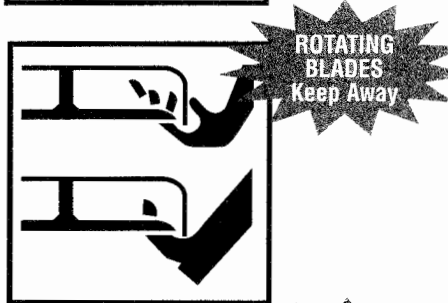
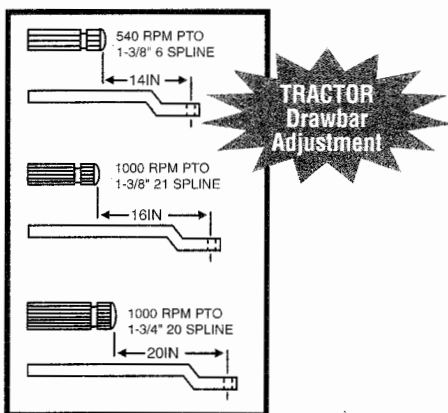
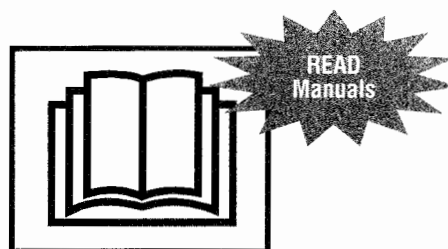

LOOK OUT
For Others

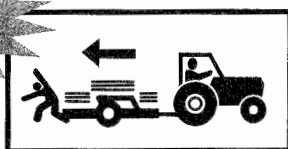

Mowing In Reverse Safety

Avoid mowing in reverse direction when possible.

Do the following when mowing in reverse direction:

- Check for any persons behind mower before reversing direction.
- Use extreme care when reverse direction mowing.
- Maintain rotary mower front and rear safety shields and flail front shields and rear rollers.

MAINTAIN
FLAIL
Rear Roller

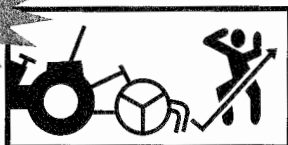

Mowing Ground Speed

Proper ground speed depends on terrain conditions and grass type, density and height to be cut:

- Normal ground speed range is 2 to 5 mph.
- Slower ground speed for mowing tall, dense grass.
- Faster ground speed for mowing medium height, thin grass and under smooth terrain conditions.
- Use slower ground speed for mowing in rough, sloping or unfamiliar terrain.

USE PROPER
Ground Speeds

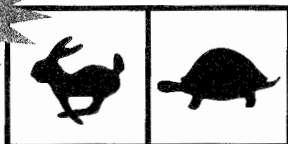

STOP BLADE
Before
Unclogging



Extremely tall grass mowing

- You may need to mow extremely tall grass twice.

First mowing pass:

- Cut grass higher (10-15 inches) to avoid hidden objects.

Second mowing pass:

- Remove debris and objects.
- Cut grass at desired height and 90 degree to the first mowing pass when possible.
- Use proper equipment shutdown practice for your safety before dismounting tractor.

PROVIDE
Adequate
Clearance for
Mower Swing

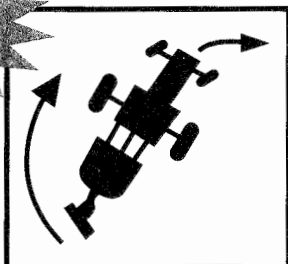

Watch equipment clearances

Three-point hitch and side mounted mowers have a larger turning arc than pull-type mowers. Allow sufficient clearance for safe turning.

NEVER STAND
On Mower
Keep Away

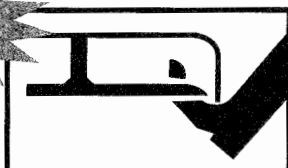

Under Mount Mower Safety

When mowing with an under mount mower:

- Keep removable discharge chute in place and over discharge opening.
- Never stand on an operating mower housing.
- Distribute grass clipping with discharge chute facing mowed area.
- Use proper equipment shutdown practice before clearing clogged mower or discharge chute.

KEEP CHUTE
In Place

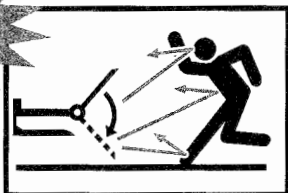

Wing Or Boom Type Mower Overhead Obstruction Hazards and Risks

Check for overhead obstructions with raised wings or boom-type mowers to avoid serious injury or death by contact with:

- Electrical power lines.
- Low tree limbs.
- Other overhead obstructions.

Wing And Side Mount Mowers Safety

When mowing with wing and side-mount mowers:

Raised wing positions reduces shielding protection and increases the thrown object and blade contact hazard risks.

To avoid serious injury or death by thrown objects or blade contact from raising and lowering wings during mowing operations:

- Do not mow with bystanders in mowing area.
- Be sure no one is near mower while raising or lowering wings.
- Keep the exposed rotating wing blade time to a practical minimum during a raised wing mowing operations.
- Stop mowing if persons enter into mowing area.
- Only raise wing to clear objects in the mowing path or to match ground slope.
- Disengage wing drive for extended periods of mowing with raised wings.
- Lower raised wing to ground after clearing object or ground slope conditions.
- Allow all mower blades to stop rotating before raising wing sections during other operations.

Ditch Bank Mowing Safety

Use extreme care when mowing ditch banks. Watch for washouts, eroded areas and mowing obstructions along the ditch banks. Hitting obstructions with side-mount or boom mowers may swerve the tractor's front end toward the ditch.

Raised wing and boom-type mower ditch bank operations may reduce the mower's thrown object shielding effectiveness for the mower operator's protection.

To increase operator protection from thrown objects during ditch bank operations:

- Use enclosed ROPS cabs, special protective enclosures and other operator shielding when performing these operations.
- Inspect mowing area and remove or mark all foreign objects and debris to be avoided by mower.



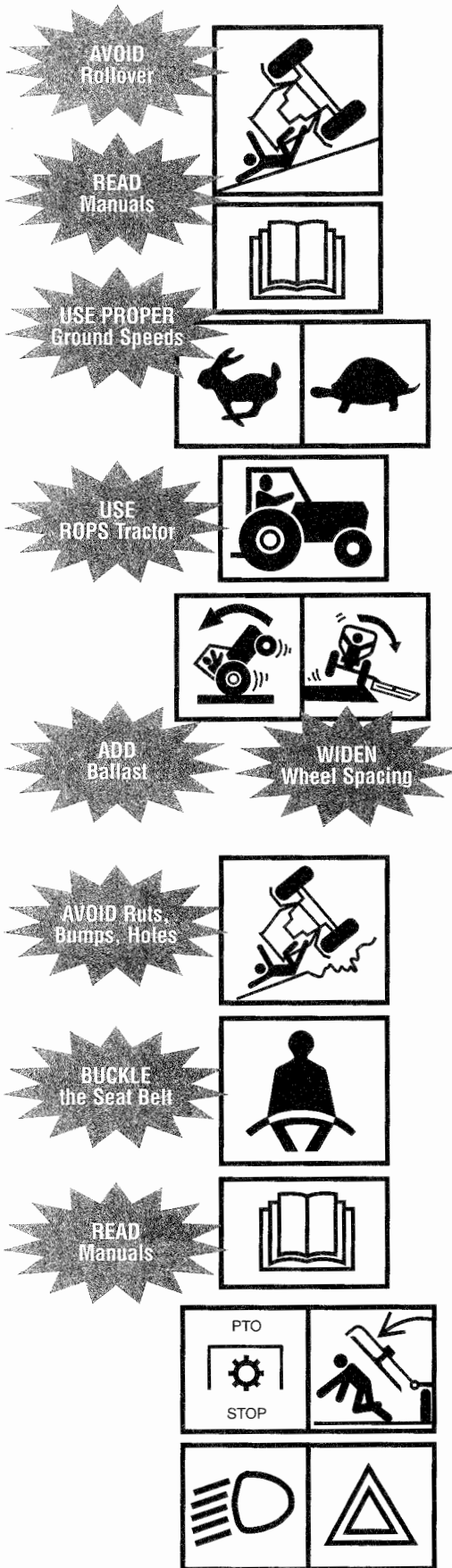

Mowing Uneven Terrain Safely

The tractor and mower stability is reduced on slopes and uneven terrain.

You can prevent tractor and mower overturns and maintain equipment stability control by:

- Reviewing tractor and mower operator's manuals for operating safety practices on slopes and uneven terrain conditions. Explain the practices to those users and operators who cannot read.
- Avoiding extremely steep slope operations.
- Using extreme care to maintain control over your equipment when operating in these conditions.
- Increasing tractor stability by adding wheel weights and increasing wheel spacing (Refer to tractor operator's manual for recommendations)
- Using ROPS and seat-belt-equipped tractor for operator safety during mowing operations.
- Maintaining minimum ground speed.
- Making wide and gradual turns.
- Avoiding sudden starts, stops, and turns when operating up, down, or across slopes.
- Not raising rear-mount or side-mount mowers or mower wings from the ground during these operations .
- Keeping alert for holes, bumps, ruts, rocks, stumps or other obstructions that could overturn tractor and mower.
- Avoiding slippery ground conditions that could overturn tractor and mower.
- Avoiding tractor and mower "hang up" by diagonal passing through sharp dips and drops.

Use extreme care in maintaining equipment stability during all uneven terrain and slope mowing operations. You are the final judge as to any slope that can be safely negotiated.

Equipment Road Transporting Safety

If equipment is to be driven on public roads:

- Refer to tractor and mower manufacturers' operator's manuals for instructions.
- Explain the instructions to those users or operators who cannot read.
- Check local regulations for required equipment markings, lights, flashers, etc., while traveling on public roads. Lights are required on mowers that obscure tractor taillights and/or warning lights.

Before transporting on public roads:

- Disengage PTO to mower.
- Raise mower into transport position.
- Lock wings up into transport position with locking devices on wing-type and side-mounted mowers.
- Attach safety chain between pull-type mower and tractor.
- Make sure lights, flashers, reflectors and SMV are in place and visible.
- Check SMV (Slow-Moving Vehicle) emblem for visibility to any rear approaching vehicle.

While transporting on public roads:

- Obey all local traffic regulations.
- Approach intersections with caution.
- Observe speed and traffic control signs.
- Avoid panic stops and sharp turns.

Parking Safety

Park equipment at:

- Designated or out-of-traffic areas.
- Preferably level ground locations.

Sloping ground parking locations:

- Position equipment across slope.
- Set parking brakes.
- Lower mower to ground.
- Block tractor wheels.

Before temporarily parking and leaving disabled equipment near traffic areas:

- Remove equipment from public roads.
- Set out warning flags
- Use tractor flashers.

Safety – During Shutdown

Use Proper Equipment Shutdown Practices For Your Safety

Refer to tractor and mower manufacturer's operator manual(s) for recommend shutdown procedures. Explain the procedures to those users or operators who cannot read.

Make proper equipment shutdown procedures an important habit to practice. Follow these safety practices before dismantling tractor:

- Disengage PTO clutch and transmission drive.
- Idle engine for gradual cooling.
- Place the controls in PARK or NEUTRAL.
- Set the parking brake.
- Lower mower to ground.
- Lower wings of wing-type mowers to ground.
- Shut off engine.
- Wait for all moving parts to stop before equipment inspections, adjustments or repairs.
- Relieve hydraulic pressure by moving hydraulic controls several times in all directions.
- Lock ignition and remove key when equipment is to be inspected, repaired, adjusted or unattended.
- Lock anti-vandalism covers and closures when equipment is unattended.
- Dismount carefully maintaining three-point contact.

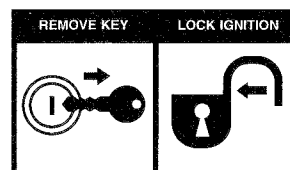
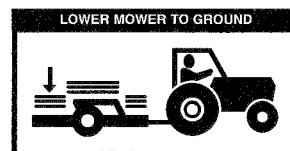
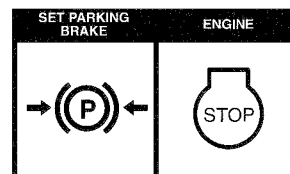
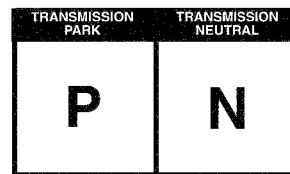
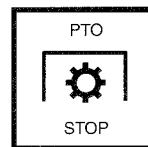
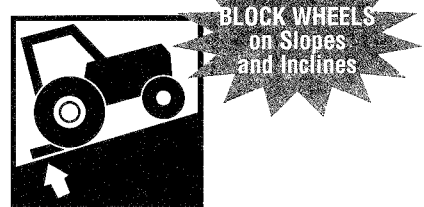
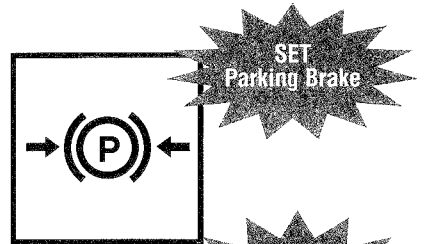

**WAIT For
Moving Parts to
Stop Before
Dismount**



**USE Three
Point Contact**



**MAINTAIN
Equipment**

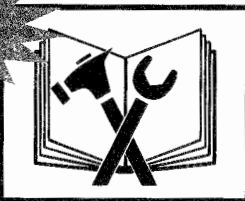

FOLLOW

**Maintenance
Schedule**



Dismounting Tractor Safely

Before dismounting tractor:

- Use proper equipment shutdown practice for your safety.
- Lower implement to the ground, stop engine and PTO, set brakes, allow all moving parts to stop, and remove key before dismounting from tractor.
- Never dismount from moving equipment.
- Never jump from machines.
- Dismount carefully.
- Check for slippery steps
- Keep feet and hands away from controls.
- Use handholds and steps during dismount.
- Face machine and use 3 point contact (2 hands, 1 foot or 2 feet, 1 hand).

Safety – During Maintenance

Maintenance Safety

Do the following for your safety before performing any maintenance, repairs or service procedures:

- Follow proper equipment shutdown practice.
- Wear all the protective clothing and personal safety devices necessary to safely perform the job.
- Refer to your manufacturer's manuals for proper maintenance, repair and service procedures. Explain the procedures to those users and operators who cannot read.

Stored energy sources (electrical, mechanical, hydraulic, pneumatic, chemical, thermal, etc..) must be either locked, blocked, relieved, disconnected, stopped, secured, neutralized, controlled or reduced to a practical minimum before any maintenance, repair or service procedures can be done safely.

Some basic safety practices to prevent potential injuries from energy releasing sources:

- Disengage PTO before shutting off engine.
- Place controls in PARK or NEUTRAL before shutting off engine.
- Set parking brake or block wheels.
- Allow all moving parts to stop.
- Lower mower to ground.
- Lower wings to ground on wing-type mowers.
- Shut off tractor engine.
- Lock ignition and remove key.
- Look and listen for evidence of moving parts before opening shields.
- Securely support or block-up mower before working underneath mower or other lifted components.
- Securely support, block-up, or lock-up mower wings with locking devices before working near or underneath a wing-type mower.
- Relieve hydraulic system pressure by moving controls several times in all directions.
- Relieve pressure before disconnecting or disassembling any pressurized system.
- Block or relieve spring pressure before disassembling any spring-loaded mechanism.
- Securely support or block up any elevated machine component before working on it.
- Avoid flames, sparks, or smoking near any fuels.

Mower Manufacturer Parts and Your Safety

Most mower manufacturers use special fasteners and specially designed parts to meet mowing operations requirements.

Critical safety-related parts (Self-locking blade bolts, blades, pins, shields or other special items) have specific strength, design and fit requirements for the make and model mower you are using.

Modifications or repair parts not approved by the mower manufacturer can cause serious safety hazard exposure risk to you and others.

TO AVOID SERIOUS INJURY OR DEATH FROM UNAPPROVED PARTS OR MODIFICATIONS:

- Do not substitute common hardware for self-locking blade bolts or other special part items.
- Do not substitute blades, pins, shields or other critical safety-related parts.
- Do not use grade 5 or 8 bolts to replace grade 2 shear bolts.

FOLLOW THE SAFETY PRACTICE OF ALWAYS CHECKING THE MOWER FOR PROPER FUNCTION AFTER ALL ADJUSTMENTS REPAIRS OR SERVICE.

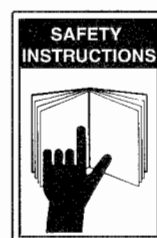
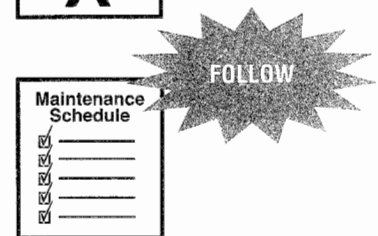
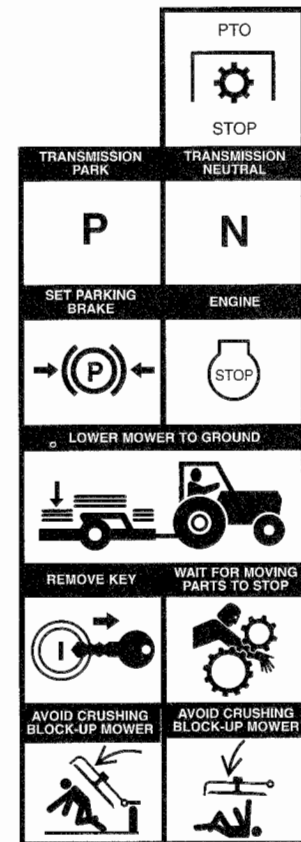

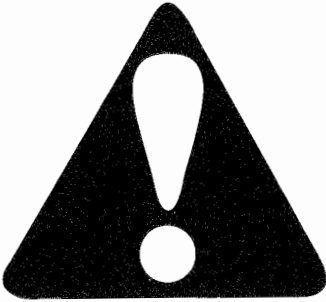

One Final Word



You have just finished reading the Mower Safety Manual. It is impossible for this manual to cover every potentially hazardous situation you may encounter. But, your knowledge of these safety precautions and your adherence to the basic rules of safety will help build good judgment in all situations. Our objective is to help you develop good safety habits and make you a better mower operator. The mower safety manual, safety precautions and basic rules of safety must be explained to those users or operators who cannot read.

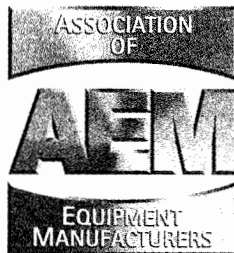

111 E. Wisconsin Avenue • Milwaukee, Wisconsin 53202 U.S.A.
www.aem.org

For information on additional copies of this and
other safety manuals, call 800-369-2310



Segadora industrial y agrícola

manual de seguridad

*para operadores
y mecánicos*

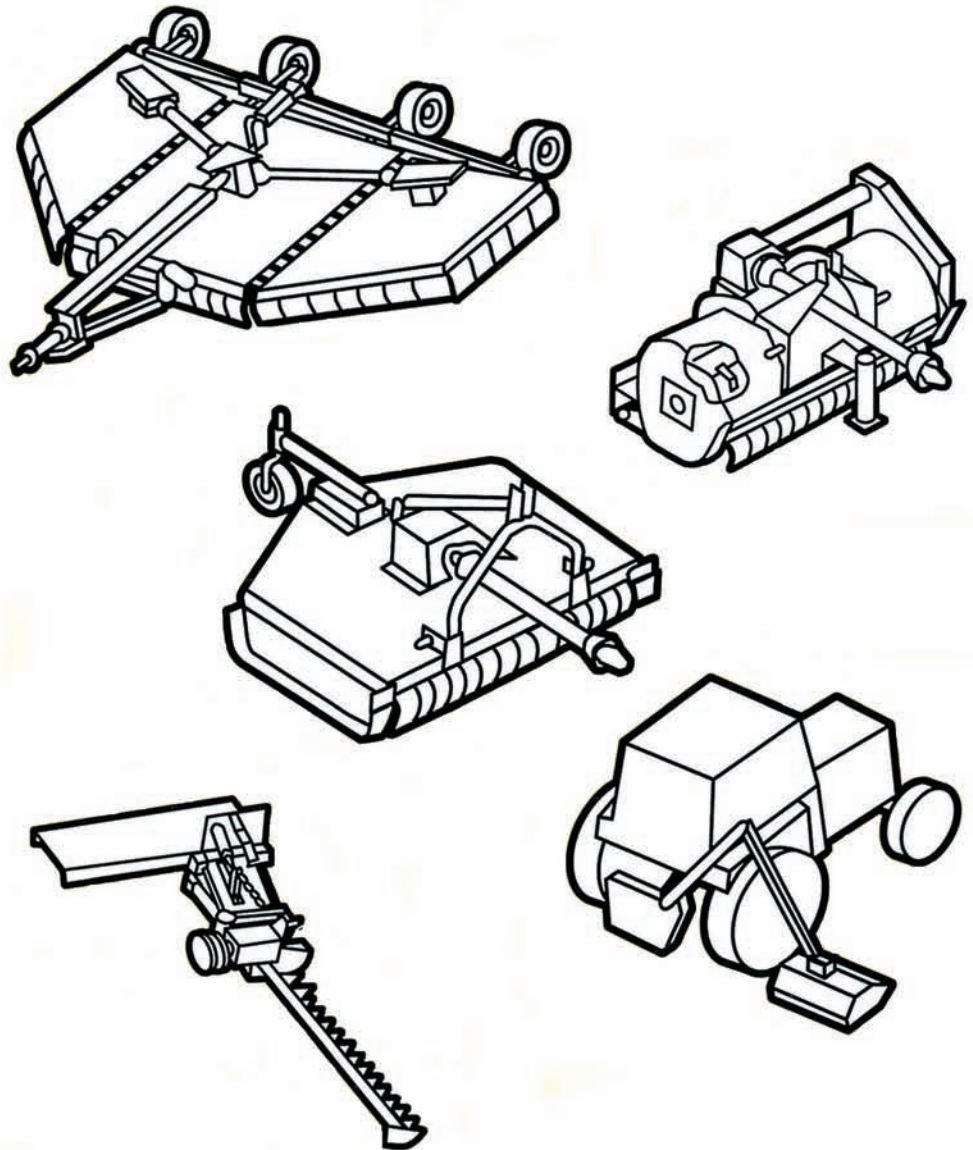

111 E. Wisconsin Avenue • Milwaukee, Wisconsin 53202 U.S.A.
www.aem.org

Contenido

Reconocimiento	2
Introducción	3
Palabras para el usuario	3
Alerta de seguridad	4
Segadoras industriales y agrícolas.....	4
Sea un operador responsable	5
Manejo seguro de riesgos y peligros.....	6
Cumpla con un programa de seguridad.....	11
Seguridad previa a la operación	11
Seguridad durante el arranque y prueba	13
Seguridad durante la operación	14
Seguridad durante la parada	18
Seguridad durante el mantenimiento	19
Palabra final	21

Reconocimiento

Deseamos extender nuestro reconocimiento a los miembros de del Association of Equipment Manufacturers por sus contribuciones para la preparación de este manual de seguridad.

Derechos de autor

© 2000 Equipment Manufacturers Institute. Todos los derechos reservados. Revisado 08.2003

Introducción

El propósito de este manual de seguridad es señalar algunas de las situaciones básicas de seguridad que pueden ocurrir durante la operación y mantenimiento de su máquina y sugerir los métodos posibles para tratar estas situaciones. Este manual NO es un sustituto de el (los) manual(es) del fabricante.

Pueden ser necesarias algunas precauciones adicionales, o algunas instrucciones no pueden aplicar, dependiendo del equipo, dispositivos de fijación, y las condiciones del lugar de trabajo o del área en que se realiza el servicio. El fabricante no tiene control directo sobre las aplicaciones, operación, inspección, lubricación o mantenimiento de la máquina. Por lo tanto, es **SU** responsabilidad practicar buenas medidas de seguridad en estas áreas.

La información proporcionada en este manual sirve como complemento de los detalles de información específicos de su máquina que están incluidos en el (los) manual(es) del fabricante. La información adicional que pueda afectar la operación segura de su máquina puede estar incluida en las etiquetas de seguridad o en los requisitos del seguro, programas de seguridad del empleador, códigos de seguridad, leyes locales del estado/provincia y leyes nacionales, reglas y reglamentos.

IMPORTANTE: si usted no tiene el (los) manual(es) del fabricante de su máquina específica, obtenga un manual de reemplazo con su empleador, distribuidor de equipo o el fabricante de su máquina. Mantenga este manual de seguridad y el (los) manual(es) del fabricante con su máquina.

Palabras para el usuario

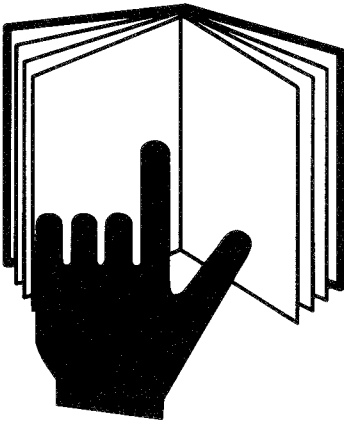

Usted tiene la responsabilidad de leer y comprender este manual de seguridad y el (los) manual(es) del fabricante, antes de operar esta máquina. Este manual de seguridad lo guía paso a paso a lo largo de su día de trabajo. El manual de seguridad, el (los) manual(es) del fabricante, avisos de seguridad (calcomanías) y precauciones de seguridad, deben explicarse a los usuarios u operadores que no puedan leer el material.

Adicionalmente al diseño y configuración del equipo el **CONTROL DEL PELIGRO** y la **PREVENCIÓN DE ACCIDENTES** dependen de la conciencia, preocupación, prudencia y capacitación adecuada de los propietarios y operadores durante la operación, transporte, mantenimiento y almacenamiento del equipo.

Recuerde que **USTED** es la clave para mantener la seguridad. Las buenas prácticas de seguridad no lo protegen solamente a usted sino que también a las personas que lo rodean. Estudie este manual y el (los) manual(es) del fabricante para su máquina específica. Hágalos una parte integral de su programa de seguridad. Recuerde que este manual de seguridad está escrito únicamente para segadoras industriales y agrícolas.

Practique todas las precauciones de seguridad usuales y acostumbradas en el trabajo y más que todo – recuerde que la seguridad depende de USTED. Solamente USTED puede evitar las lesiones graves o la muerte debidas a prácticas inseguras.

Advertencia de seguridad

Símbolo

Este símbolo de alerta de seguridad significa:

“¡ATENCIÓN! ¡MANTÉNGASE ALERTA! ¡SU SEGURIDAD ESTÁ INVOLUCRADA!”



El símbolo de alerta de seguridad identifica los mensajes de seguridad importantes en el equipo, en los avisos de seguridad, en los manuales y en otros lugares. Cuando usted vea este símbolo, esté alerta a la posibilidad de muerte o lesiones. Siga las instrucciones en el aviso de seguridad.

Palabras de señales

Las palabras de señales son palabras específicas que regularmente se encontrarán en las calcomanías de seguridad en este equipo o en otros equipos en el lugar de trabajo. Estas palabras tienen el objetivo de alertar a la persona que las vea de la presencia y el grado relativo de un riesgo.



Esta palabra de señal indica una situación de riesgo inminente que si no es evitado podrá resultar en la muerte o lesiones graves.



Esta palabra de señal indica una situación potencialmente riesgosa que si no se evita podría resultar en la muerte o lesiones graves.



Esta palabra de señal indica una situación potencialmente riesgosa que si no se evita podría resultar en lesiones menores o moderadas.

- LOS ACCIDENTES PUEDEN LISIAR Y CAUSAR LA MUERTE.
- LOS ACCIDENTES SON COSTOSOS.
- LOS ACCIDENTES PUEDEN EVITARSE.

Segadoras industriales y agrícolas

Es una segadora para cortar pasto, triturar residuos de cultivos, cortar maleza para la limpieza de terrenos, vías navegables, derechos de paso, cortes en los bordes de los caminos o carreteras.

TIPOS DE SEGADORAS INDUSTRIALES Y AGRÍCOLAS:

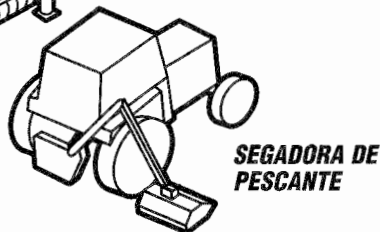
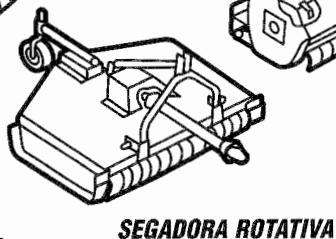
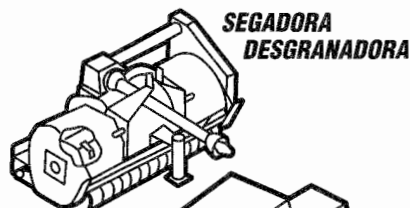
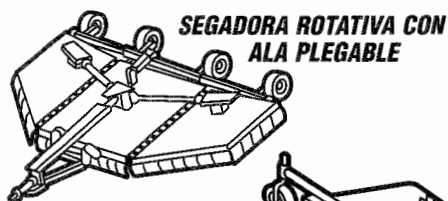

Sea un operador responsable



Para la operación segura de su equipo usted debe ser un operador responsable. Un operador responsable debe comprender claramente las instrucciones escritas proporcionadas por el fabricante ser capacitado – incluyendo la operación real del equipo y el conocimiento de las reglas y reglamentos de seguridad del lugar de trabajo.

Las medicinas y el alcohol pueden y afectarán el estado de alerta y coordinación del operador, por lo tanto, afectarán la habilidad del operador para operar el equipo en forma segura. Un operador **NUNCA** debe usar medicinas que puedan afectar su estado de alerta, juicio y coordinación; ni beber alcohol mientras opera equipo motorizado incluyendo tractores y segadoras. Un operador que use medicamentos por prescripción médica o de venta libre debe consultar con un médico profesional para conocer sobre cualquier efecto secundario que podría limitar su habilidad para operar este equipo en forma segura. **NUNCA** permita que alguien opere este equipo cuando estén afectados su estado de juicio alerta o de coordinación.

Protéjase usted mismo

Use toda la ropa protectora y los dispositivos de seguridad personal que se le proporcionen o que sean los indicados para las condiciones de trabajo.

Usted puede necesitar:

- Casco protector
- Zapatos de seguridad
- Anteojos de seguridad con protección lateral, gafas protectoras o protector facial
- Guantes extrafuertes
- Protección auditiva
- Ropa reflectora
- Equipo para clima húmedo
- Respirador o máscara filtrante

Use ropa apropiada para las condiciones del trabajo.

Siempre conozca cómo obtener ayuda en caso de una emergencia. Conozca donde encontrar y cómo usar los equipos de primeros auxilios y el extintor de incendios/sistema de supresión de incendios.



**Manténgase alerta. Evite los accidentes.
No conozca la seguridad en la forma más difícil.**

Manejo seguro de riesgos y peligros

Adicionalmente al diseño y configuración del equipo, el **CONTROL DEL PELIGRO** y la **PREVENCIÓN DE ACCIDENTES** dependen de la conciencia, preocupación, prudencia y capacitación adecuada de los propietarios y operadores durante la operación, transporte, mantenimiento y almacenamiento del equipo.

EL MANEJO SEGURO DE RIESGOS Y PELIGROS ES UN ELEMENTO ESENCIAL PARA LOS PROPIETARIOS Y OPERADORES RESPONSABLES DE TRACTORES Y SEGADORAS.

REVISE EL MANEJO SEGURO DE LOS PELIGROS Y RIESGOS ENUMERADOS A CONTINUACIÓN.

Peligro de objetos despididos

EXISTE LA POSIBILIDAD DEL RIESGO DE LESIONES A LOS OPERADORES Y TRANSEÚNTES CAUSADAS POR OBJETOS DESPEDIDOS DURANTE LA OPERACIÓN DE LA SEGADORA POR LOS SIGUIENTES:

OBJETOS (PIEDRAS, ESCOMBROS, HOJAS ROTAS DE LA SEGADORA, PERNOS DE LA HOJA, CABLES, CADENAS, ALAMBRE, ETC.) DESPEDIDOS POR LA SEGADORA.

Dispositivos protectores del equipo y prácticas de seguridad recomendadas

La cubierta de la segadora y los dispositivos protectores no pueden evitar que escapen todos los objetos o desechos del área cerrada de la hoja en todas las condiciones de segado. Es posible que los objetos escapen y se desplacen cientos de pies (300 [100 m]).

PRÁCTICAS DE SEGURIDAD RECOMENDADAS

Lea los manuales del operador del fabricante para conocer las prácticas de seguridad recomendadas durante la operación. Explique las prácticas a los usuarios u operadores que no puedan leer.

PARA AYUDAR A EVITAR LESIONES GRAVES O LA MUERTE CAUSADAS POR OBJETOS QUE GOLPEEN AL OPERADOR U OTRAS PERSONAS HAGA LO SIGUIENTE:

SEGURIDAD DE TRANSEÚNTES

- Mantenga a los transeúntes a varios cientos de pies (300 [100 m]) del área segada.

SEGURIDAD PROPORCIONADA POR LOS DISPOSITIVOS PROTECTORES DEL EQUIPO

Para contener, desviar o reducir los objetos despididos del área cerrada de la hoja:

- Mantenga la cadena, blindajes deflectores flexibles o sólidos colocados en la parte delantera y trasera de la cubierta de la segadora, en su lugar y en buen estado de funcionamiento.
- No opere el equipo con los blindajes para objetos despididos dañados o sin que estén colocados en su lugar.

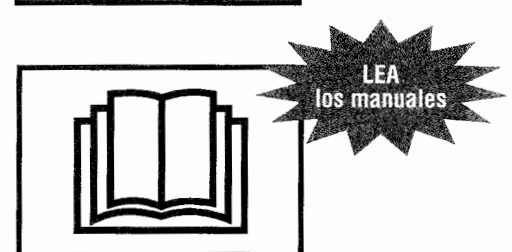

SEGURIDAD DEL OPERADOR

La operación de las segadoras con las alas levantadas, de montaje lateral y pescante, pueden reducir la efectividad del blindaje para proteger al operador contra los objetos despedidos de la segadora.

Haga lo indicado a continuación para aumentar la protección del operador contra los objetos despedidos durante las operaciones de segado:

- Use cabinas cerradas con una estructura de protección contra vuelcos (ROPS), cubiertas protectoras especiales, mallas u otros dispositivos para proteger al operador cuando efectúa estas operaciones.

SOBREPASAR LAS VELOCIDADES RECOMENDADAS PARA LA TOMA DE FUERZA (PTO)

No sobrepase las velocidades recomendadas por el fabricante para la toma de fuerza (PTO).

Las velocidades excesivas de la toma de fuerza (PTO) pueden causar:

- Fallo de la hoja
- Escape de objetos a velocidad alta u hojas rotas despedidas del área cerrada de la hoja de la segadora.
- Fallos potenciales de la línea de transmisión de 540 rpm cuando se opera a velocidades de 750 a 1000 rpm.

OTRAS PRÁCTICAS DE SEGURIDAD:

- Nunca debe operar la segadora con hojas rotas, dobladas, faltantes o que estén extremadamente desgastadas.
- Antes de segar retire los desechos y objetos extraños para evitar que sean recogidos y despedidos por la segadora.
- No debe operar la segadora durante el transporte o en posición de ala levantada.

PRÁCTICAS DE MANTENIMIENTO RECOMENDADAS

Lea los manuales del operador del fabricante para conocer sobre la inspección y mantenimiento de las defensas de la cadena y blindaje deflector flexible o sólido:

- Reemplace las defensas desgastadas o dañadas y los demás blindajes antes de segar.
- Use solamente las defensas y blindajes de reemplazo del fabricante. Otras defensas o blindajes pueden no encajar, o los materiales pueden no ser adecuados para cumplir con los requisitos de resistencia del equipo.
- Reemplace las calcomanías desgastadas o dañadas y las instrucciones de advertencia.
- Explique las instrucciones de inspección y mantenimiento a los usuarios u operadores que no puedan leer.

USE cabinas cerradas con una estructura protectora contra vuelcos (ROPS) o cubiertas protectoras

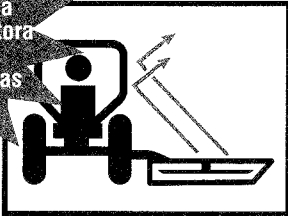

USE la velocidad apropiada de la toma de fuerza (PTO)

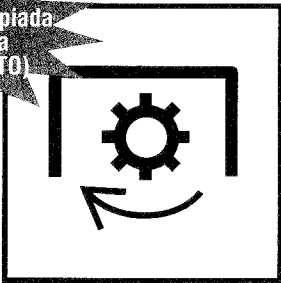

DÉ MANTENIMIENTO a su equipo

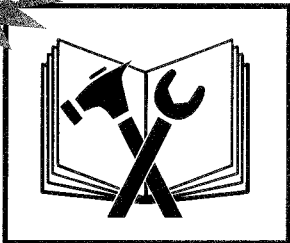

Peligros y riesgos de las hojas rotativas y línea de transmisión

EXISTE EL RIESGO DE POSIBLES LESIONES A LOS OPERADORES DE LA SEGADORA Y TRANSEÚNTES DURANTE LAS OPERACIONES DE SEGADO CAUSADAS POR LO SIGUIENTE:

- CONTACTO DEL CUERPO CON LAS HOJAS ROTATIVAS.
- ENREDO DEL CUERPO CON LAS LÍNEAS DE TRANSMISIÓN Y PIEZAS ROTATIVAS.

Dispositivos protectores del equipo y prácticas de seguridad recomendadas

PRÁCTICAS DE SEGURIDAD RECOMENDADAS

Lea los manuales del operador del fabricante para conocer las prácticas de seguridad recomendadas. Explique las prácticas a los usuarios u operadores que no puedan leer. Para evitar el riesgo de lesiones graves o la muerte causadas por el contacto con la hoja en movimiento, línea de transmisión o enredo de los operadores u otras personas haga lo siguiente:

SEGURIDAD DE TRANSEÚNTES

- No debe operar cerca de transeúntes.
- Mantenga a otras personas a varios cientos de pies (300 [100 m]) del área de segado.

PRÁCTICAS DE SEGURIDAD DEL OPERADOR

- No permita pasajeros en el tractor o segadora. Asegúrese el cinturón de seguridad durante el segado.
- Use la práctica de parada del equipo apropiada antes de dar servicio, ajustar, limpiar o eliminar las obstrucciones de la segadora.
- Manténgase alejado de las hojas rotativas, piezas y líneas de transmisión.
- Nunca arranque el motor del tractor mientras esté de pie al lado del equipo.
- Solamente arranque el motor del tractor cuando esté sentado en el asiento del operador con el cinturón de seguridad abrochado.

PRÁCTICAS DE SEGURIDAD RECOMENDADAS PARA DEFENSAS Y BLINDAJES DE LA LÍNEA DE TRANSMISIÓN

- Mantenga las líneas de transmisión y otros blindajes colocados y en buen estado.
- No debe operar la segadora cuando las defensas, defensas de la línea de transmisión u otros blindajes hagan falta o estén dañados.

PRÁCTICAS DE SEGURIDAD RECOMENDADAS

Lea los manuales del operador del fabricante para conocer las instrucciones sobre defensas, defensas de la línea de transmisión y otros blindajes:

- Reemplace las defensas, defensas de la línea de transmisión y otros blindajes desgastados o dañados antes de segar.
- Use solamente defensas y blindajes de reemplazo hechas por el fabricante. Otras defensas o blindajes pueden no encajar o ser de materiales inadecuados que no cumplan con los requisitos de resistencia del equipo.
- Reemplace las calcomanías e instrucciones de advertencia desgastadas o dañadas.
- Explique las instrucciones de inspección y mantenimiento a los usuarios u operadores que no puedan leer.



EVITE enredarse

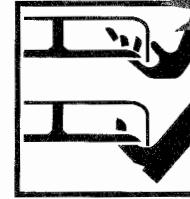

EVITE las piezas rotativas



LEA los manuales



ASEGÚRESE el cinturón de seguridad



NO LLEVE PASAJEROS



EVITE el ser atropellado



DÉ MANTENIMIENTO a su equipo

EVITE vuelcos

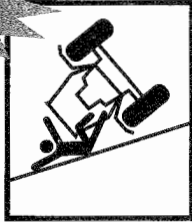

USE la estructura contra vuelcos (ROPS) del tractor



LEA los manuales

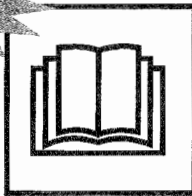

AGREGUE balasto



AUMENTE el espacio entre las ruedas y AGREGUE balasto en el lado contrario



ASEGURESE el cinturón de seguridad



EVITE EL APLASTAMIENTO asegure el ala



Peligros y riesgos de rodamiento o vuelco del tractor y segadora

EXISTE UN RIESGO DE LESIONES POSIBLES AL OPERADOR POR RODAMIENTO O VUELCO DE LA SEGADORA DURANTE LAS OPERACIONES DE SEGADO POR LO SIGUIENTE:

- TERRENO ACCIDENTADO, PENDIENTES INCLINADAS, AGUJEROS, BACHES, SURCOS, PIEDRAS, TRONCOS U OTRAS OBSTRUCCIONES QUE PODRÍAN VOLCAR EL TRACTOR Y SEGADORA.
- VELOCIDADES ABSOLUTAS EXCESIVAS PARA ESTAS CONDICIONES DE TERRENO.

Dispositivos protectores del equipo y prácticas de seguridad recomendadas

Cuando sea posible, retire los troncos, piedras, etc., o márquelos claramente con las demás obstrucciones para evitar vuelcos, averías y condiciones de conducción peligrosas. Tenga extremo cuidado para mantener el control sobre el equipo cuando opere en terrenos con estas condiciones.

ESTRUCTURAS CONTRA VUELCO (ROPS) RECOMENDADAS PARA TRACTORES

Un tractor equipado con una estructura contra vuelcos (ROPS) o cabina ROPS cerrada y cinturón de seguridad para la seguridad del operador, es esencial para la protección adicional del operador, cuando opera en terrenos con estas condiciones

AJUSTES RECOMENDADOS PARA LA ESTABILIDAD DEL TRACTOR

Lea el manual del operador del tractor para conocer los ajustes para aumentar la estabilidad del tractor:

- Agregue pesas o balasto a las ruedas delanteras y traseras.
- Ajuste el espacio entre las ruedas al ancho máximo.
- Agregue contra balasto en el lado contrario a las segadoras de montaje lateral y de pescante.
- Explique los ajustes a los usuarios u operadores que no puedan leer.

PRÁCTICAS DE SEGURIDAD RECOMENDADAS

Lea los manuales del operador del fabricante para conocer las prácticas de seguridad de operación recomendadas. Explique las prácticas a los usuarios u operadores que no puedan leer. **Para evitar lesiones graves o la muerte del operador por el vuelco del tractor y segadora, haga lo siguiente:**

- Abroche firmemente el cinturón de seguridad cuando seque con tractores equipados con una estructura contra vuelcos (ROPS).
- Evite la velocidad absoluta excesiva de acuerdo con las condiciones del terreno.
- Evite los arranques, paradas y virajes repentinos cuando opere subiendo, bajando o atravesando pendientes.
- Evite las condiciones de terreno resbaloso.
- Haga virajes anchos y graduales.
- Planifique segar cuesta abajo en pendientes inclinadas para evitar los vuelcos.

Peligros y riesgos de aplastamiento por una segadora o piezas desprendidas

EXISTE EL RIESGO DE UNA LESIÓN POR APLASTAMIENTO PARA LOS OPERADORES Y OTRAS PERSONAS DURANTE LAS OPERACIONES DE SEGADO DEBIDO A LO SIGUIENTE:

- SEGADORA O EQUIPO DESPRENDIDO DEBIDO A FALLO DEL SISTEMA HIDRÁULICO.
- FALLO EN DAR SOPORTE, BLOQUEAR O ASEGURAR COMPLETAMENTE LA SEGADORA O PIEZAS DEL EQUIPO.

Dispositivos protectores del equipo y prácticas de seguridad recomendadas

Lea los manuales del operador del fabricante para conocer las prácticas de seguridad de operación recomendadas. Explique las prácticas a los usuarios u operadores que no puedan leer. **Para ayudar a evitar lesiones serias o la muerte de los operadores y otras personas causadas por la caída de la segadora o piezas de equipo, haga lo siguiente:**

PRÁCTICAS DE SEGURIDAD RECOMENDADAS

Antes de trabajar cerca o debajo de la segadora o piezas de equipo en posición levantada:

- Use la práctica de parada del equipo apropiada antes de dar servicio, ajustar, limpiar o eliminar las obstrucciones de la segadora.
- Soporte o coloque bloques firmemente debajo de la segadora o piezas de equipo.
- En las segadoras de tipo ala coloque bloques o asegure firmemente las alas con los seguros o baje al suelo la segadora o piezas del equipo.
- Use los seguros de transporte cuando transporte la segadora en caminos públicos.

Peligros y riesgos por la fuga de fluido hidráulico a presión alta

EXISTE UN RIESGO PARA LOS OPERADORES DE SEGADORAS Y OTRAS PERSONAS DE UNA POSIBLE INYECCIÓN DE FLUIDO A PRESIÓN ALTA O GANGRENA CAUSADA POR LA INYECCIÓN EN LA PIEL DE ACEITE HIDRÁULICO O DIESEL.

PARA EVITAR LA GANGRENA, EL FLUIDO INYECTADO DEBE SER ELIMINADO QUIRÚRGICAMENTE EN POCAS HORAS, POR UN MÉDICO FAMILIARIZADO CON ESTE TIPO DE LESIÓN.

PRÁCTICAS DE SEGURIDAD RECOMENDADAS

Lea los manuales del operador del fabricante para conocer las prácticas de seguridad recomendadas. Explique las prácticas a los usuarios u operadores que no puedan leer. Las fugas de fluido a presión alta por agujeros minúsculos pueden ser casi invisibles.

Para ayudar a evitar lesiones serias o la muerte haga lo siguiente:

- Busque las fugas con pedazos de cartón o madera.
- No use las manos para verificar la presencia de fugas.
- Descargue la presión del sistema antes de desconectar los conductos.
- Antes de aplicar presión al sistema:
 - Revise que los conductos, tuberías y mangueras no estén dañados.
 - Revise que las conexiones estén apretadas.
- Antes de operar los sistemas presurizados:
 - Descargue el aire del sistema.
 - Haga referencia al (los) manual(es) del operador del fabricante para obtener instrucciones.
 - Explique los procedimientos a los usuarios u operadores que no puedan leer.

Peligros y riesgos durante el llenado de combustible del tractor

Para evitar las lesiones serias o la muerte por incendio durante el llenado:

- Apague el motor y la ignición.
- Nunca llene el tanque de combustible cerca de llamas descubiertas.
- Nunca fume mientras llena combustible.
- Evite las chispas causadas por la electricidad estática poniendo a tierra la boquilla del combustible contra el cuello de llenado del tanque.
- Evite sobrellenar el tanque o derramar el combustible.
- Limpie inmediatamente el combustible derramado.
- Siempre vuelva a colocar la tapa del combustible.

Para evitar lesiones serias o la muerte causadas por las emanaciones del escape del motor:

- Ventile adecuadamente los espacios cerrados antes de arrancar el motor.



LEA los manuales

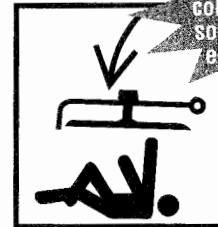

EVITE EL APLASTAMIENTO coloque bloques o soportes seguros en la segadora



FLUIDO A PRESIÓN ALTA puede inyectarse en el cuerpo

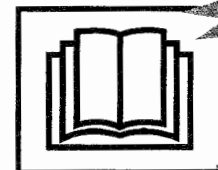

LEA los manuales

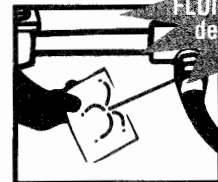

EVITE LA INYECCIÓN DE FLUIDO use un pedazo de cartón, no use las manos

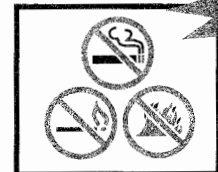

EVITE los incendios y las explosiones

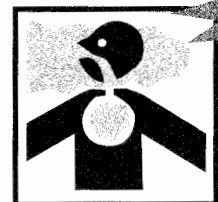

EVITE las emanaciones del escape

Cumpla con un programa de seguridad



LA SEGURIDAD ES IMPORTANTE PARA LOS PROPIETARIOS Y OPERADORES RESPONSABLES DE TRACTORES Y SEGADORAS. HAGA LO SIGUIENTE PARA SU SEGURIDAD DURANTE LA OPERACIÓN DE SEGADO:

SEA UN OPERADOR CAPACITADO HACIENDO LO SIGUIENTE:

- Leyendo, comprendiendo y obedeciendo las instrucciones escritas del fabricante en el (los) manual(es) del operador y avisos de seguridad en la segadora y tractor.
- Recibiendo capacitación operativa para la segadora y tractor.
- Solicitando a su distribuidor de equipo o supervisor que le explique lo que usted no comprende.
- Explicando las instrucciones escritas en el (los) manual(es) del operador y avisos de seguridad (calcomanías) en la segadora y tractor a los usuarios u operadores que no puedan leer.

Seguridad previa a la operación

Conozca las reglas y reglamentaciones de seguridad del lugar de trabajo

Pregunte a su supervisor sobre las reglas de seguridad de operación del equipo que usted deberá obedecer.

Algunas reglas para su seguridad y la de los demás:

- Un tractor equipado con una estructura contra vuelcos (ROPS) es necesario para la protección del operador durante las operaciones de segado.
- Conozca la capacidad y características de operación de la segadora y tractor.
- Nunca altere o desmonte el equipo de seguridad.
- Nunca permita que niños o personas no capacitadas operen una segadora o tractor.
- Nunca permita pasajeros en la segadora o tractor.
- Mantenga a otras personas alejadas de la operación de segado.
- Use la práctica apropiada para parar el equipo antes de bajarse del tractor.
- Permita que se detengan todas las piezas móviles antes de efectuar inspecciones, reparaciones o ajustes al equipo.
- Soporte o coloque bloques firmemente debajo de la segadora antes de trabajar debajo de la segadora o componentes elevados.
- Use la ropa protectora y dispositivos de seguridad personal que le han sido asignados o recomendados por el fabricante del equipo.



Conozca los controles del tractor y segadora

Conozca lo siguiente sobre su tractor y segadora:

- Función, propósito y uso de los controles.
- Velocidades seguras de operación.
- Capacidad para operar en forma segura en pendientes y terreno accidentado.
- Características de frenado y dirección.
- Espacios libres necesarios para la operación del tractor y segadora.
- Cómo detener rápidamente el equipo cuando haya una emergencia.



Use todos los dispositivos de seguridad del equipo disponibles

Para ayudar a mantener su seguridad y la de las personas que lo rodean:

- Asegúrese de que las defensas, blindajes y avisos de seguridad recomendados por el fabricante están instalados en el equipo y en buen estado.
- Mantenga todos los dispositivos protectores en su lugar y abrochados firmemente.
- **NUNCA** debe operar su equipo con los dispositivos de seguridad sin colocar, desconectados o dañados.
- Use el balasto y peso requerido para la estabilidad operativa del equipo.

Inspeccione el equipo de la segadora y tractor

Antes de comenzar su día de trabajo:

- Revise que no haya piezas del tractor y segadora que estén sueltas, rotas, dañadas o que no estén colocadas en su lugar.
- Repare o reemplace estas piezas cuando sea necesario.
- Verifique que los implementos del tractor y segadora sean los apropiados.
- Verifique que sean iguales las rpm de régimen de la toma de fuerza (PTO) a las del tractor y de la segadora.
- Revise el estado de las hojas de la segadora. Afile o reemplace de acuerdo con las recomendaciones del fabricante. Las modificaciones a las hojas como soldadura o endurecimiento de los bordes cortantes con soldadura o enderezado de las hojas dobladas, pueden reducir la resistencia de las hojas y afectar adversamente las propiedades y seguridad de las hojas.
- Verifique que todas las defensas y blindajes estén colocados en su lugar y que todo el equipo esté en buen estado de funcionamiento. Esto incluye la línea de transmisión de la toma de fuerza (PTO), caja de engranajes, defensas y blindajes del implemento que sirven para la protección del operador.
- Verifique que la horqueta de la línea de transmisión y los dispositivos de seguro estén correctamente asegurados.
- Verifique que los sistemas hidráulicos del tractor y segadora no estén dañados ni tengan fugas.
- Revise y lea los avisos de seguridad y las instrucciones de advertencia.
- Explique los avisos de seguridad e instrucciones de advertencia a los usuarios u operadores que no puedan leer.

Inspeccione el área de trabajo

Inspeccione, identifique y evite las condiciones peligrosas en el área de trabajo:

- Terreno accidentado, bajadas escarpadas, zanjas, agujeros, pendientes inclinadas, troncos, agua estancada, suelo de lodo suave, condiciones resbalosas, desechos y objetos extraños.
- Inspeccione el área de segado y elimine o marque todos los objetos extraños y desechos que debe evitar con la segadora.

Analice el área de segado para establecer:

- El mejor y más seguro procedimiento de segado.
- Tipo de material y altura de segado.
- Estado del terreno de operación.
- El uso de un patrón de segado de desplazamiento hacia delante siempre que sea posible.

Verifique la seguridad de las demás personas

Antes de arrancar el equipo:

- Camine alrededor del equipo.
- Verifique que no haya nadie debajo, sobre o cerca del equipo.
- Aleje a todas las personas de estas áreas.
- Haga sonar una alarma.



USE UNA ESTRUCTURA CONTRA VUELCOS (ROPS) y el cinturón de seguridad

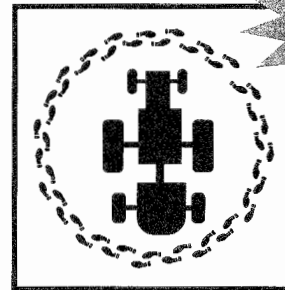

CAMINE ALREDEDOR para inspeccionar

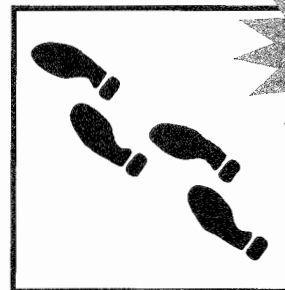

CAMINE ALREDEDOR del lugar de trabajo

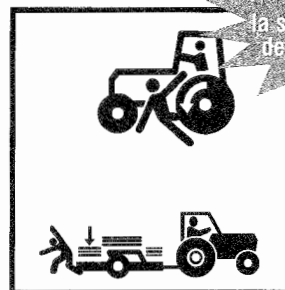

VERIFIQUE la seguridad de las demás personas

Seguridad durante el arranque y prueba

USE
el contacto de
tres puntos



USE UNA
ESTRUCTURA
CONTRA VUELCOS
(ROPS) y el
cinturón de
seguridad



USE la
velocidad
correcta de la
toma de fuerza
(PTO)



Seguridad durante la subida al tractor

Antes de subir:

- Límpiense los zapatos y las manos.

Durante la subida y la bajada del tractor:

- Use las asas y placas de los escalones.
- Nunca utilice los volantes de dirección o controles como asas.
- Nunca suba ni baje de un tractor en movimiento.

Prueba de seguridad de los controles del tractor y segadora

Antes del arranque:

- Ajuste y abroche el cinturón de seguridad en su tractor equipado con una estructura contra vuelcos (ROPS).
- Verifique que el freno de estacionamiento esté enganchado.
- Verifique que desenganche la toma de fuerza (PTO).
- Verifique que todos los controles estén en la posición de punto muerto (N) o de estacionamiento (P).
- Advierta a las demás personas presentes en el área antes de arrancar el tractor.
- Cumpla con los procedimientos de arranque recomendados por el fabricante del tractor.

Después del arranque:

- Revise que todos los instrumentos, indicadores y luces indicadoras funcionen normalmente.
- Revise que todos los controles, dirección y frenos del tractor funcionen apropiadamente.
- Repare un tractor que no esté funcionando apropiadamente antes de usarlo.
- Suba y baje la segadora cuando la línea de transmisión llegue al fondo o cuando existen problemas de enganche.
- Verifique que su equipo no vibre excesivamente y que no tenga ruidos anormales.
- Use prácticas apropiadas para detener el equipo antes de inspeccionarlo.

Seguridad en el sistema de toma de fuerza y segadora

Tractores con sistemas de doble velocidad (540 ó 1000 rpm) toma de fuerza (PTO) de cambios.

Para evitar las lesiones serias o la muerte por el fallo de piezas causado por la sobrevelocidad de la segadora:

- Asegúrese de colocar el selector de la toma de fuerza (PTO) a la velocidad de régimen de las rpm de la toma de fuerza (PTO).

Tractores con sistemas con toma de fuerza (PTO) impulsados por la transmisión.

Una segadora rotativa tendrá un efecto significativo de volante, que puede continuar impulsando el tractor cuando tiene un sistema de toma de fuerza (PTO) impulsado por la transmisión.

El tractor debe estar equipado y ser operado como se indica a continuación:

- Instale un embrague de sobremarcha.
- Permítase suficiente espacio y tiempo para maniobrar anticipando los virajes, paradas y reducciones de velocidad.

Seguridad durante la operación

Seguridad durante el enganche de la segadora al tractor

Seguridad en el montaje de la segadora con un enganche de tres puntos:

- Haga referencia a los manuales de los fabricantes de la segadoras y el tractor.
- Coloque la palanca selectora del elevador de potencia hidráulica del tractor (eje de balancín) en posición baja para evitar el movimiento inesperado.
- Explique los procedimientos de enganche a los usuarios u operadores que no puedan leer.

Seguridad en el montaje de la segadora con enganche de tipo tiro:

- Haga referencia a los manuales del fabricante de la segadora y tractor.
- Utilice solamente un enganche de barra de tiro.
- No la enganche al eje trasero del tractor ni a los brazos del enganche de tres puntos.
- Ajuste la longitud de la barra de tiro del tractor para la operación de la toma de fuerza (PTO) de 540 ó 1000 rpm.

Comience el uso de la segadora en forma correcta para mayor seguridad

Segue solamente durante el día o cuando exista iluminación artificial adecuada.

Para evitar las lesiones serias o la muerte causadas por objetos despedidos por la segadora o contacto con las hojas:

- Mantenga los blindajes de la cadena, blindajes deflectores flexibles o sólidos, conductos de descarga, colocados en su lugar y en buen estado.
- Mantenga a todas las personas a varios cientos de pies (300 [100 m]) de la operación de segado.
- Nunca dirija hacia ninguna persona la descarga de la segadora.
- Mantenga las manos, pies y otras partes del cuerpo alejadas de las piezas rotativas, hojas y agujeros de descarga.
- No debe operar la segadora en posición de transporte.

Enganche de la transmisión, toma de fuerza (PTO) de la segadora:

- Suba la segadora a la altura máxima de corte.
- Enganche la toma de fuerza (PTO) con rpm bajas del motor.
- Aumente las rpm del motor a la velocidad de régimen de las rpm de la toma de fuerza (PTO).
- Baje la segadora a la altura de corte deseado.
- Deténgase y pare inmediatamente si la segadora golpea una obstrucción.
- Inspeccione y repare cualquier daño que tenga la segadora antes de reiniciar el segado.
- No debe operar la segadora cuando tenga vibración excesiva o ruidos anormales.

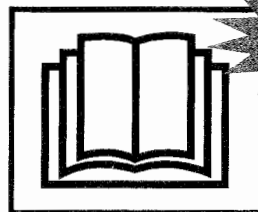

LEA los manuales

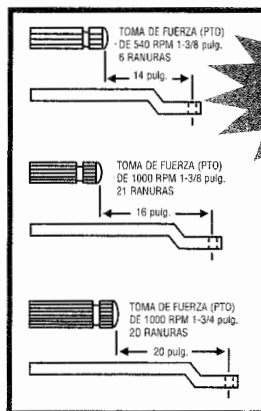

Ajuste de la barra de tiro del TRACTOR

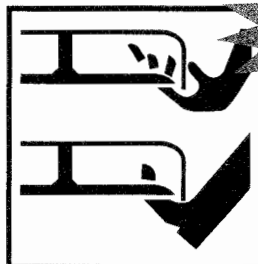

Mantenga la distancia de LAS HOJAS ROTATIVAS

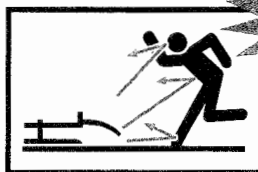

MANTENGA alejados a los transeúntes

CUIDE
que no haya
más personas

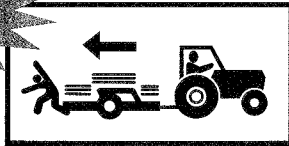

MANTENGA
el rodillo
trásero de la
desgranadora

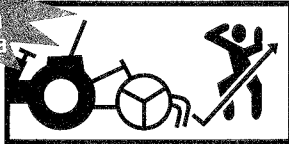

USE las
velocidades
absolutas
apropiadas

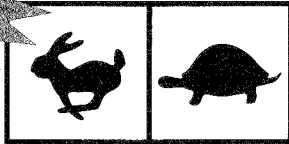

DETENGA
LA HOJA
antes de eliminar
obstrucciones



ESTABLEZCA
QUE el espacio
libre sea adecuado
para la oscilación
de la segadora

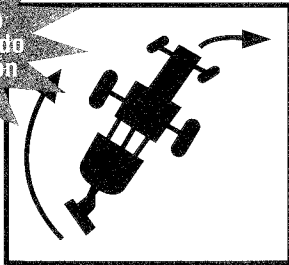

NUNCA
PERMANEZCA
DE PIE sobre
la defensa de
la segadora

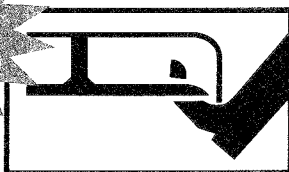

MANTENGA
EL CONDUCTO
colocado en
su lugar

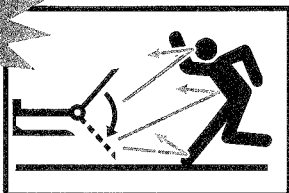

Seguridad durante el segado en marcha atrás

Evite segar en marcha atrás siempre que sea posible.

Haga lo siguiente cuando segue en marcha atrás:

- Verifique que no haya personas atrás de la segadora antes de dar marcha atrás.
- Use extremo cuidado al invertir la dirección del segado.
- Mantenga los blindajes de seguridad delanteros y traseros y los blindajes delanteros de la desgranadora y los rodillos traseros de la segadora rotativa.

Velocidad absoluta de segado

La velocidad absoluta depende de las condiciones del terreno, tipo de pasto, densidad y la altura de corte:

- El alcance normal de la velocidad absoluta es de 2 a 5 mph.
- La velocidad absoluta debe ser menor cuando segue pasto alto y denso.
- La velocidad absoluta puede ser mayor cuando segue pasto de altura mediana, delgado y cuando las condiciones del terreno sean uniformes.
- Use una velocidad absoluta menor cuando segue en pendientes accidentadas o terreno desconocido.

Segado de pasto extremadamente alto

- Puede ser necesario segar dos veces el pasto extremadamente alto.

Primera pasada de segado:

- Haga un corte alto al pasto (10-15 pulgadas [25-38 mm]) para evitar objetos escondidos.

Segunda pasada de segado:

- Retire los desechos y otros objetos.
- Corte el pasto a la altura deseada y a 90 grados de la primera pasada siempre que sea posible.
- Use las prácticas apropiadas de parada del equipo para su seguridad al bajar del tractor.

Vigile los espacios libres del equipo

Las segadoras con enganche de tres puntos y de montaje lateral tienen un arco de viraje mayor que las segadoras de tiro. Permita suficiente espacio libre para virar con seguridad.

Seguridad en el uso de las segadoras montadas en la parte inferior

Cuando segue con una segadora montada en la parte inferior:

- Mantenga el conducto de descarga desmontable colocado en su lugar sobre el agujero de descarga.
- Nunca permanezca de pie sobre la cubierta de una segadora que esté en operación.
- Distribuya el pasto cortado con el conducto de descarga hacia el área ya segada.
- Use las prácticas apropiadas para la parada del equipo antes de eliminar las obstrucciones de la segadora o conducto de descarga.

Riesgos y peligros de obstrucciones elevadas cuando se usan segadoras de ala o pescante

Verifique que no haya obstrucciones elevadas cuando use segadoras con alas levantadas o de tipo pescante, para evitar lesiones graves o la muerte causadas por el contacto con:

- Líneas de transmisión de energía eléctrica.
- Ramas bajas de árboles.
- Otras obstrucciones elevadas.

Seguridad en el uso de las segadoras de ala y de montaje lateral

Cuando utilice segadoras de ala y de montaje lateral:

Las posiciones con el ala levantada reducen la protección del blindaje y aumentan los riesgos de objetos despedidos y de contacto con la hoja.

Para evitar las lesiones serias o la muerte causadas por objetos despedidos o contacto con la hoja por la subida y bajada de las alas durante las operaciones de segado:

- No segue cuando haya transeúntes en el área de segado.
- Asegúrese de que no haya personas cerca cuando suba o baje las alas.
- Mantenga el período de tiempo durante el que está expuesta la hoja rotativa del ala, a un mínimo práctico durante las operaciones de segado con el ala levantada.
- Detenga el segado si entran personas en el área de segado.
- Solamente suba el ala para pasar sobre objetos que se encuentren en el camino de segado o para seguir la inclinación del terreno.
- Desenganche la transmisión del ala durante los períodos prolongados de segado con las alas levantadas.
- Después de pasar sobre un objeto o sobre inclinaciones del terreno, baje el ala levantada, al suelo.
- Permita que todas las hojas de la segadora detengan su rotación antes de levantar las secciones del ala durante otras operaciones.

Seguridad durante el segado de los bordes de las zanjas

Use cuidado extremo cuando sigue los bordes de las zanjas. Vigile para ver si hay derrumbes, áreas erosionadas y obstrucciones para el segado a lo largo del borde de la zanja. El extremo delantero del tractor puede desviarse hacia la zanja al golpear las obstrucciones con las segadoras de montaje lateral o de pescante.

Las operaciones con segadoras con alas levantadas y pescantes pueden reducir la efectividad del blindaje para objetos despedidos de la segadora que sirven para proteger al operador.

Para aumentar la protección del operador de objetos despedidos durante las operaciones en los bordes de las zanjas:

- Use cabinas cerradas con una estructura contra vuelcos (ROPS), cubiertas protectoras especiales y otros blindajes para el operador, cuando efectúe estas operaciones.
- Inspeccione el área de segado y retire o marque todos los objetos extraños y desechos que deben evitarse con la segadora.



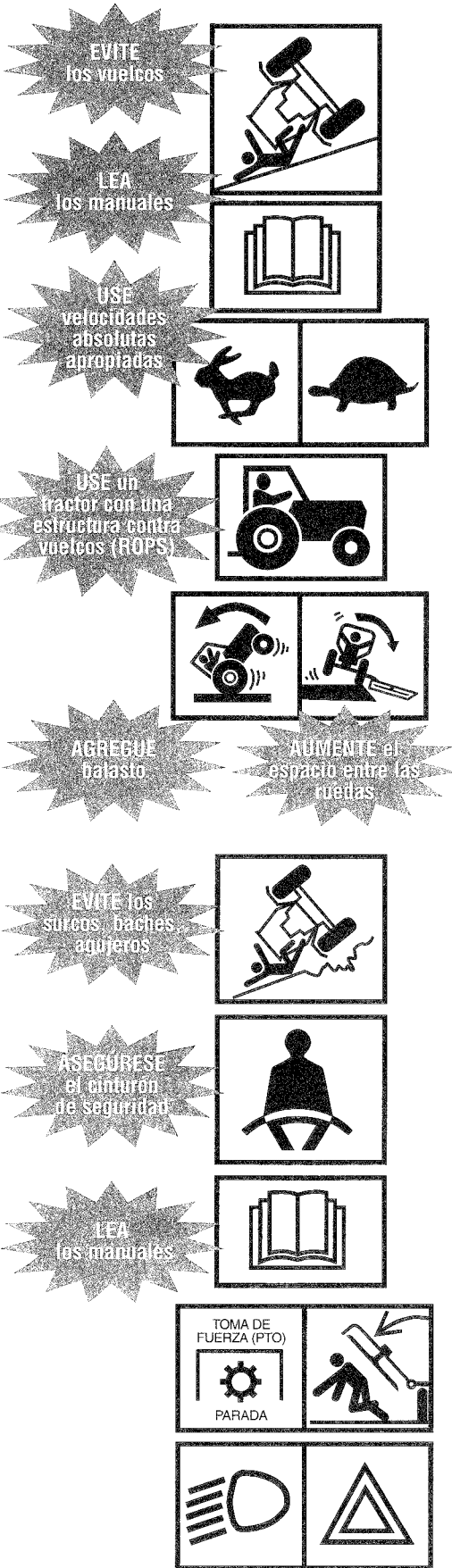

Seguridad durante el segado de terreno accidentado

La estabilidad del tractor y segadora se reduce en las pendientes y terreno accidentado.

Usted puede evitar el vuelco del tractor y segadora y mantener el control de la estabilidad del equipo haciendo lo siguiente:

- Revisando los manuales del operador del tractor y segadora para conocer las prácticas de seguridad de operación en pendientes y terreno accidentado. Explique las prácticas a los usuarios u operadores que no puedan leer.
- Evitando operar en pendientes extremadamente inclinadas.
- Usando cuidado extremo para mantener el control sobre su equipo cuando opere en estas condiciones.
- Aumentando la estabilidad del tractor, agregando pesas a las ruedas y aumentando el espacio entre las mismas, (haga referencia al manual del operador del tractor para conocer las recomendaciones).
- Usando un tractor equipado con una estructura contra vuelcos (ROPS) y cinturón de seguridad para la seguridad del operador durante las operaciones de segado.
- Manteniendo una velocidad absoluta mínima.
- Haciendo virajes anchos y graduales.
- Evitando arranques, paradas y virajes repentinos cuando opere subiendo, bajando o atravesando las pendientes.
- No subiendo del suelo las segadoras montadas atrás o lateralmente ni las alas de segado durante estas operaciones.
- Manteniéndose alerta por si hubiera agujeros, baches, surcos, piedras, troncos u otras obstrucciones que podrían volcar el tractor y segadora.
- Evitando las condiciones de suelo resbaloso que podrían volcar el tractor y segadora.
- Evitando que el tractor y segadora queden atascados al pasar diagonalmente sobre declives y bajadas escarpadas pronunciadas.

Use extremo cuidado para mantener la estabilidad del equipo durante todas las operaciones sobre terreno accidentado y pendientes. Usted tiene la palabra final referente a cualquier pendiente que pueda ser trabajada en forma segura.

Seguridad durante el transporte del equipo en caminos

Si es necesario conducir el equipo sobre los caminos públicos:

- Haga referencia al manual del operador del fabricante del tractor y segadora para conocer las instrucciones.
- Explique las instrucciones a los usuarios u operadores que no puedan leer.
- Verifique las reglamentaciones locales referentes a las marcas, luces, luces intermitentes, etc., requeridas del equipo para el desplazamiento sobre caminos públicos. Se requiere de luces para las segadoras que obstruyen las luces traseras del tractor y/o las luces de advertencia.

Antes del transporte en caminos públicos:

- Desenganche la toma de fuerza (PTO) conectada a la segadora.
- Suba la segadora a la posición de transporte.
- Asegure las alas en la posición de transporte con los seguros en las segadoras de tipo ala y de montaje lateral.
- Enganche la cadena de seguridad entre la segadora de tipo tiro y el tractor.
- Asegúrese de que las luces, luces intermitentes, reflectores y avisos de vehículo de movimiento lento (SMV) están colocados y visibles.
- Revise que el emblema de vehículo de movimiento lento (SMV) sea visible para cualquier vehículo que se acerque desde atrás.

Cuando transporte en caminos públicos:

- Obedezca todas las reglamentaciones locales de tráfico.
- Acérquese a las intersecciones con precaución.
- Cumpla con los avisos de velocidad y de control de tráfico.
- Evite las paradas bruscas y doblar repentinamente.

Seguridad durante el estacionamiento

Estacione el equipo en:

- Áreas designadas o alejadas del tráfico.
- Preferentemente utilice lugares en terreno nivelado.

Lugares de estacionamiento en terreno inclinado:

- Coloque el equipo en posición transversal en las pendientes.
- Aplique los frenos de estacionamiento.
- Baje la segadora al suelo.
- Coloque bloques en las ruedas del tractor.

Antes de estacionar temporalmente y abandonar el equipo incapacitado cerca de áreas con tráfico:

- Retire el equipo de los caminos públicos.
- Coloque las banderas de advertencia.
- Use las luces intermitentes del tractor.

Seguridad durante la parada

Para su seguridad use las prácticas apropiadas para la parada del equipo

Haga referencia al (los) manual(es) del operador del fabricante del tractor y segadora para conocer los procedimientos de parada recomendados. Explique los procedimientos a los usuarios u operadores que no puedan leer.

Haga que los procedimientos apropiados de parada del equipo sean una costumbre importante que se debe practicar. Siga estas prácticas de seguridad antes de bajarse del tractor:

- Desenganche el embrague y transmisión de la toma de fuerza (PTO).
- Para que el motor enfríe gradualmente permita que funcione al ralentí.
- Coloque los controles en estacionamiento (P) o en punto muerto (N).
- Coloque el freno de estacionamiento.
- Baje la segadora al suelo.
- Baje al suelo las alas de las segadoras de tipo ala.
- Apague el motor.
- Espere a que todas las piezas movibles se detengan antes de efectuar inspecciones, ajustes o reparaciones al equipo.
- Descargue la presión hidráulica moviendo los controles hidráulicos varias veces en todas las direcciones.
- Asegure la ignición y extraiga la llave cuando el equipo debe ser inspeccionado, reparado, ajustado o va a permanecer desatendido.
- Asegure las cubiertas contra el vandalismo cuando el equipo permanece desatendido.
- Baje cuidadosamente manteniendo un contacto de tres puntos.

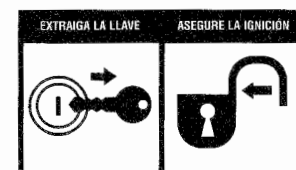
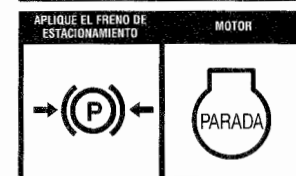

ESPERE que las piezas móviles se detengan antes de bajar

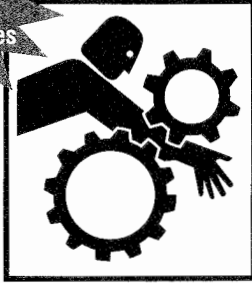

USE el contacto de tres puntos



DE MANTENIMIENTO a su equipo

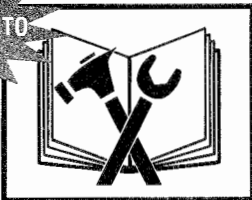

CUMPLA

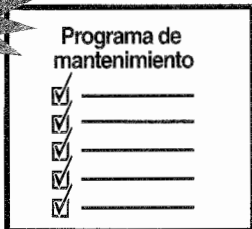

Seguridad durante la bajada del tractor

Antes de bajar del tractor haga lo siguiente:

- Para su seguridad, use las prácticas apropiadas para la parada del equipo.
- Baje el implemento al suelo, apague el motor y la toma de fuerza (PTO), aplique los frenos, permita que se detengan todas las piezas móviles y extraiga la llave antes de bajar del tractor.
- Nunca baje del equipo cuando esté en movimiento.
- Nunca salte de las máquinas.
- Baje cuidadosamente.
- Verifique que los escalones no estén resbalosos.
- Mantenga los pies y manos alejados de los controles.
- Use las asas para las manos y los escalones para bajar.
- Vea hacia la máquina y use el contacto de 3 puntos (2 manos, 1 pie ó 2 pies, 1 mano).

Seguridad durante el mantenimiento

Seguridad durante el mantenimiento

Para su seguridad haga lo siguiente antes de efectuar procedimientos de mantenimiento, reparación o servicio:

- Cumpla con la práctica apropiada para la parada del equipo.
- Use toda la ropa protectora y equipo de seguridad personal necesarios para efectuar el trabajo en forma segura.
- Haga referencia a sus manuales del fabricante para conocer los procedimientos correctos de mantenimiento, reparación y servicio. Explique los procedimientos a los usuarios y operadores que no puedan leer.

Las fuentes de energía almacenada (eléctrica, mecánica, hidráulica, neumática, química, térmica etc.) deben estar aseguradas, bloqueadas, descargadas, desconectadas, apagadas, aseguradas, neutralizadas, controladas o reducidas a un mínimo práctico, antes de efectuar con seguridad cualquier procedimiento de mantenimiento, reparación o servicio.

Algunas prácticas de seguridad básicas para evitar posibles lesiones causadas por las fuentes que emiten energía:

- Desenganche la toma de fuerza (PTO) antes de apagar el motor.
- Coloque los controles en estacionamiento (P) o punto muerto (N) antes de apagar el motor.
- Aplique el freno de estacionamiento o coloque bloques en las ruedas.
- Permita que todas las piezas movibles se detengan.
- Baje la segadora al suelo.
- En las segadoras de tipo ala, baje las alas al suelo.
- Apague el motor del tractor.
- Asegure la ignición y extraiga la llave.
- Observe y escuche para establecer si hay piezas en movimiento antes de abrir los blindajes.
- Soporte o coloque bloques firmemente debajo de la segadora antes de trabajar debajo de la segadora u otros componentes elevados.
- Soporte, coloque bloques o asegure firmemente las alas de la segadora con los seguros antes de trabajar cerca o debajo de una segadora de tipo ala.
- Descargue la presión del sistema hidráulico moviendo los controles varias veces en todas direcciones.
- Descargue la presión antes de desconectar o desensamblar cualquier sistema presurizado.
- Coloque bloques o descargue la presión del resorte antes de desensamblar cualquier dispositivo a resorte.
- Soporte o bloquee firmemente cualquier componente de la máquina que esté elevado, antes de trabajar en ella.
- Evite las llamas, chispas o fumar cerca de cualquier combustible.



Su seguridad y las piezas del fabricante para la segadora

La mayoría de los fabricantes de segadoras usan sujetadores y piezas especialmente diseñadas para cumplir con los requerimientos de la operación de segado.

Seguridad crítica – piezas relacionadas (pernos de la hoja autoasegurados, hojas, pasadores, blindajes u otros artículos especiales) tienen requerimientos de fuerza, diseño y encaje específicos para el estilo y modelo de la segadora que usted utiliza.

Las modificaciones o piezas para reparación que no son aprobadas por el fabricante de la segadora pueden causar un riesgo significativo por exposición a su seguridad y la de los demás.

PARA EVITAR LAS LESIONES SERIAS O LA MUERTE CAUSADAS POR PIEZAS O MODIFICACIONES NO APROBADAS:

- No sustituya accesorios comunes por los pernos autoasegurados de las hojas u otras piezas especiales.
- No sustituya las hojas, pasadores, blindajes u otras piezas relacionadas con la seguridad crítica.
- No use pernos de grado 5 u 8 para reemplazar los pernos de resistencia limitada grado 2.

CUMPLA LA PRÁCTICA SEGURA DE SIEMPRE VERIFICAR EL FUNCIONAMIENTO CORRECTO DE TODOS LOS AJUSTES, REPARACIONES O SERVICIO DE LA SEGADORA.



Palabra final

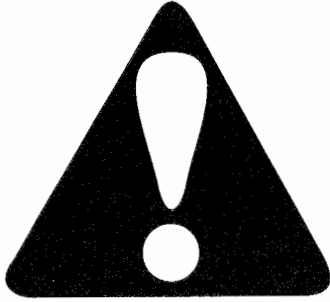

Usted ha terminado de leer el manual de seguridad de la segadora. Es imposible que este manual incluya toda situación peligrosa potencial que usted pueda encontrar. Sin embargo, su conocimiento de estas precauciones de seguridad y su cumplimiento de las reglas básicas de seguridad le ayudarán a crear buen juicio para todas las situaciones. Nuestro objetivo es ayudarle a desarrollar buenos hábitos de seguridad y hacerlo un mejor operador de segadora. El manual de seguridad de la segadora, precauciones de seguridad y reglas básicas de seguridad deben explicarse a los usuarios u operadores que no puedan leer.

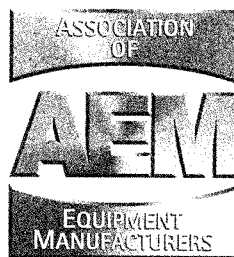

111 E. Wisconsin Avenue • Milwaukee, Wisconsin 53202 U.S.A.
www.aem.org

Para obtener información de reproducciones adicionales y
otros manuales de seguridad, llame al 800-369-2310

INTRODUCTION SECTION

Introduction Section 2-1

INTRODUCTION

This Cutter is designed with care and built with quality materials by skilled workers. Proper assembly, maintenance, and operating practices, as described in this manual, will help the owner/operator get years of satisfactory service from the machine.

The purpose of this manual is to familiarize, instruct, and train. The Assembly Section instructs the owner/operator in the correct assembly of the Mower using standard and optional equipment. The Parts Listing section is designed to familiarize the owner/operator with replaceable parts on the Mower. This section provides exploded assembly drawings of each mower component illustrating each piece and the corresponding part number.

Careful use and timely service saves extensive repairs and costly downtime losses. The Operation and Maintenance Sections of the manual train the owner/operator how to work the Mower correctly and attend to appropriate maintenance. The Trouble Shooting Guide helps diagnose difficulties with mower and offers solution to the problems.

Safety is of primary importance to the owner/operator and to the manufacturer. The first section of this manual includes a list of Safety Messages, that, if followed, will help protect the operator and bystanders from injury or death. Many of the Safety Messages will be repeated throughout the manual. The owner/operator/dealer should know these Safety Messages before assembly and be aware of the hazards of operating this mower during assembly, use, and maintenance. The Safety Alert Symbol combined with a Signal Word, as seen below, is intended to warn the owner/operator of impending hazards and the degree of possible injury faced when operating this machine.

CAUTION The lowest level of Safety Message; warns of possible minor injury. Decals located on the Mower with this Signal Word are Black and Yellow.



WARNING Serious injury or possible death! Decals are Black and Orange.



DANGER Imminent death/critical injury. Decals are Red and White.



ATTENTION OWNER/OPERATOR

BEFORE OPERATING THIS MACHINE:

1. Carefully read the Operator's Manual, completely understand the Safety Messages and instructions, and know how to operate correctly both the tractor and Mower.
2. Fill out the Warranty Card in full. Be sure to answer all questions, including the Serial Number of the Mower. Mail promptly using the return envelope included with the Operator's Manual.

NOTE: Warranties are honored only if completed "Owner Registration and Warranty" forms are received by Alamo Group within thirty days of delivery of the mower.

3. Record the Mower Model and Serial Numbers on the Warranty page at the end of the Operator's Manual. Keep this as part of the permanent maintenance file for the Mower.

INTRODUCTION

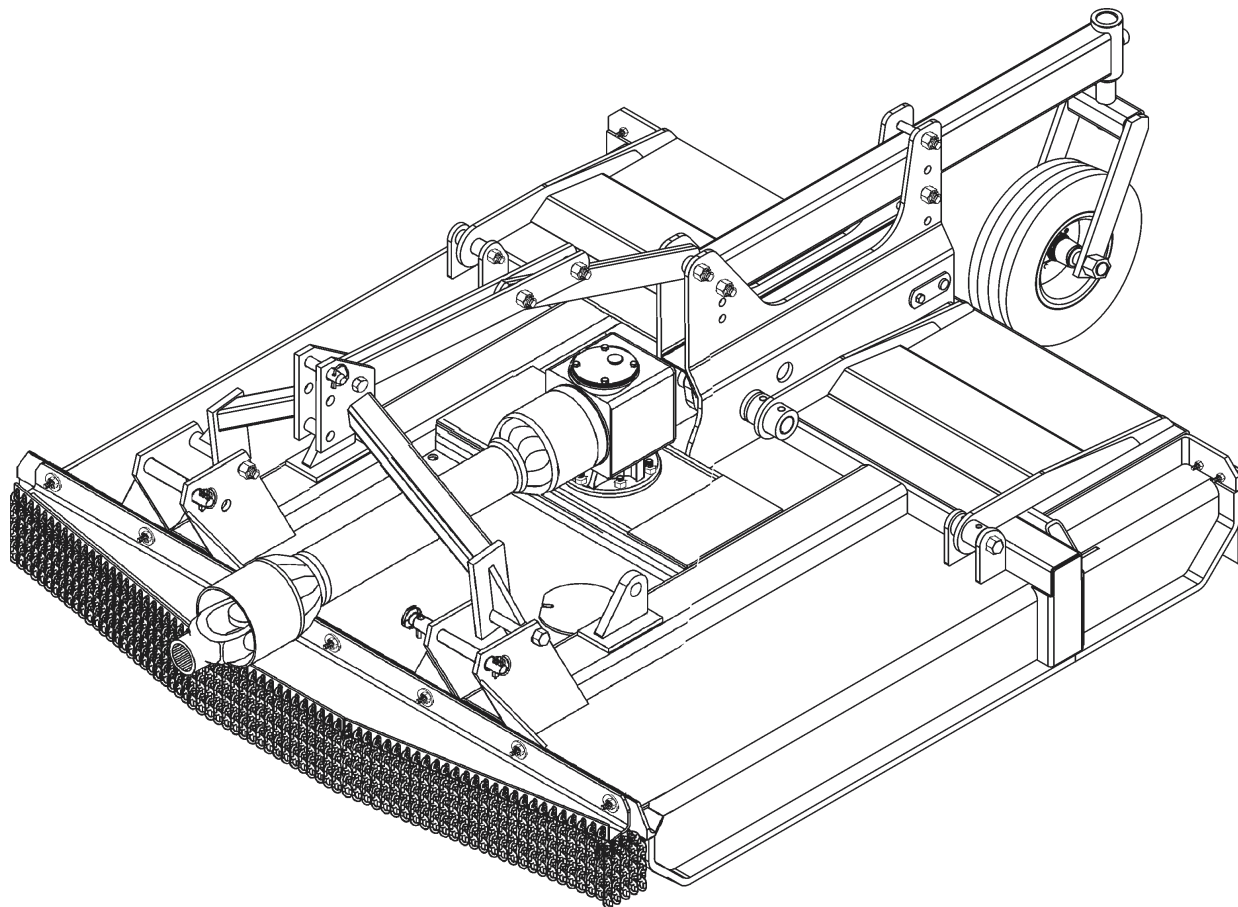

INTRODUCTION

This cutter is available in lift-type models only. These rugged Cutters are designed for heavy-duty work. They can cut brush up to 6" in diameter.

DANGER



For Non-Agricultural use, OSHA, ASAE, SAE, and ANSI standards require the use of Chain Guards, Deflectors, or Solid Skirts at all times. The Mower manufacturer strongly recommends the use of Chain Guards, Deflectors, or Solid Skirts for Agricultural purposes as well to reduce the risk of property damage, serious bodily injury, or even death from objects thrown out by or from contact with the Cutting Blades.

A 60" unit requires a minimum of 60 hp

A 72" unit requires a minimum 90 HP Tractor with adequate front end weight is required.

WARNING



At least 20% of the tractor's total weight must be on the front tires with the Mower lifted to provide adequate traction for safe steering under good conditions. Slow down on hills, rough terrain, and curves.

Front and rear, and left and right are determined by the normal direction of travel (the same as on your automobile).

ASSEMBLY SECTION

Assembly Section 3-1

ASSEMBLY

This Cutter will attach to most tractors with Cat. II & III and II & III Quick Hitch. The Lumberjack can be purchased for tractors with 540 or 1000 RPM PTO.

DEALER SET-UP INSTRUCTIONS

Assembly of this mower is the responsibility of the Servis-Rhino dealer. The mower should be delivered to the owner completely assembled, lubricated, and adjusted for normal cutting conditions.

Set up mower as received from the factory with these instructions. Open parts box and lay parts out to make location easy. Refer to the parts lists and exploded view drawings for more detail.

This mower is shipped partially assembled. Assembly will be easier if components are aligned and loosely assembled before tightening hardware.

CAUTION!

Always use personal protection devices such as eye, ear and feet protectors during assembly.



A-FRAME ASSEMBLY (FIGURE 1) 72" MODEL

To assemble the Mower's A-Frame, follow the procedures listed below:

1. One side at a time, position the mower's left and right A-Frame halves (28 and 26) between the respective front set of mower deck lugs. Align A-frame hole with lug back hole and insert a 1" x 8" bolt (41). Install a 1" locknut (40) onto bolt (41), but do not tighten at this point. Repeat procedure on other A-frame half.
2. To connect the two A-frame halves (28 and 26), place bushing (27) between frame halves' lower front holes and retain halves (28 and 26) and bushing (27) with a 1" x 4-1/2" bolt (42) and 1" locknut (43).
3. Insert spacer (23) between two front upper braces' (19) farthest holes. NOTE: Front upper braces have 3 bolt holes and lower rear braces 2 bolt holes. Insert bushing (24) into braces (19) and spacer (23). Align braces (19), bushing (24), and spacers (23) between A-frame back holes and retain using a 3/4" x 4-1/2" bolt (34) and 3/4" locknut (35).
4. Attach upper front braces (19) to lower rear braces (22) by first inserting bushings (20) into each upper front brace (19) center hole. Then place lower rear braces (22) between upper front braces (19) and bushings and align holes. Note: There will be separation between the upper front braces and no separation between the lower rear braces when installed correctly. Retain sets of braces and bushings using 3/4" x 3" bolt (38) and 3/4" locknut (35).
5. Install bushing (21) between upper braces' remaining open holes and insert 3/4" x 3" bolt (37) and 3/4" locknut (35).
6. Place spacer (25) into set of lower rear braces. Insert spacer (23) on each side of lower rear brace holes and place between mower deck rear lugs. Align brace holes and spacers with lug holes and insert a 3/4" x 4-1/2" bolt (34) and locknut 3/4" (35).
7. Tighten all bolts and locknuts per torque.

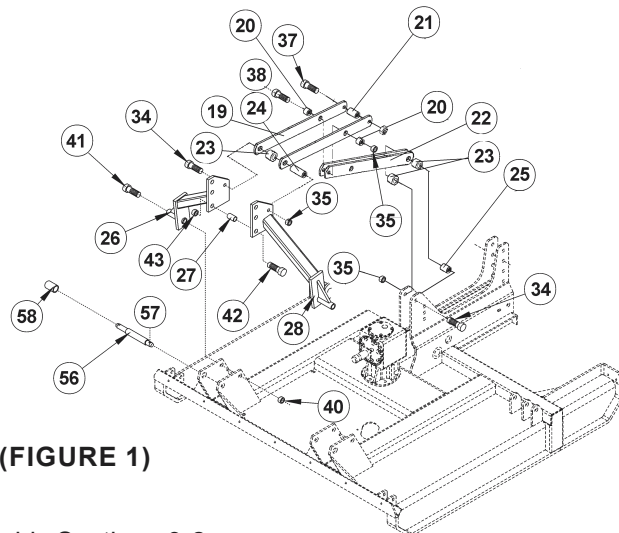

(FIGURE 1)

ASSEMBLY

A-FRAME ASSEMBLY (FIGURE 2) 60" MODEL

To assemble the Mower's A-Frame, follow the procedures listed below:

1. One side at a time, position the mower's left and right A-frame halves (21 and 22) to the inside of the respective front set of mower deck upright lugs. Align A-frame hole with with inside lug back hole. From inside the A-frame half, insert a 3/4" x 2" bolt (19) to connect the A-frame half to the lug. Install a 3/4" locknut (20) onto bolt (19), but do not tighten at this point. Repeat procedure on other A-frame half.
2. Position bushing (25) within the formed top link toggle (24) back set of holes (holes closest to bend). Raise A-frame halves, and position top link (24) and bushing (25) between the two halves. Place a flat rear brace (23) on outer side of each A-frame half (21 and 22). Align holes of flat rear braces (23), A-frame halves (21 and 22) top link (24) and bushing (25). Insert a 3/4" x 5-1/2" bolt (15) through holes and retain bolt with a 3/4" locknut (20).
3. Place free end of flat rear braces (23) to the inside of mower deck upright rear lugs. One brace at a time, align brace hole and respective lug's upper hole. From the outside of lug, insert a 3/4" x 2" bolt (19) and retain with a 3/4" locknut (20). Repeat procedure with remaining brace and lug.
4. Tighten all bolts and locknuts per recommended torque at this time.

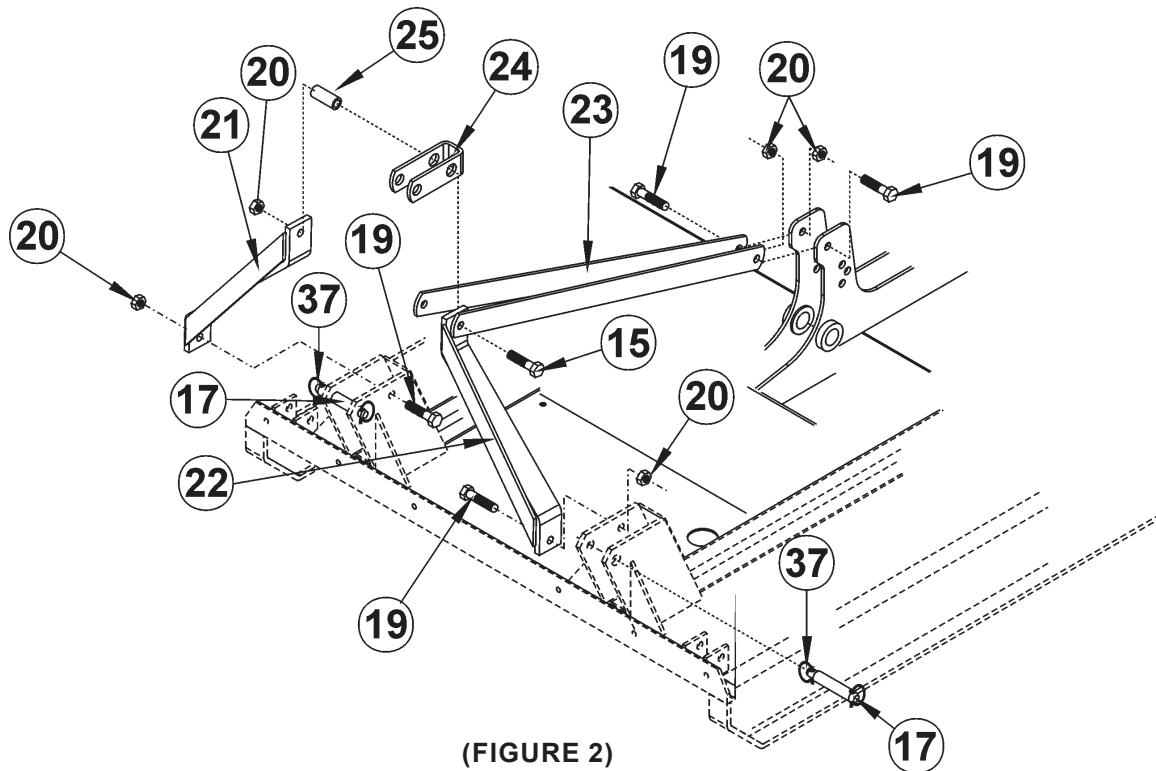

(FIGURE 2)

CAUTION! The Components of these machines are quite heavy. Block all components up securely before working under or putting extremities under such parts.



ASSEMBLY

GEARBOX SHIELD (FIGURE 2)

Position the bell shield over the input shaft and align it with threaded holes in the gearbox. Make sure access windows are facing left and right (Not up and down). Install flatwashers, mounting bolts and tighten securely.

NOTE: Access window must be removed for installation of shield to gearbox. This access window will also need to be used for mounting slip clutch to the input shaft of the gearbox.

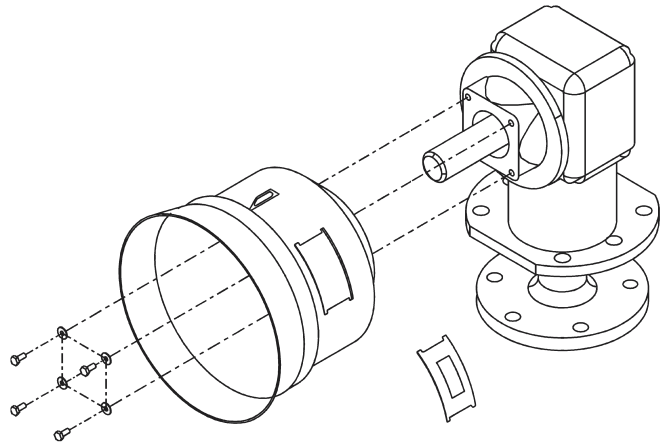

CAUTION! Shield Access window covers should always be replaced before operating cutter.



DRIVELINE ATTACHMENT

Remove bolts from clutch yoke. Install clutch onto gearbox shaft and install bolts through access window in bell shield. Tighten bolts securely.

FRONT CHAINGUARD ASSEMBLY 60" MODEL

Install front chainguard as illustrated below.

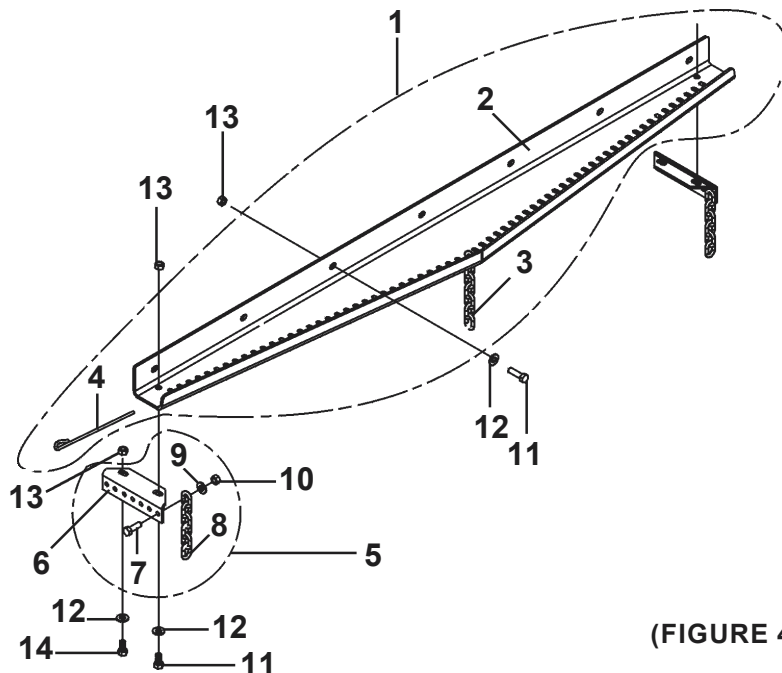

(FIGURE 4)

CAUTION! Do not operate Cutter without Front Chainguard in place.



ASSEMBLY

FRONT CHAINGUARD ASSEMBLY 72 MODEL

Install front chainguard as illustrated below.

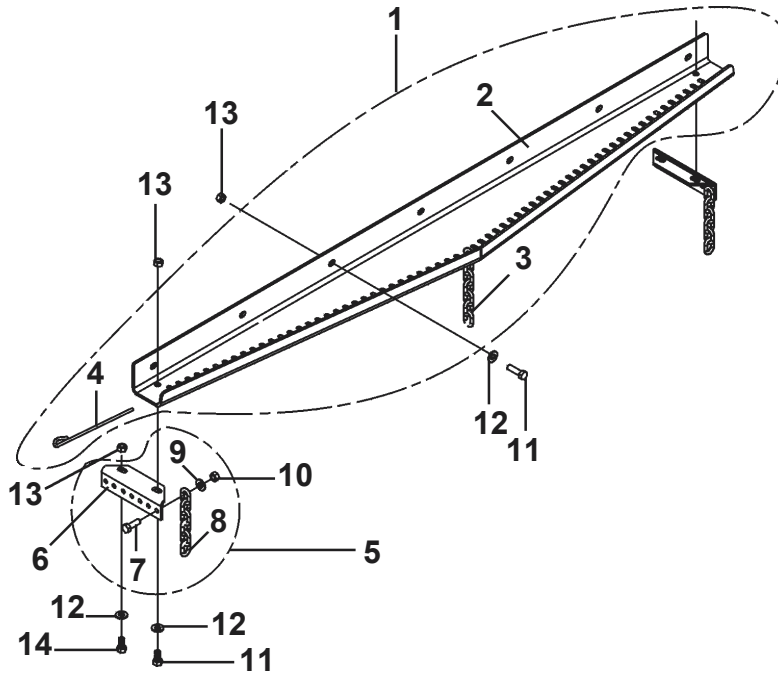

CAUTION! Do not operate Cutter without Front Chainguard in place.



OPERATION SECTION

Operation Section 4-1

OPERATION

LUMBERJACK 60/72 HEAVY-DUTY TREE CUTTERS OPERATION INSTRUCTIONS

Rhino Lumberjack 60 and Lumberjack 72 (LJ60/72) Heavy-Duty Tree Cutters are manufactured with quality material by skilled workers. Lumberjack cutters are engineered to cut vegetative material that a properly rated tractor can drive over (up to about 3" in diameter) and larger vegetation (up to 6" maximum diameter) by raising the retractable rear door and backing the cutter into the material. The cutter is equipped with protective shielding to prevent objects being thrown by blades, however, no shielding is 100% effective. All shields, guards, deflectors, and chain guards equipped on the unit must be maintained on the cutter in good operational condition.

It is the operator's responsibility to be knowledgeable of all potential operating hazards and to take every reasonable precaution to ensure oneself, others, animals, and property are not injured or damaged by the cutter, tractor, or a thrown object. The cutter must be operated with the retractable rear door in the lowered position if bystanders, livestock, pets, or property come within 100 yards of the unit and should not be operated if such items are positioned directly in front of or to the rear of the unit.

This section of the Operator's Manual is designed to familiarize, instruct, and educate safe and proper cutter use to the operator. Pictures contained in this section are intended to be used as a visual aid to assist in explaining the operation of a rotary mower and are not of a LJ60/72 cutter. Some pictures may show shields removed for purposes of clarity. NEVER OPERATE this implement without all shields in place and in good operational condition. The operator must be familiar with the cutter and tractor operation and all associated safety practices before operating the cutter and tractor. Proper operation of the LJ60/72, as detailed in this manual, will help ensure years of safe and satisfactory use of the cutter.

IMPORTANT: To avoid damage to the cutter, retorque all bolts after the first 10 hours of operation. Retorque blade carrier retaining nuts to 425 ft. lbs.

OPERATION

(1) OPERATOR REQUIREMENTS.....	4-4
(2) TRACTOR REQUIREMENTS.....	4-5
(2.1) ROPS and Seatbelt.....	4-5
(2.2) Tractor Safety Devices.....	4-5
(2.3) Tractor Horsepower.....	4-6
(2.4) 3-Point Hitch.....	4-6
(2.5) Front End Weight.....	4-6
(2.6) Power Take Off (PTO).....	4-7
(3) GETTING ON AND OFF THE TRACTOR.....	4-7
(3.1) Boarding the Tractor.....	4-8
(3.2) Dismounting the Tractor.....	4-8
(4) STARTING THE TRACTOR.....	4-9
(5) CONNECTING THE CUTTER TO THE TRACTOR.....	4-10
(6) SETTING THE CUTTER	4-11
(6.1) Setting Cutting Height.....	4-11
(6.2) Setting Deck Level.....	4-12

OPERATION

(7) DRIVELINE ATTACHMENT.....	4-12
(7.1) Driveline Length Modification.....	4-13
(8) PRE-OPERATION INSPECTION AND SERVICE.....	4-14
(8.1) Tractor Pre-Operation Inspection/Service.....	4-15
(8.2) Cutter Pre-Operation Inspection/Service.....	4-15
(9) DRIVING THE TRACTOR AND CUTTER.....	4-18
(9.1) Starting the Tractor.....	4-19
(9.2) Brake and Differential Lock Setting.....	4-19
(9.3) Raising the Cutter.....	4-20
(9.4) Driving the Tractor and Cutter.....	4-20
(9.5) Crossing Ditches and Steep Inclines.....	4-21
(10) OPERATING THE TRACTOR AND CUTTER.....	4-22
(10.1) Foreign Debris Hazards.....	4-22
(10.2) Bystander/Passersby Precaution.....	4-23
(10.3) Engaging the Power Take Off (PTO).....	4-24
(10.4) PTO RPM and Ground Speed.....	4-24
(10.5) Operating the Cutter.....	4-25
(10.6) Shutting Down the Cutter.....	4-27
(11) DISCONNECTING THE CUTTER FROM THE TRACTOR.....	4-28
(12) CUTTER STORAGE.....	4-29
(13) TRANSPORTING THE TRACTOR AND CUTTER.....	4-30
(13.1) Transporting on Public Roadways.....	4-31
(13.2) Hauling the Tractor and Cutter.....	4-33

READ AND UNDERSTAND THE ENTIRE OPERATING INSTRUCTIONS AND SAFETY SECTION OF THIS MANUAL AND THE TRACTOR MANUAL BEFORE ATTEMPTING TO USE THE TRACTOR AND CUTTER. If you do not understand any of the instructions, contact your nearest authorized dealer for a full explanation. Pay close attention to all safety signs and safety messages contained in this manual and those affixed to the cutter and tractor.

DANGER!



READ, UNDERSTAND, and FOLLOW the following Safety Messages. Serious injury or death may occur unless care is taken to follow the warnings and instructions stated in the Safety Messages. Always use good common sense to avoid hazards. (SG-2)

SAFETY INSTRUCTIONS



PELIGRO!



Si no lee Ingles, pida ayuda a alguien que si lo lea para que le traduzca las medias de seguridad. (SG-3)

!LEA EL INSTRUCTIVO!



OPERATION

1. OPERATOR REQUIREMENTS

Safe operation of the Rhino Lumberjack 60 and Lumberjack 72 (LJ60/72) Heavy-Duty Tree Cutter is the responsibility of a qualified operator. A qualified operator has read and understands both the cutter and tractor Operator Manuals and is experienced in tractor and cutter operations and all associated safety practices. In addition to the safety messages contained in this manual, safety message decals are affixed to the cutter and tractor. If any part of the operation and safe use of the cutter and tractor is not completely understood, consult an authorized dealer for a full explanation.

Safe cutter operation requires that the operator wear approved Personal Protective Equipment (PPE) for the job conditions while connecting, operating, servicing and repairing the cutter and tractor. PPE is designed to provide operator protection from bodily injury and includes the following:

Personal Protective Equipment (PPE)

- Protective eye glasses, goggles, or face shield
- Hard hat
- Steel toed safety footwear
- Gloves
- Hearing protection
- Close fitting clothing
- Respirator or filter mask

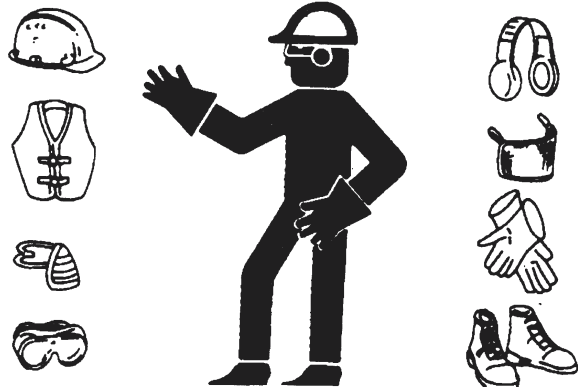

OPERATION

DANGER!



NEVER use drugs or alcohol immediately before or while operating the Tractor and Implement. Drugs and alcohol will affect an operator's alertness and coordination and therefore affect the operator's ability to operate the Equipment safely. Before operating the Tractor or Implement, an operator on prescription or over-the-counter medication must consult a medical professional regarding any side effects of the medication that would hinder their ability to operate the Equipment safely. **NEVER** knowingly allow anyone to operate this Equipment when their alertness or coordination is impaired. Serious injury or death to the operator or others could result if the operator is under the influence of drugs or alcohol. (SG-27)



OPERATION

2. TRACTOR REQUIREMENTS

The tractor used to operate the cutter must have the power capacity to lift, pull, and operate the Power Take Off (PTO) at the required speed (540 or 1000 revolutions per minute, depending on cutter gearbox) while traveling at a ground speed between 1 and 3 mph. Operating a cutter with a tractor that does not meet the following requirements may cause tractor or cutter damage and be a potential danger to the operator and passersby.

Tractor Requirements and Capabilities

- ASAE approved Roll-Over Protective Structure (ROPS) or ROPS cab and seat belt.
- Tractor Safety Devices..... Slow Moving Vehicle (SMV) emblem, lighting, PTO master shield
- Tractor Horsepower-Minimum LJ60-50HP; LJ72-90HP.
-Maximum..... 125 HP
- 3-Point Hitch-Lifting Capacity..... LJ60-1650 lbs.; LJ72-2500 lbs.
-Category..... LJ60 - CAT II ; LJ72 - CAT II or CAT III
- Front End Weight..... As needed to maintain 20% weight on front axle
- Power Take Off..... 540 rpm-6 spline or 1000 rpm-21 spline shaft

2.1 ROPS and Seat Belt

A Roll-Over-Protective-Structure (ROPS) and seat belt are essential to protect the operator from falling off the tractor, especially during a roll over where the driver could be crushed and killed. The ROPS and seat belt must be used in conjunction with one another. Only operate the tractor with the ROPS in the raised position and seat belt fastened. Tractor models not equipped with a ROPS and seat belt should have these life saving features installed by an authorized tractor dealer.

WARNING!



Operate this Equipment only with a Tractor equipped with an approved roll-over-protective system (ROPS). Always wear seat belts. Serious injury or even death could result from falling off the Tractor--particularly during a turnover when the operator could be pinned under the ROPS. (SG-7)



2.2 Tractor Safety Devices

If transporting or operating the tractor and cutter near a public roadway, the tractor must be equipped with proper warning lighting and a Slow Moving Vehicle (SMV) emblem which are clearly visible from the rear of the unit. Lights and a SMV emblem must be equipped directly on implements if the visibility of the tractor warning signals are obscured.

Maintain all manufacturer equipped safety shields and guards. Always replace shields and guards that were removed for access to connect, service, or repair the tractor or cutter. Never operate the tractor PTO with the PTO master shield missing or in the raised position.

OPERATION

2.3 Tractor Horsepower

The power required to operate a cutter is determined by the tractor PTO horsepower. For most cutting conditions, the LJ60 and LJ72 require a tractor with 50 and 90 HP, respectively. Operating the cutter with a tractor that does not have adequate power may damage the tractor engine. Exceeding 125 HP may cause cutter damage by overpowering the unit in heavy cutting conditions.

2.4 3-Point Hitch

Lumberjack cutters are considerably heavier than conventional rotary mowers of the same size. The tractor 3-point hitch must be rated to lift at least 1650 lbs. if attaching a LJ60 and 2500 lbs. if attaching a LJ72.

The LJ60 attaches to tractors with a Cat II 3-point hitch and the LJ72 either a Cat II or III hitch. Refer to the tractor owner's manual for the category of the tractor used. If the hitch does not conform to the ASAE Cat II or III hitch dimensions, the cutter may not fit properly. Consult an authorized dealer for possible modification procedures to mount nonconforming hitches.

Use the correct hitch pins for the hitch category being used. For a Cat II hitch, 1-1/8" lower and 1" upper diameter hitch pins are used and Cat III hitches require 1-7/16" lower and 1-1/4" upper diameter hitch pins.

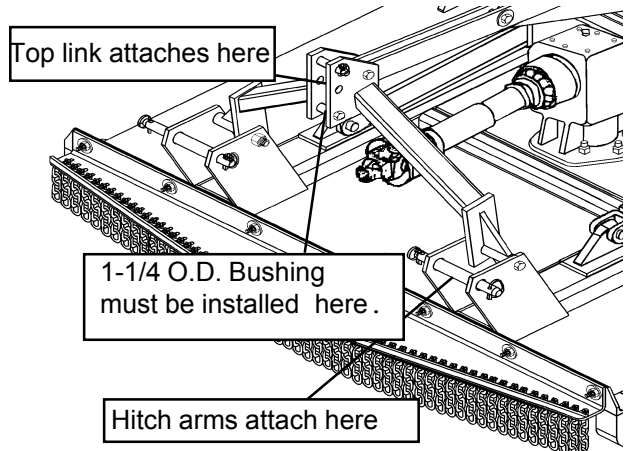

CAT II Implement / Hitch Specifications

Width from outside to outside A-frame.....	32-3/8"
Quick Hitch width inside lug to lug.....	33-5/8"
Height from bottom hitch pin to top pin.....	19"
Lower pin diameter.....	1-1/8"
Upper pin diameter.....	1"
Linch Pin diameter.....	15/32"

CAT III Implement / Hitch Specifications

Width from outside to outside A-frame.....	38"
Quick Hitch width inside lug to lug.....	39-1/4"
Height from bottom hitch pin to top pin.....	22"
Lower pin diameter.....	1-7/16"
Upper pin diameter.....	1-1/4"
Linch Pin diameter.....	15/32"

2.5 Front End Weight

A minimum of 20% total tractor weight must be maintained on the tractor front end when the cutter is in the raised position. Proper weight on the tractor front end is critical to maintain steering control and to prevent the tractor from rearing up while driving. If the tractor front end is too light, add weight until a minimum of 20% total weight is reached on the front tires. Front weights and weight carriers can be purchased through an authorized tractor dealership.

OPERATION

2.6 Power Take Off (PTO)

Depending on the equipped gearbox, LJ60/72 cutters are designed to operate at either 540 or 1000 rpm. Most tractors operate at either 540, or a combination of 540 and 1000 rpm PTO speeds. The speed of the tractor PTO can be determined by the number of splines on the PTO output shaft. Those operating at 540 rpm will have a 6-spline 1-3/8" diameter shaft and those operating at 1000 rpm will have a 21-spline 1-3/8" shaft. NOTE: The LJ60/72 will not operate on tractors equipped with a 1000 rpm 20-spline, 1-3/4" shaft. Refer to the tractor owner's manual for instructions to change PTO speeds on models that operate at more than one speed.

WARNING!



Never use a PTO shaft adapter to connect a Mower to a Tractor which operate at different speeds. The Mower must be operated by the Tractor at its rated speed (depending on mower either 540 or 1000 rpm) to provide a specific blade speed for efficient and safe mowing. Attaching a non-conforming tractor PTO shaft to an Implement driveline using a PTO shaft adapter will result in the Implement operating at a greatly increased or reduced speed. Use of a PTO shaft adapter will also change the working length of the driveline and expose unshielded driveline areas. Serious bodily injury and/or equipment failure can result from combining non-conforming Tractor and Implement speeds with the use of an adapter. Consult an authorized dealer for technical assistance if the Tractor and Mower are designed to operate at different speeds.

3. GETTING ON AND OFF THE TRACTOR

Before getting onto the tractor, the operator must read and completely understand the cutter and tractor operator manuals. If any part of either manual is not completely understood, consult an authorized dealer for a complete explanation.

WARNING!



Do Not mount or dismount the Tractor while the Tractor is moving. The Tractor engine must be turned off, the Tractor transmission in park or neutral with the parking brake set, and all moving Tractor and Implement parts at a complete stop before boarding or exiting the Tractor.



OPERATION

3.1 Boarding the Tractor

Use both hands and equipped handrails and steps for support when getting on the tractor. Never use tractor control levers for support when mounting the tractor. Always seat yourself in the operator's seat and fasten the seatbelt. Only operate the tractor and cutter with the ROPS in the raised position.

Never allow passengers to ride on the tractor or cutter. Additional riders can easily fall off and be seriously injured or killed from being ran over by both the tractor and cutter. It is the operator's responsibility to forbid additional riders.

DANGER!



Never allow children or other persons to ride on the Tractor or Implement. Falling off can result in serious injury or death. (SG-10)



DANGER!



Never allow children to operate or ride on the Tractor or Implement. (SG-11)



OPERATION

3.2 Dismounting the Tractor

Before dismounting, park the tractor and cutter on level ground, apply the parking brake, idle the engine down, disengage the PTO, and lower the cutter to the ground. Shut down the tractor engine according to the tractor operator's manual, remove the key, and wait for all motion to completely stop. Never leave the seat until the tractor, its engine and all moving cutter parts are completely stopped.

DANGER!



BEFORE leaving the Tractor seat, always engage the brake and/or set the Tractor transmission in parking gear, disengage the PTO, stop the engine, remove the key, and wait for all moving parts to stop. Place the Tractor shift lever into a low range or parking gear to prevent the Tractor from rolling. Never dismount a Tractor while it is moving or while the engine is running. Operate the Tractor controls from the Tractor seat only. (SG-9)

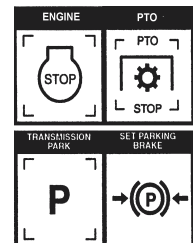

Use hand rails and steps when exiting the tractor. Be careful of your step and use extra caution when mud, ice, snow or other matter has accumulated on the steps or hand rails. Use all handrails and steps for support and never rush or jump off the tractor.

OPERATION

4. STARTING THE TRACTOR

The operator must have a complete understanding of the placement, function, and operational use of all tractor controls before starting the tractor. Review the tractor operator's manual and consult an authorized dealer for tractor operation instructions if needed.

Essential Tractor Controls:

- Locate the light control lever
- Locate the engine shut off control
- Locate the brake pedals and the clutch
- Locate the PTO control
- Locate the 3 point hitch control
- Locate the hydraulic remote control lever

Before starting the tractor ensure the following:

- Conduct all pre-start operation inspection and service according to the tractor operator's manual.
- All guards and safety devices are securely in place.
- The parking brake is on.
- The PTO control lever is disengaged.
- The 3-point hitch control lever is in the down position.
- The hydraulic remote control levers are in the neutral position.
- The tractor transmission levers are in park or neutral.

Refer to the tractor owner's manual for tractor starting procedures. Only start the tractor while seated and belted in the tractor operator's seat. Never bypass the ignition switch by short circuiting the starter.

After the tractor engine is running, avoid accidental contact with the tractor transmission to prevent sudden and unexpected tractor movement.

DANGER!



Start the Tractor only when properly seated in the Tractor seat. Starting a Tractor in gear can result in injury or death. Read the Tractor operator's manual for proper starting instructions. (SG-13)



OPERATION

5. CONNECTING THE CUTTER TO THE TRACTOR

Use extreme caution when connecting the cutter to the tractor. The cutter should be securely resting at ground level or setting securely on blocks. Keep hands and feet from under cutter deck and clear of pinch points between tractor hitch arms and cutter pins.

DANGER!



Never stand or allow another person to stand between a running Tractor and the Mower when attaching the Implement to the Tractor 3-point hitch. Always shut the Tractor off completely and set the parking brake before attempting to connect the Mower pins to the Tractor hitch.

1. Make sure the tractor is equipped with the correct PTO shaft. Change shafts if needed.
2. Shorten or remove the tractor drawbar to avoid interference when raising and lowering the cutter.
3. Board the tractor and start the engine. Position the tractor to the cutter with the 3-point lift arms positioned between the respective set of cutter A-frame lift lugs.
4. Turn off the tractor engine and dismount.
5. One lift arm at a time, align arm end hole between the set of holes of A-frame lift lugs. Insert hitch pin through the lug and arm holes and insert retaining pin into hitch pin.
6. Walk around to opposite side and repeat procedure for remaining lift arm and lift lugs.
7. Extend or retract 3-point top link to align its end hole with the holes of the cutter's top link. Insert the top link hitch pin and insert retaining pin into hitch pin.
8. Attach hydraulic hose ends of retractable rear guard cylinder into tractor hydraulic ports.
9. Adjust any lower link check chains, guide blocks, or sway blocks to prevent the cutter from swaying side to side and possible contact with tractor rear tires.



OPERATION

6. SETTING THE CUTTER

Properly setting the cutter height is essential for efficient and safe operation. A properly set cutter will make a more uniform cut, distribute clippings more evenly, require minimal tractor work, and follow the contour of uneven terrain. Note: Avoid very low cutting heights; striking the ground with the blades gives the most damaging shock loads and will cause damage to the cutter and drive.

6.1 Setting Cutting Height

1. Park the tractor and cutter on level ground.
2. Using the 3-point hitch control lever, position the front of the cutter with the side skids 1" less off the ground than desired cut height. For example, for a 3" cut, position the skids 2" from the ground. Set the 3-point control lever stop at this position to maintain this height when raising and lowering the cutter.
3. Shut down the tractor and remove the key.
4. Level the cutter deck front to rear by extending or retracting the 3-point top link.
5. Level the cutter side to side by manipulating one lower lift arm length. On most tractors, at least one of the lift arms is designed to allow for manipulation of its length. Shortening or extending will allow for deck leveling from side to side.
6. Securely block up the cutter at this height.
7. Remove the bolts securing the tailwheel beam in position and allow the tailwheel to rest at ground level. Align tailwheel beam between nearest sets of holes in beam support brackets and reinstall support bolts on each side of beam. Tighten all bolts and nuts.
8. Extend the tractor's top 3-point link so that when lifting the cutter, the front of the deck will raise 2 to 2½" before the tail wheel leaves the ground. This will allow the cutter to follow the contour of uneven terrain.

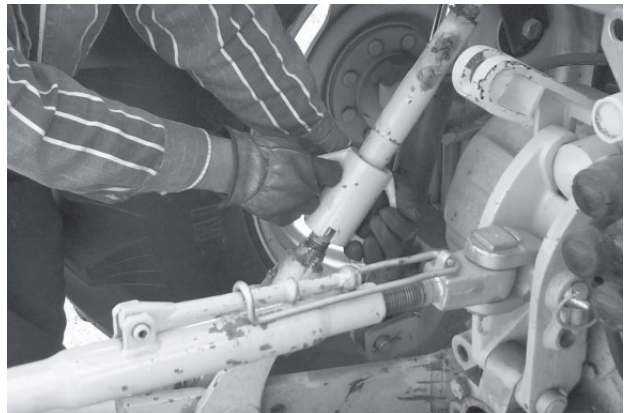
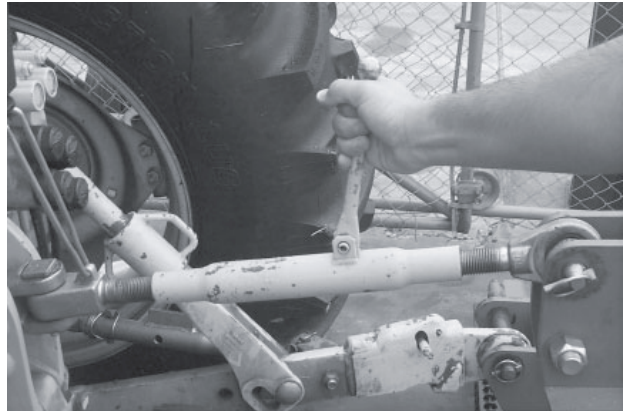

OPERATION

6.2 Setting Deck Level

The cutter deck should be level from front to rear and side to side. It is especially important that the cutter be level with the ground when cutting large diameter trees. If the cutter is not level, the blades are making contact with the tree on an elevated angle, and its ability to cut is greatly reduced. There is extreme pressure being applied to the blades, the blade carrier, the gearbox, and the driveline when cutting large diameter size trees. This pressure can cause the blades to bend or break, and other component failure. By minimizing the work required by the cutter and tractor, better performance and increased longevity of the tractor and cutter can be realized.

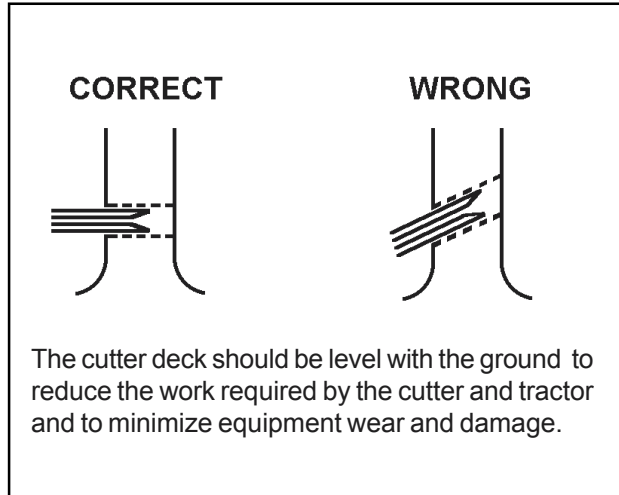

7. DRIVELINE ATTACHMENT

The driveline yoke and tractor PTO shaft must be dirt free and greased for attachment.

To attach the driveline, loosen the driveline yoke clamping cone with a 11/16" (17mm) wrench and remove the cone from yoke. Slide yoke onto output shaft and align hole for cone with groove of PTO output shaft. Reinstall cone and tighten (50 lb-ft torque). Push and pull the driveline to ensure it is securely attached to PTO output shaft. Regularly check the driveline yoke to ensure a tight connection. To remove the yoke, remove the connecting cone and pull yoke off the output shaft. If the cone cannot be easily removed by hand, drive it out from the other side using a hammer and punch.

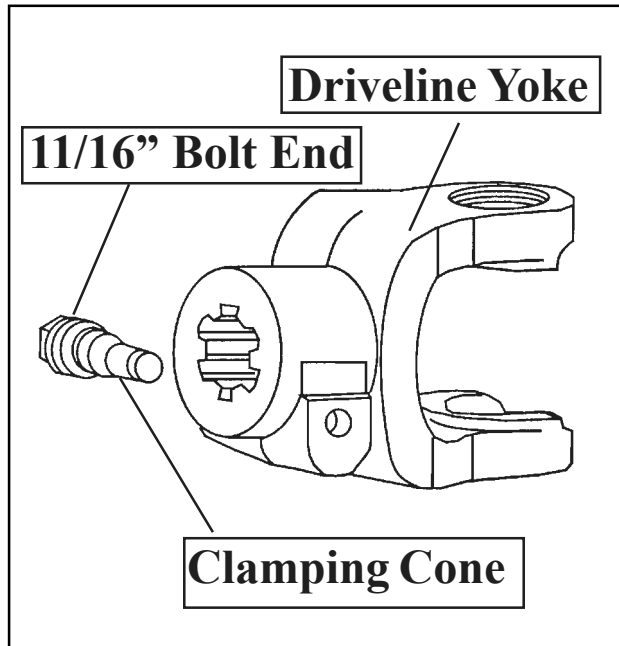

WARNING!



When attaching the PTO yoke to the Tractor PTO shaft, it is important that the clamping cone is securely seated into the groove of the PTO shaft and properly tightened. A driveline not attached correctly to the Tractor PTO shaft could slip off and result in personal injury and damage to the cutter.

OPERATION

7.1 Driveline Length Modification

WARNING!



Before operating the Mower, check to make sure the driveline will not bottom out or become disengaged. Bottoming out occurs when the inner shaft penetrates the outer housing until the assembly becomes solid-it can shorten no more. Bottoming out can cause serious damage to the Tractor PTO by pushing the PTO into the Tractor and through the support bearings or downward onto the PTO shaft, breaking it off.

When fitting the cutter to the tractor, the telescoping driveline must be inspected to ensure that at its most compressed position, the profiles do not “bottom out”, and when at its farthest extended position, there is sufficient engagement between the profiles to operate safely. At its shortest length, there must be at least a 1” clearance between each profile end and opposite profile universal joint. At its farthest operating extension, a minimum profile engagement of 10” must be maintained.

“Bottoming Out” Check Procedure

1. Disconnect driveline from the tractor and slide the profiles together until fully compressed.
2. Place a mark on the inner shield 1/8” from the end of the outer shield.
3. Reattach the driveline to the PTO shaft.
4. Raise the cutter and watch the driveline as it approaches the mark. If the distance between the mark and the end of the outer shield tube becomes less than 2” at any point, the driveline must be shortened.

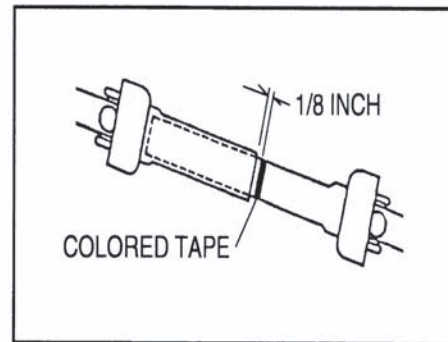

Driveline in maximum compressed position

Shorten the driveline profiles as follows:

1. Remove the driveline from the tractor.
2. Raise and lower the cutter to find position with the shortest distance between the tractor PTO shaft and cutter gearbox. Shut down the tractor and securely block the cutter in this position.
3. Pull driveline apart and reattach yoke to PTO shaft.
4. Hold driveline sections parallel to one another and measure back 1” from yoke of each shaft and place mark on opposite section. Cut this length off with a saw.
5. Round off all sharp edges and debur.
6. Thoroughly grease then reinstall the driveline.
7. Recheck for proper operation.

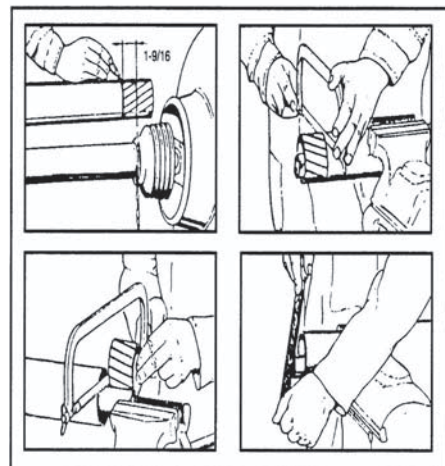

OPERATION

Engagement Check Procedure

1. With the driveline attached, raise and lower the cutter within its operating range. Position the mower at the point where the telescoping driveline is at its maximum extension. Turn off the tractor and apply the parking brake. Securely block the cutter at this height.
2. Mark the inner shield 1/8" from the end of the outer shield.
3. Disconnect the driveline from the tractor and separate the two driveline halves.
4. Measure the distance from the mark to the end of the inner profile. This length is the amount the driveline profiles were engaged.
5. If the engaged length is less than 10", the shaft is considered too short and should be replaced with a longer shaft. Consult an authorized dealer to purchase the required driveline length.

NOTE: When raising the cutter, at least 1" clearance must be maintained between the driveline and the cutter deck. If necessary, place an upper lift stop on the 3-point hitch control lever to limit the height the cutter can be raised.

8. PRE-OPERATION INSPECTION AND SERVICE

Before each use, a pre-operation inspection and service of the cutter and tractor must be performed. This includes routine maintenance and scheduled lubrication, inspecting that all safety devices are equipped and functional, and performing needed repairs. Do not operate the cutter and tractor if the pre-operation inspection reveals any condition affecting safe operation. Perform repairs and replacement of damaged and missing parts as soon as noticed. By performing a thorough pre-operation inspection and service, valuable down time and repair cost can be avoided.

OPERATION

DANGER!



Always disconnect the main PTO Driveline from the Tractor before performing service on the Mower. Never work on the Mower with the Tractor PTO driveline connected and running. Blades or Drivelines could turn without warning and cause immediate entanglement, injury or death. (SRM-3)

WARNING!



Never work under the Mower, the framework, or any lifted component unless the Mower is securely supported or blocked up to prevent sudden or inadvertent falling which could cause serious injury or even death. (SG-14)

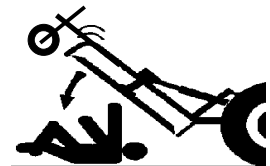

WARNING!



Periodically inspect all moving parts for wear and replace when necessary with authorized service parts. Look for loose fasteners, worn or broken parts, and leaking or loose fittings. Make sure all pins have cotter pins and washers. Serious injury may occur from not maintaining this Implement in good working order. (SG-21)

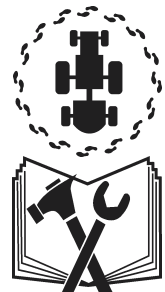

OPERATION

8.1 Tractor Pre-Operation Inspection/Service

Refer to the tractor operator's manual to ensure a complete pre-operation inspection and scheduled service is performed according to manufacturer recommendations. The following is a partial list of items requiring inspection:

- Tire condition/air pressure
- Wheel lug bolts
- Steering linkage
- PTO shield
- SMV sign is clean and visible
- Tractor's lights are clean and functional
- Tractor Seat belt is in good condition
- Tractor cab or ROPS is in good condition
- ROPS is in the raised position
- No tractor oil leaks
- Radiator free of debris
- Engine oil level and condition
- Engine coolant level and condition
- Power brake fluid level
- Power steering fluid level
- Fuel condition and level
- Sufficient lubrication at all lube points
- Air filter condition



8.2 Cutter Pre-Operation Inspection/Service

Before each cutter use, a complete inspection and service is required to ensure the cutter is in a good and safe working condition. Damaged and/or broken parts should be repaired and/or replaced immediately. To ensure the cutter is ready for operation, conduct the following.

- Perform scheduled lubrication as detailed in the maintenance section.
- Ensure all decals are in place and legible.
- Ensure driveline is securely attached to tractor. Make sure the driveline yoke clamping cone is securely seated in the grooves of the PTO shaft and tightened.
- Inspect that the 3-point hitch pins are the proper size, correctly installed, and secured to the tractor lift arms with retaining pins inserted.



OPERATION

- Ensure chain guards and rubber deflectors are in position and not damaged. Replace worn, broken, and missing pieces.
- Check the condition of the retractable rear guard and ensure it raises and lowers properly.
- Ensure the cylinder operating the retractable door is correctly installed and attached. Inspect the cylinder, hose, fittings, and connection for leaks.

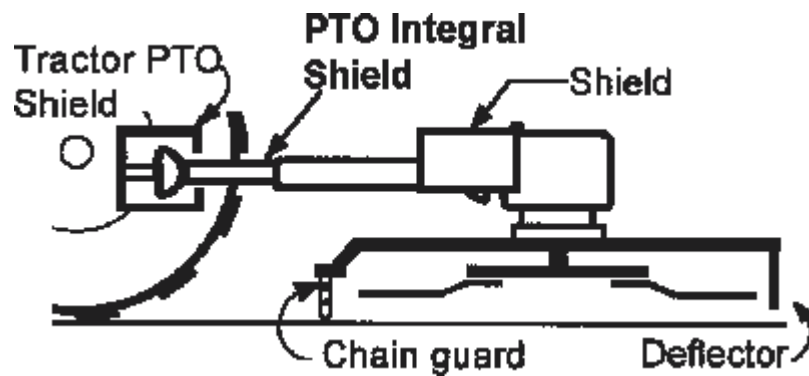

OPERATION

DANGER!



All Safety Shields, Guards and Safety devices including (but not limited to) - the Deflectors, Chain Guards, Steel Guards, Gearbox Shields, PTO integral shields, and the Retractable Door Shields should be used and maintained in good working condition. All safety devices should be inspected carefully at least daily for missing or broken components. Missing, broken, or worn items must be replaced at once to reduce the possibility of injury or death from thrown objects, entanglement, or blade contact.

(SGM-3)

- Ensure the tailwheel beam position support bolts are properly installed and tightened.
- Inspect all bolts and screws and tighten to the recommended torque.



OPERATION

- Ensure the driveline slip clutch shield is in place and in good condition.
- Ensure the driveline integral shield is in good condition and rotates freely.
- Make sure the tractor PTO master shield is in place, lowered, and in good condition.



- Inspect the gearbox oil level. A low oil level is a warning sign that the gearbox may be cracked or its seal is damaged and needs replacement.
- Ensure the gearbox vent is in place on the top of the box and free from clogs.



- Inspect blades and blade bolts for looseness and excessive wear. Make sure the cutter is securely blocked up before crawling beneath. Replace damaged, worn and missing blades as complete sets to maintain rotary balance during operation.
- Ensure blade carrier nuts are tightened.
- Ensure carrier hub nut is tightened with the cotter pin inserted and spread.



DANGER!



Replace bent or broken blades with new blades. NEVER ATTEMPT TO STRAIGHTEN OR WELD ON BLADES SINCE THIS WILL LIKELY CRACK OR OTHERWISE DAMAGE THE BLADE WITH SUBSEQUENT FAILURE AND POSSIBLE SERIOUS INJURY FROM THROWN BLADES. (SGM-10)

OPERATION

9. DRIVING THE TRACTOR AND CUTTER

Safe tractor transport requires the operator possess a thorough knowledge of the model being operated and precautions to take while driving with an attached implement. Ensure the tractor has the capacity to handle the weight of the cutter and the tractor operating controls are set for safe transport. To ensure safety while driving the tractor with an attached cutter, review the following.

DANGER!



Never run the Tractor engine in a closed building or without adequate ventilation. The exhaust fumes can be hazardous to your health. (SG-23)

WARNING!



Transport only at safe speeds. Serious accidents and injuries can result from operating equipment at unsafe speeds. Understand the Tractor and Mower and how it handles before transporting on streets and highways. Make sure the Tractor steering and brakes are in good condition and operate properly. Before transporting the Tractor and Mower, determine the safe transport speeds for you and the equipment. Make sure you abide by the following rules:

1. **Test the Tractor at a slow speed and increase the speed slowly. Apply the Brakes smoothly to determine the stopping characteristics of the Tractor and Mower. As you increase the speed of the Tractor the stopping distance increases. Determine the maximum safe transport speed for you and this Equipment.**
2. **Test the equipment at a slow speed in turns. Increase the speed through the turn only after you determine that it is safe to operate at a higher speed. Use extreme care and reduce your speed when turning sharply to prevent the Tractor and Mower from turning over. Determine the maximum safe turning speed for you and this equipment before operating on roads or uneven ground.**
3. **Only transport the Tractor and Mower at the speeds that you have determined are safe and which allow proper control of the equipment.**



Be aware of the operating conditions. Do not operate the Tractor with weak or faulty brakes. When operating down a hill or on wet or rain slick roads, the braking distance increases, use extreme care and reduce your speed in these conditions. When operating in traffic, always use the Tractor's flashing warning lights and reduce your speed. Be aware of traffic around you and watch out for the other guy. (SG-19)

OPERATION

9.1 Starting the Tractor

The procedure to start the tractor is model specific. Refer to the tractor operator's manual for starting procedures for your particular tractor. Consult an authorized dealer if the starting procedure is unclear. Ensure the 3-point control lever is in the lowered position and the PTO lever is off before starting the tractor.



9.2 Brake and Differential Lock Setting

Make sure the tractor brakes are in good operating condition. Tractor brakes can be set to operate independently allowing single rear wheel braking action or locked together to provide simultaneous rear wheel braking. FOR MOST DRIVING AND CUTTING CONDITIONS, THE BRAKE PEDALS SHOULD BE LOCKED TOGETHER TO PROVIDE THE MOST EFFECTIVE BRAKING ACTION.

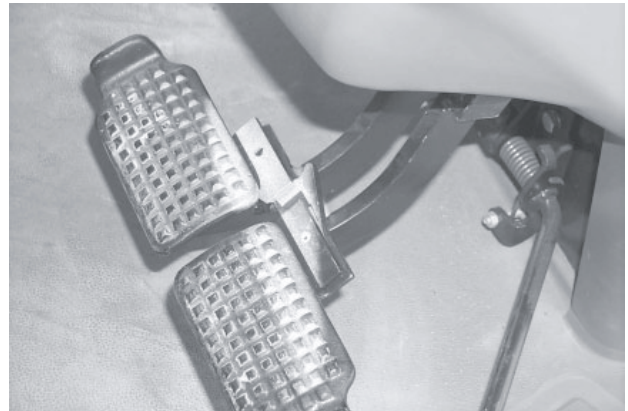

WARNING!



Be aware of the operating conditions. Do not operate the Tractor with weak or faulty brakes. When operating down a hill or on wet or rain slick roads, the braking distance increases; use extreme care and reduce your speed in these conditions. When operating in traffic, always use the Tractor's flashing warning lights and reduce your speed. Be aware of traffic around you and watch out for the other guy.

Always disengage the tractor differential lock when turning. When engaged the differential lock will prevent or limit the tractor from turning. During normal cutting conditions, locking the differential provides no benefit and should not be used.

OPERATION

9.3 Raising the Cutter

Using the tractor 3-point hitch control lever, raise the cutter off the ground about 6", or just high enough to clear any ground obstacles. When raising the cutter, make sure all connection points are securely attached and at least 1" clearance is maintained between the driveline and the deck. If necessary, place an upper lift stop on the 3-point hitch control lever to limit the height the cutter can be raised to avoid driveline damage.



9.4 Driving the Tractor and Cutter

Start off driving at a slow speed and gradually increase your speed while maintaining complete control of the tractor and cutter. Moving slowly at first will also prevent the tractor from rearing up and loss of steering control. The tractor should never be operated at speeds that cannot be safely handled or which will prevent the operator from stopping quickly during an emergency. If the power steering or engine ceases operating, stop the tractor immediately as the tractor will be difficult to control. If the tractor becomes stuck or the tires are frozen to the ground, reverse the tractor out to prevent overturning.

Perform turns with the tractor and cutter at slow speeds to determine how the tractor with the cutter handles a turn. Determine the safe operating speed to maintain proper control of the tractor when making turns. When turning with an attached rear implement, the overall length of the working unit is greatly increased. Allow additional clearance for the cutter to swing when turning.



WARNING!



Be particularly careful when transporting the Mower with the Tractor. Turn curves or go up hills only at a low speed and using a gradual steering angle. Rear mounted Implements move the center of gravity to the rear and remove weight from the front wheels. Make certain, by adding front ballast if necessary, to maintain at least 20% of the Tractor's weight on the front wheels to prevent Tractor rearing up, loss of steering control, and possible Tractor tip-over. Slow down on rough or uneven surfaces to prevent loss of steering control, which could result in property damage or possible injury. Do not transport the Mower unless the Tractor 3-Point lift lever is fully raised and in the latched transport position. Dropping the Mower during transport can cause serious damage to the Tractor and/or Mower, and possibly cause the operator or others to be injured or killed. (S3PT-2)

OPERATION

To avoid overturns, drive the tractor with care and at safe speeds, especially when operating over rough ground, crossing ditches or slopes, and turning corners. Tractor wheel tread spacing should be increased when working on inclines or rough ground to reduce the possibility of tipping.

Use extreme caution when operating on steep slopes. Keep the tractor in a low gear when going downhill. **DO NOT** coast or free-wheel downhill.



9.5 Crossing Ditches and Steep Inclines

When crossing ditches with steep banks or going up sharp inclines, it is possible that the driveline inner profile will penetrate into the outer housing to its maximum depth until the assembly becomes solid (driveline is at its extreme shortest length). This type of abusive operation may result in damage to the tractor and cutter components in the form of severe catastrophic failures.

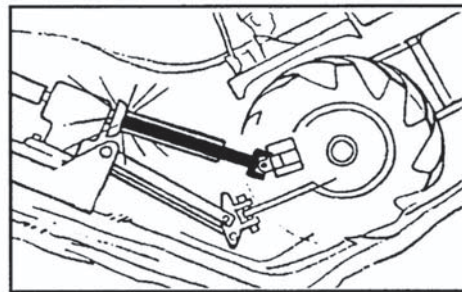

WARNING!



Damage resulting from over-collapse of the driveline's inner profile and its outer housing may allow the driveline to come loose from the Tractor which could cause bodily injury to the operator or bystanders and/or extensive damage to the Tractor or Implement

When confronted with an incline or ditch, do not approach from an angle which is perpendicular or straight on as damage to over collapse of the driveline may occur.

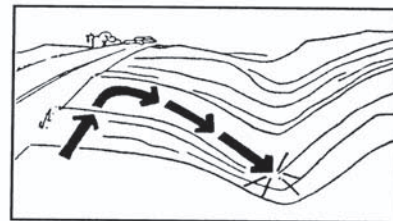

INCORRECT: DO NOT approach ditch straight on.

Inclines and ditches should be approached along a line which is at an angle as shown. This type of path will reduce the possibility of over-collapse of the driveline and resulting damage. If the gradient is so steep that such an approach increases the possibility of a tractor roll-over, select an alternate crossing path.

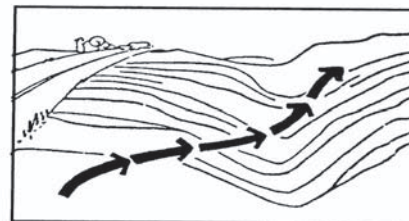

CORRECT: Approach ditch at an angle

OPERATION

10. OPERATING THE TRACTOR AND CUTTER

Before starting any cutting operation, the operator must become familiar with the area to be cut and any obstacles and hazards contained within to ensure safety to the operator, bystanders, and equipment. Special attention should be paid to foreign debris, rough terrain, steep slopes, and passersby and animals in the area.

DANGER!



Extreme care should be taken when operating near loose objects such as gravel, rocks, wire, and other debris. Inspect the area before mowing. Foreign objects should be removed from the site to prevent machine damage and/or bodily injury or even death. Any objects that cannot be removed must be clearly marked and carefully avoided by the operator. Stop mowing immediately if blades strike a foreign object. Repair all damage and make certain the blade carrier is balanced before resuming mowing. (SGM-5)



DANGER!



Many varied objects, such as wire, cable, rope, or chains, can become entangled in the operating parts of the Mower head. These items could then swing outside the housing at greater velocities than the blades. Such a situation is extremely hazardous and could result in serious injury or even death. Inspect the cutting area for such objects before mowing. Remove any like object from the site. Never allow the cutting blades to contact such items. (SGM-6)

OPERATION

10.1 Foreign Debris Hazards

Before cutting, inspect the area to make sure there are no foreign objects that the cutter blades could hit or become entangled with. Remove all foreign objects and debris. If objects are too big to remove, mark them clearly and be sure to prevent the cutter blades from contacting them.



OPERATION

If you hit a solid object or foreign debris, stop the cutter and tractor at once. Immediately idle the engine speed and disengage the PTO. Wait for all cutter rotating motion to stop, then raise the cutter and move the tractor and implement off the object. Inspect the area and remove, or mark the location of the debris. Inspect the condition of the cutter and make any needed repairs immediately. Make sure the blades are not damaged and the carrier is balanced before resuming operation.

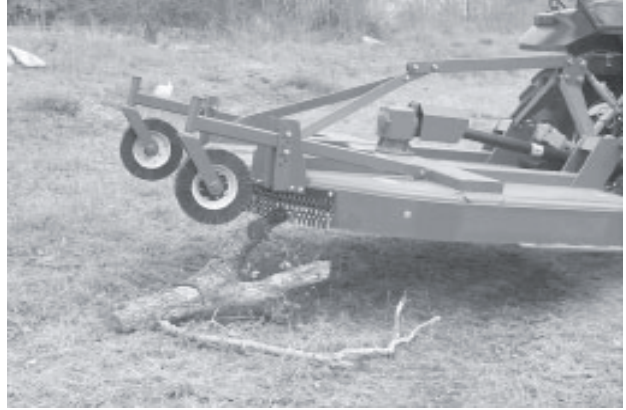

Always wear your seat belt securely fastened and the ROPS in the raised position. If the tractor or cutter contacts a tree stump, rock, or bump, a sudden movement could throw you off of the seat and under the tractor and/or cutter. The seat belt is your best protection from falling off the tractor and the ROPS provides protection from being crushed during a tractor roll-over.

10.2 Bystander/Passersby Precautions

If a bystander comes within 100 yards of the tractor while the cutter is being operated, stop the tractor at once, idle the engine and disengage the PTO. Do not engage the PTO again until all bystanders are well past the 100 yard distance. If the cutter is operated in the vicinity of people or livestock, the cutter must be operated with front chain guards and the retractable rear guard in the lowered position.

DANGER!



Rotary Mowers are capable under adverse conditions of throwing objects for great distances (100 yards or more) and causing serious injury or death. Follow safety messages carefully.

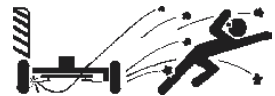

STOP MOWING IF PASSERSBY ARE WITHIN 100 YARDS UNLESS:

- Front and Rear Deflectors, Chain Guards, or Bands are installed and in good, workable condition;
- Mower sections or Wings are running close to and parallel to the ground without exposed Blades;
- Passersby are outside the existing thrown-object zone;
- All areas have been thoroughly inspected and all foreign material such as rocks, cans, glass, and general debris has been removed.

NOTE: Where there are grass and weeds high enough to hide debris that could be struck by the blades, the area should be: inspected and large debris removed, mowed at an intermediate height, inspected closely with any remaining debris being removed, and mowed again at the desired final height. (This will also reduce power required to mow, reduce wear and tear on the Mower drivetrain, spread cut material better, eliminate streaking, and make the final cut more uniform.) (SRM-1)

OPERATION

10.3 Engaging the Power Take Off (PTO)

Before engaging the PTO, make certain that the area is clear of bystanders and passersby. Set the tractor engine speed at approximately 1,000 rpm before engaging the PTO. Shift the PTO control to the on position, and slowly increase the engine speed until the PTO is operating at 540 or 1000 rpm. If you hear unusual noises or see or feel abnormal vibrations, disengage the PTO immediately. Inspect the cutter to determine the cause of the noise or vibration and repair the abnormality.

DANGER!



Do not let the Blades turn when the Mower deck is raised for any reason, including clearance or for turning. Raising the Mower deck exposes the cutting blades which creates a potentially serious hazard and could cause serious injury or even death from objects thrown from the blades. (SRM-7)

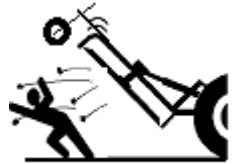

DANGER!



Do not put hands or feet under Mower decks. Blade contact can result in serious injury or even death. (SGM-9)



OPERATION

10.4 PTO RPM and Ground Speed

Ground speed for cutting will depend upon the height, type, and density of vegetation to be cut. Recommended speed for efficient cutter performance is between 1 and 3 mph. Operate the cutter at its rated 540 or 1000 rpm PTO speed to maintain blade speed and produce a clean cut. Refer to the tractor operator's manual or the tractor instrument panel for the engine speed and gear to provide the required PTO and desired speed. Make sure that the cutter is operating at its full rated speed before the blades make contact with vegetation. If it becomes necessary to temporarily regulate engine speed, increase or decrease the throttle gradually.

Ground speed is achieved by transmission gear selection and not by the engine operating speed. The operator may be required to experiment with several gear range combinations to determine the best gear and range which provides the most ideal performance from the cutter and most efficient tractor operation. As the severity of cutting conditions increase, the ground speed should be decreased by selecting a lower gear to maintain the proper operating PTO speed.

WARNING!



Do not exceed the rated PTO speed for the Implement. Excessive PTO speeds can cause Implement driveline or blade failures resulting in serious injury or death. (SG-26)

OPERATION

WARNING!



Mow at the speed that you can safely operate and control the Tractor and Mower. Safe mowing speed depends on terrain condition and grass type, density, and height of cut. Normal ground speed range is from 1 to 3 mph. Use slow mowing speeds when operating on or near steep slopes, ditches, drop-offs, overhead obstructions, power lines, or when debris and foreign objects are to be avoided. (SGM-7)

10.5 Operating the Cutter

The cutter is designed to cut vegetative material up to 6" in diameter. The tractor and cutter can be operated by driving across growth that a properly rated tractor can safely pass over. This includes grass, brush, small trees and other type of growth up to about 3" in diameter.

To cut larger vegetation (up to 6" maximum diameter), raise the retractable rear guard and slowly back the cutter into the material. Use extreme care when backing the tractor and cutter. Allow the cutter sufficient time to cut through the material and maintain the operating speed to prevent overloading the cutter and tractor. Only raise the retractable rear guard while backing into areas to be cut. The guard must be maintained in the lowered position at all other times.

DANGER!



Mow only in conditions where you have clear visibility in daylight or with adequate artificial lighting. Never mow in darkness or foggy conditions where you cannot clearly see at least 100 yards in front and to the sides of the Tractor and Mower. Make sure that you can clearly see and identify passersby, steep slopes, ditches, drop-offs, overhead obstructions, power lines, debris and foreign objects. If you are unable to clearly see this type of item discontinue mowing. (SGM-1)

DANGER!



Only mow where you have good visibility and can clearly see the ground and surrounding area that you are working in. Reduce speed when vision of the area is reduced or if you are avoiding foreign debris.

OPERATION

When you get to the end of a pass, slightly raise the cutter (2-4") before turning. Never raise the cutter entirely while the blades are turning. If the cutter must be raised higher than 12" from ground level, disengage the tractor PTO and wait for all cutter rotation to come to a complete stop before proceeding to raise the cutter.



Large, dense, or wet vegetation may need to be cut in two or more passes to achieve a uniform cut. In such conditions, raise the cutting height to 12" or more on the first pass.



Then lower the cutting height of the cutter and cut the vegetation a second time. If possible, select a cutting pattern that is at a 90 degree angle to the first pass to reduce streaking and provide a more even cut.



OPERATION

Stay alert and watch for trees, low hanging limbs, power lines, and other overhead obstacles and solid ground objects while you are operating. Use care to avoid hitting these items.



Do not cut, or drive the tractor into, material that is burning, or areas that recently burnt and may contain hot spots. Burning material, sparks, and coals could be thrown from the cutter to areas of vegetation that might ignite. Tire damage can occur when driving over hot material. Oil and grease on the tractor and cutter could ignite resulting in equipment destruction. Carry a fire extinguisher on the tractor at all times to extinguish possible fires encountered.

10.6 Shutting Down the Cutter

To shut down the cutter, first bring the tractor to a complete stop. Then slow down the cutter by reducing the engine speed before disengaging the PTO. Wait for all rotating motion to stop before proceeding to drive or shut down the tractor. The momentum created by the blade carrier weight and lack of resistance resulting from the over-running clutch result in the blades turning for an extended period of time after the PTO had been disengaged.



Park the tractor on a level surface, place the transmission in park or neutral and apply the parking brake, lower the attached cutter to the ground, shut down the engine, remove the key, and wait for all motion to come to a complete stop. Push and pull the hydraulic remote control lever several times to relieve hydraulic pressure before exiting the tractor.



WAIT A MINUTE--SAVE A LIFE--YOUR LIFE

OPERATION

11. DISCONNECTING THE CUTTER FROM THE TRACTOR

DANGER!



Never stand or allow another person to stand between a running Tractor and the Mower when disconnecting the Implement from the Tractor 3-point hitch. Always shut the Tractor off completely and set the parking brake before attempting to disconnect the Mower pins from the Tractor hitch.

Before disconnecting the mower, the PTO must be disengaged and blade rotation at a complete stop. Move the cutter to a level storage location and lower it to the ground. If it is not resting securely on the ground, block the cutter up securely before attempting to disconnect it from the tractor.

Use extreme care to keep feet and hands from under the cutter and clear of any pinch points caused by the tractor hitch arms and cutter pins.



To disconnect the cutter, first extend the tractor 3-point hitch top link to remove tension on the top link hitch pin. When the pin is loose and easy to rotate, remove the pin from the cutter. Next remove both lower hitch pins. Replace removed hitch pins into cutter. With hydraulic pressure relieved, remove hydraulic hose ends from the tractor's hydraulic ports. Secure hose ends onto cutter to prevent contact with dirt.



After disconnecting the 3 lift points, remove the cutter driveline from the tractor PTO shaft by removing the yoke clamping cone with a 11/16" (17mm) wrench and pulling the driveline yoke off the PTO shaft. If the connecting cone cannot be removed by hand, drive it out from the opposite side using a hammer and punch. Lay the driveline down carefully to avoid damaging the driveline or its shield. Do not let the driveline fall into mud or dirt, which can contaminate the bearing and shorten the life of the driveline.

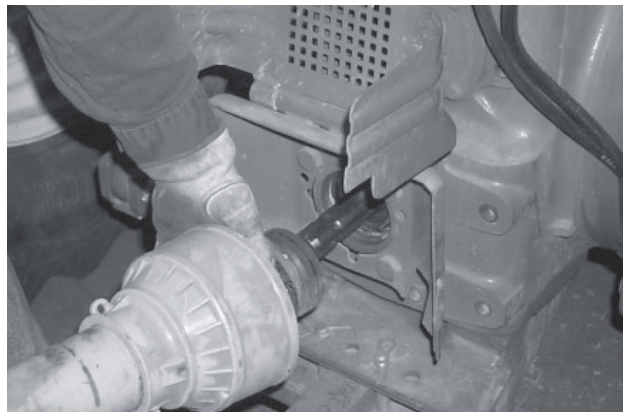

OPERATION

12. CUTTER STORAGE

Properly preparing and storing the cutter at the end of the season is critical to maintaining its appearance and to help ensure years of dependable service. The following are suggested storage procedures:

1. Thoroughly clean all debris off the cutter to prevent damage from rotting grass and standing water.
2. Lubricate all cutter grease points and fill gearbox oil level as detailed in the maintenance section.
3. Tighten all bolts and pins to the recommended torque.
4. Check the cutter for worn and damaged parts. Perform repairs and make replacements immediately so that the cutter will be ready for use at the start of the next season.
5. Store the cutter in a clean, dry place with the cutter housing resting securely on blocks or at ground level.
6. Keep the driveline yoke from sitting in water, dirt and other contaminants.
7. Use spray touch-up enamel where necessary to prevent rust and maintain the appearance of the cutter.



It is critical that the driveline clutch slip when an obstacle or heavy load is encountered to avoid cutter and/or tractor damage. If the cutter sits outside for an extended period of time or is exposed to rain and/or humid air, the clutch lining plates must be inspected to ensure they are not frozen together from rust or corrosion. If the cutter has been exposed to such conditions, at the start of each mowing season, and any time it is suspected that the slip clutch plates may be frozen together, readjust the slip clutch as detailed in Seasonal Clutch Maintenance of the maintenance section in this manual.

DANGER!



Never allow children to play on or around the Tractor and Implement. Children can slip or fall off the Equipment and be injured or killed. Children can cause the Implement to shift or fall crushing themselves and others. (SG-25)

OPERATION

13. TRANSPORTING THE TRACTOR AND CUTTER

Inherent dangers of operating the tractor and cutter and the possibility of accidents are not left behind when you finish cutting an area. Therefore, the operator must employ good judgement and safe operation practices when transporting the tractor and cutter between locations. By using good judgement and following safe transport procedures, the possibility of accidents while moving between locations can be substantially minimized.

DANGER!



Never allow children or other persons to ride on the Tractor or Implement. Falling off can result in serious injury or death.

(SG-10)



OPERATION

Before transporting the tractor and cutter, idle the tractor engine, disengage the PTO and wait for all cutter moving parts to come to a complete stop. Once all cutter parts are completely stopped, raise the cutter to transport height. NOTE: When raising the cutter, maintain 1" clearance between the driveline and cutter deck. If additional cutter deck height is needed for safe transport, disconnect the driveline from the tractor and secure its end to the cutter deck. The cutter can then be raised to the maximum lift height.



If the tractor's hydraulic pump is not independent of the tractor PTO, or if the tractor PTO has to be run to have hydraulic power, disconnect the cutter driveline from the tractor PTO output shaft. Secure the driveline to the mower deck to prevent driveline damage or loss during transport.

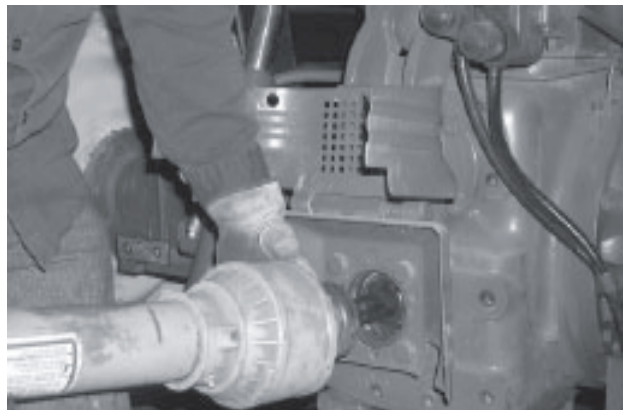

OPERATION

Before transporting the tractor on a public roadway or boarding a trailer for transport, the tractor brake pedals should be locked together. Locking the pedals ensures that both wheels brake simultaneously while stopping, especially when making an emergency stop.

Use extreme caution and avoid hard applications of the tractor brakes when towing heavy loads at road speeds.

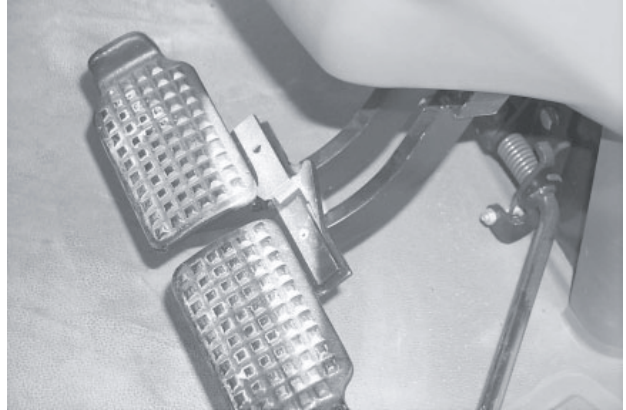

13.1 Transporting on Public Roadways

WARNING!



Make certain that the “Slow Moving Vehicle” (SMV) sign is installed in such a way as to be clearly visible and legible. When transporting the Equipment use the Tractor flashing warning lights and follow all local traffic regulations. (SG-6)

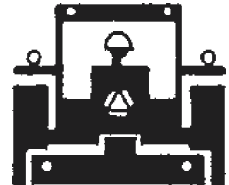

Extreme caution should be used when transporting the tractor and cutter on public roadways. The tractor must be equipped with all required safety warning features including a SMV emblem and flashing warning lights to alert drivers of the tractor's presence. Remember that roadways are primarily designed for automotive drivers and most drivers will not be looking out for you, therefore, you must look out for them. Check your side view mirrors frequently and remember that vehicles will approach quickly because of the tractor's slower speed. Be extremely cautious when the piece of equipment that you are towing is wider than the tractor tire width and/or extends beyond your lane of the road.

The SMV (Slow-Moving-Vehicle) emblem is a universal symbol used to alert drivers of the presence of equipment traveling on roadways at a slow speed. SMV signs are a triangular bright orange with reflective red trim for both easy day and night visibility. Make sure that the SMV sign attached is clean and visible from the rear before operating the tractor and cutter on public roadways. Replace the SMV emblem if faded, damaged, or no longer reflective.



OPERATION

Make sure that all tractor flashing warning lights, headlights, and brake/taillights are functioning properly before proceeding onto public roads. While newer model tractors have plenty of lighting to provide warning signals as well as artificial operating lighting, most older models were only equipped with operating lights. Consult an authorized tractor dealer for lighting kits and modifications available to upgrade the lighting on older tractor models.



When operating on public roads, have consideration for other road users. Pull to the side of the road occasionally to allow any following traffic to pass. Do not exceed the legal speed limit set in your country for agricultural tractors. Always stay alert when transporting the tractor and cutter on public roads. Use caution and reduce speed if other vehicles or pedestrians are in the area.



Reduce speed before turning or applying the brakes. Ensure that both brake pedals are locked together when operating on public roads.



OPERATION

13.2 Hauling the Tractor and Cutter

Before transporting a loaded tractor and cutter, measure the height and width dimensions and gross weight of the complete loaded unit. Ensure that the load will be in compliance with the legal limits set for the areas that will be traveled through.



Use adequately sized and rated trailers and equipment to transport the tractor and cutter. Consult an authorized dealer to determine the proper equipment required. Using adequately sized chains, heavy duty straps, cables and/or binders, securely tie down both the front and rear of the tractor utilizing the proper tie down locations as specified by the tractor manufacturer.



Arrange the chains so that when tightened, the chains are pulling downward and against themselves. Carefully tighten the securing chains or other fasteners used as much as possible using boomers or binders to apply maximum tension. Use extreme care when attaching and removing the securing devices as the extreme tension involved when released has the potential to inflict serious injury.

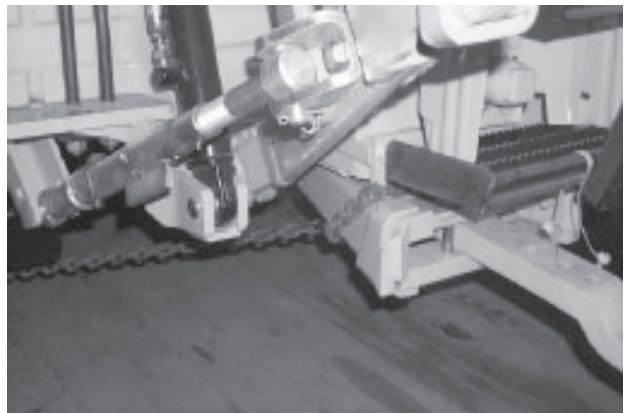

While hauling the tractor and cutter, make occasional stops to check that the tractor and cutter have not moved or shifted and that the securing chains have maintained tension. If during transport a hard braking, sharp turning, or swerving action was performed, stop at the next safe location to inspect security of the load.

OPERATION

TROUBLESHOOTING

PROBLEM	POSSIBLE CAUSE	REMEDY
NOT CUTTING CLEAN	Blades dull. Blade rotation incorrect. Carrier RPM too low. Mower not leveled. Ground speed too fast. Blades locked back. Blades riding up due to blade bolt wear. Blades bent up.	Sharpen or replace Blades. Use correct Blade for Carrier. Increase PTO speed. Adjust machine level Reduce ground speed. Free Blades. Replace Blade Bolts Replace Blades.
BREAKING BLADE BOLTS	Operating with loose Blade Bolts. Worn Blade Bolt.	Tighten Blade Bolts to 400 ft. lbs. Replace Bolt.
CUTTING TOO HIGH	Blades bent up. Blade Bolt Bushing broken or loose. Blade Carrier bent. Blades on upside down.	Replace Blades. Replace or reweld Bushing. Weld with E7018 low Hydrogen rods. Straighten or replace Blade Carrier. Turn Blades right side up and tighten.
CUTTER VIBRATES	Blade locked back. Drivelines not phased. Blade broken. Blade Carrier bent. Blade Hub not properly seated on Shaft. New Blade matched with worn Blade.	Loosen locked Blade. Replace Driveline. Replace Blades in sets. Repair or replace Carrier. Remove Hub, check Shaft, and replace or seat properly. Replace Blades in sets
CUTTER WINDROWING	Cutting heavy material.	Raise Cutter and reduce ground speed.
BLADES WEAR FAST	Cutting in sandy or rocky conditions. Blades too soft.	Increase cutting height. Replace Blades; with hardened, high-quality, Rhino Blades from the manufacturer.
BLADE BOLTS WORKING LOOSE	Bolts not tightened. Bolt hole elongated or oversized. Locknut worn out.	Tighten Bolts to 400 ft. lbs. Replace Bushing or replace Blade Carrier. Replace Locknut.

OPERATION

TROUBLESHOOTING (Continued)

PROBLEM	POSSIBLE CAUSE	REMEDY
BROKEN CROSS OR CUPS	Load too high for joint.	Use protective device with joint. Check joint angles and phasing. Slow down or raise Cutter.
END GALLING OF CROSS AND CUPS	Speed too high. Ears have deformed.	Operate at proper speed (540 or 1000 rpm). Install thrust washer.
NEEDLE ROLLERS HAVE BRINELLED INTO CUP AND CROSS	Load too high for joint.	Check for small joint angles. Use protective device. Check joint angles and phasing.
SHAFT OR TUBE TWISTED	Over-loaded.	Replace part and then slow down or raise Cutter. Use protective device.
TUBE BROKEN IN WELDED SEAM	Over-loaded.	Replace part.
YOKE BROKEN AT EAR TIP	Over-loaded.	Replace part.
GEARBOX NOISY	Improper backlash. Rough gears. Worn Bearing.	Refer to Maintenance Section Wear in or change Gears. Replace Bearing.
SLIP CLUTCH SLIPPING EXCESSIVELY	Excessive load. Springs weak. Improper adjustment. Too much power for Slip Clutch. Friction Facings worn. Oil on Facings. Friction Facings glazed.	Reduce speed and/or raise Mower. Replace Springs. Re-adjust Slip Clutch. Reduce ground speed and material intake. Replace Facings. Replace Facings Clean with emery cloth.
OIL BLOWING OUT VENT PLUG	Flat bottomed Vent Plug or shallow cavity Plug. Oil level too high.	Replace with proper Vent Plug, Cavity in Oil Plug should be approximately 5/8". Lower oil level to Plug.

OPERATION

TROUBLESHOOTING (Continued)

PROBLEM	POSSIBLE CAUSE	REMEDY
GEARBOX LEAKING	Damaged Oil Seal. No Oil Seal. Oil too light. Bent Shaft. Oil Seal race rough. Oil Seal installed wrong. Oil Seal not sealing in the housing. Bearings loose. Vent Plug stopped up. Oil level too high. Gasket damaged. Bolts loose.	Replace Seal. Install Oil Seal. Use EP140. Replace Oil Seal and Shaft. Replace Shaft or repair Race. Replace Seal. Replace Seal or use a sealant on O.D. of Seal. Adjust Bearings. Open Vent Plug. Drain oil to proper level. Replace Gasket. Tighten Bolts.
DRIVELINE INTEGRAL SHIELDS RATTLING OR NOT TURNING FREELY	Integral Shields deformed. Nylon Bearing worn.	Replace Shield. Replace Nylon Bearing.

MAINTENANCE SECTION

Maintenance Section 5-1

MAINTENANCE

Before operating your Rotary Cutter, make sure it is properly lubricated and thoroughly inspected. Only a minimum of time and effort is required to regularly lubricate and maintain this machine to provide long life and trouble free operation.

WARNING!

Always disengage the PTO before raising the Rotary Cutter for transporting or making adjustments.



LUBRICATION INFORMATION

Do not let excess grease collect on or around parts, particularly when operating in sandy areas. The illustrations below shows lubrication points. The chart gives the frequency of lubrication in hours, based on normal operating conditions. Severe or unusual conditions may require more frequent lubrication. **Figure 1.**

Use an SAE multi-purpose, lithium-type grease for all locations shown. Be sure to clean the fitting thoroughly before using grease gun. Daily lubrication of the wing driveline slip joint is necessary. Failure to maintain proper lubrication will result in damage to U-joints, gearbox, and/or driveshaft.

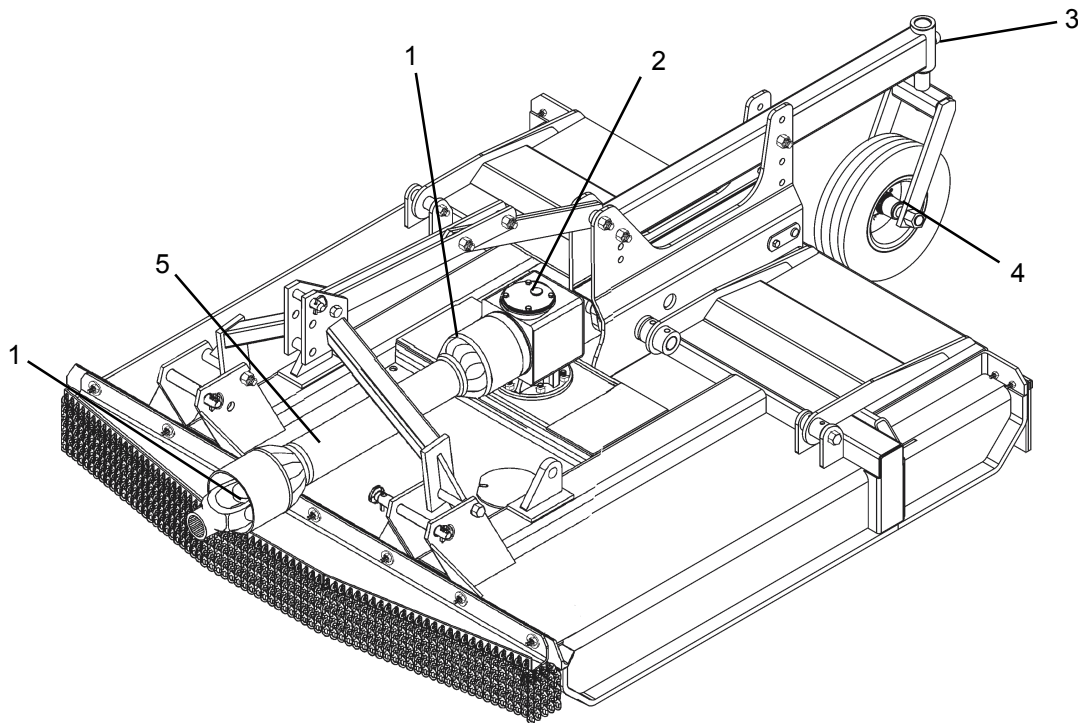

LUBRICATION FITTING LOCATION

FIGURE 1

ITEM	DESCRIPTION	FREQUENCY
1	U-Joints	8 hours
2	Gearbox	Check daily
3	Tailwheel Pivot	10 Hours
4	Wheel Hubs	Weekly
5	Telescoping	8 hours

MAINTENANCE

GEARBOX

The Gearbox has been filled with lubricant to the Test Plug Level prior to shipment. However, you should check the oil level at Test Plug before operating, and frequently thereafter.

The gearbox should not require additional lubricant unless the box is cracked or a seal is leaking. It is recommended that the oil level plug be removed after every 8 to 10 hours of operation and oil added until it runs out Test Plug hole. The Test Plug is located on the side of the Gearbox. Filler Plug is located on top of Gearbox.

FIGURE 2.

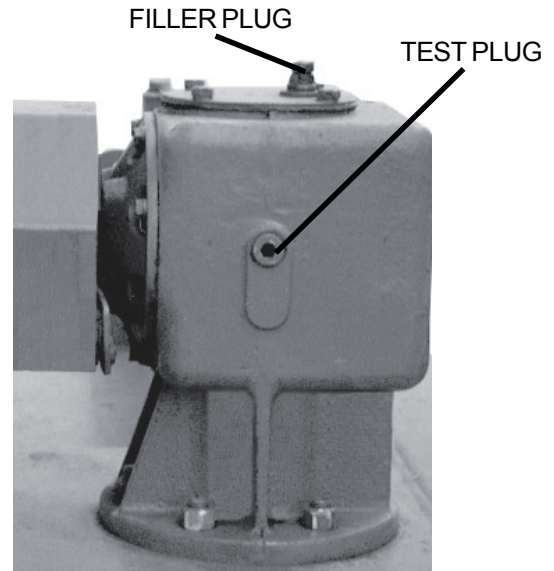

FIGURE 2

NOTE: Overfilling the Gearbox will cause pressure to build up and cause Oil Seals to leak.

ATTENTION: If the Gearbox suddenly starts making an unusual noise, stop at once, check for leaks, and refill Gearbox as required.

Required lubricant is a NLGI000 Grease (P/N 00769030) EP additives for extreme pressure and temperature.

NOTE: Overfilling the Gearbox will cause pressure to build up and cause Oil Seals to leak.

ATTENTION: If the Gearbox suddenly starts making an unusual noise, stop at once, check for leaks, and refill Gearbox as required.

TAIL WHEEL ASSEMBLY

Tail Wheel Bearings are packed at the factory with specification EP 2 grease. Grease Fittings are provided in the Wheel Hub and Tail Wheel Beam. Grease after 10 hours of use. **Figure 3 & 4.**

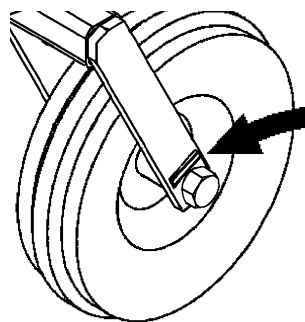

FIGURE 3. Tail Wheel Bearing Lubrication

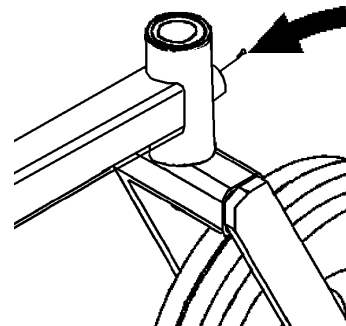

FIGURE 4. Tail Wheel Beam Lubrication

MAINTENANCE

DRIVELINE LUBRICATION

Grease Fittings are located on the Cross Assembly of each U-Joint and on the telescoping tubes. Grease the U-Joint after each 8 hours of use. **Figure 5.** Grease the telescoping tubes after every 8 hours use. Some PTO-to-Hitch connections may necessitate cutting a hole in the shields to be able to align the Grease Fitting holes for lubrication. Lubricate the shield bearings every 16 hours. **Figure 6.**

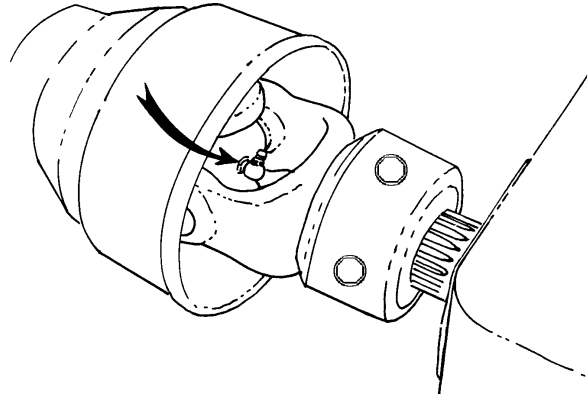

FIGURE 5. U-Joint Lubrication

CAUTION!



Make certain that the Driveline Integral Shields are free to telescope and rotate around the Driveline without binding.

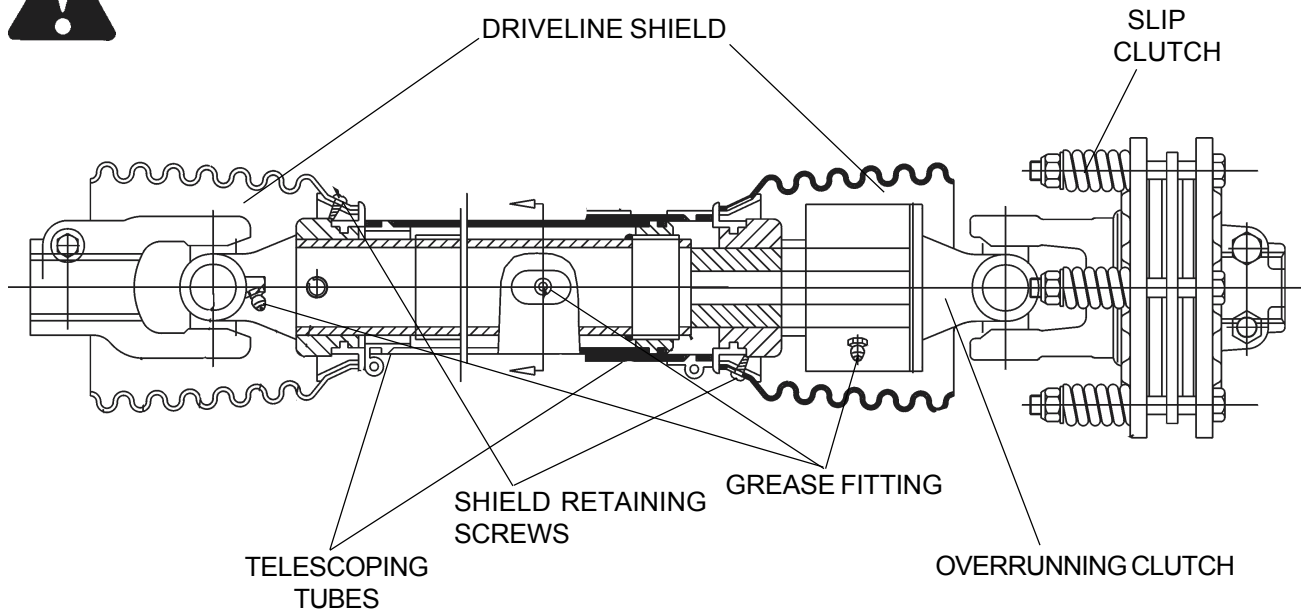

FIGURE 6. Driveline Maintenance

MAINTENANCE

MAIN DRIVELINE & CAT 4 SAFETY SHIELD

To remove the main inner driveline shield, Remove the locking screws. Align the bearing tabs with the cone pockets. **FIGURE 7.** Remove the half-guard and remove the bearing ring. **FIGURE 8.**

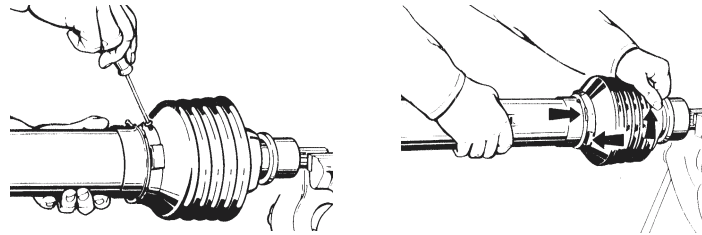

FIGURE 7

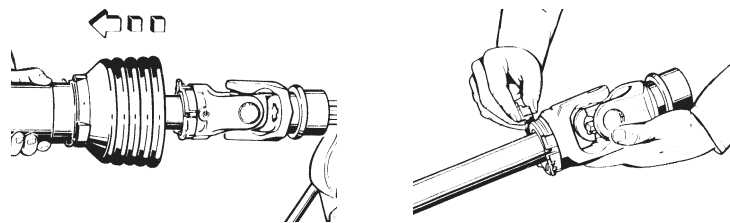

FIGURE 8

Inspect the driveline shield for worn areas or cracks. If the shield has any dents or cracks, replace the Shield. While the Shields are off, examine the Driveline for signs of abnormal wear, bent or twisted shafts, or cracks in the shafts or tubes. Check to see that the Drivelines telescope easily. If the Drivelines do not telescope properly or show signs of abnormal wear, the shaft should be repaired or replaced.

To assemble the main inner driveline shield, grease the yoke groove and inner profile tube. Attach the bearing ring in groove with recesses facing profile tube. **FIGURE 9.** Slide on the half shield. Turn the cone until it engages correctly. Install locking screws. **FIGURE 10.**

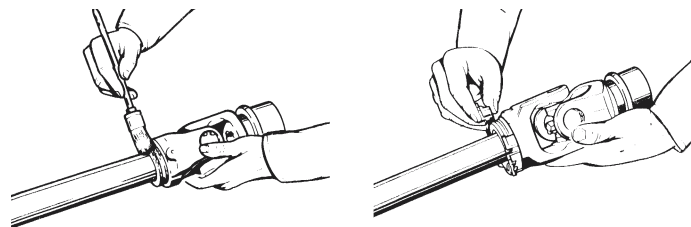

FIGURE 9

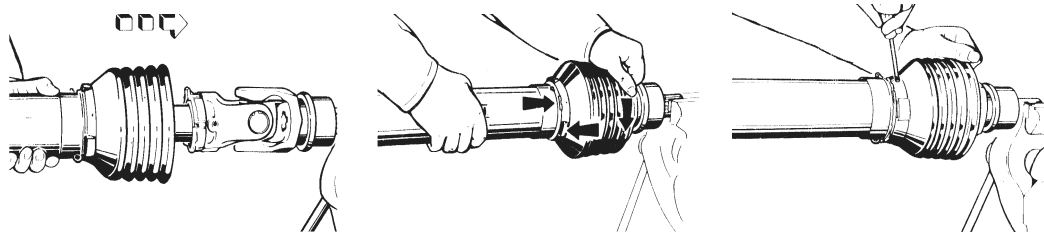

FIGURE 10

MAINTENANCE

BLADE SERVICING

Inspect blades before each use to determine that they are properly installed and in good condition. Replace any blade that is bent, excessively nicked, worn, or has any other damage. Small nicks can be ground out when sharpening.

IMPORTANT! When sharpening blades, grind each blade the same amount to maintain balance. The difference in blade weights should not exceed 1 ounce. Unbalanced blades will cause excessive vibration which can damage gear box bearings. Vibration may also cause structural cracks in cutter housing.

WARNING!



Use only original equipment blades on this cutter. They are made of special heat-treated alloy steel. Substitute blades may not meet specifications and may fail in a hazardous manner that could cause injury.

BLADE SHARPENING

Always sharpen all blades at the same time to maintain balance. Follow original sharpening pattern as shown in **Figure 11**. Always sharpen blades by grinding. **DO NOT** heat and pound out edge. Do not sharpen blade to a razor edge, but leave a 1/16" blunt edge. Do not sharpen back side of blade.

WARNING!



Avoid personal injury. Always block the cutter up to prevent it from falling when the blades and/or carrier are being serviced.

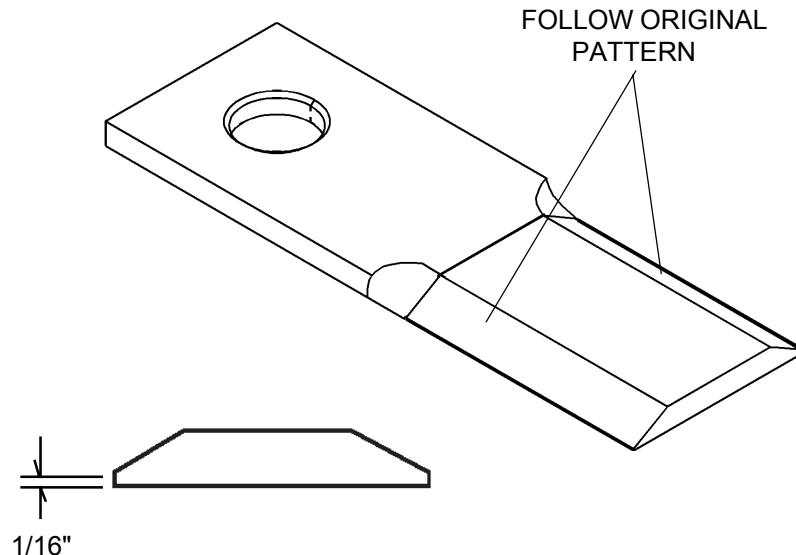

FIGURE 11. Blade Maintenance

WARNING!



Do Not heat weld on hard surface blades as this can alter material strength causing blades to fail in a hazardous manner that could cause injury.

MAINTENANCE

BLADE REMOVAL/INSTALLATION

To remove blades for sharpening or replacement, remove the cover plate on deck of cutter near gear box. Remove lock nut from blade bolt. **NOTE:** *Inspect lock nut after removal and replace if threads are damaged.* Always replace nut when replacing blade bolt. When installing blades be sure and check blade bolt pivot diameter for wear. Replace bolt if worn more than 1/4 inch at any point. See **Figure 12**. Install blade bolts with partially worn side of bolt either toward or away from center. Tighten lock nut to 400 ft. lbs.

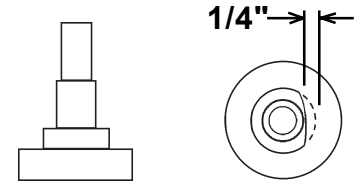

FIGURE 12

WARNING!



Avoid personal injury. Blade and/or blade carrier removal should be done only with the tractor engine shut off, key removed, in neutral, parking brake on, PTO disengaged, and the cutter blocked in the raised position. Never work under the cutter with support blocks to keep the frame from falling.

BLADE CARRIER REMOVAL/INSTALLATION

Move cutter and tractor to a solid level surface (concrete slab of pavement). Raise cutter approximately 12" and securely block at this height. Remove blades before removing carrier to maintain carrier balance. To remove the blade carrier, loosen (DO NOT REMOVE) the six bolts retaining the carrier to the carrier hub. Place a floor jack under cutter and lift carrier on center line between bolts to support carrier. Remove blade carrier bolts at this point. Lower jack with carrier and remove from under cutter deck. Reverse process to install carrier.

BLADE CARRIER HUB REMOVAL/INSTALLATION

To ensure safety, the blade carrier must be removed from the carrier hub, as described above, before removing the carrier hub from the gearbox output shaft. To remove the carrier hub, remove cotter pin and nut from gearbox output shaft. Using a suitable 2-jaw gear puller, pull hub off tapered gear box shaft.

To install the blade carrier hub, clean the splines on both the blade carrier and output shaft. Position the hub on the gearbox output shaft and install special washer nut. Tighten nut holding carrier hub while striking the hub several times with a heavy hammer to seat the hub onto the output shaft. Use a suitable spacer over the nut to prevent damage to the nut and threads. Retighten the nut to a minimum of 450 ft. pounds. Install cotter pin and spread.

IMPORTANT: Always recheck gearbox output shaft and blade carrier to be sure they are retaining nut torque after a few hours operation.

SLIP CLUTCH

A slip clutch is incorporated in the PTO driveline. It is designed to slip, absorb the shock load, and protect the driveline.

After the first hour of operation, the slip clutch should be checked for overheating. After this first check, the slip clutch should be checked weekly or anytime there is overheating. To adjust the coil spring slip clutch, tighten the spring bolts 1/8 (maximum) turn at a time. Bolts should NEVER be adjusted to the point where the coil springs are compressed solid. Minimum spring compression length is 1-7/16".

The slip clutch should be checked periodically and adjusted to compensate for wear. The lining plates are 1/8" thick when new. Replace after 1/32" wear. If the mower has been idle for an extended period of time, or in wet weather, before operating check to be sure the friction lining plates are not rusted/coroded together. Should this occur refer to the procedure described in the "Seasonal Clutch Maintenance" section on the next page.

MAINTENANCE

SEASONAL CLUTCH MAINTENANCE

It is important that the clutches slip when an obstacle or load heavier than the clutch setting is encountered. Therefore, if the machine sits outside longer than 30 days and is exposed to rain and/or humid air it is important to make sure that the clutch lining plates are not rusted/coroded together. Before using the cutter use the following procedure to make sure the clutch will slip and give the overload protection required.

1. Loosen nuts (**Figure 13**) on springs until the springs are free, yet remain secure on bolts.
2. Attach cutter to tractor and start the tractor. Set the engine speed at 1200 RPM.
3. Mark outer plates as shown in **Figure 13**.
4. Engage the PTO (approximately one second) and then quickly disengage it. The friction lining plates should break loose (check the mark).
5. Turn tractor off. (1) Tighten the nuts on the coil spring clutch to their original position of 1-1/2" for 540 RPM and 1-9/16" for 1000 RPM compressed spring length. (2) (Top of washer to pressure plate)

NOTE: This length includes flatwasher between nut and spring.

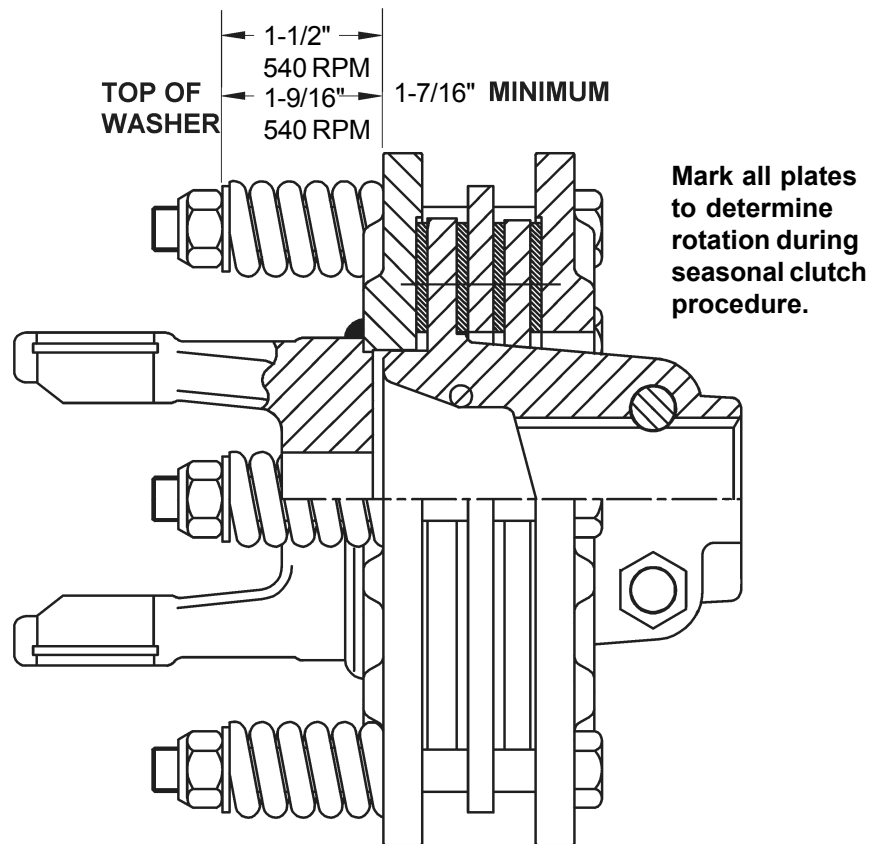

FIGURE 13. Slip Clutch Maintenance

MAINTENANCE

GEARBOX MAINTENANCE

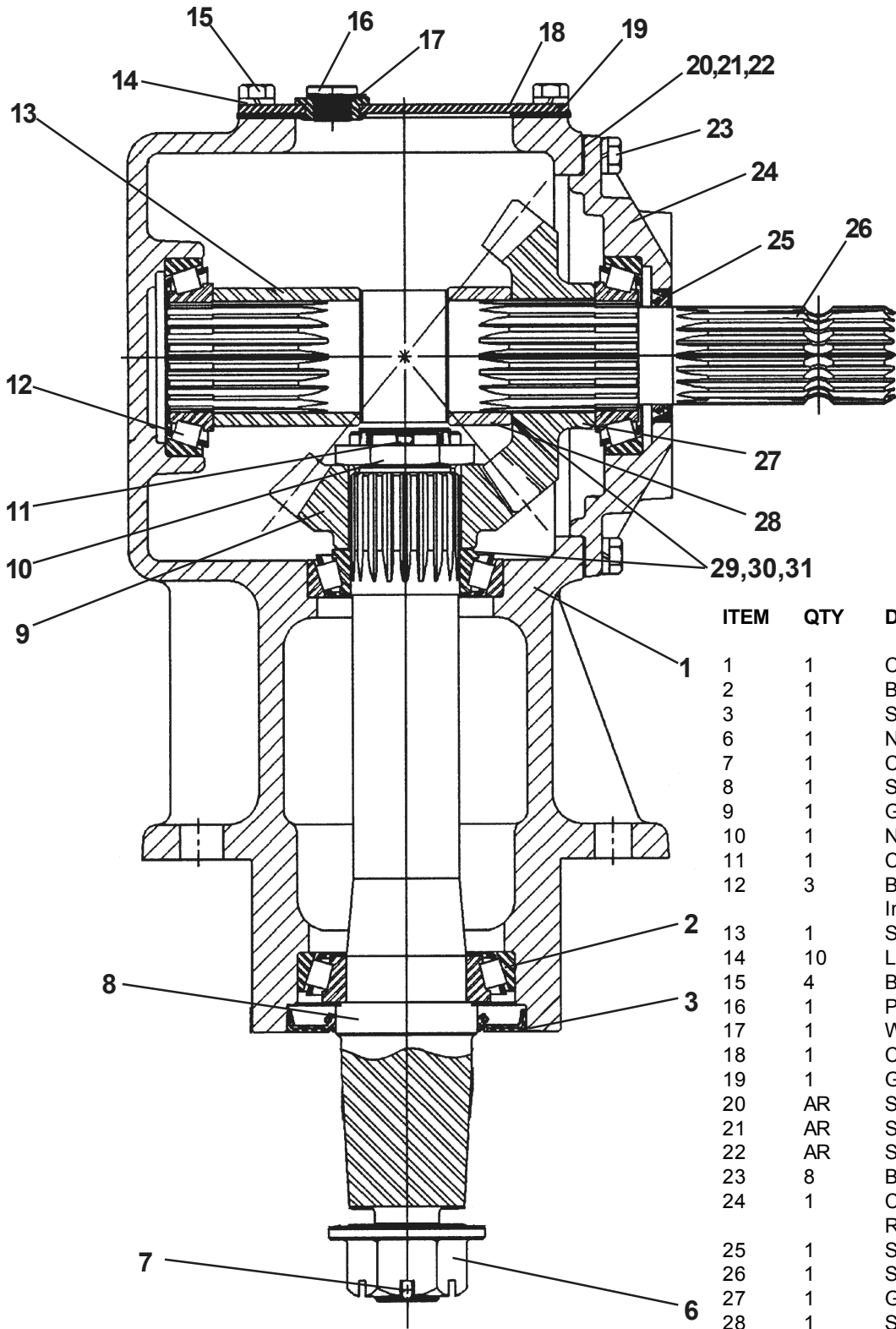

FIGURE 14

ITEM	QTY	DESCRIPTION
1	1	Casing
2	1	Bearing, Lower Output
3	1	Seal, Lower Output
6	1	Nut, Slotted
7	1	Cotter Pin
8	1	Shaft, Output
9	1	Gear, Output
10	1	Nut, Slotted
11	1	Cotter Pin
12	3	Bearing, Upper Output, Inner & Outer Input
13	1	Spacer, Long
14	10	Lockwasher
15	4	Bolt, Top Cover
16	1	Plug, Pressure Vent
17	1	Washer, Sealing
18	1	Cover, Top Inspection
19	1	Gasket, Top Cover
20	AR	Shim (0.10)
21	AR	Shim (0.25)
22	AR	Shim (0.50)
23	8	Bolt, Front Cover
24	1	Cap, Front Bearing Retaining
25	1	Seal, Input
26	1	Shaft, Input
27	1	Gear, Input
28	1	Spacer, Short
29	AR	Shim (0.30)
30	AR	Shim (0.40)
31	AR	Shim (0.50)

MAINTENANCE

MAINTENANCE

RIGHT ANGLE GEARBOX (OUTBOARD) ASSEMBLY & DISASSEMBLY PROCEDURES

INPUT SHAFT REMOVAL

- Step 1.** Place Gearbox on appropriate work surface.
- Step 2.** Remove Vent Plug (item #16) or Complete Top Cover (item #18)
- Step 3.** Turn Gearbox upside down allowing Oil to drain from gearbox into catch pan for proper disposal.
- Step 4.** Turn Gearbox right side up and drop bottom into a hole for support or lay it on its side laying flat.
- Step 5.** Remove Bolts (item # 23) from front Bearing Cap (item # 24), this will allow front cover to be removed, It may be required to drive a wedge between front cover and main housing to loosen cover.
- Step 6.** Remove Input shaft (item #26) and Input Gear (item #27), Input Shaft should pull out with Gear and Bearing Cones (item #12) still on it, Inner Bearing Cone may stay in Housing and Outer Bearing Cone should come off with front Bearing cover.
- Step 7.** Remove Inner Bearing Cone, Inner Spacer (item # 13), Outer Bearing Cone, Input Gear, Check now for Shims (item # 29,30,31) always note quantity of Shims. Remove outer Spacer (item # 28) from Input Shaft.
- Step 8.** Remove Input Seal (item # 25), Bearing Cup (item #12) from front Cover and bearing Cup (item #12) from back of Main Housing (Casing) (item # 1).

OUTPUT SHAFT REMOVAL

- Step 1.** Remove Cotter Pin (item # 11) from Nut (item # 10) and Output Shaft (item # 8) this can be done by reaching through opening in front of Main Housing.
- Step 2.** Slide Output (Pinion) Gear (item # 9) up off of Output Shaft and out of Main Housing.
- Step 3.** Output Shaft will come out of Main Housing through the bottom, If Output Seal is still in bottom of the Main Housing use a Soft Metal (Brass or Aluminum) Pin to Drive Shaft down from the top, This will drive Output Seal out at the same time.
- Step 4.** Reach in from front or top of Main Housing and remove upper Output Shaft Bearing Cone (item # 12)
- Step 5.** From the Bottom of Main Housing drive out top Bearing Cup (item # 12) and from the top drive out the bottom Bearing Cup (item # 2).

PARTS INSPECTION

- Step 1.** Inspect and Clean all Parts. Check Bearings, Shafts, Gears, Housing and Covers. Shafts should be inspected at Seal wear areas, Bearing areas, Splines, Threads and all surface areas. Check Housings for cracks and condition of all holes that are threaded. Check Housing and covers where Seals drive in for Burrs and scratches. If Bearing Cones are replaced always replace Cups with them. Gears should not have and rough surfaces where the gears run together. On Main Housing remove any old Gasket Sealer, Scratches, Wash and completely clean it.

MAINTENANCE

OUTPUT SHAFT INSTALLATION

- Step 1.** Install Upper Output Shaft Bearing Cup (item # 12) into Main Housing from the top, Install Output Shaft Lower Bearing Cup (item # 2) into Main Housing (item # 1) from the bottom, Make sure both Bearing Cup are seated firmly against housing.
- Step 2.** Install Lower Bearing Cone (item #2) down over Output Shaft from top making sure it is completely seated against shoulder on lower part of Output Shaft.
- Step 3.** Insert Output Shaft (item # 8) into Main Housing from the bottom till Lower Bearing Cone is seated into Lower Bearing Cup, Slide Upper Bearing Cone down over Output Shaft from the till it seats down against and into upper output Shaft Bearing Cup.
- Step 4.** Slide Output Gear (item # 9) down over Output Shaft till it sits against upper Bearing Cone.
- Step 5.** Install Output Shaft Bearing Adjusting nut (item # 10) Tighten Nut to set Pre-Load on Output Shaft Bearings. Bearing Preload should be from 12 to 14 inch pounds of Rolling Torque.
- Step 6.** Using Soft Metal (Brass or Aluminum) Pin, Strike both ends of Shaft with a hammer and recheck the Bearing Pre-Load, This is to ensure Bearings and components are centered and seated. If Bearing Pre-Load is OK insert Cotter Pin (item # 11) and Bend ends.
- Step 7.** To Install the Output Seal, Put a light coat of Grease on ID of Seal or on OD of shaft where Seal rides. Install the Output Seal using a Seal Driver.

INPUT SHAFT INSTALLATION

- Step 1.** Install Inner Bearing Cup (item # 12) into back of main Housing (item # 1), Make sure Cup is seated into Main Housing.
- Step 2.** Install Outer Bearing Cup (item # 12) into back of Front Bearing Cover (item # 24). Make sure Cup is Seated into front Cover.
- Step 3.** Install Spacer (item # 13) onto Back side of Input Shaft (item # 26), Install Spacer (item # 28) onto input Shaft (item # 26) from the front. Install Shims (item # 29,30 & 31) onto input Shaft from the front. For quantity of Shims refer to Step 7. on Input Shaft Removal.
- Step 4.** Install Input Gear (item #27) on to Input Shaft from the front, Install Outer Bearing Cone (item # 12) on to input shaft and slide down till it seats against Gear. Install Inner Bearing Cone (item # 12) Onto input shaft.
- Step 5.** Slide Input Shaft with all components down into Main Housing till Inner Bearing Cone is seated into Inner Bearing Cup. Look at Input Gear and Output at this time, Input Gear should not be held up by Outer Gear, if it is it will be required to add Shims (item # 29,30 & 31). If Input Gear and Output Gear seem to far away from each other remove some Shims (item # 29,30 & 31).
- Step 6.** Input Seal (item # 25) can be installed now or wait till later. With Shims (item # 20,21 & 22) lower Input Bearing Cap (item # 24) down over Input Shaft. Install Bolts (item # 23) into Bearing Cap and tighten them, Check Bearing Pre-Load and Gear Back Lash. Bearing Preload should be from 12 to 14 pounds of Rolling Torque, Gear Back Lash should be from .016" to .021". If these are not, shims will have to be removed or added to get these readings.
- Step 7.** Install Top Cover (Item # 18) and Gasket (item # 19), Install Pressure Vent Plug (item # 16) with Sealing Washer (item # 17), Vent Plug must be 5 pounds pressure relief type.
- Step 8.** Fill Gearbox with Oil, remove Oil Level Plug (item # not shown) on side of Main Housing, Remove the vent Plug (item # 16) and fill with oil till oil starts to seep out of Oil Level Plug, Stop and wait about 20 minutes so oil will have time to seep down around Output Shaft bearings then finish filling with oil. This procedure may take longer on Cold days or Shorter on Hot days. Always recheck Oil Level after gearbox has been run approximately 1/2 hour.

MAINTENANCE

STORAGE

Your rotary cutter represents an investment from which you should get the greatest possible benefit. Therefore, when the season is over, the cutter should be thoroughly checked and prepared for storage so that a minimum amount of work will be required to put it back into operation for the next season. The following are suggested storage procedures:

1. Thoroughly clean the cutter.
2. Lubricate the cutter as covered in Maintenance Section.
3. Tighten all bolts and pins to the recommended torque.
4. Check the cutter for worn or damaged parts. Make replacements immediately.
5. Store the cutter in a clean, dry place with the cutter housing resting on blocks.
6. Use spray touch-up enamel where necessary to prevent rust and maintain the appearance of the cutter.



PROPER TORQUE FOR FASTENERS

The chart lists the correct tightening torque for fasteners. When bolts are to be tightened or replaced, refer to this chart to determine the grade of bolts and the proper torque except when specific torque values are assigned in manual text.





RECOMMENDED TORQUE IN FOOT POUNDS UNLESS OTHERWISE STATED IN THE MANUAL *

NOTE: These values apply to fasteners as received from supplier, dry or when lubricated with normal engine oil. They do not apply if special graphited or molydisulphide greases or other extreme pressure lubricants are used. This applies to both UNF fine and UNC coarse threads.

Proper Torque values for bolts that are measured in Inches

Bolt Diameter			
	Head Marking No Marks Grade Two	Head Marking Three Lines Grade Five	Head Marking Six Lines Grade Eight
	Pound - Foot Value Dry	Pound - Foot Value Dry	Pound - Foot Value Dry
1/4"	5.5	9	12.5
5/16"	11	18	26
3/8"	20	33	46
7/16"	32	52	75
1/2"	50	80	115
9/16"	70	115	160
5/8"	100	160	225
3/4"	175	280	400
7/8"	175	450	650
1"	270	675	975
1-1/8"	375	850	1350
1-1/4"	530	1200	1950
1-3/8"	700	1550	2550
1-1/2"	930	2100	3350

Proper Torque values for Metric bolts

Bolt Diameter				
	Head Marking 4.8	Head Marking 8.8 or 9.8	Head Marking 10.9	Head Marking 12.9
	Pound - Foot Value Dry	Pound - Foot Value Dry	Pound - Foot Value Dry	Pound - Foot Value Dry
6mm	4.5	8.5	12	14.5
8mm	11	20	30	35
10mm	21	40	60	70
12mm	37	70	105	120
14mm	60	110	165	190
16mm	92	175	255	300
18mm	125	250	350	410
20mm	180	350	500	580
22mm	250	475	675	800
24mm	310	600	850	1000
27mm	450	875	1250	1500
30mm	625	1200	1700	2000

* To get Newton-Meters multiply pound-foot of torque by 1.356

SERVIS-RHINO

LIMITED WARRANTY

1. LIMITED WARRANTIES

- 1.01. Servis-Rhino warrants for one year from the purchase date to the original non-commercial, governmental, or municipal purchaser ("Purchaser") and warrants for six months to the original commercial or industrial purchaser ("Purchaser") that the goods purchased are free from defects in material or workmanship.
- 1.02. Manufacturer will replace for the Purchaser any part or parts found, upon examination at one of its factories, to be defective under normal use and service due to defects in material or workmanship.
- 1.03. This warranty does not apply to any part of the goods which has been subjected to improper or abnormal use, negligence, alteration, modification, or accident, damaged due to lack of maintenance or use of wrong fuel, oil, or lubricants, or which has served its normal life. This warranty does not apply to any part of any internal combustion engine, or expendable items such as blades, shields, guards, or pneumatic tires except as specifically found in your Operator's Manual.
- 1.04. Except as provided herein, no employee, agent, Dealer, or other person is authorized to give any warranties of any nature on behalf of Manufacturer.
- 1.05. Some parts are covered by an extended warranty. Refer to the inside back cover of your Operator's Manual for extended coverage, if any.

2. REMEDIES AND PROCEDURES.

- 2.01. This warranty is not effective unless the Purchaser returns the Registration and Warranty Form to Manufacturer within 30 days of purchase.
- 2.02. Purchaser claims must be made in writing to the Authorized Dealer ("Dealer") from whom Purchaser purchased the goods or an approved Authorized Dealer ("Dealer") within 30 days after Purchaser learns of the facts on which the claim is based.
- 2.03. Purchaser is responsible for returning the goods in question to the Dealer.
- 2.04. If after examining the goods and/or parts in question, Manufacturer finds them to be defective under normal use and service due to defects in material or workmanship, Manufacturer will:
 - (a) Repair or replace the defective goods or part(s).
 - (b) Reimburse Purchaser for the cost of the part(s) and reasonable labor charges (as determined by Manufacturer) if Purchaser paid for the repair and/or replacement prior to the final determination of applicability of the warranty by Manufacturer.
 - (c) The choice of remedy shall belong to Servis-Rhino.
- 2.05. Purchaser is responsible for any labor charges exceeding a reasonable amount as determined by Manufacturer and for returning the goods to the Dealer, whether or not the claim is approved. Purchaser is responsible for the transportation cost for the goods or part(s) from the Dealer to the designated factory.

3. LIMITATION OF LIABILITY.

- 3.01. MANUFACTURER DISCLAIMS ANY EXPRESS (EXCEPT AS SET FORTH HEREIN) AND IMPLIED WARRANTIES WITH RESPECT TO THE GOODS INCLUDING, BUT NOT LIMITED TO, MERCHANTABILITY AND FITNESS FOR A PARTICULAR PURPOSE.
- 3.02. MANUFACTURER MAKES NO WARRANTY AS TO THE DESIGN, CAPABILITY, CAPACITY, OR SUITABILITY FOR USE OF THE GOODS.
- 3.03. EXCEPT AS PROVIDED HEREIN, MANUFACTURER SHALL HAVE NO LIABILITY OR RESPONSIBILITY TO PURCHASER OR ANY OTHER PERSON OR ENTITY WITH RESPECT TO ANY LIABILITY, LOSS, OR DAMAGE CAUSED OR ALLEGED TO BE CAUSED DIRECTLY OR INDIRECTLY BY THE GOODS INCLUDING, BUT NOT LIMITED TO, ANY INDIRECT, SPECIAL, CONSEQUENTIAL, OR INCIDENTAL DAMAGES RESULTING FROM THE USE OR OPERATION OF THE GOODS OR ANY BREACH OF THIS WARRANTY. NOTWITHSTANDING THE ABOVE LIMITATIONS AND WARRANTIES, MANUFACTURER'S LIABILITY HEREUNDER FOR DAMAGES INCURRED BY PURCHASER OR OTHERS SHALL NOT EXCEED THE PRICE OF THE GOODS.
- 3.04. NO ACTION ARISING OUT OF ANY CLAIMED BREACH OF THIS WARRANTY OR TRANSACTIONS UNDER THIS WARRANTY MAY BE BROUGHT MORE THAN TWO (2) YEARS AFTER THE CAUSE OF ACTION HAS OCCURRED.

4. MISCELLANEOUS.

- 4.01. The laws of the State of Texas shall govern the construction of this agreement. Venue for any lawsuits shall be in Guadalupe County, Texas.
- 4.02. Manufacturer may waive compliance with any of the terms of this limited warranty, but no waiver of any terms shall be deemed to be a waiver of any other term.
- 4.03. If any provision of this limited warranty shall violate any applicable law and is held to be unenforceable, then the invalidity of such provision shall not invalidate any other provisions herein.

KEEP FOR YOUR RECORDS

ATTENTION: Purchaser should fill in the blanks below for his reference when buying repair parts and/or for proper machine identification when applying for warranty.

Servis-Rhino Implement Model _____ Serial Number _____

Date Purchased _____ Dealer _____

ATTENTION:
READ YOUR OPERATOR'S MANUAL

701-SRW.PM4-92

RHINO[®]
1020 S. Sangamon Ave.
Gibson City, IL 60936
800-446-5158
Email: parts@servis-rhino.com





TO THE OWNER/OPERATOR/DEALER

To keep your implement running efficiently and safely, read your manual thoroughly and follow these directions and the Safety Messages in this Manual. The Table of Contents clearly identifies each section where you can easily find the information you need.

The OCCUPATIONAL SAFETY AND HEALTH ACT (1928.51 Subpart C) makes these minimum safety requirements of tractor operators:

REQUIRED OF THE OWNER:

1. Provide a Roll-Over-Protective Structure that meets the requirements of this Standard; and
2. Provide Seatbelts that meet the requirements of this paragraph of this Standard and SAE J4C; and
3. Ensure that each employee uses such Seatbelt while the tractor is moving; and
4. Ensure that each employee tightens the Seatbelt sufficiently to confine the employee to the protected area provided by the ROPS.

REQUIRED OF THE OPERATOR

1. Securely fasten seatbelt if the tractor has a ROPS.
2. Where possible, avoid operating the tractor near ditches, embankments, and holes.
3. Reduce speed when turning, crossing slopes, and on rough, slick, or muddy surfaces.
4. Stay off slopes too steep for safe operation.
5. Watch where you are going - especially at row ends, on roads, and around trees.
6. Do not permit others to ride.
7. Operate the tractor smoothly - no jerky turns, starts, or stops.
8. Hitch only to the drawbar and hitch points recommended by the tractor manufacturer.
9. When the tractor is stopped, set brakes securely and use park lock, if available.

-
- Keep children away from danger all day, every day...**
 - Equip tractors with rollover protection (ROPS) and keep all machinery guards in place...**
 - Please work, drive, play and live each day with care and concern for your safety and that of your family and fellow citizens.**



LJ60/72-SOM - 02/02
Printed U.S.A.

LUMBERJACK
60/72
TREE CUTTER

P/N 00772058C

WARRANTY REGISTRATION CARD IS ON FILE.
WILL BE REFUSED UNTIL COMPLETED, SIGNED
ATTENTION: ANY CLAIM SUBMITTED TO SERVIS-RHINO®

DEALER AND PURCHASER MUST SIGN.
DAYS OF DELIVERY DATE OF THIS MACHINE.
FILLED OUT, SIGNED, AND MAILED WITHIN 30
THIS WARRANTY REGISTRATION MUST BE
TO PLACE THIS WARRANTY IN EFFECT,
IMPORTANT!

PLEASE FILL OUT OWNER WARRANTY REGISTRATION INFORMATION
SIGN, AND DROP LAST COPY IN ANY MAILBOX.
Please fold (do not tear), tape, and drop in any mailbox.

SERVIS-RHINO®
1020 S. Sangamon Ave.
Gibson City, IL 60936-9907



Free Manuals Download Website

<http://myh66.com>

<http://usermanuals.us>

<http://www.somanuals.com>

<http://www.4manuals.cc>

<http://www.manual-lib.com>

<http://www.404manual.com>

<http://www.luxmanual.com>

<http://aubethermostatmanual.com>

Golf course search by state

<http://golfingnear.com>

Email search by domain

<http://emailbydomain.com>

Auto manuals search

<http://auto.somanuals.com>

TV manuals search

<http://tv.somanuals.com>