

SHARP®

MODEL

FO-1650
FO-1850

FACSIMILE

OPERATION MANUAL

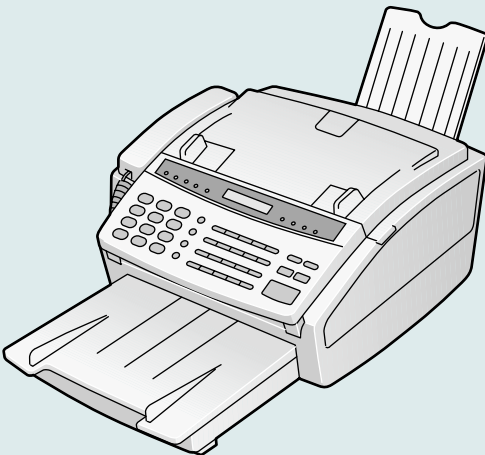

- 1.INSTALLATION
 - 2.INITIAL SETTINGS
 - 3.FAX OPERATIONS
 - 4.USING THE ANSWERING MACHINE
 - 5.MAKING COPIES
 - 6.MAKING TELEPHONE CALLS
 - 7.SPECIAL FUNCTIONS
 - 8.OPTIONAL SETTINGS
 - 9.PRINTING OUT REPORTS AND LISTS
 - 10.MAINTENANCE
 - 11.TROUBLESHOOTING
- SPECIFICATIONS
QUICK REFERENCE GUIDE

INDEX

WARNING — FCC Regulations state that any unauthorized changes or modifications to this equipment not expressly approved by the manufacturer could void the user's authority to operate this equipment.

Note: This equipment has been tested and found to comply with the limits for a Class B digital device, pursuant to Part 15 of the FCC Rules.

These limits are designed to provide reasonable protection against harmful interference in a residential installation.

This equipment generates, uses and can radiate radio frequency energy and, if not installed and used in accordance with the instructions, may cause harmful interference to radio communications. However, there is no guarantee that interference will not occur in a particular installation. If this equipment does cause harmful interference to radio or television reception, which can be determined by turning the equipment off and on, the user is encouraged to try to correct the interference by one or more of the following measures:

- Reorient or relocate the receiving antenna.
- Increase the separation between the equipment and the receiver.
- Connect the equipment into an outlet on a circuit different from that to which the receiver is connected.
- Consult the dealer or an experienced radio/TV technician for help.

ABOUT THE TELEPHONE CONSUMER PROTECTION ACT OF 1991

"The Telephone Consumer Protection Act of 1991 makes it unlawful for any person to use a computer or other electronic device to send any message via a telephone facsimile machine unless such message clearly contains in a margin at the top or bottom of each transmitted page or on the first page of the transmission the following information:

- (1) The date and time of transmission.
- (2) Identification of either the business, business entity or individual sending the message.
- (3) Telephone number of either the sending machine, business, business entity or individual.

In order to program this information into your facsimile machine, please refer to the appropriate instructions in the operation manual."



As an ENERGY STARSM partner, SHARP has determined that this product meets the ENERGY STARSM guidelines for energy efficiency.

FOR YOUR RECORDS

Please record the model number and serial number below, for easy reference, in case of loss or theft. These numbers are located on the rear side of the unit. Space is also provided for other relevant information.

Model Number _____

Serial Number _____

Date of Purchase _____

Place of Purchase _____

INTRODUCTION

Welcome to the FO-1650/1850 and thank you for choosing Sharp! The FO-1650/1850 combines a facsimile and answering machine into a single unit, allowing you to engage in both fax and voice communications with convenience and economy. In addition, the FO-1650/1850 features plain paper printing and the ability to be connected to a personal computer.

This manual gives you easy-to-follow instructions for installing and using the FO-1650/1850. The Table of Contents will show you where instructions for using each feature are located. While you may not need to read every section in detail at first, we recommend you at least look over them briefly.

If you have any questions or problems which cannot be solved by reading this manual, please contact your Sharp dealer.

Important:

- *This facsimile machine is not designed for use on a line which has call waiting, call forwarding, and some other special services offered by your telephone company. If you attempt to use the fax machine in conjunction with any of these services, you may experience errors during transmission and reception of facsimile messages.*
- *This fax machine is not compatible with digital telephone systems. No other fax machines may be connected to the same line.*

Note: *The illustrations in this manual show the FO-1650.*

Important safety information

- If any of your telephone equipment is not operating properly, you should immediately remove it from your telephone line, as it may cause harm to the telephone network.
- The socket-outlet shall be installed near the equipment and shall be easily accessible.
- Never install telephone wiring during a lightning storm.
- Never install telephone jacks in wet locations unless the jack is specifically designed for wet locations.
- Never touch uninsulated telephone wires or terminals unless the telephone line has been disconnected at the network interface.
- Use caution when installing or modifying telephone lines.
- Avoid using a telephone (other than a cordless type) during an electrical storm. There may be a remote risk of electric shock from lightning.
- Do not use a telephone to report a gas leak in the vicinity of the leak.
- Do not install or use the machine near water, or when you are wet. Take care not to spill any liquids on the machine.

TABLE OF CONTENTS

1 INSTALLATION

Unpacking Check List	1-1
Installing the Imaging Film	1-2
Connections	1-6
Attachments	1-8
Loading Printing Paper	1-9

2 INITIAL SETTINGS

Setup Guide	2-1
A Look at the Operation Panel	2-2
Entering Your Name and Fax Number	2-4
Entering Letters for Names	2-5
Setting the Date and Time	2-7
Selecting the Reception Mode	2-8
Answering Machine Set-up	2-9
Distinctive Ringing	2-17
Storing Numbers for Automatic Dialing	2-20
Volume Adjustment	2-24

3 FAX OPERATIONS

Sending Documents	3-1
Receiving Documents	3-11

4 USING THE ANSWERING MACHINE

Operating the Answering Machine	4-1
Remote Operations	4-5
Other Functions	4-13

5 MAKING COPIES

6 MAKING TELEPHONE CALLS

7 SPECIAL FUNCTIONS

Caller ID	7-1
Anti Junk Fax	7-5
Memory	7-6

TABLE OF CONTENTS

Broadcasting	7-8
Polling	7-10
Timer Operations	7-13
Entering and Using Programs	7-15
Reminder Function	7-20
PC Link Function	7-22

8 OPTIONAL SETTINGS

9 PRINTING OUT REPORTS AND LISTS

10 MAINTENANCE

11 TROUBLESHOOTING

Problems and Solutions	11-1
Messages and Signals	11-3
Clearing Paper Jams	11-5

SPECIFICATIONS

FCC REGULATORY INFORMATION

QUICK REFERENCE GUIDE

INDEX

1 INSTALLATION

UNPACKING CHECKLIST

After unpacking your fax, make sure you have all the items shown below. If any are missing, contact your dealer or retailer.

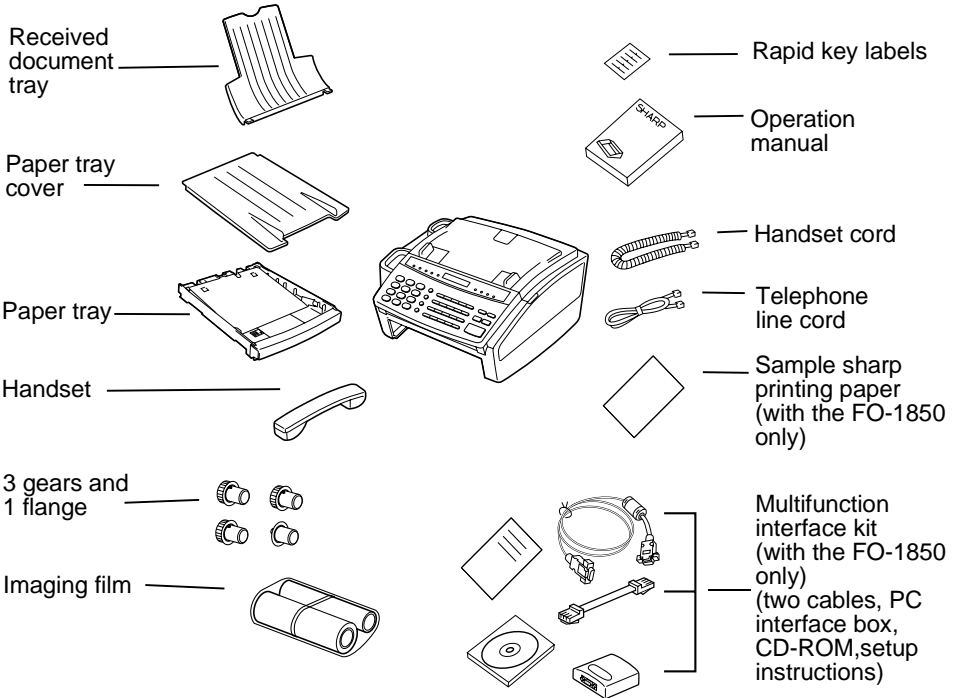

Points to keep in mind when setting up

- ◆ The fax must be installed on a level surface.
- ◆ Keep the fax away from air conditioners, heaters, direct sunlight, and dust.
- ◆ If the fax is moved from a cold to a warm place, it is possible that condensation may form on the reading glass, preventing proper scanning of documents for transmission. To remove the condensation, turn on the power and wait approximately two hours before using the fax.
- ◆ If your area experiences a high incidence of lightning or power surges, we recommend that you install surge protectors for the power and telephone lines. Surge protectors can be purchased at most telephone specialty stores.

INSTALLING THE IMAGING FILM

The printer unit in your fax creates printed text and images by applying heat to the imaging film, which causes toner to be transferred from the film to the page. Follow the steps below to install or replace the imaging film.

1

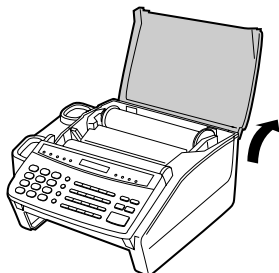

Grasp the finger hold on the right side of the printing compartment cover, and pull up to open the cover.

2

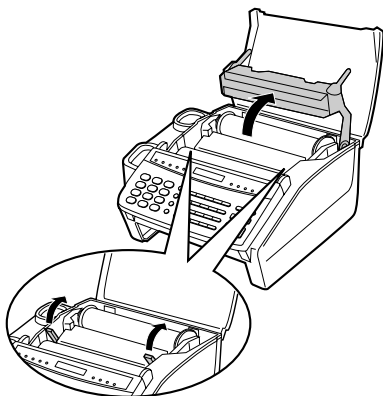

Push back the green levers on each side of the printing compartment, and rotate the printing head frame up and to the rear.

- **Caution!** The printing head (the strip of metal on the underside of the frame) applies heat to the printing film. It may be hot if a document has just been printed.

3



If you are replacing the imaging film, take the old film out of the printing compartment and remove the three gears and the flange from the ends of the spools.

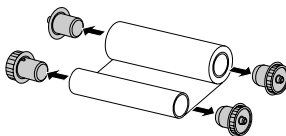

4

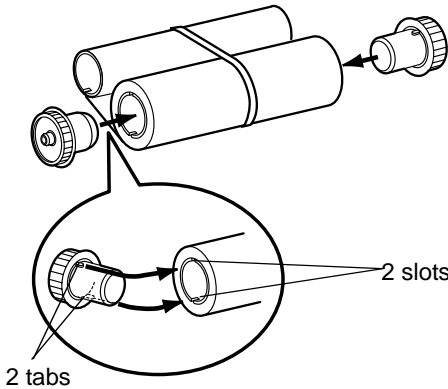

Take the new film out of its package, and insert two of the gears provided with the fax into the ends of the spool with film. Make sure that the two tabs on the gears fit properly into the slots in the ends of the spool.

- Do not yet remove the band which holds the spools together.

5

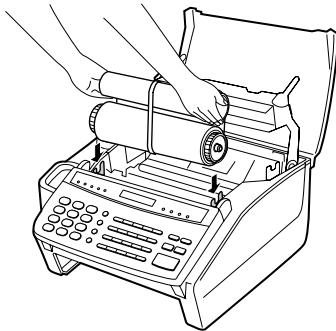

Hold the empty spool so that the end with only one slot is on the left, and lower the spools into the front of the printing compartment. The gears in the ends of the spool with film should fit into the slots on each side of the printing compartment.

6

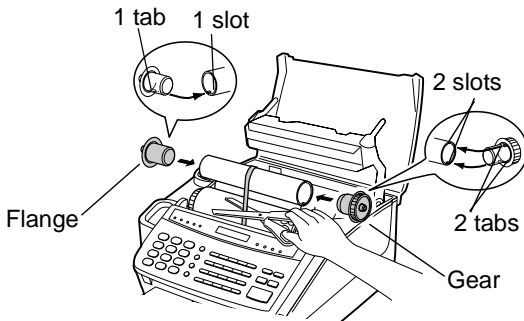

Cut the band which holds the spools together with scissors, and remove it. Insert the remaining gear into the right end of the empty spool and the flange into the left end of the empty spool. Make sure the tabs on the gear and the flange fit into the slots in the ends of the spool (the gear has two tabs and the flange has one tab).

7

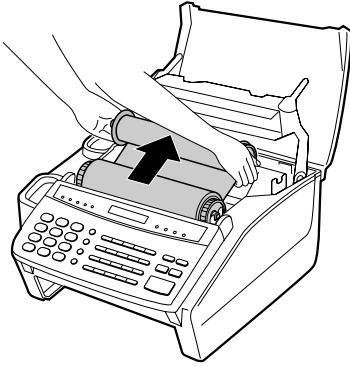

Pull the empty spool toward the back of the compartment, unwinding the film as you pull.

8

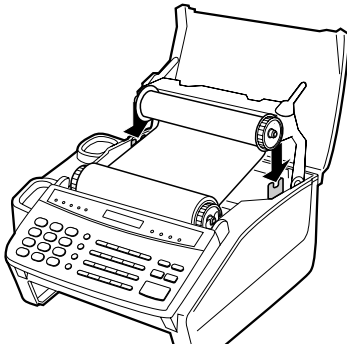

Insert the empty spool into the back of the compartment so that the gear and the flange fit into the slots on the sides of the compartment.

- Make sure that the gear engages with the gear below it.

9



Wind the film slightly (rotate the gear on the right side of the empty spool) so that there is no slack in the film. Make sure that both edges of the film wind onto the spool evenly.

10

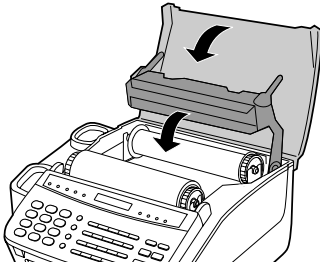

Rotate the printing head frame back down, and press down on the "PUSH" mark in the center of the frame until the frame clicks into place. Close the printing compartment cover.

11

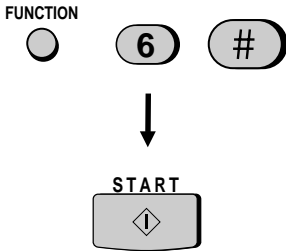

If you replaced the film, initialize the new film by pressing the **FUNCTION** key, the "6" key, and the "#" key on the operation panel. Make sure that "INITIALIZE FILM" appears in the display, and then press the **START** key. (Do not perform this step if you installed the initial sample roll of film.)

- You must initialize FO-16CR film to make it wind to the starting position for printing. If this is not done, the first pages you print will come out blank. Note that initialization will not be possible if the paper tray is not in the fax.

When to replace the imaging film

The sample roll of imaging film provided with your fax is capable of printing approximately 90 pages of letter size paper. When it is used up, "FILM END " will appear in the display. Replace it with the following imaging film, which is available at your dealer or retailer.

FO-16CR Imaging Film

One roll of FO-16CR imaging film is capable of printing approximately 660 pages of letter size paper.

Caution!

The text of documents printed with the imaging film is visible on the used film. If confidential information has been printed, dispose of the film appropriately.

CONNECTIONS

Connect the power cord, telephone line, and handset as shown below. If desired, you can also connect an extension telephone to your fax.

- ◆ You can use an extension phone connected to the fax to make and receive calls like any other extension phone on your line. For details on receiving faxes from an extension phone, see "Receiving Documents" in Chapter 3.

Plug the power cord into a 120 V, 60 Hz, grounded (3-prong) outlet.

Caution: Do not plug the power cord into any other kind of outlet. This will damage the machine and is not covered under the warranty.

AC outlet

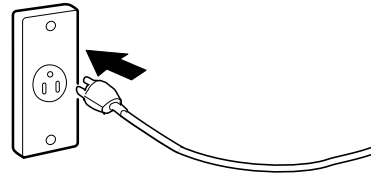

Extension telephone

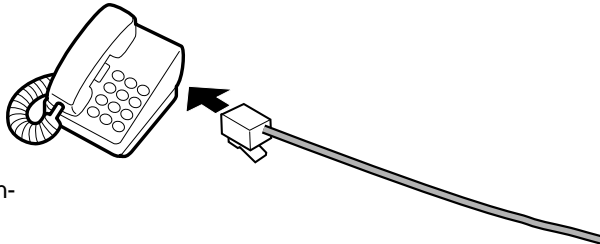

If you want to connect an extension phone to the fax, first remove the seal covering the "TEL. SET" jack on the fax, and then insert the end of the extension phone line into the jack.

Use the handset to make ordinary phone calls, or to transmit and receive documents manually.

Handset

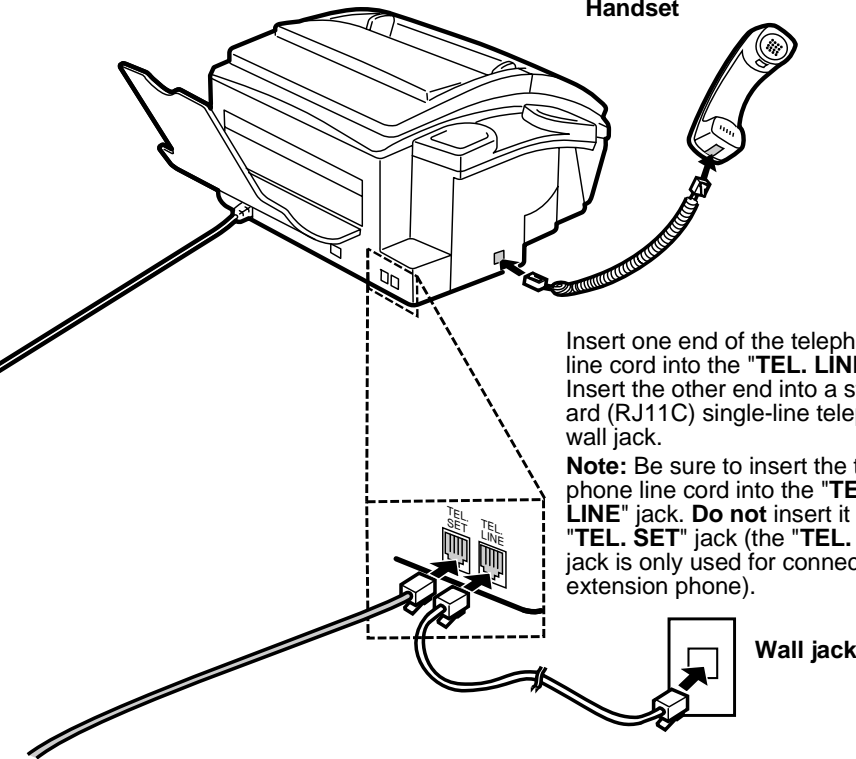

Insert one end of the telephone line cord into the "**TEL. LINE**" jack. Insert the other end into a standard (RJ11C) single-line telephone wall jack.

Note: Be sure to insert the telephone line cord into the "**TEL. LINE**" jack. **Do not** insert it into the "**TEL. SET**" jack (the "**TEL. SET**" jack is only used for connecting an extension phone).

Wall jack

Comments:

- *Your fax is set for touch-tone dialing. If you are on a pulse dial (rotary) line, you must set the fax for pulse dialing by changing Option Setting 8. This procedure is described in Chapter 8, "Optional Settings".*
- **FO-1650 only:** *If you intend to use a computer fax modem on the same phone line as your fax, see "PC Link Function" in Chapter 7 for a explanation of how you can connect your computer to your fax. If you want to use a computer fax modem on the same line but do not want to use the setup described in "PC Link Function", you must set Option Setting 10 to "NO" as described in Chapter 8, "Optional Settings".*
- **FO-1850 only:** *To use your fax with a computer, you must connect it to the computer and install the fax software. Instructions for this are included in the Multifunction interface kit.*

ATTACHMENTS

Attach the received document tray by inserting the tabs into the holes at the rear of the fax.

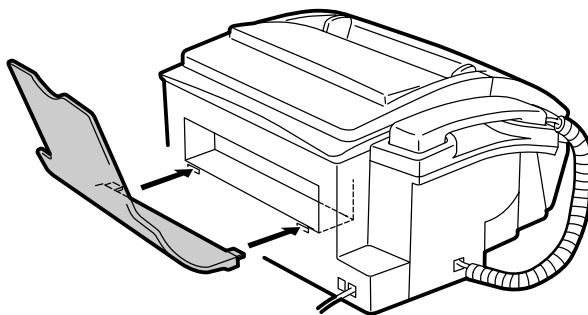

LOADING PRINTING PAPER

The paper tray holds the paper on which received documents and copies are printed. Up to 300 sheets of letter or legal size paper from 16 to 24 lbs. (60 to 90 g/m²) can be loaded in the tray. For the best results, we recommend that you use Sharp FO-16NA (letter size) or Sharp FO-16NB (legal size) paper.

1

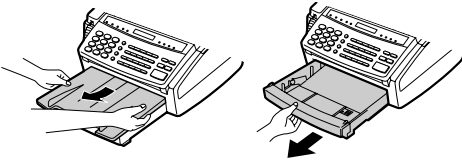

If the paper tray is in the fax machine, remove the cover. Grasp the end of the paper tray, lift it slightly, and pull it out of the fax machine.

• **Important:** You must remove the paper tray from the fax machine to add paper.

2

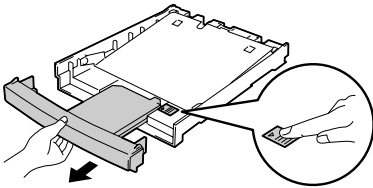

If you are going to load legal size paper, press the catch as shown, and pull out the tray extender.

3

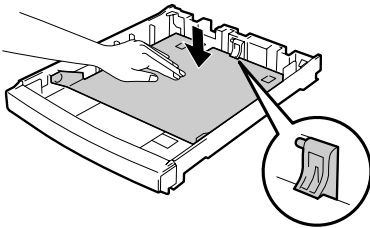

Push the pressure plate down until it locks into position.

4

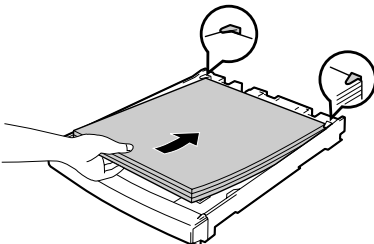

Fan the paper and then place it in the paper tray, print side up. Make sure the corners of the paper go under the holders, and then shake the tray gently to straighten the paper.

5

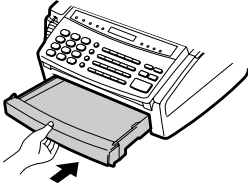

Insert the paper tray into the fax machine, making sure it clicks into place.

6

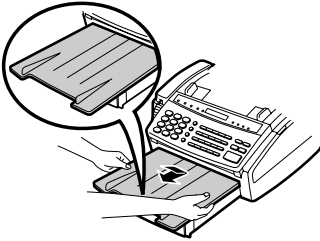

Replace the paper tray cover.

- The paper tray cover also serves as a tray for original documents which come out of the fax after scanning for transmission or copying. You can pull out the cover as needed to ensure that it catches the documents.

7

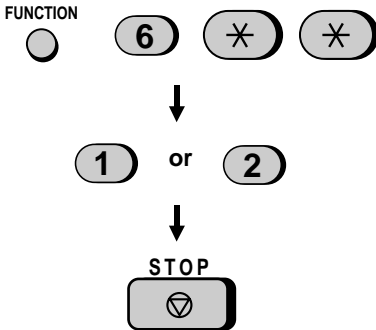

Your fax has been set at the factory to scale the size of the printed image to letter size paper. If you have loaded legal size paper, you must change this setting to legal. To change the setting, press the **"FUNCTION"** key, the **"6"** key, the **"*"** key twice, and then press **"1"** to select letter, or **"2"** to select legal. When finished, press the **STOP** key. Be sure to change this setting every time you change the paper size.

8

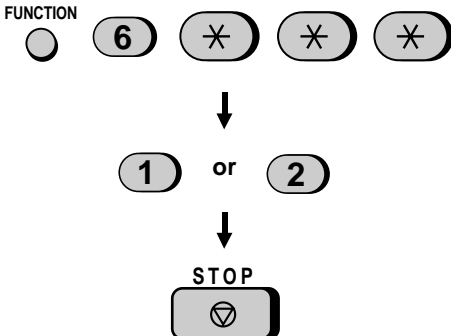

Your fax has been set at the factory to print on regular paper. If you have loaded Sharp FO-16NA or FO-16NB paper, you must change this setting to "HIGH QUALITY". To change the setting, press the **"FUNCTION"** key, the **"6"** key, the **"*"** key three times, and then press **"1"** to select regular, or **"2"** to select Sharp high quality paper. When finished, press the **STOP** key. Be sure to change this setting again if you change back to regular paper.

2 INITIAL SETTINGS

SETUP GUIDE

Before you can begin using your fax, there are some settings which must be made with the keys on the operation panel. Some of the settings are required for basic use of your fax, others may or may not be necessary depending on how you want to use the fax. The procedures for making the settings are described in this chapter in the order shown below (with the exception of Caller ID).

Required settings:

- ◆ Entering your name and fax/telephone number in the fax
- ◆ Setting the fax to the current date and time
- ◆ Selecting the reception mode
- ◆ Answering machine set-up

Settings which may be necessary:

- ◆ Distinctive ringing: If you subscribe to a distinctive ringing service from your telephone company (this is a service which allows you to use several different devices, each with its own phone number and ringing pattern, on one line), you may want to select ringing patterns for the fax and/or the built-in answering machine.
- ◆ Caller ID: If you subscribe to a Caller ID service from your telephone company, the fax will display and retain information which the telephone company provides about each call. To use this feature, reset Option Setting 13 as described in Chapter 8, "Optional Settings". For information on using Caller ID, see "Caller ID" in Chapter 7.

Other settings:

- ◆ Storing numbers for automatic dialing: Automatic dialing allows you to dial a full fax or phone number by simply pressing a Rapid Key, or by pressing the **SPEED DIAL** key and entering a 2-digit number. To use automatic dialing, you must store the desired fax and phone numbers in the fax.
- ◆ Volume adjustment: Adjustment of the volume of the speaker, handset, and ringer.

A LOOK AT THE OPERATION PANEL

Before you make the settings, take a moment to familiarize yourself with the operation panel.

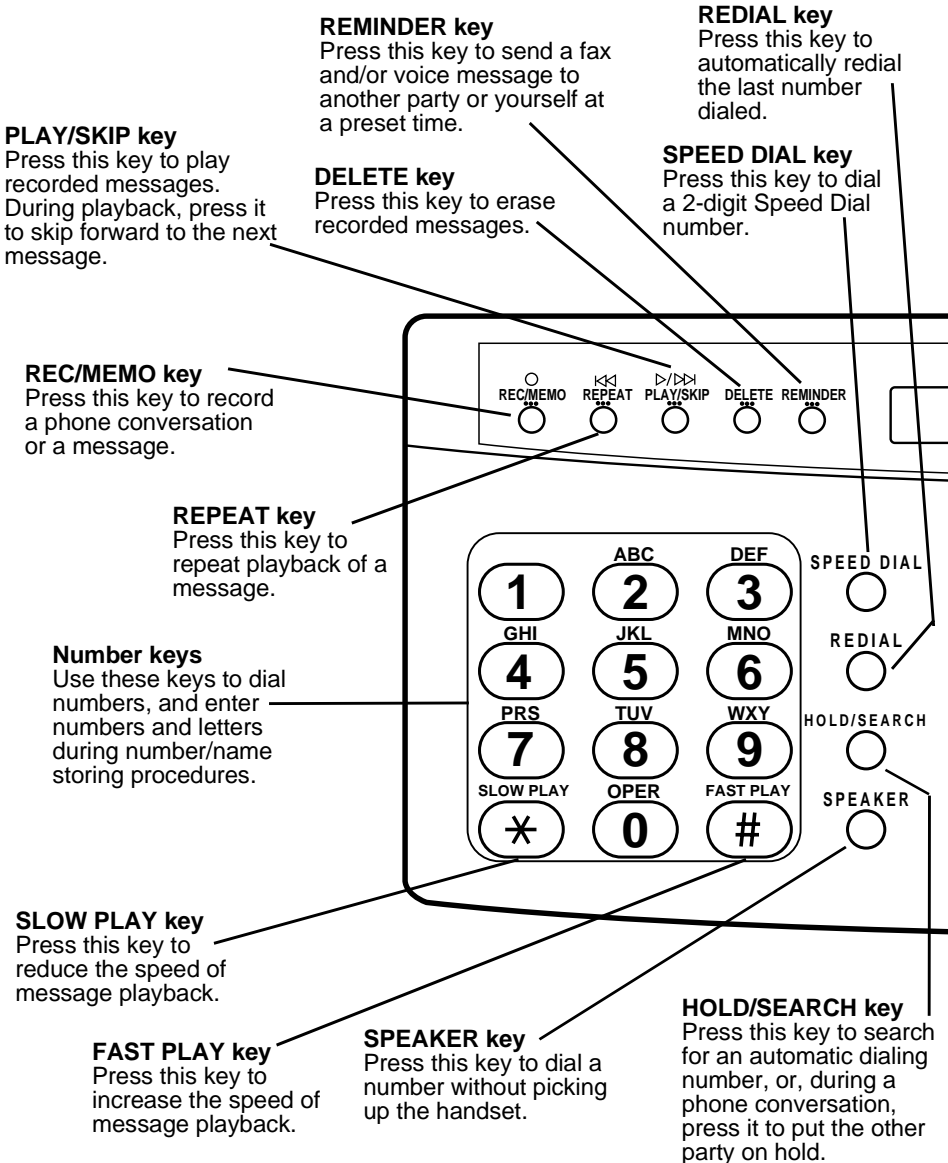

Display

This displays various messages during operation and programming.

RECEPTION MODE key

Press this key to select the mode of reception.

FUNCTION key

Press this key to select various special functions.

RESOLUTION key

Press this key to adjust the resolution and contrast before sending or copying a document.

MEMORY key

Press this key to scan a document into memory before transmitting it.

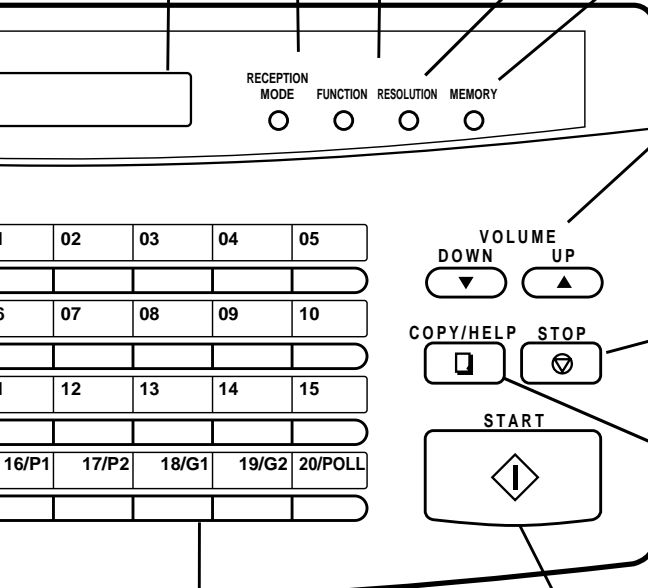

VOLUME keys

Press these keys to adjust the volume of the handset when the handset is lifted, the volume of the speaker when the **SPEAKER** key has been pressed, or the volume of the ringer at all other times.

STOP key

Press this key to stop operations before they are completed.

COPY/HELP key

When a document is in the feeder, press this key to make a copy. At any other time, press this key to print out the Help List, a quick reference guide to the operation of your fax.

Rapid Dial Keys

Press one of these keys to dial a fax or voice number automatically. (Note that you must attach the Rapid Key labels.)

START key

Press this key to send or receive a document.

ENTERING YOUR NAME AND FAX NUMBER

To have your name and fax/telephone number (called the "Sender's name" and "Sender's number") printed at the top of every page you transmit, program them by pressing the panel keys as shown below.

- ◆ You must program your name and fax number in order to comply with the Consumer Protection Act of 1991 (see inside of front cover).
- ◆ If you enter an incorrect number or letter, press the **HOLD/SEARCH** key to move the cursor back to the mistake, then enter the correct number or letter. (To move the cursor forward, press the **SPEAKER** key.)

1 FUNCTION **3**



Press the keys shown at left. "ENTRY MODE" will appear in the display.

2



Press the "#" key 2 times. "OWN NUMBER SET" will appear in the display.

3



Press the **START** key.

4



(Example)

Enter your fax number (max. of 20 digits) by pressing the number keys. (To insert a space between digits, press the "#" key. To insert a "+", press the "*" key.)

5



Press the **START** key.

6

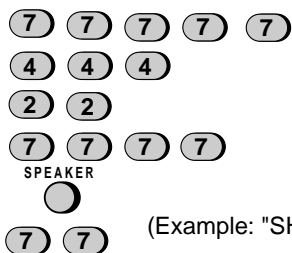

(Example: "SHARP")

Enter your name by pressing the appropriate number keys as shown on the following page. Press each key repeatedly until the desired letter appears in the display. (Max. of 24 characters.)

7



Press the **START** key and then the **STOP** key.

ENTERING LETTERS FOR NAMES

Names are programmed by pressing the number keys. You will notice that letters are marked above each of the number keys "2" through "9". To enter a letter (or number), press the appropriate key one or more times until the letter appears in the display (the number will appear first, followed by the letters in the order marked above the key). The keys used for entering letters and editing are shown below.

Space
Press this key twice to enter a space.

Letters and numbers
To enter a letter or number, press the appropriate key repeatedly until the desired number/letter appears in the display (the number appears first, then the letters in the order marked above the key).

Symbols
Press either key repeatedly until the desired symbol appears (see the symbol list on the following page).

Delete
Press this key to delete the letter highlighted by the cursor (if the cursor is to the right of the last letter entered, it will backspace and delete the last letter).

Shift
Press this key once to change case (press it again to change back).

Cursor left
Press this key to move the cursor to the left.

Cursor right
Press this key to move the cursor to the right.

SPEED DIAL

REDIAL

HOLD/SEARCH

SPEAKER

Comments:

- Enter "Q" with the "7" key, and "Z" with the "9" key (these are not marked on the machine).
- To enter two letters in succession which require using the same key, press the **SPEAKER** key once after entering the first letter, then enter the second letter.
- To change one individual letter to another, move the cursor to that letter and enter the desired letter. The new letter will simply replace the old one.

ENTERING LETTERS FOR NAMES

Symbol list

































To enter a symbol from the list below, press the "#" key or the "*" key repeatedly until the desired symbol appears.

# →	← *
. / ! " # \$ % & ' () * + , - : ; < = > ? @ [¥] ^ _ ` { } → ←	

Example

The following is an example of entering the name "ABC Co. #1".



◆ The cursor in the display is indicated below by a rectangle:



Step	Press these keys:	Display
1	 	A <input type="text"/>
2		A <input type="text"/>
3	  	A B <input type="text"/>
4		A B <input type="text"/>
5	   	A B C <input type="text"/>
6	 	A B C <input type="text"/>
7	   	A B C C <input type="text"/>
8	    	A B C C o <input type="text"/>
9		A B C C o . <input type="text"/>
10	 	A B C C o . <input type="text"/>
11	    	A B C C o . # <input type="text"/>
12		A B C C o . # <input type="text"/>
13		

SETTING THE DATE AND TIME



The date and time appear in the display and reports, and are printed at the top of every page you transmit. Set the date and time by pressing the keys on the operation panel as shown below.



- ◆ To correct a mistake, press the **SPEED DIAL** key to move the cursor back to the mistake, and then enter the correct number.



1   Press the keys shown at left. "ENTRY MODE" will appear in the display.





2    Press the keys shown at left. "DATE & TIME SET" will appear in the display.



3  Press the **START** key.

4  
(Example: January) Enter a 2-digit number for the month ("01" for January, "02" for February, "12" for December, etc.).

5  
(Example: the 5th) Enter a 2-digit number for the day ("01" to "31").

6  
(Example: 1996) Enter the last 2 digits of the year. (Note: In the year 2000, "00" will appear for the year.)

7    
(Example: 9:25) Enter a 2-digit number for the hour ("01" to "12") and a 2-digit number for the minute "00" to "59").

8  or  Press ***** to select A.M., or **#** to select P.M.

9   Press the **START** key and then the **STOP** key.

SELECTING THE RECEPTION MODE

Your fax has three modes for receiving incoming calls and faxes:

TAD mode: Select this mode when you are out and want the built-in answering machine to answer all calls. Voice messages will be recorded, and fax messages will be received automatically. ("TAD" stands for "Telephone Answering Device".)

TEL mode: Select this mode when you are in and want to receive both voice calls and fax messages on the same line. You must answer all calls, including fax messages, using the fax's handset or an extension phone connected to the same line.

FAX mode: Select this mode when you only want to receive fax messages on your line. The fax will answer all calls and receive incoming fax messages automatically.

Setting the reception mode

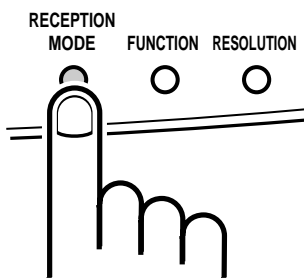

Set the mode of reception with the **RECEPTION MODE** key on the panel.

- To select TAD, press the key until "GENERAL OGM PLAY" appears in the display ("TAD" will appear after the general outgoing message plays).
- To select TEL, press the key until "TEL" appears in the display.
- To select FAX, press the key until "FAX" appears in the display.

Note: TAD mode cannot be selected unless a general outgoing message has been recorded as described in "Answering Machine Set-up" in this chapter.

FO-1850 only: Selecting the receiving unit

If you have connected the FO-1850 to a personal computer with the provided PC interface box, you can choose whether to have incoming faxes received by the FO-1850 or by your computer. The initial setting is "FAX" (reception by the FO-1850). To change the setting, follow the steps below.

For detailed information on how faxes will be received if you choose reception by your computer, see "PC reception" in "Receiving Documents" in Chapter 3.

1 **FUNCTION** **#** Press the **FUNCTION** key and the "**#**" key. "RECEIVE UNIT" will appear in the display.

2 **1** or **2** Press "**1**" (FAX) to select the FO-1850, or "**2**" (PC) to select your computer.

ANSWERING MACHINE SET-UP

About the answering machine

The FO-1650/1850's built-in answering machine allows you to receive both voice messages and fax transmissions while you are out. Up to 24 minutes of voice messages can be recorded when no documents are stored in memory (memory capacity will vary depending on current memory features in use).

When the reception mode is set to T.A.D., the answering machine will automatically answer incoming calls and play your outgoing message (this is your recorded greeting which informs callers that they can leave a message or send a fax). Voice callers can leave a message, and fax transmissions will be received automatically.

The built-in answering machine has four different "boxes" in which voice messages from callers can be recorded. This allows individuals in your office or members of your family to each receive their own private messages. A passcode can be programmed for each box to prevent other people from listening to or erasing messages.

The General Box is for general use, and Boxes 1, 2, and 3 are each for personal use. An outgoing message for the General Box must be recorded, and an outgoing message must also be recorded for each personal box used.

When the answering machine answers a call, the caller will hear the general outgoing message. If the caller wants to leave a message in the General Box, they should wait for the beep and then speak. If the caller wants to send a fax to the General Box, they should press their Start key. By pressing their Start key after speaking, the caller can leave a voice message and send a fax without having to place a separate telephone call.

If the caller wants to leave a message in a personal box, they must enter the number of the box ("1" for Box 1, "2" for Box 2, or "3" for Box 3) by pressing the appropriate key on their telephone before the beep. The outgoing message for the selected box will play, and the caller can then leave a message or press their Start key to send a fax.

When a fax is sent to a personal box, it will not be printed out immediately. Instead, it will print out when you play back the messages left in the box. If you program a passcode for the box, you will be able to receive confidential faxes. When a fax is sent to the General Box, it will be printed out immediately unless a passcode has been programmed for the General Box, in which case it will be printed out after message playback.

Note: *To leave a message in a personal box, the caller must be on a touch-tone phone.*

Recording an outgoing message

To use the built-in answering machine, you must first record a general outgoing message. This must be done even if you only intend to use personal boxes. An outgoing message for each personal box used must also be recorded. A personal box cannot be accessed if it does not have an outgoing message.

The following is an example of a general outgoing message:

"Hello, this is the Jones family. We are not at home right now. If you would like to leave a general message, please speak after the beep. If you would like to leave a private message, press "1" for John, "2" for Jane, or "3" for Billy before the beep. If you would like to send a fax, press your facsimile Start button."

The following is an example of an outgoing message for a personal box:

"This is Jane's personal box. Please leave a message after the beep."

1

FUNCTION



Press the keys shown at left. "T.A.D. SETTINGS" will appear in the display.

2



Press the "#" key. OGM RECORDING will appear in the display.

3



Press the **START** key.

4



(Example)

Press a numeric key to select the outgoing message you want to record:

- "0": General outgoing message
- "1": Box 1 outgoing message
- "2": Box 2 outgoing message
- "3": Box 3 outgoing message
- "4": Transfer outgoing message (This is used for the Transfer function, which is described in "Other Functions" in Chapter 4.)

5

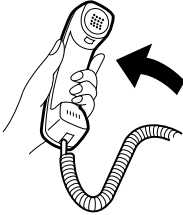

Pick up the handset and speak into it.

- The general outgoing message can be up to 60 seconds long. A personal outgoing message can be up to 30 seconds long.
- While recording, the display will show the time remaining to record.

6

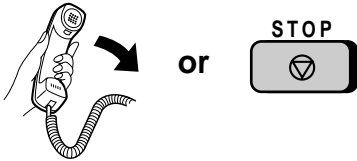

When finished, replace the handset or press the **STOP** key.

- If your message exceeds the time limit or more than 6 seconds of silence is detected, recording will stop automatically.

7



Go back to Step 4 to record an outgoing message for another box, or press the **STOP** key twice to return to the date and time display.

To listen to or erase an outgoing message



To listen to or erase an outgoing message, follow Steps 1 through 4 of the above procedure to select the message, and then press the **PLAY/SKIP** key to listen to it, or the **DELETE** to erase it. To return to the date and time display, press the **STOP** key twice. Note that the general outgoing message cannot be erased. If you need to change it, simply repeat the recording procedure.



Note: If an extension phone is connected to the FO-1650/1850, an outgoing message cannot be recorded, played, or deleted while the extension phone is being used (while **LINE IS IN USE** appears in the display).



Programming a passcode

A 3-digit passcode can be programmed for each of the boxes. If this is done, the passcode must be entered before messages in the box can be listened to or erased. Program a new passcode or clear a previously programmed passcode by pressing the panel keys as shown below.



- ◆ The numbers "1", "2", and "3" cannot be selected for the first digit of the passcode.



1   Press the keys shown at left. "T.A.D. SETTINGS" will appear in the display.

2    Press the keys shown at left. "BOX PASSCODE" will appear in the display.

3  or  Press "1" to enter a passcode, or "2" to clear a previously programmed passcode.

4  Enter the number of the box for which you want to program or clear a passcode by pressing the appropriate numeric key.
(Example) If you are clearing a passcode, go to Step 6.

5    Enter a 3-digit passcode by pressing the number keys.
(Example)

6   Press the **START** key and then the **STOP** key.

Note: To ensure confidentiality, passcodes cannot be checked. If you have forgotten a passcode, clear it and program a new one.

Fax reception in boxes

As explained at the beginning of this section, a caller can press their Start key after accessing a box to send a fax to that box. In this case, the fax will not be printed out until you listen to the messages in the box. If you don't want to receive faxes in boxes, you can turn this function off. When the function is turned off, all faxes will be printed out as soon as they are received, leaving more memory available for voice messages.

Follow the steps below to turn the Fax box function on or off (it has been turned on at the factory).

1

FUNCTION



Press the keys shown at left. "T.A.D. SETTINGS" will appear in the display.

2

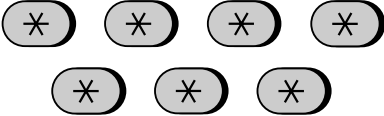

Press the keys shown at left. "FAX BOX" will appear in the display.

3

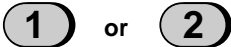

Press "1" to turn the Fax box function on, or "2" to turn it off.

4

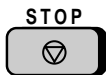

Press the **STOP** key.

Setting ICM time

Incoming messages (ICMs) are the messages which callers leave for you on the built-in answering machine. The answering machine is set at the factory to allow each caller a maximum of 4 minutes to leave a message. If desired, you can change this setting to 15, 30, or 60 seconds.

1

FUNCTION



Press the keys shown at left. "T.A.D. SETTINGS" will appear in the display.

2



Press the keys shown at left. "ICM RECORD TIME" will appear in the display.

3



(Example)

Press a numeric key to select the desired ICM recording time:

- "1": 15 seconds
- "2": 30 seconds
- "3": 60 seconds
- "4": 4 minutes

4

STOP



Press the **STOP** key.

Fax reception on TAD failure

If the memory for recording incoming messages becomes full while you are out, the answering machine will no longer be able to record messages. The ON TAD FAILURE setting is used to choose the response of the machine to incoming calls when this happens:

- ◆ Automatic fax reception "NO": The FO-1650/1850 will answer after 20 rings, after which it will wait to receive a remote command. Most callers will hang up before it answers; however, when you call the FO-1650/1850 from a remote location, you can wait until it answers, listen to your messages, and then erase them (see "Remote operations" in Chapter 4).
- ◆ Automatic fax reception "YES": The reception mode will switch to **FAX** mode, allowing the FO-1650/1850 to continue to receive faxes automatically. With this setting, you can still use the remote commands to listen to your messages and erase the message memory (see "Remote operations").

Automatic fax reception is set to NO at the factory before shipping. If you want to set it to YES, press the panel keys as follows:

1

FUNCTION



Press the keys shown at left. "T.A.D. SETTINGS" will appear in the display.

2



Press the keys shown at left. "ON TAD FAILURE" will appear in the display.

3

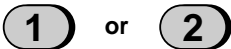

Press "1" to turn automatic fax reception on, or "2" to turn it off.

4



Press the **STOP** key.

Calling Party Control detection

When a caller hangs up, the central telephone exchange will issue a signal called a Calling Party Control (CPC) signal. The built-in answering machine has been set to detect this signal, and this allows it to immediately stop recording when a caller hangs up, thereby saving memory space and freeing you from having to listen to long periods of silence when you play back your messages.

However, if you are a subscriber to such telephone services as Call Waiting or Call Forwarding, signals used by these services may be mistaken for a CPC signal, causing the machine to hang up during a call. In this case, follow the steps below to turn off CPC detection.

Note: *CPC detection may not operate properly in some telephone exchanges. For this reason, periods of silence and/or telephone company signals may be recorded even if CPC detection is turned on.*

1

FUNCTION



Press the keys shown at left. "T.A.D. SETTINGS" will appear in the display.

2



Press the keys shown at left. "CPC DETECTION" will appear in the display.

3



or



Press "1" to turn CPC detection on, or "2" to turn it off.

4



Press the **STOP** key.

DISTINCTIVE RINGING

Distinctive ringing in FAX mode

Distinctive ringing is a service offered by some local telephone companies which allows you to use up to four different telephone numbers, each with a different ringing pattern, on your regular single line. If you subscribe to a distinctive ringing service, you can set your fax to automatically answer when it detects one of those ringing patterns, thereby allowing you to use the number corresponding to that pattern as an exclusive fax number.

Important:

- *To use distinctive ringing, you must subscribe to a distinctive ringing service from your local phone company. Do not make this setting if you do not subscribe to a distinctive ringing service.*
- *Your fax may not be compatible with some distinctive ringing services.*

When using this feature, you must set the reception mode of your fax to FAX as described in "Receiving a Document" in Chapter 3. When your designated fax number is dialed, your fax will automatically answer and begin reception after two rings. Note that other devices on the same line will also ring until your fax answers. If one of your other numbers is dialed, the fax will ring; however, it will not answer.

To use distinctive ringing, select one of the ringing patterns below for your fax by pressing the panel keys as shown on the following page. The selections are as follows:

- | | |
|--------------------|---|
| 1. RING PATTERN 1: | Two short rings. |
| 2. RING PATTERN 2: | One short, one long, and one short ring. |
| 3. RING PATTERN 3: | Two short rings and one long ring. |
| 4. STANDARD RING: | Your standard (normal) ringing pattern. |
| 5. OFF SETTING: | Answer all ringing patterns (this turns distinctive ringing off). |

Your fax has been set to "5" at the factory.

1



Press the keys shown at left. "OPTION SETTING" will appear in the display.

2



Press the keys shown at left. "DISTINCTIVE RING" will appear in the display.

3



(Example)

Select a ringing pattern by entering the appropriate number ("1" to "5" as shown in the list on the previous page).

4



Press the **STOP** key.

Distinctive ringing in TAD mode

You can also use distinctive ringing with the built-in answering machine. By turning on the TAD distinctive ringing setting as shown on the following page, each ringing pattern will be assigned to a message box as follows when the reception mode of the fax is set to TAD.

STANDARD PATTERN:	GENERAL BOX
PATTERN 1:	BOX 1
PATTERN 2:	BOX 2
PATTERN 3:	BOX 3

Each box is accessed by calling the number of its ringing pattern. For example, if a caller dials the number corresponding to ringing pattern 2, the answering machine will answer, the outgoing message for Box 2 will play, and the caller can then leave a message in Box 2. Fax transmissions can be received with any of the ringing patterns.

- ◆ Note that the above assignment of ringing patterns to boxes is not affected by the distinctive ringing setting for FAX mode described on the previous page. The above assignment is effective when the fax is in TAD mode, and the selection made for FAX mode is effective when the fax is in FAX mode.

An outgoing message must be recorded for each box used with distinctive ringing. If an outgoing message is not recorded for a box, the answering machine will not answer when the corresponding number is dialed. However, if you have selected that ringing pattern for fax reception in FAX mode as described on the previous page, the fax will answer that pattern and receive a document just like it does in FAX mode.

As an example, you could have the answering machine answer only the standard ringing pattern by recording an outgoing message only for the General Box. The other patterns would be left free, so you could use one of them for fax reception as described on the previous page, and another for a computer modem or other device.

To turn distinctive ringing in TAD mode on, press the panel keys as follows:

1

FUNCTION



Press the keys shown at left. "DISTINCTIVE RING" will appear in the display.

2



or



Press "1" to turn distinctive ringing in TAD mode on, or "2" to turn it off.

3

STOP



Press the **STOP** key.

STORING NUMBERS FOR AUTOMATIC DIALING

Automatic dialing is a quick and convenient way of dialing which is done by either pressing a Rapid Key (Rapid Key Dialing), or pressing the **SPEED DIAL** key and entering a 2-digit number (Speed Dialing). It can be used for both fax transmissions and voice calls.

To use automatic dialing, you must first store the full number in your fax and assign a 2-digit Speed Dial number to it. You can also enter a name which appears in the display when the number is dialed. Up to 99 numbers can be stored.

- ◆ Speed Dial numbers from "01" to "20" can be used for both Rapid Key Dialing and Speed Dialing; Speed Dial numbers from "21" to "99" can only be used for Speed Dialing.
- ◆ To allow easy identification of the Rapid Keys, attach each strip of Rapid Key labels above the appropriate row of Rapid Keys. The arrangement of the keys is shown in "Operation Panel" at the beginning of this chapter. Each time you store a number for Rapid Key Dialing, write the name of the party above the appropriate key.

Storing numbers

Comments:

- You may need to add a pause between certain digits in the number to allow time for connection. For example, if you are on a PBX telephone system that requires an access number to be dialed (such as "9") to access an outside line, you will need to enter a pause between the access number and the telephone/fax number of the other party. Pauses are entered by pressing the **REDIAL** key (2 seconds per pause). If necessary, several pauses can be entered in a row.
- To enter letters for names or correct a mistake, see "Entering letters for names" in this chapter.

1

FUNCTION



3

#

Press the keys shown at left. "FAX/TEL.
MODE" will appear in the display.

2

1

Press "1" to select SET.

3



Enter a 2-digit number (from "01" to "99") by pressing the number keys. This will be the Speed Dial number.

(Example)

4



Enter the fax or voice number by pressing the number keys (max. of 32 digits including pauses).

(Example)

5



Press the **START** key.

6



Enter the name of the location or party by pressing number keys as described in "Entering Letters for Names" in this chapter (max. of 20 characters). If you don't want to enter a name, skip this step.

(Example)

7



Press the **START** key.

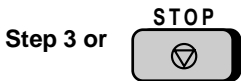

8



Return to Step 3 to store another number, or press **STOP** to exit. If the number will be used for Rapid Key Dialing, you can write the name on the label above the appropriate Rapid Key.

Clearing numbers



Note: You cannot clear a number if it is used in a program or timer operation, or if it is included in a Group Key. First clear the number from the operation or group, then perform the following clearing procedure. To check where the number is used, print out the "Program/Group List and/or the "Timer List" as described in Chapter 7.

1 FUNCTION 3 #
  

Press the keys shown at left. "FAX/TEL. # MODE" will appear in the display.

2 2



Press "2" to select CLEAR.

3 0 1 (Example)
 

Enter the Speed Dial number that you want to clear by pressing the number keys.

4 START

Press the **START** key.

5 Step 3 or STOP

Return to Step 3 to clear another number, or press **STOP** to exit.

Making changes

To make changes in a number previously stored, repeat the storing procedure. Select the code number for which you want to make changes in Step 3, and then change the number and/or name when they appear in the display (Steps 4 and 6, respectively).

Numbers and letters are changed as described in "Entering letters for names" in this chapter.

◆ A lithium battery keeps automatic dialing numbers in memory



Your fax uses a lithium battery to keep automatic dialing numbers and other programmed data in memory when the power is turned off. Battery power is consumed primarily when the power is off. With the power kept continuously off, the life of the battery is about 5 years. If the battery dies, have your dealer or retailer replace it. Do not try to replace it yourself.

Storing Numbers in Group Keys

Group Keys allow you to dial a group of fax numbers by simply pressing the appropriate Group Key once. They are convenient for the Broadcasting function, which is used to transmit a document to a group of fax machines.





Rapid Keys 18/G1 and 19/G2 can be programmed as Group Keys. To program or clear a Group Key, follow the steps below. Note that one key cannot be simultaneously programmed as both a Rapid Key and a Group Key.

- ◆ Up to 20 fax numbers can be stored in one Group Key.
- ◆ Only Speed Dial numbers can be stored in a Group Key. Full numbers cannot be stored.
- ◆ A Group Key cannot be cleared if it is being used in a programmed Broadcasting operation. First clear the programmed operation as described in "Entering and Using Programs" in Chapter 5, then clear the key. If you need to check which program the key is used in, print out the Program and Group List as described in Chapter 7.

1    Press the keys shown at left. "GROUP ENTRY MODE" will appear in the display.

2  or  Press "1" to program a Group Key, or "2" to clear a Group Key.

3  (Example) Press a Group Key (Rapid Key 18/G1 or 19/G2) to select it. If you are clearing the key, go to Step 5.

4     (Example) Enter the Speed Dial numbers of the receiving machines.

5  Press the **START** key.

6 **Step 3 or**  Return to Step 3 to program or clear another Group Key, or press **STOP** to exit.

VOLUME ADJUSTMENT

You can adjust the volume of the speaker, handset, and ringer using the **UP** and **DOWN** keys on the operation panel.

Speaker

The speaker has three volume levels: HIGH, MIDDLE, and LOW. To adjust the volume of the speaker, press the **SPEAKER** key and then press the **UP** or **DOWN** key until the desired level appears in the display. Press the **SPEAKER** key again to turn the speaker off.

Handset

The handset receiver has two volume levels: HIGH and MIDDLE. To adjust the volume of the handset receiver, lift the handset and then press the **UP** or **DOWN** key until the desired level appears in the display.

Ringer

The ringer has four volume levels: HIGH, MIDDLE, LOW, and OFF. To adjust the volume of the ringer, press the **UP** or **DOWN** key until the desired level appears in the display (make sure the **SPEAKER** has not been pressed and the handset is not lifted). The fax will ring at the new volume level each time you change the level. If you select OFF, press the **START** key to confirm your selection.

3 FAX OPERATIONS

SENDING DOCUMENTS

Transmittable documents

Your fax can transmit most standard office documents. Specific guidelines are as follows:

Size and weight

The size and weight of documents which you can load in the document feeder depend on whether you load one sheet at a time or several sheets at once.

One sheet at a time:

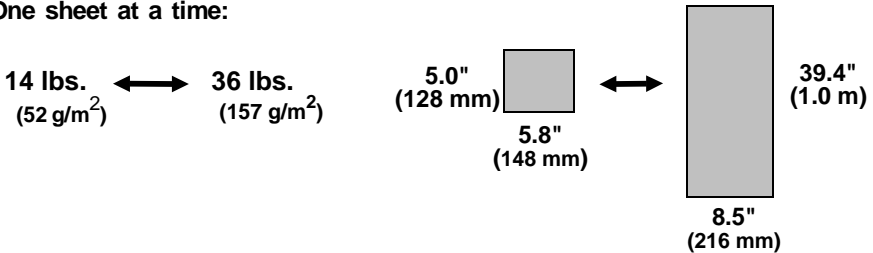

Several sheets at once:

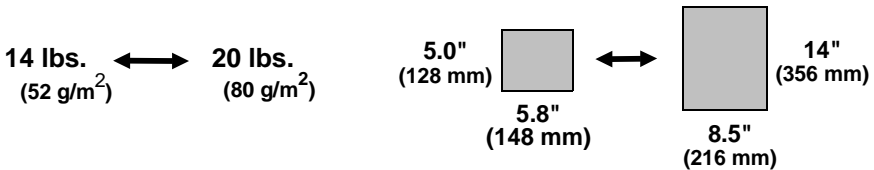

Note: The area of the document which is scanned by the fax is slightly smaller than the actual document size. The scanning width is 8.3 inches, and the scanning length is the length of the document minus 0.32 inches.

Other restrictions

- ◆ Documents written in yellow, greenish yellow, or light blue ink cannot be transmitted, as the scanner does not recognize these colors.
- ◆ Ink, glue, and correcting fluid on documents must be dry before they are transmitted.
- ◆ All clips, staples, and pins must be removed from documents before transmission. If these are not removed, they may damage the fax.
- ◆ Documents which are patched, taped, torn, smaller than the minimum size, carbon backed, or easily smudged should be photocopied, and the copy used for transmission.

Loading the document

Up to 20 pages can be placed in the feeder at one time. The pages will be automatically fed into the fax starting from the page on the bottom.

- ◆ If you need to send or copy more than 20 pages, place the additional pages gently and carefully in the feeder just before the last page is scanned. Do not try to force them in, as this may cause double-feeding or jamming.
- ◆ If your document consists of several large or thick pages which must be loaded one at a time, insert each page into the feeder as the previous page is being scanned. Insert gently to prevent double-feeding.

1

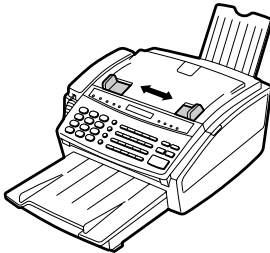

Adjust the document guides to the width of your document.

2

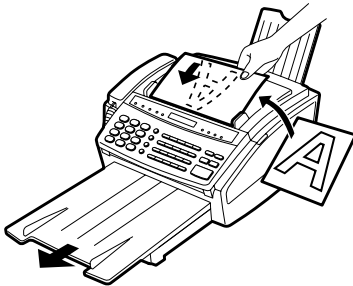

Place the document face down and push it gently into the document feeder. The top edge of the document should enter the fax first.

- The feeder will draw the leading edge of the document into the fax. **READY TO SEND** will appear in the display.

3

You can now either make resolution and/or contrast settings as described in the following section, or dial the other party as described in the section, "Dialing and transmission".

Important:

*If you need to remove the document from the feeder before transmission or copying, first open the operation panel by pulling the front edge up (grasp it at the **"PANEL RELEASE"** mark), and then remove the document. If you try to pull the document out without opening the operation panel, you may damage the feeder mechanism.*

Optional transmission settings

If desired, there are several transmission settings which you can make before dialing and transmitting the document.

Note: To make the settings, the document must first be loaded in the feeder.

Resolution

Your fax has four resolution settings. If you do not make a setting, the fax will automatically send the document in STANDARD resolution.

STANDARD:	Use STANDARD for ordinary documents. This setting gives you the fastest and most economical transmission.
FINE:	Use FINE for improved reproduction, especially with documents containing small letters or fine drawings.
SUPER FINE:	Use SUPER FINE when you need the highest quality of reproduction.
HALF TONE:	Use HALF TONE for photographs and illustrations. The original will be reproduced in 64 shades of gray.

Note: In order to transmit in FINE or SUPER FINE resolution, the receiving fax machine must also have that resolution. If it doesn't, your fax will automatically step down to the next best available setting.

Contrast

The contrast is normally set to AUTO, which means that the fax automatically controls the contrast, but for faint documents you can change the setting to DARK.

Setting the resolution and contrast

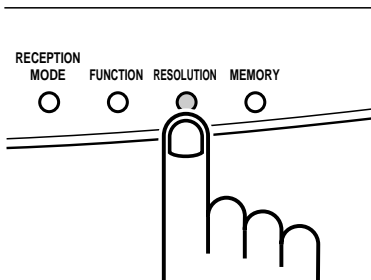

Press the **RESOLUTION** key one or more times until the desired resolution and contrast settings appear in the display.

- The first time you move through the list of resolution settings, the contrast setting AUTO will appear next to each resolution setting. The second time you move through the list, the contrast setting DARK will appear.

Cover Sheet

You can have your fax generate a cover sheet and send it as the last page of the transmission. The cover sheet includes the date and time, the sender's name and number, and the receiver's name and number if an automatic dialing number is used. The total number of pages sent is indicated on the bottom.

- ◆ Your name and number must be programmed in order for them to appear on the cover sheet. (See "Entering Your Name and Fax Number" in Chapter 2.)

To include a cover sheet with each transmission, set Option Setting 14 to "YES" as described in Chapter 8, "Optional Settings". Note that once Option Setting 14 is set to "YES", cover sheets will be automatically included with every transmission until you change the setting to "NO".

When the cover sheet function is turned on, you can also select a message which will appear as a header at the top of the cover sheet. To do so, follow the steps below. Note that the message selection is only effective for one transmission.

1 **FUNCTION** **5** Press the keys shown at left. "COVER SHEET HEAD" will appear in the display.



2 **1** Select a message by entering a number from "1" to "4" as shown below:
"1": URGENT
"2": IMPORTANT
"3": CONFIDENTIAL
"4": PLS. DISTRIBUTE

(Example)

Example

```
URGENT
      AUTOMATIC COVER SHEET
DATE : MAY-22-96 01:12 PM
TO   : JONE SMITH
FAX # : 111-111-1111
FROM : John Doe Corp.
FAX # : 201 555 1234
      2 PAGES WERE SENT
<INCLUDING THIS COVER SHEET>
```

Batch Page Numbering

This setting is used to change the page numbering of the transmitted document from simple numbering ("P.1", "P.2", etc.) to batch numbering, which means that a slash and the total number of pages being sent are added after each page number (for example, "P. 1/5", "P.2/5", etc.). This allows the receiver to check for any missing pages.

- ◆ If you are sending a cover sheet, **do not** include the cover sheet in the total number of pages. Your fax will adjust the number to include the cover sheet automatically.
- ◆ If you need to cancel a batch number entry, remove the document from the feeder or press the **STOP** key.
- ◆ If the number of pages actually transmitted does not coincide with the batch number entered, the alarm will sound and PAGE COUNT ERROR will appear in the display. "PAGE E" will also appear in the "NOTE" column of the Transaction Report if it has been set to print out.

1

FUNCTION



Press the keys shown at left. "PAGE COUNTER SET" will appear in the display.

2



Enter the total number of pages ("01" to "99") by pressing the number keys.

(Example)

Dialing and transmission

Once you have loaded the document and made any desired transmission settings, you are ready to dial the number of the receiving fax machine and transmit the document. There are several ways of dialing, and you can select the one which best suits your needs.

Normal Dialing

With Normal Dialing, you pick up the handset (or press the **SPEAKER** key) and dial as you would to make a telephone call. If the receiving machine is set to receive faxes manually (this means that the receiving party first answers your call vocally, and then presses their Start key to begin fax reception), you can talk with them before sending the fax.

1

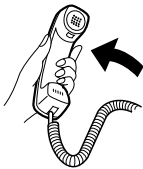

or

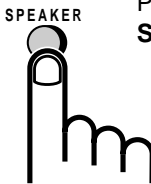

Pick up the handset or press the **SPEAKER** key. Listen for the dial tone.

2

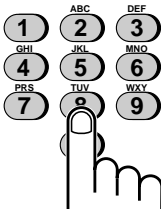

Dial the number of the receiving machine by pressing the number keys.

3

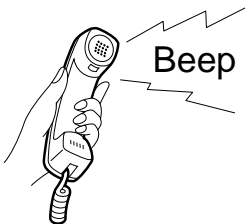

Wait for the connection. Depending on the setting of the receiving machine, you will either hear a facsimile reception tone or the other person will answer.

- If the other party answers, ask them to press their Start key (if you pressed the **SPEAKER** key, pick up the handset to speak with them). This causes the receiving machine to issue a reception tone.

4

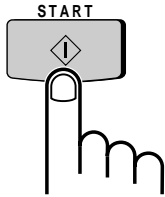

When you hear the reception tone, press the **START** key. Replace the handset if you used it.

- When transmission is completed, the fax will beep.

Direct Keypad Dialing

If you do not need to talk with the other party before sending the fax, you can just dial; it isn't necessary to pick up the handset or press the **SPEAKER** key.

- ◆ Direct Keypad Dialing is a form of automatic dialing, so if you need to insert a pause between any digits of the number, press the **REDIAL** key. (For more information on pauses, see "Storing Numbers for Automatic Dialing" in Chapter 2.)

1

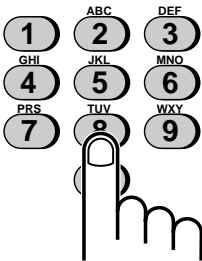

Enter the number of the receiving machine by pressing the number keys.

2

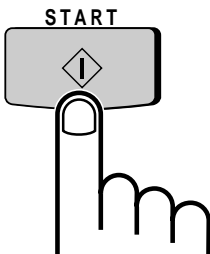

Check the display. If the number of the receiving machine shown is correct, press the **START** key.

- If it is not correct, press the **STOP** key to backspace and clear one digit at a time, and then re-enter the correct digit(s).

Rapid Key Dialing

If the number you want to dial has been stored for automatic dialing as a Speed Dial number from "01" to "20" (see "Storing Numbers for Automatic Dialing" in Chapter 2), you can dial it by pressing the corresponding Rapid Key.

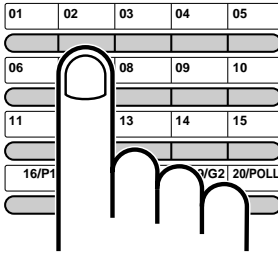

Example: To dial Speed Dial number "02", press Rapid Key 02.

Press the Rapid Key corresponding to the desired Speed Dial number.

- The name of the receiving party will appear in the display. If no name was stored, the fax number will appear. (If the name or number is incorrect, press the **STOP** key.)
- The document will be automatically transmitted once the connection is made.

Speed Dialing

Speed Dialing can be used to dial any number which has been stored for automatic dialing (see "Storing Numbers for Automatic Dialing" in Chapter 2).

1

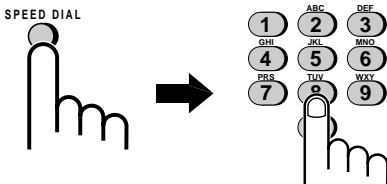

Press the **SPEED DIAL** key and then enter the two digits of the Speed Dial number by pressing the number keys.

- To enter numbers 1 through 9, first enter 0 and then the number.

2

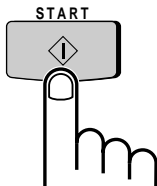

Check the display. If the name or number shown is correct, press the **START** key. (If not, press the **STOP** key and then repeat Step 1.)

Using the HOLD/SEARCH key

If you don't remember the Rapid Key or Speed Dial number in which you have stored a particular fax number, you can search for the number by following the steps below. Once you have found the number, you can dial it and transmit the loaded document by simply pressing the **START** key.

1

HOLD/SEARCH



Press the **HOLD/SEARCH** key and then the "1" key.

2

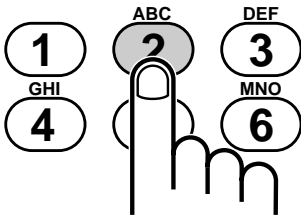

Enter the first letter of the stored name by pressing the appropriate number key (the key below the marked letter) one or more times until the letter appears in the display. If the name begins with a special character or number, press "1".

- If you don't remember the first letter, go to Step 3 (you will scroll through the list from the beginning).
- If a name wasn't stored for the number, press "0". This will cause numbers, not names, to appear when you scroll.

3



or



Press the "#" key or the "*" key to scroll through the names (numbers if you pressed "0"). Stop when the desired name appears in the display.

- If no names have been stored that begin with the entered letter, you will scroll from the next name, in alphabetical order, in the list. If no names/numbers have been stored at all, NO DATA will appear.

4

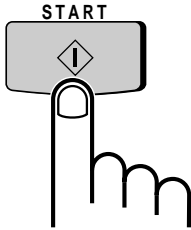

Press the **START** key. The document will be automatically transmitted once the connection is made.

Redialing

Automatic redialing

If you use automatic dialing (including Direct Keypad Dialing) and the line is busy, your fax will automatically redial the number. Up to 2 redialing attempts will be made at intervals of 5 minutes.

- ◆ To stop automatic redialing, press the **STOP** key.
- ◆ If desired, you can change the number of times the fax redials to any number from 0 to 15 with Option Setting 4, and the interval at which redialing is done to any number of minutes from 1 to 15 with Option Setting 3. See Chapter 8, "Optional Settings".

Using the REDIAL key

You can press the **REDIAL** key to redial the last number dialed. To send a document, proceed from Step 3 of Normal Dialing. Note that the speaker will be automatically activated, so you do not need to pick up the handset immediately.

RECEIVING DOCUMENTS

Using FAX mode

When the reception mode is set to FAX (press the **RECEPTION MODE** key until "FAX" appears in the display), your fax automatically answers all calls on 4 rings and receives the incoming documents.

- ◆ You can change the number of rings on which the fax answers incoming calls by changing Option Setting 2 (see Chapter 8, "Optional Settings"). Any number from 1 to 5 can be selected. Note, however, that reception of auto-dialed faxes may not be possible from certain fax machines if you select a large number of rings.
- ◆ If you pick up the handset before your fax answers, you can talk to the other party and/or receive a document as described below in "Using TEL mode". For example, with the fax set to answer on 4 rings, you can receive both voice calls and fax messages in FAX mode by answering before the fourth ring, but still have the fax answer calls automatically at times when you are unable to respond personally.

Note: *If you are using distinctive ringing, your fax will answer incoming calls after two rings regardless of the setting of Option Setting 2.*

Using TEL mode

When the reception mode is set to TEL (press the **RECEPTION MODE** key until "TEL" appears in the display), you must answer all calls (including fax transmissions) using the fax's handset or an extension phone connected to the same line.

Receiving documents on your fax machine

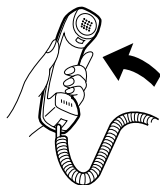

When your fax rings, pick up the handset.

- If you hear a fax tone, wait until **RECEIVING** appears in the display, and then replace the handset.
- If the other party first talks to you and then wants to send a fax, press the **START** key after speaking (press your **START** key before the sender presses their Start key). Replace the handset.

Note: *If you have set Option Setting 10 to "OFF" and you hear a fax tone when you pick up the handset, you must press the **START** key to begin reception.*

Receiving documents on an extension phone

If you hear a soft fax tone when you answer an extension phone, wait until your fax answers (the extension phone will go dead if it is connected to your fax, or you will hear pronounced high-pitched fax tones if the phone is connected to a separate wall jack), and then hang up. Your fax will automatically receive the document.

Note: *If your fax does not respond within 5 seconds, noise on the line may be preventing it from detecting the fax tone. In this case, manually activate fax reception as described in the following paragraph.*

If the other party first talks to you and then wants to send a document, press "5", "✖" and "✖" if you are on a touch tone phone. If you are on a pulse dial phone, set the handset down (do not hang up), walk over to the fax, pick up the handset, and press the **START** key.

Note: *Your fax will not accept the signal to begin reception ("5", "✖", and "✖") if a document is loaded in its feeder.*

Comments:



- *If you have set Option Setting 10 to "OFF" and hear a fax tone when you answer the extension phone, you must press "5", "✖", and "✖" if you are on a touch-tone phone, or walk over to the fax, pick up the handset, and press the **START** key if you are on a pulse dial phone.*
- *The code used to activate fax reception from a touch-tone extension phone ("5", "✖", and "✖") can be changed if desired. See Option Setting 5 ("Tel/Fax Remote Number") in Chapter 8, "Optional Settings".*
- *If you do not intend to use the code for activating fax reception, you can turn detection of the code off by resetting Option Setting 6. This will ensure that the fax never mistakenly attempts to begin reception if it detects a signal similar to "5", "✖", and "✖" while you are talking on an extension phone.*

Optional reception settings

2 in 1 Print

To save paper, you can have the size of your incoming faxes reduced by 55%. This will allow you to receive, for example, a 2-page document on one page (note that this may not be possible if the document pages are longer than your printing paper). To turn on this function, follow the steps below.

1      Press the keys shown at left. "2 IN 1 PRINT" will appear in the display.

2  or  Press "1" to turn on the function, or "2" to turn it off.





3  Press the **STOP** key.



Reception Ratio

Your fax has been set at the factory to automatically reduce the size of received documents to fit the size of the printing paper. This ensures that data on the edges of the document are not cut off. If desired, you can turn this function off and have received documents printed at full size.

Note: If a document is too long to fit on the printing paper, the remainder will be printed on a second page. In this case, the cut-off point may occur in the middle of a line.

Note: Automatic reduction may not be possible if the received document is too large, contains too many fine graphics or images, or is sent at high resolution. In this case, the remainder of the document will be printed on a second page.

1     Press the keys shown at left. "RECEPTION RATIO" will appear in the display.

2  or  Press "1" to turn automatic reduction on, or "2" to turn it off.

3  Press the **STOP** key.

PC reception (only for FO-1850)

If you have connected the FO-1850 to a personal computer with the provided PC interface box and have set the RECEIVE UNIT setting to "PC" as described in "Selecting the Reception Mode" in Chapter 2, faxes will be received as follows depending on the reception mode of the FO-1850:

- ◆ If the FO-1850 is set to FAX reception mode, an incoming call will be automatically answered after the number of rings set in your fax software. The fax will be received by your computer (make sure your fax software is running). If your computer is turned off or the fax software is not running, the FO-1850 will receive the fax.
- ◆ If the FO-1850 is set to TEL reception mode, you must first answer a call by picking up the FO-1850's handset. If the call is an auto-dialed fax transmission (you will hear a fax tone), your computer will automatically begin reception. If the other party speaks to you and then wants to send a fax, you must initiate fax reception manually with the fax software.
- ◆ If the FO-1850 is set to TAD reception mode, the OGM will play before the computer begins fax reception (voice callers will be able to leave a message). If your computer is not turned on or the fax software is not running, the FO-1850 will receive the fax.
- ◆ If the FO-1850 is set to TAD reception mode and the FAX BOX setting is YES, faxes sent to personal boxes will be received by the FO-1850. The FO-1850 will also receive faxes sent to the General Box if a General Box passcode has been programmed.

For information on how to receive faxes with your Multifunction Interface software, refer to your Multifunction Interface software manual.

If the RECEIVE UNIT setting is set to FAX, faxes will be received by the FO-1850 only. FAX, TEL, and TAD reception modes will function as explained in "Reception Mode" in Chapter 2.

Note: *Scanning, printing, and PC faxing can take place in all modes.*

4 USING THE ANSWERING MACHINE

OPERATING THE ANSWERING MACHINE

Activating the answering machine

Activate the answering machine before you go out as follows:

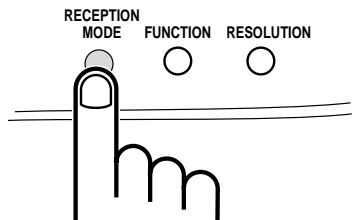

Press the **RECEPTION MODE** key one or two times to set the reception mode to **T.A.D.**

- Each outgoing message will play (you can stop playback by pressing the **STOP** key).
- If no general outgoing message has been recorded, an alarm will sound and the reception mode will change to **TEL**. Record a general outgoing message as described in "Answering Machine Set-up" in Chapter 2.

Note: If the memory is full from messages previously recorded, **MEMORY IS FULL** will appear in the display. To set the reception mode to **T.A.D.**, you must first erase some or all of the stored messages.

When the reception mode is set to **T.A.D.**, the FO-1650/1850 will answer incoming calls after two rings if it has received at least one incoming message, or after four rings if no messages are received. (For more information, see "Toll Saver" in "Remote Operations" in this chapter.)

Note: In **T.A.D.** mode, the machine will automatically switch to fax reception if it detects a period of silence longer than six seconds after answering a call. For this reason, if a caller pauses for this length of time while leaving a message, they will be cut off.

Listening to received messages

When you return, the display will show the number of messages recorded in each box. Listen to them as follows:

1



Press the **PLAY/SKIP** key.

- If you only want to listen to new messages (messages not previously listened to), continue to hold the **PLAY/SKIP** key down for at least two seconds.

2



(Example)

If you want to listen to the messages in a personal box, enter the number of that box by pressing the appropriate number key.

3



(Example)

If the box (general or personal) has a passcode, enter the passcode by pressing the appropriate number keys.

4



SLOW PLAY



FAST PLAY



The messages will play.

- As each message plays, the date and time of recording will appear briefly in the display. If no messages were received, NO MESSAGES will appear.
- To listen to a message a second time, press the **REPEAT** key before playback of that message ends.
- To move back to the previous message, press the **REPEAT** key within 3 seconds of the beginning of the current message.
- To skip forward to the next message, press the **PLAY/SKIP** key.
- To increase playback speed, press the **FAST PLAY** key. To decrease playback speed, press the **SLOW PLAY** key.

Note: Playback will stop if you receive a call, lift the handset, press the **STOP** key, or open the paper compartment cover.

Erasing received messages

It is important to erase received messages after you listen to them to ensure that the memory does not become full. This is done as follows:

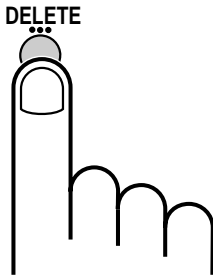

- **Erasing general messages:** To erase all messages in the General Box, press and hold down the **DELETE** key for at least 2 seconds. If the General Box has a passcode, press the **DELETE** key and then enter the passcode.
- **Erasing personal messages:** To erase all messages in a personal box, press the **DELETE** key (**do not** hold it down), enter the number of the box, and then enter its passcode (if it has one).
- **Erasing a single message:** To erase only a single message, press the **DELETE** key while the message is being played.

Using the REC/MEMO key

You can use the **REC/MEMO** key to record telephone conversations and messages for other users of the FO-1650/1850. These will be recorded in the General Box, and played back together with any incoming messages in that box when the **PLAY/SKIP** key is pressed.

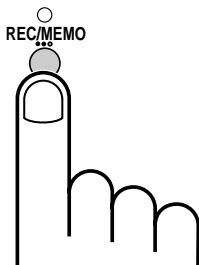

- **Recording messages:** To record a message, press the **REC/MEMO** key for at least 1 second, and then pick up the handset and speak into it. When you have finished speaking, replace the handset or press the **STOP** key.

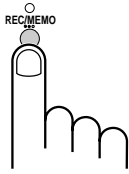

- **Recording phone conversations:** To record a phone conversation, hold down the **REC/MEMO** key during the conversation you want to record. When you are finished, release the key.

Note: To comply with federal and local regulations regarding recording a telephone call, start the recording process and then inform the caller that you are recording the call.

Date and time of ICMs

You can check the date and time of your received messages by pressing the panel keys as shown below.

- ◆ The dates and times are also shown in the Message List, which can be printed out as described in Chapter 9.

1

FUNCTION



Press the keys shown at left. "T.A.D. SETTINGS" will appear in the display.

2



Press the keys shown at left. "ICM CONFIRMATION" will appear in the display.

3



Press the **START** key. The number of messages recorded will appear in the display.

4

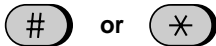

Press **#** or ***** one or more times to show the date and time of each of the messages.

- The message number will appear first, and then the date and time several seconds later.

5



Press the **STOP** key.

Note: The recorded dates and times are cleared each time you erase the messages.

REMOTE OPERATIONS

You can call the FO-1650/1850 from any touch-tone telephone and play back your messages using the remote commands. You can also use these commands to change the reception mode and other settings.

Remote code number

When you call the FO-1650/1850, you must enter the passcode for the box you want to listen to, or a remote code number if the box does not have a passcode. One remote code number can be programmed, and it is used to access all boxes which do not have passcodes. This prevents unauthorized people from listening to your messages. You can use any 3-digit number as the remote code number.

The remote code number has been set to "001" at the factory. If you want to change it, press the panel keys as shown below.

1

FUNCTION



Press the keys shown at left. "T.A.D. SETTINGS" will appear in the display.

2



Press the keys shown at left. "REMOTE CODE" will appear in the display.

3



(Example)

Enter a 3-digit number by pressing the number keys.

4

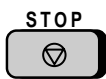

Press the **START** key and then the **STOP** key.

Toll Saver

When you call the FO-1650/1850 to listen to your messages, it will answer after two rings if it has received at least one message in any of the boxes, or after four rings if no messages are received.

This allows you to save money on telephone charges, particularly if you are calling long distance. If the machine does not answer after the second ring, you can simply hang up before it answers, saving yourself the cost of that call.

If you do not want to use the Toll Saver function, you can turn it off by following the steps below. In this case, the FO-1650/1850 will answer after the number of rings set with Option Setting 2 (see Chapter 8), the ring setting for FAX reception mode.

1

FUNCTION



Press the keys shown at left. "T.A.D. SETTINGS" will appear in the display.

2



Press the keys shown at left. "TOLL SAVER" will appear in the display.

3



(Example)

Press "1" to turn Toll Saver on, or "2" to turn it off.

4



Press the **STOP** key.

Retrieving your messages

Follow the steps below to listen to your messages from a remote location. Note that you can only access one box per call; if you want to access more than one box, you must make a separate call for each box.

Note: You can also access the FO-1650/1850 for remote operation when the reception mode is set to FAX. In this case, call the FO-1650/1850, press the "#" key immediately after it answers (before you hear the fax tone), and then continue from Step 2 below.

1



Call the FO-1650/1850 from a touch-tone telephone. When your outgoing message begins, press the "#" key on the telephone.

- You will hear a short beep, and the outgoing message will stop.

2



(Example)

Enter the number of the box you want to listen to. If you want to listen to the General Box, skip this step.

3



(Example)

Enter the box's passcode, or your remote code number if the box does not have a passcode. When finished, press "#" on the telephone.

- You will hear a series of beeps equal to the number of messages recorded in the box, or one long beep if four or more messages have been received. The machine will then play back the messages, beeping once at the end of each message. When all messages have been played back, you will hear a long beep.

- If no messages have been received in the box, you will hear a short beep. You can either hang up, or perform any of the operations described in the following section "Other remote operations".

4

While the messages are playing, you can do any of the following:

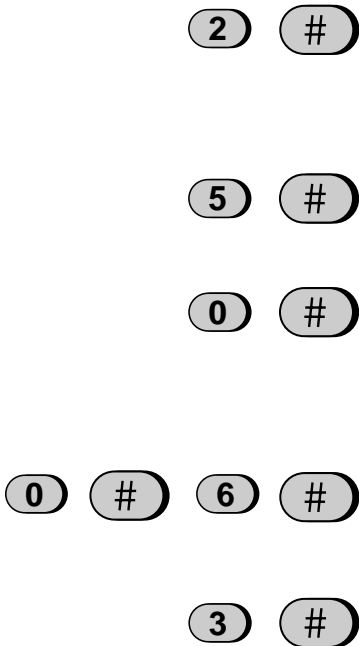

- **Repeat:** To listen to a message a second time, press "2" and "#" on the telephone before that message ends. To move back to the previous message, press "2" and "#" within the first 3 seconds of the current message.
- **Skip forward:** To skip forward to the next message, press "5" and "#" on the telephone.
- **Stop:** To stop playback, press "0" and "#" on the telephone. After this, you can enter any of the commands described in the following section, "Other remote operations".
- **Play new messages:** To listen to only your new messages, first stop playback by pressing "0" and "#", and then press "6" and "#".
- **Erase a message:** To erase the message you are currently listening to, press "3" and "#" before it ends.

5

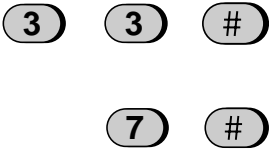

When you have finished listening to your messages, you can do any of the following:

- **Erase all messages:** To erase all of the messages in the box, press "3", "3", and "#".
- **Repeat playback:** To listen to your messages again, press "7" and "#".
- **Perform other operations:** You can enter any of the commands described in the following section, "Other remote operations".
- **Hang up:** If you do not erase your messages first, they will be saved and any new messages will be recorded after them. If you want the FO-1650/1850 to resume normal operation immediately, press "*" twice before hanging up (in some cases, particularly when the Transfer function is used, the FO-1650/1850 may not accept new calls for one or two minutes after you hang up unless you first press "*" twice).

Comments:

- *When a remote command is accepted by the machine, you will hear one beep. If an incorrect command is entered, you will hear four beeps. In the latter case, re-enter the correct command.*
- *When entering a command, do not pause longer than 10 seconds between each digit. If you do, a 4-beep error signal will be issued and the digits entered up to that point will be disregarded. In this case, re-enter the command from the beginning.*
- *If you make two errors (causing two 4-beep signals to be issued) while entering your remote code number, the line will be disconnected. This prevents unauthorized people from attempting to guess your remote code number.*
- *If you pause for longer than 60 seconds before entering a command, you will be disconnected.*

Other remote operations

After listening to your messages, you can do any of the operations described below by pressing the appropriate keys on the telephone.

Note: *The following commands cannot be entered while messages are being played back. If you do not want to wait until playback ends to enter a command, first stop playback by pressing "0" and "#", and then enter the command.*

Changing the fax reception mode



Select a new reception mode by pressing the keys as follows:

- **T.A.D.** mode: "8", "1", and "#".
- **FAX** mode: "8", "2", and "#".
- **TEL** mode: "8", "3", and "#".

Recording a new outgoing message

Note: *A new outgoing message can only be recorded for the box you selected at the beginning of the remote operation procedure.*

1



Press "4" and "*" on the telephone.

2

When you hear a short beep, speak into the telephone to record the new message.

- The message (including the general outgoing message) can be up to 15 seconds long. After 15 seconds (or earlier if the machine detects silence after you finish speaking), you will hear a beep, and the new message will be played back.

Turning the Transfer function on or off

(The Transfer function is described in the following section, "Other functions".)

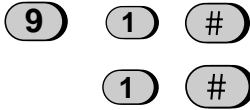

(Example)

To turn Transfer on: Press "9", "1", and "#", followed by the number of the box ("0" for the General Box) and "#".

To turn Transfer off: Press "9", "2", and "#" on the telephone.

Changing the transfer telephone number

1



Press "9", "0", and "#" on the telephone.

2



(Example)

After you hear a short beep, enter the new telephone number. When finished, press "#".

- To insert a pause between any two digits of the number, press "*".

Recording a new transfer message

1



Press "9", "3", and "#" on the telephone.

2

When you hear a short beep, speak into the telephone to record the new message.

- The time for the transfer message is fixed at 15 seconds. After 15 seconds (or earlier if the machine detects silence after you finish speaking), you will hear a beep, and the new message will be played back automatically.

Recording a "Memo"

You can leave a "memo" for yourself or other users of the machine. It will be recorded in the General Box, and played back when messages in that box are listened to.

1



Press "*" and "#" on the telephone.

2

When you hear a short beep, speak into the telephone to record the memo.

3



When you are finished, press "0" and "#".

- If the FO-1650/1850 detects a certain period of silence, it will stop recording automatically.

OTHER FUNCTIONS

Transfer function

The Transfer function is used to make the FO-1650/1850 automatically call you at a specified number every time it receives an incoming message in a selected box. This allows you to hear your messages immediately after they come in, even when you are at a remote location.

When you answer the telephone, you will hear your recorded message telling you that the call is a transfer call. Enter "#", the box number, the box's passcode (or your remote code number if the box has no passcode), and "#". The FO-1650/1850 will then play back your messages. You can also perform any of the remote operations described in the previous section.

Note: When you hang up after a transfer call, the FO-1650/1850 will not immediately resume normal operation. If you want the FO-1650/1850 to accept calls immediately after a transfer call, enter "*" twice before hanging up (if you want to hang up during message playback, first enter "0" and "#" to stop playback, then enter "*" twice).

Programming the transfer number

To use the Transfer function, you must first give the FO-1650/1850 the number to call (the transfer number). This is done by pressing the panel keys as follows:

1

FUNCTION



Press the keys shown at left. "T.A.D. SETTINGS" will appear in the display.

2



Press the keys shown at left. "TRANSFER # ENTRY" will appear in the display.

3

START



Press the **START** key.

4



(Example)

Enter a transfer number (max. of 32 digits including pauses) by pressing the number keys.

5

START



STOP



Press the **START** key and then the **STOP** key.

Note: If needed, you can change the transfer number from a remote location. See "Other remote operations" in the previous section, "Remote operations".

Recording the transfer message

The transfer message plays when you answer the telephone, and informs you that the call is a transfer call. It can be up to 15 seconds long. To record a transfer message, follow the steps described in "Recording an outgoing message" in "Answering Machine Set-up" in Chapter 2. The following is an example:

"Hello. This is a transfer call for (YOUR NAME). Enter your remote code number now."

Note: If needed, you can record the transfer message from a remote location. See "Other remote operations" in the previous section, "Remote operations".

Turning the Transfer function on and off

1

FUNCTION



Press the keys shown at left. "T.A.D. SETTINGS" will appear in the display.

2



Press the keys shown at left. "TRANSFER FUNC" will appear in the display.

3



or



Press "1" to turn the Transfer function on, or "2" to turn it off. (If you pressed "2", go to Step 5.)

4



(Example)

Enter the number of the box for which you want the Transfer function to operate (for the General Box, enter "0").

5

STOP



Press the **STOP** key.

Note: If needed, you can turn the Transfer function on or off from a remote location. See "Other remote operations" in the previous section, "Remote operations".

Override Ringing

This function allows selected callers using a touch-tone telephone to override the answering machine's outgoing message and cause the FO-1650/1850 to make a special ringing sound, alerting you that they are calling. This is useful when you are near the machine but only want to talk with certain callers, taking all other calls on the answering machine.

Programming the override code

To override the answering machine, your callers must enter a 3-digit override code from their telephone. This code has been set to "009" at the factory. If you want to change it, press the panel keys as shown below.

Important!

- Make sure the override code is different from the remote code or any passcodes programmed for boxes.

1

FUNCTION



Press the keys shown at left. "T.A.D. SETTINGS" will appear in the display.

2



Press the keys shown at left. "OVERRIDE CODE" will appear in the display.

3



(Example)

Enter a 3-digit code number by pressing the number keys.

4



Press the **START** key and then the **STOP** key.

Overriding the answering machine

Your callers should follow the steps below to override the answering machine.

1



Your caller calls the FO-1650/1850 from a touch-tone telephone. When the outgoing message begins, they should press the "#" key on their telephone.

- The caller will hear a short beep, and the outgoing message will stop.
-

2



(Example)

The caller should enter the override code and "#" by pressing the appropriate keys on their telephone.

- If an incorrect code is entered, the caller will hear four beeps. He or she must re-enter the correct code within 60 seconds or the line will be disconnected.
-

3

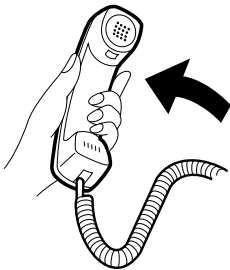

The FO-1650/1850 will make a special ringing sound. Pick up the handset to answer the call. (Note that an extension telephone connected to the same line will not ring.)

- If you do not answer within 30 seconds, the outgoing message will play again and the caller can then leave a message.
-

5 MAKING COPIES

Your fax can also be used to make copies. Single and multiple copies (up to 99 per original) can be made, enabling your fax to double as an office copier.

- ◆ The default resolution for copying is SUPER FINE.
- ◆ If you are making multiple copies of more than one original, you can choose whether to have the copies sorted (SORT COPY) or not sorted (MULTI COPY). The following example shows how the copies are ordered in each case when 3 copies each of 3 originals are made.

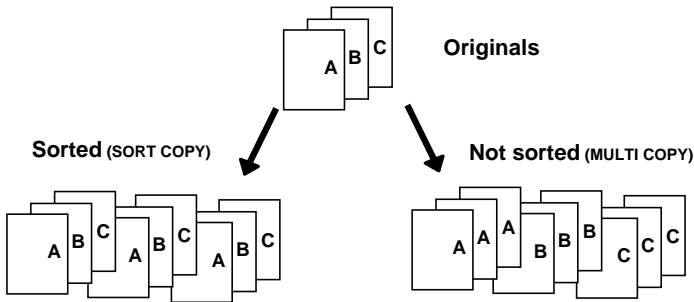

1

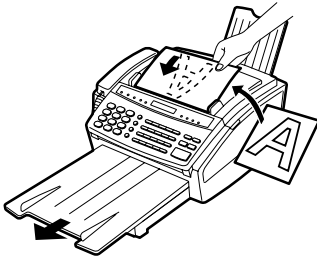

Load the document(s) face down.

- If desired, adjust the resolution and contrast with the **RESOLUTION** key.

2



Press the **COPY/HELP** key.

- If you are only making one copy of the original (or of each original) and don't want to make a reduction or enlargement setting, press the **START** key twice. Copying will begin. If you are only making one copy and want to make a reduction or enlargement setting, press the **START** key once and go to Step 5.

3

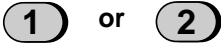

Press "1" (MULTI COPY) if you don't want the copies sorted, or "2" (SORT COPY) if you want them sorted.

4



(Example)

Enter the desired number of copies with the number keys.

- If the desired number of copies is from 1 to 9, enter "0" first.
- If you don't want to make a reduction or enlargement setting, press the **START** key. Copying will begin.

5



(Example)

Set the amount of reduction or enlargement by entering a number from "1" to "5" as shown below. Copying will begin.

- 1: AUTO (automatic size adjustment to match the size of the printing paper)
- 2: 50%
- 3: 100% (no reduction or enlargement)
- 4: 125%
- 5: 135%

Note: If you place a large number of originals in the feeder, the memory may become full before all of them can be scanned (MEMORY IS FULL will appear in the display). If this happens, press the **START** key to copy the originals which have been scanned, and then repeat the copy procedure for the remaining originals, including the original which was being scanned when the memory became full.

Copy Cut-off

When making a copy, your fax has been set at the factory to not print the remaining part of a document if the document is longer than the printing paper. If you want your fax to always print the remaining part of the document on a second page, follow the steps below.

1



Press the keys shown at left. "COPY CUT-OFF" will appear in the display.

2



or



Press "1" to turn copy cut-off on (the remaining part of the document will not be printed), or "2" to turn it off (the remaining part will be printed on a second page).

3



Press the **STOP** key.

Notes

6 MAKING TELEPHONE CALLS

Your fax can be used like a regular telephone to make and receive voice calls.

- ◆ To make or receive a phone call, the power must be on.

1

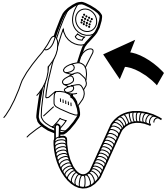

or



Pick up the handset or press the **SPEAKER** key. Listen for the dial tone.

2

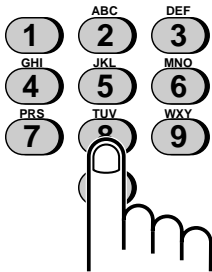

Dial the number using one of the following methods:

- **Normal Dialing:** Enter the full telephone number with the numeric keys.
- **Rapid Key Dialing:** Press the appropriate Rapid Key.
- **Speed Dialing:** Press the **SPEED DIAL** key, and enter the 2-digit Speed Dial number with the numeric keys.

3

Speak with the other party when they answer.

- If you pressed the **SPEAKER** key, pick up the handset.

Note: While the handset of the fax is lifted (off hook), an extension phone connected directly to the fax cannot be used to speak with the other party.

Using the HOLD/SEARCH key

You can use the **HOLD/SEARCH** key to search for a Rapid Key or Speed Dial number. First search for the number as described in "Using the **HOLD/SEARCH** key" in "Sending Documents" in this chapter, and then pick up the handset or press the **SPEAKER** key. The number will be dialed automatically after you do so (do not press the **START** key).

Redial

The last number called can be redialed by pressing the **REDIAL** key (it is not necessary to pick up the handset or press the **SPEAKER** key). When the other party answers, pick up the handset.

Hold

You can put the other party on hold during a conversation by pressing the **HOLD/SEARCH** key. When this is done, they cannot hear you. You can put the handset back in the cradle without breaking the connection. When you are ready to speak with them again, pick up the handset. If you did not put the handset back in the cradle, press the **HOLD/SEARCH** key one more time.

7 SPECIAL FUNCTIONS

CALLER ID

If you subscribe to a caller identification service from your telephone company, you can set your fax to display the name and number of the caller while the fax rings. The fax will also store information about unanswered calls which you can view in the display or print out as a list. This allows you to screen your calls as they come in, and makes it easy to respond to callers who do not leave messages.

To use the Caller ID function, set Option Setting 13 to YES and enter your area code as described in Chapter 8, "Optional Settings".

Important:

- *To use this function, you must subscribe to a caller identification service from your telephone company.*
- *The FO-1650/1850 may not be compatible with some caller identification services.*

How Caller ID operates

When you receive a call, the name and phone number of the caller will alternately appear in the display, beginning just before the second ring. The information will continue to be displayed until you pick up the handset, or until the fax answers automatically if it is in TAD or FAX mode.

Note: *Some caller ID services may not provide the name of the caller. In this case, only the phone number will appear.*

Display messages

One of the following messages will appear while the fax rings if caller information is not available.

NO SERVICE	No caller information was received from your telephone company. Make sure that the telephone company has activated your service.
CALLER-ID ERROR	Noise on the telephone line prevented reception of caller information.
OUT OF AREA	The call was made from an area which does not have a caller identification service, or the caller's service is not compatible with that of your local phone company.
PRIVATE CALL	Caller information was not provided by the telephone company at the caller's request.

Viewing the caller list

If you subscribe to a caller ID service and have set Option Setting 13 to YES, your fax will keep information on the most recent 20 unanswered calls you have received. (Note that if the caller sends a fax or leaves a voice message, information on that call will not be stored.) You can view this information, which consists of the name and number of each caller, in the Caller ID List.

- ◆ After you have received 20 unanswered calls, each new call will delete the oldest call.

Follow the steps below to view the Caller ID List in the display. If desired, you can immediately dial a number when it appears.

To print out the list, see Chapter 9, "Printing Out Reports and List".

1

HOLD/SEARCH



2

Press the keys shown at left. "REVIEWING CALLS" will appear in the display.

2



or



Press the "#" to scroll through the list from the most recent call, or the "*" key to scroll through the list from the oldest call.

3

START



If you want to dial one of the numbers in the list, scroll through the list until the number appears in the display.

- If you want to send a fax, first load the document and then press the **START** key.
- If you want to make a voice call, pick up the handset or press the **SPEAKER** key. Dialing will begin automatically. (If you pressed the **SPEAKER** key, pick up the handset when the other party answers.)

4

STOP



Press the **STOP** key when you have finished viewing the list.

To delete calls from the caller list

If you want to delete a single call from the caller list, press the "0" key while the call appears in the display. If you want to delete all calls from the list, hold the "0" key down for at least 3 seconds while you are viewing any number in the list.

Priority Call

If desired, you can set your fax to make a special ringing sound when you receive a call from a designated phone number. This lets you know immediately who is calling without having to look at the display. To use this function, enter the desired phone number by following the steps below (only one phone number can be entered).

Note: This function cannot be used if you are using Distinctive Ringing.

1

FUNCTION



3



Press the keys shown at left. "PRIORITY CALL #" will appear in the display.

2

1

or

2

Press "1" to enter a number, or "2" to clear a number. (If you pressed "2", go to Step 4.)

3

5 5 5 1 2 3 4 5 5 5

Enter the phone number, including the area code, by pressing the number keys (the number must be 10 digits long).

(Example)

4

START



STOP





















Press the **START** key and then the **STOP** key.

Direct Call

If desired, you can allow a designated phone number to access a personal box directly when the answering machine is activated. In this case, when the caller calls, he or she will immediately hear the outgoing message of the personal box instead of that of the general box. You can designate one phone number for each personal box.

Note: This function cannot be used if you are using Distinctive Ringing.

-
- 1** FUNCTION    Press the keys shown at left. "DIRECT CALL #" will appear in the display.
-
- 2**  or  Press "1" to enter a number, or "2" to clear a number. (If you pressed "2", go to Step 5.)
-
- 3**  (Example) Enter the number of the personal box to be accessed directly.
-
- 4**           Enter the phone number, including the area code, by pressing the number keys (the number must be 10 digits long).
(Example)
-
- 5**   Press the **START** key and then the **STOP** key.

Preventing voice calls

With Caller ID turned on, you can use the Anti Junk Fax function described in the following section to prevent voice calls as well as fax receptions (the Anti Junk Fax function can normally only prevent faxes).

In this case, when a voice call or a fax transmission comes in from a number you have specified as a "Junk Number", your fax will break the connection as soon as it receives the calling phone number from the caller ID service (before the second ring).

To use this function, set Option Setting 11 to YES as described in Chapter 8, "Optional Settings", and then enter the number in the Anti Junk Number List as described in "Anti Junk Fax" in the following section of this chapter.

Note: This function cannot be used if you are using Distinctive Ringing.

ANTI JUNK FAX

The Anti Junk Fax function allows you to block reception of faxes from parties which you specify. This saves paper by not printing out unwanted "junk" faxes.

To use this function, first turn it on by setting Option Setting 11 to YES as described in Chapter 8, and then enter the fax numbers from which you do not want to receive faxes as shown below. If you are using the Caller ID function as described in the previous section, you can also enter voice numbers.

Comments:

- Up to 5 numbers can be entered in the Anti Junk Number List.
- The Anti Junk function will not operate for a number which has also been stored as a Priority Call or Direct Call number.
- To clear a number from the Anti Junk Number List, you need to know the 1-digit number which identifies it. If you have forgotten this number, print out the Anti Junk Number List as described in Chapter 7.
- **FO-1850 only:** When you have selected fax reception by your computer, Anti Junk Fax will not operate unless you are using Caller ID.

1

FUNCTION



3



Press the keys shown at left. "STORE JUNK FAX #" will appear in the display.

2

1

or

2

Press "1" to store a number in the Anti Junk Number List, or "2" to clear a number from the list.

3

1

(Example)

Storing: Enter a 1-digit number from "1" to "5". This number identifies the fax/voice number you will store in the next step.

Clearing: Enter the number which identifies the fax/voice number you want to clear, and go to Step 5.

4

5

5

5

1

2

3

4

(Example)

Enter the fax/voice number (max. of 20 digits).

5



Press the **START** key.

6

Step 3 or



Return to Step 3 to enter (or clear) another number, or press **STOP** to exit.

MEMORY

Your fax has a memory which can be used to temporarily store both incoming and outgoing documents.

- ◆ When no voice messages (including outgoing messages) have been recorded, approximately 34 pages of average content can be held in memory if they are all going to be transmitted (24 pages if Option Setting 16 is set to YES), or 31 pages if they are all received (29 pages if Option Setting 16 is set to YES). Less pages can be held if any were scanned using fine or halftone resolution.

Sending documents from memory

With this function, the original document is scanned immediately, stored in memory, and then transmitted once the connection to the receiving machine is made. This is convenient when transmitting to places where the line is often busy, as it saves you from waiting to pick up the original document and frees the feeder for other operations. After transmission, the document will be cleared from memory.

- ◆ Only one memory transmission can be set at a time.
- ◆ The amount of memory currently occupied appears as a percentage in the display while the document is being scanned.

1

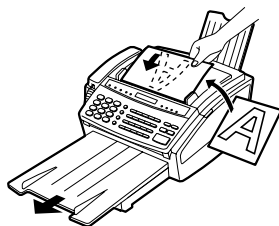

Load the document(s).

- Set the resolution and/or contrast if desired.

2

MEMORY



1



Press the **MEMORY** key and then "1".

3



(Example)

Enter the number of the receiving machine using one of the following methods:

- Press a Rapid Key.
- Press the **SPEED DIAL** key and enter a Speed Dial number.
- Enter a full telephone number by pressing the number keys.

4

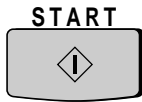

Press the **START** key if you entered a Speed Dial number or a full number.

- The document will be scanned and stored in memory. Your fax will then dial the receiving machine and transmit the document (redialling will be done automatically if necessary).

If the memory becomes full...

If the memory becomes full while the document is being scanned, MEMORY IS FULL will appear in the display.

- ◆ Press the **START** key if you want to transmit the pages which have been stored up to that point in memory. The remaining pages will be ejected from the feeder. After transmission, the memory will be cleared and you can transmit the remaining pages. You will also need to transmit the page which was being scanned when the memory filled up.
- ◆ Press the **STOP** key if you want to cancel the entire transmission.

Substitute reception into memory

This is a back-up function which is automatically activated if your fax runs out of paper, the printing ribbon needs replacement, or the paper jams.

When you have received a document in memory, FAX RX IN MEMORY will appear in the display, alternating with OUT OF PAPER, FILM END, or PAPER JAM. When you add paper, replace the imaging film, or clear the jam, the stored documents will automatically print out.

- ◆ If you received documents in memory because the fax ran out of paper, be sure to add paper which is the same size as the paper previously used. If not, the document print-out size may not match the size of the printing paper.

BROADCASTING

This function allows you to send the same document to as many as 20 different locations with just one operation. First store the document in memory, then enter the numbers of the receiving machines. The document will be transmitted to each location.

- ◆ You can only use Rapid Keys or Speed Dial numbers to dial the numbers of the receiving machines.

1

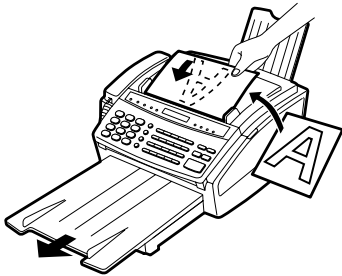

Load the document(s).

2

MEMORY



2

Press the **MEMORY** key and then "2".

3

2

2



(Example)

Dial the receiving machines (maximum of 20) using one or both of the following methods:

- Enter one or more Speed Dial numbers by pressing the number keys.
- Press one or more Rapid Keys.

4

START



Press the **START** key.

- Set the resolution and/or contrast if desired.

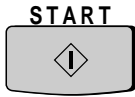
5

Press the **START** key. Transmission will begin.

- A Transaction Report is automatically printed out after Broadcasting is completed. Check the "Note" column of the report to see if any of the locations are marked "Busy" or have a communication error code. If so, send the document to those locations again.

Broadcasting using a Group Key

If the fax machines to which you want to broadcast have all been programmed into one Group Key, you can perform the broadcasting operation using the following simplified procedure:

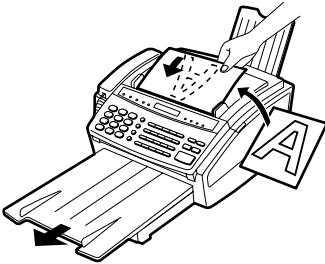
1

Load the document(s).

- Make any desired transmission settings (resolution, contrast, etc.).

2

Press the appropriate Group Key. Transmission will begin.

(Example)

POLLING

Polling allows you to request another fax machine to send a document to your fax machine. In other words, the receiving fax machine, not the transmitting fax machine, initiates the transmission. You can use your fax to both poll and be polled by others.

Setting the polling key

To use the polling function, you must first reset Rapid Key 20/POLL for use as a polling key. This is done by resetting Option Setting 12, as described in Chapter 8, "Optional Settings".

Polling others

1

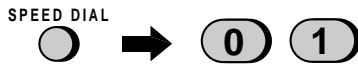

(Example)

Dial the fax machine you want to poll using one of the following methods:

- Pick up the handset (or press the **SPEAKER** key) and dial the full number. Wait for the fax answerback tone.
- Press the **SPEED** key and enter a 2-digit Speed Dial number.
- Enter the full number using the numeric keys.

2

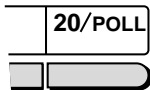

Press Rapid Key 20/POLL.

- If you used the handset, replace it when POLLING appears in the display. Reception will begin.

Note for FO-1850 only: Polled documents will be received by the FO-1850 regardless of the RECEIVE UNIT setting.

Being polled (Polling Standby)

To let another fax machine poll your fax, simply set the reception mode to FAX, and load the document(s) to be sent.





Transmission will take place when the other fax machine calls your fax and activates polling. Automatic reception is possible while your fax is on polling standby.

Note for FO-1850 only: This function will not operate if you have set RECEIVE UNIT to your PC as described in "Reception Mode" in Chapter 2.

Polling Security

Polling Security allows you to prevent unauthorized polling of your fax. When this function is turned on, polling will only take place when the fax number of the polling fax machine has been entered in your fax's list of permitted fax numbers (called "passcode numbers"). The number of the polling fax must also be programmed in itself for identification.

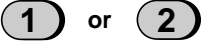
Turning Polling Security on and off

-
- | | | |
|----------|---|--|
| 1 |  | Press the keys shown at left. "ENTRY MODE" will appear in the display. |
|----------|---|--|
-
- | | | |
|----------|--|--|
| 2 |  | Press the "#" key 3 times. "SECURITY SELECT" will appear in the display. |
|----------|--|--|
-
- | | | |
|----------|---|---|
| 3 |  | Press "1" to turn polling security on, or "2" to turn it off. |
|----------|---|---|
-
- | | | |
|----------|---|--|
| 4 |  | Press the START key and then the STOP key. |
|----------|---|--|

Storing and clearing fax numbers for polling permission

You can store up to 10 fax numbers in your fax's list of permitted numbers.

1



Press the keys shown at left. "ENTRY MODE" will appear in the display.

2



Press the "*" key 4 times. "PASSCODE # MODE" will appear in the display.

3

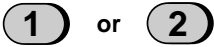

Press "1" to store a number, or "2" to clear a number.

4



(Example)

Storing: Enter a 2-digit number from "01" to "10". This number identifies the fax number you will store in the next step.

Clearing: Enter the number which identifies the fax number you want to clear, and go to Step 6.

5



(Example)

Enter the fax number (max. of 20 digits).

6



Press the **START** key.

7

Step 4 or



Return to Step 4 to enter (or clear) another number, or press **STOP** to exit.

TIMER OPERATIONS

The Timer function allows you to set a transmission and/or polling operation to be performed automatically at a time you specify. One transmission operation and one polling operation can be set at any one time, and the times they will be performed can be specified up to 24 hours in advance.

You can use this function, for example, to take advantage of lower nighttime telephone rates without having to be there when the operation is performed.

Note: Only a Speed Dial number can be used to dial the receiving machine.

Setting a timer operation

1

FUNCTION



Press the keys shown at left. "TIMER MODE" will appear in the display.

2



or



Press "#" to set a transmission operation (SEND MODE), or "*" to set a polling operation (POLLING MODE).

3



Press "1" to select SET.

4



(Example: 9:25)

Enter the time at which you want the operation to take place (2 digits for the hour and 2 digits for the minute).

5



or



Press "*" to select A.M., or "#" to select P.M.

6



Press the **START** key.

TIMER OPERATIONS

7



(Example)

Enter the Speed Dial number of the receiving fax machine.

8



Press the **START** key.

9



If this is a transmission operation, you can adjust the resolution and/or contrast (skip this step if you don't want to).

10



Press the **START** key and then the **STOP** key. If this is a transmission operation, load the document in the feeder sometime before the specified time of transmission.

To cancel an operation

If you need to cancel an operation after it has been set, follow the steps below.

1



Press the keys shown at left. "TIMER MODE" will appear in the display.

2

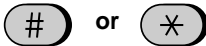

Press "**#**" to cancel a transmission operation, or "*****" to cancel a polling operation.

3



Press "**2**" to select CLEAR.

4



Press the **START** key and then the **STOP** key.



ENTERING AND USING PROGRAMS

If you frequently perform the same operation involving the same party, you can program all the steps of the operation into one Program Key. This allows you to perform the operation by simply pressing that key.



- ◆ Rapid Keys 16/P1 and 17/P2 can be used as Program Keys. However, a key cannot be used if it is already being used for Rapid Key Dialing.
- ◆ Only Speed Dial numbers can be used to enter fax numbers of receiving machines in the Program Keys. Full numbers cannot be entered.
- ◆ If the program is for a regular transmission or polling operation, a timer setting can be included to have the operation performed automatically at a selected time.
- ◆ To clear a mistake, press the **STOP** key.





Initial procedure

To program an operation, first perform the following procedure. After you have completed it, go to the procedure for the specific operation you want to program.

1    Press the keys shown at left. "PRG. ENTRY MODE" will appear in the display.

2  Press "1" to select SET.

3  or  Press a Program Key ("16/P1" or "17/P2") to select it.

4    ...  Enter a name for the program (max. of 20 characters). (See "Entering Letters for Names" in Chapter 2).
Skip this step if you don't want to enter a name.

5



Press the **START** key.

6

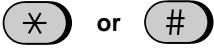

Press the **"#"** key or the **"*"** until the desired operation appears in the display. The operations will appear in the following order:

- Transmission ("SEND")
- Polling
- Broadcasting

7



Press the **START** key and then continue with the specific procedure for your operation (see the following pages).

Transmission

(Continued from "Initial procedure".)

8

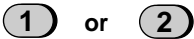

Press **"1"** if you want the document to be scanned into memory and then transmitted, or **"2"** if you want the document to be transmitted directly from the feeder. (Note: If you select **"2"**, you can include a timer setting in the program.)

- If you pressed **"1"**, go to Step 12. If you pressed **"2"** and don't want to make a timer setting, go to Step 11.

9



(Example: 9:25)

Enter the time at which you want the operation to take place (2 digits for the hour and 2 digits for the minute).

10

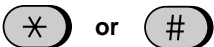

Press **"*"** to select A.M., or **"#"** to select P.M.

11



Press the **START** key.

12



(Example)

Enter the Speed Dial number of the receiving fax machine.

13



Press the **START** key.

14



If desired, set the resolution and/or contrast by pressing the **RESOLUTION** key (otherwise, skip this step).

15



Press the **START** key and then the **STOP** key.

Polling

(Continued from "Initial procedure".)

8



(Example: 9:25)

Enter the time at which you want the operation to take place (2 digits for the hour and 2 digits for the minute).
If you don't want to make a timer setting, go to Step 10.

9

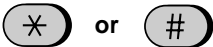

Press ***** to select A.M., or **#** to select P.M.

10



Press the **START** key.

11



(Example)

Enter the Speed Dial number of the receiving fax machine.

12



Press the **START** key and then the **STOP** key.

Broadcasting

(Continued from "Initial procedure".)

8

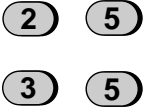

(Example)

Enter the Speed Dial numbers of the receiving machines.

9



Press the **START** key.

10



If desired, set the resolution and/or contrast by pressing the **RESOLUTION** key (otherwise, skip this step).

11



Press the **START** key and then the **STOP** key.

Clearing a Program Key

To clear a Program key, follow these steps:

1



Press the keys shown at left. "PRG. ENTRY MODE" will appear in the display.

2



Press "2" to select CLEAR.

3

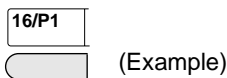

Press the Program Key you want to clear.

4



Press the **START** key and then the **STOP** key.

Using a Program Key

A programmed operation is performed as follows:

1

Load the document.

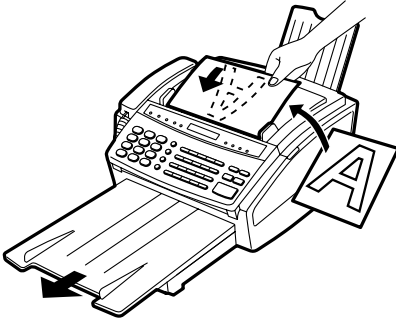

2



(Example)

Press the appropriate Program Key.

Note: A maximum of 2 timer operations can be set at any one time, including both timer operations set by pressing a Program Key and operations set as described in "Timer Operations" in this chapter.

To cancel a programmed timer operation

If a Program Key has been pressed for a timer operation and you need to cancel the operation before it is performed, follow these steps:

1



(Example)

Press the Program Key.

2



Press the **START** key.

REMINDER FUNCTION

The Reminder function allows you to send either a voice message, fax message, or both to another person or yourself at a preset time. If the reminder is for another person, your fax will call the other machine and transmit the message when the selected time arrives. If the reminder is for you, your fax will prompt you to press the **REMINDER** key to play and/or print out the message.

- ◆ Only one reminder (voice message, fax, or both) can be set at one time.
- ◆ The reminder can be set up to one year in advance.

Setting a reminder

1

REMINDER



Press the **REMINDER** key.

2



(Example: May 15th)

Enter two digits for the month ("01" to "12") and two digits for the day ("01" to "31").

3



(Example: 9:25)

Enter two digits for the hour ("01" to "12"), and two digits for the minute ("00" to "59").

4

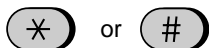

Press ***** to select A.M., or **#** to select P.M.

5



Press the **START** key.

6



(Example)

If the reminder is for another person, enter his or her telephone or fax number (max. 32 digits). (Skip this step if the reminder is for you.)

7



Press the **START** key.

8

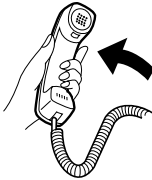

To record a voice message, pick up the handset and speak into it. When finished, replace the handset or press the **STOP** key. (Skip this step if you only want to send a fax message.)

9

REMINDER



or

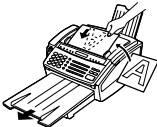

If you are only sending a voice message, press the **REMINDER** key.

If you are sending a fax message, press the **START** key, load the document, set the resolution if desired, and then press the **START** key again.

- The document will be scanned and stored in memory.

When the selected time arrives

If the reminder is for you, the fax will beep repeatedly for 60 seconds when the selected time arrives and "PRESS REMINDER" will appear in the display. Press the **REMINDER** key to play the voice message and/or print out the fax message.

If the reminder is for another person, your fax will call his or her number and then play the voice message and/or transmit the fax message. If the line is busy or no one answers, 2 redialing attempts will be made at intervals of 5 minutes.

Note: *It will not be possible for a voice message to be recorded in an answering machine.*

To check or cancel a reminder message

To check a reminder message before it is sent, press the **REMINDER** key and then press "1". The set date and time will appear, followed by the telephone or fax number of the receiving party if the reminder is for another person. Press the **START** key to play the recorded message and/or print the document.

To cancel a reminder message, press the **REMINDER** key and then press "2".

PC LINK FUNCTION

Note: This section applies only to the FO-1650.

If you have a personal computer with a fax modem and fax software, you can connect the computer to your fax with a regular telephone cord and set your fax to PC Mode (PC mode is a special mode for operation with a computer). This will allow you to use the fax as a simple scanner and printer. It is also the most convenient setup if you want to use a computer for fax operations on the same phone line as your fax machine.

Important:

To use your fax as a scanner, your fax software must have a manual reception function.

Connecting your fax to your computer

Plug one end of the telephone cord into your computer modem's **telephone line** jack (**not** the jack for an extension phone if it has one), and plug the other end into the **TEL. SET** jack on your fax (not the **TEL. LINE** jack). If necessary, first remove the seal covering the **TEL. SET** jack.

If your computer fax modem has an extension phone jack, you can connect an extension phone to it.

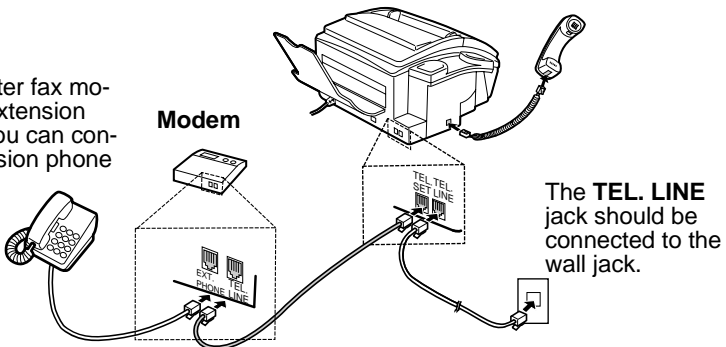

The **TEL. LINE** jack should be connected to the wall jack.

Setting your fax to PC MODE

To use your fax as a printer or scanner, you must set it to PC MODE. We also recommend that you keep the fax machine set to PC MODE if you will be performing fax operations with your computer.

- ◆ To use PC MODE, your computer modem must be connected to your fax as shown above.

1

FUNCTION



To set the fax to PC Mode, press the **FUNCTION** key and then the **"#"** key.

- "PC" will appear next to the time in the display.

2

FUNCTION



To turn PC Mode off, press the **FUNCTION** key and then the **"#"** key once again.

- The reception mode ("FAX", "TEL", or "TAD") will appear next to the time in the display.

Note: If you will be performing fax operations with your computer but do not set the fax machine to PC MODE, you must set Option Setting 10 to "NO" (see Chapter 8, "Optional Settings").

Receiving documents in PC Mode

The current reception mode setting (FAX, TEL, or TAD) is effective while you are in PC Mode. If you need to change the reception mode, press the **RECEPTION MODE** key once to make the current reception mode appear in the display, and then press it again to change the setting.

Important: If you answer a call by picking up the fax's handset when the fax is in PC Mode, the fax will not begin reception automatically when you hear a fax tone. To receive a fax, you must press the **START** key. If you answer a call by picking up a touch-tone extension phone connected to the same line, begin fax reception by pressing "5", "✳", and "✳" (or the current setting of Option Setting 5).

If you want to receive incoming faxes in your computer, set the reception mode of your fax to TEL so that it will not answer. Or, set the reception mode to FAX and set Option Setting 2 (Number of Rings to Answer) to a number greater than the number of rings on which your computer answers. In this case, your computer will normally answer first, but your fax will still answer if your computer is turned off or fails to answer for some reason.

Using your fax as a scanner

To scan a document into your computer from your fax, follow the steps below. The document will be received by your computer as if it had received a fax, and after that you can use your fax software to process it as desired.

1

FUNCTION



Make sure the fax is set to PC Mode (press the **FUNCTION** key and then the **"#"** key). "PC" will appear next to the time in the display.

2

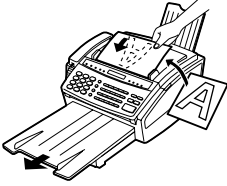

Load the document.

- If desired, press the **RESOLUTION** key to make a resolution and/or contrast setting.

3



Press the **START** key.

4

Start your fax software on your computer (if it is not already running) and select manual reception. The document will be scanned and sent to your computer.

Using your fax as a printer

To have your fax print out a document which you have prepared with your fax software, follow the steps below.

1

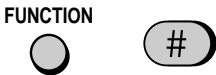

Make sure the fax is set to PC Mode (press the **FUNCTION** key and then the **#** key). "PC" will appear next to the time in the display.

2

Send the document by manual transmission with your fax software on your computer. If your software does not have a manual transmission function, enter any number in your software's auto-dial phonebook that is not a real phone number (such as **##** or **6#**), and then dial that number .

3



Wait until "LINE IS IN USE" appears in your fax's display, and then press the **START** key. Your fax will print out the document.

8 OPTIONAL SETTINGS

A variety of optional settings are available which you can use to fine-tune your fax to better suit your needs. The settings are made by pressing the panel keys, and each setting is described in the list below.

Accessing the settings

1

FUNCTION



Press the keys shown at left. "OPTION SETTING" will appear in the display.

2



or



Move through the list of settings by pressing "#" to move forward, or "*" to move backward. The settings will appear in the order listed below.

3



(Example)

When the desired setting appears in the display, change it appropriately as described below.

4



Press the **STOP** key.

Settings

Setting 1: FINE RESOLUTION PRIORITY

This sets the default resolution (the resolution used if a setting is not made with the **RESOLUTION** key) for transmitting documents. Press "1" (YES) to set it to FINE, or "2" (NO) to set it to STANDARD.

- Factory setting: "2"

Setting 2: NUMBER OF RINGS TO ANSWER

This sets the number of rings the fax machine waits before answering an incoming call in FAX reception mode. Enter any number from "1" to "5".

- Factory setting: "4"

Setting 3: RECALL INTERVAL

This sets the amount of time your fax will wait between automatic redials when the line is busy. Enter "01" for 1 minute, "02" for 2 minutes, etc., up to a maximum of 15 minutes.

- Factory setting: "05"

Setting 4: RECALL TIMES

This sets the maximum number of times your fax will automatically redial if the line is busy. Enter any number from "00" to "15".

- Factory setting: "02"

Setting 5: TEL/FAX REMOTE NUMBER

This sets the 1-digit number for activating fax reception from an extension telephone. Enter any number from "0" to "9".

- Factory setting: "5"

Setting 6: REMOTE RECEPTION SELECT

This turns detection of the code for activating fax reception from an extension phone on or off. Press "1" to turn detection on, or "2" to turn detection off.

- Factory setting: "1"

Setting 7: TRANSACTION REPORT PRINT SELECT

This sets the condition for printing out Transaction Reports. Enter a number from "1" to "5" as follows:

"1" (ALWAYS PRINT): Print out after each transmission, reception, or error.

"2" (ERR/TMR/MEM PRINT): Print out after an error, timer operation, or memory operation.

"3" (SEND ONLY): Print out only after a transmission.

"4" (NEVER PRINT): Never print out.

"5" (ERROR ONLY): Print out only after an error occurs.

- Factory setting: "5"

Setting 8: DIAL MODE

This sets the mode of dialing. Press "1" if you are on a touch-tone line, or "2" if you are on a pulse dial line. (If you don't know which type of line you have, try making phone calls with both settings and see which one works.)

- Factory setting: "1"

Setting 9: DISTINCTIVE RINGING

This sets the ring pattern to which your fax will answer if you subscribe to a distinctive ringing service. Enter a number from "1" to "5" to select a pattern. See "Distinctive Ringing" in Chapter 2 for more details.

- Factory setting: "5"

Setting 10: FAX SIGNAL RECEIVE

Your fax is set to automatically begin reception if you hear a high-pitched fax tone after answering a call on your fax or an extension phone. If you use a computer fax modem to send documents on the same line, you must turn this setting off in order to prevent your fax from mistakenly attempting to receive documents from the computer fax modem. Press "1" to turn the setting on, or "2" to turn it off.

- Factory setting: "1"

Setting 11: JUNK NUMBER CHECK

Press "1" to prevent reception from fax numbers (and voice numbers if you are using Caller ID) entered in the Anti Junk Number List. Press "2" to allow reception from all numbers.

- Factory setting: "2"

Setting 12: POLLING

Press "1" if you want to use Rapid Key 20 as a polling key. Press "2" if you want to use it as a regular Rapid Key.

- Factory setting: "2"

Setting 13: CALLER ID

If you subscribe to a caller ID service and want to use the Caller ID function, press "1", enter your area code by pressing the number keys, and then press the **START** key. To turn Caller ID off, press "2".

- Factory setting: "2"

Setting 14: AUTO COVER SHEET

Press "1" (YES) to have the fax automatically generate a cover sheet and send it as the last page of each transmission. Press "2" (NO) to turn the function off.

- Factory setting: "2"

Setting 15: ACTIVITY REPORT AUTO PRINT OUT

Press "1" to have your fax automatically print out an Activity Report once every 30 operations. (The list can still be printed out manually when desired.) Press "2" to turn automatic print-out off.

- Factory setting: "2"

Setting 16: ERROR CORRECTION MODE (ECM)

Press "1" (YES) to have any distortions in a transmission due to noise on the telephone line be corrected before print-out at the receiving end. This is only effective when the other machine has ECM as well. Press "2" (NO) to turn the function off.

- Factory setting: "1"

9 PRINTING OUT REPORTS AND LISTS

You can print out a variety of lists showing settings and information entered in the fax. You can also have the fax automatically print out a report on transactions after they are made. Each list and the report is described below.

Printing out a list

1

FUNCTION



2

Press the keys shown at left. "LISTING MODE" will appear in the display.

2



or



Press the "#" key or the "*" key until the desired list appears in the display.

3

START



Press the **START** key.

Activity Report

This report shows information on up to 30 of the operations most recently performed. The report is divided into two parts: the TRANSMISSIONS ACTIVITY REPORT, which shows information on transmissions, and the RECEPTIONS ACTIVITY REPORT, which shows information on receptions.

- ◆ If Option Setting 15 is set to "1", a report will be automatically printed out whenever information on 30 operations has accumulated. (A report can still be printed out manually at any time.)
- ◆ All information is erased after a report is printed out. If automatic print-out is turned off and print-out has not been done manually for 30 operations, the information on the oldest operation will be overwritten each time a new operation is performed.

```
*****
*                                     TRANSMISSIONS ACTIVITY REPORT
*                                     MAY-24-96 02:59 PM
*
*      FROM: John Doe Corp      201 555 1234
*-----
* NO. DATE   START   RECEIVER      TX TIME  PAGES  TYPE   NOTE
*-----
* 1  MAY-24 02:36 PM  WHITE TEC    1'11"    2  SEND  OK
* 2  MAY-24 02:38 PM  ABC CORP.    49"     1  SEND  OK
* 3  MAY-24 02:43 PM  JOHN SMITH  1'54"    3  SEND  OK
* 4  MAY-24 02:45 PM  TOM         48"     1  SEND  OK
* 5  MAY-24 02:46 PM  SHARP CORP. 49"     1  SEND  OK
*-----
*                                     TOTAL      5'51"    8
*                                     GRAND TOTAL TIME: 13M 29S
*                                     PAGES:      19
*-----
*****
```

Explanation of headings

SENDER/RECEIVER The fax number of the other machine involved in the transaction. If this machine does not have an ID function, the communication mode will appear (for example, "G3").

PAGES Number of pages transmitted or received.

NOTE **OK** - Transmission/reception was normal.

P.FAIL - A power failure occurred.

JAM - A problem with the fax paper or document occurred.

NO PAPER - You ran out of fax paper during reception.

CANCEL - Transmission was cancelled because the **STOP** key was pressed, no document was in the feeder, or the other machine requested transmission using a function which your fax does not have.

COM.E-0 to COM.E-7 - A telephone line error prevented the transaction. Explanations of the error numbers are given in the following tables, however, these are primarily for use by service engineers. In general, you will want to simply try the transaction again. If necessary, check with the other party to make sure their machine is functioning properly.

Transmission errors

E-0	Able to recognize handshake signal, but it has errors.
E-1	Cannot recognize the handshake signal from the receiver side.
E-2	Line disconnected during transmission.
E-3	Line disconnected after modem speed fall-back.
E-4	Line disconnected during multi-page transmission.
E-6	Cannot recognize the handshake signal for next page at receiver side.
E-7	No response from receiver side or "disconnect signal" is received at transmitter side.
E-8	Error was not corrected after the predetermined number of retries because of an error in a part of a page.
E-11	Error occurred after or while reception by the remote (receiving) machine was revealed to be impossible.
E-12	Error occurred just after fall-back.
E-13	Error occurred after a response to a retransmission end command was received.

Reception errors

E-0	Able to recognize handshake signal, but it has errors.
E-1	Line disconnected during reception.
E-2	Cannot recognize the handshake signal from the transmitter side.
E-3	Cannot recognize the last handshake signal from the transmitter side.
E-4	Cannot recognize the handshake signal for next page from the transmitter side in the case of mode change.
E-5	Cannot recognize the handshake signal for next page from transmitter side.
E-7	No response from transmitter or "disconnect signal" is received at receiver side.
E-8	Error occurred upon completion of reception of all pages.
E-9	Error occurred when mode was changed or transmission/reception switching was performed.
E-10	Error occurred during partial page or physical page reception.
E-11	Error occurred after or during inquiry from the remote (transmitting) machine as to whether reception was possible or not.
E-12	Error occurred during or just after fallback.
E-13	Error occurred after retransmission end command was received.
E-14	Error occurred after voice communication command was received.

Timer list

This list shows the timer operations which are currently set.

TIMER LIST		MAY-17-96 03:26 PM
FOR: John Doe Corp.		201 555 1234
<hr/>		
TIMER SEND		
START	05:00 PM	
RECEIVER	N.Y. SALES	
RESOLUTION	STANDARD	:AUTO
TIMER POLLING		
START	10:00 AM	
SENDER	JACK SMITH	
<hr/>		

Telephone Number List

This list shows the fax and voice numbers which have been stored for automatic dialing.

TELEPHONE NUMBER LIST		
FOR: John Doe Corp.		MAY-17-96 03:26 PM 201 555 1234
SPEED #	NAME	TELEPHONE #
01	N.Y. SALES	452-254-1546
02	JACK SMITH	125-563-8462
05		25555
16		M0
17		M0
18		GROUP #1 STORED

Passcode List

This list shows settings made for polling security, your name and fax/telephone number as entered in the machine, and a sample of the header printed at the top of every page you transmit (**HEADER PRINT**).

PASSCODE LIST		
FOR: John Doe Corp.		MAY-17-96 03:27 PM 201 555 1234
POLLING MODE	SECURITY OFF	
PASSCODE #	01	
	02	
	03	
	04	
	05	
	06	
	07	
	08	
	09	
	10	
PRIORITY CALL #		
SENDER'S NAME		
	John Doe Corp.	
SENDER'S TELEPHONE NUMBER		
	201 555 1234	
HEADER PRINT		
MAY-17-96 03:27 PM	John Doe Corp.	201 555 1234 P.01

Options Setting List

This list shows the current status of the optional settings. The bottom part of the list shows the status of the settings made for answering machine connection.

OPTIONS SETTING LIST		
FOR: John Doe Corp.		MAY-17-96 03:32 PM
		201 555 1234
NO.	ITEM	SETTING
1	FINE PRIORITY	NO
2	NUMBER OF RINGS IN AUTO ANSWER MODE	4 RINGS
3	RECALL INTERVAL	05 MINUTES
4	RECALL TIMES	02 TIMES
5	TEL/FAX REMOTE #	<5>**
6	REMOTE RECEPTION	YES
7	TRANSACTION PRINT SELECT	ERROR ONLY
8	DIAL MODE	STONE
9	DISTINCTIVE RINGING	OFF
10	FAX SIGNAL RECEIVE	YES
11	JUNK # CHECK	NO
12	POLLING	NO
13	CALLER-ID	NO
14	COVER SHEET	NO
15	AUTO PRINT OUT	NO
16	ECM MODE	YES

Anti Junk Number List

This list shows the fax numbers (and voice numbers if the Caller ID function is being used) from which reception is not allowed.

ANTI JUNK NUMBER LIST	
MAY-22-96 11:00 AM	
ANTI JUNK # CHECK : TEL/FAX	
STORED LOCATION	JUNK TEL #
1	1111111111
2	2222222222
3	3333333333
4	4444444444
5	5555555555

T.A.D. Program List

This list shows the settings and codes programmed for the answering machine.

T.A.D. PROGRAM LIST		MAY-01-96 02:52 PM
FOR: John Doe Corp.		201 555 1234
ITEM	CONTENT	
OGM RECORDING	GENERAL: RECORDED BOX-1: RECORDED BOX-2: NOT RECORDED BOX-3: NOT RECORDED	
TOLL SAVER	YES	
RECORDING TIME	4 MIN.	
REMOTE CODE #	001	
OVERRIDE CODE #	009	
TRANSFER TELEPHONE #		
TRANSFER TELEPHONE CALLING	NO	
FAX BOX FUNCTION	YES	
ON T.A.D. FAILURE (UNIT SETS TO AUTO FAX RCV.)	YES	
CPC DETECTION	NO	
BOX PASSCODE #	GENERAL: NOT STORED BOX-1: NOT STORED BOX-2: NOT STORED BOX-3: NOT STORED	
DIRECT CALL #	BOX-1: 2226665555 BOX-2: 7894561230 BOX-3: NOT STORED	
DISTINCTIVE RINGING YES/NO	NO	

Message List

This list shows information about the messages currently recorded in the answering machine, including the date and time of recording, the length, and the type (ICM or memo).

MESSAGE LIST					MAY-01-96 02:53 PM
FOR: John Doe Corp.					201 555 1234
NO.	RECORDED TIME	MESSAGE LENGTH	TYPE	FAX PAGES	
01	DEC-01 02:47 PM	05"	MEMO		
02	DEC-01 02:48 PM	1' 23"	ICM (BOX-1)		
03	DEC-01 02:51 PM	06"	ICM (BOX-3)		
04	DEC-01 02:52 PM	19"	ICM (BOX-2)	02	
FAX-ONLY MESSAGES			TYPE	FAX PAGES	
01			FAX (GENERAL)	01	

Program and Group List

The top part of this list shows the programs which have been entered. The bottom part shows the fax numbers which have been stored in each Group Key.

PROGRAM/GROUP LIST		
FOR: John Doe Corp.		MAY-17-96 03:31 PM 201 555 1234
PROGRAM 1	NAME	ABC Corp.
	RESERVED TIME	05:00 PM
	TYPE	TIMER POLLING
	REMOTE STATION ID	S01
GROUP 1	REMOTE STATION ID	S01

Caller ID List

This list shows information about your most recent unanswered calls (maximum of 20 calls). (This list is only available if you are using the Caller ID function.)

CALLER-ID LIST						
AREA CODE: 123			JUN-01-96 06:31 PM			
FOR: John Doe Corp.		201 555 1234				
NO.	DATE	RX TIME	NAME	TELEPHONE #	MODE	
01	JUN-01	06:29 PM	JONE SMITH	111-111-1111	AUTO	
02	JUN-01	06:29 PM	ABC TOOL	222-222-2222	AUTO/PC	
03	JUN-01	06:29 PM	SMITH JONATHAN	333-333-3333	MANU	

Print Set List

This list shows the current status of the printing settings made by pressing the **FUNCTION** key and the "6" key.

PRINT SET UP LIST		
FOR: John Doe Corp.		MAY-22-96 12:25 PM
201 555 1234		
NO.	ITEM	SETTING
1	INITIALIZE FILM	MAY-22-96
2	RECEPTION RATIO	AUTO
3	2 IN 1 PRINT	NO
4	PAPER TYPE SET	REGULAR
5	PAPER SIZE SET	LETTER
6	COPY CUT OFF	YES

Transaction Report

This report is printed out automatically after an operation is completed to allow you to check the result. Your fax is set at the factory to print out the report only when an error occurs, or after a timer or memory operation. If desired, you can change the setting to have it printed out under a variety of other conditions. This is done by changing Option Setting 7 as described in Chapter 8.

- ◆ The Transaction Report shows the same information as the Activity Report. See "Activity Report" in this chapter for an explanation of the headings.
- ◆ The report cannot be printed out manually.

Reading glass and rollers

Clean the reading glass and rollers frequently to ensure the quality of transmitted images and copies. Open the operation panel by pulling the front edge up (grasp it at the "PANEL RELEASE" mark), and clean them as shown below.

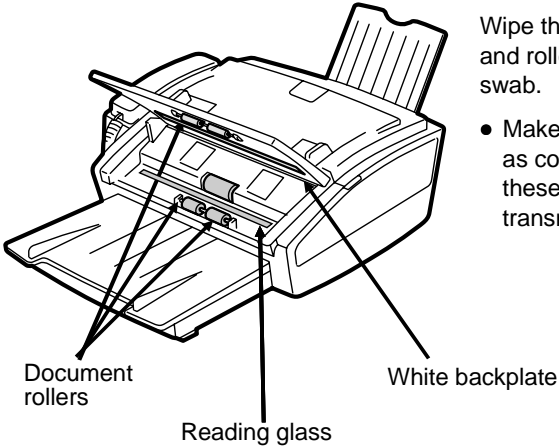

Wipe the reading glass, white backplate, and rollers with a soft cloth or cotton swab.

- Make sure that all dirt and stains (such as correcting fluid) are removed, as these will cause vertical lines on transmitted images and copies.

The housing

Wipe the external parts and surface of the machine with a dry cloth.

Caution!

- *Do not use benzene or thinner. These solvents may damage or discolor the machine.*

Fax print head

Clean the print head frequently to ensure optimum printing performance. To clean the print head, first unplug the power cord, open the paper compartment cover (grasp the finger hold on the right side of the cover and pull up), and remove the imaging film.

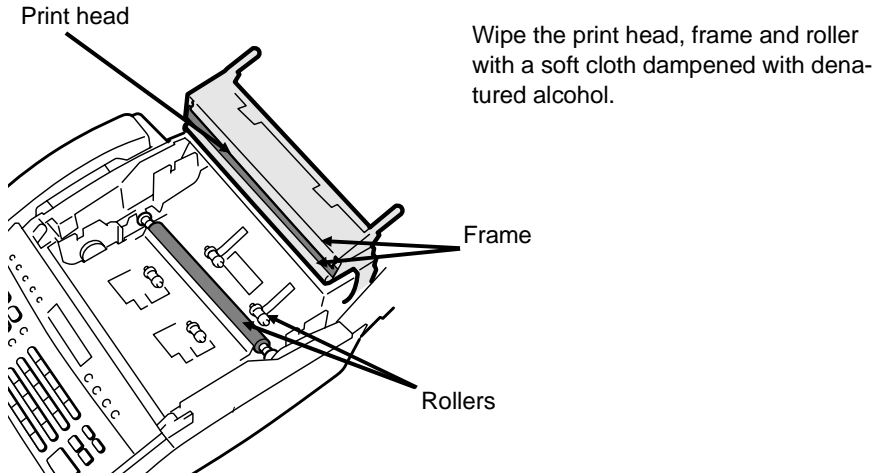

Caution!

- *Do not use benzene or thinner. Avoid touching the print head with hard objects.*
- *The print head may be hot if your fax machine has just received a large number of documents. If this is the case, allow the print head to cool prior to cleaning.*

11 TROUBLESHOOTING

PROBLEMS AND SOLUTIONS

Problem	Check and remedy
Nothing appears in the display.	<ul style="list-style-type: none">• Make sure the power cord is properly plugged into a power outlet.• Make sure the power switch has been switched to the correct position.• Connect another electrical appliance to the outlet to see if it has power.
The fax does not respond when you press any of its keys.	<ul style="list-style-type: none">• If a beep sound is not made when you press the keys, turn off the power and then turn it back on several seconds later.
Automatic document feeding does not work for transmission or copying.	<ul style="list-style-type: none">• Check the size and weight of the document (see "Transmittable documents" in Chapter 3).
Dialing cannot be done.	<ul style="list-style-type: none">• Make sure the power is on.• Make sure that the telephone line is properly connected to both the TEL. LINE jack and the wall jack.• Make sure that the fax is set to the correct dialing mode for your telephone line. See Option Setting 8 in Chapter 8.
Nothing is printed at the receiving end.	<ul style="list-style-type: none">• Make sure that the document for transmission is placed face down in the feeder.• Make sure that the printing paper is properly loaded in the receiving machine.
A distorted image is received at the other end.	<ul style="list-style-type: none">• Noise on the telephone line may cause distortion. Try sending the document again.• Make a copy of the document on your fax. If the copy is also distorted, your fax may have a problem.

PROBLEMS AND SOLUTIONS

<p>The power is on, but no transmission takes place.</p>	<ul style="list-style-type: none"> • Make sure that the receiving machine has printing paper. • Make sure that the telephone line cord is plugged into the "TEL. LINE" jack, and not the "TEL. SET" jack. • If the receiving machine is in manual mode with no attendant, reception will not be possible. • If the receiving machine is not a Sharp model, make sure it is G3 compatible. • Check the display for error messages. • Pick up the handset and check for a dial tone.
<p>The power is on, but no reception takes place.</p>	<ul style="list-style-type: none"> • Make sure that the telephone line cord is plugged into the "TEL. LINE" jack, and not the "TEL. SET" jack.
<p>The printing paper does not come out.</p>	<ul style="list-style-type: none"> • The printing paper may be jammed. See "Clearing Jammed Printing Paper" in this chapter. • Make sure that the printing paper is properly loaded in your machine. • Make sure the power is on.
<p>The printing paper comes out blank when you try to receive a document.</p>	<ul style="list-style-type: none"> • Make sure that the document is loaded properly in the feeder of the transmitting machine. Make a copy to confirm the printing ability of your machine.
<p>The received document is faint.</p>	<ul style="list-style-type: none"> • Ask the other party to send higher contrast documents. If the contrast is still too low, your fax may have a problem. Make a copy to check it.
<p>Received images are distorted.</p>	<ul style="list-style-type: none"> • Noise on the telephone line may cause distortion. Have the other party try sending the document again. • Make a copy of another document on your fax. If the copy is also distorted, your fax may have a problem.

MESSAGES AND SIGNALS

Display messages

CHECK PAPER SIZE	The paper size setting is incorrect. Change the paper size setting as described in "Loading the Paper" in Chapter 1.
COVER OPEN	The printing compartment cover is open. Close it.
DOCUMENT JAM	The original document is jammed. See the following section, "Clearing Paper Jams".
FAX RX IN MEMORY	A fax has been received in memory because the imaging film needs replacement, you have run out of printing paper, or the paper is jammed. The fax will print out automatically when the problem is fixed.
FILM END	The imaging film may need replacement. Check the film and replace it if necessary.
FUNCTION MODE	The FUNCTION key has been pressed.
LINE ERROR	Transmission or reception was not successful. Press STOP to clear the message, and then try again.
LINE IS IN USE	An extension phone connected to the fax is being used. Do not lift the fax's handset or attempt transmission at this time, as this will interrupt the conversation on the extension phone.
MEMORY IS FULL	The memory is full. See "Memory" in Chapter 7.
MEMORY PRINTING	The fax is preparing to or printing out a document from memory.
ON HOOK DIAL	The SPEAKER key has been pressed and the fax is waiting for you to dial.
OUT OF PAPER	You are out of printing paper.
OVER HEAT	The print head has overheated. Operation can be continued once it cools.
PAPER JAMMED	The printing paper is jammed. See the following section, "Clearing Paper Jams".

Note: If you have turned on the Caller ID function, see "Caller ID" in Chapter 7 for display messages related to Caller ID.

Audible signals

Continuous tone	3 seconds	Indicates the end of transmission, reception, or copying.
Intermittent tone (3 beeps)	5 seconds (1 second on, 1 second off)	Indicates incomplete transmission, reception, or copying.
Rapid intermittent tone	0.5 seconds on, 0.5 seconds off	Indicates that the printer cover is open.
Rapid intermittent tone	35 seconds (0.7 seconds on, 0.3 seconds off)	Indicates that the handset is off hook.

CLEARING PAPER JAMS

Clearing a jammed document

If a document doesn't feed properly during transmission or copying, or DOCUMENT JAMMED appears in the display, first try pressing the **START** key. If the document doesn't feed out, open the operation panel (grasp the front edge at the "**PANEL RELEASE**" mark and pull up) and pull it out gently.

Clearing jammed printing paper

1

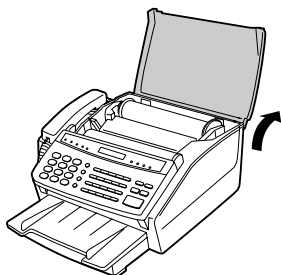

Grasp the finger hold on the right side of the printing compartment cover, and pull up to open the cover.

2

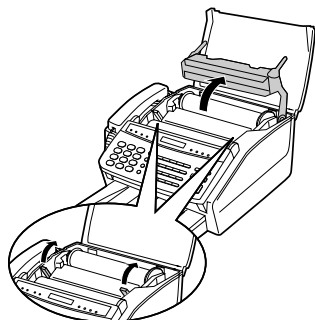

Push back the green levers on each side of the printing compartment, and rotate the printing head frame up and to the rear.

- **Caution!** The printing head (the strip of metal on the underside of the frame) applies heat to the printing film. It may be hot if a document has just been printed.

3



Remove the imaging film from the printing compartment and set it on a sheet of paper.

CLEARING PAPER JAMS

4

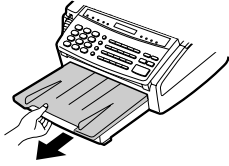

Remove the paper tray from the fax.

5

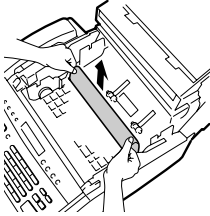

Gently pull the jammed paper out of the printing compartment.

6



Replace the imaging film, making sure that the flange goes into the rear slot on the left side of the printing compartment. Also, make sure that the right, rear gear engages with the gear below it.

7



Wind the film slightly (rotate the gear on the right side of the rear spool) so that there is no slack in the film. Make sure that both edges of the film wind onto the spool evenly.

8

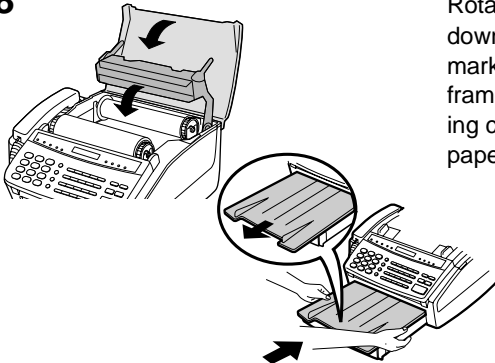

Rotate the printing head frame back down, and press down on the **"PUSH"** mark in the center of the frame until the frame clicks into place. Close the printing compartment cover and replace the paper tray.

SPECIFICATIONS

Applicable telephone line:	Public switched telephone network
Compatibility:	ITU-T (CCITT) G3 mode
Configuration:	Half-duplex, desktop transceiver
Memory size*:	512 KB (approx. 31 average pages with ECM function off and no voice messages recorded, or 24 minutes of voice messages with no documents in memory) 1 MB add-on available as option
Compression scheme:	MH, MR, MMR
Scanning method:	Flat-bed, solid-state CCD
Resolution:	Horizontal: 203 lines/inch (8 lines/mm) Vertical: Standard — 98 lines/inch (3.85 lines/mm) Fine /Halftone— 196 lines/inch (7.7 lines/mm) Super fine — 392 lines/inch (15.4 lines/mm)
Recording system:	Thermal transfer recording
Display:	7 x 5 dots, 1 line by 16-digit display
Reception modes:	Auto/Manual/Ans./switching
Modem speed:	14400 bps with automatic fallback to 12000, 9600, 7200, 4800, or 2400 bps
Transmission time*:	Approx. 6 seconds (memory transmission)
Effective recording width:	8.0" (203 mm) (average)
Input document size:	Automatic feeding: Width — 5.83 to 8.5" (148 to 216 mm) Length — 5.04 to 14" (128 to 356 mm) Manual feeding: Width — 5.83 to 8.5" (148 to 216 mm) Length — 5.04 to 39.4" (128 to 1000 mm)
Effective scanning width:	8.3" (210 mm) max.
Automatic document feeder:	20 sheets max.
Halftone (gray scale):	64 levels
Contrast control:	Automatic/Dark selectable
Copy function:	Single/Multi-copy/Sort-copy (99 copies/page)
Telephone function:	Standard (cannot be used if power fails)
Power requirements:	120 V AC, 60 Hz
Operating environment:	41 - 95°F (5 - 35°C), 20 to 80% RH
Power consumption:	Stand-by: 6 W Maximum: 100 W
Dimensions:	Width: 14.3" (363 mm) Depth: 19.2" (488 mm) Height: 7.4" (188 mm) (Without attachments)
Weight:	Approx. 13.0 lbs. (5.9 kg)

* Based on ITU-T Test Chart #1 at standard resolution in Sharp special mode, excluding time for protocol signals (i.e., ITU-T phase C time only).

As a part of our policy of continuous improvement, SHARP reserves the right to make design and specification changes for product improvement without prior notice. The performance specification figures indicated are nominal values of production units. There may be some deviations from these values in individual units.

Notes

Notes

Empty rectangular box for notes.

SHARP

Date Issued: Feb. 9,1996

MATERIAL SAFETY DATA SHEET

MSDS No. B-1006

Section 6. Physical Chemical Characteristics

Boiling/Melting Point	m.p. about 70 °C for ink	Specific Gravity	about 1
Vapor Pressure	not applicable	Solubility	negligible (water)
Vapor Density	not applicable	PH	not applicable
Evaporation Rate	negligible	Viscosity	not applicable
Appearance	thin film coated with ink	Color	black
Odor	slight wax odor		

Section 7. Fire and Explosion Data

Flash Point (Method Used):	about 250 °C for ink
Ignition Temperature:	not applicable
Flammable Limits:	not applicable (LEL); (UEL);
Extinguishing Media:	CO2, water, dry chemicals and form etc.
Special Fire Fighting Procedure:	especially none
Unusual Fire and Explosion Hazard:	none
Sensitivity to Mechanical Impact:	no hazardous effect by mechanical impact
Sensitivity to Static Charge:	not applicable

Section 8. Reactivity Data

Stability:	Stable
Incompatibility (Materials to Avoid):	especially none
Hazardous Decomposition:	not applicable
Hazardous Polymerization:	not applicable

Section 9. Precautions for Safe Handling and Use

Personal Protection Information (Respiratory, Eye Protection and Protective Glove):	not required
Engineering Control/Ventilation:	especially none
Work/Hygienic Practice:	especially none
Steps to be taken in case of Spill or Leak:	If rumple the product and wax layer peel off, sweep up or clean with vacuum cleaner and wash with water.
Waste Disposal Method:	Dispose in an approved incinerator or contract with licensed chemical disposal agency. ensure conformity with governmental disposal regulations. (Dispose by the same method of ordinary plastic products.)

Section 10. Other Information

NFPA Rating (U.S.A.):	no information
WHMIS Legislation (Canada):	not controlled
Transport Information:	no information
UN No.:	no information

FCC REGULATORY INFORMATION

FCC regulatory information

This equipment complies with FCC rules, Part 68. On this equipment is a label that contains, among other information, the FCC Registration Number and Ringer Equivalence Number (REN) for this equipment. If requested, this information must be provided to your telephone company.

An FCC compliant telephone cord and modular plug is provided with this equipment. This equipment is designed to be connected to the telephone network or premises wiring using a compatible modular jack which is Part 68 compliant. This equipment connects to the telephone network through a standard USOC RJ-11C network interface jack.

The REN is used to determine the quantity of devices which may be connected to your telephone line and still have all of those devices ring when your number is called. Too many devices on one line may result in the devices not ringing in response to an incoming call. In most, but not all, areas the sum of the RENs of all devices should not exceed five (5.0). To be certain of the number of devices that may be connected to your line, as determined by the total REN, contact your local telephone company.

If this equipment causes harm to the telephone network, your telephone company may disconnect your service temporarily. If possible, they will notify you in advance. If advance notice is not practical, you will be notified as soon as possible. You will also be advised of your right to file a complaint with the FCC.

Your telephone company may make changes in its facilities, equipment, operations, or procedures that could affect the operation of your equipment. If this happens, the telephone company will provide advance notice in order for you to make necessary modifications to maintain uninterrupted service. If the equipment is causing harm to the telephone network, your telephone company may ask you to disconnect the equipment until the problem resolved.

If you have any questions or problems which cannot be solved by reading this manual, please contact Sharp Electronics Corporation at Sharp Plaza, Mahwah, NJ 07430-2135. The customer number is 800-237-4277.

This equipment may not be used on coin service provided by the telephone company. Connection to party lines is subject to state tariffs. Contact your state's public utility commission, public service commission, or corporation commission for more information.

This equipment is hearing-aid compatible.

When programming and/or making test calls to emergency numbers:

- Remain on the line and briefly explain to the dispatcher the reason for the call.
- Perform such activities in the off-peak hours, such as early morning or late evening.

REMOTE OPERATION CARD

The card below is provided as a quick guide to remote operation. Cut it out and carry it with you when you go out.

Remote Operation Guide	SHARP®
<ol style="list-style-type: none">1. Call your fax from a touch-tone telephone, and press <input type="text" value="#"/> when the outgoing message begins.2. If you want to listen to a personal box, enter its number.3. Enter your passcode or remote code: <input type="text"/> <input type="text"/> <input type="text"/>.4. Press <input type="text" value="#"/>.5. After listening to your messages, you can either hang up to save them, or enter one of the commands on the reverse side.	

REMOTE COMMANDS

- **PLAYBACK**

Play messages. **7** **#**
 Move backward/repeat. **2** **#**
 Skip forward. **5** **#**
 Stop **0** **#**
 Play new messages only **6** **#**
 (first stop playback)

- **ERASING MESSAGES**

Erase single message **3** **#**
 Erase all messages **3** **3** **#**

- **RECORDING A MEMO**

Start ***** **#**
 End **0** **#**

- **RECORDING A NEW OGM**

Start **4** *****

- **FAX RECEPTION MODES**

T.A.D. mode **8** **1** **#**
 FAX mode **8** **2** **#**
 TEL mode. **8** **3** **#**

- **TRANSFER FUNCTION**

Turn on **9** **1** **#**
 — **(Box#)**
 — **#**
 Turn off **9** **2** **#**
 New transfer number **9** **0** **#**
 — **(Tel.#)**
 — **#**
 Record transfer OGM. **9** **3** **#**
 To quickly disconnect. ***** *****

QUICK REFERENCE GUIDE

INSTALLATION

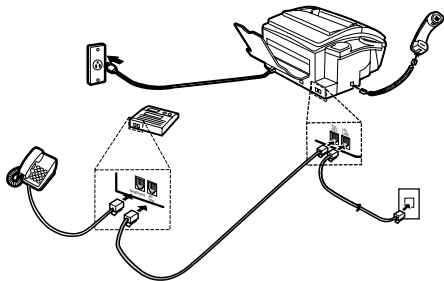

1. Connect the handset as shown.
2. Plug one end of the telephone line into the "TEL. LINE" jack on the rear of the fax, and the other end into your telephone wall jack.
3. Plug the power cord into a grounded, 120 V outlet.

INSTALLATION WITH AN EXTENSION TELEPHONE

4. Remove the seal covering the "TEL. SET" jack on the rear of the fax. Connect an extension telephone to the "TEL. SET" jack.

ENTERING YOUR NAME AND NUMBER

The law requires your name and fax number to appear on all documents you send. To program your fax to do this automatically, follow the steps below:

1. Press the **FUNCTION** key and then press "3":

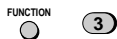

"ENTRY MODE" will appear in the display.

2. Press the "#" key twice: 
"OWN NUMBER SET" will appear in the display.

3. Press the **START** key. 

4. Enter your fax number (max. of 20 digits) by pressing the number keys.
 - ◆ If you make a mistake, press the **HOLD/SEARCH** key to move the cursor back to the mistake, then enter the correct number or letter. (To move the cursor forward, press the **SPEAKER** key.)
5. Press the **START** key: 
6. Enter your name by pressing the appropriate number keys as shown below. Press each key one or more times until the desired letter appears in the display.

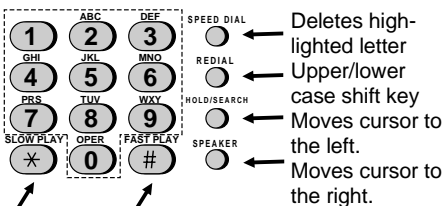

Press either key one or more times to select and enter a symbol.

- ◆ Enter "Q" with the "7" key, and "Z" with the "9" key (these are not marked on the machine). Enter a space with the "1" key.
- ◆ To enter two letters in succession which require using the same key, press the **SPEAKER** key after entering the first letter.

Example: To enter "ABZ Co.", press:

"2" twice for the letter A,

Press **SPEAKER** to move the cursor to the right,

"2" three times for the letter B,

"9" five times for the letter Z,

"1" twice for a space,

"2" four times for the letter C,

Press **REDIAL** for a lower case letter,

"6" four times for the letter o,

"#" once for a period.

7. When finished, press the **START** key and then the **STOP** key. 

(See Page 2-4 of your operation manual.)

SETTING THE DATE & TIME

To set the date and time, press the following sequence of keys:     

"DATE & TIME SET" will appear.

Press the **START** key: 

Enter two digits for the Month (01 through 12).



Enter two digits for the Date (01 through 31).

Enter two digits for the Year (00 through 99).

Enter two digits for the Hour (01 through 12).



Enter two digits for the Minute (00 through 59).

Press the "*" key for A.M. or the "#" key for P.M.



When finished, press the **START** key and then the **STOP** key:  
(See Page 2-7 of your operation manual.)



STORING & CLEARING NUMBERS FOR AUTOMATIC DIALING

To store a new number or change an existing number, press the following sequence of keys:

"FAX/TEL # MODE" will appear.

1. Press the "1" key: 
2. Enter a 2-digit number (from "01" to "99") by pressing the number keys. This will be the Speed Dial number.
3. Press the **START** key: 
4. Enter the name of the location by pressing number keys (max. of 20 characters).
5. Press the **START** key: 
6. Return to Step 3 to store another number, or press **STOP** to exit.

To clear a Speed Dial number, press the following sequence of keys:   

Press "2" and then enter the 2-digit Speed Dial number.

Press:  

(See Page 2-11 of your operation manual.)

SENDING DOCUMENTS

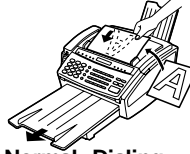

Place your document (up to 20 pages) face down in the document feeder.



Normal Dialing

1. Lift the handset or press 
2. Dial the fax number by pressing the number keys.
3. Wait for the reception tone (if a person answers, ask them to press their Start key).
4. Press your **START** key and then replace the handset.

Rapid Key Dialing

Press the appropriate Rapid Key. Transmission will begin.

Speed Dialing

1. Press the **SPEED DIAL** key: 
2. Enter the Speed Dial number by pressing the number keys.
3. Press: 

Direct Keypad Dialing

1. Enter the fax number by pressing the number keys.
2. Press: 

(See Pages 3-1- 3-10 of your manual.)

RECORDING AN OUTGOING MESSAGE

The answering machine in your fax has four boxes for recording incoming voice messages when it is set to TAD reception mode. The General Box is for general messages, and Box 1, Box 2, and Box 3 are each for personal messages. To leave a message in a personal box, your caller must press the number of that box on his or her telephone before speaking. If a number isn't pressed, the message will be recorded in the General Box.

Note: To use TAD mode, you must record a General outgoing message. To use a personal box, you must also record an outgoing message for that box.



Record an outgoing message for a box as follows:

- 1 Press the following sequence of keys:

- 2 Press a number key to select the outgoing message you want to record:
 General outgoing message **0**
 Box 1 outgoing message **1**
 Box 2 outgoing message **2**
 Box 3 outgoing message **3**
 Transfer outgoing message **4**
- 3 Pick up the handset and speak into it.
- 4 When finished, press the **STOP** key or replace the handset.
- 5 Go back to Step 2 to record an outgoing message for another box, or press the **STOP** key to exit.

Programming a passcode

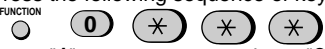
If desired, you can program a 3-digit passcode for a box. If this is done, the passcode must be entered before messages in the box can be listened to or erased.

Note: The numbers 1, 2, and 3 cannot be selected for the first digit of the passcode.

- 1 Press the following sequence of keys:

- 2 Press "1" to enter a passcode, or "2" to clear a previously programmed passcode.
- 3 Enter the number of the box for which you want to enter or clear a passcode. If you are clearing a passcode, go to Step 5.
- 4 Enter a 3-digit passcode by pressing the number keys.
- 5 Press:  

LISTENING TO MESSAGES

- 1 Press: 
- 2 If you want to listen to the messages in a personal box, enter the number of that box.
- 3 Enter the passcode for the box if it has one.

DELETING MESSAGES

Erasing a single message: Press the **DELETE** key while the message is being played.

Erasing all messages in the general box: Hold down the **DELETE** key for at least 2 seconds. If the general box has a passcode, press the **DELETE** key and then enter the passcode.

Erasing all messages in a personal box: Press the **DELETE** key (do not hold it down), enter the box number, and then enter the passcode if the box has one.

SETTING THE RECEPTION MODE

Press the **RECEPTION MODE** key until "TAD", "FAX", or "TEL" appears in the display.

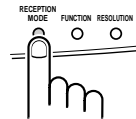

TAD mode: Select this mode when you go out and want the built-in answering machine to record voice messages from callers. Both voices messages and faxes will be received.

FAX mode: The fax will automatically answer after four rings and receive the incoming document.

TEL mode: Lift the handset when the fax rings. If you hear a fax tone, wait until "RECEIVING" appears in the display, then hang up (if "RECEIVING" doesn't appear, press the **START** key). If the calling party talks to you, press your **START** key to begin reception. (See Pages 3-11 - 3-12 and Chapter 4 of your manual.)

FUNCTION key menu

The following chart shows the layout of the functions and settings accessed by pressing the **FUNCTION** key. First press the **FUNCTION** key, the appropriate numeric key as shown, and then "#" or "*" until the desired item appears.

Instructions for making each setting appear in the display. If you have any difficulty, refer to the detailed instructions on the page shown below the setting.

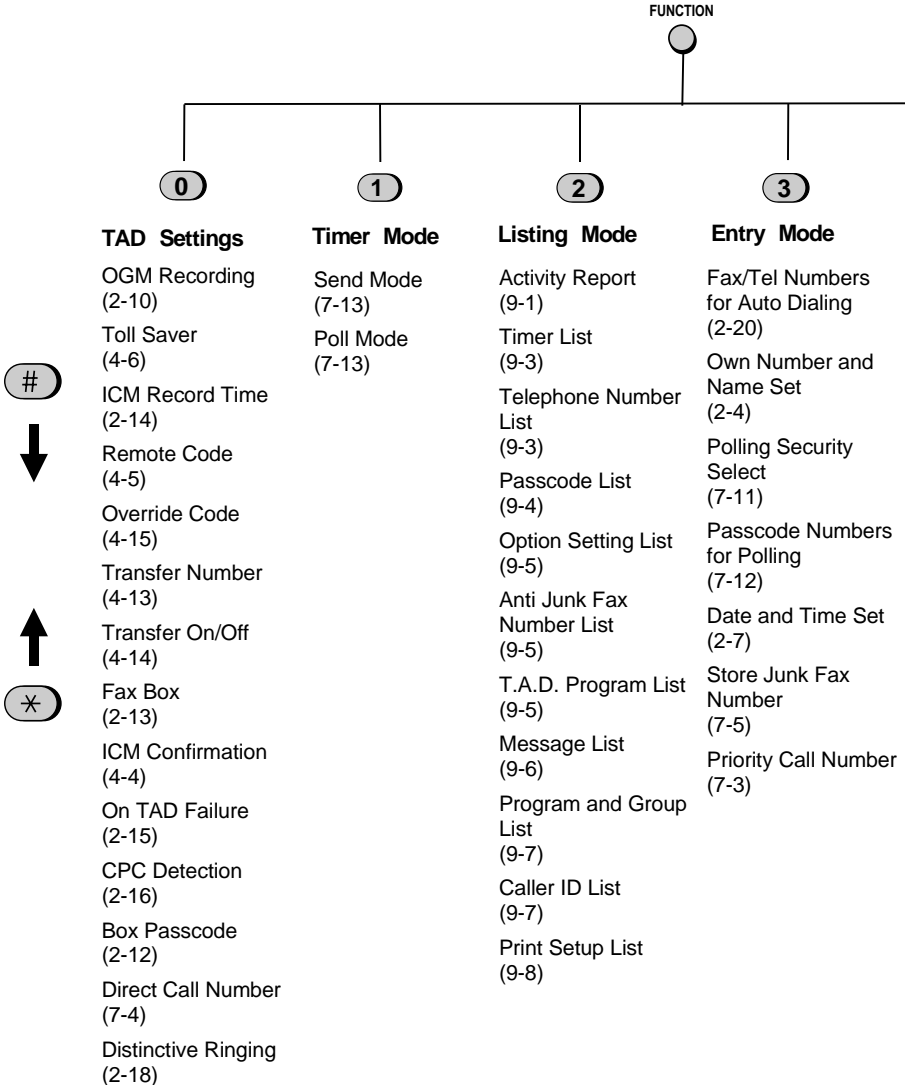

4

Optional Settings

Fine Resolution
Priority
(8-1)

Polling
(8-3)

Caller ID
(8-3)

Number of Rings in
Auto Mode
(8-1)

Autocover Sheet
(8-3)

Recall Wait Interval
(8-2)

Activity Report
(8-4)

Recall Times
(8-2)

ECM
(8-4)

Remote Reception
Number
(8-2)

Remote Reception
Select
(8-2)

Transaction Report
Print Select
(8-2)

Dial Mode
(8-2)

Distinctive Ringing
(2-17, 8-3)

Fax Signal Receive
(8-3)

Junk Number Check
(8-3)

5

Cover Sheet

Cover Sheet
Header
(3-4)

6

Print Set-up

Initialize Film
(1-5)

Reception Ratio
(3-13)

2 in 1 Print
(3-13)

Paper Type Set
(1-10)

Paper Size Set
(1-10)

Copy Cut-off
(5-3)

7

Program/Group

Program Entry
Mode
(7-15)

Group Entry
Mode
(2-23)

INDEX

A

Activity Report, 9-1 - 9-3
 Automatic print-out, 8-4
Anti Junk Fax/Number, 7-5, 8-3
Anti Junk Number List, 9-5
Audible signals, 11-4
Auto Cover Sheet, 8-3
Automatic dialing, 2-20 - 2-23

B

Batch page numbering, 3-5
Broadcasting, 7-8 - 7-9

C

Caller ID, 7-1 - 7-4, 8-3
Caller ID List, 7-2 - 7-3, 9-6
Calling party control, 2-16
Cleaning, 10-1 -10-2
Connections, 1-6 - 1-7
Contrast, 3-3
Copies, 3-14 - 3-16
Copy cut-off, 3-16
Copy/Help key, 2-3, 3-14
Cover sheet, 3-4, 8-4

D

Date, setting, 2-7
Dialing
 Direct Keypad, 3-7
 Normal, 3-6, 3-17
 Rapid Key, 3-8, 3-17
 Search, 3-9, 3-18
 Speed, 3-8, 3-17
Dial mode, 8-2
Direct Call, 7-4
Direct Keypad Dialing, 3-7
Display, 2-3
Display messages, 11-3
Distinctive ringing, 2-17 - 2-19
Document feeder, 3-2
Document guide, 3-2
Document restrictions, 3-1
Document rollers, 10-1
Document sizes, 3-1
Document, maximum scanning size, 3-1

E

Electrical outlet, 1-6
Error Correction Mode, 8-4
Extension telephone, connecting, 1-6 - 1-7
Extension telephone, using, 3-11 - 3-12

F

FAX reception mode, 2-8, 3-11
Fax reception on TAD failure, 2-15
Fine Resolution Priority, 8-1
Function key, 2-3, Quick-iii

G

Group Keys
 Storing, 2-23
 Using, 7-9

H

Halftone, 3-3
Handset, 1-7
Handset receiver volume, 2-24
Hold, 6-2
Hold/Search key, 2-2, 3-9, 6-2
Housing, cleaning, 10-1

I

Imaging film, 1-2 - 1-5
Incoming message time, 2-14
Initialize film setting, 1-5

J

Jams, clearing, 11-5

L

Letters, entering, 2-5 - 2-6
Loading the document, 3-2

M

Rec/Memo key, 2-2, 4-3 - 4-4
Memory, 7-6 - 7-7
Message List, 9-5
Messages

INDEX

Playback, 4-1 - 4-3
Erasing, 4-3
Date and time, 4-4

N

Normal Dialing, 3-6, 3-17
Number of Rings in FAX Mode, 8-1
Number keys, 2-2

O

Option Setting List, 9-4
Outgoing message, 2-10 - 2-11
Override ringing, 4-15 - 4-16

P

Paper jams, clearing, 11-5
Paper type setting, 1-10
Paper size setting, 1-10
Passcode List, 9-4
Passcodes for boxes, 2-12, 4-2, 4-3, 4-7
Pauses in automatic dialing numbers, 2-20
PC connection, 7-22 - 7-24
PC mode, 7-22 - 7-24
Play/Skip key, 2-2, 4-2
Polling, 7-10 - 7-12
Polling key, setting, 7-10, 8-3
Power cord, 1-6
Print head, cleaning, 10-2
Print Set List, 7-6
Printing from a computer, 7-24
Priority Call, 7-3
Program and Group List, 9-5
Programs, 7-15 - 7-19

R

Rapid Key Dialing, 3-8, 3-17
Rapid Keys, 2-3
Reading glass, cleaning, 10-1
Recall Wait Interval, 8-2
Recall Times, 8-2
Receive unit setting, 2-8, 3-14
Reception mode, 2-8
 Setting, 2-8
 FAX mode, 2-8, 3-11
 TAD mode, 2-8, 4-1

 TEL mode, 2-8, 3-11 - 3-12
Reception mode key, 2-3, 2-8
Reception ratio setting, 3-13
Redial key, 2-2, 2-11, 3-9, 3-18
Redialing, 3-9, 3-18
Reminder Function, 7-20 - 7-21
Resolution, 3-3
Resolution key, 2-3, 3-3
Ringing volume, 2-24
Rec/Memo key, 2-2, 4-3 - 4-4
Rollers, cleaning, 10-1 - 10-2

S

Scanning to a computer, 5-22 - 5-23
Search Dialing, 3-9, 3-18
Sender's name and number, entering, 2-4
Slow Play key, 2-2, 4-2
Speaker key, 2-2, 3-6, 3-17
Speaker volume, 2-15
Speed Dial key, 2-2, 3-7, 3-17
Speed Dialing, 3-8, 3-17
Start key, 2-3
Stop key, 2-3
Storing numbers for automatic dialing, 2-20 - 2-22

T

TAD Program List, 9-5
TAD reception mode, 2-8, 4-1
TEL. LINE jack, 1-7
TEL reception mode, 3-11 - 3-12
TEL. SET jack, 1-7
Telephone, using as, 3-17
Telephone/Fax Remote Number, 8-2
Telephone line cord, 1-7
Telephone Number List, 9-3
Time, setting, 2-7
Timer operations, 7-13 - 7-14
Timer List, 9-3
Transaction Report, 9-6
Transaction Report Print Select, 8-2
Transfer function, 4-13 - 4-15
Two-in-one printing, 3-13

V

Volume Keys, 2-3, 2-24

WARRANTY NOTICE

BE SURE TO ASK YOUR AUTHORIZED SHARP DEALER ABOUT THE WARRANTY THAT YOUR SELLING DEALER EXTENDS TO YOU. In order to assure you, the end-user, of warranty protection, Sharp extends a limited warranty to each of its authorized dealers, and in turn requires each of its authorized dealers to extend its own warranty to you on terms that are no less favorable than those given to the dealer by Sharp. You should be aware, however, that Sharp does not itself extend any warranties, either express or implied, directly to you, the end-user, and no one is authorized to make any representations or warranties on behalf of Sharp. Specifically, SHARP DOES NOT EXTEND TO YOU, THE END-USER, ANY EXPRESS WARRANTY OR ANY IMPLIED WARRANTY OF MERCHANTABILITY, fitness for use or fitness for any particular purpose in connection with the hardware, SOFTWARE, OR FIRMWARE EMBODIED IN OR USED IN CONJUNCTION WITH THIS PRODUCT. Sharp is not responsible for any damages or loss, whether direct incidental or consequential, which you, the end-user, may experience as a result of your purchase or use of the hardware, software or firmware embodied in or used in conjunction with this product. Your sole remedy in the event that you encounter difficulties with the product is against the authorized dealer from which you purchased the product. In the event that this authorized dealer does not honor its warranty commitments, please contact the General Manager Business Communication Systems Division, Sharp Electronics Corporation, Sharp Plaza, P.O. Box 650, Mahwah, NJ 07430-2135 so that Sharp can try to help you to assure complete satisfaction of all the warranty rights to which you are entitled from the authorized dealer.

SHARP®

SHARP ELECTRONICS CORPORATION

Sharp Plaza, Mahwah, New Jersey 07430-2135

SHARP CORPORATION

PRINTED IN THAILAND
(TINSE3594XH2C)

Free Manuals Download Website

<http://myh66.com>

<http://usermanuals.us>

<http://www.somanuals.com>

<http://www.4manuals.cc>

<http://www.manual-lib.com>

<http://www.404manual.com>

<http://www.luxmanual.com>

<http://aubethermostatmanual.com>

Golf course search by state

<http://golfingnear.com>

Email search by domain

<http://emailbydomain.com>

Auto manuals search

<http://auto.somanuals.com>

TV manuals search

<http://tv.somanuals.com>