

# SHARP®

## Carousel®

---

MODELS R-1600 R-1601 R-1602

---

O V E R   T H E   R A N G E

---

M I C R O W A V E   O V E N

---

**INTERACTIVE**  
**COOKING SYSTEM**



---

O P E R A T I O N   M A N U A L

---

Read all instructions carefully before using the oven.

# FOR CUSTOMER ASSISTANCE

To aid in reporting this microwave oven in case of loss or theft, please record below the model number and serial number located on the unit. We also suggest you record all the information listed and retain for future reference.

MODEL NUMBER _____	SERIAL NUMBER _____
DATE OF PURCHASE _____	
DEALER _____	TELEPHONE _____
SERVICER _____	TELEPHONE _____

TO PHONE:

**DIAL 1-800-BE-SHARP (237-4277) for:**

SERVICE (for your nearest Sharp Authorized Servicer)

PARTS (for your authorized parts distributor)

ADDITIONAL CUSTOMER INFORMATION

**DIAL 1-800-642-2122 for:**

ACCESSORIES and COOKBOOK

**DIAL (201)529-8703 for:**

COOKING ASSISTANCE

TO WRITE:

**For cooking and operation questions:**

Susan Edwards/Test Kitchen

Sharp Electronics Corporation

Sharp Plaza, Box 650

Mahwah, NJ 07430-2135

**For service problems, warranty information, missing items and other assistance:**

Sharp Electronics Corporation

Customer Assistance Center

1300 Naperville Drive

Romeoville, IL 60446-1091

Please provide the following information when you write or call: model number, serial number, date of purchase, your complete mailing address (including zip code), your daytime telephone number (including area code) and description of the problem.

TO ACCESS INTERNET: [www.sharp-usa.com](http://www.sharp-usa.com)

## PRECAUTIONS TO AVOID POSSIBLE EXPOSURE TO EXCESSIVE MICROWAVE ENERGY

- (a) Do not attempt to operate this oven with the door open since open-door operation can result in harmful exposure to microwave energy. It is important not to defeat or tamper with the safety interlocks.
- (b) Do not place any object between the oven front face and the door or allow soil or cleaner residue to accumulate on sealing surfaces.
- (c) Do not operate the oven if it is damaged. It is particularly important that the oven door close properly and that there is no damage to the: (1) door (bent), (2) hinges and latches (broken or loosened), (3) door seals and sealing surfaces.
- (d) The oven should not be adjusted or repaired by anyone except properly qualified service personnel.

# CONTENTS

<b>For Customer Assistance....</b>	Inside Front Cover	CompuDefrost .....	15
<b>Precautions to Avoid Possible</b>		CompuDefrost Chart .....	15
<b>Exposure to Excessive</b>		Manual Defrost.....	16
<b>Microwave Energy .....</b>	Inside Front Cover	Popcorn .....	16
<b>Contents .....</b>	1	<b>Other Convenient Features .....</b>	17-19
<b>Consumer Limited Warranty .....</b>	2	Multiple Sequence Cooking .....	17
<b>Product Information Card.....</b>	2	More or Less Time Adjustment .....	17
<b>Important Safety Instructions .....</b>	3	Memory Cook.....	17
<b>Unpacking Instructions .....</b>	4	Custom Help .....	18
<b>Optional Accessories .....</b>	4	1. Child Lock .....	18
<b>Grounding Instructions .....</b>	4	2. Audible Signal Elimination .....	18
<b>Information You Need to Know .....</b>	5-7	3. Auto Start .....	18
About Your Oven .....	5	4. & 5. Language/Weight Selection .....	18
About Food .....	5	Kitchen Timer.....	18
About Microwave Cooking .....	6	Touch On .....	19
About Safety .....	6	Minute Plus .....	19
About Utensils and Coverings .....	7	Demonstration Mode .....	19
About Children and the Microwave .....	7	Help .....	19
<b>Part Names .....</b>	8	Work Light.....	19
<b>Touch-Control Panel .....</b>	9	Night Light.....	19
<b>Before Operating .....</b>	10	Fan.....	19
To Set the Clock .....	10	<b>Reheating Chart .....</b>	20
Stop/Clear .....	10	<b>Fish and Seafood Cooking Chart .....</b>	20
<b>Manual Operation .....</b>	10-11	<b>Service Call Check .....</b>	21
Time Cooking .....	10	<b>THE ULTIMATE ACCESSORY .....</b>	21
To Set Power Level .....	10-11	<b>Specifications .....</b>	22
Turntable On/Off .....	11	<b>Cookbook Order Form .....</b>	22
Using the Rack.....	11	<b>Cleaning and Care.....</b>	23
<b>Special Features .....</b>	12-16	<b>Replacing Parts .....</b>	24
Breakfast/Lunch/Dinner .....	12	<b>Guia Auto-Touch.....</b>	Parte Interior de la
Breakfast Chart .....	12		Cubierta Trasera
Lunch Chart .....	13	<b>Auto-Touch Guide.....</b>	Back Cover
Dinner Chart .....	14		

## INTERACTIVE COOKING SYSTEM

The Interactive Cooking System with 2-line, 16-digit display offers step-by-step instructions for using the oven, from setting the clock to programming each feature. It also includes Custom Help for instructions on using Child Lock, Audible Signal Elimination and Auto Start. There is a choice of English, Spanish or French and a choice of U.S. Customary Unit-pound or Metric-kilograms. Touch CUSTOM HELP and follow the directions displayed or check page 18.

# CONSUMER LIMITED WARRANTY

SHARP ELECTRONICS CORPORATION warrants to the first consumer purchaser that this Sharp brand product (the "Product"), when shipped in its original container, will be free from defective workmanship and materials, and agrees that it will, at its option, either repair the defect or replace the defective Product or part thereof with a new or remanufactured equivalent at no charge to the purchaser for parts or labor for the period(s) set forth below.

This warranty does not apply to any appearance items of the Product nor to the additional excluded item(s) set forth below nor to any Product the exterior of which has been damaged or defaced, which has been subjected to misuse, abnormal service or handling, or which has been altered or modified in design or construction.

In order to enforce the rights under this limited warranty, the purchaser should follow the steps set forth below and provide proof of purchase to the servicer.

The limited warranty described herein is in addition to whatever implied warranties may be granted to purchasers by law. ALL IMPLIED WARRANTIES INCLUDING THE WARRANTIES OF MERCHANTABILITY AND FITNESS FOR USE ARE LIMITED TO THE PERIOD(S) FROM THE DATE OF PURCHASE SET FORTH BELOW. Some states do not allow limitations on how long an implied warranty lasts, so the above limitation may not apply to you.

Neither the sales personnel of the seller nor any other person is authorized to make any warranties other than those described herein, or to extend the duration of any warranties beyond the time period described above on behalf of Sharp.

The warranties described herein shall be the sole and exclusive warranties granted by Sharp and shall be the sole and exclusive remedy available to the purchaser. Correction of defects, in the manner and for the period of time described herein, shall constitute complete fulfillment of all liabilities and responsibilities of Sharp to the purchaser with respect to the Product, and shall constitute full satisfaction of all claims, whether based on contract, negligence, strict liability or otherwise. In no event shall Sharp be liable, or in any way responsible, for any damages or defects in the Product which were caused by repairs or attempted repairs performed by anyone other than an authorized servicer. Nor shall Sharp be liable or in any way responsible for any incidental or consequential economic or property damage. Some states do not allow the exclusion of incidental or consequential damages, so the above exclusion may not apply to you.

THIS WARRANTY GIVES YOU SPECIFIC LEGAL RIGHTS. YOU MAY ALSO HAVE OTHER RIGHTS WHICH VARY FROM STATE TO STATE.

**Your Product Model Number & Description:**

R-1600, R-1601 and R-1602 Home Use Carousel Microwave Oven.  
(Be sure to have this information available when you need service for your Product.)

**Warranty Period for this Product:**

One (1) year parts and labor in-home service. The warranty period continues for an additional six (6) years, for a total of seven (7) years, with respect to the magnetron tube in the Product for parts only. Labor and the servicer trip charge are not provided free of charge for this additional period.

**Additional Item(s) Excluded from Warranty Coverage (if any):**

Non-functional accessories, turntable and light bulbs.

**Where to Obtain Service:**

From a Sharp Authorized Servicer located In the United States. Be sure to have **Proof of Purchase** available. For in-home service, the servicer will come to the unit's location. If it is necessary to remove the unit for repair, the servicer will reinstall the unit at no extra charge, provided it was installed according to Sharp's Installation Instructions. To find the location of the nearest Sharp Authorized Servicer, call Sharp toll free at 1-800-BE-SHARP (1-800-237-4277).

TO OBTAIN SUPPLY, ACCESSORY OR PRODUCT INFORMATION, CALL **1-800-BE-SHARP** OR VISIT [www.sharp-usa.com](http://www.sharp-usa.com).  
SAVE THE PROOF OF PURCHASE AS IT IS NEEDED SHOULD YOUR OVEN EVER REQUIRE WARRANTY SERVICE.

## PRODUCT INFORMATION CARD

The product information card should be completed within ten days of purchase and returned. We will keep it on file and help you access the information in case of loss, damage or theft. This will also enable us to contact you in the unlikely event that any adjustments or modifications are ever required for your oven.

# IMPORTANT SAFETY INSTRUCTIONS

When using electrical appliances basic safety precautions should be followed, including the following:

**WARNING** - To reduce the risk of burns, electric shock, fire, injury to persons or exposure to excessive microwave energy:

1. Read all instructions before using the appliance.
2. Read and follow the specific **“PRECAUTIONS TO AVOID POSSIBLE EXPOSURE TO EXCESSIVE MICROWAVE ENERGY”** on inside front cover.
3. This appliance must be grounded. Connect only to properly grounded outlet. See **“GROUNDING INSTRUCTIONS”** on page 4 and **INSTALLATION INSTRUCTIONS**.
4. Install or locate this appliance only in accordance with the provided installation instructions.
5. Some products such as whole eggs and sealed containers—for example, closed glass jars—may explode and should not be heated in this oven.
6. Use this appliance only for its intended use as described in this manual. Do not use corrosive chemicals or vapors in this appliance. This type of oven is specifically designed to heat, cook or dry food. It is not designed for industrial or laboratory use.
7. As with any appliance, close supervision is necessary when used by children.
8. Do not operate this appliance if it has a damaged cord or plug, if it is not working properly or if it has been damaged or dropped.
9. This appliance should be serviced only by qualified service personnel. Contact nearest Sharp Authorized Servicer for examination, repair or adjustment.
10. Do not cover or block any openings on the appliance.
11. Do not store or use this appliance outdoors. Do not use this product near water—for example, near a kitchen sink, in a wet basement or near a swimming pool, and the like.
12. Do not immerse cord or plug in water.
13. Keep cord away from heated surfaces.
14. Do not let cord hang over edge of table or counter.
15. See door surface cleaning instructions on page 23.
16. To reduce the risk of fire in the oven cavity:
  - a. Do not overcook food. Carefully attend appliance if paper, plastic or other combustible materials are placed inside the oven to facilitate cooking.
  - b. Remove wire twist-ties from paper or plastic bags before placing bag in oven.
  - c. **If materials inside the oven should ignite, keep oven door closed, turn oven off and disconnect the power cord or shut off power at the fuse or circuit breaker panel.**
  - d. Do not use the cavity for storage purposes. Do not leave paper products, cooking utensils or food in the cavity when not in use.
17. Clean ventilation openings and grease filters frequently—Grease should not be allowed to accumulate on ventilation openings, hood (louver) or grease filters.
18. Use care when cleaning the louver and the grease filters. Corrosive cleaning agents, such as lye-based oven cleaners, may damage the louver and the grease filters.
19. When flaming foods under the hood, turn the fan on.
20. This appliance is suitable for use above both gas and electric cooking equipment 36" wide or less.

## SAVE THESE INSTRUCTIONS

# UNPACKING INSTRUCTIONS

## Unpacking and Examining Your Oven

Carefully remove oven from carton. **SAVE THE CARTON AS IT MAY MAKE INSTALLATION EASIER.**

Remove:

1. all packing materials from inside the oven cavity; however, **DO NOT REMOVE THE WAVEGUIDE COVER**, which is located on the ceiling in the oven cavity. Check to see that there are Installation Instructions, Wall Template, Top Template and RK-230 Charcoal Filter, which is used when recirculating is chosen. Read enclosures and **SAVE** the Operation Manual.
2. the feature sticker from the outside of the door, if there is one.

Check the oven for any damage, such as misaligned or bent door, damaged door seals and sealing surfaces, broken or loose door hinges and latches and dents inside the cavity or on the door. If there is any damage, do not operate the oven and contact your dealer or SHARP AUTHORIZED SERVICER.

See Installation Instructions for more details.

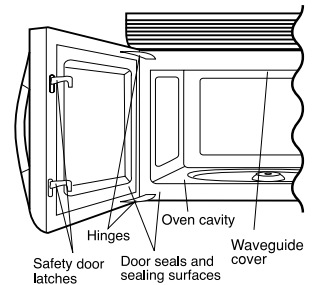

# OPTIONAL ACCESSORIES

Two optional accessories are available for this oven.

1. Charcoal Filter (RK-230). The filter packed in the oven is required when hood exhaust is recirculated. See Charcoal Filter on page 24. To purchase replacement Charcoal Filter, check with dealer or call 1-800-642-2122. Have credit card ready.
2. Filler Panel Kit. For use when the oven is installed in a 36-inch or 42-inch wide opening. The metal filler panels come in 3-inch wide pairs. One set is needed for a 36-inch opening and 2 sets for a 42-inch opening. White and black are available.

To purchase contact: Modern-Aire Ventilating Corporation  
7319 Lankershim Blvd.  
North Hollywood, CA 91605  
Phone: (818) 765-9870  
Fax: (818) 765-4916

# GROUNDING INSTRUCTIONS

This appliance must be grounded. This oven is equipped with a cord having a grounding wire with a grounding plug. It must be plugged into a wall receptacle that is properly installed and grounded in accordance with the National Electrical Code and local codes and ordinances. In the event of an electrical short circuit, grounding reduces risk of electric shock by providing an escape wire for the electric current.

**WARNING** – Improper use of the grounding plug can result in a risk of electric shock.

## Electrical Requirements

Check Installation Instructions for proper location for the power supply.

The electrical requirements are a 120 volt 60 Hz, AC only, 15 amp. or more protected electrical supply. It is recommended that a separate circuit serving only the oven be provided.

The oven is equipped with a 3-prong grounding plug. It must be plugged into a wall receptacle that is properly installed and grounded. **DO NOT UNDER ANY CIRCUMSTANCES CUT OR REMOVE THE GROUNDING PIN FROM THE PLUG.**

- Notes:**
1. If you have any questions about the grounding or electrical instructions, consult a qualified electrician or service person.
  2. Neither Sharp nor the dealer can accept any liability for damage to the oven or personal injury resulting from failure to observe the correct electrical connection procedures.

## Radio or TV Interference

Should there be any interference caused by the microwave oven to your radio or TV, check that the microwave oven is on a different electrical circuit, relocate the radio or TV as far away from the oven as feasible or check position and signal of receiving antenna.

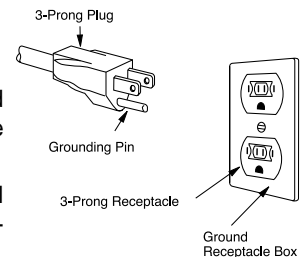

# INFORMATION YOU NEED TO KNOW

## ABOUT YOUR OVEN

This Operation Manual is valuable: read it carefully and always save it for reference.

A good microwave cookbook is a valuable asset. Check it for microwave cooking principles, techniques, hints and recipes. See pages 21 and 22 for ordering the Ultimate Accessory, the SHARP CAROUSEL MICROWAVE COOKBOOK.

**NEVER** use the oven without the turntable and support nor turn the turntable over so that a large dish could be placed in the oven. The turntable will turn both clockwise and counterclockwise. See page 11 for complete instructions.

**ALWAYS** have food in the oven when it is on to absorb the microwave energy.

When using the oven at power levels below 100%, you may hear the magnetron cycling on and off. It is normal for the exterior of the oven to be warm to the touch when cooking or reheating.

Condensation is a normal part of microwave cooking. Room humidity and the moisture in food will influence the amount of moisture that condenses in the oven. Generally, covered foods will not cause as much condensation as uncovered ones. Ventilation openings must not be blocked.

The oven is for food preparation only. It should not be used to dry clothes or newspapers.

Your oven is rated 1000 watts by using the IEC Test Procedure. In using recipes or package directions, check food a minute or two before the minimum time and add time accordingly.

## ABOUT FOOD

FOOD	DO	DON'T
<b>Eggs, sausages, fruits &amp; vegetables</b>	<ul style="list-style-type: none"> <li>• Puncture egg yolks before cooking to prevent "explosion".</li> <li>• Pierce skins of potatoes, apples, squash, hot dogs and sausages so that steam escapes.</li> </ul>	<ul style="list-style-type: none"> <li>• Cook eggs in shells.</li> <li>• Reheat whole eggs.</li> <li>• Dry nuts or seeds in shells.</li> </ul>
<b>Popcorn</b>	<ul style="list-style-type: none"> <li>• Use specially bagged popcorn for the microwave oven.</li> <li>• Listen while popping corn for the popping to slow to 1 or 2 seconds or use special POPCORN pad.</li> </ul>	<ul style="list-style-type: none"> <li>• Pop popcorn in regular brown bags or glass bowls.</li> <li>• Exceed maximum time on popcorn package.</li> </ul>
<b>Baby food</b>	<ul style="list-style-type: none"> <li>• Transfer baby food to small dish and heat carefully, stirring often. Check temperature before serving.</li> <li>• Put nipples on bottles after heating and shake thoroughly. "Wrist" test before feeding.</li> </ul>	<ul style="list-style-type: none"> <li>• Heat disposable bottles.</li> <li>• Heat bottles with nipples on.</li> <li>• Heat baby food in original jars.</li> </ul>
<b>General</b>	<ul style="list-style-type: none"> <li>• Cut baked goods with filling after heating to release steam and avoid burns.</li> <li>• Stir liquids briskly before and after heating to avoid "eruption".</li> <li>• Use deep bowl, when cooking liquids or cereals, to prevent boilovers.</li> </ul>	<ul style="list-style-type: none"> <li>• Heat or cook in closed glass jars or air tight containers.</li> <li>• Can in the microwave as harmful bacteria may not be destroyed.</li> <li>• Deep fat fry.</li> <li>• Dry wood, gourds, herbs or wet papers.</li> </ul>

## ABOUT MICROWAVE COOKING

- Arrange food carefully. Place thickest areas towards outside of dish.
- Watch cooking time. Cook for the shortest amount of time indicated and add more as needed. Food severely overcooked can smoke or ignite.
- Cover foods while cooking. Check recipe or cook-book for suggestions: paper towels, wax paper, microwave plastic wrap or a lid. Covers prevent spattering and help foods to cook evenly.
- Shield with small flat pieces of aluminum foil any thin areas of meat or poultry to prevent overcooking before dense, thick areas are cooked thoroughly.
- Stir foods from outside to center of dish once or twice during cooking, if possible.
- Turn foods over once during microwaving to speed cooking of such foods as chicken and hamburgers. Large items like roasts must be turned over at least once.
- Rearrange foods such as meatballs halfway through cooking both from top to bottom and from the center of the dish to the outside.
- Add standing time. Remove food from oven and stir, if possible. Cover for standing time which allows the food to finish cooking without overcooking.
- Check for doneness. Look for signs indicating that cooking temperatures have been reached.
  - Doneness signs include:**
    - Food steams throughout, not just at edge.
    - Center bottom of dish is very hot to the touch.
    - Poultry thigh joints move easily.
    - Meat and poultry show no pinkness.
    - Fish is opaque and flakes easily with a fork.

## ABOUT SAFETY

- Check foods to see that they are cooked to the United States Department of Agriculture's recommended temperatures.
- ALWAYS use potholders to prevent burns when handling utensils that are in contact with hot food. Enough heat from the food can transfer through utensils to cause skin burns.
- Avoid steam burns by directing steam away from the face and hands. Slowly lift the farthest edge of a dish's covering and carefully open popcorn and oven cooking bags away from the face.
- Stay near the oven while it's in use and check cooking progress frequently so that there is no chance of overcooking food.
- NEVER use the cavity for storing cookbooks or other items.
- Select, store and handle food carefully to preserve its high quality and minimize the spread of foodborne bacteria.
- Keep waveguide cover clean. Food residue can cause arcing and/or fires.
- Use care when removing items from the oven so that the utensil, your clothes or accessories do not touch the safety door latches.

TEMP	FOOD
160°F	... for fresh pork, ground meat, boneless white poultry, fish, seafood, egg dishes and frozen prepared food.
165°F	... for leftover, ready-to-reheat refrigerated, and deli and carry-out "fresh" food.
170°F	... white meat of poultry.
180°F	... dark meat of poultry.

To test for doneness, insert a meat thermometer in a thick or dense area away from fat or bone. NEVER leave the thermometer in the food during cooking, unless it is approved for microwave oven use.



## ABOUT UTENSILS AND COVERINGS

It is not necessary to buy all new cookware. Many pieces already in your kitchen can be used successfully in your new microwave oven. Make sure the utensil does not touch the interior walls during cooking.

### Use these utensils for safe microwave cooking and reheating:

- glass ceramic (Pyroceram®), such as Corningware®.
- heat-resistant glass (Pyrex®)
- microwave-safe plastics
- paper plates
- microwave-safe pottery, stoneware and porcelain
- browning dish (Do not exceed recommended preheating time. Follow manufacturer's directions.)

### These items can be used for short time reheating of foods that have little fat or sugar in them:

- wood, straw, wicker

### DO NOT USE

- metal pans and bakeware
- dishes with metallic trim
- non-heat-resistant glass
- non-microwave-safe plastics (margarine tubs)
- recycled paper products
- brown paper bags
- food storage bags
- metal twist-ties

Should you wish to check if a dish is safe for microwaving, place the empty dish in the oven and microwave on HIGH for 30 seconds. A dish which becomes very hot should not be used.

## ABOUT CHILDREN AND THE MICROWAVE

Children below the age of 7 should use the microwave oven with a supervising person very near to them. Between the ages of 7 and 12, the supervising person should be in the same room.

The child must be able to reach the oven comfortably; if not, he/she should stand on a sturdy stool.

At no time should anyone be allowed to lean or swing on the oven door.

### The following coverings are ideal:

- Paper towels are good for covering foods for reheating and absorbing fat while cooking bacon.
- Wax paper can be used for cooking and reheating.
- Plastic wrap that is specially marked for microwave use can be used for cooking and reheating. DO NOT allow plastic wrap to touch food. Vent so steam can escape.
- Lids that are microwave-safe are a good choice because heat is kept near the food to hasten cooking.
- Oven cooking bags are good for large meats or foods that need tenderizing. DO NOT use metal twist ties. Remember to slit bag so steam can escape.

### How to use aluminum foil in your microwave oven:

- Small flat pieces of aluminum foil placed smoothly on the food can be used to shield areas that are either defrosting or cooking too quickly.
- Foil should not come closer than one inch to any surface of the oven.

Should you have questions about utensils or coverings, check a good microwave cookbook or follow recipe suggestions.

**ACCESSORIES** There are many microwave accessories available for purchase. Evaluate carefully before you purchase so that they meet your needs. A microwave-safe thermometer will assist you in determining correct doneness and assure you that foods have been cooked to safe temperatures. Sharp is not responsible for any damage to the oven when accessories are used.

Children should be taught all safety precautions: use potholders, remove coverings carefully, pay special attention to packages that crisp food because they may be extra hot.

Don't assume that because a child has mastered one cooking skill he/she can cook everything.

Children need to learn that the microwave oven is not a toy. See page 18 for Child Lock feature.

# PART NAMES

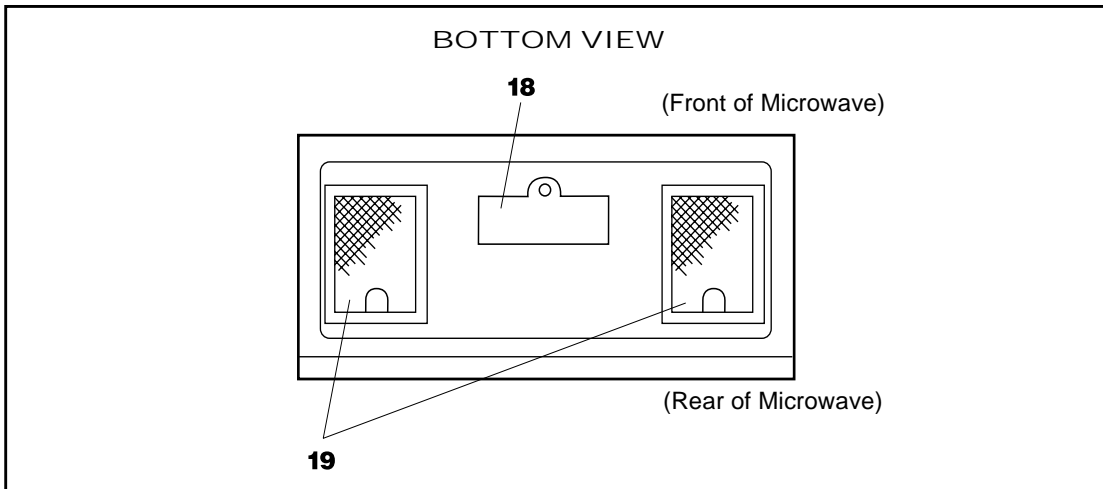
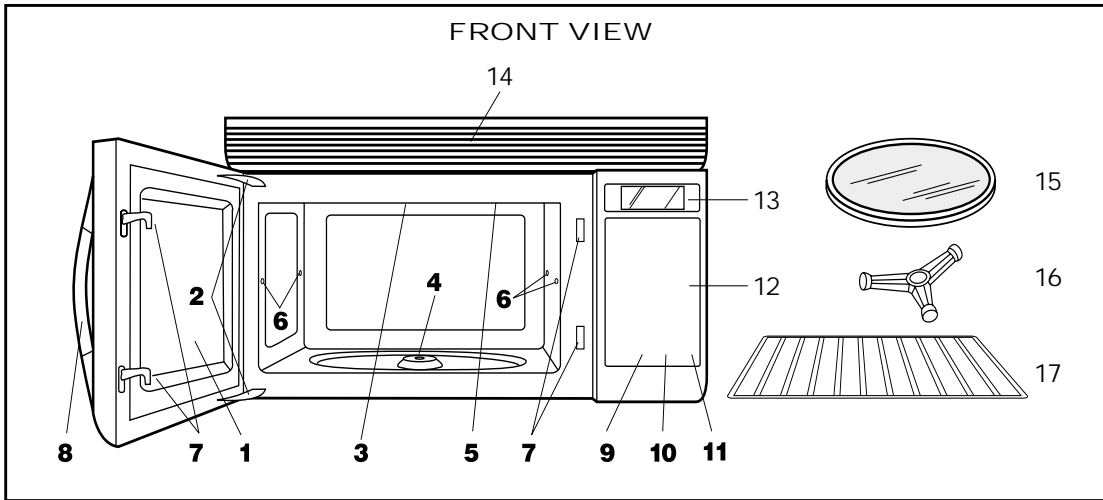

- |   |  |
|---|--|
| <p>1 Oven door with see-through window</p> <p>2 Door hinges</p> <p>3 Waveguide cover:<br/>DO NOT REMOVE.</p> <p>4 Turntable motor shaft</p> <p>5 Oven light<br/>It will light when oven is operating or door is open.</p> <p>6 Rack holders</p> <p>7 Safety door latches<br/>The oven will not operate unless the door is securely closed.</p> <p>8 Handle</p> <p>9 WORK LIGHT pad<br/>Press the WORK LIGHT pad to turn light on or off.</p> <p>10 NIGHT LIGHT pad<br/>Press the NIGHT LIGHT pad to turn light on or off.</p> | <p>11 FAN HI/LO pad<br/>Press the FAN HI/LO pad to turn on the fan. Press again for low speed. Press a third time to turn the fan off.</p> <p>12 Auto-Touch control panel</p> <p>13 Time display: Digital display, 99 minutes, 99 seconds</p> <p>14 Ventilation openings</p> <p>15 Removable turntable<br/>The turntable will rotate clockwise or counter-clockwise. Only remove for cleaning.</p> <p>16 Removable turntable support<br/>First, carefully place the turntable support in the motor shaft in the center of the oven floor. Then, place the turntable on the turntable support securely.</p> <p>17 Rack for 2-level cooking/reheating</p> <p>18 Light cover</p> <p>19 Grease filters</p> |
|---|--|

# TOUCH CONTROL PANEL

## R-1600 / R-1601 / R-1602

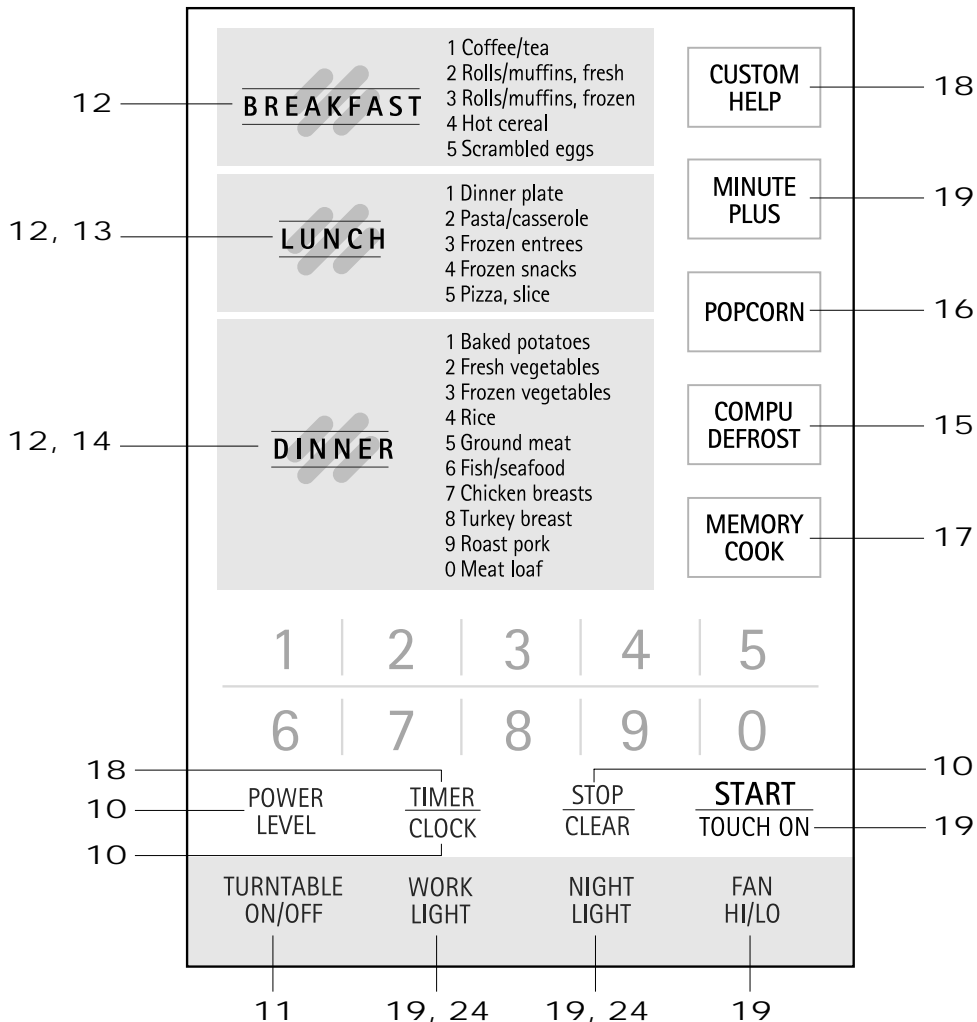

Number next to the control panel illustration indicates page on which there are a feature description and usage information.

### VISUAL DISPLAY









The 2-line, 16-digit Interactive Display spells out operating steps and shows cooking hints. When HELP is lighted in the display, touch the CUSTOM HELP pad to read a specific hint which may assist you.

# BEFORE OPERATING

- Before operating your new microwave oven make sure you read and understand this operation manual completely.
- Before the oven can be used, follow these procedures:
  1. Plug in the oven. Close the door. The oven display will show **SHARP** **SIMPLY** **THE** **BEST** **PRESS** **CLEAR** **AND** **PRESS** **CLOCK**.
  2. Touch the **Stop/Clear** pad. **:** will appear.
  3. Set clock.

## TO SET THE CLOCK

- Suppose you want to enter the correct time of day 12:30 (A.M. or P.M.).

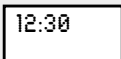
PROCEDURE	DISPLAY
1  Touch <b>TIMER/CLOCK</b> pad. Press number 2.	 
2     Enter the correct time of day by touching the numbers in sequence.	

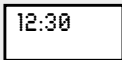
3    
Touch **TIMER/CLOCK** pad again.

This is a 12 hour clock. If you attempt to enter an incorrect clock time, **ERROR** will appear in the display. Touch the Stop/Clear pad and re-enter the time.

- If the electrical power supply to your microwave oven should be interrupted, the display will intermittently show **SHARP** **SIMPLY** **THE** **BEST** **PRESS** **CLEAR** **AND** **PRESS** **CLOCK** after the power is reinstated. If this occurs during cooking, the program will be erased. The time of day will also be erased. Simply touch STOP/CLEAR pad and reset the clock for the correct time of day.

**NOTE:** Your oven can be programmed with the door open except for START/TOUCH ON and MINUTE PLUS.

## STOP/CLEAR

Touch the Stop/Clear pad to:





1. Erase if you make a mistake during programming.
2. Cancel timer.
3. Stop the oven temporarily during cooking.
4. Return the time of day to the display.
5. Cancel a program during cooking, touch twice.

# MANUAL OPERATION

## TIME COOKING

Your oven can be programmed for 99 minutes 99 seconds (99.99). Always enter the seconds after the minutes, even if they are both zeros.

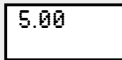
- Suppose you want to cook for 5 minutes at 100%.

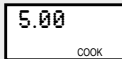
PROCEDURE	DISPLAY
1    Enter cooking time.	
2  Touch <b>START/TOUCH ON</b> pad.	

## TO SET POWER LEVEL

There are eleven preset power levels.

Using lower power levels increases the cooking time,

which is recommended for foods such as cheese, milk and long slow cooking of meats. Consult cookbook or recipes for specific recommendations.

TOUCH POWER LEVEL PAD ONCE THEN TOUCH	APPROXIMATE PERCENTAGE OF POWER	COMMON WORDS FOR POWER LEVELS
POWER LEVEL	100%	High
9	90%	
8	80%	
7	70%	Medium High
6	60%	
5	50%	Medium
4	40%	
3	30%	Med Low/Defrost
2	20%	
1	10%	Low
0	0%	

# MANUAL OPERATION

- Suppose you want to defrost for 5 minutes at 30%.

PROCEDURE	DISPLAY
1 <input type="text" value="5"/> <input type="text" value="0"/> <input type="text" value="0"/> Enter defrosting time.	<input type="text" value="5.00"/>
2 <input type="text" value="POWER LEVEL"/> <input type="text" value="3"/> Touch <b>POWER LEVEL</b> pad. Enter power level.	<input type="text" value="30 PERCENT"/>
3 <input type="text" value="START TOUCH ON"/> Touch <b>START/TOUCH ON</b> pad.	<input type="text" value="5.00 COOK"/>

## TURNTABLE ON/OFF

For most cooking, the turntable should be on; however the turntable can be turned off so that it does not rotate when extra large dishes, such as the popular 13 x 9 x 2 glass utility casserole, are used. The casserole should be placed on the turntable so that it is level.

- Suppose you want to cook lasagna in a 13 x 9 x 2 casserole for 45 minutes on 40% power.

PROCEDURE	DISPLAY
1 <input type="text" value="TURNTABLE ON/OFF"/> Touch <b>TURNTABLE ON/OFF</b> pad and note TURNTABLE OFF in the display.	<input type="text" value="TURN-TABLE OFF"/>
2 <input type="text" value="4"/> <input type="text" value="5"/> <input type="text" value="0"/> <input type="text" value="0"/> Enter cooking time.	<input type="text" value="45.00 TURNTABLE OFF"/>
3 <input type="text" value="POWER LEVEL"/> <input type="text" value="4"/> Touch <b>POWER LEVEL</b> pad. Enter number 4 for power level.	<input type="text" value="40 PERCENT TURNTABLE OFF"/>
4 <input type="text" value="START TOUCH ON"/> Touch <b>START/TOUCH ON</b> pad.	<input type="text" value="45.00 TURNTABLE OFF COOK"/>

## NOTE:

The door can be opened for checking food and the turntable will stay in the off position. After checking, close door and touch START/TOUCH ON.

The turntable will stay off for one minute after door is opened when time-of-day appears in the display. It is possible to reprogram the oven during that minute without touching the TURNTABLE ON/OFF pad. The display indicates when the turntable is off.

All special features can only be used with the turntable on. When the turntable is set in the off position, only manual operation can be used.

When cooking large quantities of food which cannot be stirred, it is best to use a lower power level such as 40 or 50%. You may speed cooking for large amounts by programming 5 to 10 minutes on 100% power (HIGH) followed by the desired time on lower power. See page 17 for how to program multiple sequences. You may wish to reverse a large casserole once during cooking; simply open door, reposition casserole, close door and touch START/TOUCH ON.

## USING THE RACK

The Rack allows several foods to be cooked or reheated at one time. However, for the best cooking and reheating, use *the turntable on and the automatic features*.

When using the Rack, set time and power level manually. Allow plenty of space around and between the dishes. Pay close attention to the cooking/reheating progress. Reposition the foods and reverse them from rack to turntable at least once during any cooking or reheating time. Using a lower power level will assist in better cooking/reheating uniformity.

## AVOID:









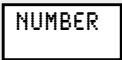

- Storing the Rack in the oven when not in use.
- Popping popcorn on the turntable with the Rack in the oven.
- Using any browning dish on the Rack.
- Using special features with the Rack. Special features are designed to be used with foods only on the revolving turntable.
- Cooking directly on the Rack—use microwave-safe cookware.

# SPECIAL FEATURES

## BREAKFAST/LUNCH/DINNER

BREAKFAST/LUNCH/DINNER will automatically compute the correct cooking time and microwave power level for foods shown in the following charts.

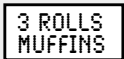
- Suppose you want to use BREAKFAST to reheat 3 regular size fresh muffins.

PROCEDURE	DISPLAY
1 	 
Touch <b>BREAKFAST</b> pad.	
2 	   
Touch number 2 for fresh rolls/muffins.	
3 	 
Enter number.	

4



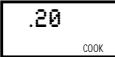

Touch **START/TOUCH ON** pad.  
After cooking, the display will indicate

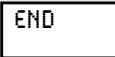

### NOTE:

1. BREAKFAST/LUNCH/DINNER can be programmed with More or Less Time Adjustment. See page 17. More or less food than the quantity listed in the charts should be cooked following the guidelines in any microwave cookbook.
2. Each food has a cooking hint. Touch CUSTOM HELP after step 2 above.
3. Should you attempt to enter more or less than the allowed amount, an error message will appear in the display.

## BREAKFAST CHART

FOOD	AMOUNT	PROCEDURE
1. Coffee/tea	1 - 4 cups	Use this setting to heat COLD TAP WATER to a temperature somewhat below the boiling point. Stir liquid briskly before and after heating to avoid "eruption". Then add the instant coffee or tea bag. Stir again.
2. Rolls/muffins, fresh	1 - 8	Use this setting to warm rolls, muffins, biscuits, bagels etc. Large items should be considered as 2 or 3 regular size. Arrange on plate with paper towel; cover with another towel.
3. Rolls/muffins, frozen	1 - 8	
4. Hot cereal	1 - 6 servings	Use individual packets or bulk cereal in your favorite variety: oatmeal, oat bran, cream of wheat, farina or wheatena.  Follow package directions for the correct amount of water or milk. To prevent boilovers, it is very important to choose a large container because microwave cooking of cereal causes high boiling. Stir half way through when preparing 3 or more servings. Stir after cooking.
5. Scrambled eggs	1 - 9 eggs	For each egg, use 1 teaspoon of butter or margarine and 1 tablespoon of milk. Place butter or margarine in dish, measuring cup or casserole large enough for the egg mixture to expand. Mix egg and milk together. Pour onto butter or margarine in dish. Place in oven and program. When audible signals are heard, stir egg mixture moving the cooked portion to the center of the dish and uncooked portion to the outside. After cooking, stir and let stand, covered, until set.  Note that eggs will be slightly undercooked when removed from the oven.

# SPECIAL FEATURES

## LUNCH CHART

FOOD	AMOUNT	PROCEDURE
1. Dinner plate		To reheat precooked foods from the refrigerator place meaty portions and bulky vegetables to outside of plate. Cut large items like baked potatoes in smaller pieces. Flatten dense foods such as mashed potatoes. Cover with wax paper or plastic wrap. <b>ONE PLATE ONLY.</b> After cooking, check that food is very hot throughout and that the bottom center of the plate is very hot. If not, continue heating using time and power level. Allow to stand, covered, 1 to 2 minutes.
	1 Regular	Touch LUNCH and then touch number 1 once for a regular amount of food: approximately 4 oz sliced meat or poultry, 1/2 cup potato or rice and 1/2 cup of vegetables or equivalent. <input type="text" value="REGULAR"/>
	1 Large	Touch LUNCH and then touch number 1 twice for a larger amount of food on a dinner plate. <input type="text" value="LARGE"/>
	1 Small	Touch LUNCH and then touch number 1 three times for a smaller amount of food on a dinner plate. <input type="text" value="SMALL"/>
2. Pasta/casserole	1 - 8 cups	Use this setting to reheat refrigerated, canned or homemade pasta with sauce or a prepared casserole with cooked ingredients. For pasta without sauce double the quantity per setting. For example, measure 2 cups of cooked noodles and program for 1 cup. Cover with lid or plastic wrap. After cooking, let stand, covered, 2 to 3 minutes.
3. Frozen entrees		Use this setting for frozen convenience foods. It will give satisfactory results for most brands. You may wish to try several and choose your favorite. Remove package from outer wrapping and follow package directions for covering. After cooking, let stand, covered for 1 to 3 minutes.
	6 - 8 oz	Touch LUNCH, number 3 and then touch number 3 once more for packages weighing 6-8 oz.
	9 - 11 oz	Touch LUNCH, number 3 and then touch number 3 twice more for packages weighing 9-11 oz.
	12 - 14 oz	Touch LUNCH, number 3 and then touch number 3 three more times for packages weighing 12-14 oz.
	15 - 17 oz	Touch LUNCH, number 3 and then touch number 3 four more times for packages weighing 15-17 oz.
4. Frozen snacks	3 - 6 oz	Can use frozen microwave pizza. Follow package directions for placing pizza on special crisping susceptor.
		For other snacks remove from outer package. Follow package directions for how to wrap or cover.
5. Pizza, slice	1 - 4	Use this setting to reheat refrigerated leftover pizza, 1 slice is approximately 1/8th of a 12-inch pizza or 1/12th of a 16-inch pizza. If possible, place on paper towel on a microwave-safe rack.

# SPECIAL FEATURES

## DINNER CHART

FOOD	AMOUNT	PROCEDURE															
1. Baked potatoes	1 - 6 med.	Pierce. Place on paper-towel-lined turntable. After cooking, remove from oven, wrap in aluminum foil and let stand 5 to 10 minutes.															
2. Fresh vegetables	1 - 6 cups	For beans, carrots, corn and peas, add 1 tablespoon of water per cup. For broccoli, Brussels sprouts, cabbage and cauliflower, cook immediately after washing with no additional water. If you like tender-crisp vegetables, double or triple measured quantity per setting. For example, use 2 cups or 3 cups of zucchini but touch number 1 when entering amount. After cooking, remove from oven, stir, cover and let stand 3 to 5 minutes before serving.															
3. Frozen vegetables	1 - 6 cups	Cover with lid or plastic wrap. After cooking, stir and let stand, covered, for 3 minutes.															
4. Rice	.5 - 2.0 cups	Place rice into a deep casserole and add double quantity of water. Cover with lid or plastic wrap. To enter amount, at Procedure 3 on page 12, touch number 4 for 1/2 cup increments up to 2 cups. After cooking, stir, cover and let stand 3 to 5 minutes or until all liquid has been absorbed. <table border="1" data-bbox="526 749 1177 909" style="margin-left: auto; margin-right: auto;"> <thead> <tr> <th>Rice</th> <th>Water</th> <th>Size of casserole</th> </tr> </thead> <tbody> <tr> <td>.5 cup</td> <td>1 cup</td> <td>1.5 quart</td> </tr> <tr> <td>1 cup</td> <td>2 cups</td> <td>2 quart</td> </tr> <tr> <td>1.5 cups</td> <td>3 cups</td> <td>2.5 or 3 quart</td> </tr> <tr> <td>2 cups</td> <td>4 cups</td> <td>3 quart or larger</td> </tr> </tbody> </table>	Rice	Water	Size of casserole	.5 cup	1 cup	1.5 quart	1 cup	2 cups	2 quart	1.5 cups	3 cups	2.5 or 3 quart	2 cups	4 cups	3 quart or larger
Rice	Water	Size of casserole															
.5 cup	1 cup	1.5 quart															
1 cup	2 cups	2 quart															
1.5 cups	3 cups	2.5 or 3 quart															
2 cups	4 cups	3 quart or larger															
5. Ground meat	.3 - 2.0 lb	Use this setting to cook ground beef or turkey as patties or in a casserole to be added to other ingredients. Place patties on a microwave-safe rack and cover with wax paper. Place ground meat in a casserole and cover with wax paper or plastic wrap. When oven stops, <table border="1" data-bbox="502 1064 831 1112" style="display: inline-table; vertical-align: middle;"> <tr> <td>TURN FOOD</td> <td>OVER</td> <td>OR STIR</td> </tr> </table> is displayed. Turn patties over or stir meat in casserole to break up large pieces. Re-cover and touch START/TOUCH ON. After cooking, let stand, covered, for 2 to 3 minutes.	TURN FOOD	OVER	OR STIR												
TURN FOOD	OVER	OR STIR															
6. Fish/seafood	.3 - 2.0 lb	Arrange in ring around shallow glass dish (roll fillet with edges underneath). Cover with vented plastic wrap. After cooking, let stand, covered for 3 minutes.															
7. Chicken breasts	.5 - 2.0 lb	Arrange boneless chicken breasts in glass dish or on microwave-safe rack. Cover with vented plastic wrap. After cooking, let stand, covered, 3-5 minutes. Chicken breasts should be 160°F.															
8. Turkey breast	3.0 - 6.0 lb	Arrange turkey breast with bone in glass dish or microwave-safe rack. Cover with vented plastic wrap. After cooking, let stand, covered, 3-5 minutes. Turkey breast should be 170°F.															
9. Roast pork	2.0 - 3.5 lb	Boneless pork loin is recommended because it cooks evenly. Place on a microwave-safe rack. Cover with vented plastic wrap. At signal, turn over. Shield with small, flat pieces of aluminum foil, any areas that are cooking too rapidly. Re-cover. After cooking, remove from oven, cover with foil and allow to stand 10 minutes. Internal temperature should be 160°F.															
0. Meat loaf	1.0 - 2.0 lb	Use your favorite recipe. Mix well and place in microwave-safe loaf dish. Cover with wax paper or vented plastic wrap. Enter weight of meat used in the recipe. After cooking, allow to stand, covered, for 5 minutes. Drain and serve.															









# SPECIAL FEATURES

## COMPU DEFROST

CompuDefrost automatically defrosts foods from the chart below.

- Suppose you want to defrost a 2.0 pound steak.

PROCEDURE	DISPLAY
<b>1</b>  x 3 Touch <b>COMPU DEFROST</b> pad once, then repeat 2 more times for Steak/chops or fish.	 
 Enter weight by touching the number pads 2 and 0. (Ex: 2.0 lb steak.)	
 Touch <b>START/TOUCH ON</b> pad.	
The oven will stop and directions will be displayed. Follow the indicated message.	

- 2** After the 1st stage, open the door. Turn steak over and shield any warm portions. Close the door.



Touch **START/TOUCH ON** pad.

- 3** After the 2nd stage, open the door. Shield any warm portions. Close the door.

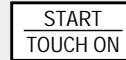

Touch **START/TOUCH ON** pad.

- 4** After defrost cycle ends, cover and let stand as indicated in chart below.

### NOTE:

1. CompuDefrost can be programmed with More or Less Time Adjustment. See page 17.
2. Each food has a defrosting hint. Touch CUSTOM HELP when HELP is indicated.
3. Should you attempt to enter more or less than the allowed amount, an error message will appear in the display.
4. To defrost other food or foods above or below the weights allowed on the chart below, use time and 30% power. See Manual Defrost on page 16.

## COMPU DEFROST CHART

FOOD	AMOUNT	PROCEDURE
1. Ground meat	.5 - 3.0 lb	Remove any thawed pieces after each stage. Let stand, covered, for 5 to 10 minutes.
2. Steak, chops or fish	.5 - 4.0 lb	After each stage, rearrange and if there are warm or thawed portions, shield with small flat pieces of aluminum foil. Remove any meat or fish that is almost defrosted. Let stand, covered, for 10 to 20 minutes.
3. Chicken pieces	.5 - 3.0 lb	AFTER EACH STAGE, REARRANGE PIECES OR REMOVE PORTIONS SHOULD THEY BECOME WARM OR THAWED. LET STAND, COVERED, FOR 10 TO 20 MINUTES.
4. Roast	2.0 - 4.0 lb	Start defrosting with fat side down. After each stage, turn roast over and shield the warm portions with aluminum foil. Let stand, covered, for 30 to 60 minutes.
5. Casserole	2 - 6 cups	After audible signal, stir if possible. At end, stir well and let stand, covered, for 5 to 10 minutes.
6. Soup	1 - 6 cups	After audible signal, stir if possible. At end, stir well and let stand, covered, for 5 to 10 minutes.

**NOTE:** Check foods when oven signals. After final stage, small sections may still be icy. Let stand to continue thawing. Do not defrost until all ice crystals are thawed.

Shielding prevents cooking from occurring before the center of the food is defrosted. Use small smooth strips of aluminum foil to cover edges and thinner sections of the food.

# SPECIAL FEATURES

## MANUAL DEFROST

If the food that you wish to defrost is not listed on the CompuDefrost Chart or is above or below the limits in the "Amount" column on the CompuDefrost Chart, you need to defrost manually.

You can defrost any frozen food, either raw or previously cooked, by using Power Level 3. Follow the exact 3-step procedure found under Time Cooking on page 11. Estimate defrosting time and press 3 for 30% when you select the power level.

For either raw or previously cooked frozen food the rule of thumb is approximately 4 minutes per pound. For

example, defrost 4 minutes for 1 pound of frozen spaghetti sauce.

Always stop the oven periodically to remove or separate the portions that are defrosted. If food is not defrosted at the end of the estimated defrosting time, program the oven in 1 minute increments on Power Level 3 until totally defrosted.

When using plastic containers from the freezer, defrost only long enough to remove from the plastic in order to place in a microwave-safe dish.

## POPCORN

- Suppose you want to pop a 3.5 oz bag of light microwave popcorn.

PROCEDURE	
<div style="border: 1px solid black; padding: 2px; display: inline-block;">POPCORN</div> x 2	Touch <b>POPCORN</b> pad twice for <div style="display: flex; justify-content: space-around; align-items: center;"> <div style="border: 1px solid black; padding: 2px; display: inline-block;">FOR LIGHT</div> <div style="border: 1px solid black; padding: 2px; display: inline-block;">REGULAR</div> </div> Touch <b>START/TOUCH ON</b> .

### NOTE:

1. To use POPCORN pad, touch within 1 minute after cooking, opening and closing the door or touching the STOP/CLEAR pad.
2. POPCORN can be programmed with More or Less Time Adjustment. See page 17.

AMOUNT	PROCEDURE
Only 1 package at a time.	Use only popcorn packaged for microwave oven use. Try several brands to decide which you like the best. Fresh popcorn works best so purchase only the amount used in a week or two. Do not try to pop unpopped kernels.
3.5 oz bag	Touch POPCORN once <div style="border: 1px solid black; padding: 2px; display: inline-block;">FOR REGULAR</div> then touch START/TOUCH ON pad.
3.0 or 3.5 oz bag (Light)	Touch POPCORN twice <div style="border: 1px solid black; padding: 2px; display: inline-block;">FOR LIGHT</div> <div style="border: 1px solid black; padding: 2px; display: inline-block;">REGULAR</div> then touch START/TOUCH ON pad.
1.75 oz bag	Touch POPCORN three times <div style="border: 1px solid black; padding: 2px; display: inline-block;">FOR SNACK</div> then touch START/TOUCH ON pad.
1.5 or 1.75 oz bag (Light)	Touch POPCORN four times <div style="border: 1px solid black; padding: 2px; display: inline-block;">FOR LIGHT</div> <div style="border: 1px solid black; padding: 2px; display: inline-block;">SNACK</div> then touch START/TOUCH ON pad.

# OTHER CONVENIENT FEATURES

## MULTIPLE SEQUENCE COOKING

Your oven can be programmed for up to 4 automatic cooking sequences, switching from one power level setting to another automatically.

Sometimes cooking directions tell you to start on one power level and then change to a different power level. Your oven can do this automatically.

- Suppose you want to cook roast beef for 5 minutes at 100% and then continue to cook for 30 minutes at 50%.

PROCEDURE									
1	First enter cooking time. Then touch <b>POWER LEVEL</b> pad twice for 100% power.								
	<table border="1"> <tr> <td>5</td> <td>0</td> <td>0</td> </tr> <tr> <td colspan="3">POWER LEVEL x 2</td> </tr> </table>	5	0	0	POWER LEVEL x 2				
5	0	0							
POWER LEVEL x 2									
2	Then enter second cooking time. Touch <b>POWER LEVEL</b> and number 5 pad for 50% power.								
	<table border="1"> <tr> <td>3</td> <td>0</td> <td>0</td> <td>0</td> </tr> <tr> <td colspan="3">POWER LEVEL</td> <td>5</td> </tr> </table>	3	0	0	0	POWER LEVEL			5
3	0	0	0						
POWER LEVEL			5						
3	Touch <b>START/ TOUCH ON</b> pad.								
	<table border="1"> <tr> <td>START</td> <td>TOUCH ON</td> </tr> </table>	START	TOUCH ON						
START	TOUCH ON								

### NOTE:

- If **POWER LEVEL** pad is touched twice, 

HIGH POWER
------------

 be displayed.
- If 100% is selected as the final sequence, it is not necessary to touch the **POWER LEVEL** pad.
- If you wish to know power level, simply touch the **POWER LEVEL** pad. As long as your finger is touching the **POWER LEVEL** pad, the power level will be displayed.

## MORE OR LESS TIME ADJUSTMENT

Should you discover that you like any of the Breakfast/Lunch/Dinner, CompuDefrost or Popcorn settings slightly **more** done, touch the **POWER LEVEL** pad once after touching your choice of pads. The display will show

MORE
------

PRESS START
-------------

 . Touch **START/TOUCH ON** pad.

Should you discover that you like any of the Breakfast/Lunch/Dinner, CompuDefrost or Popcorn settings slightly **less** done, touch the **POWER LEVEL** pad twice after touching your choice of pad. The display will show

LESS
------

PRESS START
-------------

 . Touch **START/TOUCH ON** pad.

## MEMORY COOK

### TO SET MEMORY COOK

Memory Cook allows you to set 1 set of cooking instructions in memory for quick recall.

- Suppose you want to program into Memory Cook your favorite cooking instructions for Nachos: 1 minute and 45 seconds at 70% power.

PROCEDURE	DISPLAY				
1	<table border="1"><tr><td>MEMORY COOK</td></tr></table> <table border="1"><tr><td>TO SET PRESS</td></tr></table> <table border="1"><tr><td>MEMORY COOK</td></tr></table>	MEMORY COOK	TO SET PRESS	MEMORY COOK	
MEMORY COOK					
TO SET PRESS					
MEMORY COOK					
	Touch <b>MEMORY COOK</b> pad.				
2	<table border="1"><tr><td>MEMORY COOK</td></tr></table> <table border="1"><tr><td>ENTER</td></tr></table> <table border="1"><tr><td>COOKING TIME</td></tr></table>	MEMORY COOK	ENTER	COOKING TIME	
MEMORY COOK					
ENTER					
COOKING TIME					
	Touch <b>MEMORY COOK</b> pad again.				
3	<table border="1"><tr><td>1</td><td>4</td><td>5</td></tr></table> <table border="1"><tr><td>1.45</td></tr></table>	1	4	5	1.45
1	4	5			
1.45					
	Enter cooking time.				
4	<table border="1"><tr><td>POWER LEVEL</td></tr></table> <table border="1"><tr><td>7</td></tr></table> <table border="1"><tr><td>70 PERCENT</td></tr></table>	POWER LEVEL	7	70 PERCENT	
POWER LEVEL					
7					
70 PERCENT					
	Touch <b>POWER LEVEL</b> pad. Enter number 7 for power level.				
	The display will show.				
	<table border="1"><tr><td>PRESS MEMORY</td></tr></table> <table border="1"><tr><td>COOK</td></tr></table>	PRESS MEMORY	COOK		
PRESS MEMORY					
COOK					
	<table border="1"><tr><td>TO SAVE PROGRAM</td></tr></table> <table border="1"><tr><td>IN MEMORY</td></tr></table>	TO SAVE PROGRAM	IN MEMORY		
TO SAVE PROGRAM					
IN MEMORY					
5	<table border="1"><tr><td>MEMORY COOK</td></tr></table> <table border="1"><tr><td>1.45</td></tr></table>	MEMORY COOK	1.45		
MEMORY COOK					
1.45					
	Touch <b>MEMORY COOK</b> pad.				
	Note: It is necessary to touch <b>MEMORY COOK</b> twice to enter the new program. Memory Cook can not be programmed with turntable off.				

### TO USE MEMORY COOK

- Suppose you want to cook Nachos with Memory Cook.

PROCEDURE	DISPLAY			
1	<table border="1"><tr><td>MEMORY COOK</td></tr></table> <table border="1"><tr><td>70 PERCENT</td></tr></table> <table border="1"><tr><td>1.45</td></tr></table>	MEMORY COOK	70 PERCENT	1.45
MEMORY COOK				
70 PERCENT				
1.45				
	Touch <b>MEMORY COOK</b> pad.			
2	<table border="1"><tr><td>START TOUCH ON</td></tr></table>	START TOUCH ON		
START TOUCH ON				
	Touch <b>START/ TOUCH ON</b> pad.			

# OTHER CONVENIENT FEATURES

## CUSTOM HELP

Custom Help provides 5 features which make using your oven easy because specific instructions are provided in the Interactive Display.

### 1. CHILD LOCK

The Child Lock prevents unwanted oven operation such as by small children. The oven can be set so that the control panel is deactivated or locked. To set, touch CUSTOM HELP, the number 1 and START/TOUCH ON. Should a pad be touched, will appear in the display.

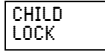

To cancel, touch CUSTOM HELP and STOP/CLEAR.

### 2. AUDIBLE SIGNAL ELIMINATION

If you wish to have the oven operate with no audible signals, touch CUSTOM HELP, the number 2 and STOP/CLEAR.

To cancel and restore the audible signal, touch CUSTOM HELP, the number 2 and START/TOUCH ON.

### 3. AUTO START

If you wish to program your oven to begin cooking automatically at a designated time of day, follow this procedure:

- Suppose you want to start cooking a stew for 20 minutes on 50% at 4:30. Before setting, check to make sure the clock is set correctly.

PROCEDURE	
1	Touch <b>CUSTOM HELP</b> pad.
2	Touch the number.
3	Enter the start time.
4	Touch <b>TIMER/CLOCK</b> pad.
5	Enter cooking program.
6	Touch <b>START/TOUCH ON</b> pad.

#### NOTE:

1. Auto Start can be used for manual cooking and Memory Cook (with turntable on only), if clock is set.

2. If the oven door is opened after programming Auto Start, it is necessary to touch the START/TOUCH ON pad for Auto Start time to appear in the readout so that the oven will automatically begin programmed cooking at the chosen Auto Start time.
3. Be sure to choose foods that can be left in the oven safely until the Auto Start time.
4. If you wish to know the time of day, simply touch the TIMER/CLOCK pad. As long as your finger is touching the pad, the time of day will be displayed.

### 4. & 5. LANGUAGE / WEIGHT SELECTION

The oven comes set for English and U.S. Customary Unit-pounds. To change, touch CUSTOM HELP and the number 4. Continue to touch the number 4 until your choice is selected from the table below. Then, touch START/TOUCH ON.

Touch number 4 for language and standard of weight.

NUMBER	LANGUAGE	STANDARD OF WEIGHT	DISPLAY
Once	English	LB	ENGLISH Lb
Twice	English	KG	ENGLISH KG
3 times	Spanish	LB	ESPAÑOL Lb
4 times	Spanish	KG	ESPAÑOL KG
5 times	French	LB	FRANC. Lb
6 times	French	KG	FRANC. KG

## KITCHEN TIMER

- Suppose you want to time a 3 minute long distance phone call.

PROCEDURE	DISPLAY
1  1	
Touch <b>TIMER/CLOCK</b> pad. Press number 1.	
2	
Enter time.	
3	Touch <b>TIMER/CLOCK</b> pad. The Kitchen Timer will count down.
4	After the Kitchen Timer cycle ends, the display will indicate the following message.

## OTHER CONVENIENT FEATURES

### TOUCH ON

Touch On allows you to cook at 100% power by touching the **START/TOUCH ON** continuously. Touch On is ideal for melting cheese, bringing milk to just below boiling etc. The maximum cooking time is 3 minutes.

- Suppose you want to melt cheese on toast.

#### PROCEDURE

- 1 Continuously touch **START/TOUCH ON** pad. The cooking time will begin counting up. 
- 2 When the cheese is melted to desired degree, remove finger from **START/TOUCH ON** pad. Oven stops immediately.

#### NOTE:

1. Note time it takes for frequently used foods and program that time in the future.
2. Touch **TOUCH ON** pad within 1 minute after cooking, opening and closing the door or touching the **STOP/CLEAR** pad.
3. **TOUCH ON** can only be used 3 times in a row. If more times are needed, open and close door or touch **STOP/CLEAR**.

### MINUTE PLUS

Minute Plus allows you to cook for a minute at 100% by simply touching the **MINUTE PLUS** pad. You can also extend cooking time in multiples of 1 minute by repeatedly touching the **MINUTE PLUS** pad during manual cooking.

- Suppose you want to heat a cup of soup for one minute.

#### PROCEDURE

- Touch **MINUTE PLUS** pad. 

#### NOTE:

1. To use **MINUTE PLUS**, touch pad within 1 minute after cooking, closing the door, touching the **STOP/CLEAR** pad or during cooking.
2. Minute Plus cannot be used with Special Features.

### DEMONSTRATION MODE

To demonstrate, touch **TIMER/CLOCK**, the number 0 and touch **START/TOUCH ON** and hold for 3 seconds.

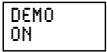
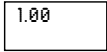
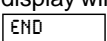
 will appear in the display. Cooking operations and specific special features can now be demonstrated with no power in the oven. For example, touch **STOP/CLEAR** and touch **MINUTE PLUS**, and the display will show  and count down quickly to .

To cancel, touch **TIMER/CLOCK**, then the number 0 and **STOP/CLEAR**. If easier, unplug the oven from the electrical outlet and replug.

### HELP

Each setting of Breakfast/Lunch/Dinner, CompuDefrost and Popcorn has a cooking hint. If you wish to check, touch **CUSTOM HELP** whenever **HELP** is lighted in the Interactive Display.

### WORK LIGHT

Press the **WORK LIGHT** pad one time to turn on and again to turn the light off.

### NIGHT LIGHT

Press the **NIGHT LIGHT** pad one time to turn on and again to turn the light off. This setting assures enough light to move about in a darkened kitchen.

### FAN

The fan will automatically start when heat rises from range surface units or burners. This protects the microwave oven from excessive temperature rise. The fan will stay on until the temperature decreases. It cannot be turned off manually during this time.

For other uses, press **FAN HI/LO** pad to select fan speed or turn fan off.

# REHEATING CHART

FOOD	STARTING TEMPERATURE	MICROWAVE TIME	PROCEDURE
<b>Meat</b> (Chicken pieces, chops, hamburgers, meat loaf slices) 1 serving 2 servings	Refrigerated Refrigerated	MED.-HIGH (70%) 1 - 2 min. 2 - 4 min.	Cover loosely with plastic wrap.
<b>Meat Slices</b> (Beef, ham, pork, turkey) 1 or more servings	Room temp. Refrigerated	MED. (50%) 1 - 1 3/4 min. per serving 1 1/2 - 2 1/2 min. per serving	Cover with gravy or wax paper. Check after 30 sec. per serving.
<b>Stirrable Casseroles and Main Dishes</b> 1 serving 2 servings 4-6 servings	Refrigerated Refrigerated Refrigerated	HIGH (100%) 1 3/4 - 3 1/2 min. 3 3/4 - 5 min. 6 1/2 - 7 1/2 min.	Cover with plastic wrap and stir after half the time.
<b>Nonstirrable Casseroles and Main Dishes</b> 1 serving 2 servings 4-6 servings	Refrigerated Refrigerated Refrigerated	MED. (50%) 4 1/2 - 7 1/2 min. 7 1/2 - 11 min. 12 - 15 min.	Cover with wax paper.
<b>Vegetables</b> 1 serving 2 servings	Refrigerated Refrigerated	HIGH (100%) 3/4 - 1 1/4 min. 1 1/2 - 2 min.	Cover. Stir after half the time.
<b>Baked Potato</b> 1 2	Refrigerated Refrigerated	HIGH (100%) 1 - 2 1/2 min. 2 1/2 - 3 min.	Cut potato lengthwise and then several times crosswise. Cover with wax paper.
<b>Pie</b> 1 slice 2 slices	Refrigerated Refrigerated	HIGH (100%) 30 - 45 sec. 1 - 1 1/2 min.	Place on microwave-safe dish. Do not cover.
After reheating, food should be very hot (165°F). If possible, stir food, cover and allow to stand two to three minutes before serving.			

# FISH AND SEAFOOD COOKING CHART

CUT	COOKING PREPARATION	MICROWAVE TIME	STANDING TIME
<b>FILLETS</b>	Pie plate or casserole. Cover with plastic wrap.	MED.-HIGH (70%) 4 - 6 min. per lb	3 min.
<b>STEAKS</b>	Pie plate or casserole. Cover with plastic wrap. Turn over halfway through cooking time.	MED.-HIGH (70%) 5 - 7 min. per lb	3 min.
<b>SHRIMP &amp; SCALLOPS</b>	Pie plate or casserole. Cover with plastic wrap. Turn over halfway through cooking time.	MED.-HIGH (70%) 4 - 6 min. per lb	1 - 2 min.

# SERVICE CALL CHECK

Please check the following before calling for service:

Place one cup of water in a glass measuring cup in the oven and close the door securely.  
Operate the oven for one minute at HIGH 100%.

- A Does the oven light come on? YES \_\_\_\_\_ NO \_\_\_\_\_
- B Does the cooling fan work? YES \_\_\_\_\_ NO \_\_\_\_\_  
(Put your hand on the louver above the Interactive Display.)
- C Does the turntable rotate? YES \_\_\_\_\_ NO \_\_\_\_\_  
(It is normal for the turntable to turn in either direction unless  
the display indicates   .)
- D Is the water in the oven warm? YES \_\_\_\_\_ NO \_\_\_\_\_

If "NO" is the answer to any of the above questions, please check electrical outlet, fuse and/or circuit breaker. If they are functioning properly, CONTACT YOUR NEAREST SHARP AUTHORIZED SERVICER. A microwave oven should never be serviced by a "do-it-yourself" repair person.

NOTE: If time appearing in the display is counting down very rapidly, check Demonstration Mode on page 19 and cancel.

## THE ULTIMATE ACCESSORY

- ✦ Great recipes
- ✦ Reliable microwave reference guide
- ✦ Many color photos
- ✦ Step-by-step instructions
- ✦ Nutritional information for each recipe
- ✦ Durable wipe-clean soft cover with 128 8 1/2 x 11 pages
- ✦ Helpful tips and special techniques

## SHARP® CAROUSEL MICROWAVE COOKBOOK

### TO ORDER

Simply call this toll-free number : **1-800-642-2122**.  
Please have your credit card ready.

If you prefer to order by mail, complete and return the order form on page 30. Please include check or money order (payable to Sharp Accessories & Supplies Center) for \$6.00 plus \$4.25 shipping & handling and tax, if applicable, per book.

### SATISFACTION GUARANTEED

You must be completely satisfied with the Sharp Carousel Microwave Cookbook. If, within 14 days, you are dissatisfied for any reason, simply return the book and we'll gladly refund your \$6.00 plus tax.

(SOLAMENTE ESCRITO EN INGLES!)

# SPECIFICATIONS

R-1600 / R-1601 / R-1602

AC Line Voltage:	Single phase 120V, 60Hz, AC only
AC Power Required:	1640W 14.0 amps.
Output Power:	1000W* (IEC Test Procedure)
Frequency:	2450 MHz
Outside Dimensions (not including handle):	29 <sup>15</sup> / <sub>16</sub> "(W) x 16 <sup>3</sup> / <sub>8</sub> "(H) x 16 <sup>15</sup> / <sub>16</sub> "(D)
Cavity Dimensions:	21"(W) x 8 <sup>7</sup> / <sub>8</sub> "(H) x 14 <sup>7</sup> / <sub>16</sub> "(D)
Oven Capacity:	1.6 Cu.Ft.
Cooking Uniformity:	Turntable / Stirrer Fan System
Weight:	Approx. (net) 55 lb, (gross) 60 lb
Work/Night Light:	2 bulbs 30w each (incandescent light bulbs)

★ The International Electrotechnical Commission's standardized method for measuring output wattage. This test method is widely recognized.

In compliance with standards set by:

**FCC** – Federal Communications Commission Authorized.

**DHHS** – Complies with Department of Health and Human Services (DHHS) rule, CFR, Title 21, Chapter I, Subchapter J.



– This symbol on the nameplate means the product is listed by Underwriters Laboratories, Inc.

----- Cut along this line. -----

## COOKBOOK ORDER FORM

Please send me \_\_\_\_\_ cookbooks at \$10.25 each \$ \_\_\_\_\_  
 Illinois sales tax, (if applicable) per book \$.44 no. of books \_\_\_\_\_ \$ \_\_\_\_\_  
 Other tax, (if applicable) no. of books \_\_\_\_\_ \$ \_\_\_\_\_

**TOTAL ORDER AMOUNT \$ \_\_\_\_\_**

I have enclosed a check made payable to Sharp Accessories & Supplies Center.

Please bill my  VISA  MASTERCARD  AMERICAN EXPRESS

Acct. No. \_\_\_\_\_ Expiration date \_\_\_\_ / \_\_\_\_

Signature \_\_\_\_\_

(All credit card orders must be signed.)

Name \_\_\_\_\_

Address \_\_\_\_\_

City \_\_\_\_\_ State \_\_\_\_\_ Zip \_\_\_\_\_

Daytime Phone No. ( ) \_\_\_\_\_

Mail to: SHARP Accessories & Supplies Center  
 2130 Townline Road  
 Peoria, Illinois 61615-1560

Price is subject to change without notice.



# CLEANING AND CARE

## Exterior

The outside surface is precoated steel and plastic. Clean the outside with mild soap and water; rinse and dry with a soft cloth. Do not use any type of household or abrasive cleaner.

## Door

Wipe the window on both sides with a damp cloth to remove any spills or splatters. Metal parts will be easier to maintain if wiped frequently with a damp cloth. Avoid the use of spray and other harsh cleaners as they may stain, streak or dull the door surface.

## Touch Control Panel

Care should be taken in cleaning the touch control panel. If the control panel becomes soiled, open the oven door before cleaning. Wipe the panel with a cloth dampened slightly with water only. Dry with a soft cloth. Do not scrub or use any sort of chemical cleaners. Close door and touch STOP/CLEAR.

## Interior

Cleaning is easy because little heat is generated to the interior surfaces; therefore, there is no baking and setting of spills or spattering. To clean the interior surfaces, wipe with a soft cloth and warm water. **DO NOT USE ABRASIVE OR HARSH CLEANERS OR SCOURING PADS.** For heavier soil, use baking soda or a mild soap; rinse thoroughly with hot water. The rack can be cleaned with hot soapy water, rinsed and dried.

## Waveguide Cover

The waveguide cover is located on the ceiling in the oven cavity. It is made from mica so requires special care. Keep the waveguide cover clean to assure good oven performance. Carefully wipe with a damp cloth any food splatters from the surface of the cover immediately after they occur. Built-up splashes may overheat and cause smoke or possibly catch fire. **DO NOT REMOVE THE WAVEGUIDE COVER.**

## Odor Removal

Occasionally, a cooking odor may remain in the oven. To remove, combine 1 cup water, grated peel and juice of 1 lemon and several whole cloves in a 2-cup glass measuring cup. Boil for several minutes using 100% power. Allow to set in oven until cool. Wipe interior with a soft cloth.

## Turntable/Turntable Support

The turntable and turntable support can be removed for easy cleaning. Wash them in mild, sudsy water; for stubborn stains use a mild cleanser and non-abrasive scouring sponge. They are also dishwasher-proof. Use upper rack of dishwasher. The turntable motor shaft is not sealed, so excess water or spills should be wiped up immediately.



Turntable

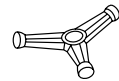

Turntable Support

## Grease Filters

Filters should be cleaned at least once a month. Never operate the fan or oven without the filters in place.

1. Pull down slightly on the tab toward the front of the oven and remove the filter. Repeat for the other filter.
2. Soak the filters in a sink or dish pan filled with hot water and detergent. **DO NOT** use ammonia or other alkali; they will react with the filter material and darken it.
3. Agitate and scrub with a brush to remove embedded dirt.
4. Rinse thoroughly and shake dry.
5. Replace by fitting the filter back into the opening.

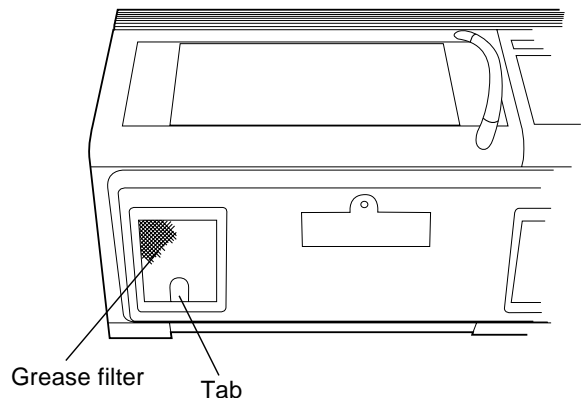

# REPLACING PARTS

## CHARCOAL FILTER

Charcoal Filter, Sharp Part number RK-230 which was enclosed with your oven, is used for nonvented, recirculated installation. The filter should be changed every 6 to 12 months depending on use. See page 4 for ordering information.

1. Disconnect power to the oven at the circuit breaker panel or by unplugging.
2. Remove the louver mounting screw from the top center of the louver and push down carefully on the tab at each end of the louver to disengage it. (See illustration.)
3. Pull the louver away from the unit.
4. Change the charcoal filter.
5. Carefully push the louver back into place (engaging both the bottom and top tabs) and replace the screw removed in step 2.

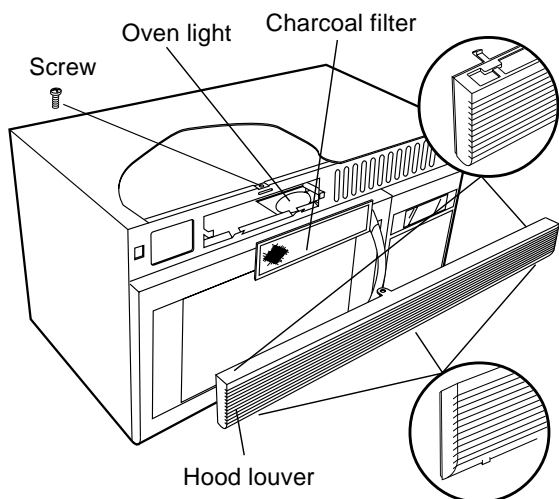

## OVEN LIGHT

Remove the louver per instructions 1-3 above and charcoal filter, if used.

1. To replace light bulb, first disconnect power to the oven at the circuit breaker panel or by unplugging.

2. Open light cover located behind filter mounting by carefully pulling up on the front edge.
3. Remove old light bulb and replace only with equivalent watt bulb available from a Sharp Authorized Servicer or parts distributor. Bulbs are also available at most hardware stores or lighting centers. **DO NOT USE BULB LARGER THAN 30 WATTS.**
4. Replace the oven light cover by carefully pushing into place. Replace the charcoal filter, if used. Push the louver back into place and replace the louver mounting screw.

## WORK LIGHT AND NIGHT LIGHT

1. To replace light bulbs, first disconnect power to the oven at the circuit breaker panel or by unplugging.
2. To release cover, remove the screw on the light cover. (See illustration.)
3. Replace light bulbs with equivalent watt bulb available from your Sharp Authorized Servicer or parts distributor. Bulbs are also available at most hardware stores or lighting centers. **DO NOT USE A BULB LARGER THAN 30 WATTS.**
4. Close light cover and secure with screw removed in step 2.

**CAUTION:** Light cover may become very hot. Do not touch glass when light is on.

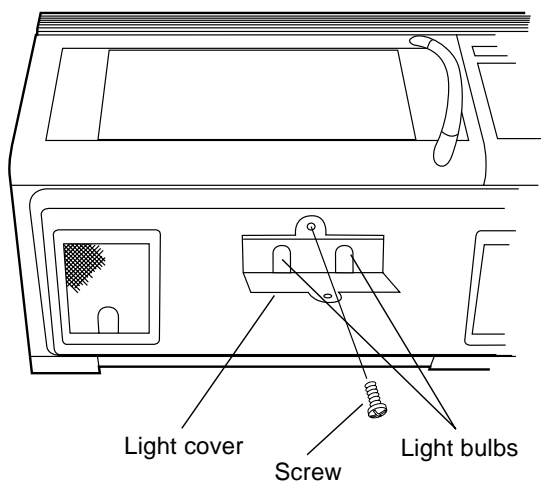

# GUIA AUTO-TOUCH<sup>MD</sup>

Para mayor información y precauciones de seguridad, consulte el Manual de Operaciones

<p><b>FIJACION DEL RELOJ</b></p> <p>Si en la pantalla aparece SHARP SIMPLY THE BEST PRESS CLEAR AND PRESS CLOCK pulse primero STOP/CLEAR.</p> <ol style="list-style-type: none"> <li>1. Pulse la tecla <b>TIMER/CLOCK</b>.</li> <li>2. Toque el botón 2.</li> <li>3. Programar la hora correcta pulsando los números en orden. (Ej.: 12:30)</li> <li>3. Pulse nuevamente la tecla <b>TIMER/CLOCK</b>.</li> </ol>	<p>TIMER CLOCK</p> <p>2</p> <p>1 2 3 0</p> <p>TIMER CLOCK</p>	<p><b>OPERACION MANUAL</b></p> <p><b>Cocinando con energía alta</b></p> <ol style="list-style-type: none"> <li>1. Programe el tiempo para cocinar tocando los botones numéricos. (ej.: 1 min. 30 seg.)</li> <li>2. Pulse la tecla <b>START/TOUCH ON</b>.</li> </ol> <p><b>Cocinando con energía variable</b></p> <ol style="list-style-type: none"> <li>1. Después del paso 1 anterior, pulse la tecla <b>POWER LEVEL</b>.</li> <li>2. Escoja el nivel de energía. (ej.: 50%)</li> <li>3. Pulse la tecla <b>START/TOUCH ON</b>.</li> </ol>	<p>1 3 0</p> <p>START TOUCH ON</p> <p>POWER LEVEL</p> <p>5</p> <p>START TOUCH ON</p>																																					
<p><b>BREAKFAST/LUNCH/DINNER</b></p> <ol style="list-style-type: none"> <li>1. Pulse la tecla <b>BREAKFAST</b>.</li> <li>2. Pulse la tecla del número de la comida deseada. (Ej.: toque el botón 2 para panecillo fresco.)</li> <li>3. Pulse la tecla de cantidad de piezas. (Ej.: toque el botón 3 para tres panecillos frescos.)</li> <li>4. Pulse la tecla <b>START/TOUCH ON</b>.</li> </ol>	<p>BREAKFAST</p> <p>2</p> <p>3</p> <p>START TOUCH ON</p>	<p><b>COMPU DEFROST</b></p> <ol style="list-style-type: none"> <li>1. Pulse la tecla <b>COMPU DEFROST</b> 3 veces.</li> <li>2. Toque los botones 2 y 0. (Ej.: filete de 2.0 libras)</li> <li>3. Pulse la tecla <b>START/TOUCH ON</b>.</li> </ol> <p>Cuando el microondas se para direcciones serán enseñadas. Siga el mens je indicado.</p>	<p>COMPU DEFROST x 3</p> <p>2 0</p> <p>START TOUCH ON</p>																																					
<p><b>TABLA BREAKFAST</b></p> <table border="1"> <thead> <tr> <th>NUMERO</th> <th>ALIMENTOS</th> <th>CANTIDAD</th> </tr> </thead> <tbody> <tr> <td>1.</td> <td>Café/té</td> <td>1 a 4 tazas</td> </tr> <tr> <td>2.</td> <td>Panecillo, fresco</td> <td>1 a 8</td> </tr> <tr> <td>3.</td> <td>Panecillo, congelado</td> <td>1 a 8</td> </tr> <tr> <td>4.</td> <td>Cereal caliente</td> <td>1 a 6 servidas</td> </tr> <tr> <td>5.</td> <td>Huevos revueltos</td> <td>1 a 9 huevos</td> </tr> </tbody> </table>	NUMERO	ALIMENTOS	CANTIDAD	1.	Café/té	1 a 4 tazas	2.	Panecillo, fresco	1 a 8	3.	Panecillo, congelado	1 a 8	4.	Cereal caliente	1 a 6 servidas	5.	Huevos revueltos	1 a 9 huevos	<p><b>TABLA COMPU DEFROST</b></p> <table border="1"> <thead> <tr> <th>NUMERO</th> <th>ALIMENTOS</th> <th>CANTIDAD</th> </tr> </thead> <tbody> <tr> <td>1.</td> <td>Carne molida</td> <td>.5 a 3.0 libras</td> </tr> <tr> <td>2.</td> <td>Filetes, chuletas, pescado</td> <td>.5 a 4.0 libras</td> </tr> <tr> <td>3.</td> <td>Piezas de pollo</td> <td>.5 a 3.0 libras</td> </tr> <tr> <td>4.</td> <td>Asar</td> <td>2.0 a 4.0 libras</td> </tr> <tr> <td>5.</td> <td>Cacerola</td> <td>2 a 6 tazas</td> </tr> <tr> <td>6.</td> <td>Sopa</td> <td>1 a 6 tazas</td> </tr> </tbody> </table>	NUMERO	ALIMENTOS	CANTIDAD	1.	Carne molida	.5 a 3.0 libras	2.	Filetes, chuletas, pescado	.5 a 4.0 libras	3.	Piezas de pollo	.5 a 3.0 libras	4.	Asar	2.0 a 4.0 libras	5.	Cacerola	2 a 6 tazas	6.	Sopa	1 a 6 tazas
NUMERO	ALIMENTOS	CANTIDAD																																						
1.	Café/té	1 a 4 tazas																																						
2.	Panecillo, fresco	1 a 8																																						
3.	Panecillo, congelado	1 a 8																																						
4.	Cereal caliente	1 a 6 servidas																																						
5.	Huevos revueltos	1 a 9 huevos																																						
NUMERO	ALIMENTOS	CANTIDAD																																						
1.	Carne molida	.5 a 3.0 libras																																						
2.	Filetes, chuletas, pescado	.5 a 4.0 libras																																						
3.	Piezas de pollo	.5 a 3.0 libras																																						
4.	Asar	2.0 a 4.0 libras																																						
5.	Cacerola	2 a 6 tazas																																						
6.	Sopa	1 a 6 tazas																																						
<p><b>TABLA LUNCH</b></p> <table border="1"> <thead> <tr> <th>NUMERO</th> <th>ALIMENTOS</th> <th>CANTIDAD</th> </tr> </thead> <tbody> <tr> <td>1.</td> <td>Plato principal</td> <td>1 plato de comida Reg., grande, chico</td> </tr> <tr> <td>2.</td> <td>Pasta/casserole</td> <td>1 a 8 tazas</td> </tr> <tr> <td>3.</td> <td>Platos congelado</td> <td>6 a 17 onzas</td> </tr> <tr> <td>4.</td> <td>Refrigerios congelado</td> <td>3 a 6 onzas</td> </tr> <tr> <td>5.</td> <td>Pizza</td> <td>1 a 4</td> </tr> </tbody> </table>	NUMERO	ALIMENTOS	CANTIDAD	1.	Plato principal	1 plato de comida Reg., grande, chico	2.	Pasta/casserole	1 a 8 tazas	3.	Platos congelado	6 a 17 onzas	4.	Refrigerios congelado	3 a 6 onzas	5.	Pizza	1 a 4	<p><b>POPCORN</b></p> <ol style="list-style-type: none"> <li>1. Pulse la tecla <b>POPCORN</b> una vez para un pqte. normal de maíz palomero dos veces para un pqte. normal ligero, 3 veces para un pqte. tamaño botana y 4 veces para uno tamaño botana ligero.</li> <li>2. Pulse la tecla <b>START/TOUCH ON</b>.</li> </ol>	<p>POPCORN</p> <p>START TOUCH ON</p>																				
NUMERO	ALIMENTOS	CANTIDAD																																						
1.	Plato principal	1 plato de comida Reg., grande, chico																																						
2.	Pasta/casserole	1 a 8 tazas																																						
3.	Platos congelado	6 a 17 onzas																																						
4.	Refrigerios congelado	3 a 6 onzas																																						
5.	Pizza	1 a 4																																						
<p><b>TABLA DINNER</b></p> <table border="1"> <thead> <tr> <th>NUMERO</th> <th>ALIMENTOS</th> <th>CANTIDAD</th> </tr> </thead> <tbody> <tr> <td>1.</td> <td>Papas Asada</td> <td>1 a 6 med.</td> </tr> <tr> <td>2.</td> <td>Vedura fresca</td> <td>1 a 6 tazas</td> </tr> <tr> <td>3.</td> <td>Vedura congelada</td> <td>1 a 6 tazas</td> </tr> <tr> <td>4.</td> <td>Arroz</td> <td>.5 a 2,0 tazas</td> </tr> <tr> <td>5.</td> <td>Carne molida</td> <td>.3 a 2,0 libras</td> </tr> <tr> <td>6.</td> <td>Filetes/chuletas, pescado</td> <td>.3 a 2,0 libras</td> </tr> <tr> <td>7.</td> <td>Pechugas de pollo</td> <td>.5 a 2,0 libras</td> </tr> <tr> <td>8.</td> <td>Pechuga de pavo</td> <td>3,0 a 6,0 libras</td> </tr> <tr> <td>9.</td> <td>Asado</td> <td>2,0 a 3,5 libras</td> </tr> <tr> <td>0.</td> <td>Torta de carne</td> <td>1,0 a 2,0 libras</td> </tr> </tbody> </table>	NUMERO	ALIMENTOS	CANTIDAD	1.	Papas Asada	1 a 6 med.	2.	Vedura fresca	1 a 6 tazas	3.	Vedura congelada	1 a 6 tazas	4.	Arroz	.5 a 2,0 tazas	5.	Carne molida	.3 a 2,0 libras	6.	Filetes/chuletas, pescado	.3 a 2,0 libras	7.	Pechugas de pollo	.5 a 2,0 libras	8.	Pechuga de pavo	3,0 a 6,0 libras	9.	Asado	2,0 a 3,5 libras	0.	Torta de carne	1,0 a 2,0 libras	<p><b>COCCION MANUAL</b></p> <p>Pulse la tecla <b>START/TOUCH ON</b> y manténgala presionada para cocinar a un 100% del nivel de energía. Al retirar el dedo del botón, el horno se detendrá instantáneamente.</p>	<p>START TOUCH ON</p> <p>MEMORY COOK x 2</p> <p>1 4 5</p> <p>POWER LEVEL</p> <p>7</p> <p>MEMORY COOK</p>					
NUMERO	ALIMENTOS	CANTIDAD																																						
1.	Papas Asada	1 a 6 med.																																						
2.	Vedura fresca	1 a 6 tazas																																						
3.	Vedura congelada	1 a 6 tazas																																						
4.	Arroz	.5 a 2,0 tazas																																						
5.	Carne molida	.3 a 2,0 libras																																						
6.	Filetes/chuletas, pescado	.3 a 2,0 libras																																						
7.	Pechugas de pollo	.5 a 2,0 libras																																						
8.	Pechuga de pavo	3,0 a 6,0 libras																																						
9.	Asado	2,0 a 3,5 libras																																						
0.	Torta de carne	1,0 a 2,0 libras																																						
<p><b>MINUTO EXTRA</b></p> <p>Pulse la tecla <b>MINUTE PLUS</b> para un minuto al 100% de energía o para añadir un minuto cuando cocine en el modo manual. Continúe tocándolo para añadir más minutos.</p>	<p>MINUTE PLUS</p>	<p><b>PARA PROGRAMAR MEMORY COOK</b></p> <ol style="list-style-type: none"> <li>1. Pulse la tecla <b>MEMORY COOK</b> dos veces y programe el tiempo de cocción. (Ej. Pulse el numero 1, 4 y 5 para 1 minuto y 45 segundos.)</li> <li>2. Pulse la tecla <b>POWER LEVEL</b> el botón numérico para el nivel deseado. (Ej. Pulse el numero 7 para 70%.)</li> <li>3. Pulse la tecla <b>MEMORY COOK</b>.</li> </ol> <p><b>PARA UTILIZAR MEMORY COOK</b></p> <ol style="list-style-type: none"> <li>1. Pulse la tecla <b>MEMORY COOK</b>. El nivel programado se mostrara en la pantalla.</li> <li>2. Pulse la tecla <b>START/TOUCH ON</b>.</li> </ol>	<p>MEMORY COOK</p> <p>START TOUCH ON</p>																																					

# AUTO-TOUCH® GUIDE

For more complete information and safety precautions, refer to your Operation Manual.

<p><b>SET CLOCK</b></p> <p>If SHARP SIMPLY THE BEST PRESS CLEAR AND PRESS CLOCK is in the display, first touch STOP/CLEAR.</p> <ol style="list-style-type: none"> <li>1. Touch <b>TIMER/CLOCK</b> pad.</li> <li>2. Press number 2 to set the clock.</li> <li>3. Enter correct time of the day by touching numbers in sequence (Ex: 12:30)</li> <li>4. Touch <b>TIMER/CLOCK</b> pad again.</li> </ol>	<p>TIMER CLOCK</p> <p>2</p> <p>1 2 3 0</p> <p>TIMER CLOCK</p>	<p><b>MANUAL OPERATION</b></p> <p><b>High Power Cooking</b></p> <ol style="list-style-type: none"> <li>1. Enter cooking time by touching number pads. (Ex: 1 min. 30 sec.)</li> <li>2. Touch <b>START/TOUCH ON</b> pad.</li> </ol> <p><b>Variable Power Cooking</b></p> <ol style="list-style-type: none"> <li>1. After Step 1 above, touch <b>POWER LEVEL</b> pad.</li> <li>2. Select power level. (Ex: 50%)</li> <li>3. Touch <b>START/TOUCH ON</b> pad.</li> </ol>	<p>1 3 0</p> <p>START TOUCH ON</p> <p>POWER LEVEL</p> <p>5</p> <p>START TOUCH ON</p>																																							
<p><b>BREAKFAST/LUNCH/DINNER</b></p> <ol style="list-style-type: none"> <li>1. Touch <b>BREAKFAST</b> pad.</li> <li>2. Touch desired food number. (Ex: touch number 2 for Rolls/muffins, fresh.)</li> <li>3. Touch number pad for quantity. (Ex: touch number 3 for three fresh rolls.)</li> <li>4. Touch <b>START/TOUCH ON</b> pad.</li> </ol>	<p>BREAKFAST</p> <p>2</p> <p>3</p> <p>START TOUCH ON</p>	<p><b>COMPU DEFROST</b></p> <ol style="list-style-type: none"> <li>1. Touch <b>COMPU DEFROST</b> pad three times.</li> <li>2. Touch number pads 2 and 0. (Ex: 2.0 lb steak)</li> <li>3. Touch <b>START/TOUCH ON</b>.</li> </ol> <p>The oven will stop and directions will be displayed. Follow the indicated message.</p>	<p>COMPU DEFROST</p> <p>x 3</p> <p>2 0</p> <p>START TOUCH ON</p>																																							
<p><b>BREAKFAST CHART</b></p> <table border="1"> <thead> <tr> <th>SETTING</th> <th>FOOD</th> <th>AMOUNT</th> </tr> </thead> <tbody> <tr> <td>1.</td> <td>Coffee/tea</td> <td>1 - 4 cups</td> </tr> <tr> <td>2.</td> <td>Rolls/muffins, fresh</td> <td>1 - 8</td> </tr> <tr> <td>3.</td> <td>Rolls/muffins, frozen</td> <td>1 - 8</td> </tr> <tr> <td>4.</td> <td>Hot cereal</td> <td>1 - 6 servings</td> </tr> <tr> <td>5.</td> <td>Scrambled eggs</td> <td>1 - 9 eggs</td> </tr> </tbody> </table>		SETTING	FOOD	AMOUNT	1.	Coffee/tea	1 - 4 cups	2.	Rolls/muffins, fresh	1 - 8	3.	Rolls/muffins, frozen	1 - 8	4.	Hot cereal	1 - 6 servings	5.	Scrambled eggs	1 - 9 eggs	<p><b>COMPU DEFROST CHART</b></p> <table border="1"> <thead> <tr> <th>SETTING</th> <th>FOOD</th> <th>AMOUNT</th> </tr> </thead> <tbody> <tr> <td>1.</td> <td>Ground meat</td> <td>.5 - 3.0 lb</td> </tr> <tr> <td>2.</td> <td>Steak, chops or fish</td> <td>.5 - 4.0 lb</td> </tr> <tr> <td>3.</td> <td>Chicken pieces</td> <td>.5 - 3.0 lb</td> </tr> <tr> <td>4.</td> <td>Roast</td> <td>2.0 - 4.0 lb</td> </tr> <tr> <td>5.</td> <td>Casserole</td> <td>2 - 6 cups</td> </tr> <tr> <td>6.</td> <td>Soup</td> <td>1 - 6 cups</td> </tr> </tbody> </table>		SETTING	FOOD	AMOUNT	1.	Ground meat	.5 - 3.0 lb	2.	Steak, chops or fish	.5 - 4.0 lb	3.	Chicken pieces	.5 - 3.0 lb	4.	Roast	2.0 - 4.0 lb	5.	Casserole	2 - 6 cups	6.	Soup	1 - 6 cups
SETTING	FOOD	AMOUNT																																								
1.	Coffee/tea	1 - 4 cups																																								
2.	Rolls/muffins, fresh	1 - 8																																								
3.	Rolls/muffins, frozen	1 - 8																																								
4.	Hot cereal	1 - 6 servings																																								
5.	Scrambled eggs	1 - 9 eggs																																								
SETTING	FOOD	AMOUNT																																								
1.	Ground meat	.5 - 3.0 lb																																								
2.	Steak, chops or fish	.5 - 4.0 lb																																								
3.	Chicken pieces	.5 - 3.0 lb																																								
4.	Roast	2.0 - 4.0 lb																																								
5.	Casserole	2 - 6 cups																																								
6.	Soup	1 - 6 cups																																								
<p><b>LUNCH CHART</b></p> <table border="1"> <thead> <tr> <th>SETTING</th> <th>FOOD</th> <th>AMOUNT</th> </tr> </thead> <tbody> <tr> <td>1.</td> <td>Dinner plate</td> <td>1 plate Reg., Large, Small</td> </tr> <tr> <td>2.</td> <td>Pasta/casserole</td> <td>1 - 8 cups</td> </tr> <tr> <td>3.</td> <td>Frozen entrees</td> <td>6 - 17 oz</td> </tr> <tr> <td>4.</td> <td>Frozen snacks</td> <td>3 - 6 oz</td> </tr> <tr> <td>5.</td> <td>Pizza, slice</td> <td>1 - 4</td> </tr> </tbody> </table>		SETTING	FOOD	AMOUNT	1.	Dinner plate	1 plate Reg., Large, Small	2.	Pasta/casserole	1 - 8 cups	3.	Frozen entrees	6 - 17 oz	4.	Frozen snacks	3 - 6 oz	5.	Pizza, slice	1 - 4	<p><b>MINUTE PLUS</b></p> <p>Touch MINUTE PLUS for one minute at 100% power or to add a minute during manual cooking. Continue to touch for additional minutes.</p>	<p>MINUTE PLUS</p>																					
SETTING	FOOD	AMOUNT																																								
1.	Dinner plate	1 plate Reg., Large, Small																																								
2.	Pasta/casserole	1 - 8 cups																																								
3.	Frozen entrees	6 - 17 oz																																								
4.	Frozen snacks	3 - 6 oz																																								
5.	Pizza, slice	1 - 4																																								
<p><b>DINNER CHART</b></p> <table border="1"> <thead> <tr> <th>SETTING</th> <th>FOOD</th> <th>AMOUNT</th> </tr> </thead> <tbody> <tr> <td>1.</td> <td>Baked potatoes</td> <td>1 - 6 med.</td> </tr> <tr> <td>2.</td> <td>Fresh vegetables</td> <td>1 - 6 cups</td> </tr> <tr> <td>3.</td> <td>Frozen vegetables</td> <td>1 - 6 cups</td> </tr> <tr> <td>4.</td> <td>Rice</td> <td>.5 - 2.0 cups</td> </tr> <tr> <td>5.</td> <td>Ground meat</td> <td>.3 - 2.0 lb</td> </tr> <tr> <td>6.</td> <td>Fish/seafood</td> <td>.3 - 2.0 lb</td> </tr> <tr> <td>7.</td> <td>Chicken breasts</td> <td>.5 - 2.0 lb</td> </tr> <tr> <td>8.</td> <td>Turkey breast</td> <td>3.0 - 6.0 lb</td> </tr> <tr> <td>9.</td> <td>Roast pork</td> <td>2.0 - 3.5 lb</td> </tr> <tr> <td>0.</td> <td>Meat loaf</td> <td>1.0 - 2.0 lb</td> </tr> </tbody> </table>		SETTING	FOOD	AMOUNT	1.	Baked potatoes	1 - 6 med.	2.	Fresh vegetables	1 - 6 cups	3.	Frozen vegetables	1 - 6 cups	4.	Rice	.5 - 2.0 cups	5.	Ground meat	.3 - 2.0 lb	6.	Fish/seafood	.3 - 2.0 lb	7.	Chicken breasts	.5 - 2.0 lb	8.	Turkey breast	3.0 - 6.0 lb	9.	Roast pork	2.0 - 3.5 lb	0.	Meat loaf	1.0 - 2.0 lb	<p><b>TOUCH ON</b></p> <p>Continuously touch START/TOUCH ON for 100% power cooking. Remove finger and oven will stop instantly.</p>	<p>START TOUCH ON</p>						
SETTING	FOOD	AMOUNT																																								
1.	Baked potatoes	1 - 6 med.																																								
2.	Fresh vegetables	1 - 6 cups																																								
3.	Frozen vegetables	1 - 6 cups																																								
4.	Rice	.5 - 2.0 cups																																								
5.	Ground meat	.3 - 2.0 lb																																								
6.	Fish/seafood	.3 - 2.0 lb																																								
7.	Chicken breasts	.5 - 2.0 lb																																								
8.	Turkey breast	3.0 - 6.0 lb																																								
9.	Roast pork	2.0 - 3.5 lb																																								
0.	Meat loaf	1.0 - 2.0 lb																																								
<p><b>POPCORN</b></p> <ol style="list-style-type: none"> <li>1. Touch <b>POPCORN</b> pad once for regular size, twice for light regular size, 3 times for snack size and 4 times for light snack size.</li> <li>2. Touch <b>START/TOUCH ON</b> pad.</li> </ol>	<p>POPCORN</p> <p>START TOUCH ON</p>	<p><b>MEMORY COOK</b></p> <p><b>TO SET MEMORY COOK</b></p> <ol style="list-style-type: none"> <li>1. Touch <b>MEMORY COOK</b> pad twice and enter cooking time. (Ex: touch number 1, 4 and 5 for 1 minute 45 seconds.)</li> <li>2. Touch <b>POWER LEVEL</b> and number pad for desired setting. (Ex: touch number 7 for 70%.)</li> <li>3. Touch <b>MEMORY COOK</b> pad.</li> </ol> <p><b>TO USE MEMORY COOK</b></p> <ol style="list-style-type: none"> <li>1. Touch <b>MEMORY COOK</b> pad. The stored settings will show on display.</li> <li>2. Touch <b>START/TOUCH ON</b> pad.</li> </ol>	<p>MEMORY COOK</p> <p>x 2</p> <p>1 4 5</p> <p>POWER LEVEL</p> <p>7</p> <p>MEMORY COOK</p> <p>MEMORY COOK</p> <p>START TOUCH ON</p>																																							

Carousel® and Auto-touch® are registered trademarks of Sharp Corporation.

**SHARP**

SHARP ELECTRONICS CORPORATION  
Sharp Plaza, Mahwah, NJ 07430-2135

TINSEB242MRRO

Download from [www.Somanuals.com](http://www.Somanuals.com). All Manuals Search And Download.



## Free Manuals Download Website

<http://myh66.com>

<http://usermanuals.us>

<http://www.somanuals.com>

<http://www.4manuals.cc>

<http://www.manual-lib.com>

<http://www.404manual.com>

<http://www.luxmanual.com>

<http://aubethermostatmanual.com>

Golf course search by state

<http://golfingnear.com>

Email search by domain

<http://emailbydomain.com>

Auto manuals search

<http://auto.somanuals.com>

TV manuals search

<http://tv.somanuals.com>