

Breakfast Bar

Lunch on the Run

MICROWAVE COOKING GUIDE

MODELS R-1610, R-1611, R-1612

One

Dish

Dinners

Sensor reheat

SuperDefrost

Baked potatoes

CompuDefrost

Frozen entrees

Beverage Center

Frozen snacks

Popcorn



SHARP[®]
Carousel[®]

FOR CUSTOMER ASSISTANCE

To aid in reporting this microwave oven in case of loss or theft, please record below the model number and serial number located on the unit. We also suggest you record all the information listed and retain for future reference.

MODEL NUMBER _____	SERIAL NUMBER _____
DATE OF PURCHASE _____	
DEALER _____	TELEPHONE _____
SERVICER _____	TELEPHONE _____

TO PHONE:

DIAL 1-800-BE-SHARP (237-4277) for :

SERVICE (for your nearest Sharp Authorized Servicer)

PARTS (for your authorized parts distributor)

ADDITIONAL CUSTOMER INFORMATION

DIAL 1-800-642-2122 for :

ACCESSORIES and COOKBOOK

DIAL (201)529-8703 for :

COOKING ASSISTANCE

TO WRITE:

For cooking and operation questions:

Susan Edwards/Test Kitchen

Sharp Electronics Corporation

Sharp Plaza, Box 650

Mahwah, NJ 07430-2135

For service problems, warranty information, missing items and other assistance:

Sharp Electronics Corporation

Customer Assistance Center

1300 Naperville Drive

Romeoville, IL 60446-1091

Please provide the following information when you write or call: model number, serial number, date of purchase, your complete mailing address (including zip code), your daytime telephone number (including area code) and description of the problem.

TO ACCESS INTERNET: www.sharp-usa.com

PRECAUTIONS TO AVOID POSSIBLE EXPOSURE TO EXCESSIVE MICROWAVE ENERGY

- (a) Do not attempt to operate this oven with the door open since open-door operation can result in harmful exposure to microwave energy. It is important not to defeat or tamper with the safety interlocks.
- (b) Do not place any object between the oven front face and the door or allow soil or cleaner residue to accumulate on sealing surfaces.
- (c) Do not operate the oven if it is damaged. It is particularly important that the oven door close properly and that there is no damage to the: (1) door (bent), (2) hinges and latches (broken or loosened), (3) door seals and sealing surfaces.
- (d) The oven should not be adjusted or repaired by anyone except properly qualified service personnel.

CONTENTS

For Customer Assistance....	Inside Front Cover	2. Lunch on the Run	18
Precautions to Avoid Possible		Lunch on the Run Chart	18-19
Exposure to Excessive		3. One Dish Dinners	19
Microwave Energy	Inside Front Cover	One Dish Dinners Recipes	19-21
Contents	1	4. SuperDefrost	21
Consumer Limited Warranty	2	SuperDefrost Chart	21-22
Product Information Card	2	5. CompuDefrost	21
Important Safety Instructions	3	CompuDefrost Chart	22-23
Unpacking Instructions	4	6. Beverage Center	23
Optional Accessories	4	Beverage Center Chart	23
Grounding Instructions	4	Other Convenient Features	24-26
Information You Need to Know	5-7	Multiple Sequence Cooking	24
About Your Oven	5	More or Less Time Adjustment	24
About Food	5	Memory Cook.....	24
About Utensils and Coverings	6	Custom Help	25
About Children and the Microwave	6	1. Child Lock	25
About Microwave Cooking	7	2. Audible Signal Elimination	25
About Safety	7	3. Auto Start.....	25
Part Names	8	4. & 5. Language/Weight Selection	25
Touch-Control Panel	9	Kitchen Timer.....	25
Before Operating	10	Touch On	26
To Set the Clock	10	Minute Plus	26
Stop/Clear	10	Demonstration Mode	26
Manual Operation	10-11	Help	26
Time Cooking	10	Work Light	26
To Set Power Level	10-11	Night Light	26
Turntable On/Off	11	Fan Hi/Lo	26
Using the Rack.....	11	Auto Fan	26
Manual Defrost.....	11	Cleaning and Care	27
Special Features	12-23	Replacing Parts	28
Sensor Cooking	12	Specifications	29
Sensor Reheat	12	THE ULTIMATE ACCESSORY	29
Sensor Reheat Chart	12	Service Call Check	30
Other Sensor Cooking Settings	13	Cookbook Order Form	30
Sensor Cooking Chart	13-14	Guia Auto-Touch	31-32
Sensor Cooking Recipes	14-16	Auto-Touch Guide.	33-Back Cover
More From Your Microwave	17-23		
1. Breakfast Bar	17		
Breakfast Bar Chart	17-18		

INTERACTIVE COOKING SYSTEM

The Interactive Cooking System with 2-line, 16-digit display offers step-by-step instructions for using the oven, from setting the clock to programming each feature. It also includes Custom Help for instructions on using Child Lock, Audible Signal Elimination and Auto Start. There is a choice of English, Spanish or French and a choice of U.S. Customary Unit-pound or Metric-kilograms. Touch CUSTOM HELP and follow the directions displayed or check page 25.

CONSUMER LIMITED WARRANTY

SHARP ELECTRONICS CORPORATION warrants to the first consumer purchaser that this Sharp brand product (the "Product"), when shipped in its original container, will be free from defective workmanship and materials, and agrees that it will, at its option, either repair the defect or replace the defective Product or part thereof with a new or remanufactured equivalent at no charge to the purchaser for parts or labor for the period(s) set forth below.

This warranty does not apply to any appearance items of the Product nor to the additional excluded item(s) set forth below nor to any Product the exterior of which has been damaged or defaced, which has been subjected to misuse, abnormal service or handling, or which has been altered or modified in design or construction.

In order to enforce the rights under this limited warranty, the purchaser should follow the steps set forth below and provide proof of purchase to the servicer.

The limited warranty described herein is in addition to whatever implied warranties may be granted to purchasers by law. ALL IMPLIED WARRANTIES INCLUDING THE WARRANTIES OF MERCHANTABILITY AND FITNESS FOR USE ARE LIMITED TO THE PERIOD(S) FROM THE DATE OF PURCHASE SET FORTH BELOW. Some states do not allow limitations on how long an implied warranty lasts, so the above limitation may not apply to you.

Neither the sales personnel of the seller nor any other person is authorized to make any warranties other than those described herein, or to extend the duration of any warranties beyond the time period described above on behalf of Sharp.

The warranties described herein shall be the sole and exclusive warranties granted by Sharp and shall be the sole and exclusive remedy available to the purchaser. Correction of defects, in the manner and for the period of time described herein, shall constitute complete fulfillment of all liabilities and responsibilities of Sharp to the purchaser with respect to the Product, and shall constitute full satisfaction of all claims, whether based on contract, negligence, strict liability or otherwise. In no event shall Sharp be liable, or in any way responsible, for any damages or defects in the Product which were caused by repairs or attempted repairs performed by anyone other than an authorized servicer. Nor shall Sharp be liable or in any way responsible for any incidental or consequential economic or property damage. Some states do not allow the exclusion of incidental or consequential damages, so the above exclusion may not apply to you.

THIS WARRANTY GIVES YOU SPECIFIC LEGAL RIGHTS. YOU MAY ALSO HAVE OTHER RIGHTS WHICH VARY FROM STATE TO STATE.

Your Product Model Number & Description:

R-1610, R-1611 and R-1612 Home Use Carousel Microwave Oven.
(Be sure to have this information available when you need service for your Product.)

Warranty Period for this Product:

One (1) year parts and labor in-home service. The warranty period continues for an additional six (6) years, for a total of seven (7) years, with respect to the magnetron tube in the Product for parts only. Labor and the servicer trip charge are not provided free of charge for this additional period.

Additional Item(s) Excluded from Warranty Coverage (if any):

Non-functional accessories, turntable and light bulbs.

Where to Obtain Service:

From a Sharp Authorized Servicer located In the United States. Be sure to have **Proof of Purchase** available. For in-home service, the servicer will come to the unit's location. If it is necessary to remove the unit for repair, the servicer will reinstall the unit at no extra charge, provided it was installed according to Sharp's Installation Instructions. To find the location of the nearest Sharp Authorized Servicer, call Sharp toll free at 1-800-BE-SHARP (1-800-237-4277).

TO OBTAIN SUPPLY, ACCESSORY OR PRODUCT INFORMATION, CALL 1-800-BE-SHARP OR VISIT www.sharp-usa.com.
SAVE THE PROOF OF PURCHASE AS IT IS NEEDED SHOULD YOUR OVEN EVER REQUIRE WARRANTY SERVICE.

PRODUCT INFORMATION CARD

The product information card should be completed within ten days of purchase and returned. We will keep it on file and help you access the information in case of loss, damage or theft. This will also enable us to contact you in the unlikely event that any adjustments or modifications are ever required for your oven.

IMPORTANT SAFETY INSTRUCTIONS

When using electrical appliances basic safety precautions should be followed, including the following:

WARNING - To reduce the risk of burns, electric shock, fire, injury to persons or exposure to excessive microwave energy:

1. Read all instructions before using the appliance.
2. Read and follow the specific **“PRECAUTIONS TO AVOID POSSIBLE EXPOSURE TO EXCESSIVE MICROWAVE ENERGY”** on inside front cover.
3. This appliance must be grounded. Connect only to properly grounded outlet. See **“GROUNDING INSTRUCTIONS”** on page 4 and **INSTALLATION INSTRUCTIONS**.
4. Install or locate this appliance only in accordance with the provided installation instructions.
5. Some products such as whole eggs and sealed containers—for example, closed glass jars—may explode and should not be heated in this oven.
6. Use this appliance only for its intended use as described in this manual. Do not use corrosive chemicals or vapors in this appliance. This type of oven is specifically designed to heat, cook or dry food. It is not designed for industrial or laboratory use.
7. As with any appliance, close supervision is necessary when used by children.
8. Do not operate this appliance if it has a damaged cord or plug, if it is not working properly or if it has been damaged or dropped.
9. This appliance should be serviced only by qualified service personnel. Contact nearest Sharp Authorized Servicer for examination, repair or adjustment.
10. Do not cover or block any openings on the appliance.
11. Do not store or use this appliance outdoors. Do not use this product near water—for example, near a kitchen sink, in a wet basement or near a swimming pool, and the like.
12. Do not immerse cord or plug in water.
13. Keep cord away from heated surfaces.
14. Do not let cord hang over edge of table or counter.
15. See door surface cleaning instructions on page 27.
16. To reduce the risk of fire in the oven cavity:
 - a. Do not overcook food. Carefully attend appliance if paper, plastic or other combustible materials are placed inside the oven to facilitate cooking.
 - b. Remove wire twist-ties from paper or plastic bags before placing bag in oven.
 - c. **If materials inside the oven should ignite, keep oven door closed, turn oven off and disconnect the power cord or shut off power at the fuse or circuit breaker panel.**
 - d. Do not use the cavity for storage purposes. Do not leave paper products, cooking utensils or food in the cavity when not in use.
17. Clean ventilation openings and grease filters frequently—Grease should not be allowed to accumulate on ventilation openings, hood (louver) or grease filters.
18. Use care when cleaning the louver and the grease filters. Corrosive cleaning agents, such as lye-based oven cleaners, may damage the louver and the grease filters.
19. When flaming foods under the hood, turn the fan on.
20. This appliance is suitable for use above both gas and electric cooking equipment 36" wide or less.

SAVE THESE INSTRUCTIONS

UNPACKING INSTRUCTIONS

Unpacking and Examining Your Oven

Carefully remove oven from carton. Be sure to remove the turntable support and place it in the oven. **SAVE THE CARTON AS IT MAY MAKE INSTALLATION EASIER.**

Remove:

1. all packing materials from inside the oven cavity; however, **DO NOT REMOVE THE WAVEGUIDE COVER**, which is located on the ceiling in the oven cavity. Check to see that there are Installation Instructions, Wall Template, Top Template and RK-230 Charcoal Filter, which is used when recirculating is chosen. Read enclosures and **SAVE** the Operation Manual.
2. the feature sticker from the outside of the door, if there is one.

Check the oven for any damage, such as misaligned or bent door, damaged door seals and sealing surfaces, broken or loose door hinges and latches and dents inside the cavity or on the door. If there is any damage, do not operate the oven and contact your dealer or SHARP AUTHORIZED SERVICER.

See Installation Instructions for more details.

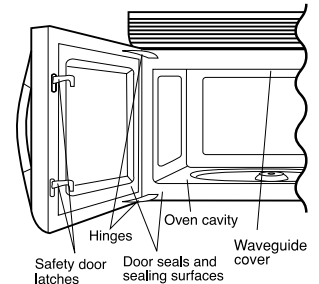

OPTIONAL ACCESSORIES

Two optional accessories are available for this oven.

1. Charcoal Filter (RK-230). The filter packed in the oven is required when hood exhaust is recirculated. See Charcoal Filter on page 28. To purchase replacement Charcoal Filter, check with dealer or call 1-800-642-2122. Have credit card ready.
2. Filler Panel Kit. For use when the oven is installed in a 36-inch or 42-inch wide opening. The metal filler panels come in 3-inch wide pairs. One set is needed for a 36-inch opening and 2 sets for a 42-inch opening. White and black are available.

To purchase contact: Modern-Aire Ventilating Corporation
7319 Lankershim Blvd.
North Hollywood, CA 91605
Phone: (818) 765-9870
Fax: (818) 765-4916

GROUNDING INSTRUCTIONS

This appliance must be grounded. This oven is equipped with a cord having a grounding wire with a grounding plug. It must be plugged into a wall receptacle that is properly installed and grounded in accordance with the National Electrical Code and local codes and ordinances. In the event of an electrical short circuit, grounding reduces risk of electric shock by providing an escape wire for the electric current.

WARNING – Improper use of the grounding plug can result in a risk of electric shock.

Electrical Requirements

Check Installation Instructions for proper location for the power supply.

The electrical requirements are a 120 volt 60 Hz, AC only, 15 amp. or more protected electrical supply. It is recommended that a separate circuit serving only the oven be provided.

The oven is equipped with a 3-prong grounding plug. It must be plugged into a wall receptacle that is properly installed and grounded. **DO NOT UNDER ANY CIRCUMSTANCES CUT OR REMOVE THE GROUNDING PIN FROM THE PLUG.**

Notes: 1. If you have any questions about the grounding or electrical instructions, consult a qualified electrician or service person.

2. Neither Sharp nor the dealer can accept any liability for damage to the oven or personal injury resulting from failure to observe the correct electrical connection procedures.

Radio or TV Interference

Should there be any interference caused by the microwave oven to your radio or TV, check that the microwave oven is on a different electrical circuit, relocate the radio or TV as far away from the oven as feasible or check position and signal of receiving antenna.

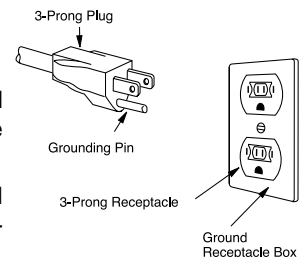

INFORMATION YOU NEED TO KNOW

ABOUT YOUR OVEN

This Operation Manual is valuable: read it carefully and always save it for reference.

A good microwave cookbook is a valuable asset. Check it for microwave cooking principles, techniques, hints and recipes. See pages 29 and 30 for ordering the Ultimate Accessory, the SHARP CAROUSEL MICROWAVE COOKBOOK.

NEVER use the oven without the turntable and support nor turn the turntable over so that a large dish could be placed in the oven. The turntable will turn both clockwise and counterclockwise. See page 11 for complete instructions.

ALWAYS have food in the oven when it is on to absorb the microwave energy.

When using the oven at power levels below 100%, you may hear the magnetron cycling on and off. It is normal

for the exterior of the oven to be warm to the touch when cooking or reheating.

Condensation is a normal part of microwave cooking. Room humidity and the moisture in food will influence the amount of moisture that condenses in the oven. Generally, covered foods will not cause as much condensation as uncovered ones. Ventilation openings must not be blocked.

The oven is for food preparation only. It should not be used to dry clothes or newspapers.

Your oven is rated 1000 watts by using the IEC Test Procedure. In using recipes or package directions, check food a minute or two before the minimum time and add time accordingly.

ABOUT FOOD

FOOD	DO	DON'T
Eggs, sausages, fruits & vegetables	<ul style="list-style-type: none">• Puncture egg yolks before cooking to prevent "explosion".• Pierce skins of potatoes, apples, squash, hot dogs and sausages so that steam escapes.	<ul style="list-style-type: none">• Cook eggs in shells.• Reheat whole eggs.• Dry nuts or seeds in shells.
Popcorn	<ul style="list-style-type: none">• Use specially bagged popcorn for the microwave oven.• Listen while popping corn for the popping to slow to 1 or 2 seconds or use special Popcorn pad.	<ul style="list-style-type: none">• Pop popcorn in regular brown bags or glass bowls.• Exceed maximum time on popcorn package.
Baby food	<ul style="list-style-type: none">• Transfer baby food to small dish and heat carefully, stirring often. Check temperature before serving.• Put nipples on bottles after heating and shake thoroughly. "Wrist" test before feeding.	<ul style="list-style-type: none">• Heat disposable bottles.• Heat bottles with nipples on.• Heat baby food in original jars.
General	<ul style="list-style-type: none">• Cut baked goods with filling after heating to release steam and avoid burns.• Stir liquids briskly before and after heating to avoid "eruption".• Use deep bowl, when cooking liquids or cereals, to prevent boilovers.	<ul style="list-style-type: none">• Heat or cook in closed glass jars or air tight containers.• Can in the microwave as harmful bacteria may not be destroyed.• Deep fat fry.• Dry wood, gourds, herbs or wet papers.

ABOUT UTENSILS AND COVERINGS

It is not necessary to buy all new cookware. Many pieces already in your kitchen can be used successfully in your new microwave oven. Make sure the utensil does not touch the interior walls during cooking.

Use these utensils for safe microwave cooking and reheating:

- glass ceramic (Pyroceram®), such as Corningware®.
- heat-resistant glass (Pyrex®)
- microwave-safe plastics
- paper plates
- microwave-safe pottery, stoneware and porcelain
- browning dish (Do not exceed recommended preheating time. Follow manufacturer's directions.)

These items can be used for short time reheating of foods that have little fat or sugar in them:

- wood, straw, wicker

DO NOT USE

- metal pans and bakeware
- dishes with metallic trim
- non-heat-resistant glass
- non-microwave-safe plastics (margarine tubs)
- recycled paper products
- brown paper bags
- food storage bags
- metal twist-ties

Should you wish to check if a dish is safe for microwaving, place the empty dish in the oven and microwave on HIGH for 30 seconds. A dish which becomes very hot should not be used.

ABOUT CHILDREN AND THE MICROWAVE

Children below the age of 7 should use the microwave oven with a supervising person very near to them. Between the ages of 7 and 12, the supervising person should be in the same room.

The child must be able to reach the oven comfortably; if not, he/she should stand on a sturdy stool.

At no time should anyone be allowed to lean or swing on the oven door.

The following coverings are ideal:

- Paper towels are good for covering foods for reheating and absorbing fat while cooking bacon.
- Wax paper can be used for cooking and reheating.
- Plastic wrap that is specially marked for microwave use can be used for cooking and reheating. DO NOT allow plastic wrap to touch food. Vent so steam can escape.
- Lids that are microwave-safe are a good choice because heat is kept near the food to hasten cooking.
- Oven cooking bags are good for large meats or foods that need tenderizing. DO NOT use metal twist ties. Remember to slit bag so steam can escape.

How to use aluminum foil in your microwave oven:

- Small flat pieces of aluminum foil placed smoothly on the food can be used to shield areas that are either defrosting or cooking too quickly.
- Foil should not come closer than one inch to any surface of the oven.

Should you have questions about utensils or coverings, check a good microwave cookbook or follow recipe suggestions.

ACCESSORIES There are many microwave accessories available for purchase. Evaluate carefully before you purchase so that they meet your needs. A microwave-safe thermometer will assist you in determining correct doneness and assure you that foods have been cooked to safe temperatures. Sharp is not responsible for any damage to the oven when accessories are used.

Children should be taught all safety precautions: use potholders, remove coverings carefully, pay special attention to packages that crisp food because they may be extra hot.

Don't assume that because a child has mastered one cooking skill he/she can cook everything.

Children need to learn that the microwave oven is not a toy. See page 25 for Child Lock feature.

ABOUT MICROWAVE COOKING

- Arrange food carefully. Place thickest areas towards outside of dish.
- Watch cooking time. Cook for the shortest amount of time indicated and add more as needed. Food severely overcooked can smoke or ignite.
- Cover foods while cooking. Check recipe or cookbook for suggestions: paper towels, wax paper, microwave plastic wrap or a lid. Covers prevent spattering and help foods to cook evenly.
- Shield with small flat pieces of aluminum foil any thin areas of meat or poultry to prevent overcooking before dense, thick areas are cooked thoroughly.
- Stir foods from outside to center of dish once or twice during cooking, if possible.
- Turn foods over once during microwaving to speed cooking of such foods as chicken and hamburgers. Large items like roasts must be turned over at least once.
- Rearrange foods such as meatballs halfway through cooking both from top to bottom and from the center of the dish to the outside.
- Add standing time. Remove food from oven and stir, if possible. Cover for standing time which allows the food to finish cooking without overcooking.
- Check for doneness. Look for signs indicating that cooking temperatures have been reached.

Doneness signs include:

- Food steams throughout, not just at edge.
- Center bottom of dish is very hot to the touch.
- Poultry thigh joints move easily.
- Meat and poultry show no pinkness.
- Fish is opaque and flakes easily with a fork.

ABOUT SAFETY

- Check foods to see that they are cooked to the United States Department of Agriculture's recommended temperatures.
- ALWAYS use potholders to prevent burns when handling utensils that are in contact with hot food. Enough heat from the food can transfer through utensils to cause skin burns.
- Avoid steam burns by directing steam away from the face and hands. Slowly lift the farthest edge of a dish's covering and carefully open popcorn and oven cooking bags away from the face.
- Stay near the oven while it's in use and check cooking progress frequently so that there is no chance of overcooking food.
- NEVER use the cavity for storing cookbooks or other items.
- Select, store and handle food carefully to preserve its high quality and minimize the spread of foodborne bacteria.
- Keep waveguide cover clean. Food residue can cause arcing and/or fires.
- Use care when removing items from the oven so that the utensil, your clothes or accessories do not touch the safety door latches.

TEMP	FOOD
160°F	... for fresh pork, ground meat, boneless white poultry, fish, seafood, egg dishes and frozen prepared food.
165°F	... for leftover, ready-to-reheat refrigerated, and deli and carry-out "fresh" food.
170°F	... white meat of poultry.
180°F	... dark meat of poultry.

To test for doneness, insert a meat thermometer in a thick or dense area away from fat or bone. NEVER leave the thermometer in the food during cooking, unless it is approved for microwave oven use.

PART NAMES

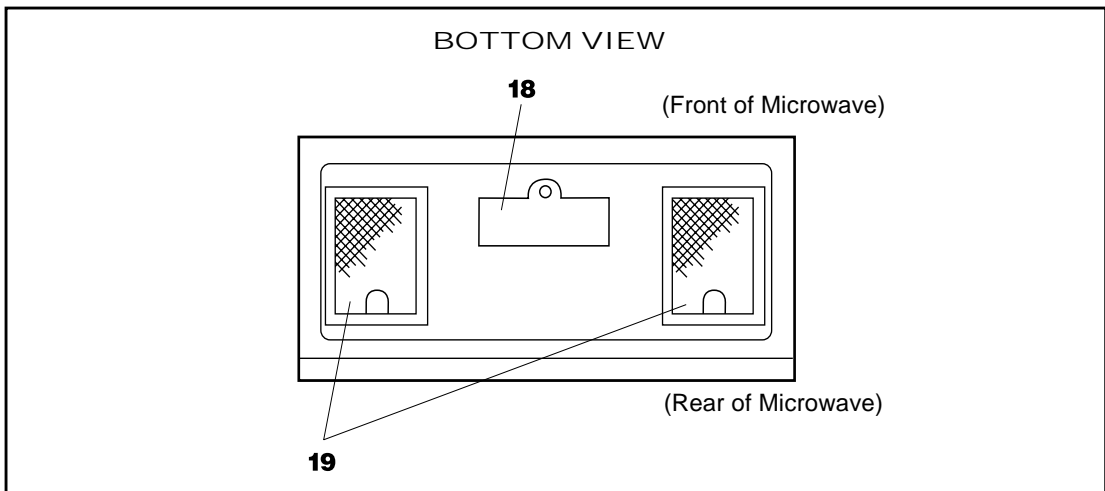
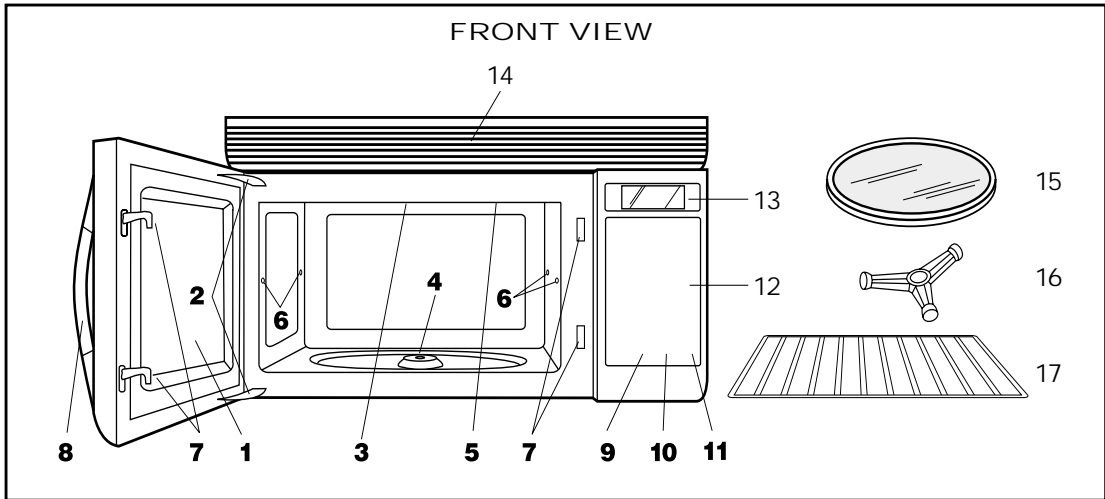

- | | |
|---|--|
| <p>1 Oven door with see-through window</p> <p>2 Door hinges</p> <p>3 Waveguide cover:
DO NOT REMOVE.</p> <p>4 Turntable motor shaft</p> <p>5 Oven light
It will light when oven is operating or door is open.</p> <p>6 Rack holders</p> <p>7 Safety door latches
The oven will not operate unless the door is securely closed.</p> <p>8 Handle</p> <p>9 WORK LIGHT pad
Press the WORK LIGHT pad to turn light on or off.</p> <p>10 NIGHT LIGHT pad
Press the NIGHT LIGHT pad to turn light on or off.</p> | <p>11 FAN HI/LO pad
Press the FAN HI/LO pad to turn on the fan. Press again for low speed. Press a third time to turn the fan off.</p> <p>12 Auto-Touch control panel</p> <p>13 Time display: Digital display, 99 minutes, 99 seconds</p> <p>14 Ventilation openings</p> <p>15 Removable turntable
The turntable will rotate clockwise or counter-clockwise. Only remove for cleaning.</p> <p>16 Removable turntable support
First, carefully place the turntable support in the motor shaft in the center of the oven floor. Then, place the turntable on the turntable support securely.</p> <p>17 Rack for 2-level cooking/reheating</p> <p>18 Light cover</p> <p>19 Grease filters</p> |
|---|--|

TOUCH CONTROL PANEL

R-1610 / R-1611 / R-1612

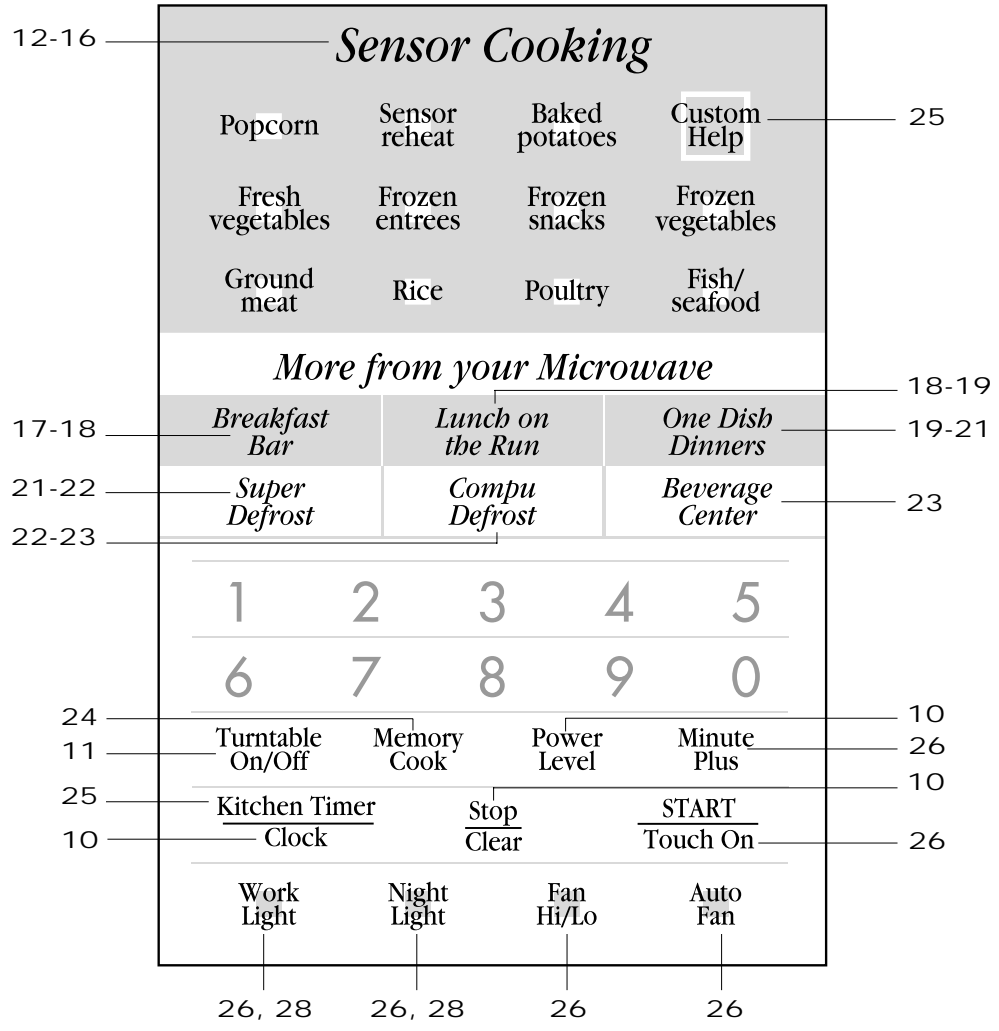

Number next to the control panel illustration indicates page on which there are a feature description and usage information.

VISUAL DISPLAY

The 2-line, 16-digit Interactive Display spells out operating steps and shows cooking hints. When HELP is lighted in the display, touch the CUSTOM HELP pad to read a specific hint which may assist you.

BEFORE OPERATING

- Before operating your new microwave oven make sure you read and understand this operation manual completely.
- Before the oven can be used, follow these procedures:
 1. Plug in the oven. Close the door. The oven display will show **SHARP** **SIMPLY** **THE** **BEST** **PRESS** **CLEAR** **AND** **PRESS** **CLOCK**.
 2. Touch the **Stop/Clear** pad. **:** will appear.
 3. Set clock.

TO SET THE CLOCK

- Suppose you want to enter the correct time of day 12:30 (A.M. or P.M.).

PROCEDURE	DISPLAY
1 Touch Kitchen Timer/Clock pad. Press number 2.	Kitchen Timer Clock TO SET CLOCK PRESS 2
2 Enter the correct time of day by touching the numbers in sequence.	1 2 3 0 12:30

3
Touch **Kitchen Timer/Clock** pad again.

Kitchen Timer
Clock **12:30**

This is a 12 hour clock. If you attempt to enter an incorrect clock time, **ERROR** will appear in the display. Touch the Stop/Clear pad and re-enter the time.

- If the electrical power supply to your microwave oven should be interrupted, the display will intermittently show **SHARP** **SIMPLY** **THE** **BEST** **PRESS** **CLEAR** **AND** **PRESS** **CLOCK** after the power is reinstated. If this occurs during cooking, the program will be erased. The time of day will also be erased. Simply touch Stop/Clear pad and reset the clock for the correct time of day.

NOTE: Your oven can be programmed with the door open except for START/Touch On and Minute Plus.

STOP/CLEAR

Touch the Stop/Clear pad to:

1. Erase if you make a mistake during programming.
2. Cancel timer.
3. Stop the oven temporarily during cooking.
4. Return the time of day to the display.
5. Cancel a program during cooking, touch twice.

MANUAL OPERATION

TIME COOKING

Your oven can be programmed for 99 minutes 99 seconds (99.99). Always enter the seconds after the minutes, even if they are both zeros.

- Suppose you want to cook for 5 minutes at 100%.

PROCEDURE	DISPLAY
1 Enter cooking time.	5 0 0 5.00
2 Touch START/Touch On pad.	START Touch On 5.00 <small>COOK</small>

TO SET POWER LEVEL

There are eleven preset power levels.

Using lower power levels increases the cooking time, which is recommended for foods such as cheese, milk

and long slow cooking of meats. Consult cookbook or recipes for specific recommendations.

TOUCH POWER LEVEL PAD ONCE THEN TOUCH	APPROXIMATE PERCENTAGE OF POWER	COMMON WORDS FOR POWER LEVELS
Power Level	100%	High
9	90%	
8	80%	
7	70%	Medium High
6	60%	
5	50%	Medium
4	40%	
3	30%	Med Low/Defrost
2	20%	
1	10%	Low
0	0%	

MANUAL OPERATION

- Suppose you want to defrost for 5 minutes at 30%.

PROCEDURE	DISPLAY
1 Enter defrosting time.	
2 Touch Power Level pad. Enter power level.	
3 Touch START/Touch On pad.	

TURNTABLE ON/OFF

For most cooking, the turntable should be on; however the turntable can be turned off so that it does not rotate when extra large dishes, such as the popular 13 x 9 x 2 glass utility casserole, are used. The casserole should be placed on the turntable so that it is level.

- Suppose you want to cook lasagna in a 13 x 9 x 2 casserole for 45 minutes on 40% power.

PROCEDURE	DISPLAY
1 Touch Turntable On/Off pad and note TURNTABLE OFF in the display.	
2 Enter cooking time.	
3 Touch Power Level pad. Enter number 4 for power level.	
4 Touch START/Touch On pad.	

NOTE:

The door can be opened for checking food and the turntable will stay in the off position. After checking, close door and touch START/Touch On.

The turntable will stay off for one minute after door is opened when time-of-day appears in the display. It is possible to reprogram the oven during that minute without touching the Turntable On/Off pad. The display indicates when the turntable is off.

All special features can only be used with the turntable on. When the turntable is set in the off position, only manual operation can be used.

When cooking large quantities of food which cannot be stirred, it is best to use a lower power level such as 40 or 50%. You may speed cooking for large amounts by programming 5 to 10 minutes on 100% power (HIGH) followed by the desired time on lower power. See page 24 for how to program multiple sequences. You may wish to reverse a large casserole once during cooking; simply open door, reposition casserole, close door and touch START/Touch On.

USING THE RACK

The Rack allows several foods to be cooked or reheated at one time. However, for the best cooking and reheating, use *the turntable on and the automatic features*.

When using the Rack, set time and power level manually. Allow plenty of space around and between the dishes. Pay close attention to the cooking/reheating progress. Reposition the foods and reverse them from rack to turntable at least once during any cooking or reheating time. Using a lower power level will assist in better cooking/reheating uniformity.

AVOID:

- Storing the Rack in the oven when not in use.
- Popping popcorn on the turntable with the Rack in the oven.
- Using any browning dish on the Rack.
- Using special features with the Rack. Special features are designed to be used with foods only on the revolving turntable.
- Cooking directly on the Rack—use microwave-safe cookware.

MANUAL DEFROST

If the food that you wish to defrost is not listed on the SuperDefrost or CompuDefrost Chart or is above or below the limits in the "Amount" column on the SuperDefrost or CompuDefrost Chart, you need to defrost manually.

You can defrost any frozen food, either raw or previously cooked, by using Power Level 3. Follow the exact 3-step procedure found under Time Cooking above. Estimate defrosting time and press 3 for 30% when you select the power level.

For either raw or previously cooked frozen food the rule of thumb is approximately 4 minutes per pound. For example, defrost 4 minutes for 1 pound of frozen spaghetti sauce.

Always stop the oven periodically to remove or separate the portions that are defrosted. If food is not defrosted at the end of the estimated defrosting time, program the oven in 1 minute increments on Power Level 3 until totally defrosted.

When using plastic containers from the freezer, defrost only long enough to remove from the plastic in order to place in a microwave-safe dish.

SPECIAL FEATURES

SENSOR COOKING

Sharp's Sensor is a semi-conductor device that detects the vapor (moisture and humidity) emitted from the food as it heats. The sensor adjusts the cooking times and power level for various foods and quantities.

Using Sensor Settings:

1. After oven is plugged in, wait 2 minutes before using Sensor Cooking.
2. Be sure the exterior of the cooking container and the interior of the oven are dry. Wipe off any moisture with a dry cloth or paper towel.
3. The oven works with foods at normal storage temperature. For example, popcorn would be at room temperature.
4. Any Sensor Cooking selection can be programmed with More or Less Time Adjustment. See page 24.
5. More or less food than the quantity listed in the chart should be cooked following the guidelines in any microwave cookbook.
6. During the first part of Sensor Cooking, food name will appear on the display. Do not open the oven door or touch Stop/Clear during this part of the cooking cycle. The measurement of vapor will be interrupted. If this occurs, an error message will appear. To continue cooking, touch the Stop/Clear pad and cook manually.

When the sensor detects the vapor emitted from the food, remainder of cooking time will appear. Door may be opened when remaining cooking time appears on the display. At this time, you may stir or season food, as desired.

7. If the sensor does not detect vapor properly when popping popcorn, the oven will turn off, and the correct time of day will be displayed. If the sensor does not detect vapor properly when cooking other foods, **ERROR** will be displayed, and the oven will turn off.

8. Check food for temperature after cooking. If additional time is needed, continue to cook manually.
9. Each food has a cooking hint. Touch Custom Help pad when the HELP indicator is lighted in the display.

Covering Foods:

Some foods work best when covered. Use the cover recommended in the Sensor Cooking chart for these foods.

1. Casserole lid.
2. Plastic wrap: Use plastic wrap recommended for microwave cooking. Cover dish loosely; allow approximately 1/2 inch to remain uncovered to allow steam to escape. Plastic wrap should not touch food.
3. Wax paper: Cover dish completely; fold excess wrap under dish to secure. If dish is wider than paper, overlap two pieces at least one inch to cover.

Be careful when removing any covering to allow steam to escape away from you.

SENSOR REHEAT

You can cook many foods by touching just one pad. You don't need to calculate cooking time or power level.

- Suppose you want to reheat canned chili.

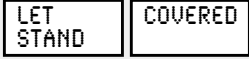
PROCEDURE	DISPLAY
<p>1 Sensor reheat</p> <p>Touch Sensor reheat pad. When sensor detects the vapor emitted from the food, remainder of reheating time will appear.</p>	
<p>2 At end, follow the directions in the display.</p>	

NOTE: The Turntable On/Off Sensor reheat, Popcorn, Fresh vegetables and Poultry settings have 2 choices. Follow directions in the Interactive Display to choose desired option.

SENSOR REHEAT CHART

FOOD	AMOUNT	PROCEDURE
Sensor reheat: Turntable On	4 - 36oz	Place in dish or casserole slightly larger than amount to be reheated. Flatten, if possible. Cover with lid, plastic wrap or wax paper. Use covers such as plastic wrap or lids with larger quantities of more dense foods such as stews. After reheating, stir well, if possible. Foods should be very hot. If not, continue to heat with variable power and time. After stirring, re-cover and allow to stand 2 to 3 minutes.
Turntable Off Stirrable	13 x 9 x 2 glass utility casserole	Ideal for reheating stirrable casseroles, such as macaroni and cheese or stew. Cover with vented plastic wrap or wax paper. Touch Turntable On/Off, Sensor reheat and number 1. At signal, stir casserole and rotate dish. Touch START/Touch On. At end, stir and allow to stand, covered, for 5 to 10 minutes.
Non-stirrable	13 x 9 x 2 glass utility casserole	Ideal for reheating non-stirrable casseroles, such as lasagna. Cover with vented plastic wrap or wax paper. Touch Turntable On/Off, Sensor reheat and the number 2. At signal, rotate dish. Touch START/Touch On. At end, allow to stand, covered, for 10 to 15 minutes.

SPECIAL FEATURES

OTHER SENSOR COOKING SETTINGS

Sensor Cooking will automatically compute the microwave power and cooking time for foods shown in the chart below. You don't need to enter the weight or quantity of the food.

- Suppose you want to cook fresh broccoli.

PROCEDURE	DISPLAY
1 Fresh vegetables	VEGE-TABLES SOFT
Touch Fresh vegetables pad and the number 1 for soft vegetables.	

When sensor detects the vapor emitted from the food, remainder of cooking time will appear.

- 2 At end, follow the directions in the display.

STIR	LET STAND
COVERED	

SENSOR COOKING CHART

FOOD	AMOUNT	PROCEDURE
Popcorn	1 package 3.0 - 3.5 oz (Regular) 1.5 - 1.75 oz (Snack)	Use only popcorn packaged for microwave oven use. Try several brands to decide which you like the best. Press Popcorn pad and the number 1 for regular size bags. Press Popcorn pad and number 2 for snack size bags. Do not try to pop unpopped kernels.
Baked potatoes	1 - 6 med.	Pierce. Place on paper-towel-lined turntable. After cooking, remove from oven, wrap in aluminum foil and let stand 5 to 10 minutes.
Fresh vegetables: Soft		Wash and place in casserole. Add no water if vegetables have just been washed. Cover with lid for tender vegetables. Use plastic wrap for tender-crisp vegetables. Touch Fresh vegetables, number 1 and START/Touch On pads. After cooking, stir, if possible. Let stand, covered, for 2 to 5 minutes.
Broccoli	.25 - 2.0 lb	
Brussels sprouts	.25 - 2.0 lb	
Cabbage	.25 - 2.0 lb	
Cauliflower (flowerets)	.25 - 2.0 lb	
Cauliflower (whole)	1 med.	
Spinach	.25 - 1.0 lb	
Zucchini	.25 - 2.0 lb	
Baked apples	2 - 4 med.	
Fresh vegetables: Hard		Place in casserole. Add 1-4 tbsp water. Cover with lid for tender vegetables. Use plastic wrap cover for tender-crisp vegetables. Touch Fresh vegetables, number 2 and START/Touch On pads. After cooking, stir, if possible. Let stand, covered, for 2 to 5 minutes.
Carrots, sliced	.25 - 1.5 lb	
Corn on the cob	2 - 4	
Green beans	.25 - 1.5 lb	
Winter squash:		
diced	.25 - 1.5 lb	
halves	1 - 2	
Frozen entrees	6 - 17 oz	Use this pad for frozen convenience foods. It will give satisfactory results for most brands. You may wish to try several and choose your favorite. Remove package from outer wrapping and follow package directions for covering. After cooking, let stand, covered, for 1-3 minutes.
Frozen snacks	3 - 8 oz	Use for frozen French fries, cheese sticks, appetizers etc. Remove from outer package. Follow package directions for how to wrap or cover. Be careful when removing from the oven as snack may be very hot.
Frozen vegetables	.25 - 1.25 lb	Add no water. Cover with lid or plastic wrap. After cooking, stir and let stand, covered, for 3 minutes.

SPECIAL FEATURES

SENSOR COOKING CHART (CONTINUED)

FOOD	AMOUNT	PROCEDURE															
Ground meat	.25 - 2.0 lb	Use this setting to cook ground beef or turkey as patties or in a casserole to be added to other ingredients. Place patties on a microwave-safe rack and cover with wax paper. Place ground meat in a casserole and cover with wax paper or plastic wrap. When oven stops, turn patties over or stir meat in casserole to break up large pieces. Re-cover and touch START/Touch On. After cooking, let stand, covered, for 2 to 3 minutes.															
Rice	.5 - 2.0 cups	Place rice into a deep casserole and add double quantity of water. Cover with lid or plastic wrap. After cooking, stir, cover and let stand 3 to 5 minutes or until all liquid has been absorbed. <table border="1" data-bbox="587 575 1237 734"> <thead> <tr> <th>Rice</th> <th>Water</th> <th>Size of casserole</th> </tr> </thead> <tbody> <tr> <td>.5 cup</td> <td>1 cup</td> <td>1.5 quart</td> </tr> <tr> <td>1 cup</td> <td>2 cups</td> <td>2 quart</td> </tr> <tr> <td>1.5 cups</td> <td>3 cups</td> <td>2.5 or 3 quart</td> </tr> <tr> <td>2 cups</td> <td>4 cups</td> <td>3 quart or larger</td> </tr> </tbody> </table>	Rice	Water	Size of casserole	.5 cup	1 cup	1.5 quart	1 cup	2 cups	2 quart	1.5 cups	3 cups	2.5 or 3 quart	2 cups	4 cups	3 quart or larger
Rice	Water	Size of casserole															
.5 cup	1 cup	1.5 quart															
1 cup	2 cups	2 quart															
1.5 cups	3 cups	2.5 or 3 quart															
2 cups	4 cups	3 quart or larger															
Poultry: Boneless	.5 - 2.0 lb	Use boneless breast of chicken or turkey. Cover with vented plastic wrap. Touch Poultry, number 1 and START/Touch On pads. When oven stops, rearrange. Re-cover and touch START/Touch On pad. After cooking, let stand, covered, 3-5 minutes. Poultry should be 160°F.															
With bone	.5 - 3.0 lb	Arrange pieces with meatiest portions toward outside of glass dish or microwave-safe rack. Cover with vented plastic wrap. Touch Poultry, number 2 and START/Touch On pads. After cooking, let stand, covered, 3-5 minutes. Dark meat should be 180°F and white meat should be 170°F.															
Fish/seafood	.25 - 2.0 lb	Arrange in ring around shallow glass dish (roll fillet with edges underneath). Cover with vented plastic wrap. After cooking, let stand, covered for 3 minutes.															

SENSOR COOKING RECIPES

Herb-and-Cheese Chicken Breasts

Makes 8 servings

- | | |
|--|--|
| 1 8-ounce package cream cheese, softened | 1 garlic clove, minced |
| 2 tablespoons milk | 4 whole chicken breasts with skin and bone |
| 2 green onions, minced | 1/2 cup dried bread crumbs |
| 1 tablespoon minced parsley | 1 teaspoon paprika |
| 1/2 teaspoon thyme leaves | 3 tablespoons butter or margarine, melted |

- In a small bowl, combine cream cheese, milk, green onions, parsley, thyme, and garlic.
- Push fingers between skin and meat of each chicken breast to form a pocket. Spread an equal amount of cream cheese mixture in each pocket.
- On waxed paper, combine bread crumbs and paprika. Dip chicken breasts into melted butter, then roll in seasoned bread crumbs to coat.
- In 8-inch x 8-inch, baking dish, place chicken and cover with plastic wrap. Microwave using Poultry (with bone).
- Serve chicken with rice.

SENSOR COOKING RECIPES (CONTINUED)

Shrimp Pasta Sauce

Makes 4 servings

- | | |
|--|---|
| 1 pound of shrimp, peeled and deveined | 1 cup thinly sliced scallions (about 2 bunches) |
| 2 cups canned tomato puree | 1 clove of garlic, minced |
| 1 tablespoon tomato paste | salt and pepper to taste |
| 1/2 cup thinly sliced fresh basil leaves | Parmesan cheese |
| 1/2 teaspoon oregano | |

- 1 Place shrimp in 2-quart, covered casserole.
- 2 Microwave using Fish/seafood. Drain and set aside.
- 3 Combine tomato puree, tomato paste, basil, oregano, scallions, garlic, salt and pepper in 2-quart casserole.
- 4 Microwave using Sensor reheat.
- 5 Combine sauce with cooked shrimp.
- 6 Serve sauce over cooked pasta. Garnish with Parmesan cheese.

Glazed Apple Slices

Makes 6 to 8 servings

- | | |
|-----------------------------------|--|
| 1/4 cup brown sugar | 3/4 cup orange juice |
| 3 tablespoons margarine or butter | 1 tablespoon cornstarch |
| 2 tablespoons apricot preserves | 4 baking apples (about 1 1/2 pounds), peeled and sliced into 8 pieces each |
| 1/2 teaspoon ground nutmeg | 3 tablespoons chopped green pistachios |
| 1/4 teaspoon salt | |
| 1/2 cup sugar | |

- 1 Combine brown sugar, margarine and apricot preserves in a small bowl. Microwave at HIGH (100%) until margarine melts and preserves soften, 45 seconds to 1 minute. Stir in nutmeg, salt, sugar, orange juice and cornstarch. Microwave at HIGH (100%) until thickened, 4 to 6 minutes, stirring several times.
- 2 Arrange apple slices in a large microwave serving dish. Spread hot sauce over apples. Cover well with vented plastic wrap. Microwave using Fresh vegetables: Soft. Allow to cool 5 minutes before serving.
- 3 Sprinkle with pistachios. Serve alone or over vanilla ice cream or sponge cake.

Cranberry Fluff

Makes 6 to 8 servings

- | | |
|--------------------------|---|
| 2 cups fresh cranberries | 1 carton (3 ounces) orange flavored gelatin |
| 1 cup water | 1/2 pint whipping cream, whipped or 1 carton (8 ounces) non-dairy whipped topping |
| 3/4 cup sugar | |

- 1 Combine cranberries, water and sugar in a 2-quart casserole. Cover with wax paper. Microwave using Sensor reheat Less. Drain cranberries and reserve liquid.
- 2 Add enough hot water to reserved liquid to make 2 cups. Stir the gelatin into hot liquid until it dissolves. Cover with wax paper. Microwave using Sensor reheat Less.
- 3 Add berries and cool. Refrigerate until thickened. Fold whipped cream into cooled cranberry mixture. Spoon into serving dishes and garnish with extra whipped cream. Refrigerate until ready to serve.

SENSOR COOKING RECIPES (CONTINUED)

Mexican Seasoned Potatoes

Makes 6 to 8 servings

- | | |
|--|-----------------------------|
| 4 medium baking potatoes (8 ounces each) | 1/2 teaspoon oregano leaves |
| 1/4 cup olive oil | 1/4 teaspoon ground cumin |
| 1 tablespoon instant minced onion | 1/2 teaspoon salt |
| 1/2 teaspoon chili powder | |

- 1 Cut each potato lengthwise into 4 equal wedges. Place potato wedges into 10-inch square casserole. Toss potatoes with oil to coat well.
- 2 In small bowl, combine remaining ingredients. Sprinkle over potatoes.
- 3 Cover potatoes with wax paper. Microwave using Baked potatoes setting. Rearrange potatoes when time appears on display. Let stand, covered, 5 minutes.

Hearty Turkey Chili

Makes 6 servings

- | | |
|----------------------------|--|
| 1 pound ground turkey | 1 medium zucchini, cut into 1 inch cubes |
| 1 large onion, chopped | 1 28 ounce can of tomatoes |
| 2 garlic cloves, minced | 1/3 cup tomato paste |
| 2 tablespoons chili powder | 1 15 1/4 to 19 ounce can red kidney beans, drained |
| 1 tablespoon cumin | 8 ounces frozen corn, thawed |

- 1 In 3-quart casserole, place ground turkey, onion, garlic, chili powder and cumin. Mix thoroughly.
- 2 Cover and microwave using Ground meat. Stir and drain.
- 3 To meat mixture, add zucchini, tomatoes with their liquid, tomato paste, beans and corn. Microwave, covered, using Sensor reheat.

Creole Corn

Makes 6 servings

- | | |
|---|-----------------------------------|
| 2 teaspoons oil | 1 teaspoon brown sugar |
| 1/2 cup chopped celery | 1/2 teaspoon onion powder |
| 1/2 cup chopped green pepper | 1/4 teaspoon garlic powder |
| 16 ounce can tomatoes | salt and pepper to taste |
| 4 ounce can mushroom stem and pieces, drained | 1 package (16 ounces) frozen corn |

- 1 In 2-quart casserole, combine oil, celery, green pepper, tomatoes, mushrooms, sugar, onion powder, garlic powder, salt and pepper.
- 2 Microwave using Sensor reheat. Set aside.
- 3 In covered, 1-quart casserole, microwave corn using Frozen vegetables. Drain.
- 4 Combine corn and vegetable-seasoning mixture. Stir and serve immediately.

Savory Flounder Fillets

Makes 4 servings

- | | |
|-------------------------------|--------------------------|
| 3/4 cup of corn flake crumbs | 1/2 teaspoon paprika |
| 3 tablespoons chopped parsley | 1 pound flounder fillets |
| 2 teaspoons grated lemon peel | 1 egg, slightly beaten |

- 1 On waxed paper, combine corn flake crumbs, parsley, lemon peel and paprika. Dip fillets in beaten egg, then coat with crumb mixture.
- 2 Place fish in a covered, microwave-safe, baking dish. Microwave using Fish/seafood.
- 3 Serve with tartar or cocktail sauce or melted cheese.

SPECIAL FEATURES

MORE FROM YOUR MICROWAVE









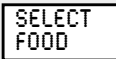

Your oven has 6 convenient pads to assist with meal preparation. There are some foods in the Breakfast Bar and Lunch on the Run that use the sensor. See the

Sensor Cooking information on page 12. For foods not using the sensor, follow the directions in the Interactive Display to enter quantity.

1. BREAKFAST BAR

Breakfast Bar is for preparing popular breakfast foods.

- Suppose you want to use Breakfast Bar to cook 2 servings of hot cereal.

PROCEDURE	DISPLAY
1  Touch Breakfast Bar pad.	 
2  x 3 Touch Breakfast Bar pad three more times to select hot cereal.  If you want to cook 2 servings, touch 2 pad.	    
3  Touch START/Touch On pad.	
4 After cooking, follow the directions in display.	

NOTE:

1. Heat rolls/muffins setting has 2 choices. Follow directions in the Interactive Display to choose desired option.
2. Breakfast Bar can be programmed with More or Less Time Adjustment. Touch the Power Level pad once or twice before touching START/Touch On pad. See page 24.
3. Each food has a cooking hint. Touch Custom Help pad when the HELP indicator is lighted in the display.
4. Should you attempt to enter more or less than the allowed amount, an error message will appear in the display.
More or less than the quantity listed in the chart should be cooked following the guidelines in any microwave cookbook.
5. The final cooking result will vary according to the food condition (e.g. initial temperature, shape, quality). Check food for temperature after cooking. If additional time is needed, continue to cook manually.

BREAKFAST BAR CHART

FOOD	AMOUNT	PROCEDURE
1. Scrambled eggs	1 - 9 eggs	For each egg, use 1 teaspoon of butter or margarine and 1 tablespoon of milk. Place butter or margarine in dish, measuring cup or casserole large enough for the egg to expand. Mix egg and milk together. Pour on to butter or margarine in dish. Place in oven and program. When audible signals are heard, stir egg mixture moving the cooked portion to the center of the dish and uncooked portion to the outside. After cooking, stir and let stand, covered, until set. Note that eggs will be slightly undercooked when removed from the oven.
2. Bacon	2 - 6 strips	Place bacon on paper plate, lined with paper towel. Bacon should not extend over the rim of plate. Cover with another paper towel. Allow bacon to stand a few minutes after removing from the oven to complete the cooking.
3. Hot cereal	1 - 6 servings	Use individual packets or bulk cereal in your favorite variety: oatmeal, oat bran, cream of wheat, farina or wheatena. Follow package directions for the correct amount of water or milk. To prevent boilovers, it is very important to choose a large container because microwave cooking of cereal causes high boiling. When oven stops, stir and touch START/Touch On. After cooking, stir and let stand, covered, for 2 minutes.

SPECIAL FEATURES

BREAKFAST BAR CHART (CONTINUED)

FOOD	AMOUNT	PROCEDURE
4. Heat rolls/ muffins:		Use this pad to warm rolls, muffins, biscuits, bagels etc. Large items should be considered as 2 or 3 regular size. Arrange on plate: cover with paper towel.
Fresh	1 - 8 pieces	To warm fresh rolls and muffins, touch Breakfast Bar pad 5 times and touch number 1 pad. Then enter desired quantity and touch START/Touch On pad. For refrigerated rolls or muffins, it may be necessary to double the entered amount to ensure the proper serving temperature. For example, enter quantity of 2 for 1 refrigerated muffin.
Frozen	1 - 8 pieces	For frozen rolls and muffins, touch Breakfast Bar pad 5 times and touch number 2 pad. Then enter desired quantity and touch START/Touch On pad.
5. Frozen breakfast foods*	1 (3 - 6 oz)	This setting works well for frozen breakfast entrees, pancakes, waffles, burritos etc. Follow manufacturer's directions for how to prepare for microwaving. Allow to stand 1 or 2 minutes after cooking.

* IT IS NOT NECESSARY TO ENTER AMOUNT.

2. LUNCH ON THE RUN

Lunch on the Run is for cooking/heating foods that take a short amount of time!

- Suppose you want to use Lunch on the Run to heat 2 cups of soup.

PROCEDURE	DISPLAY
1	<div style="display: flex; justify-content: space-around;"> <div style="border: 1px solid black; padding: 2px; text-align: center;"><i>Lunch on the Run</i></div> <div style="border: 1px solid black; padding: 2px; text-align: center;">REPEAT TO</div> <div style="border: 1px solid black; padding: 2px; text-align: center;">SELECT FOOD</div> </div> <p>Touch Lunch on the Run pad.</p>
2	<div style="display: flex; justify-content: space-around;"> <div style="border: 1px solid black; padding: 2px; text-align: center;"><i>Lunch on the Run</i></div> <div style="font-size: 2em;">x 3</div> <div style="border: 1px solid black; padding: 2px; text-align: center;">SOUP</div> <div style="border: 1px solid black; padding: 2px; text-align: center;">PRESS START</div> </div> <p>Touch Lunch on the Run pad three more times to select soup.</p>
3	<div style="border: 1px solid black; padding: 2px; text-align: center; width: fit-content;">START Touch On</div> <p>Touch START/Touch On pad.</p>
4	After cooking, follow the directions in the display.

NOTE:

1. Lunch on the Run can be programmed with More or Less Time Adjustment. Touch the Power Level pad once or twice before touching Start/Touch On pad. See page 24.
2. Each food has a cooking hint. Touch Custom Help pad when the HELP indicator is lighted in the display.
3. Should you attempt to enter more or less than the allowed amount, an error message will appear in the display.

More or less than the quantity listed in the chart should be cooked following the guidelines in any microwave cookbook.
4. The final cooking result will vary according to the food condition (e.g. initial temperature, shape, quality). Check food for temperature after cooking. If additional time is needed, continue to cook manually.

LUNCH ON THE RUN CHART

IT IS NOT NECESSARY TO ENTER AMOUNT.

FOOD	AMOUNT	PROCEDURE
1. Meal in a cup	1 cup	This setting is ideal for individual portions of canned food packed in a small microwaveable container, usually 6 to 8 ounces. Remove inner metal lid and replace outer microwaveable lid. After cooking, stir food and allow to stand 1 or 2 minutes.
2. Hot dogs in buns	1 - 4	Place hot dog in bun. Wrap each with paper towel or napkin.
3. Soup	1 - 6 cups	Place in bowl or casserole. Cover with lid or plastic wrap. At end, stir, re-cover and let stand 1 to 3 minutes.

SPECIAL FEATURES

LUNCH ON THE RUN CHART (CONTINUED)

FOOD	AMOUNT	PROCEDURE
4. Microwave pizza	1 (6 - 8 oz)	Use for frozen microwave pizza. Remove from package and unwrap. Follow package directions for use of package and/or silver crisping disk.
5. Frozen sandwich	1 (3 - 6 oz)	Use for frozen microwaveable sandwiches. Remove from package and follow directions for placing in the oven.

3. ONE DISH DINNERS

One Dish Dinners will cook any of the dinners listed in the chart by simply following the directions in the Interactive Display and on the Recipe Card. There are 2 recipes in each section. Choose one and follow Recipe Card for ingredients and instructions.

- Suppose you want to use One Dish Dinners to cook Spicy Couscous Pockets in ground beef dinner.

PROCEDURE	DISPLAY						
1 Touch One Dish Dinners pad.	<table border="1"> <tr> <td>REPEAT TO</td> <td>SELECT DINNER</td> </tr> </table>	REPEAT TO	SELECT DINNER				
REPEAT TO	SELECT DINNER						
2 Touch One Dish Dinners pad once more to select ground beef.	<table border="1"> <tr> <td>GROUND BEEF</td> <td>DINNER</td> </tr> <tr> <td>SEE RECIPE</td> <td>CARD</td> </tr> <tr> <td>PRESS START</td> <td></td> </tr> </table>	GROUND BEEF	DINNER	SEE RECIPE	CARD	PRESS START	
GROUND BEEF	DINNER						
SEE RECIPE	CARD						
PRESS START							

3

START
Touch On

Touch **START/Touch On** pad.

NOTE:

1. One Dish Dinners can be programmed with More or Less Time Adjustment. Touch the Power Level pad once or twice before touching START/Touch On pad. See page 24.
2. Each food has a cooking hint. Touch Custom Help pad when the HELP indicator is lighted in the display.

ONE DISH DINNERS RECIPES (RECIPES SERVE 6)

1. GROUND BEEF DINNER

Spicy Couscous Pockets

Place in a 3 quart casserole:

- 1 1/4 pounds lean ground beef (85% lean or better)
- 1 can (14.5 ounces) diced tomatoes
- 1 can (8 ounces) tomato sauce
- 1 cup water
- 1 large onion, chopped
- 1/4 cup chopped green pepper
- 3/4 cup couscous
- 1 clove garlic, minced
- 1 1/2 tablespoons chili powder
- 1 teaspoon ground cumin
- 1 teaspoon dried oregano leaves

Stir well and cover. Touch **One Dish Dinners** 2 times and touch **START/Touch On**.

At pause, stir well and add:

- 1 cup raisins

Recover. Touch **START/Touch On**.

Serve spooned into pita pockets.

Speedy Shepherd's Pie

Combine the following and spread evenly in a 11" x 7" rectangular casserole:

- 1 1/2 pounds lean ground beef (85% lean or better)
- 1 cup dry bread crumbs
- 1/2 cup catsup
- 1 onion, minced
- 1 egg

Touch **One Dish Dinners** 2 times and touch **START/Touch On**.

At pause, top ground beef mixture with:

- 2 cups frozen peas and carrots

Top peas and carrots with:

- 4 cups prepared mashed potatoes (either freshly made or reconstituted from dry)

Touch **START/Touch On**.

Serve with gravy (canned or made from a mix).

2. CHICKEN DINNER

Yellow Rice with Chicken

Place in a 3 quart casserole:

- 1 package (5 - 8 ounces) yellow rice mix with flavor packet
- 2 cups chicken broth

Stir well and cover. Touch **One Dish Dinners** 3 times and touch **START/Touch On**.

At pause, stir well and add:

- 1 cup frozen peas
- 1 red pepper, diced
- 1 1/4 pounds boneless chicken cutlets, sliced into thin strips

Recover. Touch **START/Touch On**.

At end, garnish with parsley.

Chicken with Fruited Stuffing

Place in a 3 quart casserole:

- 1 package (6 ounces) cornbread or apple and raisin stuffing mix with flavor packet
- 1 cup apple juice
- 1 1/2 cups chicken broth
- 3 tablespoons butter, cut into cubes
- 2 apples, peeled, cored and cut into cubes
- 1/3 cup raisins

Stir well and cover. Touch **One Dish Dinners** 3 times and touch **START/Touch On**.

At pause, stir well and add:

- 3 cups string beans, cut into 1" pieces
- 1 1/4 pounds boneless chicken cutlets, sliced into thin strips

Recover. Touch **START/Touch On**.

At end, garnish with toasted slivered almonds.

3. BEEF OR PORK DINNER

Sweet and Sour Pork with Rice

Place in a 3 quart casserole:

- 1 cup rice
- 2 cups pineapple juice
- 1/4 cup apricot/peach sauce, sweet and sour sauce or duck sauce
- 2 tablespoons soy sauce
- 1 tablespoon fresh ginger, minced

Stir well and cover. Touch **One Dish Dinners** 4 times and touch **START/Touch On**.

At pause, stir well and add:

- 1/4 cup honey
- 1 1/4 pounds boneless, lean, pork loin, cut into thin strips
- 1 can (20 ounces) pineapple cubes, drained
- 3 cups fresh or frozen stir-fry vegetables (pea pods, celery, water chestnuts, carrots, peppers, etc.)

Recover. Touch **START/Touch On**.

At end, garnish with toasted almonds.

Beef with Broccoli and Rice

Place in a 3 quart casserole:

- 1 cup white rice
- 3 tablespoons Teriyaki sauce
- 1 tablespoon Hoisin sauce
- 2 1/2 cups beef broth

Stir well and cover. Touch **One Dish Dinners** 4 times and touch **START/Touch On**.

At pause, stir well and add:

- 1 1/4 pounds beef top round, sliced thin against the grain (1/4" thick)
- 4 scallions, diced
- 4 cups broccoli florets
- 1 large onion, sliced very thinly

Recover. Touch **START/Touch On**.

4. SEAFOOD DINNER

Creamy Seafood Pasta

Place in a 3 quart casserole:

- 8 - 9 ounces fresh tortellini
- 2 cups water

Stir well and cover. Touch **One Dish Dinners** 5 times and touch **START/Touch On**.

At pause, stir well and add:

- 1 jar (17 ounces) creamy Alfredo sauce or 1 3/4 cups of medium, white cheese sauce
- 1 1/4 pounds combination raw shellfish, fresh or thawed (shrimp, bay scallops, crabmeat)
- 3 cups mixed, fresh vegetables (sliced mushrooms, thinly julienned carrots, green beans)

Recover. Touch **START/Touch On**.

At end, garnish with:

- 1/3 cup grated Parmesan cheese

Greek Fusilli with Eggplant and Shrimp

Place in a 3 quart casserole:

- 2 cloves garlic, minced
- 1 large onion, thinly sliced
- 1 jar (28 ounces) marinara sauce
- 1 cup water or dry white wine
- 2 cups (6 ounces) tricolor pasta
- 1 medium eggplant (approximately one pound), peeled and cut into large cubes

Stir well and cover. Touch **One Dish Dinners** 5 times and touch **START/Touch On**.

At pause, stir well and add:

- 1 1/4 pounds raw shrimp (fresh or thawed), peeled and deveined

Recover. Touch **START/Touch On**.

At end, top with:

- 3/4 - 1 cup crumbled feta cheese

SPECIAL FEATURES

5. VEGETARIAN DINNER

Garden Au Gratin

Place in a 3 quart casserole:

- 1 1/2 pounds baking potatoes, cut into eighths, thinly sliced
- 1 can (14.5 ounces) diced tomatoes
- 1 tablespoon minced garlic
- 1 teaspoon thyme leaves

Stir well and cover. Touch **One Dish Dinners** 6 times and touch **START/Touch On**.

At pause, stir well and add:

- 1 bag (16 ounces) frozen pepper stir fry mix or 4 cups thinly sliced fresh peppers and onions
- 3 cups thinly sliced summer squash or combination of broccoli, cauliflower and squash

Recover. Touch **START/Touch On**.

At end, stir completely and garnish with:

- 6 ounces shredded Cheddar cheese

Orzo with Sun-Dried Tomatoes and Artichokes

Place in a 3 quart casserole:

- 1 cup orzo or other tiny shaped pasta
- 3 1/2 cups vegetable or chicken broth
- 1/4 cup pesto sauce (fresh or reconstituted from dry)
- 1/2 cup small pieces of sundried tomatoes
- 1 tablespoon minced garlic
- 1 tablespoon Italian seasoning

Stir well and cover. Touch **One Dish Dinners** 6 times and touch **START/Touch On**.

At pause, stir well and add:

- 3 cups chopped green, red, orange or yellow peppers
- 1 onion, thinly sliced
- 1 can (14 ounces) artichoke hearts, drained and quartered
- 1 can (3 ounces) pitted, ripe olives, drained and halved

Recover. Touch **START/Touch On**.











At end, stir and garnish top with:

- 1/2 cup freshly shredded Parmesan cheese
- 1/4 cup pine nuts

4. SUPERDEFROST

SuperDefrost rapidly defrosts specific foods and weights found in the SuperDefrost Chart below.

- Suppose you want to defrost 1.0 pound boneless poultry.

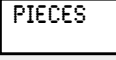
PROCEDURE	DISPLAY
1  Touch SuperDefrost pad once.	 
2  x 2 Touch SuperDefrost pad two more times to select boneless poultry.	  
3  Touch START/Touch On pad. The oven will stop so the food can be checked. The display will show: Close the door.	  

 Touch **START/Touch On** pad.

- 4 After defrost cycle ends, follow the directions.

NOTE:

1. To defrost foods above or below the weights allowed on the SuperDefrost Chart, use CompuDefrost or Manual Defrost. See CompuDefrost on pages 22 and 23 or Manual Defrost on page 11.
2. SuperDefrost can be programmed with More or Less Time Adjustment. Touch the Power Level pad once or twice before touching START/Touch On pad.
3. Touch Custom Help pad when the HELP indicator is lighted in the display for a helpful hint.

SUPER DEFROST CHART

FOOD	AMOUNT	PROCEDURE
1. Ground meat	1.0 lb	At pause, turn over, removed any thawed pieces and break remainder apart. At end, let stand, covered, for 3 to 5 minutes.

SPECIAL FEATURES

SUPER DEFROST CHART (CONTINUED)













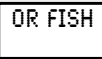

FOOD	AMOUNT	PROCEDURE
2. Boneless poultry	1.0 lb	At pause, turn over and separate into pieces. At end, let stand, covered, for 3 to 5 minutes.
3. Bone-in chicken pieces	2.0 lb	At pause, turn over and separate into pieces. At end, let stand, covered, for 3 to 5 minutes.



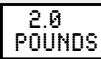



NOTE: SuperDefrost provides just enough defrosting that the foods can be used in recipes or for cooking. There will be some ice crystals remaining.

5. COMPUDEFROST

CompuDefrost automatically defrosts all the foods found in the CompuDefrost Chart below.

- Suppose you want to defrost a 2.0 pound steak.

PROCEDURE	DISPLAY
1  Touch CompuDefrost pad once.	 
2  x 2 Touch CompuDefrost pad two more times to select steak.	   
3   Enter weight by touching the number pads 2 and 0. (Ex: 2.0 lb steak.)	 
4  Touch START/Touch On pad. The oven will stop so the food can be checked. The display will show:	  

5 After the 1st stage, open the door. Turn steak over and shield any warm portions. Close the door.	 Touch START/Touch On pad.
6 After the 2nd stage, open the door. Shield any warm portions. Close the door.	   Touch START/Touch On pad.
7 After defrost cycle ends, follow the directions.	 

NOTE:

- To defrost other food or foods above or below the weights allowed on the CompuDefrost Chart, use time and 30% power. See Manual Defrost on page 11.
- CompuDefrost can be programmed with More or Less Time Adjustment. Touch the Power Level pad once or twice before touching START/Touch On pad.
- Touch Custom Help pad when the HELP indicator is lighted in the display for a helpful hint.
- If you attempt to enter more or less than the amount as indicated in the chart below, an error message will appear in the display.

COMPU DEFROST CHART

FOOD	AMOUNT	PROCEDURE
1. Ground meat	.5 - 3.0 lb	Remove any thawed pieces after each stage. Let stand, covered, for 5 to 10 minutes.
2. Steaks, chops or fish	.5 - 4.0 lb	After each stage, rearrange and if there are warm or thawed portions, shield with small flat pieces of aluminum foil. Remove any meat or fish that is almost defrosted. Let stand, covered, for 10 to 20 minutes.
3. Chicken pieces	.5 - 3.0 lb	After each stage, rearrange pieces or remove portions should they become warm or thawed. Let stand, covered, for 10 to 20 minutes.

SPECIAL FEATURES

COMPU DEFROST CHART (CONTINUED)

FOOD	AMOUNT	PROCEDURE
4. Roast	2.0 - 4.0 lb	Start defrosting with fat side down. After each stage, turn roast over and shield the warm portions with aluminum foil. Let stand, covered, for 30 to 60 minutes.
5. Casserole	2 - 6 cups	After audible signal, stir if possible. At end, stir well and let stand, covered, for 5 to 10 minutes.
6. Soup	1 - 6 cups	After audible signal, stir if possible. At end, stir well and let stand, covered, for 5 to 10 minutes.

NOTE: Check foods when oven signals. After final stage, small sections may still be icy. Let stand to continue thawing. Do not defrost until all ice crystals are thawed. Shielding prevents cooking from occurring before the center of the food is defrosted. Use small smooth strips of aluminum foil to cover edges and thinner sections of the food.

6. BEVERAGE CENTER

Beverage Center enables you to reheat coffee or tea to restore to a more suitable drinking temperature or to make instant coffee or tea.

- Suppose you want to make 2 cups of coffee.

PROCEDURE	DISPLAY
1 Touch Beverage Center pad.	REPEAT TO SELECT OPTIONS
2 Touch Beverage Center pad once more. 1 x 2 Touch number 1 pad 2 times.	TO MAKE COFFEE OR TEA CONTINUE PRESSING 1 FOR CUPS 2 CUPS PRESS START
3 Touch START/Touch On pad.	

NOTE:

1. Beverage Center can be programmed with More or Less Time Adjustment. Touch the Power Level pad once or twice after selecting the amount. See page 24.
2. Touch Custom Help pad when the HELP indicator is lighted in the display, for a helpful hint.
3. Should you attempt to enter more or less than the allowed amount, an error message will appear in the display.

More or less than the quantity listed in the chart should be made following the guidelines in any microwave book.

BEVERAGE CENTER CHART

FOOD	AMOUNT	PROCEDURE
Make coffee/tea	1 - 4 cups	Use this setting for heating COLD TAP WATER to a temperature somewhat below the boiling point to make instant coffee or tea. Touch number 1 pad for 1 cup increase per touch. Stir liquid briskly before and after heating to avoid "eruption".
Reheat	.5 - 2.0 cups	This setting is good for restoring cooled beverage to a better drinking temperature. Touch number 2 pad for a 0.5 cup increase per touch. Stir after heating.

OTHER CONVENIENT FEATURES

MULTIPLE SEQUENCE COOKING

Your oven can be programmed for up to 4 automatic cooking sequences, switching from one power level setting to another automatically.

Sometimes cooking directions tell you to start on one power level and then change to a different power level. Your oven can do this automatically.

- Suppose you want to cook roast beef for 5 minutes at 100% and then continue to cook for 30 minutes at 50%.

PROCEDURE	
1	First enter cooking time. Then touch Power Level pad twice for 100% power.
	<div style="display: flex; align-items: center; gap: 10px;"> <div style="border: 1px solid black; padding: 2px 5px;">5</div> <div style="border: 1px solid black; padding: 2px 5px;">0</div> <div style="border: 1px solid black; padding: 2px 5px;">0</div> </div> <div style="display: flex; align-items: center; margin-top: 5px;"> <div style="border: 1px solid black; padding: 2px 5px; font-size: small;">Power Level</div> x 2 </div>
2	Then enter second cooking time. Touch Power Level pad. Touch number pad 5 for 50% power.
	<div style="display: flex; align-items: center; gap: 10px;"> <div style="border: 1px solid black; padding: 2px 5px;">3</div> <div style="border: 1px solid black; padding: 2px 5px;">0</div> <div style="border: 1px solid black; padding: 2px 5px;">0</div> <div style="border: 1px solid black; padding: 2px 5px;">0</div> </div> <div style="display: flex; align-items: center; margin-top: 5px;"> <div style="border: 1px solid black; padding: 2px 5px; font-size: small;">Power Level</div> <div style="border: 1px solid black; padding: 2px 5px; margin-left: 10px;">5</div> </div>
3	Touch START/Touch On pad.
	<div style="border: 1px solid black; padding: 2px 5px; text-align: center; font-size: small;">START Touch On</div>

NOTE:

1. If Power Level pad is touched twice,

HIGH POWER

 will be displayed.
2. If 100% is selected as the final sequence, it is not necessary to touch the Power Level pad.
3. If you wish to know power level, simply touch the Power Level pad. As long as your finger is touching the Power Level pad, the power level will be displayed.

MORE OR LESS TIME ADJUSTMENT

Should you discover that you like any of the Sensor Cooking or More from your Microwave settings slightly **more** done, touch the Power Level pad once after touching your choice of pads. The display will show

MORE

PRESS START

 . Touch **START/Touch On** pad.

Should you discover that you like any of the Sensor Cooking or More from your Microwave settings slightly **less** done, touch the Power Level pad twice after touching your choice of pad. The display will show

LESS

PRESS START

 . Touch **START/Touch On** pad.

MEMORY COOK

TO SET MEMORY COOK

Memory Cook allows you to set 1 set of cooking instructions in memory for quick recall.

- Suppose you want to program into Memory Cook your favorite cooking instructions for Nachos: 1 minute and 45 seconds at 70% power.

PROCEDURE	DISPLAY
1	<div style="display: flex; justify-content: space-around; align-items: center;"> <div style="border: 1px solid black; padding: 2px 5px; font-size: small;">Memory Cook</div> <div style="border: 1px solid black; padding: 2px 5px; font-size: small;">TO SET PRESS</div> <div style="border: 1px solid black; padding: 2px 5px; font-size: small;">MEMORY COOK</div> </div> <p>Touch Memory Cook pad.</p>
2	<div style="display: flex; justify-content: space-around; align-items: center;"> <div style="border: 1px solid black; padding: 2px 5px; font-size: small;">Memory Cook</div> <div style="border: 1px solid black; padding: 2px 5px; font-size: small;">ENTER</div> <div style="border: 1px solid black; padding: 2px 5px; font-size: small;">COOKING TIME</div> </div> <p>Touch Memory Cook pad again.</p>
3	<div style="display: flex; justify-content: space-around; align-items: center;"> <div style="border: 1px solid black; padding: 2px 5px; font-size: small;">1</div> <div style="border: 1px solid black; padding: 2px 5px; font-size: small;">4</div> <div style="border: 1px solid black; padding: 2px 5px; font-size: small;">5</div> <div style="border: 1px solid black; padding: 2px 5px; font-size: small;">1.45</div> </div> <p>Enter cooking time.</p>
4	<div style="display: flex; justify-content: space-around; align-items: center;"> <div style="border: 1px solid black; padding: 2px 5px; font-size: small;">Power Level</div> <div style="border: 1px solid black; padding: 2px 5px; font-size: small;">7</div> <div style="border: 1px solid black; padding: 2px 5px; font-size: small;">70 PERCENT</div> </div> <p>Touch Power Level pad. Enter number 7 for power level.</p> <p>The display will show:</p> <div style="display: flex; justify-content: space-around; align-items: center;"> <div style="border: 1px solid black; padding: 2px 5px; font-size: small;">PRESS MEMORY</div> <div style="border: 1px solid black; padding: 2px 5px; font-size: small;">COOK</div> </div> <div style="display: flex; justify-content: space-around; align-items: center;"> <div style="border: 1px solid black; padding: 2px 5px; font-size: small;">TO SAVE PROGRAM</div> <div style="border: 1px solid black; padding: 2px 5px; font-size: small;">IN MEMORY</div> </div>
5	<div style="display: flex; justify-content: space-around; align-items: center;"> <div style="border: 1px solid black; padding: 2px 5px; font-size: small;">Memory Cook</div> <div style="border: 1px solid black; padding: 2px 5px; font-size: small;">1.45</div> </div> <p>Touch Memory Cook pad.</p> <p>Note: It is necessary to touch Memory Cook twice to enter the new program. Memory Cook cannot be programmed with turntable off.</p>

TO USE MEMORY COOK

- Suppose you want to cook Nachos with Memory Cook.

PROCEDURE	DISPLAY
1	<div style="display: flex; justify-content: space-around; align-items: center;"> <div style="border: 1px solid black; padding: 2px 5px; font-size: small;">Memory Cook</div> <div style="border: 1px solid black; padding: 2px 5px; font-size: small;">70 PERCENT</div> <div style="border: 1px solid black; padding: 2px 5px; font-size: small;">1.45</div> </div> <p>Touch Memory Cook pad.</p> <div style="border: 1px solid black; padding: 2px 5px; font-size: small; text-align: center; margin-left: auto;">PRESS START</div>
2	<div style="border: 1px solid black; padding: 2px 5px; font-size: small; text-align: center;">START Touch On</div> <p>Touch START/Touch On pad.</p>

OTHER CONVENIENT FEATURES

CUSTOM HELP

Custom Help provides 5 features which make using your oven easy because specific instructions are provided in the Interactive Display.

1. CHILD LOCK

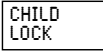
The Child Lock prevents unwanted oven operation such as by small children. The oven can be set so that the control panel is deactivated or locked. To set, touch Custom Help, the number 1 and START/Touch On. Should a pad be touched,  will appear in the display.

To cancel, touch Custom Help and Stop/Clear.

2. AUDIBLE SIGNAL ELIMINATION







If you wish to have the oven operate with no audible signals, touch Custom Help, the number 2 and Stop/Clear.

To cancel and restore the audible signal, touch Custom Help, the number 2 and START/Touch On.

3. AUTO START

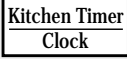
If you wish to program your oven to begin cooking automatically at a designated time of day, follow this procedure:

- Suppose you want to start cooking a stew for 20 minutes on 50% at 4:30. Before setting, check to make sure the clock is set correctly.

PROCEDURE	
1	Touch Custom Help pad. 
2	Touch number 3. 
3	Enter the start time. 
4	Touch Clock pad. 
5	Enter cooking program.  
6	Touch START/Touch On pad. 

NOTE:

1. Auto Start can be used for manual cooking if clock is set.
2. If the oven door is opened after programming Auto Start, it is necessary to touch the START/Touch On pad for Auto Start time to appear in the readout so that the oven will automatically begin programmed cooking at the chosen Auto Start time.

3. Be sure to choose foods that can be left in the oven safely until the Auto Start time. Acorn or butternut squash are often a good choice.
4. If you wish to know the time of day, simply touch the Clock pad. As long as your finger is touching the Clock pad, the time of day will be displayed.

4. & 5. LANGUAGE / WEIGHT SELECTION







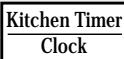

The oven comes set for English and U.S. Customary Unit-pounds. To change, touch Custom Help and the number 4 pads. Continue to touch the number 4 pad until your choice is selected from the table below. Then, touch START/Touch On pad.

Touch number 4 pad for language and standard of weight.

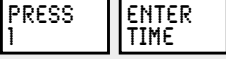
NUMBER	LANGUAGE	STANDARD OF WEIGHT	DISPLAY
Once	English	LBS	ENGLISH LB
Twice	English	KG	ENGLISH KG
3 times	Spanish	LBS	ESPAÑOL LB
4 times	Spanish	KG	ESPAÑOL KG
5 times	French	LBS	FRANCAIS LB
6 times	French	KG	FRANCAIS KG

KITCHEN TIMER

- Suppose you want to time a 3 minute long distance phone call.

PROCEDURE	DISPLAY
1  1	
Touch Kitchen Timer/Clock pad. Press number 1.	
2 	
Enter time.	
3 	Touch Kitchen Timer/Clock pad. The Kitchen Timer will count down.
4 After the Kitchen Timer cycle ends, the display will indicate the following message.	

OTHER CONVENIENT FEATURES

TOUCH ON

Touch On allows you to cook at 100% power by touching the **START/Touch On** pad continuously. Touch On is ideal for melting cheese, bringing milk to just below boiling etc. The maximum cooking time is 3 minutes.

- Suppose you want to melt cheese on a piece of toast.

PROCEDURE

- 1 Continuously touch **START/Touch On** pad. The cooking time will begin counting up. 
- 2 When the cheese is melted to desired degree, remove finger from **START/Touch On** pad. Oven stops immediately.

NOTE:

1. Note time it takes for frequently used foods and program that time in the future.
2. Touch **START/Touch On** pad within 1 minute after cooking, opening and closing the door or touching the **Stop/Clear** pad.
3. Touch On can only be used 3 times in a row. If more times are needed, open and close door or touch **Stop/Clear** pad.

MINUTE PLUS

Minute Plus allows you to cook for a minute at 100% by simply touching the Minute Plus pad. You can also extend cooking time in multiples of 1 minute by repeatedly touching the Minute Plus pad during manual cooking.

- Suppose you want to heat a cup of soup for one minute.

PROCEDURE

- 1 Touch **Minute Plus** pad. 

NOTE:

1. To use Minute Plus, touch pad within 1 minute after cooking, closing the door, touching the **Stop/Clear** pad or during cooking.
2. Minute Plus cannot be used with Special Features.

DEMONSTRATION MODE

To demonstrate, touch Kitchen Timer/Clock, the number 0 and touch **START/Touch On** and hold for 3 seconds.

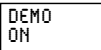
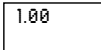
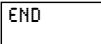
 will appear in the display. Cooking operations and specific special features can now be demonstrated with no power in the oven. For example, touch **Stop/Clear** and touch **Minute Plus**, and the display will show  and count down quickly to .

To cancel, touch Kitchen Timer/Clock, then the number 0 and **Stop/Clear**. If easier, unplug the oven from the electrical outlet, replug and set the clock.

HELP

Whenever **HELP** is lighted in the Interactive Display, touch **Custom Help** to read cooking and operating hints.

WORK LIGHT

Press the **WORK LIGHT** pad one time to turn on and again to turn the light off.

NIGHT LIGHT

Press the **NIGHT LIGHT** pad one time to turn on and again to turn the light off. This setting assures enough light to move about in a darkened kitchen.

FAN HI/LO

The fan will automatically start when heat rises from range surface units or burners. This protects the microwave oven from excessive temperature rise. The fan will stay on until the temperature decreases. It cannot be turned off manually during this time.

For other uses, press **Fan Hi/Lo** pad to select fan speed or turn fan off.

AUTO FAN

The fan can be set to turn off automatically. Touch **Auto Fan** and enter the number of minutes you wish for the fan to operate. It is automatically set for the high fan speed. If you wish to have the low fan speed, touch **Auto Fan**, enter the number of minutes you wish for the fan to operate and then touch **Fan Hi/Lo** once. Touch **Fan Hi/Lo** twice if you wish to stop the fan during operation.

CLEANING AND CARE

Exterior

The outside surface is precoated steel and plastic. Clean the outside with mild soap and water; rinse and dry with a soft cloth. Do not use any type of household or abrasive cleaner.

Door

Wipe the window on both sides with a damp cloth to remove any spills or splatters. Metal parts will be easier to maintain if wiped frequently with a damp cloth. Avoid the use of spray and other harsh cleaners as they may stain, streak or dull the door surface.

Touch Control Panel

Care should be taken in cleaning the touch control panel. If the control panel becomes soiled, open the oven door before cleaning. Wipe the panel with a cloth dampened slightly with water only. Dry with a soft cloth. Do not scrub or use any sort of chemical cleaners. Close door and touch Stop/Clear.

Interior

Cleaning is easy because little heat is generated to the interior surfaces; therefore, there is no baking and setting of spills or spattering. To clean the interior surfaces, wipe with a soft cloth and warm water. **DO NOT USE ABRASIVE OR HARSH CLEANERS OR SCOURING PADS.** For heavier soil, use baking soda or a mild soap; rinse thoroughly with hot water. The rack can be cleaned with hot soapy water, rinsed and dried.

Waveguide Cover

The waveguide cover is located on the ceiling in the oven cavity. It is made from mica so requires special care. Keep the waveguide cover clean to assure good oven performance. Carefully wipe with a damp cloth any food splatters from the surface of the cover immediately after they occur. Built-up splashes may overheat and cause smoke or possibly catch fire. **DO NOT REMOVE THE WAVEGUIDE COVER.**

Odor Removal

Occasionally, a cooking odor may remain in the oven. To remove, combine 1 cup water, grated peel and juice of 1 lemon and several whole cloves in a 2-cup glass measuring cup. Boil for several minutes using 100% power. Allow to set in oven until cool. Wipe interior with a soft cloth.

Turntable/Turntable Support

The turntable and turntable support can be removed for easy cleaning. Wash them in mild, sudsy water; for stubborn stains use a mild cleanser and non-abrasive scouring sponge. They are also dishwasher-proof. Use upper rack of dishwasher. The turntable motor shaft is not sealed, so excess water or spills should be wiped up immediately.



Turntable

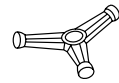

Turntable Support

Grease Filters

Filters should be cleaned at least once a month. Never operate the fan or oven without the filters in place.

1. Pull down slightly on the tab toward the front of the oven and remove the filter. Repeat for the other filter.
2. Soak the filters in a sink or dish pan filled with hot water and detergent. **DO NOT** use ammonia or other alkali; they will react with the filter material and darken it.
3. Agitate and scrub with a brush to remove embedded dirt.
4. Rinse thoroughly and shake dry.
5. Replace by fitting the filter back into the opening.

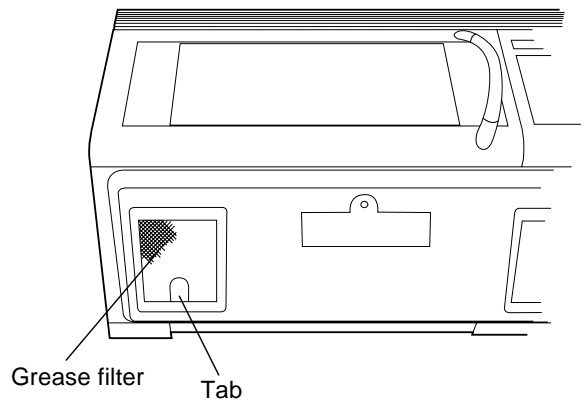

REPLACING PARTS

CHARCOAL FILTER

Charcoal Filter, Sharp Part number RK-230 which was enclosed with your oven, is used for nonvented, recirculated installation. The filter should be changed every 6 to 12 months depending on use. See page 4 for ordering information.

1. Disconnect power to the oven at the circuit breaker panel or by unplugging.
2. Remove the louver mounting screw from the top center of the louver and push down carefully on the tab at each end of the louver to disengage it. (See illustration.)
3. Pull the louver away from the unit.
4. Change the charcoal filter.
5. Carefully push the louver back into place (engaging both the bottom and top tabs) and replace the screw removed in step 2.

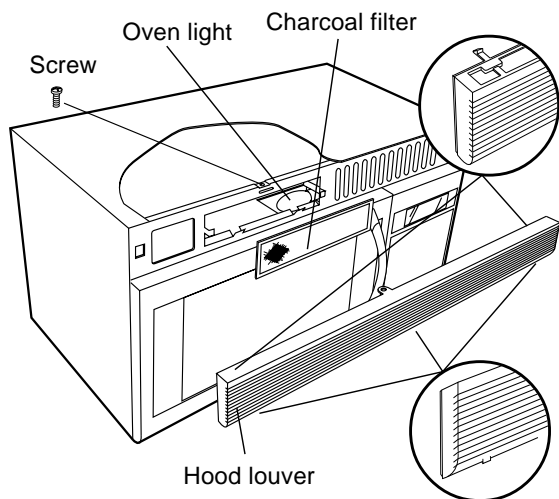

OVEN LIGHT

Remove the louver per instructions 1-3 above and charcoal filter, if used.

1. To replace light bulb, first disconnect power to the oven at the circuit breaker panel or by unplugging.

2. Open light cover located behind filter mounting by carefully pulling up on the front edge.
3. Remove old light bulb and replace only with equivalent watt bulb available from a Sharp Authorized Servicer or parts distributor. Bulbs are also available at most hardware stores or lighting centers. **DO NOT USE BULB LARGER THAN 30 WATTS.**
4. Replace the oven light cover by carefully pushing into place. Replace the charcoal filter, if used. Push the louver back into place and replace the louver mounting screw.

WORK LIGHT AND NIGHT LIGHT

1. To replace light bulbs, first disconnect power to the oven at the circuit breaker panel or by unplugging.
2. To release cover, remove the screw on the light cover. (See illustration.)
3. Replace light bulbs with equivalent watt bulb available from your Sharp Authorized Servicer or parts distributor. Bulbs are also available at most hardware stores or lighting centers. **DO NOT USE A BULB LARGER THAN 30 WATTS.**
4. Close light cover and secure with screw removed in step 2.

CAUTION: Light cover may become very hot. Do not touch glass when light is on.

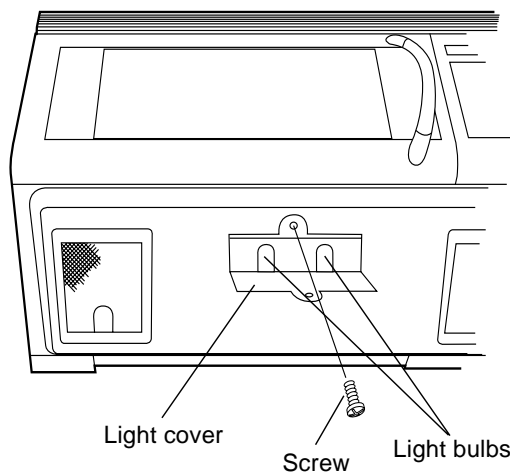

SPECIFICATIONS

R-1610 / R-1611 / R-1612

AC Line Voltage:	Single phase 120V, 60Hz, AC only
AC Power Required:	1640W 14.0 amps.
Output Power:	1000W* (IEC Test Procedure)
Frequency:	2450 MHz
Outside Dimensions (not including handle):	29 ¹⁵ / ₁₆ "(W) x 16 ³ / ₈ "(H) x 16 ¹⁵ / ₁₆ "(D)
Cavity Dimensions:	21"(W) x 8 ⁷ / ₈ "(H) x 14 ⁷ / ₁₆ "(D)
Oven Capacity:	1.6 Cu.Ft.
Cooking Uniformity:	Turntable / Stirrer Fan System
Weight:	Approx. (net) 55 lb, (gross) 60 lb
Work/Night Light:	2 bulbs 30w max. each (incandescent light bulbs)

★ The International Electrotechnical Commission's standardized method for measuring output wattage. This test method is widely recognized.

In compliance with standards set by:

FCC – Federal Communications Commission Authorized.

DHHS – Complies with Department of Health and Human Services (DHHS) rule, CFR, Title 21, Chapter I, Subchapter J.



– This symbol on the nameplate means the product is listed by Underwriters Laboratories, Inc.

THE ULTIMATE ACCESSORY

- ★ **Great recipes**
- ★ **Reliable microwave reference guide**
- ★ **Many color photos**
- ★ **Step-by-step instructions**
- ★ **Nutritional information for each recipe**
- ★ **Durable wipe-clean soft cover with 128 8 1/2 x 11 pages**
- ★ **Helpful tips and special techniques**

SHARP®

CAROUSEL MICROWAVE COOKBOOK

TO ORDER

Simply call this toll-free number : **1-800-642-2122**. Please have your credit card ready.

If you prefer to order by mail, complete and return the order form on page 30. Please include check or money order (payable to Sharp Accessories & Supplies Center) for \$6.00 plus \$4.25 shipping & handling and tax, if applicable, per book.

SATISFACTION GUARANTEED

You must be completely satisfied with the Sharp Carousel Microwave Cookbook. If, within 14 days, you are dissatisfied for any reason, simply return the book and we'll gladly refund your \$6.00 plus tax.

(SOLAMENTE ESCRITO EN INGLES!)

SERVICE CALL CHECK

Please check the following before calling for service:

Place one cup of water in a glass measuring cup in the oven and close the door securely.
Operate the oven for one minute at HIGH 100%.

- A Does the oven light come on? YES _____ NO _____
- B Does the cooling fan work? YES _____ NO _____
(Put your hand on the louver above the Interactive Display.)
- C Does the turntable rotate? YES _____ NO _____
(It is normal for the turntable to turn in either direction unless
the display indicates

TURN- TABLE

OFF

 .)
- D Is the water in the oven warm? YES _____ NO _____

If "NO" is the answer to any of the above questions, please check electrical outlet, fuse and/or circuit breaker. If they are functioning properly, CONTACT YOUR NEAREST SHARP AUTHORIZED SERVICER. A microwave oven should never be serviced by a "do-it-yourself" repair person.

NOTE: If time appearing in the display is counting down very rapidly, check Demonstration Mode on page 26 and cancel.

Cut along this line.

COOKBOOK ORDER FORM

Please send me _____ cookbooks at \$10.25 each \$ _____
Illinois sales tax, (if applicable) per book \$.44 no. of books _____ \$ _____
Other tax, (if applicable) no. of books _____ \$ _____

TOTAL ORDER AMOUNT \$ _____

- I have enclosed a check made payable to Sharp Accessories & Supplies Center.
 Please bill my VISA MASTERCARD AMERICAN EXPRESS

Acct. No. _____ Expiration date ____ / ____

Signature _____
(All credit card orders must be signed.)

Name _____

Address _____

City _____ State _____ Zip _____



Daytime Phone No. () _____

Mail to: SHARP Accessories & Supplies Center Price is subject to change without notice.
2130 Townline Road
Peoria, Illinois 61615-1560

Si desea leer información más completa y precauciones de seguridad para el manejo del horno, consulte el manual de operaciones.

PARA FIJAR LA HORA

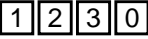
Si el indicador dice SHARP SIMPLY THE BEST PRESS CLEAR AND PRESS CLOCK, toque primero el botón **Stop/Clear**.

- 1 Toque el botón **Kitchen Timer/Clock**. 
- 2 Marque la hora correcta en el reloj tocando los botones numéricos en el orden respectivo. (Ej: 12:30) 
- 3 Toque nuevamente el botón **Kitchen Timer/Clock**. 

COCCIÓN CON SENSOR





- 1 Toque el botón **Baked potatoes**. 
- 2 Toque el botón **START/Touch On**. 

TABLA DE COCCIÓN CON SENSOR

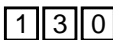

ALIMENTO	CANTIDAD
Palomitas de maíz	3.0 - 3.5 oz (Regular) 1.5 - 3.5 oz (Snack)
Sensor de recalentar	4 - 36 oz
Papa asada	1 - 6 med.
Verdura: Suave	.25 - 2.0 libras
Firme	.25 - 1.5 libras
Plato fuerte congel.	6 - 17 oz
Bocadillo congel.	3 - 8 oz
Vedura congel.	.25 - 1.25 libras
Carne molida	.25 - 2.0 libras
Arroz	.5 - 2.0 tazas
Aves: Sin hueso	.5 - 2.0 libras
Con hueso	.5 - 3.0 libras
Pescado/mariscos	.25 - 2.0 libras

OPERACIÓN MANUAL

COCCIÓN DE ALTA POTENCIA

- 1 Toque los botones numéricos para asignar el tiempo de cocción. (Ej: 1 min. 30 seg.) 
- 2 Toque el botón **START/Touch On**. 

COCCIÓN DE POTENCIA VARIABLE

- 1 Después de realizar la operación 1 descrita arriba, toque el botón **Power Level**. 
- 2 Seleccione un nivel de potencia. (Ej: 50%.) 
- 3 Toque el botón **START/Touch On**. 

TOUCH ON





Toque sin interrupción el botón que dice **START/Touch On** para cocinar con un 100% de potencia. En cuanto quite el dedo el horno se detendrá instantáneamente. 

MINUTO EXTRA

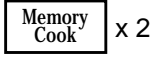

Toque el botón **Minute Plus** durante un minuto al 100% de potencia para aumentar un minuto en el tiempo de cocción manual. Continúe tocándolo si necesita aumentar más minutos. 

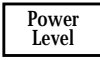
MEMORY COOK

PARA PROGRAMAR MEMORY COOK

- 1 Pulse la tecla **Memory Cook** dos veces y programe el tiempo de cocción. (Ej: Pulse el numero 1, 4 y 5 para 1 minuto y 45 segundos.) 

- 2 Pulse la tecla **Power Level** el botón numérico para el nivel deseado. (Ej. Pulse el numero 7 para 70%.) 

- 3 Pulse la tecla **Memory Cook**. 

PARA UTILIZAR MEMORY COOK

- 1 Pulse la tecla **Memory Cook**. El nivel programado se mostrara en la pantalla. 
- 2 Pulse la tecla **START/Touch On**. 

BREAKFAST BAR





- 1 Toque el botón **Breakfast Bar**. 
- 2 Seleccione la comida deseada. (Ej: toque el botón Breakfast Bar 3 veces más para cereales calientes.) 

- 3 Toque el botón número 2 para dos raciones.
- 4 Toque el botón **START/Touch On**. 

TABLA BREAKFAST BAR

ALIMENTO	CANTIDAD
1. Huevos revueltos	1 - 9 huevos
2. Toino	2 - 6 rebanadas
3. Cereal caliente	1 - 6 porciones
4. Calentar pan fresco	1 - 8 piezas
5. Alimentos congel. de desayuno	1 (3 - 6 oz)

Continuado en la pagina 32.

Continuación de la página 31.

LUNCH ON THE RUN



- 1 Toque el botón **Lunch on the Run.** 
- 2 Seleccione la comida deseada.
(Ej: toque el botón Lunch on the Run 3 veces más para sopa.)  x 3
- 3 Toque el botón **START/Touch On.** 

TABLA LUNCH ON THE RUN

ALIMENTO	CANTIDAD
1. Comida en una taza	1 (6 - 8 oz)
2. Hot dog en su pan	1 - 4
3. Sopa	1 - 6 tazas
4. Pizza de microondas	1 (6 - 8 oz)
5. Emparedado	1 (3 - 6 oz)

SUPER DEFROST

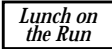

- 1 Toque el botón **SuperDefrost.** 
- 2 Seleccione la comida deseada.
(Ej: toque el botón SuperDefrost 2 veces más para descongelar 1.0 libra de pollo sin huesos.)  x 2
- 3 Toque el botón **START/Touch On.** Durante la descongelación, el horno se parará; siga las indicaciones. Toque el botón **START/Touch On** para continuar descongelando. 

TABLA DE SUPER DEFROST

ALIMENTO	CANTIDAD
1. Carne molida	1.0 libras
2. Pollo sin hueso	1.0 libras
3. Pollo con hueso	2.0 libras

BEVERAGE CENTER







- 1 Toque el botón **Beverage Center.** 
- 2 Seleccione el ajuste Beverage Center deseado. (Ej: toque el botón Beverage Center 2 veces más para volver a calentar café.)  x 2
- 3 Toque el botón número 2 4 veces para 2 tazas.  x 4
- 4 Toque el botón **Start/Touch On.** 

TABLA BEVERAGE CENTER

ALIMENTO	CANTIDAD
1. Hacer café o té	1 - 4 tazas
2. Recalentar	.5 - 2.0 tazas

ONE DISH DINNERS

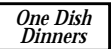
- 1 Toque el botón **One Dish Dinners.** 
- 2 Seleccione la comida deseada.
(Ej: toque el botón One Dish Dinners una vez más para carne picada.) 
- 3 Toque el botón **START/Touch On.** 

GUÍA DE MENÚ PARA ONE DISH DINNERS

ALIMENTO	RECETA (Todos menús para 6 raciones)
1. Cena de carne	<ul style="list-style-type: none"> • "Cuscus" condimentado con pan • Carne picada y verduras cubiertas con puré
2. Cena de pollo	<ul style="list-style-type: none"> • Arroz amarillo con pollo • Pollo con relleno de frutas
3. Cena de cerdo o res	<ul style="list-style-type: none"> • Puerco agridulce con arroz • Carne de vaca con brécol y arroz
4. Cena de mariscos	<ul style="list-style-type: none"> • Pasta cremosa con mariscos • "Fusilli" griego con berenjenas y camarones
5. Cena de vegetales	<ul style="list-style-type: none"> • Verduras gratinadas • Orzo con tomates secados al sol y alcachofas

CONSULTE LA TARJETA DE RECETAS PARA CONOCER DETALLES.

COMPU DEFROST





- 1 Toque el botón **CompuDefrost.** 
- 2 Seleccione la comida deseada.
(Ej: toque el botón **Compu Defrost** 2 veces más para descongelar un filete de carne.)  x 2
- 3 Toque los botones número 2 y 0 para 2.0 libras.
(Ej: filete de 2.0 libras.)  
- 4 Toque el botón **START/Touch On.** Durante la descongelación, el horno se parará; siga las indicaciones. Toque el botón **START/Touch On** para continuar descongelando. 



TABLA DE COMPU DEFROST

ALIMENTO	CANTIDAD
1. Carne molida	.5 - 3.0 libras
2. Bistec, chuleta o pescado	.5 - 4.0 libras
3. Piezas de pollo	.5 - 3.0 libras
4. Asado	2.0 - 4.0 libras
5. Caserola	2 - 6 tazas
6. Sopa	1 - 6 tazas

Carousel® y Auto-Touch® son marcas registradas de Sharp Corporation.

Continued from Back Cover



LUNCH ON THE RUN

- 1 Touch **Lunch on the Run** pad. 
- 2 Select desired food. (Ex: touch Lunch on the Run pad 3 more times for soup.)  x 3
- 3 Touch **START/Touch On** pad. 

LUNCH ON THE RUN CHART

FOOD	AMOUNT
1. Meal in a cup	1 cup (6 - 8 oz)
2. Hot dogs in buns	1 - 4
3. Soup	1 - 6 cups
4. Microwave pizza	1 (6 - 8 oz)
5. Frozen sandwich	1 (3 - 6 oz)





SUPER DEFROST

- 1 Touch **SuperDefrost** pad. 
- 2 Select desired food. (Ex: touch SuperDefrost pad 2 more times to defrost 1.0 lb boneless poultry.)  x 2
- 3 Touch **Start/Touch On** pad. During defrosting, the oven will stop; follow the directions. Touch **Start/Touch On** pad to continue defrosting. 

SUPER DEFROST CHART

FOOD	AMOUNT
1. Ground meat	1.0 lb
2. Boneless poultry	1.0 lb
3. Bone-in chicken pieces	2.0 lb



BEVERAGE CENTER

- 1 Touch **Beverage Center** pad. 
- 2 Select desired Beverage Center setting. (Ex: touch Beverage Center pad 2 more times to reheat coffee.)  x 2
- 3 Touch number 2 pad 4 times for 2 cups.  x 4
- 4 Touch **START/Touch On** pad. 

BEVERAGE CENTER CHART

FOOD	AMOUNT
1. Make coffee/tea	1 - 4 cups
2. Reheat	.5 - 2.0 cups

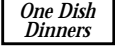
ONE DISH DINNERS





- 1 Touch **One Dish Dinners** pad. 
- 2 Select desired food. (Ex: touch One Dish Dinners pad once more for ground beef.) 
- 3 Touch **START/Touch On** pad. 

ONE DISH DINNERS CHART

FOOD	RECIPES (All are for 6 servings)
1. Ground beef dinner	<ul style="list-style-type: none"> • Spicy Couscous Pockets • Speedy Shepherd's Pie
2. Chicken dinner	<ul style="list-style-type: none"> • Yellow Rice with Chicken • Chicken with Fruited Stuffing
3. Beef or pork dinner	<ul style="list-style-type: none"> • Sweet and Sour Pork with Rice • Beef with Broccoli and Rice
4. Seafood dinner	<ul style="list-style-type: none"> • Creamy Seafood Pasta • Greek Fusilli with Eggplant and Shrimp
5. Vegetarian dinner	<ul style="list-style-type: none"> • Garden Au Gratin • Orzo with Sun-Dried Tomatoes and Artichokes

SEE RECIPE CARD FOR DETAILS.

COMPU DEFROST

- 1 Touch **CompuDefrost** pad. 
- 2 Select desired food. (Ex: touch **CompuDefrost** pad 2 more times to defrost Steak.)  x 2
- 3 Touch number pads 2 and 0 for 2.0 lb. (Ex: 2.0 lb steak.)  
- 4 Touch **START/Touch On** pad. During defrosting, the oven will stop; follow the directions. Touch **START/Touch On** pad to continue defrosting. 

COMPU DEFROST CHART

FOOD	AMOUNT
1. Ground meat	.5 - 3.0 lb
2. Steaks, chops or fish	.5 - 4.0 lb
3. Chicken pieces	.5 - 3.0 lb
4. Roast	2.0 - 4.0 lb
5. Casserole	2 - 6 cups
6. Soup	1 - 6 cups

AUTO-TOUCH® GUIDE

For more complete information and safety precautions, refer to your Operation Manual.

SET CLOCK

If SHARP SIMPLY THE BEST PRESS CLEAR AND PRESS CLOCK is in the display, first touch Stop/Clear.

1 Touch **Kitchen Timer/Clock** pad.

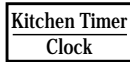

2 Enter correct time of the day by touching numbers in sequence. (Ex: 12:30)

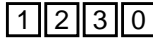

3 Touch **Kitchen Timer/Clock** pad again.



SENSOR COOKING

1 Touch **Baked potatoes** pad.

Baked potatoes

2 Press **START/Touch On**.



SENSOR COOKING CHART

FOOD	AMOUNT
Popcorn	1 package 3.0 - 3.5 oz (Regular) 1.5 - 3.5 oz (Snack)
Sensor reheat	4 - 36 oz
Baked potatoes	1 - 6 med.
Fresh vegetables:	
Soft	.25 - 2.0 lb
Hard	.25 - 1.5 lb
Frozen entrees	6 - 17 oz
Frozen snacks	3 - 8 oz
Frozen vegetables	.25 - 1.25 lb
Ground meat	.25 - 2.0 lb
Rice	.5 - 2.0 cups
Poultry: Boneless	.5 - 2.0 lb
With bone	.5 - 3.0 lb
Fish/seafood	.25 - 2.0 lb

TOUCH ON

Continuously touch **START/Touch On** pad for 100% power cooking. Remove finger and oven will stop instantly.



MINUTE PLUS

Touch **Minute Plus** for one minute at 100% power or to add a minute during manual cooking. Continue to touch for additional minutes.



MANUAL OPERATION

HIGH POWER COOKING

- 1 Enter cooking time by touching number pads. (Ex: 1 min. 30 sec.)
- 2 Touch **START/Touch On** pad.



VARIABLE POWER COOKING

- 1 After Step 1 above, touch **Power Level** pad.
- 2 Select power level. (Ex: 50%.)
- 3 Touch **START/Touch On** pad.



5



MEMORY COOK

TO SET MEMORY COOK

- 1 Touch **Memory Cook** pad twice and enter cooking time. (Ex: touch number 1, 4 and 5 for 1 minute 45 seconds.)
- 2 Touch **Power Lever** and number pad for desired setting. (Ex: touch number 7 for 70%.)
- 3 Touch **Memory Cook** pad.



7



TO USE MEMORY COOK

- 1 Touch **Memory Cook** pad. The stored settings will show on display.
- 2 Touch **START/Touch On** pad.



BREAKFAST BAR

- 1 Touch **Breakfast Bar** pad.
- 2 Select desired food. (Ex: touch Breakfast Bar pad 3 more times for hot cereal.)
- 3 Touch number 2 pad for 2 servings.
- 4 Touch **START/Touch On** pad.



2



BREAKFAST BAR CHART

FOOD	AMOUNT
1. Scrambled eggs	1 - 9 eggs
2. Bacon	2 - 6 strips
3. Hot cereal	1 - 6 servings
4. Heat rolls/muffins	1 - 8 pieces
5. Frozen breakfast foods	1 (3 - 6 oz)

Carousel® and Auto-touch® are registered trademarks of Sharp Corporation.

Continued on the Inside Back Cover

SHARP SHARP ELECTRONICS CORPORATION
Sharp Plaza, Mahwah, NJ 07430-2135

TINSEB235MRR0
Printed in USA

Download from Wwww.Somanuals.com. All Manuals Search And Download.



Free Manuals Download Website

<http://myh66.com>

<http://usermanuals.us>

<http://www.somanuals.com>

<http://www.4manuals.cc>

<http://www.manual-lib.com>

<http://www.404manual.com>

<http://www.luxmanual.com>

<http://aubethermostatmanual.com>

Golf course search by state

<http://golfingnear.com>

Email search by domain

<http://emailbydomain.com>

Auto manuals search

<http://auto.somanuals.com>

TV manuals search

<http://tv.somanuals.com>