

SHARP®

MICROWAVE OVEN

माइक्रोवेव ओवन

Ⓛ

R-231F

OPERATION MANUAL

संचालन का मैनुयल



SHARP

SHARP CORPORATION

CONTENTS	Pages
Warning	E-1
Special Notes	E-2
Installation Instructions	E-3
Oven Diagram	E-4
Operation of Touch Control Panel	E-5
Control Panel Display	E-5
Touch Control Panel Layout	E-5
Microwave Cooking Techniques	E-6
Before Operating	E-7
Getting Started	E-7
Clock Setting	E-7
Stop/Clear	E-7
To Cancel a Programme	
During Cooking	E-7
Manual Operations	E-8
Microwave Time Cooking	E-8
Sequence Cooking	E-9
Instant Cook	E-9
Increasing Time During a	
Cooking Programme	E-10
Automatic Operations	E-11
Notes for Automatic Operations ...	E-11
Instant Action	E-11
Instant Action Menu Guide	E-12
Express Defrost	E-13
Express Defrost Menu Guide	E-14
Easy Defrost	E-15
East Defrost Menu Guide	E-16
Other Convenient Features	E-17
Less/More Setting	E-17
Timer	E-18
Child Lock	E-18
Demonstration Mode	E-18
Alarm	E-18
Care and Cleaning	E-19
Service Call Check	E-19
Specifications	E-19

विषयसूची	पृष्ठ
चेतावनी	Hi-1
विशेष टिप्पणिया	Hi-2
इंस्टॉलेशन सम्बंधी निर्देश	Hi-3
ओवन का रेखाचित्र	Hi-4
कंट्रोल पैनल का संचालन	Hi-5
टच कंट्रोल पैनल का नक्शा	Hi-5
कंट्रोल पैनल का चित्र	Hi-5
माइक्रोवेव में भोजन पकाने के तरीके	Hi-6
शुरू करने से पहले	Hi-7
शुरूआत	Hi-7
घड़ी की सेटिंग	Hi-7
स्टॉप/क्लियर	Hi-7
भोजन पकाते समय प्रोग्राम कैंसल	
करने के लिए	Hi-7
हाथ से चलाना	Hi-8
माइक्रोवेव टाइम कुकिंग	Hi-8
क्रमवार भोजन पकाना	Hi-9
इंस्टैंट कुक	Hi-9
कुकिंग प्रोग्राम चलते वक्त	
समय बढ़ाना	Hi-10
स्वचालित संचालन	Hi-11
स्वचालित संचालनों के बारे में नोट	Hi-11
इंस्टैंट एक्शन	Hi-11
इंस्टैंट एक्शन मेन्यू गाइड	Hi-12
एक्सप्रेस डिफ्रॉस्ट	Hi-13
एक्सप्रेस डिफ्रॉस्ट मेन्यू गाइड	Hi-14
ईजी डिफ्रॉस्ट	Hi-15
ईजी डिफ्रॉस्ट मेन्यू गाइड	Hi-16
अन्य सुविधाएं	Hi-17
सेटिंग कम/ज्यादा	Hi-17
टाइमर	Hi-18
चाइल्ड लॉक	Hi-18
डेमॉन्स्ट्रेशन मोड	Hi-18
अलार्म	Hi-18
देखरेख और सफाई	Hi-19
सर्विस कॉल चेक	Hi-19
स्पेसिफिकेशन्स	Hi-19

WARNING

IMPORTANT SAFETY INSTRUCTIONS : READ CAREFULLY AND KEEP FOR FUTURE REFERENCE.

1. To reduce the risk of fire in the oven cavity:
 - a. Do not overcook food.
 - b. Remove wire twist-ties from paper or plastic bags before placing bag in the oven.
 - c. Do not heat oil or fat for deep frying. The temperature of the oil cannot be controlled.
 - d. If materials inside the oven should smoke or ignite, keep oven door closed, turn oven off, and disconnect the power cord, or shut off power at the fuse or circuit breaker panel.
 - e. Attend the oven closely when using disposable containers made from plastic, paper or other combustible material.
 - f. Attend the oven closely when using disposable containers made from plastic, paper or other combustible material.
2. To reduce the risk of explosion and sudden boiling:
 - a. Do not place sealed containers in the oven. Baby bottles fitted with a screw cap or teat are considered to be sealed containers.
 - b. Do not use excessive amount of time.
 - c. When boiling liquids in the oven, use the wide-mouthed container.
 - d. Stand at least for 20 seconds at the end of cooking to avoid delayed eruptive boiling of liquids.
 - e. Stir the liquid before and during cooking. Use extreme care when handling the container or inserting a spoon or other utensil into the container.
3. This oven is for home food preparation only and should only be used for heating, cooking and defrosting food and beverage.
It is not suitable for commercial or laboratory use.
4. Never operate the oven whilst any object is caught or jammed between the door and the oven.
5. Do not try to adjust or repair the oven yourself.
It is hazardous for anyone other than a qualified service technician trained by SHARP to carry out any service or repair operation which involves the removal of a cover which gives protection against exposure to microwave energy.
6. Do not operate the oven if it is not working correctly or damaged until it has been repaired by a qualified service technician trained by SHARP. It is particularly important that the oven door closes properly and that there is no damage to:
 - (1) Door (warped), (2) Hinges and Latches (broken or loosened),
 - (3) Door Seals, Sealing Surfaces and oven cavity (buckled or deformed),
 - (4) Burn marks on the door seal faces.
7. Do not catch the utensil, your clothes or accessories on the door safety latches when you take out the food from the oven.
8. Should the power supply cord become damaged, it must be replaced with a special cord supplied or approved by the SHARP SERVICE CENTRE. And it must be replaced by a qualified service technician trained by SHARP.
9. Make sure that the power supply cord is undamaged, and that it does not run under the oven or over any hot surface or sharp edges.
10. If the oven lamp fails please consult your dealer or a qualified service technician trained by SHARP.
11. After cooking, use oven mittens when taking out the food and avoid steam burns by directing steam away from the face and hands.
12. Slowly lift the furthest edge of dish's cover and microwave plastic wrap and carefully open popcorn and oven cooking bags away from the face.
13. To prevent the turntable from breaking:
 - a. Before cleaning the turntable with water, leave the turntable to cool.
 - b. Do not put hot foods or hot utensils on the cold turntable.
 - c. Do not put cold foods or cold utensils on the hot turntable.
14. Do not place anything on the outer cabinet.
15. Do not store food or any other items inside the oven.
16. Make sure the utensil does not touch the interior walls during cooking.
17. This appliance is not intended for use by young children or infirm persons without supervision.
18. Only allow children to use the oven without supervision when adequate instructions have been given so that the child is able to use the oven in a safe way and understands the hazards of improper use.
19. Young children should be supervised to ensure that they do not play with the appliance.

SPECIAL NOTES

	DO	DON'T
Eggs, fruits, nuts, seeds vegetables, sausages and oysters	<ul style="list-style-type: none"> * Puncture egg yolks and whites and oysters before cooking to prevent "explosion". * Pierce skins of potatoes, apples, squash, hot dogs and oysters so that steam escapes. 	<ul style="list-style-type: none"> * Cook eggs in shells. This prevents "explosion", which may damage the oven or injure yourself. * Reheat whole eggs. * Overcook oysters. * Dry nuts or seeds in shells.
Popcorn	<ul style="list-style-type: none"> * Use specially bagged popcorn for the microwave oven. * Listen while popping corn for the popping to slow to 1-2 seconds. 	<ul style="list-style-type: none"> * Pop popcorn in regular brown bags or glass bowls. * Exceed maximum time on popcorn package.
Baby food	<ul style="list-style-type: none"> * Transfer baby food to small dish and heat carefully, stirring often. Check for suitable temperature to prevent burns. * Remove the screw cap and teat before warming baby bottles. After warming shake thoroughly. Check for suitable temperature. 	<ul style="list-style-type: none"> * Heat disposable bottles. * Overheat baby bottles. Only heat until warm. * Heat bottles with nipples on. * Heat baby food in original jars.
General	<ul style="list-style-type: none"> * Food with filling should be cut after heating, to release steam and avoid burns. * Use a deep bowl when cooking liquids or cereals to prevent boiling over. 	<ul style="list-style-type: none"> * Heat or cook in closed glass jars or airtight containers. * Deep fry fat. * Dry wood, herbs, or wet papers, clothes or flowers. * Operate the oven empty except the directed case in the operation manual.
Liquids (Beverages)	<ul style="list-style-type: none"> * For boiling or cooking liquids see WARNING on page E-1 to prevent the explosion and delayed eruptive boiling. 	<ul style="list-style-type: none"> * Heat for longer than recommended time.
Canned foods	<ul style="list-style-type: none"> * Remove food from can. 	<ul style="list-style-type: none"> * Heat or cook food while in cans.
Sausage rolls, Pies, Christmas pudding	<ul style="list-style-type: none"> * These foods have high sugar and/or fat contents. * Cook for the recommended time. 	<ul style="list-style-type: none"> * Overcook as they may catch fire.
Meats	<ul style="list-style-type: none"> * Use a microwave proof rack or plate to collect drained juices. 	<ul style="list-style-type: none"> * Place meat directly on the turntable for cooking.
Utensils	<ul style="list-style-type: none"> * Check the utensils are suitable for MICROWAVE cooking before you use them. 	<ul style="list-style-type: none"> * Use metal utensils for MICROWAVE cooking. Metal reflects microwave energy and may cause an electrical discharge known as arcing.
Aluminium foil	<ul style="list-style-type: none"> * Use to shield food to prevent over cooking. * Watch for sparkling, therefore reduce foil and keep clear of cavity walls. 	<ul style="list-style-type: none"> * Use too much. * Shield food close to cavity walls as sparkling can damage the oven.

INSTALLATION INSTRUCTIONS

1. Remove all packing materials from the oven cavity, (do not remove the waveguide cover, item 10 on page E-4), and the feature sticker from the outside of the door, if there is one. Check the unit for any damage, such as a misaligned door, damaged door seals around the door or dents inside the oven cavity or on the door. If there is any damage, please do not operate the oven until it has been checked by a SERVICE CENTRE APPROVED BY SHARP and repaired, if necessary.
2. Accessories provided
 - 1) Turntable
 - 2) Roller stay
 - 3) Operation manual
3. Fit the roller stay and turntable referring to OVEN DIAGRAM on page E-4. Place the roller stay on the bottom of oven and seat the turntable on the roller stay, while aligning well with the coupling in the centre. NEVER use the oven without the turntable and roller stay.
4. The oven should not be installed in any area where heat and steam are generated, for example, next to a conventional oven unit.

The oven should be installed so as not to block ventilation openings.
Allow at least 15cm on top of the oven for free air space.
This oven is not designed to be built-in to a wall or cabinet.
5. Neither the manufacturer nor the distributors can accept any liability for damage to the machine or personal injury for failure to observe the correct electrical connecting procedure.
The A.C. voltage and frequency must correspond to the one indicated on the rating plate.
6. **WARNING-THIS APPLIANCE MUST BE EARTHED.**

If the socket outlet in your house is not compatible with the plug supplied, cut-off the mains plug and fit an appropriate type, observing the wiring cord below.
If you are unsure how to do this get help from an electrician.
IMPORTANT - The wires in power supply cord are coloured in accordance with the following code:

Green-and-yellow	:	Earth
Blue	:	Neutral
Brown	:	Live

As the colours of the wires in the power supply cord of this appliance may not correspond with the coloured marking identifying the terminals in your plug, proceed as follows:

The wire which is coloured green-and-yellow must be connected to the terminal in the plug which is marked with the letter E or by the earth symbol \perp or coloured green or green-and-yellow.

The wire which is coloured blue must be connected to the terminal which is marked with the letter N or coloured blue.

The wire which is coloured brown must be connected to the terminal which is marked with the letter L or coloured brown.

NOTE: Under no circumstances should the cut-off plug be inserted into a socket outlet as a serious electric shock may occur.

OVEN DIAGRAM

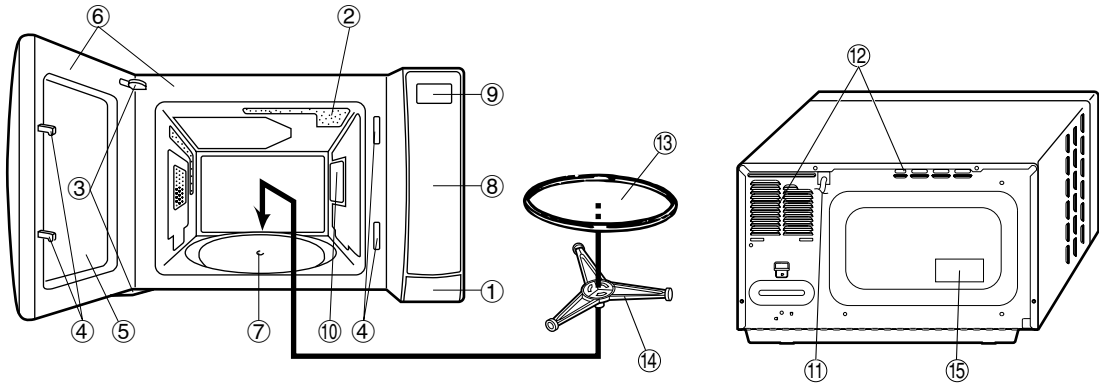

1. Door open button
2. Oven lamp
3. Door hinges
4. Door safety latches
5. See through door
6. Door seals and sealing surfaces
7. Coupling
8. Control panel (See page E-5)
9. Liquid crystal display
10. Waveguide cover
11. Power supply cord
12. Ventilation openings
13. Turntable
14. Roller stay
15. Rating plate

OPERATION OF CONTROL PANEL

The operation of the oven is controlled by pressing the appropriate pads arranged on the surface of the control panel.

An entry signal tone should be heard each time you press the control panel to make a correct entry.

In addition the oven will beep for approximately 2 seconds at the end of the cooking cycle, or 4 times when a cooking procedure is required.

Control Panel Display



Touch Control Panel Layout

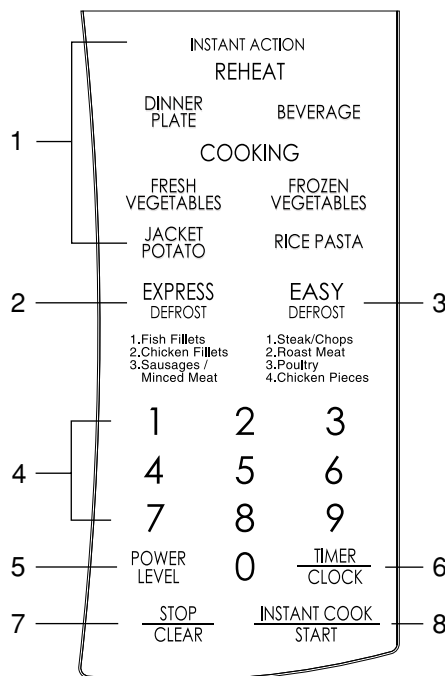



1. **INSTANT ACTION PADS**
Press to cook or reheat 6 popular menus.
2. **EXPRESS DEFROST PAD**
Press to select the Express Defrost menu.
3. **EASY DEFROST PAD**
Press to select the Easy Defrost menu.
4. **NUMBER PADS**
Press to enter cooking time, clock time, weight of food.
5. **POWER LEVEL PAD**
Press to select microwave power setting.
If not pressed, 100% power is automatically selected.
Press to alter the cooking result for automatic operations.
6. **TIMER/CLOCK PAD**
Press to set clock, timer, child lock or demonstration mode.
7. **STOP/CLEAR PAD**
Press to clear during programming.
Press once to stop operation of oven during cooking; press twice to cancel cooking programme.
8. **INSTANT COOK/START PAD**
Press once to cook for 1 minute at 100% or increase by 1 minute multiples each time this pad is pressed during cooking.
Press to start oven after setting programmes.

MICROWAVE COOKING TECHNIQUES

<u>Arrange food carefully</u>	Place thickest areas toward outside of dish.
<u>Watch cooking time</u>	Cook for the shortest amount of time indicated and add more time as needed. Food severely over-cooked can smoke or ignite.
<u>Cover foods before cooking</u>	Check recipe for suggestions: paper towels, microwave plastic wrap or a lid. Covers prevent spattering and help foods to cook evenly. (Helps keep oven clean)
<u>Shield foods</u>	Use small pieces of aluminium foil to cover thin areas of meats or poultry in order to avoid overcooking.
<u>Stir foods</u>	From outside to center of dish once or twice during cooking, if possible.
<u>Turn foods</u>	Foods such as chicken, hamburgers or steaks should be turned over once during cooking.
<u>Rearrange foods</u>	Like meatballs halfway through cooking both from top to bottom and from the center of the dish to the outside.
<u>Allow standing time</u>	After cooking ensure adequate standing time. Remove food from oven and stir if possible. Cover for standing time which allows the food to finish cooking without overcooking.
<u>Check for doneness</u>	Look for signs indicating that cooking temperature has been reached. Doneness signs include: <ul style="list-style-type: none"> - Food steams throughout, not just at edge. - Poultry thigh joints move easily. - Poultry show no pinkness. - Fish is opaque and flakes easily with a fork.
<u>Condensation</u>	A normal part of microwave cooking. The humidity and moisture in food will influence the amount of moisture in the oven. Generally, covered foods will not cause as much condensation as uncovered foods. Ensure that the ventilation openings are not blocked.
<u>Browning dish</u>	When using a browning dish or self-heating material, always place a heat-resistant insulator such as a porcelain plate under it to prevent damage to the turntable, roller stay and coupling due to heat stress. The preheating time specified in the dish's instructions must not be exceeded.
<u>Microwave safe plastic wrap</u>	For cooking food with high fat content, do not bring the wrap in contact with the food as it may melt.
<u>Microwave safe plastic cookware</u>	Some microwave safe plastic cookware are not suitable for cooking foods with high fat and sugar content.

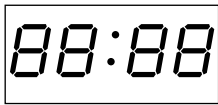

BEFORE OPERATING

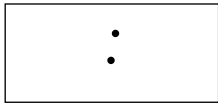
Getting Started

Step	Procedure	Pad Order	Display
1	Ensure the oven door is closed. Plug the oven into a power point and switch on the power.		 Flashing eights
2	Press the STOP/CLEAR pad so that the oven beeps.		 Only the dots will remain.

Clock Setting

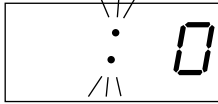
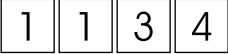
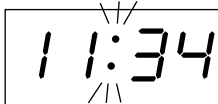
* To enter the present time of day 11:34 (AM or PM).

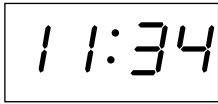
Step	Procedure	Pad Order	Display
1	Press the TIMER/CLOCK pad.		 The dots (:) will flash on and off.
2	Enter the correct time of day by pressing the numbers in sequence.		
3	Press the TIMER/CLOCK pad again.		

This is a 12 hour clock. If you attempt to enter an incorrect clock time (eg. 13:45),  will appear in the display.

Press the STOP/CLEAR pad and re-enter the time of day (eg. 1:45).

The clock of the oven works based on the frequency of power source. So it may gain or lose in some area where the frequency varies. It is recommended that you should adjust the time occasionally.

If you wish to know the time of day during the cooking or timer mode, press the CLOCK pad. As long as your finger is pressing the CLOCK pad, the time of day will be displayed.

Stop/Clear

Press the STOP/CLEAR pad once to:

1. Stop the oven temporarily during cooking.
2. Clear if you make a mistake during programming.

To Cancel a Programme During Cooking

Press the STOP/CLEAR pad twice.

MANUAL OPERATIONS

Microwave Time Cooking

This is a manual cooking feature, first enter the cooking time then the power level. There are five different power levels.

Power level	10% (LOW)	30% (MEDIUM LOW)	50% (MEDIUM)	70% (MEDIUM HIGH)	100% (HIGH)
Display	10P	30P	50P	70P	100P
Examples of foods typically cooked on microwave oven power level	Keeping food warm	Defrosting Softening butter	Casseroles Seafood	Cakes Muffins Slices	Vegetables Rice/Pasta Fruit

This variable cooking control allows you to select the rate of microwave cooking.

If a power level is not selected, then 100% power is automatically used.

* Suppose you want to time cook for 2 minutes 30 seconds on 100% power.

Step	Procedure	Pad Order	Display
1	Enter desired cooking time.	2 3 0	2.30
2	Press the INSTANT COOK/START pad.	INSTANT COOK START	2.30 COOK The timer begins to count down.

To lower the power press the POWER LEVEL pad until desired power level is displayed.

* Suppose you want to cook Fish Fillets for 10 minutes on 50% power.

Step	Procedure	Pad Order	Display
1	Enter desired cooking time.	1 0 0 0	10.00
2	Select power level by pressing the POWER LEVEL pad as required (for 50% press three times).	POWER LEVEL x 3	50P
3	Press the INSTANT COOK/START pad.	INSTANT COOK START	10.00 COOK The timer begins to count down.

If the door is opened during cooking process, the cooking time in the display automatically stops. The cooking time starts to count down again when the door is closed and the INSTANT COOK/START pad is pressed.

If you wish to know the power level during cooking, press the POWER LEVEL pad. As long as your finger is pressing the POWER LEVEL pad, the power level will be displayed.

If more than 20 minutes is entered on 100% power, the microwave power will be reduced after 20 minutes to avoid overheating.

Sequence Cooking

Your oven can be programmed for up to 3 automatic cooking sequences, switching from one variable power setting to another automatically.

* Suppose you want to cook for 10 minutes on 50% followed by 5 minutes on 100%.

Step	Procedure	Pad Order	Display
1	Enter desired cooking time.		
2	Select desired power level by pressing the POWER LEVEL pad (for 50% press three times).	 x 3	
3	For second sequence, enter desired time for cooking time. If power is not selected the oven will operate at 100% power.		
4	Press the INSTANT COOK/START pad.		 The timer begins to count down to zero. When it reaches zero, the second sequence will appear and the timer will begin counting down to zero again.

Instant Cook™

For your convenience Sharp's Instant Cook allows you to easily cook for one minute on 100% power.

Step	Procedure	Pad Order	Display
1	Press the INSTANT COOK/START pad. Within 3 minutes of closing the door.		 The timer begins to count down.

Press the INSTANT COOK/START pad until desired time is displayed. Each time the pad is pressed, the cook time is increased by 1 minute.

Increasing Time During a Cooking Programme



Microwave time can be added during a cooking programme using the INSTANT COOK/START pad.

* Suppose you want to increase the cooking time by 2 minutes during 5 minutes on 50% power cooking. (at the moment the remaining cooking time is 1 min. 30 sec.)

Step	Procedure	Pad Order	Display
1	Enter desired cooking time.	<div style="border: 1px solid black; display: inline-block; padding: 2px;">5</div> <div style="border: 1px solid black; display: inline-block; width: 20px; height: 20px; border-radius: 50%; margin: 0 5px;"></div> <div style="border: 1px solid black; display: inline-block; width: 20px; height: 20px; border-radius: 50%; margin: 0 5px;"></div>	<div style="border: 1px solid black; padding: 5px; display: inline-block;">5.00</div>
2	Select power level by pressing the POWER LEVEL pad as required (for 50% press three times).	<div style="border: 1px solid black; padding: 5px; display: inline-block;">POWER LEVEL</div> x 3	<div style="border: 1px solid black; padding: 5px; display: inline-block;">5 0P</div>
3	Press the INSTANT COOK/START pad.	<div style="border: 1px solid black; padding: 5px; display: inline-block;">INSTANT COOK START</div>	<div style="border: 1px solid black; padding: 5px; display: inline-block;"> <small>COOK</small> 5.00 </div> <p>The timer starts to count down.</p> <div style="border: 1px solid black; padding: 5px; display: inline-block;"> <small>COOK</small> 1.30 </div>
4	Press the INSTANT COOK/START pad twice to increase the cooking time by two minutes.	<div style="border: 1px solid black; padding: 5px; display: inline-block;">INSTANT COOK START</div> x 2	<div style="border: 1px solid black; padding: 5px; display: inline-block;"> <small>COOK</small> 3.30 </div>

AUTOMATIC OPERATIONS





Notes for Automatic Operations

- When using the automatic features, carefully follow the details provided in each MENU GUIDE to achieve the best result.
If the details are not followed carefully, the food may be overcooked or undercooked or  may be displayed.
- Food weighing more or less than the quantity or weight listed in each MENU GUIDE, cook manually.
- To change the final cooking or defrosting result from the standard setting, press the POWER LEVEL pad once (for more) or twice (for less) after selecting desired setting. Refer to page E-17.
- The final cooking result will vary according to the food condition (e.g. initial temperature, shape, quality). Check the food after cooking and if necessary continue cooking manually.
- To avoid children's misuse, each INSTANT ACTION pad can be used only within 3 minutes of a preceding operation.
- To defrost foods above or below the weights allowed on the EXPRESS DEFROST MENU GUIDE, use EASY DEFROST or defrost manually.
-  will be displayed if:
more or less than weight of foods suggested in EASY DEFROST MENU GUIDE is programmed when the INSTANT COOK/START pad is pressed.
To clear, press the STOP/CLEAR pad and reprogramme.
- When entering the weight of the food, round off the weight to the nearest 0.1kg(100g). For example, 1.35kg would become 1.4kg.

Instant Action

The Instant Action allows you to cook or reheat several popular foods.
Follow the details provided in INSTANT ACTION MENU GUIDE on page E-12.

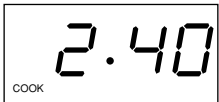
* Suppose you want to cook 1 Jacket Potato.

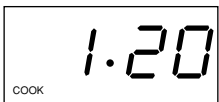
Step	Procedure	Pad Order	Display
1	Press the JACKET POTATO pad until desired quantity is displayed (for 1 piece press once).	 x 1	 ↓ After about 2 sec.  The cooking time will begin counting down. The oven will "beep" 4 times and stop. COOK indicator will go off and CHECK will flash on and off.
2	Open the door. Turn over potatoes. Close the door.		 CHECK will be flashing
3	Press the INSTANT COOK/START pad.		 The cooking time will begin counting down. When it reaches zero, the oven will "beep".

Instant Action Menu Guide

The final cooking result will vary according to the food condition (e.g. initial temperature, shape, quality). Check the food after cooking and if necessary continue cooking manually.

Menu	Quantity (Unit per pressing each INSTANT ACTION pad)	Initial Temperature (approx.)		Procedure	⌚ Standing Time (minutes)																				
Dinner Plate <table border="1" data-bbox="130 459 477 595"> <tr> <th>MEAT</th> <th>POTATO</th> <th>VEGETABLES</th> </tr> <tr> <td>175-180g</td> <td>125g</td> <td>100g</td> </tr> <tr> <td>Beef, Lamb Chicken, T-Bone</td> <td>sliced</td> <td>2 varieties eg. sliced Carrot Zucchini, Broccoli</td> </tr> </table>	MEAT	POTATO	VEGETABLES	175-180g	125g	100g	Beef, Lamb Chicken, T-Bone	sliced	2 varieties eg. sliced Carrot Zucchini, Broccoli	1 serve (approx. 400g)	+ 3°C Refrigerated		<ul style="list-style-type: none"> Cover with plastic wrap. After cooking, stand covered. 	2											
MEAT	POTATO	VEGETABLES																							
175-180g	125g	100g																							
Beef, Lamb Chicken, T-Bone	sliced	2 varieties eg. sliced Carrot Zucchini, Broccoli																							
Beverage includes: Tea Coffee Water	1-4 cups (1 cup, 250 ml)	+ 20°C Room temperature		<ul style="list-style-type: none"> No cover. Place on the outside of turntable. After reheating, stir. 																					
Fresh Vegetables Carrots } Potato } Beans / Brussels Sprouts } Broccoli / Cauliflower } Zucchini / Spinach } Cabbage }	0.1-0.6 kg (0.1 kg)	+ 3°C Refrigerated		<ul style="list-style-type: none"> Wash the vegetables. Arrange the vegetables in a shallow dish in the following way: hard vegetables around the outside, soft vegetables in the centre, medium vegetables in-between. Cover with glass lid or plastic wrap. After cooking, stand covered and stir. 	1 - 5																				
Frozen Vegetables Carrots } Beans / Brussels Sprouts } Broccoli / Cauliflower } Corn } Green Peas } Mixed Vegetables }	0.1-0.6 kg (0.1 kg)	- 18°C Frozen		<ul style="list-style-type: none"> Before cooking, separate vegetables eg. broccoli as much as possible. Arrange the vegetables in a shallow dish in the following way: hard vegetables around the outside, soft vegetables in the centre, medium vegetables in-between. Cover with a glass lid or plastic wrap. After cooking, stand covered and stir. 	1 - 5																				
Jacket Potato Potato (whole)	1-6 pieces (1 piece, approx. 150 g)	+ 20°C Room temperature		<ul style="list-style-type: none"> Use washed new potatoes. Pierce twice with fork on each side. Place on outside of turntable. The oven will "beep" and stop, CHECK will flash on and off. Turn over potatoes and press start to continue cooking. After cooking, stand, covered with aluminium foil. 	3 - 10																				
Rice / Pasta includes: White Rice Dry Pasta	1-4 serves (1 serve, 1/2 cup)	approx. + 60°C hot tap water or soup stock		<ul style="list-style-type: none"> Wash rice until water runs clear. Place into a Pyrex® bowl and cover with hot soup stock (for rice) or with hot tap water (for rice or pasta). Cook uncovered. The oven will "beep" and stop, CHECK will flash on and off. Stir and press start to continue cooking. After cooking, stand and stir. 	1 - 5																				
<table border="1" data-bbox="130 1593 551 1825"> <tr> <th>Serve</th> <th>1 serve</th> <th>2 serves</th> <th>3 serves</th> <th>4 serves</th> </tr> <tr> <td>Rice/Pasta</td> <td>1/2 cup</td> <td>1 cup</td> <td>1 1/2 cups</td> <td>2 cups</td> </tr> <tr> <td>Soup stock or Hot tap water for Rice</td> <td>1 1/4 cups</td> <td>1 1/2 cups</td> <td>2 cups</td> <td>3 cups</td> </tr> <tr> <td>Hot tap water for Pasta</td> <td>2 cups</td> <td>2 cups</td> <td>3 cups</td> <td>4 cups</td> </tr> </table>	Serve	1 serve	2 serves	3 serves	4 serves	Rice/Pasta	1/2 cup	1 cup	1 1/2 cups	2 cups	Soup stock or Hot tap water for Rice	1 1/4 cups	1 1/2 cups	2 cups	3 cups	Hot tap water for Pasta	2 cups	2 cups	3 cups	4 cups					
Serve	1 serve	2 serves	3 serves	4 serves																					
Rice/Pasta	1/2 cup	1 cup	1 1/2 cups	2 cups																					
Soup stock or Hot tap water for Rice	1 1/4 cups	1 1/2 cups	2 cups	3 cups																					
Hot tap water for Pasta	2 cups	2 cups	3 cups	4 cups																					

Express Defrost







- 1. Fish Fillets
- 2. Chicken Fillets
- 3. Sausages /
Minced Meat





EXPRESS DEFROST rapidly defrosts 0.5 kg specific foods.

Follow the details provided in EXPRESS DEFROST MENU GUIDE on page E-14.

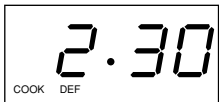
* Suppose you want to defrost 0.5 kg of Chicken Fillets.

Step	Procedure	Pad Order	Display
1	Press the EXPRESS DEFROST pad until the desired menu number is displayed (for Chicken Fillets press twice).	 x 2	
2	Press the INSTANT COOK/START pad.		 The defrosting time will begin counting down. The oven will "beep" 4 times and stop. COOK indicator will go off and CHECK will flash on and off.
3	Open the door. Remove defrosted pieces, turn over remaining pieces. Close the door.		 CHECK will be flashing.
4	Press the INSTANT COOK/START pad.		 The defrosting time will begin counting down. When it reaches zero, the oven will "beep".

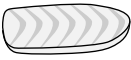
Express Defrost Menu Guide

No.	Menu	Quantity (kg's)	Procedure	⌚ Standing Time (minutes)
1	Fish Fillets 	0.5	<ul style="list-style-type: none"> Place fish fillets on the defrost rack. The oven will "beep" and stop, CHECK will flash on and off. Turn over and separate into pieces. Press start to continue defrosting. After defrost time, stand covered with aluminium foil. 	5
2	Chicken Fillets 	0.5	<ul style="list-style-type: none"> Place chicken fillets on the defrost rack. The oven will "beep" and stop, CHECK will flash on and off. Break apart and turn over. Press start to continue defrosting. After defrost time, stand covered with aluminium foil. 	5
3	Sausages / Minced Meat 	0.5	<ul style="list-style-type: none"> Place sausages / minced meat on the defrost rack. The oven will "beep" and stop, CHECK will flash on and off. Remove defrosted portions, turn over and shield edges with foil strips. Press start to continue defrosting. After defrost time, stand covered with aluminium foil. 	5

NOTE: When freezing minced meat, shape it into flat even sizes.

For fish fillets, chicken fillets and sausages, freeze separately in single flat layers and if necessary interleave with freezer plastic to separate layers. This will ensure even defrosting.

It is also a good idea to label the packs with the correct weights.

Easy Defrost









1. Steak / Chops
2. Roast Meat
3. Poultry
4. Chicken Pieces

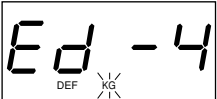



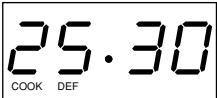

EASY DEFROST will automatically compute the microwave power and defrosting time.

Follow the details provided in EASY DEFROST MENU GUIDE on page E-16.

* Suppose you want to defrost 1.0 kg of Chicken Pieces.

Step	Procedure	Pad Order	Display
1	Press the EASY DEFROST pad until the desired menu number is displayed (for Chicken Pieces press four times).	 x 4	 KG will flash on and off.
2	Press the number pads to enter weight.		 KG stops flashing and remains on display.
3	Press the INSTANT COOK/START pad.		 The defrosting time will begin counting down. The oven will "beep" 4 times and stop. COOK indicator will go off and CHECK will flash on and off.
4	Open the door. Remove defrosted pieces, turn over remaining pieces. Close the door.		 CHECK will be flashing.
5	Press the INSTANT COOK/START pad.		 The defrosting time will begin counting down. When it reaches zero, the oven will "beep".

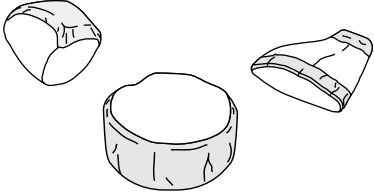
Easy Defrost Menu Guide

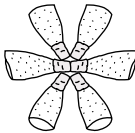
No.	Menu	Quantity min-max (kg's)	Procedure	⌚ Standing Time (minutes)
1	Steak Chops 	0.1-1.5	<ul style="list-style-type: none"> Shield thin end of chops or steaks with foil. Position the food with thinner parts in the centre in a single layer on the defrost rack. If pieces are stuck together, try to separate as soon as possible. The oven will "beep" and stop, CHECK will flash on and off. Remove defrosted pieces, turn over and shield the warm portions. Press start to continue defrosting. After defrost time, stand covered with aluminium foil. 	5 - 20
	Minced Meat Beef 	0.1-1.5	<ul style="list-style-type: none"> Place frozen minced meat on the defrost rack. Shield edges. The oven will "beep" and stop, CHECK will flash on and off. Remove defrosted portions, turn over and shield edges with foil strips. Press start to continue defrosting. After defrost time, stand covered with aluminium foil. 	5 - 20
2	Roast Meat Beef/Lamb 	0.5-1.5	<ul style="list-style-type: none"> Shield the edge with foil strips about 2.5cm wide. Place joint with lean side face upwards (if possible) on the defrost rack. The oven will "beep" and stop, CHECK will flash on and off. Turn over and shield the warm portions. Press start to continue defrosting. After defrost time, stand covered with aluminium foil. 	5 - 30
3	Poultry 	1.0-1.5	<ul style="list-style-type: none"> Remove from original wrapper. Shield wing and leg tips with foil. Place breast side down on the defrost rack. The oven will "beep" and stop, CHECK will flash on and off. Turn over and shield the warm portions. Press start to continue defrosting. After defrost time, stand covered with aluminium foil. N.B. After standing run under cold water to remove giblets if necessary. 	15 - 20
4	Chicken Pieces 	0.1-1.5	<ul style="list-style-type: none"> Shield the exposed bone with foil. Place chicken pieces on the defrost rack. The oven will "beep" and stop, CHECK will flash on and off. Remove defrosted pieces, turn over and shield the warm portions. Press start to continue defrosting. After defrost time, stand covered with aluminium foil. 	5 - 15

Food not listed in the Guide can be defrosted using 30 % setting.

NOTE: When freezing minced meat, shape it into flat even sizes.

For chicken pieces, steaks and chop, freeze separately in single flat layers and if necessary interleave with freezer plastic to separate layers. This will ensure even defrosting. It is also a good idea to label the packs with the correct weights.

OTHER CONVENIENT FEATURES

Less/More Setting



The cooking times programmed into the automatic menus are tailored to the most popular tastes. To adjust the cooking time to your individual preference use the "more" or "less" feature to either add (more) or reduce (less) cooking time.

The Less/More can be used to adjust the cooking time of the following features

- INSTANT ACTION
- EXPRESS DEFROST
- EASY DEFROST





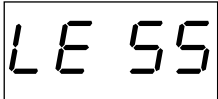

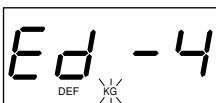

(1) INSTANT ACTION

* Suppose you want to reheat 1 cup of Beverage for less time than the standard setting.

Step	Procedure	Pad Order	Display
1	Press the BEVERAGE pad once.	 x 1	
2	Press the POWER LEVEL pad twice within 2 seconds.	 x 2	

(2) EXPRESS DEFROST / EASY DEFROST

* Suppose you want to defrost 1.0kg of Chicken Pieces (Easy Defrost) for more time than the standard setting.

Step	Procedure	Pad Order	Display
1	Press the EASY DEFROST pad four times for Chicken Pieces.	 x 4	
2	Press the number pads to enter weight.	 	
3	Press the POWER LEVEL pad once.	 x 1	
4	Press the INSTANT COOK/START pad.		

For EXPRESS DEFROST select the menu using the EXPRESS DEFROST pad instead of the EASY DEFROST pad in step 1, and go to step 3.

Timer

Use this feature as a general purpose timer. Example include:
 timing boiled eggs cooked on the stove top.
 timing the recommended standing time of food.

You can enter any time up to 99 minutes, 99 seconds. If you want to cancel the timer during the count down phase simply press STOP/CLEAR and the display will return to showing time of day.

* Suppose you want to set the timer to 3 minutes for boiling an egg on the stove top.

Step	Procedure	Pad Order	Display
1	Enter desired time.	3 0 0	3.00
Once the egg has come to the boil in the saucepan you can start the timer.			
2	Press the TIMER/CLOCK pad .	TIMER CLOCK	3.00 The timer begins to count down. When the timer reaches zero, the oven will "beep". End will appear in the display.

Child Lock

If the oven is accidentally started with no food/liquid in the cavity, the oven could be damaged.
 To prevent accidents like this, your oven has a "Child Lock" feature that you can set when the oven is not in use.

To set the Child Lock, press the TIMER/CLOCK pad, press number pad **1** and finally press the INSTANT COOK/START pad and hold for 3 seconds. **SAFE** will appear in the display.
 The Control Panel is now locked, each time a pad is pressed, the display will show "SAFE".

To unlock the control panel, press the TIMER/CLOCK pad, **1** and the STOP/CLEAR pad. The time of day is displayed and the oven is ready to use.

Demonstration Mode

This feature is mainly for use by retail outlets, and also allows you to practice the key operation.

To demonstrate, press the TIMER/CLOCK pad , press number pad **0** and finally press the INSTANT COOK/START pad and hold for 3 seconds. **DESP** will appear in the display.
 Cooking operations can now be demonstrated with no power in the oven. For example, press INSTANT COOK/START pad, and the display will show **1.00** and count down to zero at ten times the speed. When the timer reaches zero, **End** will appear in the display.

To cancel, press the TIMER/CLOCK pad, **0** and the STOP/CLEAR pad.

Alarm

Your oven has an alarm function. If you leave food in the oven after cooking, the oven will "beep" 3 times after 2 minutes.

If you do not remove the food at that time, the oven will "beep" 3 times after 4 minutes and 6 minutes.

CARE AND CLEANING

Disconnect the power supply cord before cleaning or leave the door open to inactivate the oven during cleaning.

CLEAN THE OVEN AT REGULAR INTERVALS - Keep the oven clean, or it could lead to deterioration of the surface. This could adversely affect the life of the appliance and possibly result in a hazardous situation.

Exterior:

The outside may be cleaned with mild soap and warm water, wipe clean with a damp cloth. Avoid the use of harsh abrasive cleaners.

Door:

Wipe the door and window on both sides, the door seals and adjacent parts frequently with a damp cloth to remove any spills or splatters. Do not use abrasive cleaner.

Control Panel:

Wipe the panel with a cloth dampened slightly with water only.

Do not scrub or use any sort of chemical cleaners. Avoid the use of excess water.

Interior walls:

To clean the interior surfaces, wipe with a soft cloth and warm water for hygienic reasons. After use wipe the waveguide cover in the oven with a soft damp cloth to remove any food splashes. Built-up splashes may overheat and begin to smoke or catch fire. Do not remove the waveguide cover. **DO NOT USE A COMMERCIAL OVEN CLEANER, ABRASIVE OR HARSH CLEANERS AND SCOURING PADS ON ANY PART OF YOUR MICROWAVE OVEN. NEVER SPRAY OVEN CLEANERS DIRECTLY ONTO ANY PART OF YOUR OVEN.**

Avoid using excess water. After cleaning the oven, ensure any water is removed with a soft cloth.

Turntable/Roller Stay:

Wash with mild soapy water and dry thoroughly.

SERVICE CALL CHECK

Please check the following before calling for service:

1. Does the display light? YES _____ NO _____
2. When the door is opened, does the oven lamp come on? YES _____ NO _____
3. Place one cup of water (approx. 250 ml) in a glass measure in the oven and close the door securely. Oven lamp should go off if door is closed properly. Press the INSTANT COOK/START pad once.
 - A. Does the oven lamp light? YES _____ NO _____
 - B. Does the cooling fan work? YES _____ NO _____
(Put your hand over the rear ventilation openings.)
 - C. Does the turntable rotate? YES _____ NO _____
(The turntable can rotate clockwise or anticlockwise. This is quite normal.)
 - D. After one minute, did an audible signal sound and COOK indicator go off? YES _____ NO _____
 - E. Is the water inside the oven hot? YES _____ NO _____

If "NO" is the answer to any of the above questions, please check your wall socket and the fuse in your meter box. If both the wall socket and the fuse are functioning properly, CONTACT YOUR NEAREST SERVICE CENTRE APPROVED BY SHARP.

NOTE: 1. If time in the display is counting down rapidly, check Demonstration Mode. (See page E-18 for detail.)
2. If you cook the food over 20 minutes on 100% power, the microwave power will be automatically reduced to avoid overheating.

SPECIFICATIONS

AC Line Voltage:	Refer to the rating plate.
AC Power Required:	1.21kW
Output Power:	800W*(IEC test procedure)
Microwave Frequency:	2450 MHz**(Class B / Group 2)
Outside Dimensions:	460 mm (W) x 275 mm (H) x 353 mm (D)
Cavity Dimensions:	322 mm (W) x 212 mm (H) x 336 mm (D)
Cooking Uniformity:	Turntable (ø295 mm tray) system
Weight:	Approx. 12kg

* This measurement is based on the International Electrotechnical Commission's standardized method for measuring output power.

** This is the classification of ISM (Industrial, Scientific and Medical) equipment described in the International Standard CISPR11.

Free Manuals Download Website

<http://myh66.com>

<http://usermanuals.us>

<http://www.somanuals.com>

<http://www.4manuals.cc>

<http://www.manual-lib.com>

<http://www.404manual.com>

<http://www.luxmanual.com>

<http://aubethermostatmanual.com>

Golf course search by state

<http://golfingnear.com>

Email search by domain

<http://emailbydomain.com>

Auto manuals search

<http://auto.somanuals.com>

TV manuals search

<http://tv.somanuals.com>