

SHARP

Important

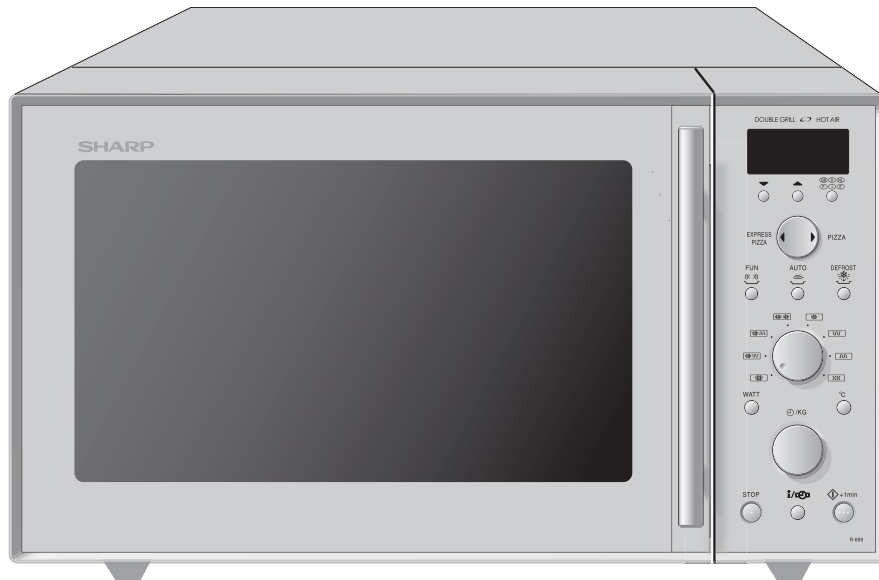

R-898 MICROWAVE OVEN WITH TOP & BOTTOM GRILL AND CONVECTION

OPERATION MANUAL WITH COOKBOOK

OPERATION MANUAL

This operation manual contains important information which you should read carefully before using your microwave oven.

IMPORTANT: There may be a serious risk to health if this operation manual is not followed or if the oven is modified so that it operates with the door open.

900 W (IEC 60705)

ENGLISH

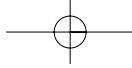

Dear Customer,

Congratulations on acquiring your new combi-microwave oven with grill and convection, which from now on will make your kitchen chores considerably easier.

You will be pleasantly surprised by the kinds of things you can do with a microwave. Not only can you use it for rapid defrosting or heating up of food, you can also prepare whole meals.

In our test kitchen our microwave team has gathered together a selection of the most delicious international recipes which are quick and simple to prepare.

Be inspired by the recipes we have included and prepare your own favourite dishes in your microwave oven.

There are so many advantages to having a microwave oven which we are sure you will find exciting:

- Food can be prepared directly in the serving dishes, leaving less to wash up.
- Shorter cooking times and the use of little water and fat ensure that many vitamins, minerals and characteristic flavours are preserved.

We advise you to read the cookery book guide and operating instructions carefully.

You will then easily understand how to use your oven.

Enjoy using your microwave oven and trying out the delicious recipes.

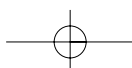
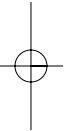
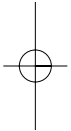

GB

Information for Customers on environmentally friendly disposal of this SHARP product

GB

If this product cannot be used any more, it should be collected and disposed of in a legally correct and environmentally sound way.

**DO NOT DISPOSE OF THIS PRODUCT WITH YOUR HOUSEHOLD WASTE
OR MIXED WITH OTHER WASTES ! YOU MIGHT ENDANGER THE ENVIRONMENT !**

Sharp Corporation is committed to protecting the environment and conserving energy. Our goal is to minimize the environmental impact of our products by continually implementing and improving product technologies, designs, and customer information aimed at environmental conservation.

(1) For our customers in Belgium, The Netherlands, Sweden, and Switzerland

SHARP takes part in the national recycling system for electrical and electronic equipment, which has been founded on the base of an environmental law.

If you wish to discard this SHARP product, please read here details on the countries concerned:

Country	Recycling Information for that Country
Belgium	Please use the services of the Belgian electronics recycling system called "Recupel". <ul style="list-style-type: none"> • call 0800 - 40387 (from within the country) • or look at the website: www.recupel.be
The Netherlands	Please use the services of the Dutch electronics recycling system called "NVMP". <ul style="list-style-type: none"> • call 0800 - 0242002 (from within the country) • or look at the website: www.nvmp.nl
Sweden	Please use the services of the Swedish electronics recycling system called "ELRETUR": <ul style="list-style-type: none"> • call 08 - 5452-1290 (from within the country) • or look at the website: www.el-retur.se
Switzerland	Please use the services of the Swiss electronics recycling system called "S.EN.S ". <ul style="list-style-type: none"> • call 043 - 255 20 00 (from within the country) • look at the website: www.sens.ch

(2) For our customers in Austria, Denmark, Finland, France, Germany, Italy, Luxemburg, Portugal, and Spain

If you wish to discard this SHARP product, please contact your local authorities for collection facilities, or contact a recycling company which is licensed for the recycling of electrical and electronic equipment; then dispose of this product through one of these parties.

It is intended that from 13 August 2005 on, collection facilities are available all over the country where users from private households can return waste electrical and electronic equipment free of charge and in an environmentally friendly way. Then please contact your local authorities for the nearest collection facility which can accept this product, and dispose of this product through it.

Before this date, it is possible that the last user has to bear the cost of collection and recycling.

(3) For our customers in other countries

If you wish to discard this SHARP product, please contact your local authorities for collection facilities, or contact a recycling company which is licensed for the recycling of electrical and electronic equipment; then discard this product through one of these parties.

It is possible that the last user has to bear the cost of collection and recycling.



CONTENTS

RECYCLING INFORMATION	1
OVEN AND ACCESSORIES	3
CONTROL PANEL	4
IMPORTANT SAFETY INSTRUCTIONS	5 - 7
INSTALLATION	7
BEFORE OPERATION	8
SELECTING THE LANGUAGE	8
ENERGY SAVE MODE	9
USING THE STOP BUTTON	9
SETTING THE CLOCK	10
MICROWAVE POWER LEVELS	10
MICROWAVE COOKING	11
GRILL COOKING	11 - 12
HEATING WITHOUT FOOD	12
CONVECTION COOKING	13 - 14
DUAL COOKING	15 - 16
OTHER CONVENIENT FUNCTIONS	17 - 19
AUTOMATIC OPERATION (EXPRESS PIZZA)	20
EXPRESS PIZZA CHART	20
AUTOMATIC OPERATION (PIZZA/FUN MENUS/AUTO COOK/AUTO DEFROST) ..	21 - 22
PIZZA CHART	22
FUN MENU CHART	23
AUTO COOK CHART	24
AUTO DEFROST CHART	25
RECIPES FOR FUN MENUS	26
RECIPES FOR AUTO COOK AC-3	27
CARE AND CLEANING	28
SERVICE CALL CHECK	29
SERVICE ADDRESSES	30 - 35
SPECIFICATIONS	36

OVEN AND ACCESSORIES

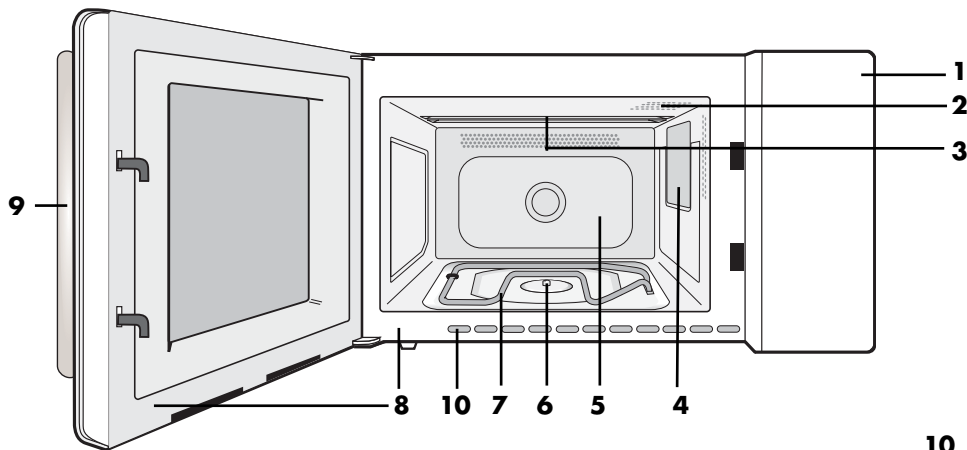

- 1** Control panel
- 2** Oven lamp
- 3** Grill heating element (top grill)
- 4** Waveguide cover
- 5** Oven cavity
- 6** Turntable motor shaft
- 7** Grill heating element (bottom grill)
- 8** Door seals and sealing surfaces
- 9** Door opening handle
- 10** Ventilation openings
- 11** Power cord
- 12** Outer cabinet

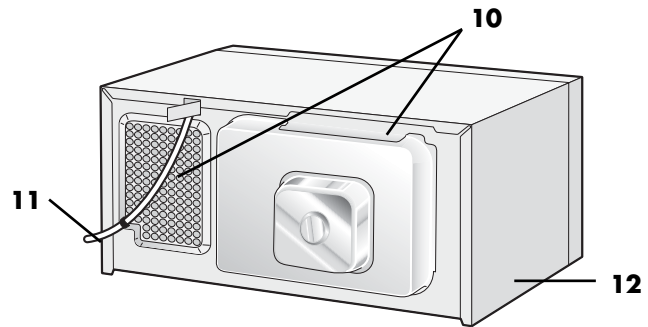

ACCESSORIES:

Check to make sure the following accessories are provided:

- 13** Turntable
- 14** Low Rack
- 15** High Rack

Place the turntable over the turntable motor shaft on the floor of the cavity.

Before first using the turntable and racks, clean with mild soapy water.

Do not cut or scratch the turntable.

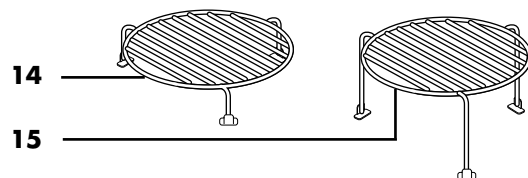
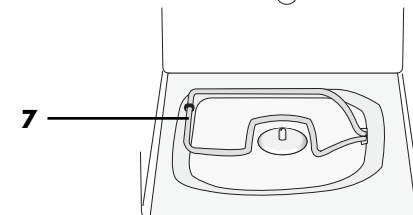
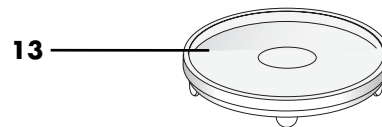

WARNING:

The accessories (e.g. turntable) will become very hot during Grill, Convection, Dual and Automatic operation (except Auto Defrost) modes. Always use thick oven gloves when removing the food or turntable from the oven to prevent burns.

NOTE:

When you order accessories, please mention the following two items: Part name and model name to your dealer or SHARP authorized service agent.

ENGLISH

CONTROL PANEL

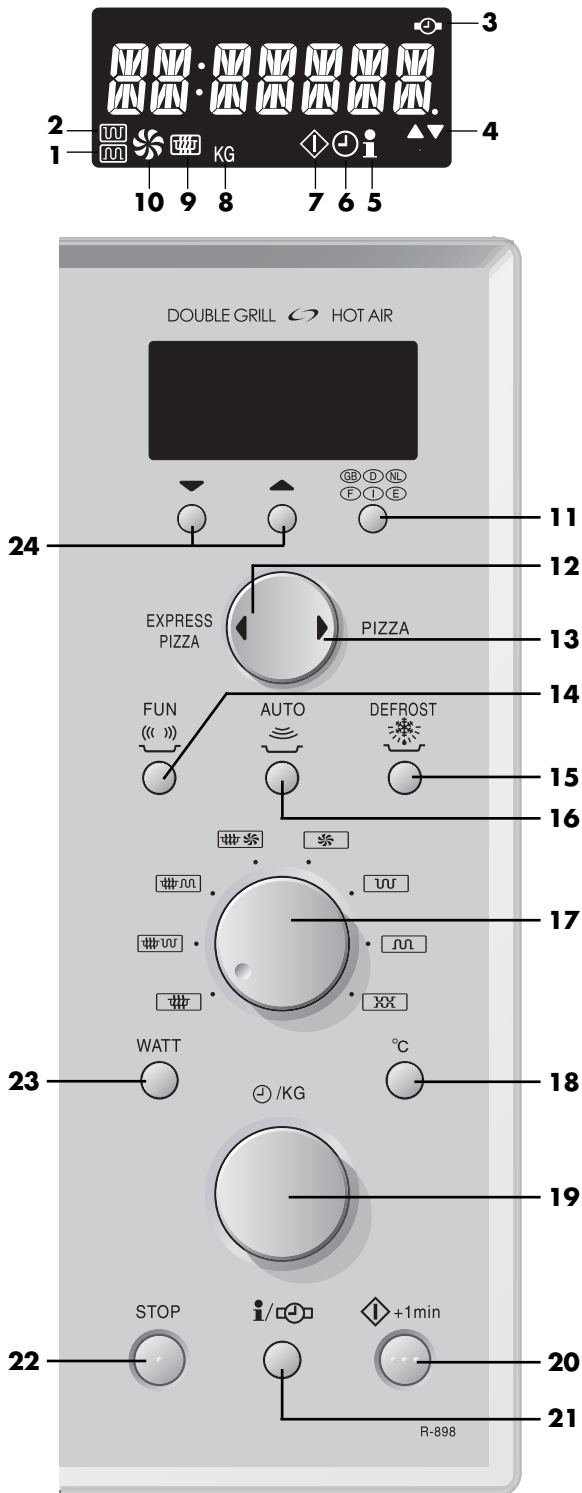

Digital display and indicators:

- 1 **BOTTOM GRILL** indicator
- 2 **TOP GRILL** indicator
- 3 **CLOCK SET** indicator
- 4 **LESS/MORE** indicator
- 5 **INFORMATION** indicator
- 6 **TIMER** indicator
- 7 **COOKING IN PROGRESS** indicator
- 8 **WEIGHT (kg)** indicator
- 9 **MICROWAVE** indicator
- 10 **CONVECTION** indicator

Operating buttons:

- 11 **LANGUAGE** button
- 12 **EXPRESS PIZZA** button
- 13 **PIZZA** button
- 14 **FUN MENUS** button
- 15 **AUTO DEFROST** button
- 16 **AUTO COOK** button
- 17 **COOKING MODE** dial

Rotate the dial so that indicator points to appropriate symbol:

- for microwave cooking
- for microwave cooking with TOP GRILL
- for microwave cooking with BOTTOM GRILL
- for microwave cooking with CONVECTION
- for CONVECTION
- for TOP GRILL
- for BOTTOM GRILL
- for TOP & BOTTOM GRILLS

- 18 **CONVECTION (°C)** button
Press to change the convection setting.
- 19 **TIME/WEIGHT** dial
Rotate the dial to enter either the cooking/defrosting time or weight of food.
- 20 **START** **/+1 min** button
- 21 **INFO/CLOCK** button
- 22 **STOP** button
- 23 **MICROWAVE POWER LEVEL** button
Press to change the microwave power setting.
- 24 **LESS/MORE** buttons

IMPORTANT SAFETY INSTRUCTIONS



IMPORTANT SAFETY INSTRUCTIONS: READ CAREFULLY AND KEEP FOR FUTURE REFERENCE

To avoid the danger of fire

The microwave oven should not be left unattended during operation. Power levels that are too high or cooking times that are too long may overheat foods resulting in a fire.

In cases where the oven is to be installed into a kitchen cabinet, the installation frame EBR-5000 licensed by SHARP must be used. This is available from your dealer. Refer to the frame installation instructions or ask your dealer for the proper instruction procedure. Only the use of this frame will guarantee the safety and quality of the product.

The electrical outlet must be readily accessible so that the unit can be unplugged easily in an emergency.

The AC power supply must be 230 V, 50 Hz, with a minimum 16 A distribution line fuse, or a minimum 16 A distribution circuit breaker.

It is recommended that a separate circuit serving only this appliance be provided.

Do not place the oven in areas where heat is generated. For example, close to a conventional oven.

Do not install the oven in an area of high humidity or where moisture may collect.

Do not store or use the oven outdoors.

If food being heated begins to smoke, DO NOT OPEN THE DOOR. Turn off and unplug the oven and wait until the food has stopped smoking. Opening the door while food is smoking may cause a fire.

Use only microwave-safe containers and utensils. See Page X.

Do not leave the oven unattended when using disposable plastic, paper or other combustible food containers.

Clean the waveguide cover, the oven cavity and the turntable after use. After cooking fatty foods without a lid, always clean the cavity and especially the grill heating elements thoroughly. These must be dry and free from grease. Built-up grease may overheat and begin to smoke or catch fire.

Do not place flammable materials near the oven or ventilation openings. Do not block the ventilation openings.

Remove all metallic seals, wire twists, etc., from food and food packages. Arcing on metallic surfaces may cause a fire.

Do not use the microwave oven to heat oil for deep frying. The temperature cannot be controlled and the oil may catch fire.

To make popcorn, use only special microwave popcorn makers.

Do not store food or any other items inside the oven. Check the settings after you start the oven to ensure the oven is operating as desired.

See the corresponding hints in the cookery book section. See pages XX - XX.

To avoid the possibility of injury

WARNING:

Do not operate the oven if it is damaged or malfunctioning. Check the following before use:

- The door; make sure the door closes properly and ensure it is not misaligned or warped.
- The hinges and safety door latches; check to make sure they are not broken or loose.
- The door seals and sealing surfaces; ensure that they have not been damaged.
- Inside the oven cavity or on the door; make sure there are no dents.
- The power supply cord and plug; ensure that they are not damaged.

Never adjust, repair or modify the oven yourself. It is hazardous for anyone other than a competent person to carry out any service or repair operation which involves the removal of a cover which gives protection against exposure to microwave energy.

Do not operate the oven with the door open or alter the door safety latches in any way.

Do not operate the oven if there is an object between the door seals and sealing surfaces.

Do not allow grease or dirt to build up on the door seals and adjacent parts. Follow the instructions for "Care and Cleaning" on page 28. Failure to maintain the oven in a clean condition could lead to a deterioration of the surface that could adversely affect the life of the appliance and possibly result in a hazardous situation.

Individuals with PACEMAKERS should check with their doctor or the manufacturer of the pacemaker for precautions regarding microwave ovens.

To avoid the possibility of electric shock

Under no circumstances should you remove the outer cabinet.

Never spill or insert any objects into the door lock openings or ventilation openings. In the event of a spill, turn off and unplug the oven immediately, and call an authorised SHARP service agent.



IMPORTANT SAFETY INSTRUCTIONS

Do not immerse the power supply cord or plug in water or any other liquid.

Do not let the power supply cord hang over the edge of a table or work surface.

Keep the power supply cord away from heated surfaces, including the rear of the oven.

Do not attempt to replace the oven lamp yourself or allow anyone who is not an electrician authorised by SHARP to do so. If the oven lamp fails, please consult your dealer or an authorised SHARP service agent.

If the power supply cord of this appliance is damaged, it must be replaced by an authorised SHARP service agent.

To avoid the possibility of explosion and sudden boiling:

WARNING: Liquids and other foods must not be heated in sealed containers since they are liable to explode.

Never use sealed containers. Remove seals and lids before use. Sealed containers can explode due to a build up of pressure even after the oven has been turned off.

Take care when microwaving liquids. Use a wide-mouthed container to allow bubbles to escape.

Microwave heating of beverages can result in delayed eruptive boiling, therefore care has to be taken when handling the container.

To prevent sudden eruption of boiling liquid and possible scalding:

1. Stir liquid prior to heating/reheating.
2. It is advisable to insert a glass rod or similar utensil into the liquid whilst reheating.
3. Let liquid stand for at least 20 seconds in the oven at the end of cooking time to prevent delayed eruptive boiling.

Do not cook eggs in their shells, and whole hard boiled eggs should not be heated in microwave ovens since they may explode even after microwave cooking has ended. To cook or reheat eggs which have not been scrambled or mixed, pierce the yolks and the whites, or the eggs may explode. Shell and slice hard boiled eggs before reheating them in the microwave oven.

Pierce the skin of such foods as potatoes, sausages and fruit before cooking, or they may explode.

To avoid the possibility of burns

Use pot holders or oven gloves when removing food from the oven to prevent burns.

Always open containers, popcorn makers, oven cooking bags, etc., away from the face and hands to avoid steam burns.

To avoid burns, always test food temperature and stir before serving and pay special attention to the temperature of food and drink given to babies, children or the elderly.

Temperature of the container is not a true indication of the temperature of the food or drink; always check the food temperature.

Always stand back from the oven door when opening, to avoid burns from escaping steam and heat.

Slice stuffed baked foods after heating to release steam and avoid burns.

Keep children away from the door and accessible parts that may become hot when the grill is in use. Children should be kept away to prevent them burning themselves.

Do not touch the oven door, outer cabinet, rear cabinet, oven cavity, ventilation openings, accessories and dishes during **GRILL, CONVECTION, DUAL** and **AUTOMATIC** operation (except **AUTO DEFROST**) as they will become hot. Before cleaning make sure they are not hot.

To avoid misuse by children

WARNING: Only allow children to use the oven without supervision when adequate instructions have been given so that the child is able to use the oven in a safe way and understands the hazards of improper use.

Do not lean or swing on the oven door. Do not play with the oven or use it as a toy.

Children should be taught all important safety instructions: use of pot holders, careful removal of food coverings; paying special attention to packaging (e.g. self-heating materials) designed to make food crisp, as they may be extra hot.

Other warnings

Never modify the oven in any way.

Do not move the oven while it is in operation.

This oven is for home food preparation only and may only be used for cooking food. It is not suitable for commercial or laboratory use.

IMPORTANT SAFETY INSTRUCTIONS



To promote trouble-free use of your oven and avoid damage.

Never operate the oven when it is empty except where recommended in the operation manual, see Page 12. Doing so may damage the oven.

When using a browning dish or self-heating material, always place a heat-resistant insulator such as a porcelain plate under it to prevent damage to the turntable due to heat stress. The preheating time specified in the dish's instructions must not be exceeded.

Do not use metal utensils, which reflect microwaves and may cause electrical arcing. Do not put cans in the oven.

Use only the turntable designed for this oven.

Do not place anything on the outer cabinet during operation.

Do not use plastic containers for microwaving if the oven is still hot from using the **GRILL**, **CONVECTION**, **DUAL** and **AUTOMATIC** operation (except **AUTO DEFROST**), because they may melt. Plastic containers must not be used during above modes unless the container manufacturer says they are suitable.

NOTE:

If you are unsure how to connect your oven, please consult an authorised, qualified electrician.

Neither the manufacturer nor the dealer can accept any liability for damage to the oven or personal injury resulting from failure to observe the correct electrical connection procedure.

Water vapour or drops may occasionally form on the oven walls or around the door seals and sealing surfaces. This is a normal occurrence and is not an indication of microwave leakage or a malfunction.

INSTALLATION



1. Remove all packing materials from the inside of the oven cavity. Discard the loose polythene sheet from between the door and cavity. Remove the feature sticker, if attached, from the outside of the door.

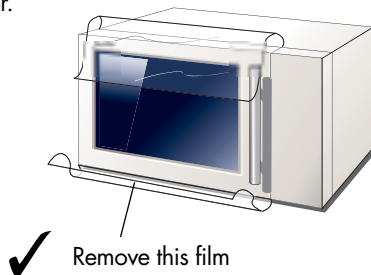

2. Check the oven carefully for any signs of damage.
3. Place the oven on a flat, level surface strong enough to support the oven's weight plus the heaviest item likely to be cooked.

4. **The oven door may become hot during cooking. Place or mount the oven so that the bottom of the oven is 85 cm or more above the floor. Keep children away from the door to prevent them burning themselves.**

5. **Do not allow the power supply cord to run over any hot or sharp surfaces, such as the hot air vent area at the top rear of the oven.**

6. Ensure there is a minimum of free space above the oven of 19 cm.

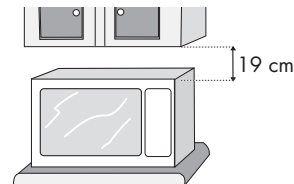

7. Securely connect the plug of the oven to a standard earthed (grounded) household electrical outlet.

ENGLISH



BEFORE OPERATION

Your oven comes pre-set for Energy Save Mode so when you first plug it in nothing will appear on the digital display.

To operate the oven in Energy Save Mode:

1. Plug in the oven. Nothing will appear on the display at this time.
2. Open the door. The oven display will show "SELECT LANGUAGE" in 6 languages.
3. Close the door.
4. Select a language (see below).
5. Heat the oven without food (See page 12).

NOTE:

You can change to Clock Set Mode if you prefer, see page 10 of the operation manual. If you decide to set the clock, Energy Save Mode does not work.

COOKING HINTS:

Your oven has an 'Information Display System' which allows you to access step by step instructions for each of the ovens features/buttons. Instructions will appear in the digital display each time you press a button to inform you of the next operation step.

In Energy Save Mode, if you do not operate the oven for 3 minutes or more (i.e. closing the door, pressing the **STOP** key, or at the end of cooking), you will not be able to operate the oven until you open and close the oven door.



SELECTING THE LANGUAGE

Press LANGUAGE button	LANGUAGE
once	ENGLISH
twice	DEUTSCH
3 times	NEDERLANDS
4 times	FRANCAIS
5 times	ITALIAN
6 times	ESPANOL

Your oven initially has English selected as the language. To change to a language of your choice, scroll through the options available by pressing the **LANGUAGE** button as shown in the table opposite. Then press the **START**  **/+1 min** button.

Example:

Suppose you want to select **Italian**.

1. Choose the desired language

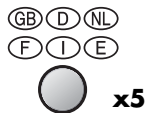

2. Start the setting.

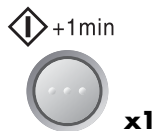

- Check the display.



NOTE: The selected language will be memorised, even if the electrical power supply is interrupted.

ENERGY SAVE MODE

Your oven has two operating modes, Energy Save Mode and Clock Set Mode.

The difference between them is that when you are not using the oven, in Energy save Mode nothing will appear on the digital display and in Clock Set Mode the time will be shown.

In Energy Save Mode, if you do not operate the oven for 3 minutes or more (i.e. closing the door, pressing the **STOP** key, or at the end of cooking), you will not be able to operate the oven.

To restore power on, open the door.

If you set the clock, energy save mode will be cancelled.

To start energy save mode manually, follow the instructions below.

Example:

To start the energy save mode (the current time is 23:35):

1. Make sure the correct time appears on the display.
2. Press the **INFO/CLOCK** button twice.
3. Adjust the display to 0 by rotating the **TIME/WEIGHT** dial.
4. Press **START**  **+1 min** button. The power will be off and the display will show nothing.

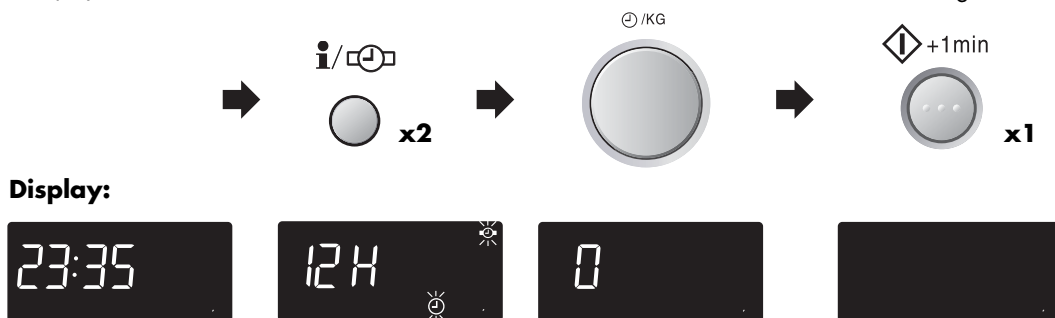

USING THE STOP BUTTON

STOP



Use the **STOP** button to:

1. Erase a mistake during programming.
2. Stop the oven temporarily during cooking.
3. Cancel a programme during cooking, press the **STOP** button twice.



SETTING THE CLOCK

There are two setting modes: 12 hour clock and 24 hour clock.

- 1.** To set the 12 hour clock, press the **INFO/CLOCK** button twice, as shown:

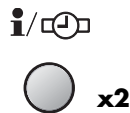

- 2.** To set the 24 hour clock, press the **INFO/CLOCK** button 3 times, as shown:

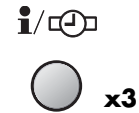

Example:

To set the 24 hour clock to 23:35:

- 1.** Choose the 24 hour clock by pressing the **INFO/CLOCK** button 3 times.



- 2.** Set the hours. Rotate the **TIME/WEIGHT** dial clockwise until the correct hour is displayed.



- 3.** Change from hours to minutes by pressing the **INFO/CLOCK** button once.

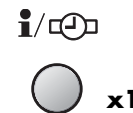

- 4.** Set the minutes. Rotate the **TIME/WEIGHT** dial clockwise until the correct minutes are displayed.



- 5.** Press the **INFO/CLOCK** button once to start the clock.

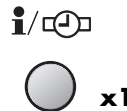

Check the display.



NOTES:

- You can rotate the **TIME/WEIGHT** dial clockwise or counter clockwise.
- Press the **STOP** button if you make a mistake during programming.
- If the oven is in cooking mode and you wish to know the time of day, touch the **INFO/CLOCK** button. As long as your finger is touching the button, the time of day will be displayed.
- If the electrical power supply to your microwave oven is interrupted, plug in the oven again, then open and close the door. The display will show:

"ENERGY SAVE MODE" in 6 languages.

If this occurs during cooking, the programme will be erased. The time of day will also be erased.

- When you want to reset the time of day, follow the above example again.
- If you do not set the clock, press the **STOP** button once. ".0" will appear on the display. When the operation of the oven is finished, ".0" will reappear on the display instead of the time of day.
- If you set the clock, energy save mode does not work.



MICROWAVE POWER LEVELS

Your oven has 5 power levels. To choose the power level, follow the advice given in the recipe section.



900 WATT = 100 % output

630 WATT = 70 % output

450 WATT = 50 % output

270 WATT = 30 % output

90 WATT = 10 % output

- To select Microwaving, rotate the **COOKING MODE** dial to the  MICROWAVE setting.
- Select the desired microwave power setting by pressing the **MICROWAVE POWER LEVEL** button.
- If the **MICROWAVE POWER LEVEL** button is pressed once,  (100 %) will be displayed. If you miss your desired level, continue pressing the **MICROWAVE POWER LEVEL** button until you reach the level again.
- If the power level is not selected, the level 900 W (100 %) is automatically set.**

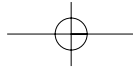



MICROWAVE COOKING

Your oven can be programmed for up to 90 minutes. (90.00). The input unit of cooking (defrosting) time varies from 10 seconds to five minutes. It depends on the total length of the cooking (defrosting) time as shown on the table opposite:

Cooking Time:	Increasing unit:
0-5 minutes	10 seconds
5-10 seconds	30 seconds
10-30 minutes	1 minute
30-90 minutes	5 minutes

Example:

Suppose you want to heat soup for 2 minutes and 30 seconds on 630 W microwave power.

1. Rotate the **COOKING MODE** dial to the  MICROWAVE setting.
2. Enter desired cooking time by rotating the **TIME/WEIGHT** dial clockwise.
3. Press the **MICROWAVE POWER LEVEL** button twice for 630 W microwave power.
4. Press the **START**  / **+1 min** button once to start cooking.

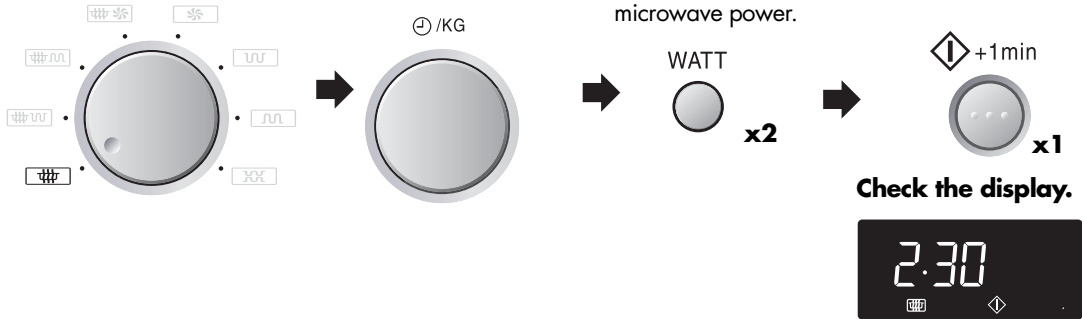





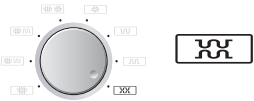

NOTES:

1. When the door is opened during the cooking process, the cooking time on the digital display stops automatically. The cooking time starts to count down again when the door is closed and the **START**  / **+1 min** button is pressed.
2. If you wish to know the power level during cooking, press the **MICROWAVE POWER LEVEL** button. As long as your finger is pressing the **MICROWAVE POWER LEVEL** button, the power level will be displayed.
3. You can rotate the **TIME/WEIGHT** dial clockwise or counter-clockwise. If you rotate the dial counter-clockwise, the cooking time will decrease from 90 minutes by degrees.

GRILL COOKING

Your oven has 2 grill heating elements, and a combination of 3 grill cooking modes. Select the desired grill mode by rotating the **COOKING MODE** dial to the desired setting.

COOKING MODE DIAL	GRILL HEATING ELEMENT IN USE	DISPLAY
	Top and Bottom Grill together	TOP AND BOTTOM 
	Top Grill	TOP GRILL 
	Bottom Grill	BOTTOM GRILL 

ENGLISH

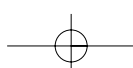





GRILL COOKING

Example:

Suppose you want to cook cheese on toast for 5 minutes using the top grill only: (Place toast on the high rack.)

1. Rotate the **COOKING MODE** dial to the  TOP GRILL setting.
2. Enter the desired cooking time by rotating the **TIME/WEIGHT** dial clockwise.
3. Press the **START**  / **+1 min** button once to start cooking.



1. The high or low racks are recommended when grilling.
2. You may detect smoke or a burning smell when using the grill for the first time, this is normal and not a sign that the oven is out of order. (Please see heating without food below.)
3. After cooking the display may show 'NOW COOLING'.



WARNING: The oven cavity, door, outer cabinet, turntable, racks, dishes and especially the bottom grill will become very hot, always use thick oven gloves when removing the food or turntable from the oven to prevent burns.



HEATING WITHOUT FOOD

You may detect smoke or a burning smell when using the grill(s) or dual grill for the first time. This is normal and not a sign that the oven is out of order. To avoid this problem, when first using the oven, operate both top and bottom grills without food for 20 minutes.

IMPORTANT: During grill operation, to allow smoke or smells to disperse open a window or switch the kitchen ventilation on. Make sure there is no food in the oven.

1. Rotate the **COOKING MODE** dial to the  TOP & BOTTOM GRILL setting.
 2. Enter the required heating time. (20 min.)
 3. Press the **START**  / **+1 min** button once to start cooking.
 4. The oven will count down. When the oven has finished cooking, open the door to cool the oven cavity.
-

WARNING: The oven door, outer cabinet & oven cavity will become hot. Take care to avoid burns when cooling the oven down after operation.

CONVECTION COOKING





This microwave oven has 10 pre-set oven temperatures which use a combination of the top and bottom grills.

Press CONVECTION button	1	2	3	4	5	6	7	8	9	10
Oven Temp (° C)	250	230	220	200	180	160	130	100	70	40

Example 1: To cook with preheating

Suppose you want to pre-heat to 180° C and cook for 20 minutes at 180° C.

1. Rotate the **COOKING MODE** dial to the  CONVECTION setting.
2. Enter the desired preheat temperature by pressing the **CONVECTION** button five times. The display will show 180° C.
3. Press the **START**  / **+1 min** button once to start preheating. When the pre-heated temperature has been reached the audible signal sounds, the display will show 180° C, open the door and place the food inside the oven. Close the door.

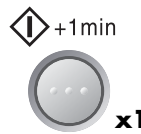
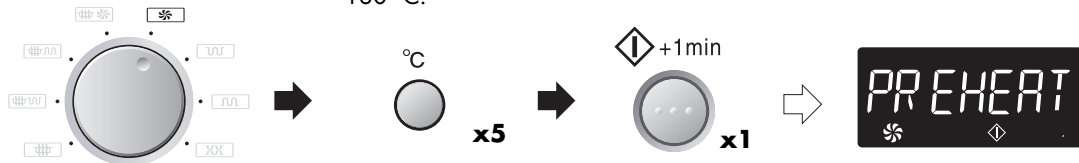

4. Enter desired cooking time by rotating the **TIME/WEIGHT** dial clockwise.



5. Press the **START**  / **+1 min** button once to start cooking.

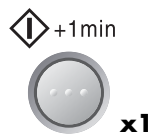

Check the display.

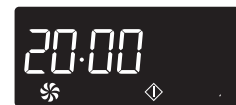

NOTES:

1. After preheating, if you want to cook at a different temperature press the **CONVECTION** button until the desired setting appears on the display. In the example above, to change the temperature you would press the **CONVECTION** button after entering the cooking time.
2. When the oven reaches the programmed preheating temperature, it will automatically hold at the pre-heated temperature for 30 minutes. After 30 minutes the display will change to time of day, if set. The selected convection programme will be cancelled.
3. After cooking the oven will automatically cool and the display will show "NOW COOLING".



ENGLISH



CONVECTION COOKING

Example 2: To cook without preheating

Suppose you want to cook at 250° C for 20 minutes.

1. Rotate the **COOKING MODE** dial to the  CONVECTION setting.
2. Enter desired cooking time by rotating the **TIME/WEIGHT** dial clockwise.
3. Enter the desired cooking temperature by pressing the **CONVECTION** button once (250° C).
4. Press the **START**  / **+1 min** button once to start cooking.



Check the display.

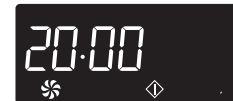

NOTES:

1. After cooking the oven will automatically cool and the display will show "NOW COOLING".
2. To change the convection temperature, press the **CONVECTION** button until the desired temperature appears on the display.
3. Temperature measurements taken whilst the oven is in convection mode will differ from the displayed level. This is due to the grill elements turning on and off in order to regulate the oven temperature. This will not affect the cooking results as long as the operation manual and cook book are followed correctly.

WARNING: The oven cavity, door, outer cabinet, turntable, racks, dishes and especially the bottom grill will become very hot, always use thick oven gloves when removing the food or turntable from the oven to prevent burns.

DUAL COOKING



Your oven has 3 **DUAL** cooking modes combining the heat of convection, top grill or bottom grill with the power of the microwave. To select the **DUAL** cooking mode rotate the **COOKING MODE** dial to the desired setting, then choose the cooking time. Generally, dual cooking time shortens the total cooking time.

Setting	COOKING MODE dial	Initial Microwave power	Cooking method	Display
DUAL 1 		270 W	Convection 250° C	
DUAL 2 		270 W	Top grill	
DUAL 3 		270 W	Bottom grill	

NOTES: The power settings are variable:

- DUAL 1: The oven temperature can be changed from 40° C to 250° C in ten levels.
Microwave power levels can be changed from 90 W - 450 W in three levels.
- DUAL 2 & 3: Microwave power levels can be changed from 90 W - 900 W in five levels.

Example 1:

Suppose you want to cook for 20 minutes on DUAL 1, using 90 W microwave power and 200° C convection.

1. Rotate the **COOKING MODE** dial to the DUAL 1 setting.
2. Enter desired cooking time by rotating the **TIME/WEIGHT** dial clockwise.
3. Press the **MICROWAVE POWER LEVEL** button twice for 90 W microwave power.

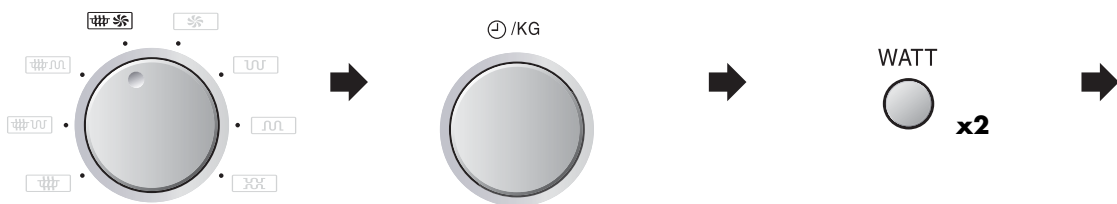

4. Enter the desired cooking temperature by pressing the **CONVECTION** button 4 times (200° C).
5. Press the **START** / **+1 min** button once to start cooking.

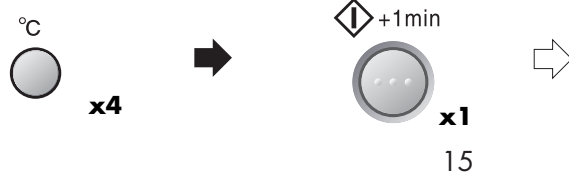

Check the display.

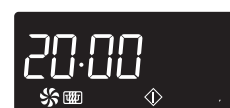

ENGLISH



DUAL COOKING

Example 2:

Suppose you want to cook for 20 minutes on DUAL 2, using 90 W microwave power and TOP GRILL.

1. Rotate the **COOKING MODE** dial to the  DUAL 2 setting.
2. Enter desired cooking time by rotating the **TIME/WEIGHT** dial clockwise.
3. Press the **MICROWAVE POWER LEVEL** button twice for 90 W microwave power.

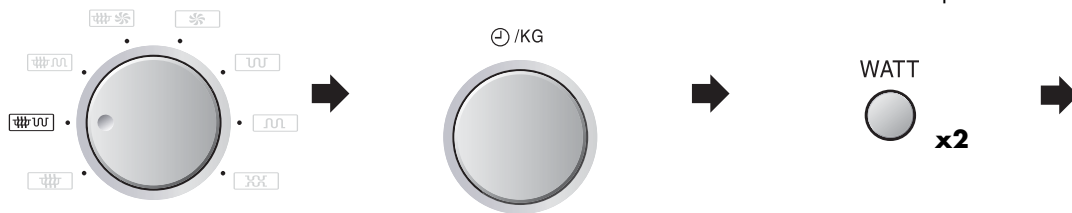

4. Press the **START**  button once to start cooking.

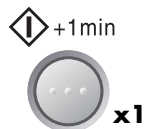

Check the display.



Example 3:

Suppose you want to cook for 20 minutes on DUAL 3, using 90 W microwave power and BOTTOM GRILL.

1. Rotate the **COOKING MODE** dial to the  DUAL 3 setting.
2. Enter desired cooking time by rotating the **TIME/WEIGHT** dial clockwise.
3. Press the **MICROWAVE POWER LEVEL** button twice for 90 W microwave power.

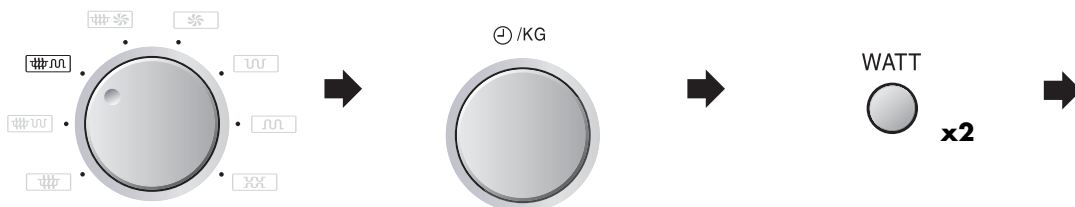

4. Press the **+1min/START**  button once to start cooking.

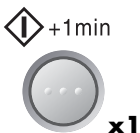

Check the display.



WARNING:

The oven cavity, door, outer cabinet, turntable, racks, dishes and especially the bottom grill will become very hot, always use thick oven gloves when removing the food or turntable from the oven to prevent burns.

NOTES:

1. After cooking, the display may show "NOW COOLING". To clear it, press the **STOP** button.
2. Temperature measurements taken whilst the oven is in convection mode will differ from the displayed level. This is due to the grill elements turning on and off in order to regulate the oven temperature. This will not affect the cooking results as long as the operation manual and cook book are followed correctly.

OTHER CONVENIENT FUNCTIONS



1. LESS / MORE button.

The **LESS** (▼) and **MORE** (▲) buttons allow you to easily decrease or increase programmed setting times, (for a less well or more well cooked result), used in automatic operations or cooking time while in operation.

a) Changing the pre-programmed time setting.

Example:

Suppose you want to cook 0.4 kg Grill Skewers using the **AUTO COOK** button and **MORE** (▲) button.

1. Choose the desired result (well cooked) by pressing the **MORE** (▲) button once.
2. Select **AUTO COOK** (Grill Skewers) by pressing the **AUTO COOK** button once.
3. Enter the amount by rotating the **TIME/WEIGHT** dial clockwise.
4. Press the **START** (◊) / **+1 min** button once to start cooking.

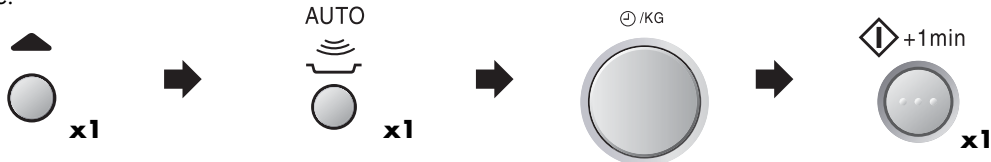

Display:

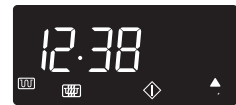

NOTE:

To cancel **LESS** or **MORE**, press the same button again.
 To change **MORE** to **LESS** simply press the **LESS** (▼) button.
 To change **LESS** to **MORE** simply press the **MORE** (▲) button.

b) Adjusting the heating time while oven is operating.

During the manual cooking process, the cooking time can be decreased or increased in 1 minute steps each time the **LESS** (▼) and **MORE** (▲) buttons are pressed.

NOTE:

You can use this function for manual cooking only.



OTHER CONVENIENT FUNCTIONS

2. MINUTE PLUS function.

The **START**  **/+1min** button allows you to operate the two following functions:

a) 1 minute cooking

You can cook on your desired cooking mode for 1 minute without entering the cooking time.

Example:

Suppose you want to cook for 1 minute at 630 W microwave power.

1. Rotate the **COOKING MODE** dial to the  **MICROWAVE** setting.

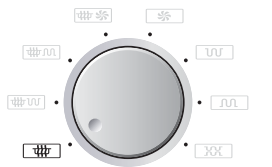

2. Press the **MICROWAVE POWER LEVEL** button twice for 630 W microwave power.

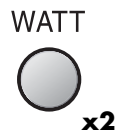







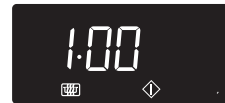

3. Press the **START**  **/+1min** button to start cooking.



Check the display.



NOTES:

- You can use this function for manual cooking only.
- When the **COOKING MODE** dial is on microwave () and you press the **START**  **/+1min** button, the microwave power is always 900 watt.
When the **COOKING MODE** dial is on dual (,  or ) and you press the **START**  **/+1min** button, the microwave power is always 270 watt.
When the **COOKING MODE** dial is on convection or dual 1 ( or ) and you press the **START**  **/+1min** button, the convection temperature is always 250° C.
- To avoid misuse by children the **1 minute cooking** function can be used only within 3 minutes after the preceding operation, ie closing the door or pressing the **STOP** button.

b) Extend the cooking time

You can extend the cooking time in multiples of one minute if the button is pressed while the oven is in operation.

NOTE:

You can use this function for manual cooking only.

OTHER CONVENIENT FUNCTIONS



3. TO CHECK SETTINGS WHILE THE OVEN IS OPERATING

You can check the power level and the actual oven temperatures ie: when pre-heating.

TO CHECK THE POWER LEVEL:

To check the microwave power level during cooking press the **MICROWAVE POWER LEVEL** button. The oven continues to count down, although the display shows the power level.

WATT



As long as your finger is pressing the button, the power level will be displayed.

TO CHECK THE CONVECTION TEMPERATURE:

To check the convection temperature during cooking press the **CONVECTION** button. When the oven is pre-heating, you can check the actual oven temperature.

°C



As long as your finger is pressing the button, the convection temperature in °C will be displayed.

4. INFORMATION button

Each button carries useful information. If you wish to get the information, press the **INFO/CLOCK** button before pressing the desired button.

Example:

Suppose you want to get information about AUTO COOK menu number 2, Roast Chicken:

1. Choose the **INFO/CLOCK** button function.
2. Press the **AUTO COOK** button twice to select the AUTO COOK menu AC-2.



x1



AUTO



x2



Check the display.

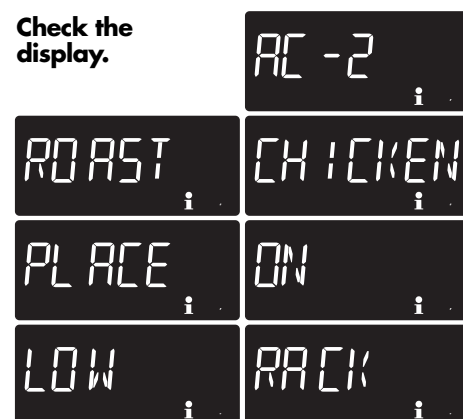

NOTE:

1. The information message will be repeated twice, and then the display will show the time of day, if set.
2. If you want to cancel the information press the **STOP** button.

ENGLISH



AUTOMATIC OPERATION (EXPRESS PIZZA)

The **EXPRESS PIZZA** function automatically cooks frozen pizza very quickly. The following steps provide additional information on using this feature:

1. In order to prevent the accidental use of the oven, the **EXPRESS PIZZA** can only be input within 3 minutes after cooking completion, closing the door or pressing the **STOP** key.
2. The weight of the pizza is input by pressing the **EXPRESS PIZZA** key multiple times, until the desired weight is displayed. Enter the weight of the food only.
For food weighing more or less than the weights given in the cooking chart, cook using PIZZA function (see pages 21 - 22) or manual operation.
3. The programmed cooking time is an average time. If you want to alter the cooking time, use the **LESS (▼)** or **MORE (▲)** buttons before pressing the **EXPRESS PIZZA** button (see page 17).
If you want the best pizza result, use the PIZZA function (P-1 Frozen Pizza), see pages 21 - 22.
4. There is no need to press the **START** button as the oven will automatically start to cook after the weight has been input.

NOTE:

The final temperature will vary according to the initial temperature, i.e. whether it was chilled or at room temperature. Check food is piping hot after cooking. If necessary, you can extend the cooking time manually.

WARNING: The oven cavity, door, outer cabinet, turntable, racks, dishes and especially the bottom grill will become very hot, always use thick oven gloves when removing the food or turntable from the oven to prevent burns.

Example: To cook Frozen Pizza 0,3 kg.

1. To select the menu and weight range required, press the **EXPRESS PIZZA** button once.



x1



After 2 seconds the oven will start to cook automatically.



EXPRESS PIZZA CHART

BUTTON	MENU	WEIGHT (Increasing Unit) / UTENSILS	PROCEDURE
	Express Frozen Pizza 	0,3/0,35/0,4 kg (50 g) (initial temp -18° C) Directly on the turntable	<ul style="list-style-type: none"> • Remove the ready prepared frozen pizza from the packaging and place on the turntable. • After cooking, place on a plate for serving.

AUTOMATIC OPERATION (PIZZA/FUN MENUS/AUTO COOK/AUTO DEFROST)



These automatic functions are designed to work out the correct cooking mode and cooking time to get the best results. You can choose from the 3 PIZZA, 5 FUN MENUS, 5 AUTO COOK and 5 AUTO DEFROST menus.

PIZZA button



PIZZA

FUN MENUS button



FUN

(())

AUTO COOK button



AUTO

AUTO DEFROST button



DEFROST

WARNING: For all menus except AUTO DEFROST:





The oven cavity, door, outer cabinet, turntable, racks, dishes and especially the bottom grill will become very hot. Use thick oven gloves when removing food or the turntable from the oven to prevent burns.

The following steps provide additional information on using this feature:

1. The menu you wish to use can be selected by pressing the **PIZZA**, **FUN MENUS**, **AUTO COOK** or **AUTO DEFROST** button until the desired menu number is displayed.
2. The weight of the food can be input by rotating the **TIME/WEIGHT** dial until the desired weight is displayed. (Except FUN MENUS C-4 and C-5). Enter the weight of the food only. Do not include the weight of the container.
For food weighing more or less than weights/quantities given in the cooking chart, cook using manual operation.
3. The programmed cooking times are average times. If you want to alter cooking times pre-programmed in the automatic operations, use the **LESS** (▼) or **MORE** (▲) buttons. For best results follow the cooking chart instructions, pages 22 - 25.
4. Press the **START** (◊) / **+1 min** button to start cooking.

When action is required (e.g. to turn food over) the oven stops, the audible signals sound and the display shows the necessary action. To continue cooking, press the **START** (◊) / **+1 min** button.

Example:

1.  PIZZA **PIZZA** button
2.  /KG **TIME/WEIGHT** dial
3.  **LESS/MORE** buttons
4.  +1min **START** (◊) / **+1 min** button

The final temperature will vary according to the initial temperature, i.e. whether it was chilled or at room temperature. Check food is piping hot after cooking. If necessary, you can extend the cooking time manually.



AUTOMATIC OPERATION (PIZZA/FUN MENUS/AUTO COOK/AUTO DEFROST)







The **PIZZA**, **FUN MENUS**, **AUTO COOK** and **AUTO DEFROST** buttons offer the possibility to cook foods quickly and easily.

Example: Suppose you want to cook Grill Skewers (Kebabs) weighing 0.4 kg using the **AUTO COOK** button.

1. Choose the AUTO COOK menu AC-1 by pressing the **AUTO COOK** button once. Cooking information will appear: The weight indicator will flash on the display:
2. Enter the weight by rotating the **TIME/WEIGHT** dial clockwise.
3. Press the **START**  / **+1 min** button to start cooking.



PIZZA CHART

BUTTON	MENU	WEIGHT (Increasing Unit) / UTENSILS	PROCEDURE
 x1	P-1 Pizza  Frozen Pizza	0,15 - 0,60 kg (50 g) (initial temp -18° C) Directly on the turntable	<ul style="list-style-type: none"> • Remove the ready prepared frozen pizza from the packaging and place on the turntable. For thick base pizza, press the MORE (▲) button. • After cooking, place on a plate for serving.
 x2	P-2 Pizza  Chilled Pizza	0,15 - 0,45 kg (50 g) (initial temp 5° C) Directly on the turntable	<ul style="list-style-type: none"> • Remove the ready prepared chilled pizza from the packaging and place on the turntable. • After cooking, place on a plate for serving.
 x3	P-3 Pizza  Fresh Pizza e.g. Homemade Pizza	0,7 - 1,0 kg (100 g) (initial temp 20° C) Directly on the turntable	<ul style="list-style-type: none"> • Prepare the pizza following the recipe below. • Place directly on the turntable. • After cooking, place on a plate for serving.

PIZZA RECIPE

Ingredients:





300 g Approx.	Ready prepared dough (Ready mix or roll out dough.)
200 g Approx.	Tinned tomatoes
150 g	Topping as desired (e.g. corn, ham, salami, pineapple)
50 g	Grated cheese Basil, oregano, thyme salt, pepper

Procedure:

1. Prepare the dough according to the manufacturer's instructions. Roll out to the size of the turntable.
2. Lightly grease the turntable and place the pizza base on it and pierce the dough.
3. Drain the tomatoes and cut into pieces. Season the tomatoes with the herbs and spread on the dough. Put all other ingredients on the pizza and finally cover with the cheese.
4. Cook on **P-3 Pizza** "Fresh Pizza".











FUN MENUS CHART



BUTTON	MENU	WEIGHT (Increasing Unit) / UTENSILS	PROCEDURE
FUN (()) ● x1	C-1 Fun Menu Frozen Baguettes * e.g. Baguettes with Pizza topping 	0,15 - 0,50 kg (50 g) (initial temp -18° C) Directly on the turntable	<ul style="list-style-type: none"> Remove the deep frozen baguettes from the packaging and place on the turntable. After cooking, place on a plate for serving.
FUN (()) ● x2	C-2 Fun Menu Fish Fingers * 	0,20 - 0,50 kg (50 g) (initial temp -18° C) Directly on the turntable	<ul style="list-style-type: none"> Remove the deep frozen fish fingers from the packaging and place on the turntable. After cooking, place on a plate for serving.
FUN (()) ● x3	C-3 Fun Menu French Fried Potatoes * (recommended for conventional ovens) e.g Standard and thick type 	0,20 - 0,40 kg (50 g) (initial temp -18° C) Directly on the turntable	<ul style="list-style-type: none"> Remove the deep frozen French fried potatoes from the packaging and place in one layer on the turntable. For thick French fried potatoes, use the MORE (▲) button. After cooking, place on a plate for serving.
FUN (()) ● x4	C-4 Fun Menu Vegetarian Food 	(initial temp 20° C) Gratin dish Low rack	<ul style="list-style-type: none"> See recipes for Vegetarian Food on page 26.
FUN (()) ● x5	C-5 Fun Menu Desserts e.g. Fruit Crumble 	(initial temp 20° C) Gratin dish Low rack	<ul style="list-style-type: none"> See recipe for Desserts on page 26.



AUTO COOK CHART

BUTTON	MENU	WEIGHT (Increasing Unit) / UTENSILS	PROCEDURE
AUTO  x1	AC-1 Cook  Grill Skewers See recipes on page XX.	0,2 - 0,8 kg (100 g) (initial temp 5° C) High rack	<ul style="list-style-type: none"> • Prepare the grill skewers. • Place on the high rack and cook. • When the audible signal sounds turn over. • After cooking, place on a plate for serving.
AUTO  x2	AC-2 Cook  Roast Chicken Ingredients for 1,2 kg grilled chicken: Salt and Pepper, 1 tsp sweet paprika, 2 tbsp oil	0,9 - 1,8 kg (100 g) (initial temp 5° C) Low rack	<ul style="list-style-type: none"> • Mix the ingredients and spread on the chicken. • Pierce the skin of the chicken with a fork. • Put chicken, breast side down, on the low rack. • When audible signals sound, turn the chicken over. • After cooking, leave for approx. 3 minutes in the oven, remove and put on a plate for serving.
AUTO  x3	AC-3 Cook  Gratinated Fish Fillet	0,6 - 1,2 kg* (100 g) (initial temp 5° C) Gratin dish Low rack	<ul style="list-style-type: none"> • See recipes for Gratinated Fish Fillet on page 27. * Indicates the total weight of all ingredients.
AUTO  x4	AC-4 Cook  Gratin See recipes on page XX.	0,5 - 1,5 kg* (100 g) (initial temp 5° C) Gratin dish Low rack	<ul style="list-style-type: none"> • Prepare the gratin. • Place the gratin on the low rack. • After cooking, let the food stand, wrapped in aluminium foil, for approx. 5 minutes. * Indicates the total weight of all ingredients.
AUTO  x5	AC-5 Cook  Cake See recipes on page XX.	0,5 - 1,5 kg* (100 g) initial temp 20° C) Cake dish Low rack Saucer	<ul style="list-style-type: none"> • Prepare the cake. • Place the cake dish on the low rack and put a saucer between the low rack and the tin. • After cooking, remove and stand for approx. 10 minutes.

AUTO DEFROST CHART



BUTTON	MENU	WEIGHT (Increasing Unit) / UTENSILS	PROCEDURE
DEFROST x1	AD-1 Defrost * Steaks and Chops	0,2 - 1,0 kg (100 g) (initial temp -18° C) (See note below)	<ul style="list-style-type: none"> Place the food on a plate in the centre of the turntable. When the oven stops and the audible signals sound, turn the food over, rearrange and separate. Shield thin parts and warm spots with aluminium foil. After defrosting, wrap in aluminium foil for 10 - 20 minutes, until thoroughly defrosted.
DEFROST x2	AD-2 Defrost * Minced Meat	0,2 - 1,0 kg (100 g) (initial temp -18° C) (See note below)	<ul style="list-style-type: none"> Place the block of minced meat on a plate in the centre of the turntable. When the oven stops and the audible signals sound, turn the food over. Remove the defrosted parts if possible. After defrosting, stand for 5 - 10 minutes, until thoroughly defrosted.
DEFROST x3	AD-3 Defrost * Poultry	0,9 - 2,0 kg (100 g) (initial temp -18° C) (See note below)	<ul style="list-style-type: none"> Place a plate upside down on the turntable and put the poultry, breast side down, on the plate. When the oven stops and the audible signals sound, turn the food over. Shield thin parts and warm spots with aluminium foil. After defrosting, cover with aluminium foil and stand for 30 - 90 minutes, until thoroughly defrosted.
DEFROST x4	AD-4 Defrost * Cake	0,1 - 1,4 kg (100 g) (initial temp -18° C) Flat dish	<ul style="list-style-type: none"> Remove all packaging from the cake. Place on a flat dish in the middle of the turntable. After defrosting, cut the cake into similar sized pieces keeping space between each piece and let stand for 15 - 70 minutes until evenly defrosted.
DEFROST x5	AD-5 Defrost * Bread	0,1 - 1,0 kg (100 g) (initial temp -18° C) Flat dish (Only sliced bread is recommended for this programme.)	<ul style="list-style-type: none"> Distribute on a flat dish in the centre of the turntable. When the audible signal sounds rearrange, and remove defrosted slices. After defrosting separate all slices and distribute on a large plate. Cover the bread with aluminium foil and let stand for 5 - 10 minutes until thoroughly defrosted.

NOTE: Auto Defrost

- Steaks and Chops should be frozen in one layer.
- Minced meat should be frozen in the thin shape.
- After turning over, shield the defrosted portions with small, flat pieces of aluminium foil.
- The poultry should be processed immediately after defrosting.
- For Steaks, Chops, Minced Meat and Poultry arrange the food in the oven as shown below:

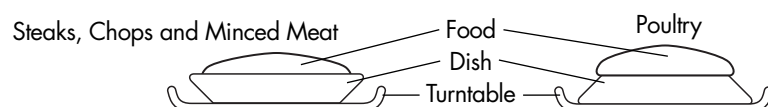



RECIPES FOR FUN MENUS

VEGETARIAN FOOD (C-4)

Stuffed Courgettes

Ingredients:

- 4 courgettes of same size (total weight: 700-900 g)
- 2 bunches spring onions
- 4 tomatoes (400 g)
- 200 g feta cheese, diced
- 40 g rusk
- 1 egg
- salt and pepper
- 10 g butter or margarine for greasing the pan

For the sauce:

- 150 ml vegetable stock
- 100 ml cream
- 62,5 g soft cheese
- 25 g sunflower kernel

VEGETARIAN FOOD (C-4)

Stuffed Pepper

Ingredients:

- 4 red peppers
- 2 onions
- 200 g fresh mixed mushrooms
- 2 eggs
- 100 g emmenthal cheese, grated
- 25 g bread crumbs
- bunch citril finch (leaves of citron)
- bunch parsley
- salt, pepper and nutmeg
- 10 g butter or margarine for greasing the pan

For the sauce:

- 240 g small can peeled tomatoes, drain well
- 100 g Crème fraîche
- 150 ml white wine
- herbs of the provence

DESSERTS (C-5)

Raspberry, Apple and Almond Crumble

Ingredients:

For the filling:

- 250 g frozen raspberries
- 2 eating apples, peeled and thinly sliced
- 50 g brown sugar
- 15 ml Crème de cassis

For the crumble:

- 75 g butter
- 125 g plain flour
- 100 g chopped almonds
- 75 g caster sugar

Procedure:

- Wash the courgettes, cut lengthwise into half, remove the pins, take off the inside and dice it. Wash the spring onions and cut them into small slices. Boil over the tomatoes, peel and dice.
- Beat the egg, season with salt and pepper, crumble the rusk in it and mix all together with diced tomatoes, feta cheese, the diced courgettes and half of the spring onions.
- Grease the gratin dish, put the half courgettes in it and fill them with the mixture.
- Place the gratin dish on the low rack and cook on **FUN MENUS C-4** "Vegetarian food".
- Meanwhile beat together vegetable stock, cream and soft cheese and add the remaining spring onions. When the audible signals sound and the oven stops, add the sauce, and sprinkle over the sunflowerkernel and press the **START** key.
- After cooking, let stand for 5 minutes.

Procedure:

- Cut the red peppers lengthwise into half, remove the stalks and pins, wash and dry. Cut the onions into small cubes and mix together with the sliced mushrooms.
- Beat eggs and mix with emmenthal cheese, bread crumbs, onions, mushrooms and finely chopped herbs. Season the mixture and fill the red peppers.
- Put the stuffed peppers in a greased gratin dish, place the gratin dish on the low rack and cook on **FUN MENUS C-4** "Vegetarian food".
- Meanwhile mix together tomatoes with Crème fraîche, white wine and herbs. When the audible signals sound and the oven stops, add the sauce and press the **START** key.
- After cooking, let stand for 5 minutes.

Procedure:

- Place raspberries, apples sugar and crème de cassis in a gratin dish and mix well. Heat for 5 minutes on 900 W, stir after half of cooking time.
- Meanwhile prepare the crumble. Rub the butter into the flour until mixture resembles fine breadcrumbs, stir in the chopped almonds and caster sugar.
- Spoon the crumble evenly on top of the fruit. Place on the low rack and cook on **FUN MENUS C-5** "Dessert".

HINT: You can use tinned cherries (200 g) or tinned peaches (200 g) instead of frozen raspberries, apples and brown sugar. In this case it is not necessary to precook the fruits.

RECIPES FOR AUTO COOK AC-3



GRATINATED FISH FILLET (AC-3)

Fish Gratin Italian Style

Ingredients: 600 g Rose Fish Fillet
 250 g Mozzarella. approx
 250 g tomatoes
 2 tbsp. anchovy butter
 salt and pepper
 1 tbsp chopped basil
 lemon juice of 1/2 lemon
 2 tbsp chopped mixed herbs
 75 g grated Gouda (45 % fat)
 sauce thickening powder

Procedure:

- Wash the Fish and dry. Sprinkle with lemon juice and salt and grease with the anchovy butter.
- Place in an oval gratin dish (32 cm).
- Sprinkle the gouda over the fish.
- Wash the tomatoes and remove the stalks. Cut into slices and place on top of the cheese.
- Season with salt, pepper and the mixed herbs.
- Drain the mozzarella, cut into slices and place on the tomatoes. Spread over the basil.
- Place the gratin dish on the low rack and cook on **AUTO COOK AC-3** "Gratinated Fish Fillet" (1,2 kg).

Hint: After cooking remove the fish from the gratin dish and stir in some sauce thickening powder. Cook again for 1-2 minutes on 900 W power.

GRATINATED FISH FILLET (AC-3)

Gratinated Rose Fish Fillets 'Esterhazy'

Ingredients: 600 g Rose Fish Fillet
 250 g Leeks
 50 g onion
 100 g carrot
 1 tbsp. butter
 salt, pepper and nutmeg
 2 tbsp. lemon juice
 125 g crème fraîche
 100 g grated Gouda (45 % fat)

Procedure:

- Wash the leeks and divide in 2 parts from top to bottom. Cut into thin strips.
- Peel the onions and carrots and cut into thin strips.
- Put the vegetables, butter and spices into a casserole dish and mix well. Cook for 5-6 minutes on 900 W power. Stir once in-between cooking.
- In the meantime wash the fish fillet, dry and sprinkle with lemon juice and salt.
- Mix the Crème fraîche under the vegetables and season again.
- Put half of the vegetables in an oval gratin dish (32 cm). Place the fish on top and cover with the remaining vegetables.
- Spread over the Gouda and place on the low rack. Cook on **AUTO COOK AC-3** "Gratinated Fish Fillet" (1,2 kg).

GRATINATED FISH FILLET (AC-3)

Gratinated Rose Fish - Broccoli.

Ingredients: 500 g Rose Fish Fillet
 2 tbsp. lemon juice
 1 tbsp. butter
 2 tbsp flour
 300 ml milk
 chopped dill, pepper and salt
 250 g frozen broccoli
 100 g grated Gouda (45 % fat)

Procedure:

- Wash the fish fillet and dry. Sprinkle with lemon juice and salt.
- Heat together butter and flour in a casserole dish without cover for 1-1¹/₂ mins on 900 W power.
- Add the milk and stir well. Cook again without cover for 3-4 minutes on 900 W power. After cooking stir and season with dill, salt and pepper.
- Defrost the broccoli in a casserole dish for 4-6 mins on 900 W power. Once defrosted, place the broccoli into a gratin dish (32 cm) and put the fish on top and season.
- Pour the sauce over and sprinkle over the cheese
- Place on low rack and cook on **AUTO COOK AC-3** "Gratinated Fish Fillet" (1,1 kg).



CARE AND CLEANING

CAUTION: DO NOT USE COMMERCIAL OVEN CLEANERS, STEAM CLEANERS, ABRASIVE, HARSH CLEANERS, ANY THAT CONTAIN SODIUM HYDROXIDE OR SCOURING PADS ON ANY PART OF YOUR MICROWAVE OVEN

WARNING!
After **GRILL, CONVECTION, DUAL and AUTOMATIC** operation (except Auto Defrost) modes, the oven cavity, door, oven cabinet and accessories will become very hot. Before cleaning, make sure they have cooled down.

Oven exterior

The outside of your oven can be cleaned easily with mild soap and water. Make sure the soap is wiped off with a moist cloth, and dry the exterior with a soft towel.

Oven controls

Open the door before cleaning to de-activate the oven controls. Care should be taken when cleaning the oven control. Using a cloth dampened with water only, gently wipe the panel until it becomes clean. Avoid using excessive amounts of water. Do not use any chemical or abrasive cleaners.

Oven Interior

1. For cleaning, wipe any splatters or spills with a soft damp cloth or sponge after each use while the oven is still warm. For heavier spills, use a mild soap and wipe several times with a damp cloth until all residues have been removed. Do not remove the waveguide cover.
2. Make sure that mild soap or water does not penetrate the small vents in the walls which may cause damage to the oven.
3. Do not use spray type cleaners on the oven interior.
4. Heat up your oven regularly by using both heating elements, refer to "Heating without food" on page 12. Remaining food or fat splashed on the oven interior can cause smoke or a bad smell.

Turntable

Remove the turntable. Wash the turntable in mild soapy water. Dry with a soft cloth. The turntable is dishwasher safe.

Low Rack and High Rack

These should be washed in a mild washing up liquid solution and dried. High and Low racks are dishwasher safe.

Door

To remove all trace of dirt, regularly clean both sides of the door, the door seals and adjacent surfaces with a soft, damp cloth.

NOTE: A steam cleaner should not be used.

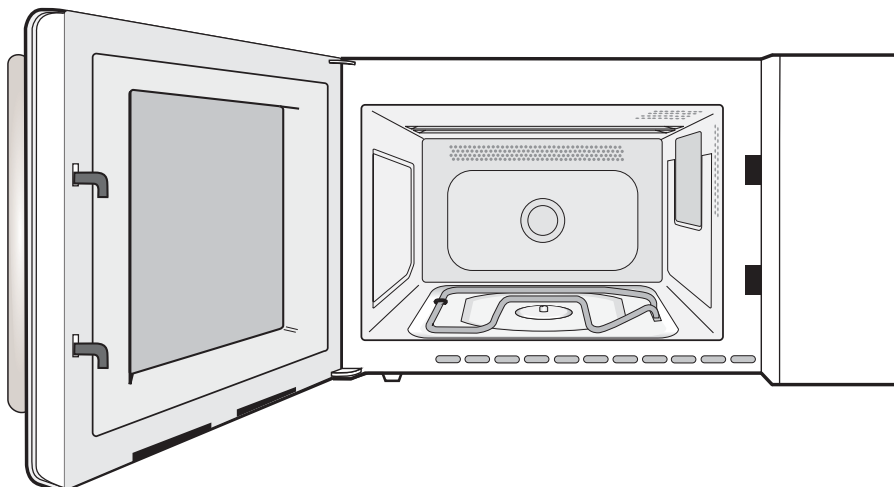

SERVICE CALL CHECK



PLEASE CHECK THE FOLLOWING BEFORE CALLING FOR SERVICE:

1. Power Supply:
Check the power plug is properly connected to a suitable wall outlet.
Check the line fuse/circuit breaker is functioning properly.
2. When the door is opened, does the oven lamp turn on? YES _____ NO _____
3. Place a cup of water (approx. 150 ml) in the oven and close the door securely.
Set the **COOKING MODE** dial to microwave setting.
Programme the oven for one minute on 900 W power and start the oven.
Does the oven lamp come on? YES _____ NO _____
Does the turntable rotate? YES _____ NO _____
NOTE: The turntable turns in either direction.
Does the ventilation work? YES _____ NO _____
(Place your hand over the ventilation openings and check for air flow.)
After 1 minute does the signal sound? YES _____ NO _____
Does the cooking in progress indicator go off? YES _____ NO _____
Is the cup of water warm after the above operation? YES _____ NO _____
4. Set the **COOKING MODE** dial to the TOP & BOTTOM GRILL setting for 3 minutes. After 3 minutes do both GRILL heating elements become red? YES _____ NO _____

If you answer "NO" to any of the above questions, call a Service Technician appointed by SHARP and report the results of your check. See inside back cover for details of address.

IMPORTANT: If the display shows nothing even if the power supply plug is properly connected, the energy save mode may be in operation. Open and close the oven door to operate the oven. See page 9.

NOTE:

1. If you cook the food over the standard time with only the same cooking mode, the power of the oven will lower automatically to avoid overheating. (The microwave power level will be reduced and the grill heating elements will begin to light on and off.)

Cooking mode	Standard time
Microwave 900 W cooking	20 min.
Grill cooking	
TOP GRILL <input type="checkbox"/>	15 min.
BOTTOM GRILL <input type="checkbox"/>	15 min.
TOP and BOTTOM GRILL <input type="checkbox"/>	Top grill - 6 min. Bottom grill - 6 min.
Dual 2 <input type="checkbox"/> (900 watt microwave power only)	Micro - 20 min. Top grill - 15 min.
Dual 3 <input type="checkbox"/> (900 watt microwave power only)	Micro - 20 min. Bottom grill - 15 min.

2. After the GRILL (using both heating elements), DUAL, CONVECTION and AUTOMATIC OPERATION (except AUTO DEFROST), the cooling fan will run and "NOW COOLING" will appear on the display. Also, when you press the **STOP** button and open the door during the GRILL, DUAL, CONVECTION and/or automatic cooking (except AUTO DEFROST), the cooling fan will run; you may, therefore, feel air blowing from the ventilation openings.

• SEULEMENT VALIDE POUR L'ALLEMAGNE • SLECHTS GELDIG VOOR DUITSLAND •
• SOLTANTO VALIDO PER LA GERMANIA • SOLAMENTE VÁLIDO PARA ALEMANIA •

Haushaltsgeräte

Gilt nur für Deutschland

Lieber SHARP Kunde,

SHARP- Geräte sind Markenartikel, die mit Präzision und Sorgfalt nach modernen Fertigungsmethoden hergestellt werden. Bei sachgemäßer Handhabung und unter Beachtung der Bedienungsanleitung wird Ihnen Ihr Gerät lange Zeit gute Dienste leisten.

Das Auftreten von Fehlern ist aber nie auszuschließen. Sollte Ihr Gerät innerhalb der gesetzlichen oder mit Ihrem Verkäufer vereinbarten Verjährungsfristen für Sachmängel-/ Garantiefristen einen Mangel aufweisen, so wenden Sie sich bitte an den Handelsbetrieb, bei dem Sie das Gerät erworben haben, denn dieser ist Ihr Ansprechpartner für Sachmängel / Garantieansprüche.

.....

Wichtiger Hinweis für alle ein-/ untergebaute Haushalts-Mikrowellengeräte

Wurde Ihr Gerät von einem Handelsbetrieb fachgerecht mit einem von SHARP genehmigten Einbaurahmen ein-/ bzw. untergebaut, so können Sie sich direkt an unseren:



zwecks Reparaturabwicklung im Vor-Ort-Service wenden:

Achtung:

Wird dieser Service für von Ihnen selbst ein-/untergebaute Geräte in Anspruch genommen, sind für Aus- /und Einbau, Fahrzeit und Km die entstehenden Kosten von Ihnen zu tragen!

Bitte erkundigen Sie sich vor Anforderung des Kundendienstes bei diesem über die anfallenden Kosten.

Den für Sie nächstgelegenen Kundendienst nennt Ihnen gern unsere og. Hotline.

Als Nachweis für Sachmängel-/ Garantiarbeiten dient Ihr Kaufbeleg / Rechnung

Selbstverständlich können Sie unseren QUICK 48 Vor-Ort-Service Mikrowellengeräte auch nach Ablauf der Verjährungsfristen für Sachmängel-/Garantiefristen in Anspruch nehmen, dann jedoch gegen Aufwandsberechnung des jeweiligen Kundendienstes.

SHARP ELECTRONICS (EUROPE GmbH)
Parts & Technical Services

<http://www.sharp.de>

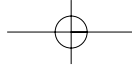

• ADDRESSES D'ENTRETIEN • ONDERHOUDSADRESSEN • DIRECCIONES DE SERVICIO • INDIRIZZI DI SERVIZIO •

ÖSTERREICH - <http://www.sharp.at>

Bei einer Reklamation Ihrer SHARP Mikrowelle wenden Sie sich bitte an Ihren Fachhändler oder an eine der nachfolgend aufgeführten SHARP SERVICE Niederlassungen.

Fa. Manfred Mayer GmbH, 1234 Wien, Stippckgasse 6, 01 - 609 31 20
Fa. MCL-Service GesmbH, 1232 Wien, Deutschstr. 19, 01 - 616 88 00
Fa. Schuhmann Ges.m.b.H., 4030 Linz, Gablonzerweg 18, 0732 - 38 22 80
Fa. Roland Göschl, 5020 Salzburg, Bayerhammerstr. 12c, 0662 - 88 23 07
Fa. Reitmeir, 6020 Innsbruck, Leopoldstr. 57, 0512 - 93 82 53
Radio-TV A. Moser, 6900 Bregenz, An der Heufurt 28, 05574 - 757 77
Fa. AV-Pichler, 8055 Graz, Am Wagrain 342, 0316 - 29 12 92
Fa. Audio Video Service, 9020 Klagenfurt, Feldkirchnerstr. 72, 0463 - 431 14
Fa. Scheuermann, 9500 Villach, Rennsteinerstr. 8, 04242 - 211 74

BELGIUM - <http://www.sharp.be>

En cas d'une réclamation concernant une four a micro-onde SHARP, nous vous prions de vous adresser à votre spécialiste ou à une adresse des SHARP Services suivantes.

Indien uw magnetron problemen geeft kunt u zich wenden tot uw dealer of een van de onderstaande Sharp service centra.

SHARP ELECTRONICS, Phone: 0900-10158
AVTC, Kleine Winkellaan 54, 1853 Strombeek-Bever, 02/2674019
ETS HENROTTE, Rue Du Campinaire 154, 6240 Farciennes, 071/396290
Nouvelle Central Radio (N.C.R.), Rue des Joncs 15 L-1818 HOWALD, 00352404078
Service Center Deinze, Kapellestraat, 95, 9800 DEINZE, 09-386.76.67

NEDERLAND - <http://www.sharp.nl>

Indien uw magnetron problemen geeft kunt u zich wenden tot uw dealer of naar onderstaand Sharp Service Centrum.

SHARP ELECTRONICS BENELUX BV, Helpdesk -Postbus 900, 3990 DW Houten, 0900-7427723

FRANCE - <http://www.sharp.fr>

En cas de réclamation pour les fours micro-ondes SHARP, nous vous prions de vous adresser à votre spécialiste ou à l'une des stations techniques agréées SHARP suivantes:

A.A.V.I., 1 rue du Mont de Terre, 59818 Lesquin Cedex, 03.20.62.18.98
A.A.V.I. (Point d'Accueil), 9-11 rue Léon Trulin, 59000 Lille, 03.20.14.96.20
ATELIER ROUSSEL, 12 Bld Flandre Dunkerque, 56100 Lorient, 02.97.83.07.41
BASTIA TELE VIDEO, Immeuble Le Béarn - Av. de la libération, 20600 Bastia, 04.95.30.81.29
C.M.T.S., 38 rue des Ormeaux, 75020 Paris, 01.43.70.20.00
ELECTRONIC SERVICE PLUS, 5 bd LOUIS XI - ZI le Menneton, 37000 Tours, 02.47.77.90.90
ELECTRO SERVICE, 21 rue de Mulhouse - B.P 122, 68313 Illzach, 03.89.62.50.00
M.R.T., 74 Rue Albert Einstein - 72021 Le Mans Cedex, 02.43.28.52.20
S.T.E., 3 chemin de l'Industrie, 06110 Le Cannet Rocheville, 04.93.46.05.00
S.T.R. AQUITAINE, 111 rue Bouthier - B.P 27, 33015 Bordeaux, 05.57.80.78.07
S.T.V.S., 1 rue de la Presse, 42000 Saint Etienne, 0825.898.903
S.T.V.S., 10 chemin Saint Gobin, 69 190 Saint fons, 04.72.89.06.89
S.T.V.S. (point d'accueil), 143 av Maréchal de Saxe, Entrée: 54 rue Villeroy, 69003 Lyon 04.78.62.07.05
TECH SERVICE, 15 rue du château de ribaute, ZA ribaute 2, 31130 Quint Fonsegrives, 05.62.57.63.90
TIMO VIDEO, 131 chemin des bassins, Zone Europarc - Hameau D, 94000 Creteil, 01.43.39.08.18
U.N.T.D., 1 rue des Lourdines, 76000 Rouen, 02.35.72.28.04

ITALIA - <http://www.sharp.it>

Nel caso si verificassero problemi alla vostra apparecchiatura potrete rivolgervi presso un nostro centro di assistenza autorizzato sharp

ABRUZZO: CTR di de Berardinis vincenzo, Via Giuseppe Cacchi L'Aquila, 0862-315407 / **CTR di de Berardinis vincenzo**, Via P. Gobetti Avezzano L'Aquila, 0863-412131 / **Marinangeli Fabrizio**, Via Rocco Carabba L'Aquila, 0862-310279 / **Marinangeli Fabrizio**, Via F.lli Rosselli Avezzano L'Aquila, 0863-25207 / **Elettrovideo snc**, Via Tiburina Pescara, 085-52020 / **Cat di Bellone**, Via Dell' Aereoporto Teramo, 0861-415745

BASILICATA: SUONO E IMMAGINE di Conti Massimo, Via E. Maiorana Matera, 0835-389310

CALABRIA: Battaglia Saverio, Via C. Colombo Catanzaro Lido, 0961-33824 / **S.A.T.E. di Dodaro**, Via degli Stadi Cosenza, 0984-482337 / **SE.RI.EL.CO.**, Via delle Medaglie d'Oro Cosenza, 0984-33152 / **Eurotrading dei F.lli Aiello G. & D. snc**, Via Torino Crotone, 0962-20889 / **Assistenza Tecnica Cozzupoli & Crupi snc**, Via R. Campi primo tronco 103 Reggio Calabria, 0965-24022 / **Ater snc**, Via Naz. Pentimele 159/a-b Reggio Calabria, 096547051 / **Ciano Giuseppe**, Via Seconda Traversa Toscanini Taurianova, 0966-643483 / **Audio Video snc**, Via A. De Gasperi 4/e Vibo Valentia, 0963-45571 o 45572

CAMPANIA: Elettronica D' Argenio, Via Nazionale Torrette Nercogliano Avellino, 0825-681590 / **D.R.F. di Rubbo**, Via L. Piccinato Benevento, 0824-62416 / **Audio Service**, Via Cattaneo 4/6 Caserta, 0823-329099 / **Congestri' Ignazio**, Via Giordano Bruno Maddaloni Caserta, 0823-437704 / **Elettronica Service snc di Starace Aniello e C.**, Viale Europa Castellamare di Stabia Napoli,

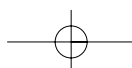

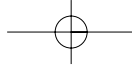

• ADDRESSES D'ENTRETIEN • ONDERHOUDSADRESSEN • DIRECCIONES DE SERVICIO • INDIRIZZI DI SERVIZIO •

081-8728280 / **Errediesse Service**, Via P. Mascagni Napoli, 081-5794825 / **SATEP**, Via Nazionale delle Puglie 176 Casoria Napoli, 081-7590706 / **Video Elettronica 2 di Nasti**, Via Antonino Pio Napoli, 081-7676300 / **M.C. Elettronica snc di Milito M. e Della Sala**, Via dei Mille Salerno, 089-330591 / **Netti Gianfrano**, Via Magna Grecia Capaccio Scalo Salerno, 0882-730071

EMILIA ROMAGNA: MA.PI. snc, Via T. Azzolini Bologna, 051-6414115 / **VIDEO 2000 SRL**, Via dell'Industria Bologna, 051-531581/624060 / **Assistenza Electron di Fogli**, Via F.lli Aventi Ferrara, 0532-903250 / **Stema snc**, Viale Bologna Forlì, 0543-704475 / **Audio Video Center**, Via Vandelli 23 Modena, 059-235219 / **REAT srl**, via Giardini Nord 8 Formigine Modena, 059-557168 / **Ecoservice Srl**, Via Buffolara 68A Parma, 0521-987402 / **Parmaservice sas**, Via Benedetta Parma, 0521-271666 / **Riparazioni Elettriche Ravenna**, Via Reale Camerlona Ravenna, 0544-521500 / **Technolab snc**, Via Romea Ravenna, 0544-64008 / **RTE RADIO TV ELETTRONICA di I. Catellani & C.**, Via Premuda Reggio Emilia, 0522-381277 / **Masini Service**, Via Mediterraneo Bellaria Rimini, 0541-347714 / **Novatecnica snc**, Via Giovenale Rimini, 0541-736361 / **Nuova Tecnocoop**, Via Armellini Bellariva di Rimini, 0541-370812

FRIULI VENEZIA GIULIA: D.R.M. di de Monte Ignio, P.ZA Montesanto S. Lorenzo Isontino Gorizia, 0481-808858 / **AVR di Dri sas**, Via Colonna 20/8 Pordenone, 0434-27669 / **Officina Elettom. di Starace Elio**, Via Caprin Trieste, 040-773718

LAZIO: A.P. Rip. Arduini Piero, Via Licinio Refice 192 Frosinone, 0775-291267 / **Palmieri Francesco**, Via S. Polledrara Frosinone, 0775-291485 / **Elettronica 81**, Via Ezio Latina, 0773-694608 / **Italreg di Albano**, Parco Belvedere Conca 74 Gaeta, 0771-470851 / **CTS centro tecnico specializzato**, Via Rialto Roma, 06-39729748 / **Panaservice SRL**, Via Barbana 35 Roma, 06-5409766 / **Video Service sas di G. Calabrese & C. (VT)**, Str. Teverina Viterbo, 0761-251557

LIGURIA: G.A.T.E. snc, Passo P. Carrega Genova, 010-8361543 / **STAE SNC**, Corso A. Gastaldi Genova, 010-5299269 / **Cat snc di Ginulla O. & Rebuffo M.**, Via L. Giordano Imperia, 0183-710920 / **Michelis Sandro**, Via Giannetti Imperia, 0183-275891 / **RIEN snc**, Via Valle La Spezia, 0187-21925 / **Tognetti service**, Via Lunigiana La Spezia, 0187-507656 / **Teleservice snc**, Via Ponchelli 27R Savona, 019-810058

LOMBARDIA: Video Service snc, Via Locatelli Seriate Bergamo, 035-296883 / **Baccinelli Marzio & C. snc**, Via Branze Brescia, 030-2006411 / **Eurotecnica di Ronchi**, Via Milano Brescia, 030-317673 / **S.T.A.R.T. Video Hi-Fi**, Via Orti Romani Cremona, 0372-38731 / **Sae di Oneda M. snc**, Via Chinaglia Cremona, 0372-460314 / **Tecnovideo snc**, P.zza De Gasperi Mantova, 0376-321554 / **A.E. snc**, via Acerbi 28 Milano, 02-66220906 / **AT Electronics**, Piazza Cartagine 4 Milano, 02-58019146 / **Test TV snc**, Via Altamura Milano, 02-4035408 - 406441 / **Morini Daniele**, Via Maiocchi Voghera Pavia, 0383-368740 / **Crel snc**, Via Carducci Sondrio, 0342-216538 / **Elettronica Cappi**, Via Gorizia Sondrio, 0342-210459 / **Salvadori Claudio**, Via del Bosco Busto Arsizio Varese, 0331-329973 / **Salvadori Claudio Succursale**, Via Merano Varese, 0332-333501 / **Teletecnica 2000**, Via Torino Gallarate Varese, 0331-775519

MARCHE: Digitecnica di Moroni R: & c snc, Via Zuccarini Candia, 071-2866067 / **Marconi Lanfranco**, Via Monte Bianco Porto d'Ascoli, 0735-659230 / **Pluritecnica di Campitelli A. Nespeca M. snc**, Via Gradara Ascoli Piceno, 0736-342635 / **SAT Radio Tv snc**, Via D. Rossi Macerata, 0733-231304 / **C.A.T. snc**, Via A. Cecchi Pesaro, 0721-25608 / **SAT 2000 snc di Sparamonti P. e C.**, Via dello Stadio. 16 Terni, 0744-424133

PIEMONTE: Siragusa & Roagna, C.so Matteotti Asti, 0141-531131 / **Arte e Tecnica snc**, Via Falletti 22 Biella, 015-8496250 / **Alpilab di Giordano**, Corso Giovanni XXIII 11 Cuneo, 0171-690384 / **Videotext di Oberto Stefano**, P.za Trento e Trieste Canale Cuneo, 0173-95878 / **Guida di Guida Alessio**, Via Roggiolo Trecate Novara, 0321-71608 / **El.te di Antonello Adriano**, Via Ugo Foscolo Torino, 011-6503786 / **REAT di Frisina Rita**, Corso Unione Sovietica 584 Torino, 011-3979817 / **Elektro di Fiore Francesco**, Via Tripoli Vercelli, 0161-250071

PUGLIA: Marinelli Benedetto, Via dei Salici Barletta, 0883-514054 / **SAT sas di Partipilo**, Via Borsellino e Falcone 17 bis Bari, 080-5022999 / **Astrotec p.s.c.a.r.l.**, Viale Ofanto Foggia, 0881-685013 / **Stear snc**, Via E. Perrone Foggia, 0881-778483 / **Arnesano Faustino**, Via M. Moscardino 10 Lecce, 0832-318277 / **Microkey srl**, Via Giammatteo Lecce, 0832-399398 / **Microkey srl**, Via de Giuseppe Maglie Lecce, 0836-424813 / **Santoro Attilio**, Via Marche 24 Taranto, 099-335884

SARDEGNA: AS.TEC. Elettronica, Via Riva Villasanta 227 Cagliari, 070-524153 / **Floris Sergio**, Via Mazzini Gonnese, 0781-45436 / **G.S. Elettronica di Porcu Giuseppe M.**, Via della Resistenza Nuoro, 0784-203084 / **Co.ri.fr.el. 2**, Via del Castagno Settore "D" Olbia, 0789-562104 / **Videoelettronica snc**, Via Torino Sassari, 079-276616

SICILIA: Service Russo di Russo Alfonso, Via Dei Giovani Agrigento, 0922-610788 / **Video Service di De Francisci Paolo**, Via P.Nenni Agrigento, 0922-595881 / **Vullo Michele**, Via Gorizia Caltanissetta, 0934-551367 / **A.V.S. Elettronica**, Via Sassari 2/c Catania, 095-446696 / **Cuppari Electronics**, via S. Agostino 15 Messina, 090-672064 / **Cuppari Electronics Succursale**, Via Libertà Capo d' Orlando Messina, 0941-911785 / **Tecnica Sud snc**, Viale Regina Elena Messina, 090-40037 / **Alamia Service Piccola Cooperativa**, C.so Pisani 310/312 Palermo, 091-6570502 / **Di Fonzo F. & Figli snc**, Via Ruggero Loria Palermo, 091-363578 / **Elettronica di Di Tullio Maria**, Via Carlentini Siracusa, 0931-758602 / **Latino Impianti**, Via Eloro Rosolini Siracusa, 0931-857099 / **Tecnico Siracusana**, Via Novelli Siracusa, 0931-39440 / **Arte TV sas**, Via G. Centorbi 17 Mazara del Vallo Trapani, 0923-908160 / **Euroservice 2000**, via degli Atleti 61/c Marsala Trapani, 0923-956475

TOSCANA: Bardazzi Paolo, Via Forlanini 8DR Firenze, 055-4376776 / **Cate di Lepri Guido e C. snc**, Via Segantini Empoli, 0571-80652 / **Centi Franco**, Via Dosio 83 Firenze, 055-710388 / **Laboratorio Tv Arrighi**, Via F.lli Cervi P.A. Elsa Empoli, 0571-931327 / **M2 Elettronica**, Via Danimarca Grosseto, 0564-454571 / **NA.TO.MA. snc**, Via del sabotino 13 Grosseto, 0564-456229 / **Cate di Lepri Guido e C. snc**, C.so Matteotti Cecina, 0586-635071 / **A.T.E.S.**, Via Torino 3/a Livorno, 0586-859566 / **Laboratorio Riparazioni Falchi**, Via A. Garibaldi Piombino, 0565-49400 / **Teleservice di D'Amicis E. & V. snc**, Via P. Pisana Livorno, 0586-400564 / **E.T.S. di Napolitano Biagio**, Via Bientina Altopascio, 0583-269196 / **Elettronica RNP**, Via Romana Lucca, 0583-956225 o 957565 / **MGM Service snc di Martinelli**, Via Paolinelli Capannori, 0583-30382 / **DBS ELETTRONICA di Aldovardi S. & C. snc**, Via Simon musico Massa, 0585-489893 / **SAEC**, Via degli Artigiani Massa, 0585-251724 / **Belcari Enrico**, Via J. Gagarin Pisa, 0587-420273 / **E.T.S. di Napolitano Biagio**, Via Lucchese Montecatini Terme, 0572-767430 / **Cate di Lepri Guido e C. snc**, Via Fiorentina Prato, 0574-632652 / **Teleservice di Benvenuti Stefano**, Via E.Fermi 9/13 Prato, 0574-580840 / **PA.RI.EL.S.di Barletti Mirella**, Via B.Tolomei 9 Siena, 0577.51159

TRENTINO ALTO ADIGE: Dal Pozzo Enzo, Via Barletta Bolzano, 0471-913290 / **Tecnoservice snc**, Via San Vigilio Bolzano, 0471-289062 / **Melone Michele**, Via Zara Trento, 0461-235166 / **Sighel Mauro**, Via A. Volta Trento, 0461-935919

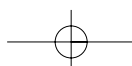



• ADDRESSES D'ENTRETIEN • ONDERHOUDSADRESSEN • DIRECCIONES DE SERVICIO • INDIRIZZI DI SERVIZIO •

UMBRIA: **Baldassarri G. & G. snc**, Via A. Manna S. Andrea delle Fratte, 075-5270921 / **Tecnoconsult Elettronica**, Via Madonna Alta Perugia, 075-5003089 / **Quondam**, Via del Rivo Terni, 0744-301512

VALLE D'AOSTA: **Cat di D'Isanto**, C.so Ivrea Aosta, 0165-364056

VENETO: **D.D. Assistenza Tecnica snc**, Via Mondin Belluno, 0437-30240 / **Pierezza Carlo**, Via Barroccio dal Borgo Padova, 049-681592 / **L'Elettronica più snc**, Via Gaspare Campo Rovigo, 0425-33221 / **Assistenza Elettronica Campi**, Via E. Reginato Treviso, 0422-436245 / **Franchino gianfranco**, Via Zermanese 6B Treviso, 0422-321054 / **Video Tv1732**, Via San Marco Sottomarina, 041-5541675 / **Vignando Luigino**, Via dell' Industria Gruario, 0421-74472 / **Zaffalon Urbano**, via Santa Croce 2040 Venezia, 041-2750670 / **Global Service Impianti di Cerpelloni & C.**, p.zza Plebiscito 9A Avesa, 045-8342935 / **Video Service**, Via Vitruvio Verona, 045-566299 / **DL service di dal Lago Lorenzo**, Via Giaretta 33 Vicenza, 0444-566662 / **Speedy service**, V.le Europa 42/b Thiene, 0445.368235

ESPAÑA - <http://www.sharp.es>

En caso de una reclamación con vuestra SHARP Microwave, preguntan por favor la casa dónde han comprado su máquina o infórmense en una de las SHARP Service casas siguientes.

ALAVA: **Merino Nicolas Jose A.**, Av Judizmendi 24, Vitoria-Gasteiz, 945/ 25.18.92

ALBACETE: **Juman**, Cl Ejercito 1, Albacete, 967/ 22.40.78 / **Parreño**, Cl Santiago Rusiñol 50, Albacete, 967/ 22.62.49

ALICANTE: **A.E. De Consumo**, Cl Peru 42, Alcoy, 96/ 552.32.35 / **David Torregrosa Jorda**, Cl Terrassa 6, Alcoy, 965/ 33.43.06 / **Eurosaf, S.L.**, Cl Montero Rios 33, Alicante, 96/ 525.80.40 / **Angel Avellan Puig**, Cl Poeta Quintana 13, Alicante, 965/ 21.32.55 / **Joaquin Saez Servicios**, Cl Escorpion 6-8, Alicante, 96/ 528.73.33 / **Video Electronica Noguera**, Cl Castellon 17, Altea, 965/ 84.41.58 / **Tele-Color**, Cl Del Vent 9, Benidorm, 96/ 585.24.60 / **Joaquin A. Lon Jaen**, Cl Patricio Ferrandiz 66, Denia, 96/ 578.67.50 / **Trinitario Gea**, Cl Jaime Pomares Javaloyes 47, Elche, 96/ 545.56.25 / **Unisaf**, Cl Duque De Tamames 9, Orihuela, 96/ 674.11.94 / **Jose A. Patiño Villena**, Cr De Bigastro 1, Orihuela, 96/ 571.74.29 / **Electroservicios Plaza**, Pz Santiago 5, Orihuela, 96/ 828.45.67 / **E.Electrosax**, Cl Rio Turia 1, Sax, 96/ 547.42.32 / **Electronica Santa Pola**, Cl Orihuela 43, Torrevieja, 96/ 571.25.58 / **A.T. Tv. Video**, Av De La Constitucion 185 D, Villena, 965/ 80.02.31

ALMERIA: **Televideo**, Cl Velazquez 7 Local-A, Adra, 950/ 40.18.63 / **Servirap**, Cl Angel Ochotonera 11, Almeria, 950/ 27.40.67 / **Sonivitel S.L.**, Cl Poeta Paco Aquino 51, Almeria, 950/ 22.97.55 / **Servicio Tecnico Ponce**, Plg Ps Maritimo E- Europa 1, Garrucha, 950/ 13.28.37

ASTURIAS: **Asturservice**, Cl Sanchez Calvo 6 Bjos., Aviles, 98/ 556.83.87 / **S.A.T. Juan-Manuel**, Cl Uria 60, Cangas De Narcea, 98/ 581.22.48 / **Manuel Alea Villa**, Cl Llano Morgolles S/N, Cangas De Onis, 98/ 592.26.40 / **Electronica Edimar, S.A.**, Cl Cangas De Onis 4, Gijon, 98/ 535.34.51 / **Astusetel S.L.**, Cl Cea Bermudez 9, Gijon, 98/ 539.10.11 / **Juan Morillon Del Corro**, Av De Gijon 19, La Felguera/Langreo, 98/ 567.40.24 / **Santiago Valderrey**, Cl Dr. Venancio Mtez. 7, Navia, 98/ 563.18.61 / **Alvarez Olivar Casilda**, Cl San Jose 12, Oviedo, 98/ 522.37.39 / **G.A.M.I.F.E.L.**, Cl Ricardo Montes 6, Oviedo, 98/ 528.43.60

AVILA: **Daniel Serrano Labrado**, Cl Jose Gochicoa 16, Arenas De S.Pedro, 920/ 37.15.16 / **Electronica Gredos**, Cl Eduardo Marquina 24, Avila, 920/ 22.48.39 / **Reparaciones San Segundo**, Cl Soria 6, Avila, 920/ 22.33.21

BADAJOS: **Indalecio Amaya Sanchez**, Cl Carreras 11, Almendralejo, 924/ 66.47.01 / **Electronica Bote**, Pz Portugal 2, Badajoz, 924/ 22.17.40 / **Patricio Electronica**, Cl Reyes Huertas 7, Merida, 924/ 33.04.13 / **Electronica Centeno S.L.**, Av Del Zafra 1, Puebla Sancho Perez, 924/ 57.53.08 / **C.E. Vilanovense C.B.**, Cl Camino Magacela 4 Local-5, Villanueva Serena, 924/ 84.59.92

BALEARES (MENORCA): **Insaf, Cb**, Cl Pintor Calbo 30, Mahon, 971/ 36.53.18

BALEARES (IBIZA): **Reparaciones Ortega**, Cl Via Punica 33, Ibiza, 971/ 39.01.55

BALEARES (MALLORCA): **Instalaciones Maes, S.L.**, Cl Son Nadal 63, Palma De Mallorca, 971/ 27.49.47

BARCELONA: **Servinters, S.C.C.L.**, Pz Casagemes 20, Badalona, 93/ 389.44.60 / **Fermo**, Av Morera 5, Badalona, 93/ 465.22.00 / **Videocolor**, Cl Villarroel 44, Barcelona, 93/ 454.99.08 / **4 En 1 Reparaciones**, Cl Taquigrafo Marti 19, Barcelona, 93/ 430.97.26 / **La Clinica Del Electrodo**, Cl Balmes 160, Barcelona, 93/ 236.44.11 / **Pulgar I Edo S.L.**, Cl Castillejos 333, Barcelona, 93/ 436.44.11 / **Domofica**, Av Diagonal 296, Barcelona, 93/ 408.66.22 / **Estarlich**, Cl Industria 131, Calella, 93/ 766.22.33 / **Joaquin Casajoana Pages**, Cl Major 19 (Tienda), Castelldefels, 93/ 664.43.60 / **Electronica Mateos**, Cr De Caldas (Bajos) 76, Granollers, 93/ 849.28.77 / **Teelco**, Av Balmes 90, Igualada, 93/ 805.11.90 / **Elde**, Cl Bruch 55, Manresa, 93/ 872.85.42 / **Totvisio Electronica S.L.**, Pj Ferrer 14, Manresa, 93/ 873.88.81 / **Ramon Villaret De Gea**, Cl Moli De Vent 21, Mataro, 93/ 798.02.48 / **Estarlich**, Cl Auquebisbe Creus 12, Mataro, 93/ 790.22.89 / **Salja & Mat**, Cl La Raseta 15 L3, Molins De Rey, 93/ 668.13.61 / **Ce.Va.Sat**, Ps Rubio I Ors 105, Sabadell, 93/ 710.76.13 / **Servei Tecnico Ferrer**, Cl Sarda 37, Sabadell, 93/ 710.51.38 / **Fix Servicio Tecnico**, Cl Valles 88, Sant Cugat Valles, 93/ 675.59.02 / **Ce. Va. Sat, S.C.**, Cr Matadepera 87, Terrassa, 93/ 785.51.11 / **Laurea S.A.T.**, Cl Guillerries Bis 20, Vic, 93/ 889.02.48 / **Fred Vilafranca**, Cl Progres 42, Vilafranca Del Penedes, 93/ 890.48.52 / **Top Electronica**, Cl Misser Rufet 4 Bjos, Vilafranca Penedes, 93/ 890.35.91

BILBAO: **Telnor**, Pz Juanene 5 Tras., Erandio, 94/ 417.04.97

BURGOS: **Servitec Burgos S.L.**, Cl Lavaderos 7-9, Burgos, 947/ 22.41.68 / **Electronica Mas**, Cl Alfonso Vi 6, Miranda De Ebro, 947/ 31.49.94

CACERES: **Ruiz Garcia Jose**, Cl Ecuador 5-B, Caceres, 927/ 22.48.86 / **Arsenio Sanchez, C.B.**, Cl Tornavacas 9, Plasencia, 927/ 41.11.21 / **Radio Sanchez C.B.**, Av De Miajadas S/N, Trujillo, 927/ 32.06.88

CADIZ: **Jose Borja Y Jose Arana**, Cl San Antonio 31, Algeciras, 956/ 66.60.53 / **Galan Sat S.L.**, Cl Cruz Roja Española 11, Cadiz, 956/ 20.14.17 / **Fermafrio**, Pz España 1, Cadiz, 956/ 28.10.82 / **Novomam-Sat**, Pol. Urbisur, Jorge Juan 4, Chiclana De La Frontera, 956/ 40.12.09 / **Electronica Y Climatizacion Jeda**, Cl Divina Pastora E-1 L-4,5,6, Jerez La Frontera, 956/ 33.64.99 / **Servitel**, Cl Porvenir 11 Local, Jerez La Frontera, 956/ 33.76.55 / **Electrogan**, Cl Pagador 31, Pto. Sta. Maria, 956/ 87.07.05 / **Galan Sat S.L.**, Cl Factoria Matagorda 52, Puerto Real, 956/ 83.35.35 / **Rota Electrosur**, Cl Malaga 11, Rota, 956/ 81.59.60

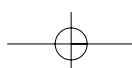

• ADDRESSES D'ENTRETIEN • ONDERHOUDSADRESSEN • DIRECCIONES DE SERVICIO • INDIRIZZI DI SERVIZIO •

CANTABRIA: **Electronica Seyma**, Cl Camilo Alonso Vega 48, Santander, 942/ 32.50.60

CASTELLON: **Electronica Maestrat**, Ps Febrer Soriano 65, Benicarlo, 964/ 46.03.08 / **Asiste, S.L.**, Av De Valencia Nave 19, Castellon, 964/ 21.57.69 / **Vensat Reparaciones**, Cl Vinaros 24, Castellon, 964/ 20.57.12

CEUTA: **Pedro A. Carcaño Lopez**, Cl Urano (Local 7), Ceuta, 956/ 50.43.99

CIUDAD REAL: **Tele-Nueva**, Cl Campo 56, Tomelloso, 926/ 50.59.96 / **Electronica Arellano**, Cl Lorenzo Rivas 14, Alcazar De San Juan, 926/ 54.78.95 / **Lara Technitel**, Cl De La Jara 1, Ciudad Real, 926/ 21.17.87 / **Satelec**, Cl Libertad 13, Ciudad Real, 926/ 22.01.55 / **Climatec**, Cl Pozo 3 4º A, Puertollano, 652/ 79.03.60 / **Angel Rodero Bellow**, Cl Asturias 26, Tomelloso, 926/ 51.52.76 / **Electrodiaz S.L.**, Cl Buensuceso 10, Valdepeñas, 926/ 32.23.24

CORDOBA: **Electronica Sales**, Cl Andalucia 11, Aguilar Frontera, 957/ 66.09.04 / **Dueñas CalAs Teodoro**, Cl Hermano Juan Fdez 15, Cordoba, 957/ 26.35.06 / **Cayro**, Cl Hermano Juan Fdez. 15, Cordoba, 957/ 26.35.06 / **Microm Electronica**, Av Aeropuerto 2, Cordoba, 957/ 23.02.22 / **Antonio Gonzalez Esquinas**, Cl Gral Primo Rivera 61, Peñarroya, 957/ 57.10.50 / **Serpriego S.L.**, Cl San Luis 4 Bjo. Izda., Priego De Cordoba, 957/ 54.15.11

GIRONA: **Reparaciones Pilsa S.C.**, Cl J. Pascual I Prats 8, Girona, 972/ 20.66.96 / **Feliu Canalias**, Cl Major 26, Campdevanor, 972/ 73.01.72 / **Riera Daviu**, Cl Torras Y Bages 19, Figueres, 972/ 50.32.64 / **Satel**, Ps De Barcelona 12, Olot, 972/ 26.55.19 / **New Meresa**, Cl Surera Bertran 23, Palafrugell, 972/ 30.44.54 / **Arbe Servei**, Av Pompeu Fabra 134, Palafrugell, 696/ 20.14.08

GRANADA: **Servicosta**, Pz Dr. Alvarez Riosol 1, Almuñecar, 958/ 63.11.43 / **Digimat Electronica**, Av Jose De Mora 16, Baza, 958/ 70.04.52 / **Electronica Wenceslao**, Cl Fontiveros 42, Granada, 958/ 81.16.16 / **Fermasa**, Cl Azorin 7, Granada, 958/ 25.64.77 / **Servigon**, Cl Hospital De La Virgen 22, Granada, 958/ 20.52.81 / **Electronica Vargun**, C/.Mozart L2 Ed.Granate, Granada, 958/ 26.06.01

GUADALAJARA: **Tecnicas Marvi S.L.**, Pz Capitan Boixareu 51, Guadalajara, 949/ 23.27.63 **Ferreteria Toledano**, Cl Ejercito 17 A, Guadalajara, 949/ 23.02.61

GUIPUZCOA: **Teknibat Electronica**, Cl Zezenbide 4, Eibar, 943/ 70.24.37 / **Estudios 3, C.B.**, Pz De Los Estudios 3, San Sebastian, 943/ 45.37.97 / **Reparaciones Urruti S.L.**, Ps Aintzieta 32, San Sebastian, 943/ 45.84.10

HUELVA: **Abril Sanchez Valentin**, Cl Cadiz 2, Cala, 959/ 10.60.41 / **Telejara**, Pol. Polirrosa ClA Nave-27, Huelva, 959/ 22.60.74 / **Telesonid Huelva, S.C.A.**, Cl Fco.Vazquez Limon 4, Huelva, 959/ 24.38.60 / **Airsext Huelva**, Ps De La Glorieta 6, Huelva, 959/ 22.88.13 / **Electro Sur**, Cl Alonso De Ercilla 23, Huelva, 959/ 29.06.15

JAEN: **Electronica Gonzalez**, Corredera San Bartolome 11, Andujar, 953/ 50.33.82 / **Electro Himega, S.A.**, Cl Adarves Bajos 4-C, Jaen, 953/ 24.22.56 / **Uniservic Electronica**, Cl Goya 1 Bjos, Ubeda, 953/ 75.14.19

LA CORUÑA: **Ramsat**, Av Finisterre 117-B, Cee, 981/ 74.74.61 / **Zener Electronica**, Cl Ronda De Monte Alto 15, La Coruña, 981/ 22.07.00 / **S.T. Mendez**, Cl Gil Vicente 13, La Coruña, 981/ 27.52.52 / **Bandin Audio**, Cl Rua Arcos Moldes 2 B-3, Rianxo, 981/ 86.60.23 / **Victor Perez Quintela**, Cl Entrerios 35, Santiago De Compostela, 981/ 58.43.92

LA RIOJA: **Top Service**, Cl Achutegui De Blas 17, Calahorra, 941/ 13.50.35 / **Electronica Musand**, Cl Rey Pastor 60-62, Logroño, 941/ 22.84.52 / **Aguado Sat**, Cl Velez De Guevara 26 Bajo, Logroño, 941/ 25.25.53

LEON: **Prosat**, Pz Doce Martires 5, Leon, 987/ 20.34.10 / **Tecnyser Electro**, Cl Relojero Losada 25, Leon, 987/ 22.77.87 / **Asist. Tecnica Marcos**, Cl Conde De Toreno 5, Leon, 987/ 20.01.01 / **Domespa Bierzo**, Cl Batalla De Lepanto 8, Ponferrada, 987/ 41.14.29

LERIDA: **Satef**, Cl Sant Pelegri 54, Tarrega, 973/ 50.08.48 / **Electronica Guirao**, Cl Sant Pere Claver 16 B-2, Tarrega, 973/ 50.02.34 / **Jordi Duro Fort**, Cl Industria 6 3º 3º, Tremp, 973/ 65.25.15

LLEIDA: **Ielsa Electronica**, Cl Tarragona 15, Lleida, 973/ 24.71.27 / **Cristel**, Cl Vallcalent 32, Lleida, 973/ 27.08.26

LUGO: **Televexo S.L.**, Cl Nosa Sra. Do Carmen 82, Burela, 982/58.18.57 / **Servicio Tecnico Pasfer**, Av Arcadio Pardiñas 77, Burela, 696/17.86.458 / **Electronica Penelo**, Cl Serra Gañidoira 63, Lugo, 982/ 21.47.43 / **Electronica Fouces**, Cl Benito Vicetto 34, Monforte De Lemos, 982/ 40.24.38

MADRID: **Video Service Electronic**, Cl Era Honda 9, Alcala De Henares, 91/ 880.27.87 / **Variosat, S.L.**, Cl Isla De Corcega 24, Alcobendas, 91/ 662.04.68 / **Ugenasa**, Cl La Canaleja 4, Alcorcon, 91/ 611.52.51 / **Electronica Barajas**, Pz Del Jubilado 8, Barajas, 91/ 305.48.90 / **Tec-Norte**, Cl Santiago Apostol 5, Collado Villalba, 91/851.63.47 / **Garman C.B.**, Cl Carlos Sole 38 Local, Madrid, 91/380.33.49 / **Electronica Garman, C.B.**, Cl Mandarina 15, Madrid, 91/ 368.01.79 / **Electronica Ansar**, Cl Tomasa Ruiz 4, Madrid, 91/ 460.47.45 / **Elbeservi, S.A.**, Cl Dr.R. Castroviejo 19, Madrid, 91/ 386.27.11 / **Cromadelta**, Cl Alfonso XII 31, Mostoles, 91/ 664.16.41

MALAGA: **Servisuel, Edif. La Union**, Cm De Las Cañadas Lc 2, Fuengirola, 952/ 46.90.28 / **Climaire Plus**, Cl Guaro 4, Malaga, 95/ 234.50.36 / **Electronica Garcia Campoy**, Av Velazquez 5, Malaga, 952/ 32.00.77 / **Electronica Bg**, Cl Andalucia 2, San Pedro De Alcantara, 952/ 78.50.09 / **Video Taller, S.C.**, Edif. La Noria B Bjos-5, Torre Del Mar, 952/ 54.23.95

MELILLA: **Sonitev**, Cl Ejercito Español 3, Melilla, 952/ 68.30.80 / **MURCIA:** **Reg., C.B.**, Cl Ramon Y Cajal 27, Cartagena, 968/ 51.00.06 / **Caro Porlan Raimundo**, Cl Jose Mouliaa 45, Lorca, 968/ 46.18.11 / **J. Luis Haro Calvo**, Cl La Seda 8 Edif. Las Terrazas, Lorca, 968/ 47.18.79 / **Electroservicios Seba,C.B.**, Cl Isaac Albeniz 4 Bjos, Murcia, 968/ 29.85.93 / **Visatel**, Cl Torre Alvarez S/N, Murcia, 968/24.16.47 / **Electro Servicios Plaza**, Cl Gomez Cortina 10, Murcia, 968/ 28.45.67 / **Angel Lopez Alcaraz**, Cl Sierra Del Espartal 6 (Edif. Ana), Murcia, 968/ 29.39.10 / **Rafael Gomez Yelo**, Ps Corbera 17, Murcia, 968/ 26.14.67

NAVARRA: **A. T. Pamplona**, Cl Julian Gayarre 1, Pamplona, 948/ 24.19.50 / **Unitec**, Cl Fuente Canonigos 5, Tudela, 948/ 82.74.34

ORENSE: **Fernandez Gonzalez Jose**, Av Buenos Aires 75 Bjos, Orense, 988/ 23.48.53 / **Antonio Rodriguez Alvarez**, Cl Cabeza De Manzaneda 7, Orense, 988/ 22.40.98

PALENCIA: **Electronica Javier**, Av Castilla 77, Palencia, 979/ 75.03.74 / **Multiservicio Palencia**, Cl Cardenal Cisneros 20, Palencia, 979/ 74.53.80

• ADDRESSES D'ENTRETIEN • ONDERHOUDSADRESSEN • DIRECCIONES DE SERVICIO • INDIRIZZI DI SERVIZIO •

PAMPLONA: **Electro Reparaciones 2000**, Cl Monasterio Fitero 26, Pamplona, 948/ 26.79.12

PONTEVEDRA: **Imason**, Cl Loureiro Crespo 43, Pontevedra, 986/ 84.16.36 / **Central De Servicios**, Cl Asturias (Bajo) 10, Vigo, 986/ 37.47.45 / **Sial-Alvimo S.L.**, C/ C.Torrecedeira 92 Bjos, Vigo, 986/ 29.93.01 / **Electronica Cambados**, Cl Camilo Jose Cela 13, Vilagarcia Arousa, 986/ 50.83.27

SALAMANCA: **Almat Electronica**, Cl Galileo 21, Salamanca, 923/ 22.45.08 / **J. Daniel Martinez**, Cl Abraham Lacut 11-15, Salamanca, 923/ 19.16.10

SEGOVIA: **Guijo S.T.**, Cl Teofilo Ayuso 2 Local, Segovia, 921/ 42.94.18

SEVILLA: **Electro 93 S.L.**, Cl Melliza 1, Dos Hermanas, 95/ 472.37.16 / **Electronica Bersabe**, Pasaje Merinos 62 A, Ecija, 95/ 483.33.93 / **Electronica Guillen**, Cl La Cilla 70, Osuna, 954/ 81.12.96 / **Electronica Triana**, Cl Evangelista 69-71 L-25, Sevilla, 95/ 433.83.03 / **Telepal**, Cl Julio Verne 49, Sevilla, 95/ 464.95.80 / **Auvitel, S.L.**, Cl Virgen De Africa 20, Sevilla, 95/ 427.57.07 / **Luis Rivas Caldas**, Cl Febo 16, Sevilla, 95/ 451.73.55 / **Intersat Sevilla**, Cl Beethoven 5, Sevilla, 95/ 443.02.26 / **Frilar**, Pol. Indust. Navisa C/A 47, Sevilla, 95/ 492.14.44 / **Televideo Nervion**, Cl Juan Curiel 22, Sevilla, 95/ 458.10.66

SORIA: **Teco**, Cl Antolin De Soria 10, Soria, 975/ 22.61.25

TARRAGONA: **Selecco S.L.**, Cl Calderon De La Barca 11, Amposta, 977/ 70.00.12 / **Mañe Grifolls**, Cl Jesus 21, Calafell, 977/ 69.04.39 / **Tecno Serveis Mora**, Cl Pau Picasso 1, Mora D'ebre, 977/ 40.08.83 / **Euro Tecnicos Electronica**, Cl Lepanto 16-18, Reus, 977/ 32.24.89 / **Martorell Altes Francisco**, Cl Roseta Mauri 10, Reus, 977/ 75.32.41 / **Electronica Loguard**, Cl Vapor Vell 17, Reus, 977/ 32.38.04 / **Electronica S. Torres**, Cl Ernest Vilches 4-B L-2, Tarragona, 977/ 21.21.48 / **Sertecs, S.C.**, Cl Caputxins (Bajos) 22, Tarragona, 977/ 22.18.51 / **Electro Servei C.B.**, Ps Moreira 10, Tortosa, 977/ 51.04.42

TERUEL: **Electronica Alcañiz S.L.**, Cl Carmen 21, Alcañiz, 979/ 87.07.94 / **Teleservicio Bajo Aragon**, Cl Romualdo Soler 4, Alcañiz, 978/ 87.08.10 / **Alejandro Hernandez**, Rb San Julian 59, Teruel, 978/ 60.85.51

TOLEDO: **Electro Anaya**, Cl Vertedera Alta 14, Consuegra, 925/ 48.09.81 / **Electronica Rivas**, Cl Barrio San Juan 1, Talavera La Reina, 925/ 80.55.46 / **Electronica Fe-Car, S.L.**, Av Santa Barbara 30, Toledo, 925/ 21.21.45 / **Electronica Jopal S.L.**, Av Santa Barbara S/N, Toledo, 925/ 25.04.42

VALENCIA: **Envisa Electronic, S.L.**, Cl General Espartero 9, Alzira, 96/ 241.24.87 / **Tecno Hogar**, Cl Dos De Mayo 41, Gandia, 96/ 286.53.35 / **Electro Servis**, Cl Grupo San Valero 4-6, Sueca, 96/ 170.38.50 / **Frifonta**, Cl Actor Llorens 3, Valencia, 96/ 369.92.66 / **Servicios Electronicos**, Cl Doctor Oloriz 3, Valencia, 96/ 340.20.34 / **Antonio Monleon, S.L.**, Av De La Plata 91, Valencia, 96/ 334.55.87

VALLADOLID: **Electronica Vitelson**, Pz Del Mercado 9, Medina Del Campo, 983/ 80.43.56 / **Teleservicios**, Cl Esgueva 6, Valladolid, 983/ 30.92.61 / **Asist. Tecnica Marcos**, Cl Pio Del Rio Horteiga 2-4, Valladolid, 983/ 29.78.66 / **Jesus Albuquerque**, Cl Vinos Ribera Del Duero 10, Valladolid, 983/ 24.62.26 / **Teodoro Negro Hernandez**, Glorieta Descubrimiento 4, Valladolid, 983/ 39.17.81

VIZCAYA: **Servitele**, Cl Autonomia 24 Galerias, Bilbao, 94/ 444.89.02 / **Negredo Martin Daniel**, Cl Padre Pernet 8, Bilbao, 94/ 411.22.82 / **Collantes Martin Onofre**, Cl Ortuño De Alango 7, Portugalete, 94/ 483.21.22

ZAMORA: **R.T.V. Blanco**, Cl Eduardo Julian Perez 9, Zamora, 980/ 51.14.41

ZARAGOZA: **Cinca Monterde Antonio**, Cl Via Universitas 52, Zaragoza, 976/ 31.69.65 / **Aragon Televideo, S.C.**, Cl Batalla Clavijo 18, Zaragoza, 976/ 32.97.12

SWITZERLAND - <http://www.sharp.ch>

Sharp Electronics AG, Langwiesenstrasse 7, CH-8108 Dällikon, +41 1 846 61 11

SWEDEN - <http://www.sharp.se>

Bild&Ljudservice, Roxviksgatan 8, 582 73 Linköping, 013-356250

Jönköping Antenn & TV Service, Fridhemsvägen 20, 553 02 Jönköping, 036-161690

Tomi Elektronik, Svandammsplan 2, 126 47 Hägersten, 08-186170

Tv Trim, St Pauligatan 37, 416 90 Göteborg, 031-847200

Tv-berg, Krusegatan 26, 212 25 Malmö, 040-188380

NORWAY

Service Eksperten, Trondheimsvn 436B, N-0962 Oslo, 22 90 19 30

ICELAND

Braedurnir Ormsson Ltd, PO box 8790, IS-128 Reykjavik, +354-5332800

Hjólmtækni Ehf, Skeifar, IS-108 Reykjavik, +354-5332150

DENMARK

Elektronik Centret, Literbuen 10A, DK2740 Skovlunde, 44 50 30 00

SUOMI

Oy Perkkio, PL 40 Rälssintie 6, SF-00721 Helsinki, +35-8947805000

Theho Video Oy, Niittyläntie 3, SF-0620 Helsinki, +35-891461500



SPECIFICATION

AC Line Voltage	: 230 V, 50 Hz, single phase
Distribution line fuse/circuit breaker	: Minimum 16 A
AC Power required:	Microwave : 1,45 kW Top Grill : 1,25 kW Bottom Grill : 0,65 kW Top Grill/Microwave : 2,65 kW Bottom Grill/Microwave : 2,05 kW Top and Bottom Grill : 1,85 kW Triple : 3,40 kW Convection : 1,86 kW Convection/Microwave : 2,06 kW
Output power:	Microwave : 900 W (IEC 60705) Top Grill : 1,2 kW Bottom Grill : 0,6 kW Convection : 1,8 kW
Microwave Frequency	: 2450 MHz * (Group 2/Class B)
Outside Dimensions	: 520 mm (W) x 309 mm (H) x 486 mm (D)
Cavity Dimensions	: 353 mm (W) x 207 mm (H) x 357 mm (D) **
Oven Capacity	: 26 litres **
Turntable	: ø325 mm, metal
Weight	: approx. 19 kg
Oven lamp	: 25 W/240 - 250 V

- * This Product fulfils the requirement of the European standard EN55011.
 In conformity with this standard, this product is classified as group 2 class B equipment.
 Group 2 means that the equipment intentionally generates radio-frequency energy in the form of electromagnetic radiation for heating treatment of food.
 Class B equipment means that the equipment is suitable to be used in domestic establishments.

- ** Internal capacity is calculated by measuring maximum width, depth and height.
 Actual capacity for holding food is less.



This equipment complies with the requirements of directives 89/336/EEC and 73/23/EEC as amended by 93/68/EEC.

As part of a policy of continuous improvement, we reserve the right to alter design and specifications without notice.

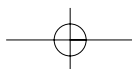
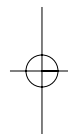
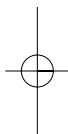
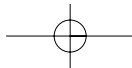

SHARP

SHARP ELECTRONICS (EUROPE) GMBH.
Sonninstrasse 3
20097 Hamburg
Germany

SHARP MANUFACTURING

ist ein Mitglied von:
est un membre de:
is een lid van:
è un membro di:
es un miembro de:
é um membro de:



<http://www.microwavesassociation.org.uk/>

Gedruckt in Grossbritannien
Imprimé au Royaume-Uni
Gedruckt in Groot-Brittannie
Stampato in Gran Bretagna
Impreso en el Reino Unido
Impreso no Reino Unido



Der Zellstoff zur
Herstellung dieses
Papiers kommt zu
100 % aus nachhaltig
bewirtschafteten
Wäldern

Ce papier est
entièrement fabriqué
à partir de pâte à
papier provenant
de forêts durables

De pulp die gebruik is
voor de vervaardiging
van dit papier is voor
100 % afkomstig uit
bossen die doorlopend
opnieuw aangepland
worden

Il 100 % della pasta
utilizzata per
produrre questa carta
proviene da foreste
sostenibili

El 100 % de la
pasta utilizada en
la fabricación de
este papel procede
de bosques
sostenibles

Este papel é
totalmente fabricado
a partir de pasta de
papel proveniente
de florestas duráveis

TINS-A398URRO

SHARP

SHARP ELECTRONICS (EUROPE) GMBH.
Sonninstrasse 3
20097 Hamburg
Germany

SHARP MANUFACTURING

ist ein Mitglied von:

est un membre de:

is een lid van:

è un membro di:

es un miembro de:

é um membro de:



<http://www.microwavesassociation.org.uk/>

Gedruckt in Grossbritannien

Imprimé au Royaume-Uni

Gedruckt in Groot-Brittannie

Stampato in Gran Bretagna

Impreso en el Reino Unido

Impresso no Reino Unido



Das Papier dieser
Bedienungsanleitung
besteht zu 100 %
aus Altpapier

Le papier de ce
mode d'emploi est
fait de 100 %
de papier réutilisé

De papier voor deze
gebruiksaanwijzing
is van 100 %
hergebruiken papier
gemaakt

La carta di questo
manuale d'istruzioni
è fatta di 100 %
della carta riciclata

El papel de este
manual de
instrucciones se
hace de 100 %
es del papel
reciclado

O papel deste
manual da operação
é feito de 100 %
do papel recycled

TINS-A398URRO

Free Manuals Download Website

<http://myh66.com>

<http://usermanuals.us>

<http://www.somanuals.com>

<http://www.4manuals.cc>

<http://www.manual-lib.com>

<http://www.404manual.com>

<http://www.luxmanual.com>

<http://aubethermostatmanual.com>

Golf course search by state

<http://golfingnear.com>

Email search by domain

<http://emailbydomain.com>

Auto manuals search

<http://auto.somanuals.com>

TV manuals search

<http://tv.somanuals.com>