

SHARP®

Portable DVD Video Player
Reproductor de Video DVD Portátil
Bärbar DVD-spelare

DV-L70S DV-L70BL

OPERATION MANUAL
MANUAL DE MANEJO
BRUKSANVISNING

ENGLISH **GB** 1 – **GB** 95
ESPAÑOL **E** 1 – **E** 95
SVENSKA **S** 1 – **S** 95



This equipment complies with the requirements of Directives 89/336/EEC and 73/23/EEC as amended by 93/68/EEC.

Dieses Gerät entspricht den Anforderungen der EG-Richtlinien 89/336/EWG und 73/23/EWG mit Änderung 93/68/EWG.

Ce matériel répond aux exigences contenues dans les directives 89/336/CEE et 73/23/CEE modifiées par la directive 93/68/CEE.

Dit apparaat voldoet aan de eisen van de richtlijnen 89/336/EEG en 73/23/EEG, gewijzigd door 93/68/EEG.

Dette udstyr overholder kravene i direktiv nr. 89/336/EEC og 73/23/EEC med tillæg nr. 93/68/EEC.

Quest' apparecchio è conforme ai requisiti delle direttive 89/336/EEC e 73/23/EEC, come emendata dalla direttiva 93/68/EEC.

Η εγκατάσταση αυτή ανταποκρίνεται στις απαιτήσεις των οδηγιών της Ευρωπαϊκής Ένωσης 89/336/ΕΟΚ και 73/23/ΕΟΚ, όπως οι κανονισμοί αυτοί συμπληρώθηκαν από την οδηγία 93/68/ΕΟΚ.

Este equipamento obedece às exigências das directivas 89/336/CEE e 73/23/CEE, na sua versão corrigida pela directiva 93/68/CEE.

Este aparato satisface las exigencias de las Directivas 89/336/CEE y 73/23/CEE, modificadas por medio de la 93/68/CEE.



Denna utrustning uppfyller kraven enligt riktlinjerna 89/336/EEC och 73/23/EEC så som kompletteras av 93/68/EEC.

Dette produktet oppfyller betingelsene i direktivene 89/336/EEC og 73/23/EEC i endringen 93/68/EEC.

Tämä laite täyttää direktiivien 89/336/EEC ja 73/23/EEC vaatimukset, joita on muutettu direktiivillä 93/68/EEC.

SPECIAL NOTE FOR USERS IN THE U.K.

The mains lead of this product is fitted with a non-rewireable (moulded) plug incorporating a 3A fuse.

Should the fuse need to be replaced, a BSI or ASTA approved BS 1362 fuse marked  or  and of the same rating as above, which is also indicated on the pin face of the plug, must be used.

Always refit the fuse cover after replacing the fuse. Never use the plug without the fuse cover fitted.

In the unlikely event of the socket outlet in your home not being compatible with the plug supplied, cut-off the mains plug and fit an appropriate type.

DANGER: The fuse from the cut-off plug should be removed and the cut-off plug destroyed immediately and disposed of in a safe manner.

Under no circumstances should the cut-off plug be inserted elsewhere into a 13A socket outlet, as a serious electric shock may occur.

To fit an appropriate plug to the mains lead, follow the instructions below:

IMPORTANT: The wires in the mains lead are coloured in accordance with the following code:

Blue: Neutral

Brown: Live

As the colours of the wires in the mains lead of this product may not correspond with the coloured markings identifying the terminals in your plug, proceed as follows:

- The wire which is coloured blue must be connected to the plug terminal which is marked N or coloured black.
- The wire which is coloured brown must be connected to the plug terminal which is marked L or coloured red.

Ensure that neither the brown nor the blue wire is connected to the earth terminal in your three-pin plug.

Before replacing the plug cover make sure that:

- If the new fitted plug contains a fuse, its value is the same as that removed from the cut-off plug.
- The cord grip is clamped over the sheath of the mains lead and not simply over the lead wires.

IF YOU HAVE ANY DOUBT, CONSULT A QUALIFIED ELECTRICIAN.

**GENERAL
INFORMATION**

**CONNECTION and
INITIAL SETTING**

**BASIC
OPERATIONS**

**SPECIAL
FUNCTIONS**

OTHERS

ENGLISH

OPERATION MANUAL



IMPORTANT SAFEGUARDS AND PRECAUTIONS

CAUTION

BEFORE OPERATING YOUR NEW DVD PLAYER, PLEASE CAREFULLY READ THIS OPERATION MANUAL AND THEN SAVE IT FOR FUTURE REFERENCE.

Note:

This unit can be used only where the power supply is AC 110V-240V, 50/60Hz. It cannot be used elsewhere.

CAUTION:

USE OF CONTROLS OR ADJUSTMENTS OR PERFORMANCE OF PROCEDURES OTHER THAN THOSE SPECIFIED HEREIN MAY RESULT IN HAZARDOUS RADIATION EXPOSURE.

AS THE LASER BEAM USED IN THIS DVD PLAYER IS HARMFUL TO THE EYES, DO NOT ATTEMPT TO DISASSEMBLE THE CABINET. REFER SERVICING TO QUALIFIED PERSONNEL ONLY.

WARNING:

TO REDUCE THE RISK OF FIRE OR ELECTRIC SHOCK, DO NOT EXPOSE THIS EQUIPMENT TO RAIN OR MOISTURE.

TO REDUCE THE RISK OF FIRE OR ELECTRIC SHOCK, AND ANNOYING INTERFERENCE, USE THE RECOMMENDED ACCESSORIES ONLY.

Laser Diode Properties	
for DVD disc Play	for CD, Video CD disc Play
Material: AlGaInP	Material: AlGaAs
Wave length: 650 nm	Wave length: 780 nm
Emission duration: Continuous	Emission duration: Continuous
Laser output: Max. 0.7 mW	Laser output: Max. 0.7 mW



IMPORTANT SAFEGUARDS AND PRECAUTIONS

- This DVD player is classified as a CLASS 1 LASER product.
 - "CLASS 1 LASER PRODUCT" is printed at the bottom of the player.
 - The laser caution label is located at the bottom of the player.
 - This product contains a low power laser device.
- To ensure continued safety do not remove any cover or attempt to gain access to the inside of the product. Refer all servicing to qualified personnel.

CAUTION : VISIBLE AND INVISIBLE LASER RADIATION WHEN OPEN AND INTERLOCKS DEFEATED. DO NOT STARE INTO BEAM OR VIEW DIRECTLY WITH OPTICAL INSTRUMENT.

VARNING : SYNLIIG OCH OSYNLIIG LASERSTRÅLNING NÄR DENNA DEL ÄR ÖPPNAD OCH SPÄRRAR ÄR URKOPPLADE. STIRRA EJ IN I STRÅLEN OCH BETRAKTA EJ STRÅLEN GENOM OPTISKA INSTRUMENT.

VARO : AVATTAESSA JA SUOJALUKITUS OHITETTAESSA OLET ALTTIINA NÄKYVÄÄ JA NÄKYMÄTÖN LASERSÄTEILYLLE. ÄLÄ TUIJOTA SÄTEESEEN ÄLÄKÄ KATSO SITÄ OPTISEN LAITTEEN LAPI.

ADVARSEL : SYNLIIG OG USYNLIIG LASERSTRÅLNING NÄR DEKSEL ÖPNES OG SIKKERHEDSLÄS BRYTES. STIRR IKKE INN I STRÅLEN ELLER SE DIREKTE MED OPTISKE INSTRUMENTER.

ADVARSEL : SYNLIIG OG USYNLIIG LASERSTRÅLNING VED ÅBNING, NÄR SIKKERHEDSÅFBRYDERE ER UDE AF FUNKTION. SE IKKE IND I STRÅLEN HELLER IKKE MED OPTISKE INSTRUMENTER.

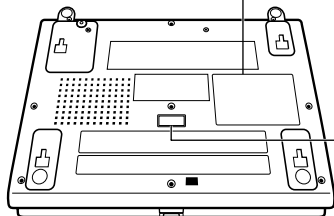

CLASS 1
LASER PRODUCT

CAUTION
VISIBLE AND INVISIBLE LASER RADIATION
WHEN OPEN AND INTERLOCKS DEFEATED.
DO NOT STARE INTO BEAM OR VIEW
DIRECTLY WITH OPTICAL INSTRUMENT.

WARNING
DO NOT DEFEAT THESE INTERLOCKS.

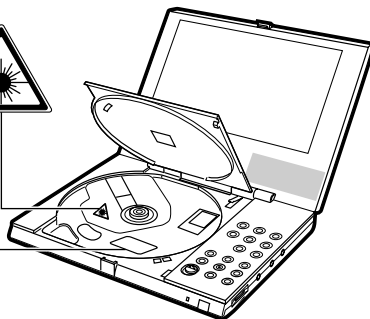



IMPORTANT SAFEGUARDS AND PRECAUTIONS

Power Cord Protection

To avoid any malfunctions of the unit, and to protect against electric shock, fire or personal injury, please observe the following.

- Hold the plug firmly when connecting or disconnecting the AC power cord.
- Keep the AC power cord away from heating appliances.
- Never put any heavy object on the AC power cord.
- Do not attempt to repair or reconstruct the AC power cord in any way.

Location and Handling

- Air vents are provided in the DVD player cabinet to prevent excessive temperatures inside the unit. Do not place your DVD player in closed spaces, cover it, or otherwise block the vents.
- Do not place the DVD player in direct sunlight, or near heat sources.
- Keep the DVD player away from strong magnetic objects.
- Do not insert or drop anything into the DVD player through the air vents as this could cause serious damage, possibly resulting in fire.
- Do not place any object containing water or other liquids on the DVD player. In the event that liquid should enter the cabinet, unplug the DVD player immediately and contact the retailer or service centre approved by SHARP immediately.
- Do not remove the DVD player cabinet. Touching parts inside the cabinet could result in electric shock and/or damage to the DVD player. For service and adjustment inside the cabinet, call a qualified dealer or service centre approved by SHARP.

Nonuse Periods

When the unit is not being used, turn the unit off.

When left unused for a long period of time, the unit should be unplugged from the household AC outlet.

No Fingers or Other Objects Inside

Do not place any foreign object in the disc compartment.

Stacking

Place the unit in a horizontal position, and do not place anything heavy on it.



Condensation

Moisture may form on the pickup lens in the following conditions:

- immediately after a heater has been turned on.
- in a steamy or very humid room.
- when the unit is suddenly moved from a cold environment to a warm one.

If moisture forms inside this unit, it may not operate properly.

In this case, turn on the power and wait about one hour for the moisture to evaporate.

If There is Noise Interference on the TV While a Broadcast is being Received

Depending on the reception condition of the TV, interference may appear on the TV monitor while you watch a TV broadcast and the unit is left on.

This is not a malfunction of the unit or the TV. To watch a TV broadcast, turn off the unit.

Service

Do not attempt to service this DVD player yourself. Please refer any service to the nearest service centre approved by SHARP.

Copyright

Audio-visual material may consist of copyrighted works which must not be recorded without the authority of the owner of the copyright. Please refer to relevant laws in your country.

Copy Protection

For the European Continent except the U.K.

This DVD player supports Macrovision copy protection.

On DVD discs that include a copy protection code, if the contents of the DVD disc are copied using a VCR, the copy protection code prevents the videotape copy from playing normally.

For the U.K.

Recording and playback of any material may require consent.

Please refer particularly to the provisions of the Copyright Act 1956, the Dramatic and Musical Performers Protection Act 1958, the Performers Protection Acts 1963 and 1972 and to any subsequent statutory enactments and orders.



IMPORTANT SAFEGUARDS AND PRECAUTIONS

Apparatus Claims of U.S. Patent Nos. 4,631,603, 4,577,216, 4,819,098 and 4,907,093 licensed for limited viewing uses only.

This product incorporates copyright protection technology that is protected by method claims of certain U.S. patents and other intellectual property rights owned by Macrovision Corporation and other rights owners. Use of this copyright protection technology must be authorized by Macrovision Corporation, and is intended for home and other limited viewing uses only unless otherwise authorized by Macrovision Corporation. Reverse engineering or disassembly is prohibited.

Recommended Measures for Optimum Picture Excellence

The unit is a precision device that is constructed using extremely accurate technology.

Soiling or friction affecting the pickup lens or disc drive can impair the image quality. At the worst, neither video nor audio will be played back. To obtain optimum picture quality, the player should be checked (cleaning and replacement of some parts) every 1,000 hours. Note that this period varies depending on the environment (temperature, humidity, dust, etc.) in which the player is used. Contact your authorized Sharp supplier for details.

Do not attempt to clean the pickup lens yourself.



Disc Handling and Maintenance

Handling precautions

- Hold the disc by the edges so the surface will not be soiled with fingerprints. **(A)**
Fingerprints, dirt and scratches can cause skipping and distortion.
- Do not write on the label side with a ball-point pen or other writing utensils.
- Do not use record cleaning sprays, benzine, thinner, static electricity prevention liquids or any other solvent.
- Be careful not to drop or bend the disc.
- Do not install more than 1 disc.
- Do not try to close the disc compartment cover when the disc is not installed properly. **(B)**
- Be sure to store the disc in its exclusive case when not in use. Then store upright.
- Do not stick paper or adhesive labels to the disc.

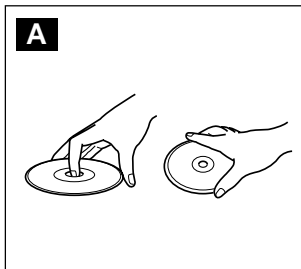

If the Surface is Soiled **(C)**

Wipe gently with a soft, damp (water only) cloth. When wiping discs, always move the cloth from the centre hole toward the outer edge. (If you wipe the discs using a circular motion, circular scratches are likely to occur, which will cause noise.)

If the playing surface of a disc is soiled or scratched, the player may display indicator  on the screen and fail to play the disc correctly. Wipe any soiling off the playing surface with a soft cloth.

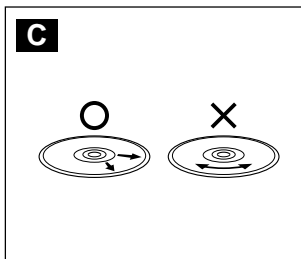
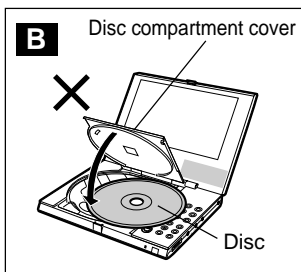

If the Disc is Brought from a Cold to a Warm Environment, Dew may form on the Disc

Wipe this dew off with a soft, dry, lint-free cloth before using the disc.

Improper Disc Storage

You can damage discs if you store them in the following places:

- Areas exposed to direct sunlight
- Humid or dusty areas
- Areas directly exposed to a heat outlet or heating appliance

Contents



GENERAL INFORMATION

IMPORTANT SAFEGUARDS AND PRECAUTIONS	2
Disc Handling and Maintenance	7
Handling precautions	7
Features	10
Accessories	11
Types of Disc that can be played on Your DVD Player	12
Discs recorded by PAL system, Discs recorded by NTSC system and Type of TV connection	16
NTSC disc playback on a PAL TV	16
Quick Start Guide	17
General Guide	24
Using Headphones	28
To use the supplied earphones	28



CONNECTION and INITIAL SETTING

Connecting to External Equipment for Input	29
To connect external equipment	29
Connecting a TV with External Terminals	30
Connecting to Audio Equipment	31
Playing 2 channel audio	31
Playing Dolby Digital (5.1 channel), DTS and MPEG Version 2.0 audio	32
Using the AC Adapter	33
Using a Battery Pack (Sold Separately)	34
To charge the battery pack	34
To attach a battery pack to the DVD player	35
Battery Capacity Indicator	37
Turning Power On and Off	38
To turn main power on and off	38
Using the Remote Control Unit	40
To load batteries	40
Remote control unit operating range	40
Operation Modes	41
To select an operation mode	41
Setup	42
Setting the language	42
TV MODE SET setting	43
PARENTAL setting	45
COMPRESSION (Dolby Digital Output Level) setting	47
DISC MENU LANGUAGE setting	49
MPEG OUT setting	50
Screen Size Setting	52
To set the screen size	52
Changing the Display Mode	54
To change the display mode	54
DVD mode operation indicators	56



BASIC OPERATIONS

Playing a Disc 57
 To play a disc 57
 To adjust the volume level 58
 To stop disc play 58
Other Disc Play Features 59
 To resume disc play after stopping 59
 To use fast forward and fast reverse 60
 To use slow motion (DVD only) 60
 To use still picture and frame advance 61
 Chapter/track skip 62
 Title/track direct skip 63
 Chapter direct skip (DVD only) 63



SPECIAL FUNCTIONS

Repeat Playback 64
Programmed Playback 66
Making Display Settings 70
 To make digital gamma settings (DVD, Video CD only) 70
 To make digital super picture settings (DVD, Video CD only) 71
Audio Selection (DVD, Video CD only) 72
Angle Selection (DVD only) 74
Subtitle Selection (DVD only) 75
Using Dolby Virtual (DVD only) 76
Selecting Titles from the Title Menu of a DVD (DVD only) 77
Setting Play Parameters Using the Disc Menu (DVD only) 78
Settings from the DVD Player Control Panel (GUI) 79
Adjusting Display 81
 To adjust display colours 81
 To adjust overall screen brightness 82
Viewing Images from an External Device 83



OTHERS

References 84
 Precautions 84
 AC Adapter 86
 Care 86
 Battery Pack (Sold Separately) 86
Troubleshooting 88
Error Indicators and Warnings 91
Specifications 92
Glossary 94



Features

7" LCD Screen and Stereo Speakers

- A big 7" LCD screen and built-in stereo speakers provide exciting DVD viewing, even without connecting to a TV.
- Dolby Virtual provides high-quality surround sound.

2-Way Power Supply (Battery pack is sold separately.)

- A 2-way power supply allows operation using the supplied AC adapter for indoor play, or the battery pack sold separately for outdoor play.

Compact, Lightweight Design

- About the size of a movie DVD case, your DVD player is designed to go along just about anywhere.

High-Resolution Images, High-Quality Sound

- A high-resolution 336,960-pixel LCD screen produces images of outstanding quality.
- Digital gamma correction and digital super picture provide more realistic image detail.
- Dolby Virtual ensures richer sound from two built-in speakers.

AV input/output, optical digital output jack equipped as standard







- An optical digital output jack (which doubles as the audio input/output jack) can be used to output a stream of *1Dolby Digital 5.1 channel audio, *2DTS digital audio and Audio MPEG. Connecting a Dolby Digital/DTS/Audio MPEG digital surround processor or amplifier to this jack creates an environment of amazingly powerful surround sound.
- The AV input/output jack can be used to connect a video deck or camcorder to your DVD player. Or you can use these jacks to connect to a TV for big-screen viewing. (Output only is supported for S-video. An S-video signal cannot be input to your DVD player.)

*1 Manufactured under license from Dolby Laboratories. "Dolby", "Pro Logic" and the double-D symbol are trademarks of Dolby Laboratories. Confidential Unpublished Works. ©1992-1997 Dolby Laboratories, Inc. All rights reserved.

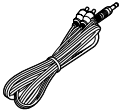

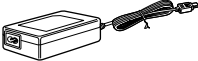
*2 "DTS" and "DTS Digital Surround" are trademarks of Digital Theater Systems, Inc.

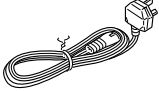

Accessories

<p>Remote Control Unit</p> 	<p>Audio Cord</p> 	<p>S-video/Video Cord</p> 
	<p>AC Adapter</p> 	<p>Earphones</p> 
<p>Two (R6 UM/SUM-3 or AA) Batteries for the Remote Control Unit</p> 	<p>AC Cord For the European Continent except the U.K. and Eire</p>  <p>(Supplied with DV-L70S/ DV-L70BL)</p>	<p>For the U.K. and Eire</p>  <p>(Supplied with DV-L70S only)</p>





Disc Features and this Operation Manual

- The types of functions and operations that can be used for a particular disc vary depending on the features of that disc. In some cases, these functions and operations may differ from the descriptions given in this Operation Manual. In this event, follow the instructions given on the screen. This Operation Manual only covers basic disc operations.
- **For some operations, the  or  indicator may appear on the screen. This indicates that the operation described in this Operation Manual is not permitted for the current disc.**



Types of Disc that can be played on Your DVD Player

The unit can play back discs bearing any of the following marks:

	DVD [8cm disc/12cm disc]	See NOTE 1 See NOTE 2 on the next page See NOTE 3 on the next page
	Video CDs [8cm disc/12cm disc]	See NOTE 2 on the next page • Supports version until version 2.0.
	Audio CDs [8cm disc/12cm disc]	
<p>Other CDs</p> <ol style="list-style-type: none"> 1) On CD-G and CD-EXTRA discs, only the sound can be played (no images). 2) Photo CD, DVD-ROM and CD-ROM discs cannot be used. 3) Discs with unusual shapes (heart-shaped or hexagonal discs) cannot be used. The use of such discs will cause a fault. <ul style="list-style-type: none"> • When the player detects an incompatible disc, it displays indicator . When this happens, check the disk type. 		

NOTE 1

- DVD players and discs are designed with region numbers which dictate the regions in which a disc can be played. If the region number on the disc you want to play does not match the region number in your DVD player, you will not be able to play the disc.

The region number for this DVD player is 2.

Sample disc display:



Disc playable in all regions



Types of Disc that can be played on Your DVD Player

The list below shows the countries covered by region number 2.

Common Names	Names of Nations and Areas	Common Names	Names of Nations and Areas
Albania	Republic of Albania	Monaco	Principality of Monaco
Andorra	Principality of Andorra	Netherlands	Kingdom of the Netherlands
Austria	Republic of Austria	Norway	Kingdom of Norway
Bahrain	State of Bahrain	Oman	Sultanate of Oman
Belgium	Kingdom of Belgium	Poland	Republic of Poland
Bosnia and Herzegovina	Bosnia and Herzegovina	Portugal	Portuguese Republic
Bulgaria	Republic of Bulgaria	Qatar	State of Qatar
Croatia	Republic of Croatia	Romania	Romania
Cyprus	Republic of Cyprus	San Marino	Republic of San Marino
Czech	The Czech Republic	Saudi Arabia	Kingdom of Saudi Arabia
Denmark	Kingdom of Denmark	Slovakia	The Slovak Republic
Egypt	Arab Republic of Egypt	Slovenia	Republic of Slovenia
Finland	Republic of Finland	South Africa	Republic of South Africa
France	French Republic	Spain	Spain
Germany	Federal Republic of Germany	Swaziland	Kingdom of Swaziland
Greece	Hellenic Republic	Sweden	Kingdom of Sweden
Hungary	Republic of Hungary	Switzerland	Swiss Confederation
Iceland	Republic of Iceland	Syrian Arab Republic	Syrian Arab Republic
Iran	Islamic Republic of Iran	Turkey	Republic of Turkey
Iraq	Republic of Iraq	United Arab Emirates	United Arab Emirates
Ireland	Ireland	United Kingdom	United Kingdom of Great Britain and Northern Ireland
Israel	State of Israel	Vatican City State	State of the City of Vatican
Italy	Republic of Italy	Yemen	Republic of Yemen
Japan	Japan	Yugoslavia	Federal Republic of Yugoslavia
Jordan	Hashemite Kingdom of Jordan	Channel Islands*	Channel Islands
Kuwait	State of Kuwait	Faeroe Islands*	Faeroe Islands
Lebanon	Republic of Lebanon	Gibraltar*	Gibraltar
Lesotho	Kingdom of Lesotho	Greenland*	Greenland
Liechtenstein	Principality of Liechtenstein	Isle of Man*	Isle of Man
Luxembourg	Grand Duchy of Luxembourg	Svalbard and Jan Mayen Islands*	Svalbard and Jan Mayen Islands
Macedonia	The Former Yugoslav Republic of Macedonia		
Malta	Republic of Malta		

*represents Area Name

NOTE 2

- The specific playback functionality for some DVD and video CD discs is determined by the disc manufacturer. Because this DVD player plays disc data in accordance with the disc manufacturer's guidelines, some functions may not be available on some discs. Be sure to read the instructions provided with the disc.

The "Prohibited" indicator  displayed during DVD player operation indicates that such manufacturer-imposed restrictions apply.

NOTE 3

- This DVD player supports the 2-channel(L/R) audio in Audio MPEG Version 2.0. However, it does not support 7.1-channel in Audio MPEG Version 2.0.







Discs that Cannot be Played

1. You cannot play illegally produced discs.
 - You cannot play discs of other region number than No. 2 (refer to the list of region number 2 on page 13), such as discs for the use in U.S.A. (region No. 1) and China (region No. 6).
2. You cannot play scratched discs.
3. You cannot play discs that are dusty, soiled or marked with fingerprints.
- If the playing surface of a disc is soiled or scratched, the player may display indicator  on the screen and fail to play the disc correctly. (Refer to the instructions on page 7 and clean discs before attempting to play them.)

While a disc is playing, soiling or scratches on the disc may disrupt the image (appearing as blocks on the screen). When the image is disrupted, the player automatically restores the correct image after 2 or 3 seconds. If the normal screen does not reappear, press the **RESUME** button on the remote control. This will bring up the normal screen again.

Icons Used on DVD Discs

Sample Icons

	1. English 2. Chinese		1. English 2. Chinese			
Number of recorded audio tracks		Type of subtitles recorded		Screen aspect ratio recorded	Disc with multiple camera angles	Region code indicator (see page 12)



Title, chapter and tracks

- DVDs are divided into “titles” and “chapters”. If the disc has more than one movie on it, each movie would be a separate “title”. “chapters”, on the other hand, are subdivisions of titles.

Example: DVD

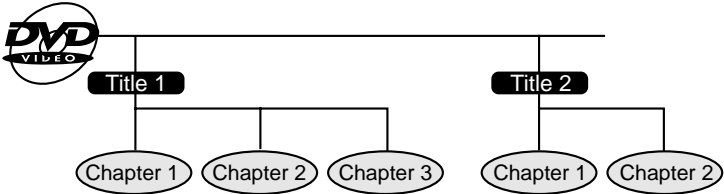

- Video CDs and audio CDs are divided into “tracks”. You can think of a “track” as one tune on an audio CD.

Example: Video CD or Audio CD



NOTE

- Numbers identify each title, chapter, and track on a disc. Most discs have these numbers recorded on them, but some do not.



Discs recorded by PAL system, Discs recorded by NTSC system and Type of TV connection

- The DVD player can play back discs recorded by NTSC using the modified PAL system, such as Video CD, DVD-region 2, but cannot play back discs for the use in U.S.A. (region No. 1).
- Region numbers cannot be changed in this system.
- This DVD player also has a built-in system converter which makes it possible to view discs (Video CD, DVD-region 2) recorded by the NTSC system using a PAL TV. (See "NTSC disc playback on a PAL TV" below.)

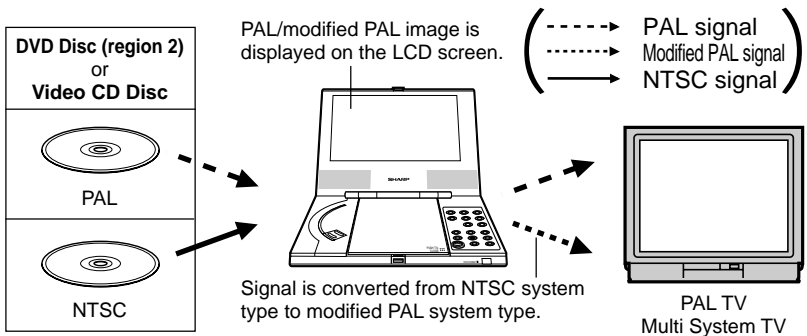

NTSC disc playback on a PAL TV

When playing an NTSC disc using a PAL TV, please note the following:

- The picture will shrink vertically to some degree, as shown in the diagram, but this does not indicate a malfunction in your TV or DVD player.
- If your TV does not have a V-HOLD control, the picture may roll and be unwatchable. However, if you use a TV with V-HOLD control, you can stop the rolling by adjusting the V-HOLD control and watch the picture.





Quick Start Guide

This Quick Start Guide provides only the most basic information for operating your DVD player. See the other sections of this Operation Manual for full details about operational procedures, precautions, and other information.

- Connections and initial settings ... on pages 29 to 50
- To play a disc on pages 57 to 82
- To view images from a video deck or other external equipment on page 83

1 Load batteries into the remote control unit.

Correctly load two batteries into the remote control unit that comes with the DVD player.

- 1** While pressing down at the point indicated by the ▼ mark, slide the battery cover from the remote control unit.

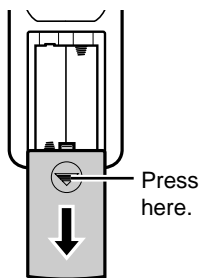

- 2** Load the batteries.

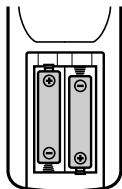

Load the two (R6 UM/SUM-3 or AA) batteries that come with the DVD player, making sure their ⊕ and ⊖ ends are facing as indicated by the markings inside the battery compartment.

- 3** Slide the battery cover back into place.

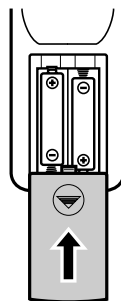

2 Open the display panel.

- 1** Press the display panel release. **2** Open the display panel.

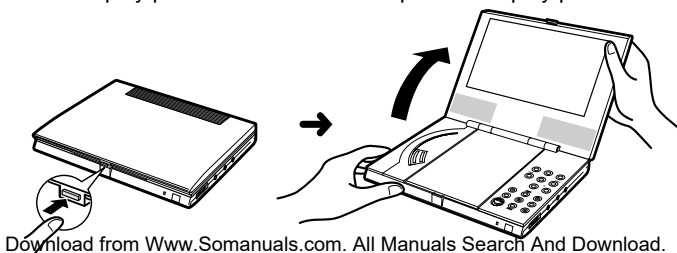



3 Turn on the DVD player.

- 1 Plug the AC cord into the power socket of the AC adapter (①).
- 2 Plug the DC output plug into the DC input jack of the DVD player (②).
- 3 Plug the other end of the AC cord into a household power outlet (③).
- 4 Slide the main power switch to the "ON" position (④).

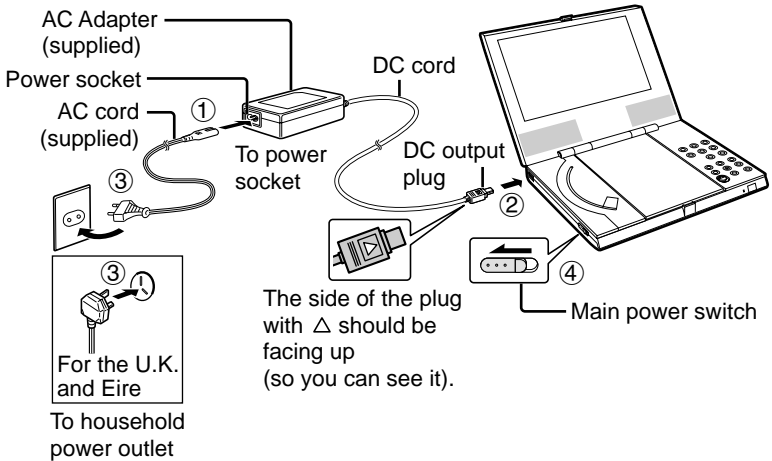









4 Prepare the disc you want to play.

Before loading a disc, check to make sure that it is one that is supported by the DVD player.

Supported disc types

Disc Type	Disc Contents	Disc Size
DVD Video Disc Region Numbers:     NTSC/PAL system DVD discs that conform to the region numbers noted above (see page 12)	Audio and video (movies)	12cm / 8cm
Video CD NTSC/PAL system video CDs  	Audio and video (movies)	12cm / 8cm
Audio CD 	Audio	12cm / 8cm (single)

5 Load the disc and start play.

After confirming that the disc is compatible, you can load it into the DVD player and play it.



To load a disc into the disc player

- 1 Slide the disc compartment cover release button in the direction indicated by the arrow and open the cover.
 - Pressing the button causes the cover to open only partially. Lift the cover by hand to open it the rest of the way.

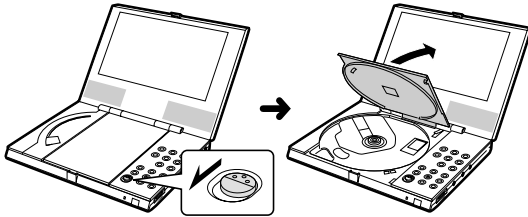

- 2 Gently press down on the disc in the vicinity of the centre hole so it seats properly into place.
 - You should be able to hear and feel the disc seat securely into place when you press down on it.



NOTE

- Make sure the label of the disc is facing up when you load it into the player.

- 3 Close the disc compartment cover and press down at the corner marked "PUSH TO CLOSE" so it locks securely into place.



Important!

- Make sure the disc seats securely when you load it into the player. An improperly seated disc can result in damage to the disc and malfunction of the player.
- The indicator  appears on the display if the disc you are using is damaged, if you load the disc upside-down, or if the region number of the disc you are using is one that is not supported by this disc player. If the above indicator appears, remove the disc from the player and take the proper corrective action.

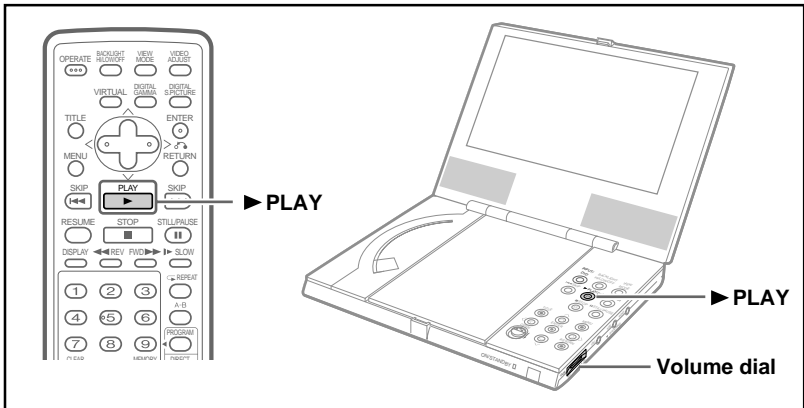

To play a disc

- 1 The startup screen appears after a few moments.
 - For information about how to turn on power and load a disc, see page 18 and 20 respectively.
- 2 After the startup screen appears, press **▶PLAY**.
 - This starts play of the disc.

Startup screen



Images appear on the display only when the display mode is "ON". See "Changing the Display Mode" on page 54 for more information.

To adjust the volume level

Rotate the volume dial on the right side of the DVD player to adjust the volume level of the audio within a range of 0 to 10.

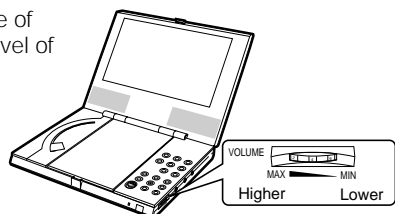



Quick Start Guide

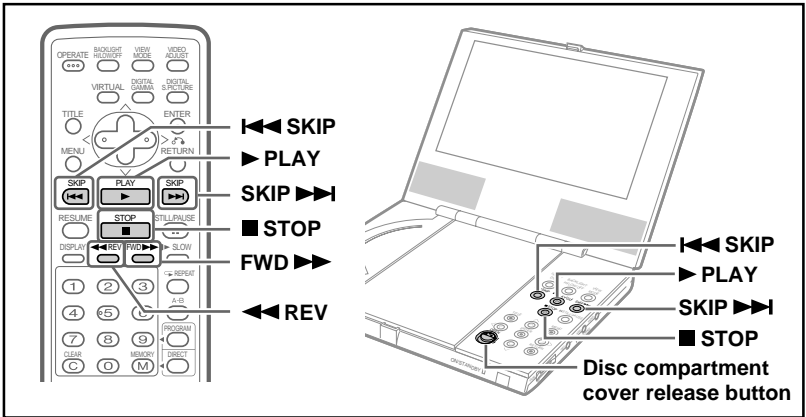

Disc play operations

To use chapter (track) skip

While a disc is playing, press **SKIP ►►►** or **◄◄◄ SKIP**.

- **SKIP ►►►** skips to the next chapter (track).
- **◄◄◄ SKIP** skips to the beginning of the current chapter (track). Press **◄◄◄ SKIP** again to skip to the previous chapter (track).

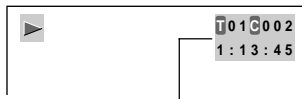

Images appear on the display only when the display mode is "ON". See "Changing the Display Mode" on page 54 for more information.

NOTE

- You may not be able to use chapter (track) skip with some discs.
- You may not be able to use chapter information display with some discs.



To fast forward and fast reverse

- 1 While a disc is playing, press **FWD▶▶** or **◀◀REV**.
 - **FWD▶▶** starts fast forward.
 - **◀◀REV** starts fast reverse.



- 2 To stop a fast forward or fast reverse operation, press **▶PLAY**.
 - This returns to normal play.

NOTE

- You may not be able to use fast forward and fast reverse with some discs.

To stop disc play

- 1 Press **■STOP**.

To remove the disc from the player

- 1 Slide the disc compartment cover release button in the direction indicated by the arrow and open the cover.
- 2 Carefully remove the disc from the player.



NOTE

- Take care so you do not touch the disc surface with your fingers. As shown in the illustration, place your index finger into the centre hole of the disc and lift up the edge of the disc with your thumb.
- 3 Close the disc compartment cover and press down at the corner marked "PUSH TO CLOSE" so it locks securely into place.



! Important!

- Keep the disc compartment cover closed except when loading or removing a disc. Otherwise, dust getting into the DVD player can lead to malfunction.



General Guide

DVD Player - Right side

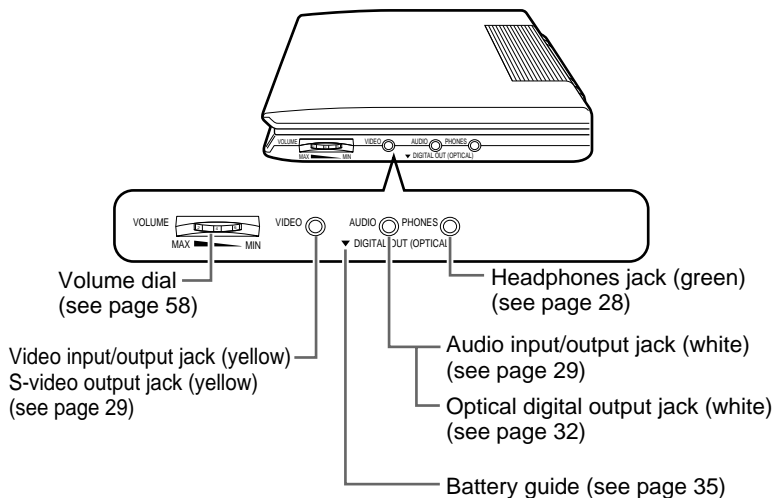

DVD Player - Left side

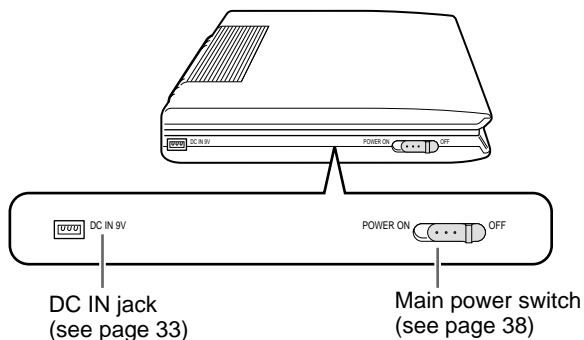



DVD Player - Front

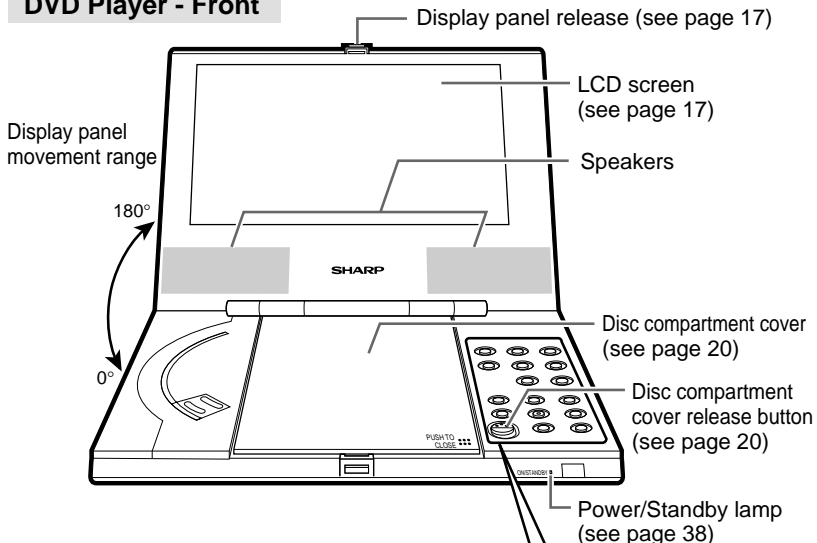

- ① INPUT/DVD (see page 41)
- ② PLAY (▶)/GUI button (see page 57/79)
- ③ SKIP (◀◀) button (see page 62)
- ④ STOP (■) button (see page 58)
- ⑤ TITLE button (see page 77)
- ⑥ ENTER button (see page 42)
- ⑦ ◀ (see page 42)
- ⑧ ▼ (see page 42)
- ⑨ BACKLIGHT HI/LOW/OFF button (see page 82)
- ⑩ VIEW MODE button (see page 53)
- ⑪ SKIP (▶▶) button (see page 62)
- ⑫ STILL/PAUSE (||) button (see page 61)
- ⑬ ▲ (see page 42)
- ⑭ MENU (see page 78)
- ⑮ ▶ (see page 42)
- ⑯ RETURN button* (see page 66)

* When in the Standby mode, pressing this button restores full power.

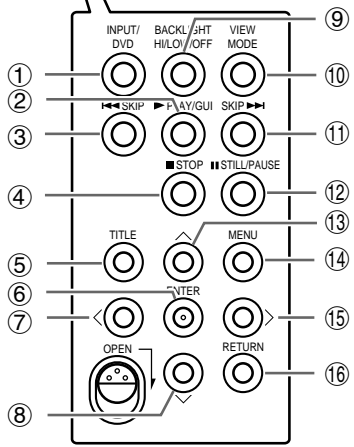

Important!

- The range of movement for the display panel is 0° to 180°. Never try to force the display panel open past 180°. Doing so can seriously damage the display panel and DVD player.



DVD Player - Bottom

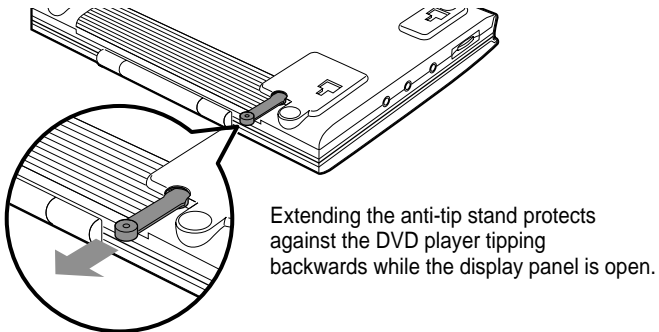
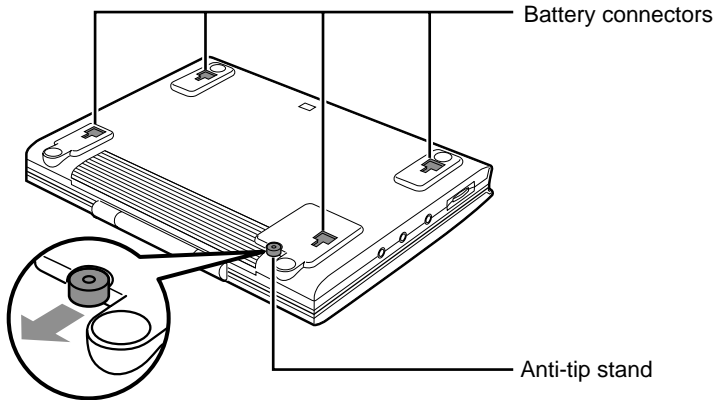



Remote Control Unit

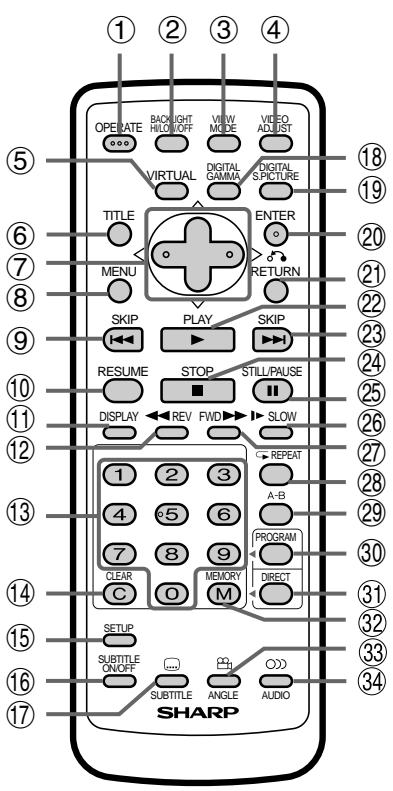

- ① OPERATE button (see page 39)
- ② BACKLIGHT HI/LOW/OFF button (see page 82)
- ③ VIEW MODE button (see page 53)
- ④ VIDEO ADJUST button (see page 81)
- ⑤ VIRTUAL button (see page 76)
- ⑥ TITLE button (see page 77)
- ⑦ Cursor buttons (▲▼◀▶) (see page 42)
- ⑧ MENU button (see page 78)
- ⑨ SKIP (◀◀) button (see page 62)
- ⑩ RESUME button (see page 59)
- ⑪ DISPLAY button (see page 54)
- ⑫ REV (◀◀) button (see page 60)
- ⑬ Number buttons (see page 63)
- ⑭ C (CLEAR) button (see page 63)
- ⑮ SETUP button (see page 42)
- ⑯ SUBTITLE ON/OFF button (see page 75)
- ⑰ SUBTITLE button (see page 75)
- ⑱ DIGITAL GAMMA button (see page 70)
- ⑲ DIGITAL S.PICTURE button (see page 71)
- ⑳ ENTER button (see page 42)
- ㉑ RETURN button (see page 66)
- ㉒ PLAY (▶) button (see page 57)
- ㉓ SKIP (▶▶) button (see page 62)
- ㉔ STOP (■) button (see page 58)
- ㉕ STILL/PAUSE (||) button (see page 61)
- ㉖ SLOW (▶▶) button (see page 60)
- ㉗ FWD (▶▶) button (see page 60)
- ㉘ REPEAT button (see page 64)
- ㉙ A-B button (see page 65)
- ㉚ PROGRAM button (see page 66)
- ㉛ DIRECT button (see page 63)
- ㉜ M (MEMORY) button (see page 67)
- ㉝ ANGLE button (see page 74)
- ㉞ AUDIO button (see page 72)



Using Headphones

You can connect the earphones that come with the DVD player or commercially available headphones with a stereo mini plug to the headphones jack and listen to the audio output.

To use the supplied earphones

- 1 Connect the earphones that come with the DVD player to the headphones jack.
 - The headphones jack is a stereo mini jack.

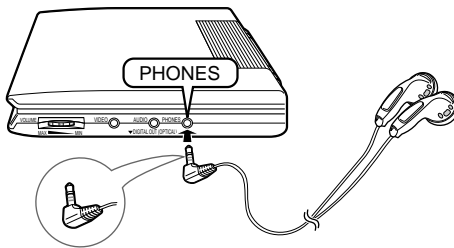

Important!

- Lower the volume level to minimum before you plug the supplied earphones or commercially available headphones.

NOTE

- Connecting the supplied earphones or commercially available headphones disables the DVD player's speakers.

- 2 Use the volume dial to adjust the volume level.

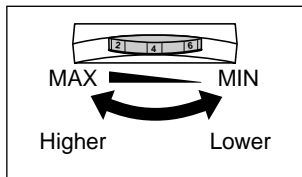



Connecting to External Equipment for Input

Selecting "INPUT" as the INPUT mode of the DVD player automatically switches the function of its video and audio input/output jacks to input. Then you can view images from a connected VCR or camcorder on the screen of your DVD player.

External Equipment

VCR (PAL system only)



Camcorder (PAL system only)



CONNECTION and INITIAL SETTING

To connect external equipment

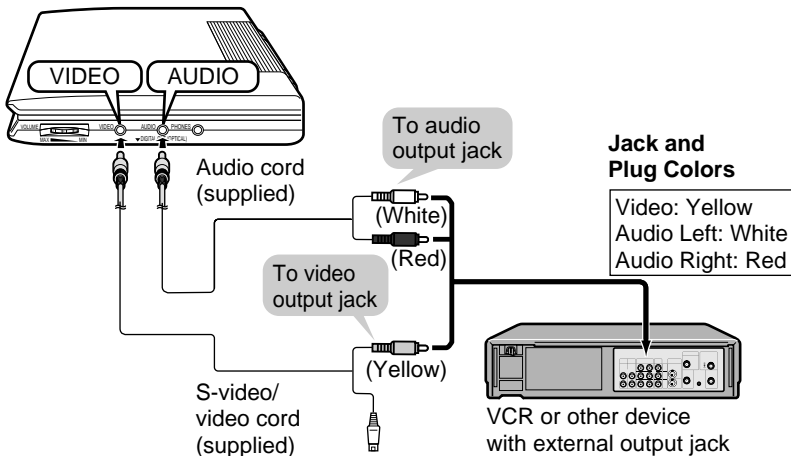

! Important!

- When inputting a modified PAL or NTSC signal, images will not appear on the screen. This does not indicate malfunction.
- Be sure to turn both the DVD player and the other equipment off before connecting them. Doing so protects against damage.
- Use only the audio and video cables supplied with the DVD player to connect to the video input/output and audio input/output jacks. Using other cables can cause malfunction.
- Refer to the operation manual for the other equipment for details about its operation, connecting procedures, etc.
- **Do not use the S-video cord for connecting to another device for input. The S-video cord is for output only.**



Connecting a TV with External Terminals

You can use the S-video plug of the S-video/video cord to connect your DVD player to a television equipped with an S-video input jack and enjoy viewing high-quality images on the TV screen.

- Be sure to turn both the DVD player and the TV equipment off before connecting them.

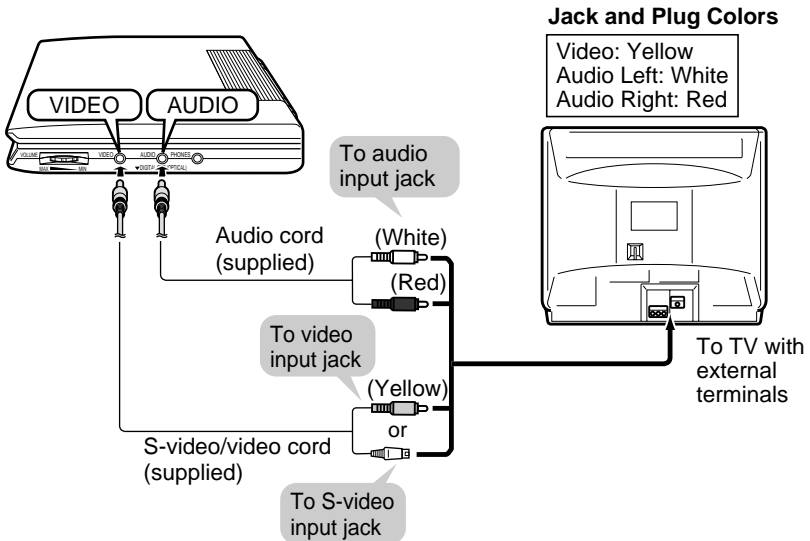

NOTE

- If you want to listen to the audio through audio equipment, connect only the S-video/video cord to the TV.
- Play is possible while the display panel of the DVD player is closed. In this case, no audio is output from the DVD player speakers.
- Use the remote control unit to control the DVD player while the display panel is closed.

To watch DVD player images on the TV

- 1 Turn on the TV.
- 2 Set the TV to channel where the DVD player is connected ("AV", "VIDEO", etc.).
- 3 Turn on the DVD player and start play.
 - See page 57 for details on how to play a disc.



Connecting to Audio Equipment

Connecting the DVD player to audio equipment provides normal stereo sound plus powerful stereo sound enhanced by Dolby Digital (5.1 channel) and DTS.

Playing 2 channel audio

The audio input/output jack of the DVD player also doubles as an optical digital output jack.

■ Analogue Connection

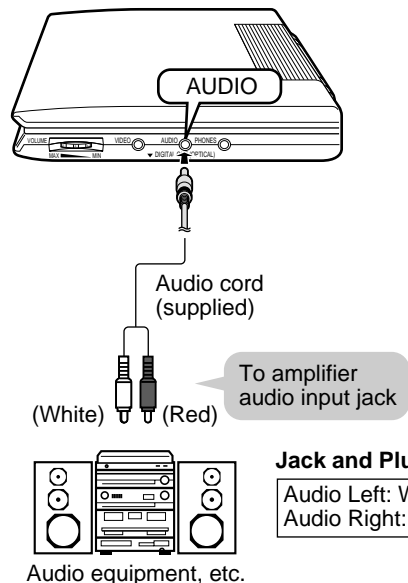

■ Digital Connection

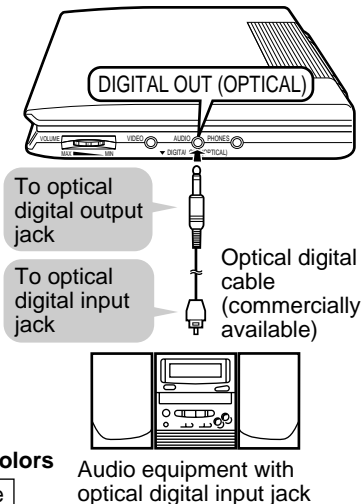

Jack and Plug Colors

Audio Left: White
Audio Right: Red

■ Digital Connection to Audio Equipment or MD Player without a Dolby Digital Decoder

- Only discs that have a linear PCM audio track (44.1kHz, 48kHz sampling frequency) will play back correctly via the digital optical link.
- Discs that have multi channel sound i.e. Dolby Digital (5.1 channel), Dolby Surround (Pro Logic), DTS or Audio MPEG Version 2.0 will only work with units equipped with the appropriate decoder. To play these discs please use the analogue connection.
- Compatibility with Audio MPEG Version 2.0 (Multi) only supports the L and R components.



Connecting to Audio Equipment

Helpful Hints

- When connecting to audio equipment, we recommend that you set the "COMPRESSION (Dolby Digital Output Level)" to "OFF" (see page 47).

Digital Connection to an MD to Record a CD

When you are using a digital connection to record the contents of a CD to an MD, the track numbers of the CD may not match the track numbers recorded to the MD.

Playing Dolby Digital (5.1 channel), DTS and MPEG Version 2.0 audio

- Connecting an amplifier with a Dolby Digital/DTS/Audio MPEG Version 2.0 digital surround processor or a Dolby Digital/DTS/Audio MPEG Version 2.0 digital surround decoder to your DVD player's optical digital jack provides richer, more powerful audio play.
- To use DTS digital surround, use the Disc Menu (page 78) or press **AUDIO** (page 72) to select DTS audio.

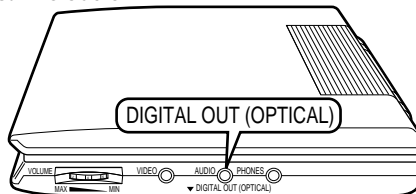

NOTE

- You need to purchase a commercially available optical digital cable to make the connection described here.
- This connection is not possible if the processor or amplifier to which you want to connect does not have an optical digital input jack.
- Refer to the operation manual for the processor or amplifier for information about connecting to it.

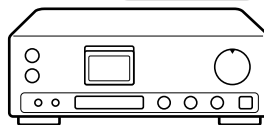
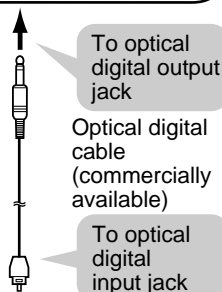

Dolby Digital (5.1ch)/DTS/
Audio MPEG Version 2.0
processor or amplifier



Using the AC Adapter

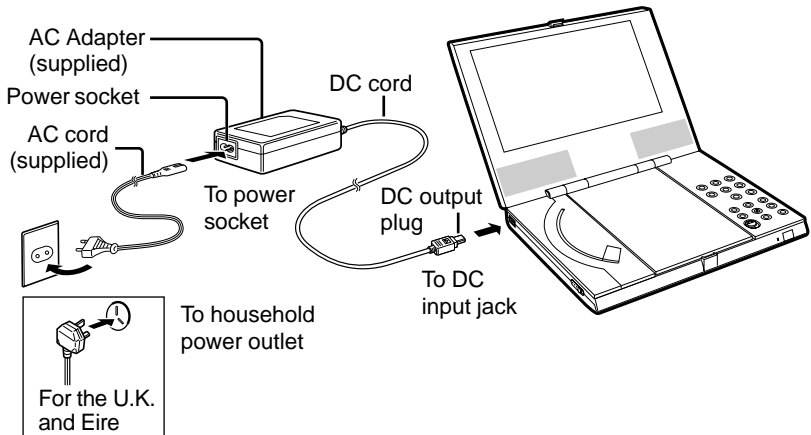

Important!

- Make sure the main power switch of the DVD player is in the "OFF" position before attaching or detaching the AC adapter.
- Use only the AC adapter specified for the DVD player. Use of another type of AC adapter can cause damage to and malfunction of the player.
- The AC adapter may become warm after long-term use. This is normal and does not indicate malfunction.
- When not in use, be sure to unplug the AC adapter from the power outlet.
- Do not leave the AC adapter in areas subject to high humidity or dust. Such conditions create the danger of fire and electric shock.

NOTE

- The AC adapter that comes with the DVD player is designed for use with any power source in the range of 110V to 240V, so you can even take it with you when travelling abroad. In some countries, however, you may need to purchase an AC plug adapter (often available at airports) to match the plug of the AC adapter to local power outlets.



CAUTION

Never use any commercially available electronic transformer.

- Connecting the AC adapter to an electronic voltage transformer of the type widely available at tourist shops can result in fire, electrical shock or other hazards.



Using a Battery Pack (Sold Separately)

The following describes how to charge the battery pack sold separately (BT-L100 (S)/BT-L100 (BL)) and use it to power the DVD player.

To charge the battery pack

Use the AC adapter that comes with the DVD player to charge the battery pack.

- 1 Plug the AC cord into the power socket of the AC adapter (①).
 - Push the cord into the AC adapter as far as it can go.

- 2 Plug the other end of the AC cord into a household power outlet (②).

- 3 Plug the DC cable into the battery pack (③).

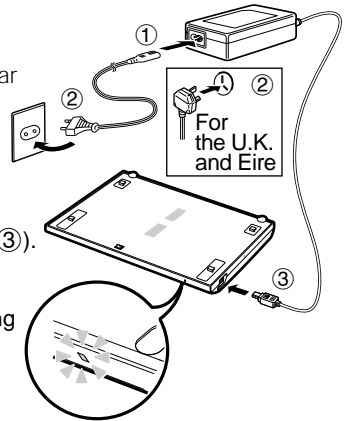

Charge Lamp

The charge lamp is red while charging is in progress, and turns green when the battery pack is fully charged.

! Important!

- Make sure the main power switch of the DVD video player is in the "OFF" position before attaching or detaching the AC adapter.
- A battery pack that is attached to the DVD player does not charge while the player is turned on. Turn power off in order to charge the battery pack.
- Before storing a battery pack, first fully discharge it by using it to power DVD player operation. At least every six months, charge a stored battery pack and use it to power the DVD player.

NOTE

- The battery pack becomes warm when charging. This is normal and does not indicate abnormality.
- If the charge lamp flashes red or does not light when charging, it could mean the battery pack is faulty. See "Troubleshooting" on page 88.

Charge time

Charge time: Approximately five hours

- The charge time noted here is the time required to bring a fully depleted battery pack to full charge.
- Cold conditions and the condition of the battery pack may cause the required charge time to be longer.



Using a Battery Pack (Sold Separately)

Be sure to charge a battery pack before using it.

To attach a battery pack to the DVD player

Make sure the DVD player's main power switch is in the "OFF" position.

- 1 Align the battery guide ▼ with the ▲ mark (①) on the battery pack.
- 2 Slide the DVD player in the direction indicated by the arrow (②).
- 3 Plug the battery pack's DC cable into the DC input jack of the DVD player.

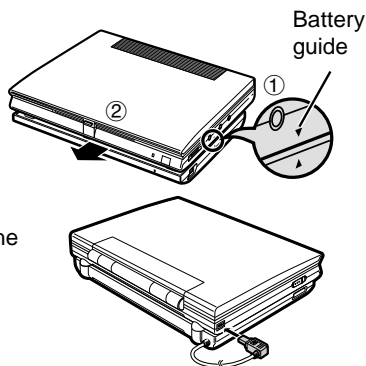

! Important!

- To prevent mis-operation while attaching or removing the battery pack, make sure the main power switch of the DVD player is in the "OFF" position.
- Make sure that the battery pack is positioned correctly when you attach it to the DVD player. Positioning it wrong can cause malfunction.
- Remove the battery pack from the DVD player when you are through using it.

NOTE

- The battery pack becomes warm during use. This is normal and does not indicate malfunction.

Helpful Hints

Using the AC Adapter with the Battery Pack

- A safety feature automatically turns off DVD player power if you set the volume level too high while playing certain types of discs. If this happens, lower the volume level and restart play.
- You can charge the battery pack while it is attached to the DVD player by connecting the AC adapter to the DVD player and turning off DVD player power.
- **The DVD player is powered by the AC adapter if you turn it on under the above conditions. The battery pack is not charged while DVD player power is turned on.**



Using a Battery Pack (Sold Separately)

DVD continuous play time

DVD continuous play time
(Using speakers)

Approximately 3 hours

- The DVD continuous play time is a reference value indicating maximum play time with low display brightness at 20°C.
- Play time may be shorter due to disc type, temperature, battery condition, and speaker volume.

To remove the battery pack from the DVD player

Make sure the DVD player's main power switch is in the "OFF" position.

- 1** Unplug the DC cable. While holding down the battery release button, slide the DVD player in the direction indicated by the arrow.

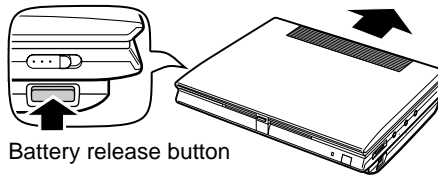

- 2** Lift the DVD player in the direction indicated by the arrow.

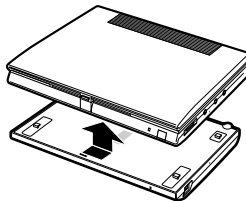

Important!

- Never remove the battery pack while a playback operation is in progress.



Battery Capacity Indicator

- The battery capacity indicator appears only while the display mode is "AUTO" or "ON". With "AUTO", the indicator appears for a short while and then disappears.
- Battery condition, temperature, and operational conditions affect the remaining capacity of a battery. Because of this the battery capacity indicator is intended to be for reference purposes only.
- Regardless of the display mode, the low battery warning appears on the display whenever the battery is about to go dead.
- The low battery warning does not appear when the display panel is closed. When the power/standby lamp goes out, replace the battery pack with a charged one or switch to AC adapter power.

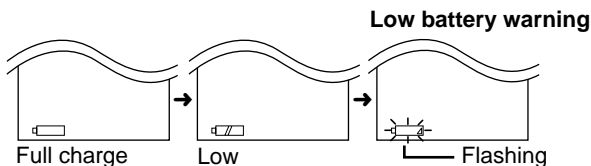

NOTE

- After the low battery warning appears, the DVD player shuts down. When this happens, replace the battery pack with a charged one or switch to AC adapter power.

CAUTION:

When battery power is low, power may suddenly turn off when you change to another operation mode (DVD, INPUT, etc.). When this happens, replace the battery pack with a charged one or switch to AC adapter power.



Turning Power On and Off

To turn main power on and off

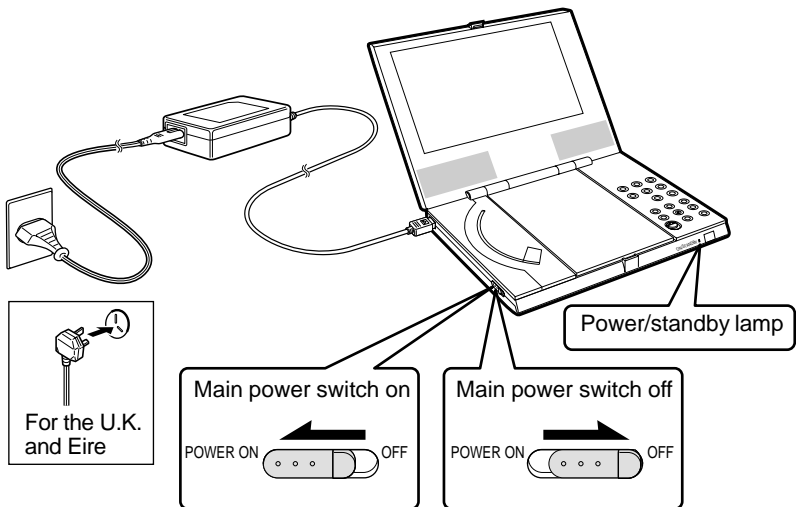

- Slide the main power switch left to the “ON” position to turn power on.
- Slide the main power switch right to the “OFF” position to turn power off.
- In the following cases, the power/standby lamp on the front of the DVD player lights green to let you know that power is on. This helps to ensure you do not forget and leave power on.
 - ① When the display panel is closed with main power turned on
 - ② When the backlight setting is “OFF” (see page 82)

NOTE

- When not in use, unplug the AC adapter from the power outlet.



To turn power on and off with the remote control unit

When the main power switch is in the "ON" position, you can turn power off and on by pressing **OPERATE**.

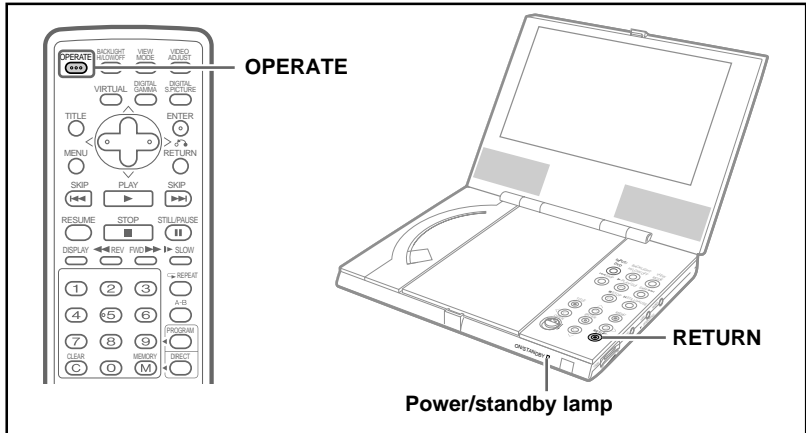

1 Press **OPERATE**.

- Each press of **OPERATE** toggles power on and off.
- Pressing **OPERATE** does not turn on power if the main power switch is in the "OFF" position.
- After DVD player power is turned off using **OPERATE**, the power/standby lamp is red to indicate the DVD player is in the Standby mode.

Standby mode

In the Standby mode, the power/standby lamp is red, regardless of whether the display panel is open or closed. The DVD player goes into the Standby mode when either of the following happens.

- When you press **OPERATE**
- When disc play is stopped for about five minutes in the DVD mode

To restore full power from the Standby mode, press **RETURN** on the player, slide the main power switch to the "OFF" position and then back to "ON" again, or press **OPERATE**.



Using the Remote Control Unit

To load batteries

For information about how to load the batteries, see page 17.

Remote control unit operating range



Important!

- Do not subject the remote control unit to strong impact.
- Do not allow the remote control unit to become wet and keep it out of areas subject to high humidity.

NOTE

- The remote control unit may fail to work properly after you replace its batteries. When this happens, remove the batteries and leave them out for at least five minutes. Next, reload the batteries and try again.
- The remote control unit may not work properly if the remote sensor of the DVD player is in direct sunlight or other strong light. Change the orientation of the light or the DVD player and try again.

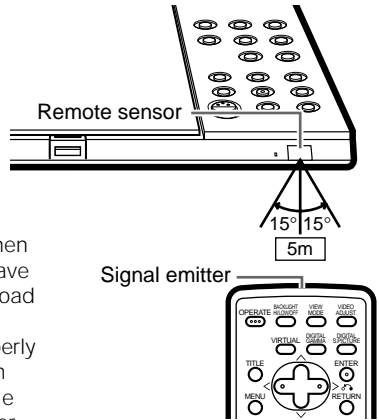

Improperly using batteries can cause them to leak. Note the following precautions when using batteries.



CAUTION

- Make sure the positive \oplus and negative \ominus ends of the batteries are facing correctly.
- Never mix batteries of different types.
- Never mix new batteries with old ones. Doing so reduces the life of the new batteries and can cause the old batteries to leak.
- Do not leave dead batteries in the remote control unit. Touching fluid leaking from batteries can cause skin irritation. Clean out any leaked fluid with a cloth, taking care not to get any on your fingers.

NOTE

- The batteries that come with the DVD player discharge slightly during shipping and storage. You should be able to get about six months to one year of operation from the supplied batteries.
- If you do not plan to use the remote control unit for a long time, remove its batteries.



Operation Modes

Your DVD player has two operation modes. Select the one that suits the operation you want to perform.

- DVD mode for disc playback
- INPUT mode for input from external equipment

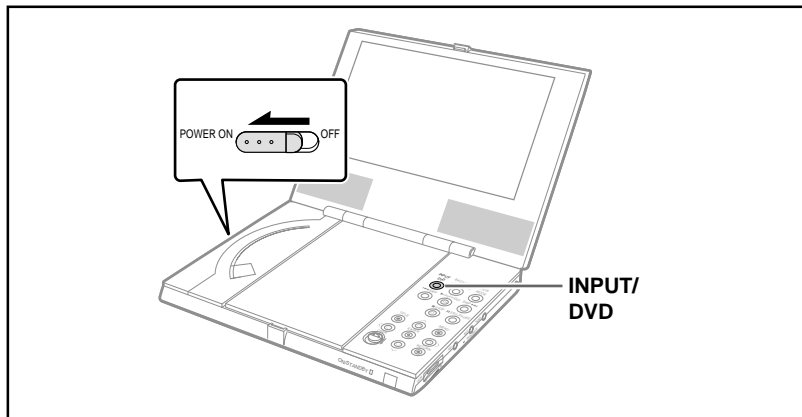

To select an operation mode

- 1 Slide the main power switch towards "ON" to turn on power.
- 2 Press **INPUT/DVD**.
 - Each press of **INPUT/DVD** toggles between the DVD mode and the INPUT mode.

DVD Mode



INPUT Mode

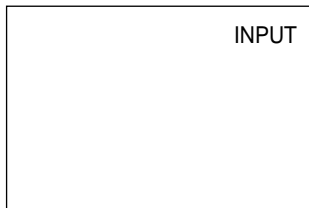



Setup

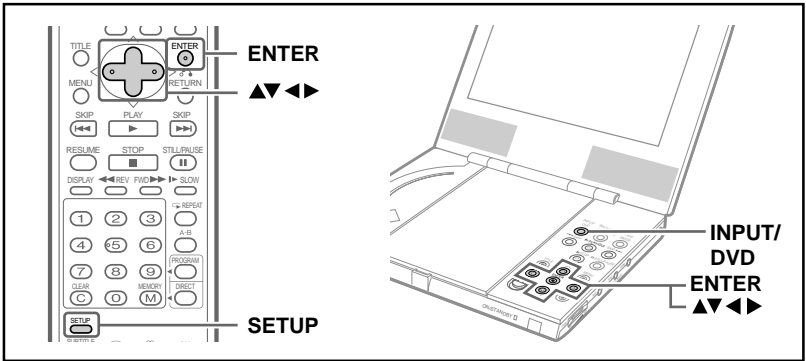

Setting the language

- 1 Press **INPUT/DVD** a number of times until you enter the DVD mode.
- 2 Press **SETUP**. DVD SET UP screen appears.

CAUTION:

When you use the DVD player for the first time, press **SETUP**. OSD LANGUAGE SET UP screen in the Step 3 appears. You should set the language to be used for the "OSD LANGUAGE SET UP". (7 languages)

- 3 Use **▲** or **▼** to move the cursor (**➡**) to "OSD LANGUAGE SET UP" and use **◀** or **▶** to display OSD LANGUAGE SET UP screen.
- 4 Select the language with **▲**, **▼**, **◀**, **▶**.
Example: ESPAÑOL

- 5 Press **ENTER** to register the setting. The Spanish DVD SET UP screen appears.

- 6 If you want to complete the settings here, press **ENTER** to exit the setup procedure.

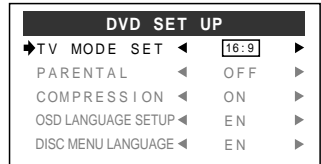



TV MODE SET setting

The following describes how to select the DVD playback display format.

Viewing on the DVD Player Screen or a Wide Screen TV

Using a 16:9 Wide Image

Select **16:9** for wide DVD video output.

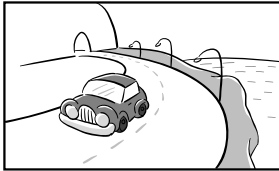

- A wide image size is output when playing a wide image disc.
- When playing a 4:3 image disk, you can select the image size you want for the DVD player screen or connected TV (see page 52).

Viewing on a 4:3 Size TV

Using Pan Scan

Select **4:3** **PS** for wide DVD video output.

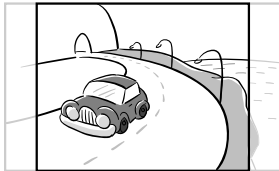

When playing a wide image disc, the left and right sides of the image are cut (pan scan) to output a natural-looking 4:3 size image. A wide image disc without pan scan **PS** is played back in letter box. A 4:3 disk is played as-is in 4:3.

Using Letter Box

Select **4:3** **LB** for wide DVD video output.

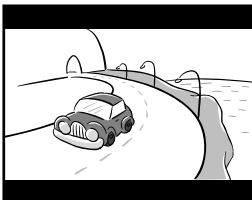

When playing a wide image disc, black bands are inserted at the top and bottom and a 4:3 size image is output. A 4:3 disk is played as-is in 4:3.



Setup

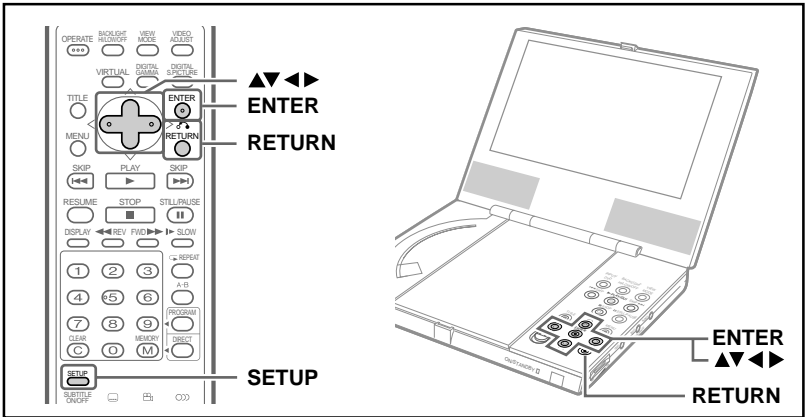

To make TV MODE SET setting

- 1 Press **SETUP**.
 - This displays the DVD SET UP screen.
- 2 Use **▼** and **▲** to select "TV MODE SET".
- 3 Use **◀** and **▶** to select the screen type (see page 43).
- 4 Press **ENTER** to register the setting.
 - This returns to the startup screen.



NOTE

- Never open the DVD SET UP screen while a playback operation is in progress. If a disc is playing, stop playback first.
- If you select 16:9 while a 4:3 TV is connected, playing a 16:9 disc displays a vertical image screen. (Black bands appear at the top and bottom of the screen.)

Helpful Hints

- To exit the DVD SET UP screen and return to the startup screen, press **RETURN**.



PARENTAL setting

Parental level

DVD discs equipped with the parental lock function are rated according to their content. The rated content allowed by a parental lock level and the way a DVD disc can be controlled may vary from disc to disc. For example, if the disc allowed you to edit out violent scenes unsuitable for children and replace them with more viewable scenes, or lock out play of the DVD disc altogether.

NOTE

- You can use the parental lock function only with DVD discs that are equipped with the parental lock feature.

DVD player parental level settings

Level 1: for general viewing (highly restricted level that can be viewed by anyone. Sensational scenes are cut or replaced with other scenes.) → Level 8: for adults only (a level to be viewed by adults only. Unrestricted view of any scene)

(The smaller the number, the greater the level of restriction.)

NOTE

- When "PARENTAL" is set to "OFF", DVD discs can be played back regardless of the parental level. The factory default setting is "OFF".

Passwords

The parental level setting of the DVD player can be protected by a password against unauthorized changes. Once you set a password, it must be input to perform the following operations.

- To change the parental level
- To temporarily change the parental level during playback



To make PARENTAL setting

- 1 Press **SETUP**.
 - This displays the DVD SET UP screen.
- 2 Use **▼** and **▲** to select "PARENTAL". Press **▶**.

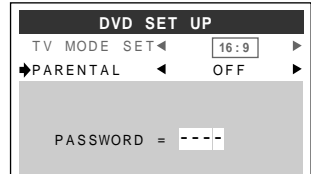

- If there is no password registered yet, the password input field appears as **□ □ □ □** instead of **□ □ □ □**.

- 3 Use the number buttons to input the password.



- 4 Use **◀** and **▶** to select the parental level and then press **ENTER**.
 - This returns to the startup screen.

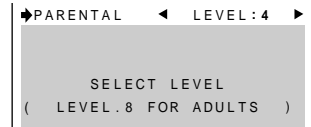

Repeat steps 1 through 4 above whenever you want to change the parental level.

NOTE

- The first time you input a new password, the DVD player will prompt you to input it a second time for confirmation. The password you input is registered automatically, and you will have to input it each time you change the parental level in the future.
- You must input the correct password to make any changes in the parental level. Be sure to keep a separate record of your password somewhere for later reference.
- Some DVDs allow the viewer to temporarily change the parental level setting to view the original scenes. When this prompt appears, input the password to view the original scenes.

Helpful Hints



- The illustration on page 44 shows the buttons used in this procedure.

If you forget your password, press **■STOP** four times instead of inputting numbers in step 3 of the procedure. This clears the currently set password.

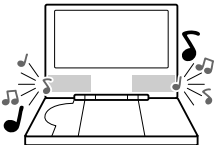
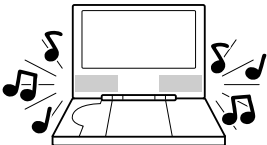

COMPRESSION (Dolby Digital Output Level) setting

When Dolby Digital is used to record the audio on a DVD disc, the average overall volume level of the audio is relatively lower than that produced by an audio CD. This is to provide the widest possible dynamic range. To counteract this, your DVD player automatically raises the overall average volume level of a disc recorded using Dolby Digital to a level that is similar to that of an audio CD.

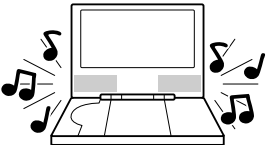
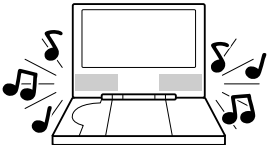
	COMPRESSION: OFF	COMPRESSION: ON
 DVD Dolby Digital audio	 • Low audio level	 • Audio level the same as audio CD
 Audio CDs		

- OFF Audio level recorded on disc is played back without modification.
- ON Dolby Digital average audio level is increased so it sounds similar to that of an audio CD.

Helpful Hints

- Use of the "OFF" setting is recommended when the DVD player is connected to audio equipment.
- The factory default setting is "ON".



Setup

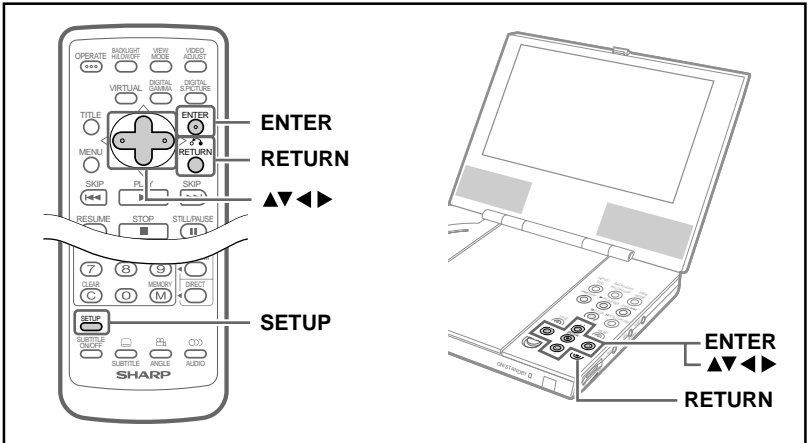

To set the COMPRESSION (Dolby Digital Output Level)

1 Press **SETUP**.
• This displays the DVD SET UP screen.

2 Use **▼** and **▲** to select "COMPRESSION".

DVD SET UP		
TV MODE SET	16:9	▶
PARENTAL	OFF	▶
◆COMPRESSION	ON	▶

3 Use **◀** and **▶** to select the setting you want.
• Each press of **◀** or **▶** toggles between "OFF" and "ON".

DVD SET UP		
TV MODE SET	16:9	▶
PARENTAL	OFF	▶
◆COMPRESSION	OFF	▶

4 Press **ENTER**.

Helpful Hints

• To exit the DVD SET UP screen and return to the startup screen, press **RETURN**.

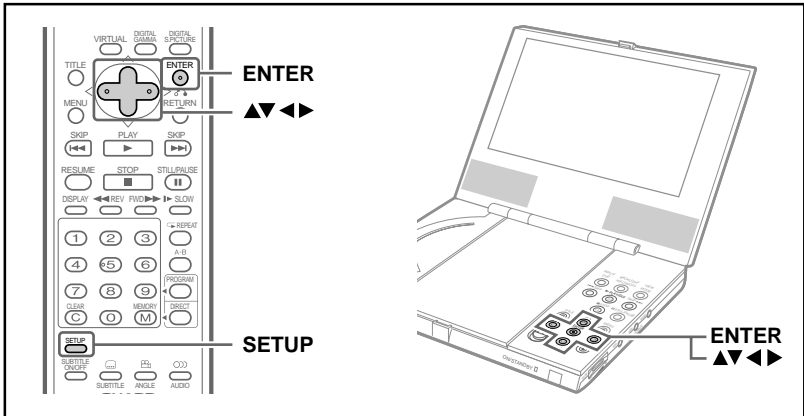

Use this setting for selecting disc menu languages recorded on a disc.

DISC MENU LANGUAGE setting

Selecting 7 languages from DISC MENU LANGUAGE

- 1 Press **SETUP** to display the DVD SET UP screen.
- 2 Use **▲** or **▼** to move the cursor (➡) to "DISC MENU LANGUAGE".
- 3 Use **◀** or **▶** to display the DISC MENU LANGUAGE screen.
- 4 Select the language you want to use with **▲**, **▼**, **◀**, **▶** and press **ENTER**.
Example: ESPAÑOL

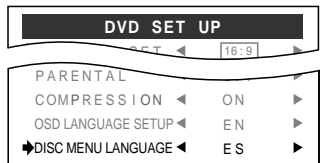
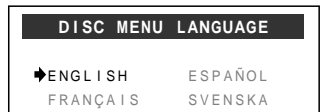
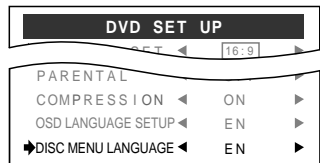



Selecting languages from OTHER

- Use ▲, ▼, ◀, ▶ to select "OTHER", then press **ENTER** to set the "OTHER" input item (two letters).



- For example, to select "AF" (Afrikaans), use ▲ or ▼ to select "A" as the first letter, use ◀ or ▶ to move to the second place, then use ▲ or ▼ to select "F".

NOTE

- When "A" is selected for the first letter, only letters to the right of codes beginning with "A" can be selected as the second letter. Refer to the codes beginning with "A" on the language code list on menu screen (see next page).
Example: First letter – A
Second letter – A, B, F, M, R, S, Y or Z

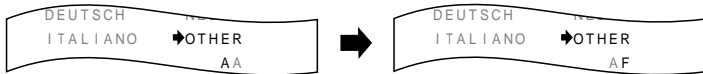

- Press **ENTER** to return to the DVD SET UP screen.

NOTE

- Some discs allow disc menu language setting from the disc menu. See page 78 for more information.
- Some discs will not allow the menu language to be changed.

MPEG OUT setting

Simultaneous output of an analogue and digital audio signal is not possible for the AUDIO/DIGITAL OUT (OPTICAL) when playing MPEG 5.1 channel software. As a result, 2-channel analogue output will not be possible at the time of digital 5.1 channel output. To this end, it will be necessary to set either a digital output of the MPEG audio or an analogue output using MPEG OUT on the DVD SET UP screen.

- Use ▲ and ▼ to select "MPEG OUT".



- Use ◀ and ▶ to select the setting you want, and then press **ENTER**.

TV setting: Set this when using the analogue output of the MPEG audio (e.g., TV 2-channel stereo).

AMP setting: Set this when using MPEG multiplex audio with a digital connection to the amplifier. (The 2-channel analogue output is not possible at this time)

- Press **ENTER** to exit the setup procedure. The startup screen then appears.

**Language code list on menu screen**

Code	Language Name	Code	Language Name	Code	Language Name	Code	Language Name
AA	Afar	FY	Frisian	MG	Malagasy	SL	Slovenian
AB	Abkhazian	GA	Irish	MI	Maori	SM	Samoa
AF	Afrikaans	GB	Scots Gaelic	MK	Macedonian	SN	Shona
AM	Ameharic	GL	Galician	ML	Malayalam	SO	Somali
AR	Arabic	GN	Guarani	MN	Mongolian	SQ	Albanian
AS	Assamese	GU	Gujarati	MO	Moldavian	SR	Serbian
AY	Aymara	HA	Hausa	MR	Marathi	SS	Siswat
AZ	Azerbaijani	HI	Hindi	MS	Malay	ST	Sesotho
BA	Bashkir	HR	Croatian	MT	Maltese	SU	Sundanese
BE	Byelorussian	HU	Hungarian	MY	Burmese	SV	Swedish
BG	Bulgarian	HY	Armenian	NA	Nauru	SW	Swahili
BH	Bihari	IA	Interlingua	NE	Nepali	TA	Tamil
BI	Bislama	IE	Interlingue	NL	Dutch	TE	Telugu
BN	Bengali; Bangla	IK	Inupiak	NO	Norwegian	TG	Tajik
BO	Tibetan	IN	Indonesian	OC	Occitan	TH	Thai
BR	Breton	IS	Icelandic	OM	(Afan) Oromo	TI	Tigrinya
CA	Catalan	IT	Italian	OR	Oriya	TK	Turkmen
CO	Corsican	IW	Hebrew	PA	Panjabi	TL	Tagalog
CS	Czech	JA	Japanese	PL	Polish	TN	Setswana
CY	Welsh	JI	Yiddish	PS	Pashto, Pushto	TO	Tonga
DA	Danish	JW	Javanese	PT	Portuguese	TR	Turkish
DE	German	KA	Georgian	QU	Quechua	TS	Tsonga
DZ	Bhutani	KK	Kazakh	RM	Rhaeto- Romance	TT	Tatar
EL	Greek	KL	Greenlandic	RN	Kirundi	TW	Twi
EN	English	KM	Cambodian	RO	Romanian	UK	Ukrainian
EO	Esperanto	KN	Kannada	RU	Russian	UR	Urdu
ES	Spanish	KO	Korean	RW	Kinyarwanda	UZ	Uzbek
ET	Estonian	KS	Kashmiri	SA	Sanskrit	VI	Vietnamese
EU	Basque	KU	Kurdish	SD	Sindhi	VO	Volapük
FA	Persian	KY	Kirghiz	SG	Sangho	WO	Wolof
FI	Finnish	LA	Latin	SH	Serbo- Croatian	XH	Xhosa
FJ	Fiji	LN	Lingala	SI	Singhalese	YO	Yoruba
FO	Faroese	LO	Laothian	SK	Slovak	ZH	Chinese
FR	French	LT	Lithuanian			ZU	Zulu
		LV	Latvian, Lettish				



Screen Size Setting

When viewing a DVD on your DVD player screen, you select the screen size that best suits the image you are viewing.

To set the screen size

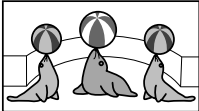
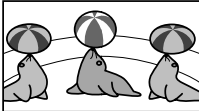
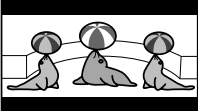
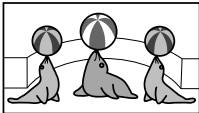
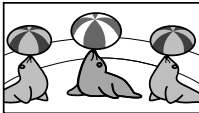
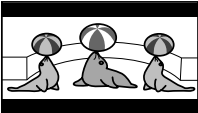
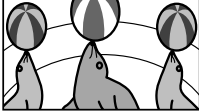
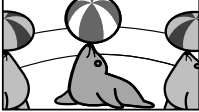
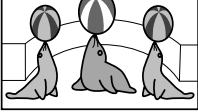
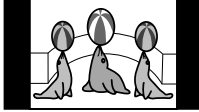
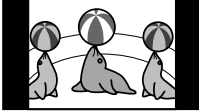
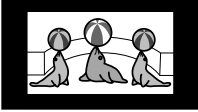
Software Type Mode	Wide	4:3	4:3 Letter Box
SMART STRETCH	Full Screen 	Image is stretched by its four corners. 	Image is stretched by its four corners. Top and bottom remain black. 
STRETCH	Full Screen 	Above screen stretched horizontally to fit. 	Screen stretched horizontally to fit. Top and bottom remain black. 
ZOOM	Top and Bottom Cut 	Above screen resized to fit, with top and bottom cut. 	Full Screen Screen stretched vertically to fit. 
SIDE BAR	Screen stretched vertically to fit. Left and right remain black. 	Left and right remain black 	Letter Box 

NOTE

- Using different screen size mode combinations from those shown above will produce images that are stretched horizontally or cut off at the top and bottom.

Helpful Hints

- The screen size mode automatically changes to STRETCH when you play a 16:9 wide image DVD with the "TV MODE SET" item of the DVD SET UP set to 16:9.

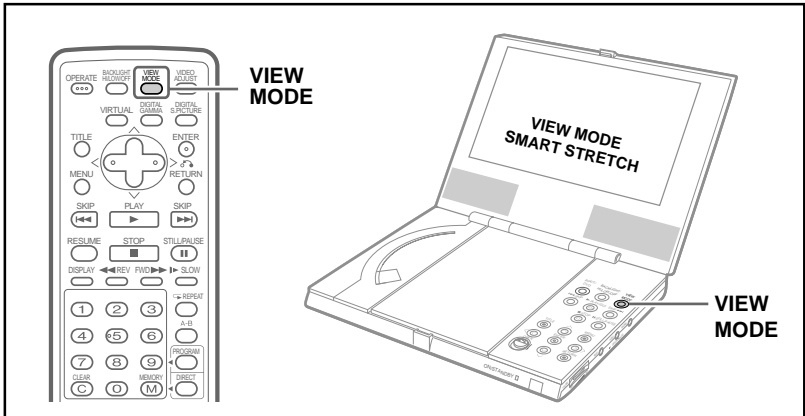

1 Press **VIEW MODE**.

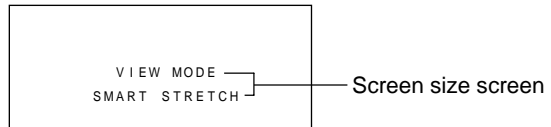

- Each press of **VIEW MODE** cycles through the screen size settings in the sequence: STRETCH → ZOOM → SIDE BAR → SMART STRETCH → STRETCH

NOTE

- The ZOOM mode uses a special process to stretch the image vertically. Compared with the original image, you may be able to notice some jagged lines or horizontal inside the stretched image. This does not indicate malfunction.



Changing the Display Mode

To change the display mode

1 Press **DISPLAY**.

- Each press of **DISPLAY** cycles through the display mode settings in the following sequence: ON → OFF → AUTO → ON.

AUTO Display indicators appear for about three seconds and then disappear.

ON Display indicators remain displayed.

OFF Display indicators are not displayed.

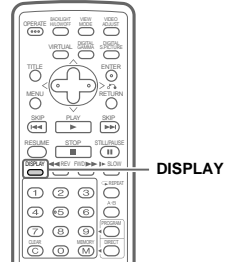

NOTE

- With some discs, chapter numbers and elapsed play time may not appear.

You can select "AUTO", "ON", or "OFF" as the display mode. The following shows what appears on the display when "AUTO" or "ON" is selected.

■ DVD Mode

DVD

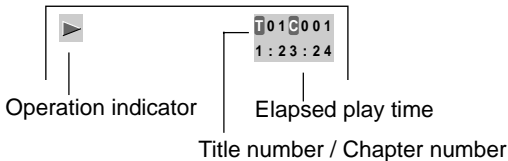

Video CD

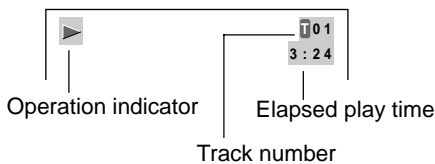

Audio CD

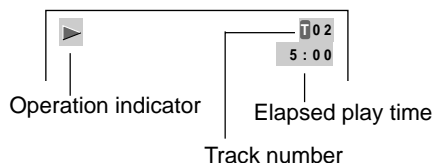



■ Audio Switching

DVD



Audio indicator (for Dolby Digital 5.1 channel)

Linear PCM 2ch

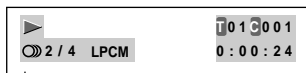

Audio indicator (for linear PCM 2ch)

Audio MPEG Version 2.0

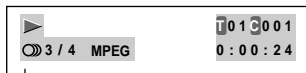

Audio indicator (for Audio MPEG Version 2.0)

Video CD, Audio CD



■ INPUT Mode





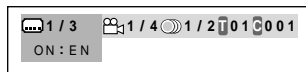







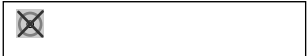
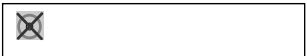
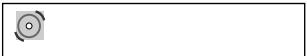

■ DVD Player GUI (DVD Mode)



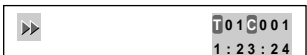

DVD mode operation indicators

The following are examples of display indicators that appear during DVD playback.

DVD Player Status	Display Indicators
Play attempted without a disc	
Play attempted with a non-compatible disc	
Loading (data being read from disc)	
Stop	
Play	  1 : 23 : 24 Appears when display mode is "ON".
Pause	  1 : 23 : 24 Appears when display mode is "ON".
Slow	  1 : 23 : 24 Appears when display mode is "ON".
Fast Forward	  1 : 23 : 24 Appears when display mode is "ON".
Fast Reverse	  1 : 23 : 24 Appears when display mode is "ON".



Playing a Disc

This DVD player can play a DVD, video CD, or audio CD using the procedure described below.

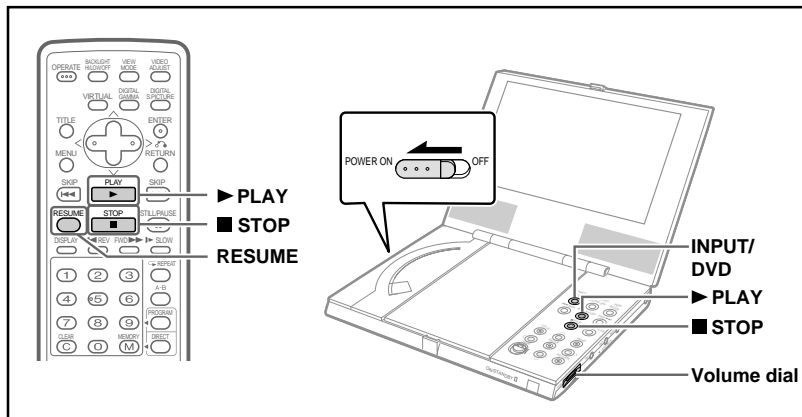

To play a disc

- 1 Slide the main power switch towards "ON" to turn on power.
- 2 Press **INPUT/DVD** a number of times until you enter the DVD mode.
- 3 Load the disc you want to play into the DVD player.
 - See page 20 for information about loading discs.
- 4 Press **▶PLAY**.
 - This starts disc play.



NOTE

- Wait to press **▶PLAY** until the startup screen appears (see page 21).

Helpful Hints

- If the disc you are using supports auto start, it starts to play automatically (even if you do not press **▶PLAY**), as soon as you close the disc compartment cover.



Playing a Disc

CAUTION



- Never try to open the disc compartment cover and look inside the disc compartment at the laser while a disc is playing. Doing so creates the danger of serious eye damage.



Important!

- Do not press down on the disc compartment cover while a disc is playing.
- Keep the disc compartment cover closed except when loading or removing a disc. Otherwise, dust getting into the DVD player can lead to malfunction.
- The indicator  appears on the display if the disc you are using is damaged, if you load the disc upside-down, or if the region number of the disc you are using is one that is not supported by this disc player. If the above indicator appears, remove the disc from the player and take the proper corrective action.

Helpful Hints

- Disc scratches, noise, or other factors can cause temporary problems with the video image from a DVD or video CD. If this happens, press **RESUME** to jump ahead to where play returns to normal.

To adjust the volume level

Rotate the volume dial on the right side of the DVD player to adjust the volume level of the audio within a range of 0 to 10.

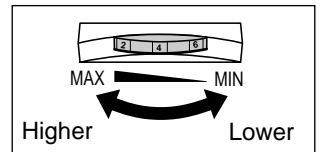

NOTE

- A safety feature automatically turns off DVD player power if you set the volume level too high while playing certain types of discs. If this happens, lower the volume level and restart play.

To stop disc play

- 1 Press  **STOP**.

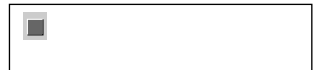

NOTE

- If you do not perform any operation for about five minutes after stopping disc play, indicator  disappears from the screen and the DVD player goes into its Standby mode.
- All buttons except **OPERATE** are disabled in the Standby mode.
- To restore full power from the Standby mode, slide the main power switch to the "OFF" position and then back to "ON" again, or press **OPERATE**.
- You can also restore full power from the Standby mode by pressing **RETURN** on the DVD player's control panel.



Other Disc Play Features

This section explains how to use skip, slow motion, and other play features.

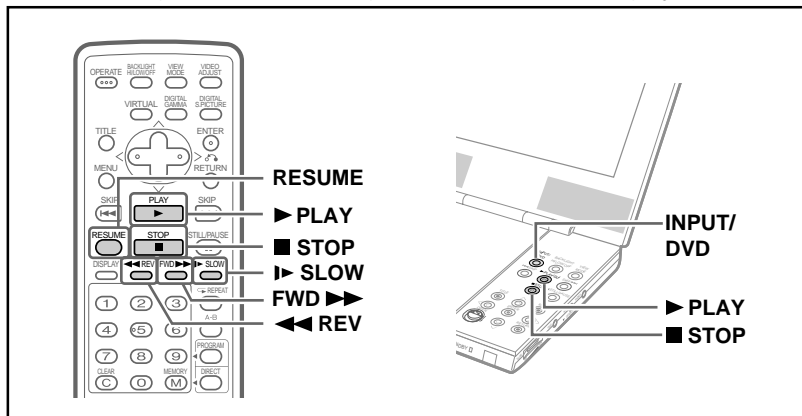

To resume disc play after stopping

- 1 While the disc is playing, press **■ STOP** at the location where you want to stop.
 - Leave the disc in the DVD player. The DVD player remembers the location where you stopped.
- 2 To restart play, press **RESUME**.
 - Play resumes from a point slightly before the point where it was stopped.

NOTE

- This resume operation does not work with PBC (playback control) play of a video CD with PBC.
- This resume operation may not work with certain types of discs.

This resume operation does not work in the following cases.

- If the main power switch is turned off after disc play is stopped.
- If the DVD player enters the Standby mode after disc play is stopped.
- If you change to the INPUT mode.
- If you remove the disc from the DVD player after disc play is stopped.
- If you display the DVD SET UP screen or disc menu screen after disc play is stopped.



To use fast forward and fast reverse

- 1 While a disc is playing, press **FWD▶▶** to start fast forward or **◀◀REV** for fast reverse.
 - Initially, the fast forward or fast reverse operation is performed at a relatively slow speed. With a DVD (but not an audio CD or video CD), you can press **FWD▶▶** or **◀◀REV** again to increase the speed.

Example: Display after **FWD▶▶** is pressed



- 2 Press **▶PLAY** to resume normal play.



NOTE

- You may not be able to use these operations with some discs.
- With a DVD, you cannot fast forward or fast reverse from one title to another. Normal play resumes when the beginning of a title is reached.
- Audio and subtitles are not played while fast forwarding or fast reversing with a DVD or video CD.

To use slow motion (DVD only)

- 1 While a disc is playing, press **▶SLOW**.



- 2 To cancel slow motion and return to normal play, press **▶PLAY**.

NOTE

- You may not be able to use slow motion with some discs.
- Slow motion cannot be used with video CDs or audio CDs.

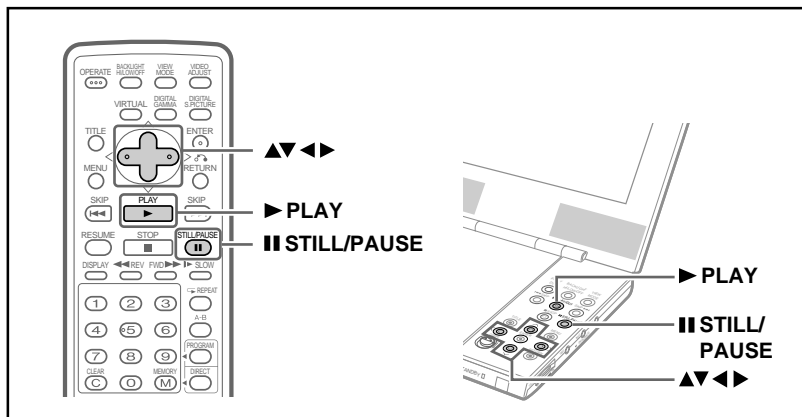

To use still picture and frame advance

- 1** While a disc is playing, press **|| STILL/PAUSE**.
 - This freezes the image on the screen.
 - Each press of **|| STILL/PAUSE** advances the frame.
- 2** To cancel still picture and return to normal play, press **▶ PLAY**.

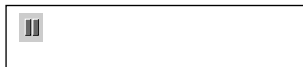

NOTE ▶

- You may not be able to use still picture and frame advance with some discs.
- Frame advance cannot be used with video CDs.

Helpful Hints

- This operation performs the audio CD PAUSE function.



Other Disc Play Features

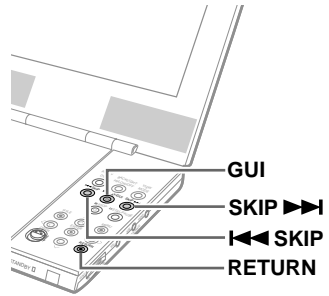
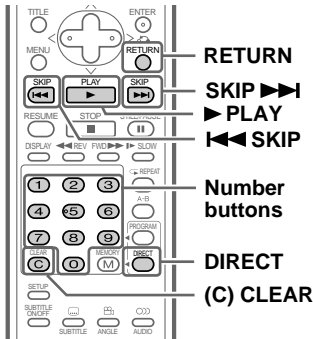

See page 79 for information about how to skip to a specific chapter (track) using the DVD player's **GUI**.

Chapter/track skip

- 1 While a disc is playing, press **SKIP ►►►** or **◄◄ SKIP**.



When using video CD PBC (playback control) play

- **SKIP ►►►** is the same as a NEXT button.
- **◄◄ SKIP** is the same as a PREVIOUS button.
- Pressing **RETURN** displays the previous menu screen.



NOTE

- Operation depends on the video CD type.
- You may not be able to use chapter (track) skip with certain discs.

Helpful Hints

- **SKIP ►►►** skips to the next chapter (track).
- **◄◄ SKIP** skips to the beginning of the current chapter (track). Press **◄◄ SKIP** again to skip to the beginning of the previous chapter (track).



Title/track direct skip

You can use direct skip only with a disc that is playing or that was playing but it now stopped.

In the case of a video CD or audio CD, start from step 2.

- 1 While the disc is playing or stopped, press **DIRECT**.
- 2 Use the number buttons to input the number of the title (track) to which you want to skip.

Example: Press **3**.



- 3 Press **▶PLAY**.
 - You must press **▶PLAY** within about 10 seconds after inputting a number.

NOTE

- You may not be able to use direct skip with certain discs.
- Direct skip does not work immediately after you load a disc into the DVD player or when the DVD player is in the Standby mode. It can be used only after the disc has been played, even if only partially.

Helpful Hints

- If you are playing a video CD or audio CD, input a track number.
- If you make a mistake while inputting a number, press **C** (CLEAR) and try again.

Chapter direct skip (DVD only)

- 1 While the disc is playing, press **DIRECT** twice.
- 2 Use the number buttons to input the number of the chapter to which you want to skip.

Example: Press **3**.



- 3 Press **▶PLAY**.
 - You must press **▶PLAY** within about 10 seconds after inputting a number.

NOTE

- You cannot skip to a chapter with a video CD or audio CD.
- With certain DVDs, the chapter number may not appear on the display.
- Some DVDs may partially disable the direct skip function.

Helpful Hints

- If you make a mistake while inputting a number, press **C** (CLEAR) and try again.



Repeat Playback

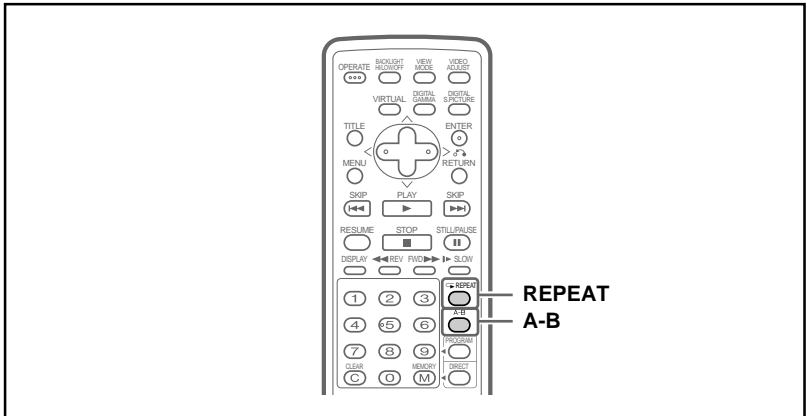

Chapter repeat (DVD only)

Example: To repeat play the chapter you are currently viewing

- 1 Play the chapter you want to repeat.
- 2 Press **REPEAT** to start repeat play of the chapter.
 - To cancel repeat play, press **REPEAT** again. This clears the "⏮⏮" indicator from the display.



NOTE

- You may not be able to use repeat play with certain discs.

Title repeat (DVD only)

Example: To repeat play the title you are currently viewing

- 1 Play the title you want to repeat.
- 2 Press **REPEAT** twice to start repeat play of the title.
 - To cancel repeat play, press **REPEAT** again. This clears the "⏮" indicator from the display.



NOTE

- You may not be able to use repeat play with certain discs.



Disc repeat (video CD, audio CD only)

Example: To repeat play a disc

- 1 While the disc is playing, press **REPEAT** to start repeat play.
 - To cancel repeat play, press **REPEAT** again. This clears the "⏮" indicator from the display.



NOTE

- You cannot use repeat play with PBC (playback control) play of a PBC video CD.
- You may not be able to use repeat play with certain discs.
- You cannot use repeat play in combination with programmed play.

A-B repeat (DVD only)

Example: To repeat the scene from 0:01:00 to 0:02:00 in Chapter 1 of Title 1

- 1 When play reaches the start point of the scene, press **A-B**.
 - This registers the location at the start point (A).
- 2 When play reaches the end point of the scene, press **A-B** again.
 - This starts A-B repeat from the start point (A) and the end point (B).
 - To cancel A-B repeat, press **A-B** again. This clears the "A⏮B" indicator from the display.



NOTE

- The start point and end point must be inside the same chapter.
- A-B repeat cannot be used with a video CD or audio CD.
- A-B repeat cannot be used with some multi-angle functions (see page 74).

Helpful Hints

- A-B repeat is cancelled whenever you press **STOP**, **TITLE**, or **MENU**.



Programmed Playback

You can program your DVD player to play titles, tracks, or chapters in the sequence you want.

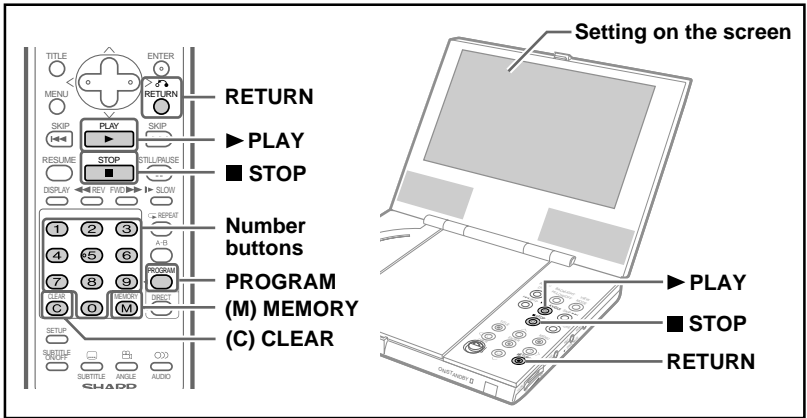

Title/Track programmed playback

This function can be used only with a disc that has been played once, even partially.

- 1 Turn on the DVD player, start play of the disc, and then stop play. Next, press **PROGRAM**.

DVD

- Pressing **PROGRAM** displays the title programming screen.

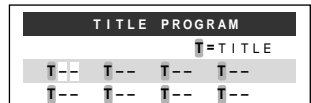

Video CD, Audio CD

- Pressing **PROGRAM** displays the track programming screen.

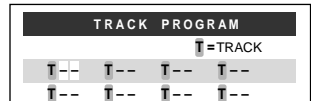

- Press **RETURN** if you want to exit the above screens.

NOTE

- You cannot program the play sequence while a disc is playing.
- Play sequence programming does not work with a disc that does not include title (track) information.
- Play sequence programming does not work with a disc that disables programming. Such discs marked with the indicator
- Play sequence programming does not work immediately after you load a disc into the DVD player or when the DVD player is in the Standby mode. It can be used only after the disc has been played, even if only partially.



- Use the number buttons to input the title number or track number you want, and then press **M** (MEMORY).

Example: To input Title (Track) 10, press **1**, **0** and then **M** (MEMORY).

DVD

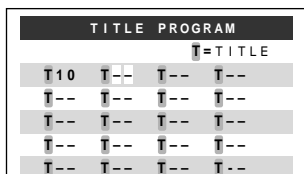

Video CD, Audio CD

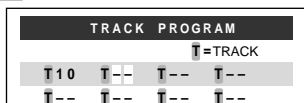

- Repeat step 2 for up to 20 titles (tracks) in the sequence that you want them to play.
- Press **▶PLAY** to start play in the sequence you specified.
 - Titles (tracks) are played in the sequence you specified.



To stop programmed play

- Press **■ STOP**.

Helpful Hints

- The number you input is not stored in memory if there is no corresponding title (track) number on the disc. Make sure you input title (track) numbers correctly.
- If you input the wrong number, press **C** (CLEAR) and then re-input.
- Holding down **C** (CLEAR) for about two seconds clears all the program data in memory.
- To exit the programming procedure part way through, press **RETURN**.
- You can also input one-digit numbers in step 2. To input 2, for example, press **2** and then **M** (MEMORY).



Programmed Playback

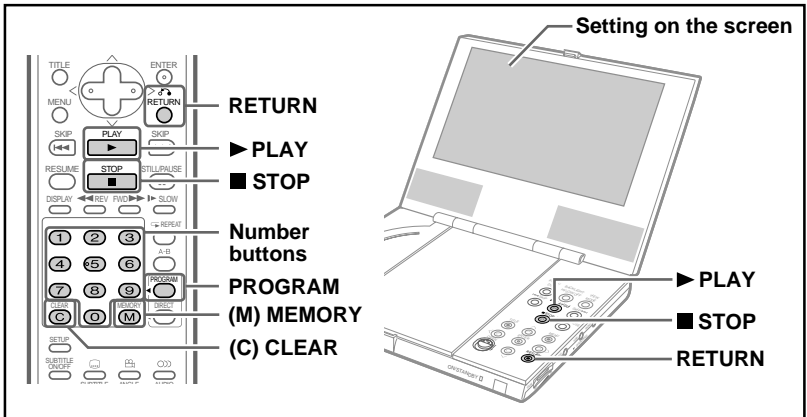

If you have a DVD that includes chapter data, you can program your DVD player to play chapters in the sequence you want.

Chapter programmed playback (DVD only)

This function can be used only with a disc that has been played once, even partially.

- 1 Turn on the DVD player, start play of the disc, and then stop play. Next, press **PROGRAM** twice.
 - This displays the chapter programming screen.
 - Press **RETURN** if you want to exit the above screen.
- 2 Use the number buttons to input the title number you want, and then press **M** (MEMORY).

Example: To input Title 10, press **1, 0** and then **M** (MEMORY).

CHAPTER PROGRAM			
T=	TITLE: 10	C=	CHAPTER
C	--	C	--
C	--	C	--
C	--	C	--

NOTE

- You cannot program the play sequence while a disc is playing.
- Play sequence programming does not work with a disc that does not include chapter information.
- Play sequence programming does not work with a disc that disables programming. Such discs marked with the indicator .
- Play sequence programming does not work immediately after you load a disc into the DVD player or when the DVD player is in the Standby mode. It can be used only after the disc has been played, even if only partially.



- 3** Use the number buttons to input the chapter number you want, and then press **M** (MEMORY).

Example: To input Chapter 23, press **2, 3** and then **M** (MEMORY).

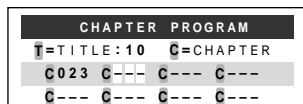

- Repeat step 3 for up to 20 chapters in the sequence that you want them to play.

- 4** Press **▶ PLAY** to start play in the sequence you specified.



To stop programmed play

- 1** Press **■ STOP**.

Helpful Hints

- The number you input is not stored in memory if there is no corresponding title number on the disc. Make sure you input title numbers correctly.
- If you input the wrong number, press **C** (CLEAR) and then re-input.
- Holding down **C** (CLEAR) for about two seconds clears all the program data in memory.
- To exit the programming procedure part way through, press **RETURN**.
- You can also input one-digit numbers in steps 2 and 3. To input 2, for example, press **2** and then **M** (MEMORY).



Making Display Settings

Digital gamma is a function that brings out the best that DVD has to offer by making darker areas of the image brighter while leaving its bright areas unchanged.

Digital super picture enhances the fine detail of the image and outlines of the objects it contains. It also minimizes noise, making the image clearer.

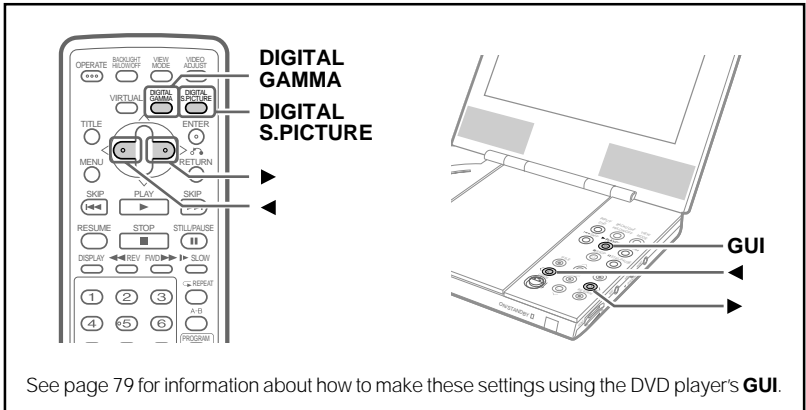

To make digital gamma settings (DVD, Video CD only)

- 1 Press **DIGITAL GAMMA**.
 - Each press of **DIGITAL GAMMA** cycles through the digital gamma settings in the following sequence: AUTO → ON → OFF.
 - The current setting is shown on the display.

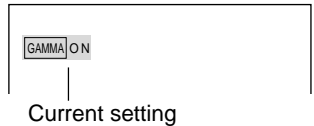

When you are playing the DVD image on an external monitor screen, the effect that digital gamma has on the image depends on whether the DVD player's display panel is open or closed.

Helpful Hints

- Digital gamma helps to add depth to movie and concert images that contain a lot of dark scenes, and when viewing images under bright light.



2 While "ON" is selected, use ◀ and ▶ to set the digital gamma level.

- The current level is shown on the display.

Bright ↔ Brighter
◀ ▶



- The level display remains on the screen for about 10 seconds.

Helpful Hints

- If the level setting disappears from the screen, you can change the level setting by pressing **DIGITAL GAMMA** to display it again. Next, use ◀ and ▶ to change the level.

To make digital super picture settings (DVD, Video CD only)

1 Press **DIGITAL S.PICTURE**.

- Each press of **DIGITAL S.PICTURE** toggles the digital super picture setting between "ON" and "OFF".
- The current setting is shown on the display.



2 While "ON" is selected, use ◀ and ▶ to set the digital super picture level.

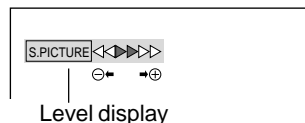

- The level display remains on the screen for about 10 seconds.

When you are playing the DVD image on an external monitor screen, the effect that digital super picture has on the image depends on whether the DVD player's display panel is open or closed.

Helpful Hints

- For greater image detail and sharper images, adjust the digital super picture setting so the indicator is more towards ⊕.
- To reduce the digital noise in older images and other images that contain noise, adjust the digital super picture setting so the indicator is more towards ⊖.
- Adjusting the digital super picture towards ⊕ for DVD play and ⊖ for video CD play is recommended for best image quality.
- If the level setting disappears from the screen, you can change the level setting by pressing **DIGITAL S.PICTURE** to display it again. Next, use ◀ and ▶ to change the level.



Audio Selection (DVD, Video CD only)

A number of different methods are used to record audio onto a DVD, including multi-channels (used for voiceovers in other languages), Dolby Digital (5.1ch), DTS, linear PCM and Audio MPEG Version 2.0. Your DVD player provides a number of different audio modes from which you can choose to suit the type of disc you are playing.

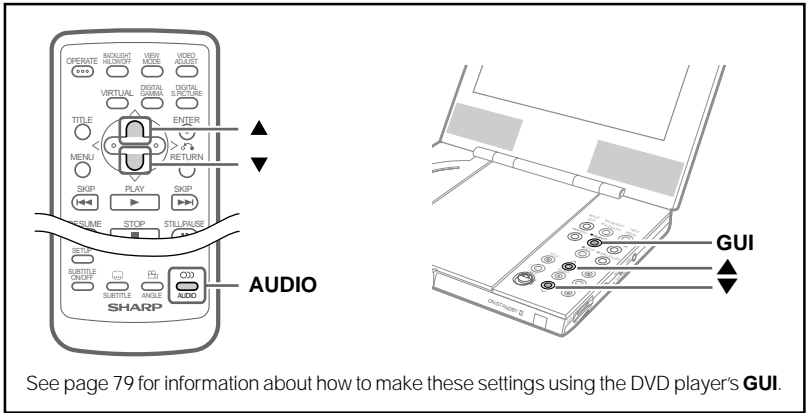

To select the audio channel for playback

1 While the disc is playing, press **AUDIO**.

Example: DVD with three audio channels

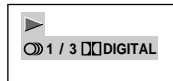

• The display shows which of the channels is currently selected.

Video CD

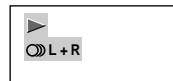

NOTE

• Some discs allow audio channel switching from the disc menu. See page 78 for more information.



Audio Selection (DVD, Video CD only)

- 2 Press **AUDIO** to cycle through the available channels and select the one you want.

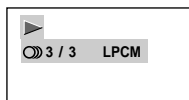

- In the case of a video CD or audio CD, each press of **AUDIO** cycles through the channels in the following sequence:
L+R → L → R.

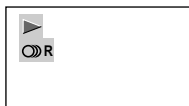
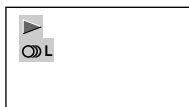

Helpful Hints

- With a DVD player, use ▲ and ▼ to scroll through the channel numbers.
- The channel number selection display remains on the screen for about 10 seconds.

To play DTS/MPEG audio using a DTS/Audio MPEG digital surround decoder

- 1 Connect the DVD player to the DTS/Audio MPEG digital surround decoder (see page 32).
- 2 Press **AUDIO** to select the DTS/MPEG mode.

NOTE

- You must use a DTS digital surround decoder (see page 32) in order to play DTS audio. Playing back a DTS audio disc on the DVD player alone will not produce correct audio output, even if you select the DTS mode.



Angle Selection (DVD only)

You can change the angle of view when playing a DVD that contains scenes recorded from multiple angles.

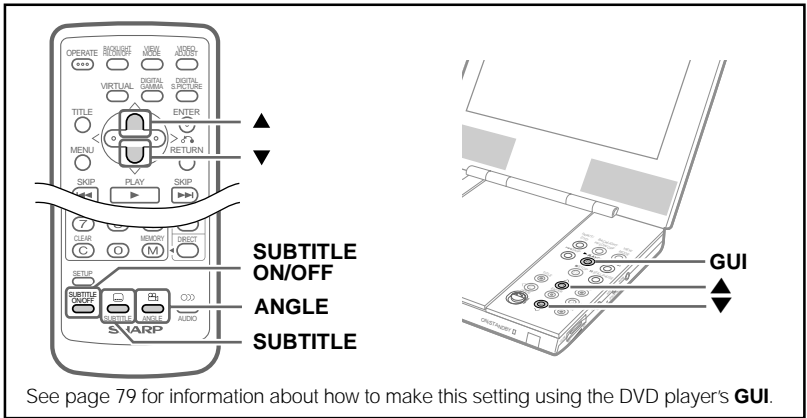

To change the view angle

- 1 While the disc is playing, press **ANGLE**.
 - This displays the currently selected view angle number.

Example: When there are five view angles

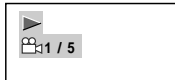

- 2 While the view angle numbers are on the screen, use **ANGLE** to select the one you want.
 - The number of the view angle you select is shown on the screen.

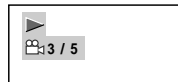

NOTE

- The angle number does not appear if the disc you are using has only one angle of view.
- The actual procedure for changing the view angle depends on the disc you are using. See the disc jacket for details.
- The view angle number remains on the display for about 10 seconds.



Subtitle Selection (DVD only)

You can use the following procedure to select the set of subtitles you want to use when the DVD you are playing includes subtitle sets for multiple languages.

To change the subtitle set

1 While the disc is playing, press **SUBTITLE**.

- This displays the currently selected subtitle set number.

Example: When there are three subtitle sets

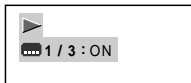

- If the disc does not have any subtitle data, **xx** appears in place of the subtitle set number.

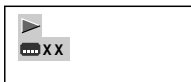

2 Select the number of the subtitle set you want.

- The number of the subtitle set you select is shown on the screen.

NOTE

- The subtitle set number does not appear if the disc you are using has only one set of subtitle.
- While the subtitle set numbers are on the display, use **▲** and **▼** to select the one you want.

To turn subtitling on and off

1 While the disc is playing, press **SUBTITLE ON/OFF** to toggle subtitling on and off.

- The subtitle set numbers remain on the screen for about 10 seconds.

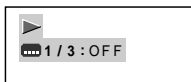



Using Dolby Virtual (DVD only)

- Your DVD player has built-in virtual surround circuitry that provides rich audio output when playing through a stereo (2-channel) television or through audio equipment.
- Dolby Virtual lets you play audio from DVDs recorded using Dolby Digital (5.1 channel) and Dolby Surround (Pro Logic).
- See the disc jacket for information about how its audio was recorded.

Dolby Virtual

The following table shows the types of audio recordings for which Dolby Virtual is enabled.

Dolby Digital (5.1 channel)	Dolby Surround (Pro Logic)	Linear PCM Audio/ DTS Audio	MPEG Audio Ver.2.0
Yes	Yes	No	No

- Dolby Virtual is disabled when the DVD player is connected to external equipment over an optical digital connection.

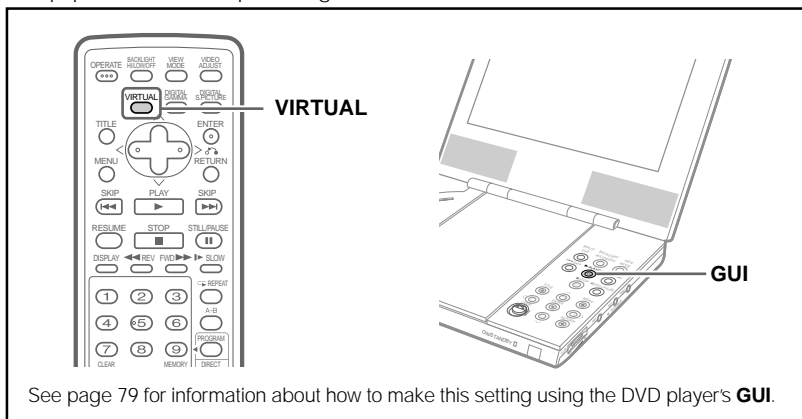

To turn Dolby Virtual on and off

- 1 While the DVD is playing, press **VIRTUAL**.
 - Each press of **VIRTUAL** toggles Dolby Virtual on and off.

VIRTUAL ON

NOTE

- Dolby Virtual cannot be used with a video CD or audio CD.
- Dolby Virtual is disabled during playback of a DVD recorded with DTS audio, linear PCM audio and Audio MPEG Version 2.0.
- The QSound  mark used by Dolby Virtual is a trademark of QSound Labs, Inc.



Selecting Titles from the Title Menu of a DVD (DVD only)

Some DVDs have a title menu that you use to select the title you want to play.

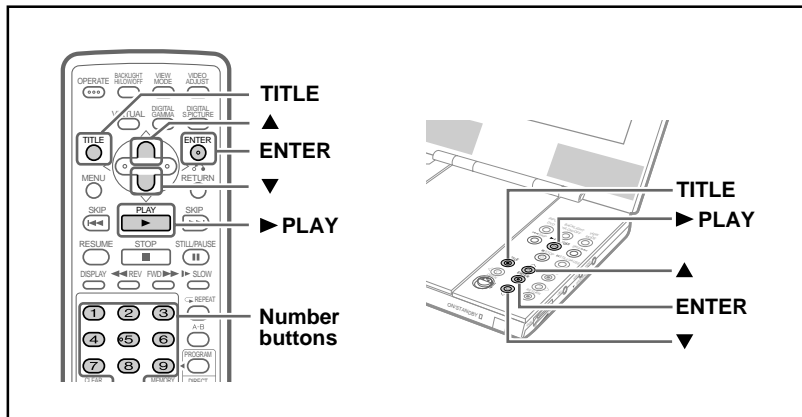

To select a title from the title menu of a DVD

This function can be used only with a disk that has been played once, even partially.

- 1 While the disc is playing or stopped, press **TITLE** to display its title menu.
- 2 Use **▲** and **▼** to select the title you want.
- 3 Press **ENTER** or **▶PLAY** to start play of the selected title.

NOTE

- Some DVDs use the term "top menu" instead of "title menu".
- Nothing appears on the screen when you press **TITLE** if the disc you are using does not have a title menu.
- The procedure shown here provides only general steps. The actual procedure for using the title menu depends on the disc you are using. See the disc jacket for details.
- The title menu does not appear immediately after you load a disc into the DVD player or when the DVD player is in the Standby mode. It appears only after the disc has been played, even if only partially.

Helpful Hints

- You can also specify a title by inputting a title number with the number buttons.



Setting Play Parameters Using the Disc Menu (DVD only)

Some DVDs include a disc menu that you can use to select subtitle set, audio channel, and Dolby Digital (5.1 channel) or DTS audio. You can also turn disc menu on and off.

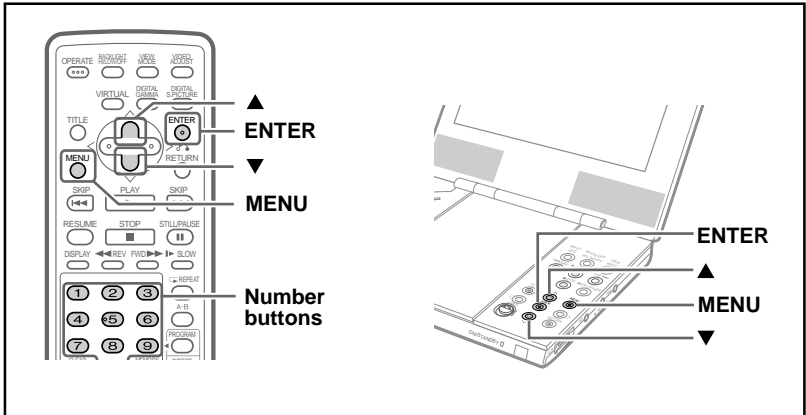

To use the disc menu to turn on subtitles

This function can be used only with a disk that has been played once, even partially.

- 1 While the disc is playing or stopped, press **MENU** to display the disc menu.
- 2 Use ▲ and ▼ to select the subtitle item on the disc menu.
- 3 Press **ENTER** to display the subtitle set number selection screen.
- 4 Use ▲ and ▼ to select the subtitle set you want to use.
- 5 Press **ENTER** to register your selection and display the subtitles.

Repeat the above procedure to make other disc menu settings.

NOTE

- The procedure shown here provides only general steps. The actual procedure for using the disc menu depends on the disc you are using. See the disc jacket for details.
- The disc menu does not appear immediately after you load a disc into the DVD player or when the DVD player is in the Standby mode. It appears only after the disc has been played, even if only partially.

Helpful Hints

- You can also select items by using the number buttons.



Settings from the DVD Player Control Panel (GUI)

Certain DVD settings must be made using the DVD player's control panel, and cannot be made using the remote control unit. Other settings can be made using either the remote control unit or the control panel.

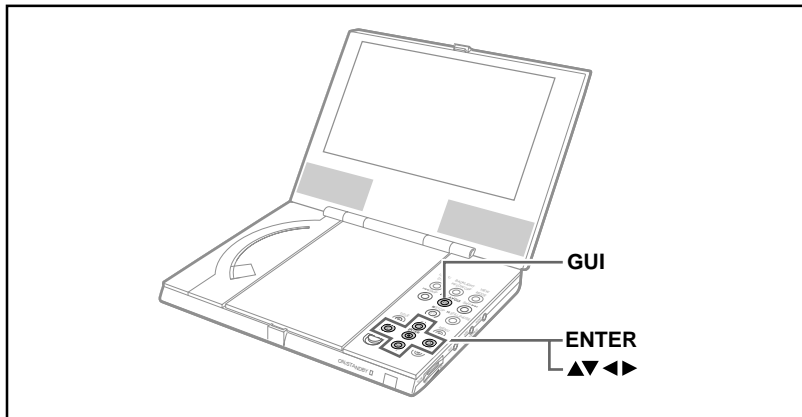

To make settings from the DVD player control panel

- While the disc is playing, press **GUI**.
 - Each press of **GUI** cycles through the setting screens in the sequence shown below.

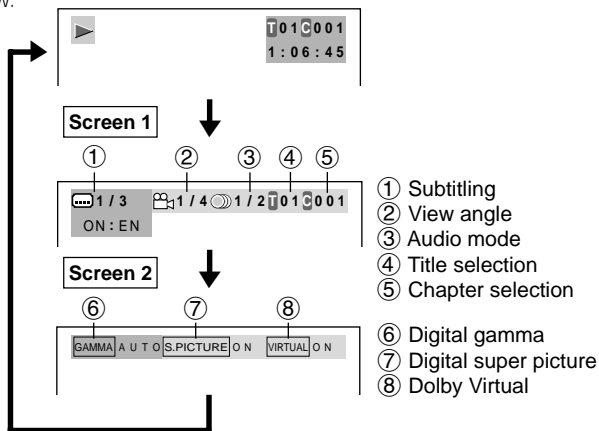

NOTE

- The setting screen disappears from the display if you do not perform any operation for about 10 seconds.
 - You can manually clear the setting screen by pressing **MENU** or **TITLE**.
- Download from www.Somanuals.com. All Manuals Search And Download.



Settings from the DVD Player Control Panel (GUI)

- 2 While “Screen 1” or “Screen 2” is on the display, use ◀ and ▶ to select the setting you want to change.

Example: View angle

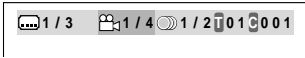

Example: Dolby Virtual



The icon of any function that is not supported by the disc you are using is replaced by **xx**.

- 3 Use ▼ and ▲ to change the selected setting.

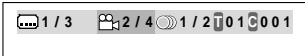

■ Digital Gamma Correction

- 4 Press **ENTER** to cycle through the available settings: AUTO → ON → OFF.
- 5 While the “ON” setting is displayed, use ▼ and ▲ to change the level setting.



■ Digital Super Picture

- 4 Use **ENTER** to toggle digital super picture on and off.
- 5 While the “ON” setting is displayed, use ▼ and ▲ to change the level setting.



- 6 After you are finished, press **GUI** to clear the setting screen from the display.
- Press **GUI** as many times as necessary to return to the normal operation screen.

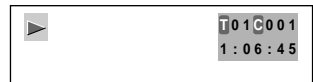

NOTE

- The setting screen is cleared automatically whenever you display a DVD screen that enables you to change the scene by pressing ▲, ▼, ◀ or ▶.
- The setting screen is cleared whenever you press **■STOP**, **TITLE**, or **MENU**.



Adjusting Display

Use the procedures described here to adjust the brightness and contrast of the colours that appear on the display, and the overall brightness of the display.

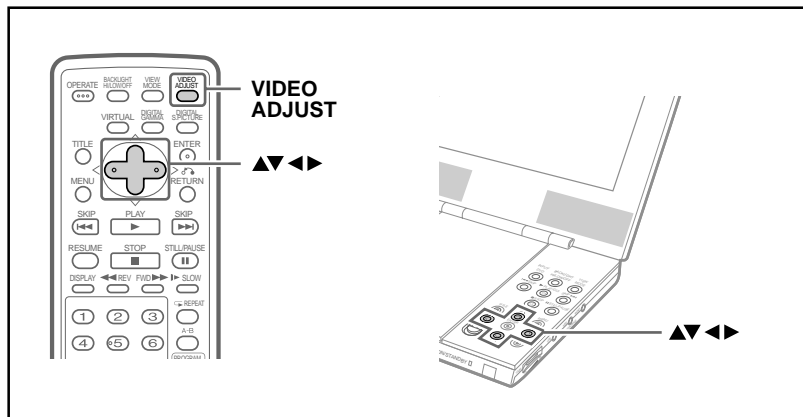

To adjust display colours

1 Press **VIDEO ADJUST**.

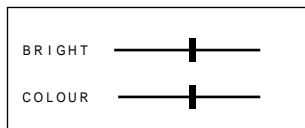

2 Use ▼ and ▲ to select the item whose setting you want to change.
• The colour of the selected item changes to indicate it is selected.

3 Use ◀ and ▶ to change the setting of the selected item.

Example: When selecting "COLOUR"

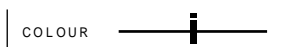

Helpful Hints

- BRIGHT Controls image colour brightness
- COLOUR .. Controls image colour contrast

4 After you are finished, press **VIDEO ADJUST**.

NOTE

- The setting screen disappears from the display if you do not perform any operation for about five seconds.
- The settings you make here are retained even when you turn off the DVD player.



Adjusting Display

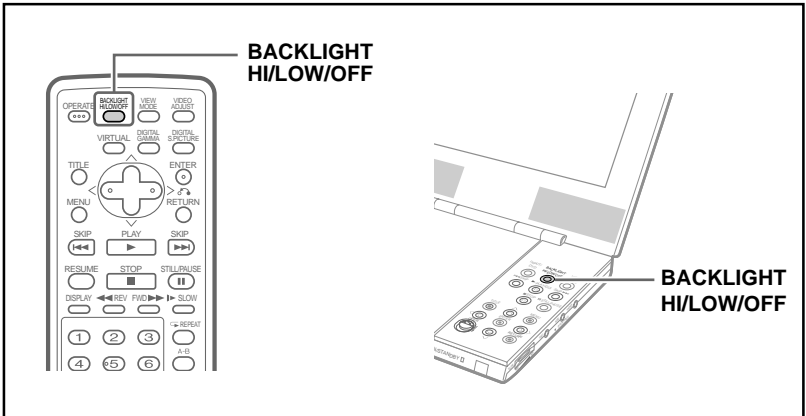

To adjust overall screen brightness

Use the following procedure to adjust the overall screen brightness level and to turn screen illumination on and off.

1 Press **BACKLIGHT HI/LOW/OFF**.

- Each press of **BACKLIGHT HI/LOW/OFF** cycles through the backlight settings in the following sequence:
HI → LOW → OFF → HI.

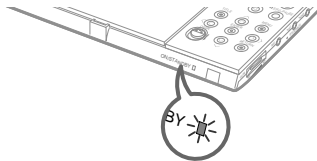

- The power/standby lamp of the DVD player lights green whenever the backlight is turned off.

NOTE

- The setting you make here is retained even when you turn off the DVD player.



Viewing Images from an External Device

Use the following procedure to set up the DVD player for use as a monitor for viewing images from a VCR or camcorder.

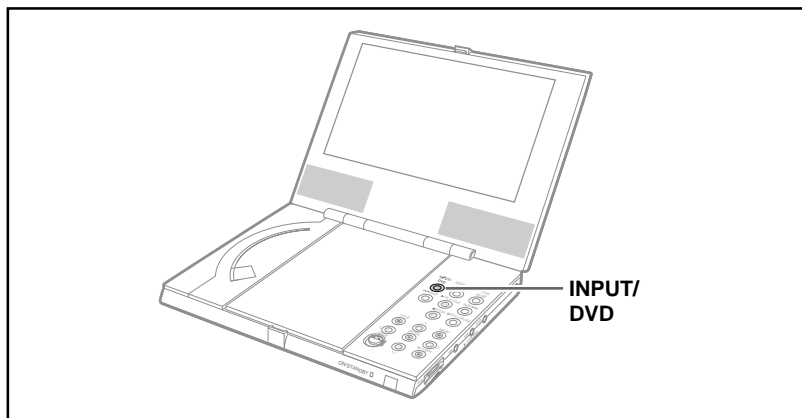

To view images from an external device

- 1 Connect the external device using the procedure on page 29.
- 2 Turn on the external device.
- 3 Turn on the DVD player.
- 4 Press **INPUT/DVD** to enter the INPUT mode.
- 5 Press the play button of the external device.

INPUT

NOTE

- Power is not supplied from the DVD player to a connected camcorder.
- When not using the DVD player with external equipment, be sure to disconnect all cords from the video input/output and audio input/output terminals.



References

Precautions

Use & Care

- **Avoid magnetic sources.**

Using the DVD player near strong fluorescent lights, motors, televisions, or other magnetic sources may adversely affect recorded images.

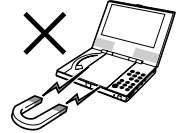

- **Remember to remove the disc, turn off the power when the DVD player is not in use.**

- **Using the DVD player near a broadcasting station or other powerful transmission source may cause buzzing or picture deterioration.**

- **Avoid shocks and dropping.**

Do not drop or otherwise subject the DVD player to hard shocks or strong vibrations.



- **Avoid placing the DVD player in close proximity to lighting equipment.**

The heat from incandescent lights may deform the DVD player, or cause it to malfunction.



- **Always respect prohibitions or restrictions on the use of electronic equipment on commercial flights or in other sensitive areas.**

- **Be aware of the temperature and humidity.**

You can use your DVD player at 0°C to +40°C and at 30% to 80% relative humidity. Do not store the unit in an unventilated car in the summer, in direct sunlight, or near strong heat sources; this can result in severe damage to the unit's casing and circuitry or in burning yourself.



- **Avoid situations where water, sand, dust or other foreign matter could get on or inside the DVD player, and do not use or leave your DVD player in areas with excessive smoke, steam or moisture.**

Such environments can cause malfunctions or cause mildew to form on the lenses. Be sure to keep the unit in a well-ventilated location.



- **When using your DVD player in a cold environment, the colour LCD screen often appears less bright immediately after the power is turned on.**

This is not a malfunction. To prevent the DVD player from becoming too cold, wrap it in a thick cloth (a blanket, etc.).

- **Never touch the pickup lens when installing or cleaning discs.**

This will cause the DVD player to malfunction.



- **Do not leave the DVD player on your lap for a long time during use.**
Heat generated by the DVD player can cause low-temperature burning of the skin over time.

Moving and shipment

- **Remove the disc before packing the DVD player for moving or shipment.**
It is also a good idea to remove the disc and turn off power whenever you are not using the DVD player.

Saving power

- **Help save power by turning off the DVD player when you are not using it. If you do not plan to use the DVD player for a long time (such as when leaving on a trip), unplug the power cord from the power outlet.**

Care of the LCD

- **To clean off the screen, turn off power and wipe the display with a soft cloth.**

About the LCD Panel

- The LCD panel is a product of the latest LCD manufacturing technology that provides a pixel yield of 99.99%. This means that less than 0.01% of the total number of pixels are defective (they do not turn on or always remain turned on).
- The fluorescent tube that provides backlighting of the screen requires periodic replacement. As a general rule, the life of the fluorescent tube is about 10,000 hours of continuous use under normal temperatures. If the display appears dark, if it flickers, or if it fails to light, contact your original retailer or your nearest Sharp service centre for replacement.

Copyright Information

- Unauthorized copying, broadcast, public display, transmission, public performance and rental (regardless of whether or not such activities are for profit) of disc contents are prohibited by law.
- This device is equipped with copy protection technology that causes substantial degradation of images when the contents of a disc are copied to video tape.
- This device is protected by U.S. patents and other intellectual property rights, the copyright for which belongs to Macrovision Corporation. The use of Macrovision's copy protection technology in the device is authorized by Macrovision and is intended for home use only, unless otherwise authorized in writing by Macrovision. Reverse engineering or disassembly is prohibited.
- This device was manufactured under license from Dolby Laboratories Licensing Corporation.
- Dolby, Dolby Digital, Dolby Pro Logic, and the double-D symbol () are trademarks of Dolby Laboratories Licensing Corporation.
- DTS is a trademark of Digital Theater Systems.



AC Adapter

- The supplied AC adapter is compatible with 50Hz and 60Hz electrical systems in the range of 110 V to 240 V AC.
- The AC adapter may interfere with reception if used near a radio.
- Prevent flammables, liquids, and metal objects from entering the adapter.
- The adapter is sealed unit. Do not attempt to open and modify it.
- Do not damage, drop, or subject the adapter to vibration.
- Do not leave the adapter in direct sunlight.
- Avoid using the adapter in humid or extremely hot places.

Care

Cleaning and Maintenance

- Many plastic parts are used in the DVD player casing. Do not use thinners, benzenes or other strong chemical cleaners. These may cause discolouration and damage to the casing.
- Clean the casing with a soft, dry cloth. If the casing is particularly dirty, wipe the casing with a tightly wrung cloth dampened with a diluted, neutral detergent. Then wipe it again with a soft, dry cloth.
- Use a soft, dry cloth to wipe finger marks and other soiling off the LCD screen.

Battery Pack (Sold Separately)



Be sure to observe the following precautions whenever handling the battery pack. Failure to do so can result in battery pack leakage, overheating, smoke emission, fire, or rupture.

1. Never try to take the battery pack apart or modify it in any way. Never apply solder directly to battery pack terminals.
2. When the battery pack is removed from the unit, do not allow its terminals to contact each other through needles, necklaces, or other metal objects.
3. Never leave the battery pack in direct sunlight, on the dashboard of a vehicle, or in any other area where it is exposed to high temperature (greater than 60°C).
4. Never place the battery pack into water, salt water or fire, and do not expose it to heat.
5. Use only the specified AC adapter to charge the battery pack.
6. This battery pack is designed to power specific portable DVD video players only. Never use it with any other device.



Warning!

1. Never drop the battery pack or otherwise subject it to strong impact.
2. Use and store the battery pack in areas that is out of the reach of small children.
3. Never place the battery pack inside a microwave oven or a washing machine.
4. Fluid from inside the battery pack getting into the eyes can cause loss of eyesight. Wash out the eyes thoroughly with plain water and then contact a doctor immediately. Battery pack fluid on clothing or skin can cause skin irritation. Wash off fluid immediately with plain water.

Caution!

1. Charge the battery pack in an area where the temperature is within the range of 10°C to 30°C. Charging outside this temperature range creates the danger of battery pack leakage, overheating, smoke emission, fire, or rupture.
2. When not in use, remove the battery pack and store it in a cool place.
3. Before transporting the DVD video player to another location, remove the battery pack. Failure to do so creates the danger of personal injury due to the battery pack falling out.
4. Avoid prolonged contact with the AC adapter or battery pack while charging. Prolonged contact while charging creates the danger of low-temperature burns.
5. Do not allow the ventilation hole on the back of the battery pack to become blocked. A blocked ventilation hole prevents internal heat from escaping, creating the danger of battery pack leakage, overheating, smoke emission, fire, or rupture.
6. Keep the battery pack out of areas subject to large amounts of oil smoke, steam, moisture, dust, etc.
 - Never leave the battery pack in food preparation areas, near heaters, or in any other location where it can be exposed to oil smoke or steam. Doing so creates the danger of fire and electric shock.
 - Do not use or store the battery pack where it is exposed to direct sunlight, sources of heat, or any other location subject to high temperatures. Doing so creates the danger of battery pack leakage, overheating, smoke emission, fire, or rupture.

Battery Pack Charging Precautions

- Charge the battery pack in an area where the temperature is in the range of 10°C to 30°C. Low temperature can inhibit charging and cause deterioration of the battery pack. The battery pack also cannot charge fully under high temperatures.
- Charging of a battery pack may become disabled (and the charge lamp may fail to light) whenever heat from the DVD player caused the internal temperature of an attached battery pack to rise above certain level. When this happens, remove the battery pack from the DVD player. Charging will start automatically when battery pack internal temperature drops to a safe level.

Storage Precautions

- Before storing a battery pack, first fully discharge it by using it to power DVD player operation. Store the battery pack in a cool place. Storing a battery while it is charged or in a hot location promotes deterioration.



Troubleshooting

Whenever you are having problems with your DVD player, check the following points before requesting service.

Problem	Recommended Action	Page
Power does not turn on or suddenly turns off.	• Make sure the power plug of the AC adapter is plugged into a power outlet.	33
	• Try turning power off and then back on again.	38
Power does not turn on or suddenly turns off under battery power.	• Check if the battery pack is charged. If not, charge it.	34
The remote control unit does not work.	• Make sure that batteries are loaded correctly.	40
	• Check for dead batteries.	
	• Make sure the signal emitter of the remote control unit is pointed at the remote sensor of the DVD player.	
	• Make sure the remote control unit is not too far from the DVD player.	
	• Make sure nothing is blocking the signal path between the remote control unit and DVD player.	
No image appears or no audio is produced.	• Make sure video and audio cords are connected correctly.	29-32
	• Make sure the disc you are trying to play is a DVD (Region 2 or ALL), video CD, or audio CD.	12-14
	• Use a disc that is free of dirt and scratches.	7
	• Make sure the disc is not upside-down.	20
	• The DVD player's pickup lens may be dirty. Take the DVD player to your nearest service centre for cleaning.	6
	• If you want to display images on a connected TV, make sure the TV channel is set to VIDEO or AV.	30

The micro-controller built into the DVD player can be affected by external electrical noise and interference. If you suspect this is the problem, try turning the DVD player off and then back on again.



Problem		Recommended Action	Page
Nothing appears on the screen.		<ul style="list-style-type: none">• Check the DVD player's overall screen brightness setting to make sure it is not "OFF".	82
No audio is output.		<ul style="list-style-type: none">• Make sure the display panel is open. Audio is not output through the DVD player speakers while the display panel is closed.	30
		<ul style="list-style-type: none">• Check the volume dial setting. If it is at zero, rotate the dial to turn up the volume.	21, 58
		<ul style="list-style-type: none">• Make sure headphones are not connected to the headphones jack. Connecting headphones disables the DVD player's speakers.	28
Nothing appears on the screen and no audio is output.		<ul style="list-style-type: none">• Make sure the DVD player is in the DVD mode and not the INPUT mode.	41
Image and sound are distorted		<ul style="list-style-type: none">• Use a disc that is free of scratches.	7, 58
		<ul style="list-style-type: none">• Make sure that the DVD player's built-in speakers are not receiving interference from external speakers.	–
INPUT mode	No image from a connected device appears on the screen of the DVD player.	<ul style="list-style-type: none">• Make sure video and audio cords are connected correctly.	29
		<ul style="list-style-type: none">• Make sure you are not trying to use the S-video cord for input. The S-video cord is for output only.	
		<ul style="list-style-type: none">• Make sure the DVD player is in the INPUT mode and not the DVD mode.	83
DVD mode	No image from the DVD player appears on the screen of a connected device.	<ul style="list-style-type: none">• Make sure the channel of the connected TV is set to VIDEO or AV.	30
		<ul style="list-style-type: none">• Make sure video and audio cords are connected correctly.	
	The volume of Dolby Digital audio from a DVD is too low.	<ul style="list-style-type: none">• Change the "COMPRESSION" setting to "ON". This setting compensates for the relatively low average volume level of Dolby Digital, which is used to provide the widest possible dynamic range.	47





Troubleshooting

Problem		Recommended Action	Page
Battery Pack Operation	The battery pack does not charge.	<ul style="list-style-type: none"> Make sure the main power switch is in the "OFF" position. The battery pack does not charge when it is connected to the DVD player while DVD player power is turned on. 	34, 35
		<ul style="list-style-type: none"> A warm battery takes longer than normal to charge. Wait until the battery cools to normal temperature before trying to charge it. 	–
	Power does not turn on.	<ul style="list-style-type: none"> Replace the battery pack with a charged one or switch to AC adapter power. 	33-36
	The battery charge lamp does not light (the battery pack does not charge).	<ul style="list-style-type: none"> Charging of a battery pack may become disabled (and the charge lamp may fail to light) whenever heat from the DVD player causes the internal temperature of an attached battery pack to rise above certain level. When this happens, remove the battery pack from the DVD player. Charging will start automatically when battery pack internal temperature drops to a safe level. 	–
		<ul style="list-style-type: none"> Make sure the temperature of the battery pack is within the allowable temperature range of 10°C to 30°C for charging. 	86
		<ul style="list-style-type: none"> Check to make sure that the AC adapter DC cable is connected correctly. 	33
	The battery charge lamp is flashing.	<ul style="list-style-type: none"> Try disconnecting the AC adapter DC cable from the battery pack and then reconnecting it. If the battery pack is attached to the DVD player, first disconnect the battery pack DC cable from the DVD player before performing the above step. 	–
<ul style="list-style-type: none"> Try charging another battery pack. The same symptom occurring with another battery pack may indicate a problem with the AC adapter. If the other battery pack charges normally, it can indicate a problem with the first battery pack or that the first battery pack has reached the end of its normal service life. 		–	
Cannot record to an MD.	<ul style="list-style-type: none"> Make sure the connected audio equipment is turned on. 	72	
	<ul style="list-style-type: none"> Check if linear PCM is selected as the audio mode. 		
When recording from a CD to an MD over an optical digital connection, the CD track numbers and MD track numbers do not match.	<ul style="list-style-type: none"> When the space between tracks of some disks is very short, two tracks can be recorded as a single track, which causes a mismatch of track numbers. 	–	
	<ul style="list-style-type: none"> CD and MD track numbers may not match when recording from a CD using programmed play or direct skip. 		



Error Indicators and Warnings

The error indicators and warnings described below appear on the display whenever there is a disk play problem, operational problem, etc.

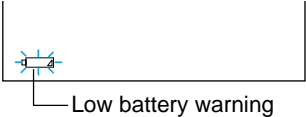
Display	Meaning
	<ul style="list-style-type: none">• The region number of the DVD you are attempting to play is not 2 or ALL.• The disc you are attempting to play is not compatible with this DVD player.
	<ul style="list-style-type: none">• You are attempting a play operation while there is no disc in the disc compartment.
	<ul style="list-style-type: none">• The disc you are using does not support the operation you are trying to perform.• You are trying to perform a wrong operation.
 <p>Low battery warning</p>	<ul style="list-style-type: none">• Battery power is low. DVD player power turns off automatically. Replace the battery pack with a charged one or switch to AC adapter power.

■ Power/Standby Lamp

Lamp Status	Meaning
Lit red	<ul style="list-style-type: none">• Standby Press OPERATE or use the DVD player's main power switch to restore full power.
Lit green	<ul style="list-style-type: none">• Display brightness is "OFF" or the display panel is shut while DVD main power is turned on.



Specifications

Product	Portable DVD Player
Model	DV-L70S/DV-L70BL
Signal System	NTSC/PAL
Supported Disc Types	DVD (Region Number 2, ALL), Video CD, Audio CD
Video Input/Output	Input/Output Jack: Mini jack x 1 (accepts supplied S-video/video cord)
S-Video Output	Input/Output Levels: 1Vp-p (75Ω) Y Output Level: 1Vp-p (75Ω) C Output Level: 0.286Vp-p (75Ω) Output Jack: Mini jack (shared with Video In/Out) x 1 (accepts supplied S-video/video cord)
Audio Input/Output	Input/Output Jack: Mini jack x 1 (accepts supplied audio cord) Input/Output Levels: 2Vrms (1kHz, 0dB)
Digital Audio Interface	Optical digital output: mini jack (shared with audio In/Out)
Audio Output	0.8W + 0.8W
Headphones Output	Output Jack: Mini jack (stereo)
Display	Screen Size: 7 inches (87.8 (H) x 155.5 (W) mm) Type: Transmissive TN liquid crystal panel Drive: TFT (thin transistor) active matrix Pixels: 336,960 (234 (H) x 480 (W) x 3), Effective Pixel Rate: 99.99% minimum
Speakers	Two 28mm round speakers
Light Source	Internal (fluorescent)
Video Signal	Horizontal Resolution: 480 lines (DVD) S/N Ratio: 60dB minimum
Audio Signals	Frequency Characteristics: Linear PCM DVD: 4Hz to 22kHz (48kHz sampling)/ 4Hz to 44kHz (96kHz sampling) CD: 4Hz to 20kHz (EIAJ) (Audio MPEG Version 2.0) S/N Ratio: CD: 95dB 1kHz (EIAJ) Dynamic Range: Linear PCM DVD: 94dB (EIAJ) CD: 94dB (EIAJ) Total Harmonic Distortion Ratio: 0.006% maximum (EIAJ)
Power Requirements	AC Adapter: 9V DC
Power Consumption (AC Adapter)	Main Power On: 11W average (15.5W maximum) Standby: 0.5W (Power/standby lamp lit red) Main Power Off: 0W
Dimensions	188 (W) x 141 (D) x 25.4 (H) mm (except for projections)



Weight	620g
Operating Temperature	5°C to 35°C
Operating Humidity	80% RH maximum
Storage Temperature	-20°C to 40°C

AC Adapter Specifications

Power Requirements	110 to 240V AC, 50/60Hz
Rated Input Capacity	DVD Operation: 30VA Charging (110V): 30VA
Rated Output	DVD Operation: 9V DC Charging: 9V DC
Dimensions	58 (W) × 104 (D) × 275 (H) mm
Weight	170g

Specifications are subject to change without notice.
Weight and dimensions are approximate.

Digital Output (Linear PCM)

- The digital output format used in this DVD player is linear PCM audio sampled at 44.1kHz or 48kHz. Linear PCM sound for DVD video discs sampled at 96kHz cannot be output digitally. Check the disc jacket for information on the audio sampling used.



Glossary

Backlight	Built-in fluorescent light that supplies screen illumination.
Chapter	A section inside a title.
Compression (Dolby Digital output level)	Setting that increases the average volume of Dolby Digital audio when playing a DVD.
Digital gamma	Corrects for gradations in dark areas of images to make images clearer.
Digital super picture	Enhances the fine detail of the image and outlines of the objects it contains.
Display colour settings	Settings for controlling the brightness, and contrast of image colours.
Dolby Digital (5.1 channel)	A sound system developed by Dolby Laboratories Inc. that gives movie theater ambience to audio output when the DVD player is connected to a Dolby Digital 5.1 channel processor or amplifier.
Dolby Virtual Surround	Provides rich surround sound by downmixing Dolby Digital 5.1 channel and Dolby Surround (Pro Logic) to 2-channel audio.
DTS	Theater audio system by Digital Theater Systems Inc. Six audio channels are used to create accurate sound field positioning and realistic sound.
DVD mode	DVD player mode for playing DVDs.
GUI	Graphical User Interface. The GUI uses symbols and marks to create an easy-to-understand interface for performing such operations as: switching the angle of the DVD, controlling digital gamma correction, making disc playback settings, etc.
INPUT mode	DVD player mode for playing the audio and video from a connected device.
Letter box	Screen size that cuts off the top and bottom of the image to allow playing of Wide (16:9) software on a connected 4:3 TV.



- Linear PCM audio** Audio signal recording system used for audio CDs.
- Pan scan**
 Screen size that cuts off the sides of the image to allow playing of Wide (16:9) software on a connected 4:3 TV.
- Parental level** Setting that makes it possible to control the types of scenes that can be played by the DVD player. This setting helps to keep children from viewing adult material.
- Pickup** Laser device that reads the data from a disc for playback.
- Playback control (PBC)** This video CD system allows selection of scenes or information from an on-screen menu.
- Region number** Number identifying a geographic region of compatibility for a DVD.
- Screen size** This setting makes it possible to fit an image onto the screen by cutting off the top and bottom, cutting off the sides, or by stretching the image. You can set the screen size by selecting SIDE BAR, STRETCH, ZOOM or SMART STRETCH.
- Title** When a DVD contains multiple movies, each movie is called a "title".
- Title menu** This is a menu displayed by some DVDs for selection of chapters and subtitle set. The title menu is also called a "top menu".
- Track** One tune on an audio CD.
- View angle** Some DVDs have recordings from multiple angles, so you can select a view angle when playing the disc.

SHARP CORPORATION

Osaka, Japan

Printed in Japan
Impreso en Japón
Tryckt i Japan
TINS-3709GEZZ
T2315-A

Free Manuals Download Website

<http://myh66.com>

<http://usermanuals.us>

<http://www.somanuals.com>

<http://www.4manuals.cc>

<http://www.manual-lib.com>

<http://www.404manual.com>

<http://www.luxmanual.com>

<http://aubethermostatmanual.com>

Golf course search by state

<http://golfingnear.com>

Email search by domain

<http://emailbydomain.com>

Auto manuals search

<http://auto.somanuals.com>

TV manuals search

<http://tv.somanuals.com>