

---

***TAPPAN***

***GAS RANGE***



## Product Registration

### Register Your Product

The **PRODUCT REGISTRATION CARD** should be filled in completely, signed and returned to Electrolux Home Products North America.

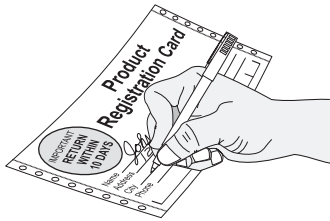

**Thank you for choosing this appliance.** The information contained within this **Owner's Guide** will instruct you on how to properly operate and care for your appliance. Please read through the information contained in your literature pack to learn more about your new appliance.

### Record Your Model and Serial Numbers

Record in the space provided below the model and serial numbers found on the serial plate located under the lift-up cooktop.

**Model Number:** \_\_\_\_\_

**Serial Number:** \_\_\_\_\_

**Date of Purchase:** \_\_\_\_\_

## Contents

This Owner's Guide contains general operating instructions for your appliance and feature information for several models. Your appliance may not have all the described features.

### Versión en español

Si desea obtener una copia en español de este Manual del Usuario, sírvase escribir a la dirección que se incluye a continuación. Solicite la **318204013**.

Electrolux Home Products  
Attn : Care Use  
P. O. Box 212378  
Augusta, GA 30917

Product Registration .....	2
Versión en español .....	2
Important Safety Instructions .....	3-5
Liquefied Petroleum (Propane) Gas Conversion .....	6
Grounding Instructions (electric ignition models only) ..	6
Cooktop and Oven Ignition .....	6
Flame Size .....	7
Proper Burner Adjustments .....	7
Selecting Surface Cooking Utensils .....	7
Specialty Pans & Trivets .....	8
Canning Tips & Informations .....	8
Setting Surface Controls .....	9
Before Setting Oven Controls .....	10
Setting Oven Controls .....	10
Air Circulation in the Oven .....	11
Oven Baking .....	11
Oven Cleaning .....	12-13
General Cleaning .....	14-16
Storage Drawer .....	16
Changing Cooktop and Oven Lights .....	17
Adjusting Oven Temperature .....	17
Avoid Service Checklist .....	18-19
Warranty .....	20

**⚠ WARNING** If the information in this manual is not followed exactly, a fire or explosion may result causing property damage, personal injury or death.

### FOR YOUR SAFETY:

- Do not store or use gasoline or other flammable vapors and liquids in the vicinity of this or any other appliance.
- **WHAT TO DO IF YOU SMELL GAS:**
  - Do not try to light any appliance.
  - Do not touch any electrical switch; do not use any phone in your building.
  - Immediately call your gas supplier from a neighbor's phone. Follow the gas supplier's instructions.
  - If you cannot reach your gas supplier, call the fire department.
- Installation and service must be performed by a qualified installer, servicer or the gas supplier.



# IMPORTANT SAFETY INSTRUCTIONS

Read all instructions before using this appliance.  
Save these instructions for future reference.

This guide contains important safety symbols and instructions. Please pay special attention to these symbols and follow all instructions given. Here is a brief explanation of the use of these symbols.

**⚠ WARNING** This symbol will help alert you to situations that may cause serious bodily harm, death or property damage.

**⚠ CAUTION** This symbol will help alert you to situations that may cause bodily injury or property damage.

- **Remove all tape and packaging wrap before using the range. Destroy the carton and plastic bags after unpacking the range.** Never allow children to play with packaging material.
- **Proper Installation—Be sure your appliance is properly installed and grounded by a qualified technician in accordance with the National Gas Code ANSI Z223.1—latest edition, or in Canada CAN/CGA B149.1, and CAN/CGA B149.2, and the National Electrical Code ANSI/NFPA No. 70—latest edition, or in Canada CSA Standard C22.1, Canadian Electrical Code, Part 1, and local code requirements.** Install only per installation instructions provided in the literature package for this range.
- **Never modify or alter the construction of a range by removing leveling legs, panels, wire covers, anti-tip brackets/screws, or any other part of the product.**

**⚠ WARNING** Stepping, leaning or sitting on the doors or drawers of this range can result in serious injuries and may also cause damage to the range. Do not allow children to climb or play around the range. The weight of a child on an open door may cause the range to tip, resulting in serious burns or other injury.

**⚠ WARNING** Do not use the oven for storage.

• **Storage in or on Appliance—Flammable materials should not be stored in an oven, near surface burners or in the storage drawer (if equipped).** This includes paper, plastic and cloth items, such as cookbooks, plasticware and towels, as well as flammable liquids. Do not store explosives, such as aerosol cans on or near the range. Flammable materials may explode and result in fire or property damage.

Ask your dealer to recommend a qualified technician and an authorized repair service. Know how to disconnect the electrical power to the range at the circuit breaker or fuse box in case of an emergency.

**⚠ CAUTION** Cold temperatures can damage the electronic control. When using the appliance for the first time, or when the appliance has not been used for an extended period of time, be certain the unit has been in temperatures above 32°F for at least 3 hours before turning on the power to the appliance.

**⚠ CAUTION** Do not store items of interest to children in the cabinets above a range or on the backguard of a range. Children climbing on the range to reach items could be seriously injured.

• **User Servicing—Do not repair or replace any part of the appliance unless specifically recommended in the manuals.** All other servicing should be done only by a qualified technician to reduce the risk of personal injury and damage to the range.

• **Do not leave children alone. Children should not be left alone or unattended in the area where an appliance is in use.** They should never be allowed to sit or stand on any part of the appliance.

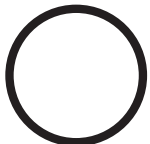

**⚠ WARNING**

- All ranges can tip.
- Injury to person could result.
- Install anti-tip device packed with range.
- See installation instructions.

**⚠ WARNING**

To reduce the risk of tipping of the range, the range must be secured by properly installed anti-tip bracket(s) provided with the range. To check if the bracket(s) is installed properly, remove the lower panel or storage drawer and verify that the anti-tip bracket(s) is engaged. Refer to the installation instructions for proper anti-tip bracket(s) installation.

• **DO NOT TOUCH SURFACE BURNERS, AREAS NEAR THESE BURNERS, OVEN BURNER OR INTERIOR SURFACES OF THE OVEN.** Areas near surface burners may become hot enough to cause burns. During and after use, do not touch, or let clothing or other flammable materials touch these areas until they have had sufficient time to cool. Among these areas are the cooktop, surfaces facing the cooktop, the oven vent openings and surfaces near these openings, oven door and window.

• **Wear Proper Apparel—Loose-fitting or hanging garments should never be worn while using the appliance.** Do not let clothing or other flammable materials contact hot surfaces.

# IMPORTANT SAFETY INSTRUCTIONS<sub>(continued)</sub>

**⚠ WARNING** NEVER use this appliance as a space heater to heat or warm the room. Doing so may result in carbon monoxide poisoning and overheating of the oven.

- **Do Not Use Water or Flour on Grease Fires—Smother the fire with a pan lid, or use baking soda, a dry chemical or foam-type extinguisher.**
- **When heating fat or grease, watch it closely.** Fat or grease may catch fire if allowed to become too hot.
- **Use Only Dry Potholders—Moist or damp potholders on hot surfaces may result in burns from steam.** Do not let the potholders touch the flame or burners. Do not use a towel or other bulky cloth instead of a potholder.
- **Do Not Heat Unopened Food Containers—Build-up of pressure may cause the container to burst and result in injury.**
- **Remove the oven door from any unused range if it is to be stored or discarded.**
- **IMPORTANT—Do not attempt to operate the oven during a power failure. If the power fails, always turn the oven off.** If the oven is not turned off and the power resumes, the oven will begin to operate again. Food left unattended could catch fire or spoil.

## IMPORTANT INSTRUCTIONS FOR USING YOUR COOKTOP

- **Know which knob controls each surface heating unit.**

**⚠ WARNING** Use Proper Flame Size—Adjust flame size so it does not extend beyond the edge of the utensil. The use of undersized utensils will expose a portion of the burner flame to direct contact and may result in ignition of clothing. Proper relationship of utensil to flame will also improve efficiency.

- **Utensil Handles Should Be Turned Inward and Not Extend Over Adjacent Surface Burners—**To reduce the risk of burns, ignition of flammable materials, and spillage due to unintentional contact with the utensil, the handle of the utensil should be positioned so that it is turned inward, and does not extend over adjacent surface burners.

- **Never Leave Surface Burners Unattended at High Settings—**Boilovers cause smoking and greasy spillovers that may ignite, or a pan that has boiled dry may melt.
- **Protective Liners—**Do not use aluminum foil to line surface burner pans, oven bottom or any other part of the range. Use of protective liners or aluminum foil may interfere with heat and air distribution, and combustion. Damage to the range or personal injury may result.
- **Glazed Cooking Utensils—**Only certain types of glass, glass/ceramic, ceramic, earthenware, or other glazed utensils are suitable for rangetop service without breaking due to the sudden change in temperature. Check the manufacturer's recommendations for rangetop use.
- **Do Not Use Decorative Surface Burner Covers.** If a burner is accidentally turned on, the decorative cover will become hot and possibly melt. You will not be able to see that the burner is on. Burns will occur if the hot covers are touched. Damage may also be done to the cooktop or burners because the covers may cause overheating. Air will be blocked from the burner and cause combustion problems.

## IMPORTANT INSTRUCTIONS FOR USING YOUR OVEN

- **Use Care When Opening Door—**Stand to the side of the range when opening the door of a hot oven. Let hot air or steam escape before you remove or replace food in the oven.
- **Keep Oven Vent Ducts Unobstructed.** The oven is vented below the backguard. Touching the surfaces in this area when the oven is operating may cause severe burns. Also, do not place plastic or heat-sensitive items on or near the oven vent. These items could melt or ignite.

**⚠ WARNING** NEVER cover any slots, holes or passages in the oven bottom or cover an entire rack with materials such as aluminum foil. Doing so blocks air flow through the oven and may cause carbon monoxide poisoning. Aluminum foil linings may trap heat, causing a fire hazard.

- **Placement of Oven Racks.** Always place oven racks in desired location while oven is cool. If rack must be moved while oven is hot, use extreme caution. Use potholders and grasp the rack with both hands to reposition. Do not let potholders contact the oven burner flame or interior of the oven. Remove all utensils from the rack before removing rack.

# IMPORTANT SAFETY INSTRUCTIONS<sub>(continued)</sub>

- **Do not use the broiler pan without its insert.** The broiler pan and grid allow dripping fat to drain and be kept away from the high heat of the broiler.
- **Do not cover the broiler grid with aluminum foil.** Exposed fat and grease could ignite.
- **Do not touch a hot light bulb (some models) with a dampcloth.** Doing so could cause the bulb to break. Disconnect the range or turn off the power to the range before removing and replacing light bulb.
- **Kitchen cleaners/aerosols**—Always follow the manufacturer's recommended directions for use. Be aware that excess residue from cleaners and aerosols may ignite causing damage and/or injury.

## CONTINUOUS CLEANING OVENS (some models):

- **Do not use oven cleaners on the oven liner or any of the continuous cleaning surfaces.** Continuous cleaning surfaces can be identified by their rough surface finish.

## SELF-CLEANING OVENS (some models):

- **Clean in the self-cleaning cycle only the parts of the oven listed in this owner's guide.** Before self-cleaning the oven, remove the broiler pan and any utensils stored in the oven.
- **Do not clean the oven door gasket.** The door gasket is essential for a good seal. Care should be taken not to rub, damage or remove the gasket.
- **Do not use oven cleaners.** No oven cleaner or oven liner protective coating of any kind should be used in or around any part of the oven.

## IMPORTANT INSTRUCTIONS FOR CLEANING YOUR RANGE

- **Clean the range regularly to keep all parts free of grease that could catch fire.** Pay particular attention to the area underneath each surface burner. Exhaust fan ventilation hoods and grease filters should be kept clean. Do not allow grease to accumulate. Greasy deposits in the fan could catch fire. Refer to the hood manufacturer's instructions for cleaning.

## IMPORTANT SAFETY NOTICE

The California Safe Drinking Water and Toxic Enforcement Act requires the Governor of California to publish a list of substances known to the state to cause cancer, birth defects or other reproductive harm, and requires businesses to warn customers of potential exposure to such substances.

# SAVE THESE INSTRUCTIONS

## Liquefied Petroleum (Propane) Gas Conversion

This appliance can be used with Natural Gas or Liquefied Petroleum (Propane) Gas. It is shipped from the factory for use with Natural Gas.

Refer to the Installation Instructions for conversion from Natural Gas to Propane Gas, or from Propane Gas to Natural Gas.

**⚠ WARNING** Severe shock or damage to the appliance may occur if the appliance is not installed by a qualified installer.

## Grounding Instructions (electric ignition models only)

**⚠ WARNING** Avoid fire hazard or electrical shock. Do not use an adaptor plug, an extension cord, or remove grounding prong from electrical power cord. Failure to follow this warning can cause serious injury, fire or death.

Grounding type wall receptacle

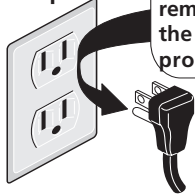

Power supply cord with 3-prong grounding plug

### IMPORTANT: READ AND SAVE THESE INSTRUCTIONS.

**⚠ WARNING** This appliance is equipped with a 3-prong grounding plug for your protection against shock hazard and should be plugged directly into a properly grounded receptacle. **DO NOT** cut or remove the grounding prong from this plug.

For personal safety, this oven must be properly grounded. For maximum safety, the power cord must be plugged into a 120V—60 Hz. outlet that is correctly polarized and properly grounded.

If a two-prong wall receptacle is the only available outlet, it is the personal responsibility of the consumer to have it replaced with a properly grounded three-prong wall receptacle installed by a qualified electrician.

DO NOT UNDER ANY CIRCUMSTANCES CUT OR REMOVE THE THIRD ROUND GROUNDING PRONG FROM THE POWER CORD PLUG. SEE THE INSTALLATION INSTRUCTIONS PACKAGED WITH THIS APPLIANCE FOR COMPLETE INSTALLATION AND GROUNDING INSTRUCTIONS. DO NOT OPERATE THE APPLIANCE USING A TWO-PRONG ADAPTER OR AN EXTENSION CORD.

## Cooktop and Oven Ignition

**⚠ WARNING** During a power failure, the oven burners cannot be lit and you should not try to do so. The oven burner valves will not open up and will prevent the gas from flowing through the burner valves to the burners.

### To Manually Light Cooktop Burners with Spark Ignition

When you turn the control knob to LITE, all ignitors make an electric spark (a ticking sound) which lights the selected burner.

During a power failure, the burners will not light automatically. In an emergency, a cooktop burner may be lit with a match by following the steps below:

1. Light a match and hold the flame near the burner you want to light. Wooden matches work best.
2. Push in and turn the control knob slowly. Be sure you are turning the correct knob for the burner you are lighting.

**Note: If the burner does not light within 5 seconds, turn the knob off and wait one minute before trying again.**

### Oven Ignition

When you turn the oven on, the glow bar igniter begins to heat. When the lighter is hot enough, in about 1 minute, the gas flows into the burner and is ignited.

The igniter glows bright orange when hot. It cycles on and off with the thermostat and will glow whenever the burner is on.

---

***For most cooking***, start on the highest control setting and then turn to a lower one to complete the process. Use the chart below as a guide for determining proper

## Specialty Pans & Trivets



**Woks** with flat bottoms suitable for use on your cooktop are available in most cookshop or hardware stores. Round-bottomed woks (with a support ring that does not extend beyond the burner unit) may also be used. The metal ring was designed to support the wok safely when it is filled with large amounts of liquids (soup making) or fat (frying).

**DO NOT** use a wok if it is equipped with a metal ring that extends beyond the burner unit. Because this ring traps heat, the surface unit and cooktop surface could be damaged.

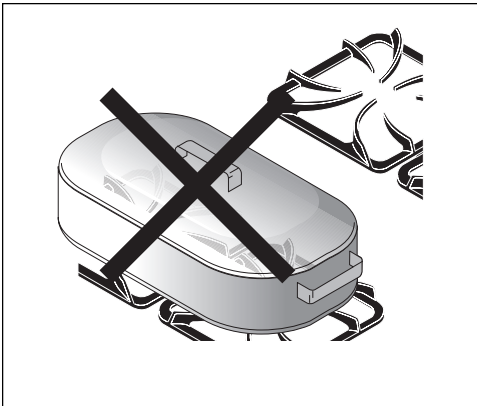

**Wire trivets:** Do not use wire trivets. Cookware bottoms must be in direct contact with the grates.

**CAUTION** DO NOT use two burner units to heat one large pan such as a roaster or griddle, or allow cooking utensils to boil dry. The bottom surface of the pan in either of these situations could cause discoloring or crazing of the appliance cooking surface, and damage to the grates and burner units.

## Canning Tips & Information

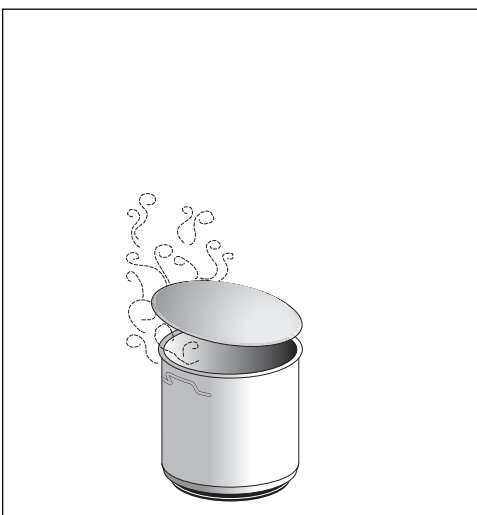



## Setting Surface Controls

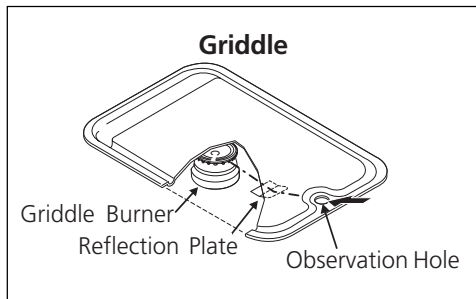
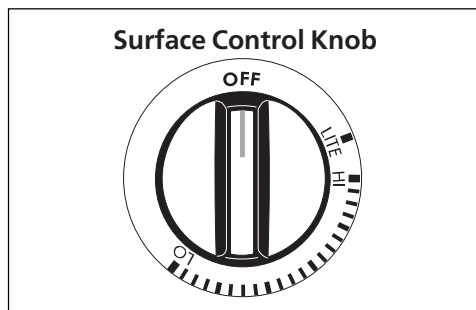

The hole in the griddle cover should be toward the backguard.

**CAUTION** Make sure to locate the griddle observation hole toward the front of the range to observe the burner flame.

**CAUTION** Do not use the griddle cover over a lit burner or for cooking. This may damage the cover.

Each burner lights automatically from an electric ignitor. *Electric ignitors* light automatically each time a Surface Control knob is turned to the LITE position.

### To Operate the Surface Burner

1. Place cooking utensil on burner.
2. Push in and turn the Surface Control knob to LITE. **Note:** All electronic ignitors will click at the same time. However, only the burner you are turning on will ignite.
3. Visually check that the burner has lit.
4. After the burner lights, turn the control knob to the desired flame size. The control knobs do not have to be set at a particular mark. Use the guides and adjust the flame as needed. **DO NOT** cook with the control knob in the LITE position. (The electronic ignitors will continue to click if one Surface Control knob is left in the LITE position, causing premature wear.)

In the event of an electrical power outage, the surface burners can be lit manually. To light a surface burner, hold a lit match to the burner head, then slowly turn the surface control knob to LITE. Use caution when lighting surface burners manually.

**CAUTION** Do not place plastic items such as salt and pepper shakers, spoon holders or plastic wrappings on top of the range when it is in use. These items could melt or ignite. Potholders, towels or wood spoons could catch fire if placed too close to a flame.

### Griddle (some models)

Your non-stick griddle must first be "conditioned" to insure non-stick cooking. Remove the enamel griddle cover. Wipe a teaspoon of vegetable oil over the surface before using the griddle for the first time.

Do not overheat the griddle as this will cause permanent staining of the non-stick coating. You can protect the non-stick coating by keeping the enamel cover over the griddle when not in use.

The griddle is intended for direct food cooking. Do not use pans or other cookware on the griddle. Doing so could damage the finish. After turning on the griddle burner, you can check to see if it is ignited by looking at the griddle burner flame reflection plate through the observation hole. See diagram of Griddle Burner at left.

### 5th Burner (some models)

The 5th burner pan, chrome bowl insert and a burner grate can be used in place of the griddle. To use the griddle area for a 5th burner, remove the griddle and place the 5th burner pan over the burner. Then place the bowl insert and the burner grate in the proper position. Operate the 5th burner with the griddle control knob.

## Before Setting Oven Controls

### Oven Vent Location

The oven is vented through the **center rear of the cooktop**. When the oven is on, warm air is released through the vent. This venting is necessary for proper burner operation in the oven. **DO NOT** block the vent. Doing so may cause baking failures, fire or damage to the range.

## Arranging Oven Racks

*ALWAYS ARRANGE OVEN RACKS WHEN THE OVEN IS COOL (PRIOR TO OPERATING THE OVEN).* Always use oven mitts when using the oven.

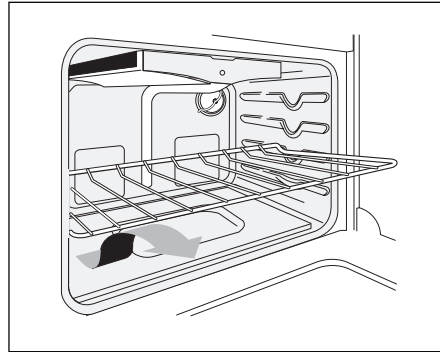

**To remove an oven rack**, pull the rack forward until it stops. Lift up front of rack and slide out. **To replace an oven rack**, fit the rack onto the guides on the oven walls. Tilt the front of the rack upward and slide the rack back into place.

The rungs on the offset rack are slightly raised from the edges of the rack. This raised part of the rack is designed to allow easy and safe removal of foods from the lower racks of the oven and prevent hands from contacting the hot oven door.

## Setting Oven Controls

(Porcelain Enamel and Continuous Cleaning Oven Only, Self-Cleaning Oven See the Electronic Oven Control Guide)

Temperature Control Knob

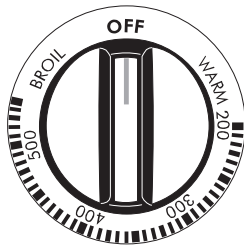

The broiler pan and its grid allow dripping grease to drain and be kept away from the high heat of the broiler. **DO NOT** use the pan without its grid. **DO NOT** cover the grid with foil. The exposed grease could ignite.

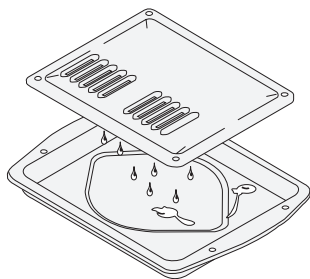

### To Bake

1. Arrange oven racks while the oven is still cool. See "Arranging Oven Racks" under **Before Setting Oven Controls**.
2. Push in and turn the Temperature Control knob to the desired temperature.
3. Preheat the oven for 10 to 12 minutes before baking. Preheating is not necessary when roasting, cooking casseroles or broiling most foods.
4. When cooking is finished, turn the Temperature Control knob to OFF.

### To Broil

Broiling is done in the compartment below the oven cavity. Food is broiled by the same burner that heats the oven. The broiler compartment rolls out for easy checking and turning of food.

1. Open the broiler drawer and roll the broiler compartment out.
2. Arrange broiler pan while broil compartment is still cool. For rare meats, position the broiler pan closer to the burner (upper position). For well-done foods such as chicken, lobster tails or thick cuts of meat, position the pan further from the burner (lower position).

Rack Position From Top	Food
1	Rare steaks
2-3	Ham slices, fish, hamburgers and medium steaks and chops
4	Well-done foods such as chicken and lobster

3. Push in and turn the Temperature Control knob to **BROIL**.
4. Place the grid on the broiler pan, then place the meat on the grid. **DO NOT** use the broiler pan without the grid or cover the grid with aluminum foil. The exposed fat could ignite.
5. Push the compartment all the way into the range and close the drawer.
6. Broil on one side until food is browned; turn and cook on the second side. Season and serve. **Note:** Always pull the broiler compartment out to the stop position before turning or removing food.
7. When broiling is finished, turn the Temperature Control knob to OFF.

## Air Circulation in the Oven

For best air circulation and baking results, center pans as much as possible. Allow 2-4" (5-10 cm) around the utensil(s) for proper air circulation and be sure pans do not touch each other, the door, sides or back of oven. The hot air must circulate around the pans in the oven for even heat to reach all parts of the oven.

If using multiple pans, stagger as shown. If using one pan, place in center of oven.

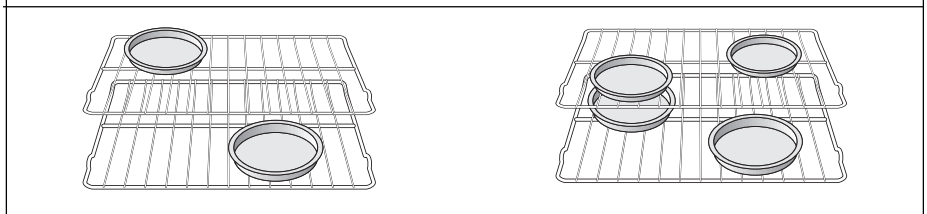





## Oven Baking

"Baking" means to cook foods such as cakes or casseroles by dry heat in a covered or uncovered pan. Roasting, often confused with baking, means to cook meat in an uncovered pan. To bake or roast, follow the instructions provided in the Owner's Guide. (See "Setting Oven Controls" section.)

### Baking Problems and Solutions Chart (Below)

### Product Expectations

The cooking times and temperatures needed to bake a product may vary slightly from your previously owned appliance.

Baking Problems	Causes	Corrections
<b>Cookies and biscuits burn on the bottom.</b> 	<ul style="list-style-type: none"> <li>• Cookies and biscuits put into the oven before the preheating time is completed.</li> <li>• Oven rack overcrowded.</li> <li>• Dark pan absorbs heat too fast.</li> </ul>	<ul style="list-style-type: none"> <li>• Allow oven to preheat to the selected temperature before placing food in oven.</li> <li>• Choose pan sizes that will permit 2-4" (5-10 cm) of air space on all sides when placed in the oven.</li> <li>• Use a medium-weight aluminum baking sheet.</li> </ul>
<b>Cakes too dark on top or bottom.</b> 	<ul style="list-style-type: none"> <li>• Cakes put into the oven before preheating time is completed.</li> <li>• Rack position too high or low.</li> <li>• Oven too hot.</li> </ul>	<ul style="list-style-type: none"> <li>• Allow oven to preheat to the selected temperature before placing food in the oven.</li> <li>• Use proper rack position for baking needs.</li> <li>• Set oven temperature 25°F/12°C lower than recommended.</li> </ul>
<b>Cakes not done in the center.</b> 	<ul style="list-style-type: none"> <li>• Oven too hot.</li> <li>• Incorrect pan size.</li> <li>• Pan not centered in oven.</li> </ul>	<ul style="list-style-type: none"> <li>• Set oven temperature 25°F/12°C lower than recommended.</li> <li>• Use pan size suggested in recipe.</li> <li>• Use proper rack position and place pan so there is 2-4" (5-10 cm) of space on all sides of pan.</li> </ul>
<b>Cakes not level.</b> 	<ul style="list-style-type: none"> <li>• Range not level.</li> <li>• Pan too close to oven wall or rack overcrowded.</li> <li>• Pan warped.</li> <li>• Oven rack not level.</li> </ul>	<ul style="list-style-type: none"> <li>• Place a marked glass measuring cup filled with some water on the center of the oven rack. If the water level is uneven, refer to the installation instructions for leveling the range.</li> <li>• Be sure to allow 2-4" (5-10 cm) of clearance on all sides of each pan in the oven.</li> <li>• Do not use pans that are dented or warped.</li> <li>• Check oven rack for flatness and proper positioning.</li> </ul>
<b>Foods not done when cooking time is up.</b> 	<ul style="list-style-type: none"> <li>• Oven too cool.</li> <li>• Oven overcrowded.</li> <li>• Oven door opened too frequently.</li> </ul>	<ul style="list-style-type: none"> <li>• Set oven temperature 25°F/12°C higher than suggested and bake for the recommended time.</li> <li>• Be sure to remove all pans from the oven except the ones to be used for baking.</li> <li>• Open oven door only after shortest recommended baking time.</li> </ul>

## Oven Cleaning (continued)

## Self-Cleaning Oven (some models)

Refer to your Electronic Oven Control Guide

**⚠ CAUTION** During the self-cleaning cycle, the outside of the wall oven can become very hot to the touch. **DO NOT** leave small children unattended near the appliance. Use care when opening the oven door after self-cleaning cycle. Stand to the side of the oven when opening the door to allow hot air or steam to escape.

### Adhere to the following cleaning precautions:

- Allow the oven to cool before cleaning.
- Wear rubber gloves when cleaning the range manually.

REMOVE SPILLOVERS AND HEAVY SOILING AS SOON AS POSSIBLE. **REGULAR CLEANINGS WILL REDUCE THE NUMBER OF MAJOR CLEANINGS LATER.**

**⚠ CAUTION** Ammonia must be rinsed before operating the oven. Provide adequate ventilation.

**⚠ CAUTION** **DO NOT** line the oven walls, bottom, racks or any other part of the range with aluminum foil. Doing so will destroy heat distribution, produce poor baking results and cause permanent damage to the oven interior (aluminum foil will melt to the interior surface of the oven).

## Easy Clean Oven (some models)

Porcelain has a smooth finish and is a type of glass fused to metal. Oven cleaners can be used on all interior oven surfaces.

### General Cleaning

Remove soils using hot, soapy water. Do not allow food spills with a high sugar or acid content (such as milk, tomatoes, sauerkraut, fruit juices or pie filling) to remain on the surface as they may cause a dull spot even after cleaning.

### To Remove Heavy Soil

1. Allow a dish of ammonia to sit in the oven overnight or for several hours with the oven door closed. Clean softened spots using hot, soapy water. Rinse well with water and a clean cloth.
2. If soil remains, use a soap-filled scouring pad or a nonabrasive cleaner. If necessary, use an oven cleaner following manufacturer's instructions. **DO NOT** mix ammonia with other cleaners.
3. Clean any soil from the oven frame, the door liner outside the oven door gasket, the small area at the front center of the oven bottom and the oven vent exit (located below the backguard). Clean with hot, soapy water. Rinse well using clean water and a cloth.

### Adhere to the following precautions when using oven cleaners:

1. **DO NOT** spray on the electrical controls or switches because it could cause a short circuit and result in sparking or fire.
2. **DO NOT** allow a film from the cleaner to build up on the temperature sensing bulb; it could cause the oven to heat improperly. (The bulb is located in the rear of the oven.) Carefully wipe the bulb clean after each oven cleaning, being careful not to move the bulb. A change in its position could affect how the oven bakes. Avoid bending the bulb and capillary tube.
3. **DO NOT** spray any cleaner on the oven door trim or gasket, handles or any exterior surfaces of the range, wood or painted surfaces. The cleaner can damage these surfaces.

### Cleaning the Oven Bottom

**The oven bottom in porcelain enamel oven models can be removed for cleaning.** See "To Remove and Replace Oven Bottom" under **General Cleaning**.

Clean using hot, soapy water, a mild abrasive cleanser, a soap-filled abrasive pad or oven cleaner following manufacturer's instructions.

## Oven Cleaning (continued)

### Adhere to the following cleaning precautions:

- Allow the oven to cool before cleaning.
- Wear rubber gloves when cleaning the range manually.

REMOVE SPILLOVERS AND HEAVY SOILING AS SOON AS POSSIBLE. **REGULAR CLEANINGS WILL REDUCE THE NUMBER OF MAJOR CLEANINGS LATER.**

**⚠ CAUTION** Ammonia must be rinsed before operating the oven. Provide adequate ventilation.

**⚠ WARNING DO NOT** use oven cleaners, gritty cleansers, coarse abrasive pads or brushes, silicone sprays or metal scrapers on the interior walls, oven frame or ceiling of a continuous cleaning oven. **Permanent damage to the oven may result.**

**⚠ CAUTION DO NOT** line the oven walls, bottom, racks or any other part of the range with aluminum foil. Doing so will destroy heat distribution, produce poor baking results and cause permanent damage to the oven interior (aluminum foil will melt to the interior surface of the oven).

## Continuous Cleaning Oven (some models)

Continuous cleaning ovens have a special coating which is a porous ceramic material. This rough coating tends to prevent grease spatters from forming little beads which run down the side walls leaving streaks that require hand cleaning. Instead, when spatter hits the porous coating, it disperses and is partially absorbed. This spreading action increases the exposure of oven soil to heated air, making it less noticeable.

*Soil may not disappear completely.* Remaining soil will gradually fade with continued oven use. *The special coating works best on small amounts of spatter.* Larger spills, or spills generating from sugar, egg and dairy mixtures, do not clean as well.

### If difficult soils occur:

1. Remove the oven racks and cookware.
2. Remove soils by completing steps **a** or **b** below:
  - a) Use hot, soapy water and wash soils using a nylon-bristly brush or a nylon mesh scouring pad. **DO NOT** rub or scrub with paper towels, cloths or sponges. They will leave lint on the oven coating.
  - b) Apply ammonia with a sponge and dab it into the porous coating. Leave the ammonia on the soiled area for 30 minutes.
3. Rinse with clear water.
4. Close the oven door and push in and turn the Temperature Control knob to 450°F (230°C).
5. Operate oven for 15 minutes.
6. Remaining soil will fade with continued oven use.

## Cleaning the Oven Bottom

**The oven bottom is not a continuous cleaning finish. Oven cleaners can be used on the oven bottom only.** Remove the oven bottom before using oven cleaners. **DO NOT** get oven cleaner on any of the continuous cleaning surfaces.

**Note:** To remove or replace oven bottom, see "To Remove and Replace Oven Bottom" under **General Cleaning**.

*To clean,* use hot, soapy water, a mild abrasive cleanser, a soap-filled abrasive pad or oven cleaner (**on the oven bottom only**) following manufacturer's instructions.

# General Cleaning

## Cleaning Various Parts of Your Range

Before cleaning any part of the range, be sure all controls are turned OFF and the range is COOL. REMOVE SPILLOVERS AND HEAVY SOILING AS SOON AS POSSIBLE. REGULAR CLEANINGS WILL REDUCE THE NUMBER OF MAJOR CLEANINGS LATER.

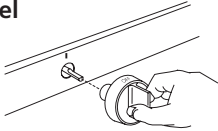
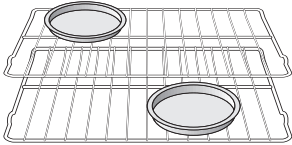
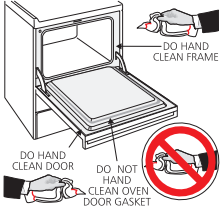
Surfaces	How to Clean
<b>Aluminum</b> (Trim Pieces) & <b>Vinyl</b>	Use hot, soapy water and a cloth. Dry with a clean cloth.
<b>Glass, Painted and Plastic</b> Control Knobs, Body Parts, and Decorative Trim	For general cleaning, use hot, soapy water and a cloth. For more difficult soils and built-up grease, apply a liquid detergent directly onto the soil. Leave on soil for 30 to 60 minutes. Rinse with a damp cloth and dry. <b>DO NOT</b> use abrasive cleaners on any of these materials; they can scratch.
<b>Control Panel</b> 	Before cleaning the control panel, turn all controls to OFF and remove the control knobs. To remove, pull each knob straight off the shaft. Clean as instructed above. Be sure to squeeze excess water from the cloth before wiping the panel; especially when wiping around the controls. Excess water in or around the controls may cause damage to the appliance. To replace knobs after cleaning, line up the flat sides of both the knob and the shaft; then push the knob into place.
<b>Porcelain Enamel</b> Burner Grates, Under the Cooktop, Cooktop, Broiler Pan and Insert, Roll-out Broiler, Door Liner and Oven Bottom	Clean in the dishwasher and dry upon removal. If soils are not removed, follow these cooktop cleaning instructions: Gentle scouring with a soapy scouring pad will remove most spots. Rinse with a 1:1 solution of clear water and ammonia. If necessary, cover difficult spots with an ammonia-soaked paper towel for 30 to 40 minutes. Rinse with clean water and a damp cloth, and then scrub with a soap-filled scouring pad. Rinse and wipe dry with a clean cloth. Remove all cleaners or the porcelain may become damaged during future heating. <b>DO NOT</b> use spray oven cleaners on the rangetop.
<b>Stainless Steel, Chrome</b> Decorative Trim, Drip Pans	Clean with hot, soapy water and a dishcloth. Rinse with clean water and a cloth. Cover stubborn spots with an ammonia-soaked paper towel for 30 to 40 minutes. Rinse. Cleaners made especially for stainless steel are recommended. Be sure to rinse the cleaners as bluish stains may occur during heating and cannot be removed.
<b>Oven Racks</b> 	Oven racks can be removed or left in the oven during the self-cleaning cycle for cleaning. If removed, clean by using a mild, abrasive cleaner, following manufacturer's instructions. Rinse with clean water and dry.  If the racks are cleaned in the self-clean cycle, their color will turn slightly blue and the finish will be dull. After the self-clean cycle is completed, and the oven has cooled, rub the sides of the racks with wax paper or a cloth containing a small amount of baby oil or salad oil (this will make the racks glide easier into the rack positions).
<b>Surface Burners</b>	The holes in the burners of your range must be kept clean at all times for proper ignition and a complete, even flame. Clean burner holes routinely with a small gauge wire or needle and especially after bad spillovers which could clog these holes.  To remove and replace burner units per your model, see "To Remove and Replace Burners" under <b>General Cleaning</b> . To clean, soak the burners in a 1:1 clean water and ammonia solution for 30 to 40 minutes. For stubborn stains, scrub with soap and water or a mild abrasive cleanser and a damp cloth. Before putting the burner back, dry it thoroughly by setting it in a warm oven for 30 minutes. Then replace it, making sure it is properly seated and level. <b>DO NOT</b> put burner units in the dishwasher.
<b>Oven Door</b> 	To clean oven door, wash with hot, soapy water and a clean cloth. <b>DO NOT</b> immerse the door in water. <b>DO NOT</b> clean the oven door gasket. (Self-cleaning oven only: The oven door gasket is made of a woven material which is essential for a good seal). Care should be taken not to rub, damage or remove the gasket.

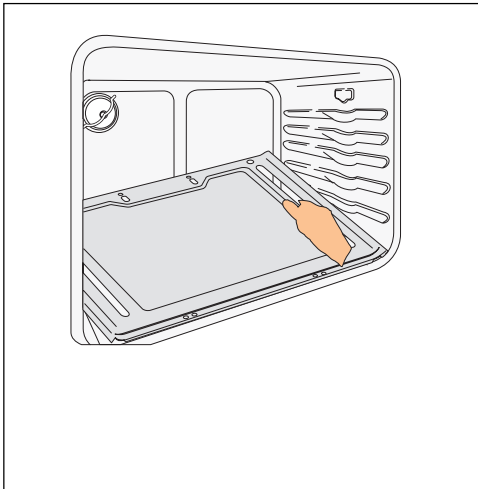

## General Cleaning

(continued)

**⚠ CAUTION** The door is heavy. For safe, temporary storage, lay the door flat with the inside of the door facing down.

Removing the Oven Door

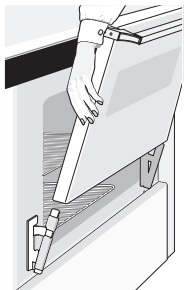

### To Remove and Replace Oven Door

The oven door can be removed to make oven cleaning easier.

#### To Remove Oven Door:

1. Open door approximately 4 inches to the stop position.
2. Grasp door at side edges.
3. Lift door up and off hinges.
4. To clean oven door, see the cleaning chart on page 16.

#### To Replace Oven Door:

1. Be sure the hinge arms are in the stop position. Be careful if pulling the hinges open by hand. The hinges may snap back against the oven frame and could pinch fingers.
2. Hold the door at the sides near the top.
3. Slide the door down onto the hinges as far as it will go and close the door.
4. If the door is not in line with the oven frame, remove door and repeat the above steps.

### Cleaning the Roll-Out Broiler (some models)

#### To Remove the Roll-Out Broiler:

1. Pull out broiler until it stops, and then push back in about 1 inch.
2. Grasp handle, lift and pull out broiler. Lift the rollers under the broiler over the roller guide stops in the broiler compartment.
3. Clean the lower and side broiler plates and roll-out broiler as explained in the cleaning instructions for porcelain enamel under **General Cleaning**.

#### To Replace the Roll-Out Broiler:

1. Put the rollers under the broiler behind the roller guide stops in the broiler compartment.
2. Hold broiler in the raised position as you slide it partly into the broiler compartment, then lower broiler and push completely closed.

### Griddle

Griddle  
Burr

### Cleaning the Griddle (some models)

Before cleaning, be sure all controls are OFF. For easier cleaning, clean the griddle while it is still *warm*. The griddle can be removed for easier cleaning. The griddle can be washed in the sink with a mild detergent and plastic scouring pad. For greasy residue, use a grease-dissolving dishwashing liquid and a nylon scrub brush.

*Avoid abrasive cleansers* that can scratch the finish. Do not use oven cleaners. Wipe dry before reinstalling into rangetop.

## Storage Drawer

### Storage Drawer (some models)

Use the storage drawer for storing cooking utensils. The drawer can be removed to facilitate cleaning under the range. Use care when handling the drawer.

To open the storage drawer, push the drawer in gently and it will spring open. To close, push the drawer until you hear a click, which indicates that the spring is compressed, and the drawer is closed.

#### To Remove the Storage Drawer:

1. Open and empty the drawer of all utensils.
2. Pull drawer out to the drawer stop.
3. Lift the front high enough to allow the drawer to be pulled out.

#### To Replace the Storage Drawer:

1. Insert the rear end of the drawer into the opening.
2. Fit the end rollers onto the guide rails.
3. Hold the drawer in a horizontal position, then push in until a click is heard.

**⚠ WARNING** Flammable materials should not be stored in an oven, near surface elements or in the storage drawer or compartment (if equipped). This includes paper, plastic and cloth items, such as cookbooks, plasticware and towels, as well as flammable liquids. Do not store explosives, such as aerosol cans, on or near the range. Flammable materials may explode and result in fire or property damage.



## Adjusting Oven Temperature

(Easy and continuous cleaning models only, Self-cleaning model refer to the electronic timer guide)

Figure 1: Back of Control Knob

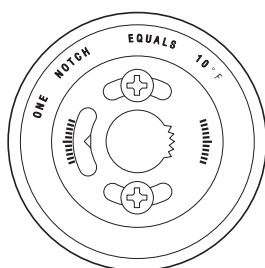

Note position of pointer prior to adjustment

The temperature in the oven has been set at the factory. When first using the oven, be sure to follow recipe times and temperatures. If you think the oven is too hot or too cool, the temperature in the oven can be adjusted. Before adjusting, test a recipe by using a higher or lower temperature than the recommended temperature. The baking results should help you to decide how much of an adjustment is needed.

### To Adjust Oven Temperature:

1. Check to be sure the Temperature Control knob is in the OFF position.
2. Pull Temperature control knob straight off the shaft.
3. Loosen, but do not remove, the two screws at the back of the knob (Figure 1).  
**Note:** If knob does not have 2 screws, it is not adjustable. There is a series of small indicator grooves. One of these grooves is positioned next to a tiny pointer. Note the position of the pointer.
4. To increase the temperature, move the pointer in a clockwise direction. To decrease the temperature, move the pointer in a counterclockwise direction. The temperature can be adjusted in increments of 10°F.
5. When the desired adjustment is reached, tighten both screws.
6. To replace the knob, line up the flat sides of both the knob and the shaft. Push the knob into place. **DO NOT** force the Temperature Control knob onto the shaft or you may damage the back of the knob.

**Note:** Once an adjustment is made, the OFF position will vary from the reference mark on the backguard depending on the amount of adjustment.

# Avoid Service Checklist

Before you call for service, review this list. It may save you time and expense. The list includes common occurrences that are not the result of defective workmanship or materials in this appliance.

## OCCURRENCE

## POSSIBLE CAUSE/SOLUTION

**Oven Control Beeps and Displays -F1- through -F8- (some models).**

Electronic control has detected a fault condition. Push **Cancel** to clear the display and stop the display from beeping. Reprogram the oven. If a fault reoccurs, record the fault number, push the **Cancel button** and contact an authorized servicer.

**Range is not level.**

Poor installation. Place oven rack in center of oven. Place a level on the oven rack. Adjust leveling legs at base of range until the rack is level.

Weak, unstable floor. When oven is level, cooktop may not appear to be level with countertop. Be sure floor is level and can adequately support range. Contact a carpenter to correct sagging or sloping floor.

Kitchen cabinet misalignment may make range appear to be unlevel. Be sure cabinets are square and have sufficient room for range clearance.

**Cannot move appliance easily. Appliance must be accessible for service.**

Cabinets not square or are built in too tight. Contact a cabinet maker to correct the problem.

Contact builder or installer to make appliance accessible.

Carpeting interferes with range. Provide sufficient space so range can be lifted over carpet.

Gas line is hard-plumbed. Have a flexible A.G.A./C.G.A. approved metal appliance connector installed.

**Surface burners do not light.**

Surface control knob has not been completely turned to LITE. Push in and turn the Surface Control knob to LITE until burner ignites and then turn control to desired flame size.

Burner ports are clogged. With the burner off, use a small-gauge wire or needle to clean ports. See "Surface Burners" in the cleaning chart under **General Cleaning** for additional cleaning instructions.

Range power cord is disconnected from outlet. Be sure cord is securely plugged into the outlet.

Electrical power outage. Burners can be lit manually. See **Setting Surface Controls** in this Owner's Guide.

**Flame burns half way around.**

Burner ports are clogged. With the burner off, clean by using a small-gauge wire or needle to clean ports.

Moisture is present after cleaning. Lightly fan the flame and allow burner to operate until flame is full. Dry the burners thoroughly following instructions under **General Cleaning**.

**Surface burner flame is orange.**

Dust particles in main line. Allow the burner to operate a few minutes until flame turns blue.

A slightly orange flame is unavoidable due to salt air in coastal areas.

**Oven does not operate**

Temperature Control knob is not set properly. Make sure the Temperature Control knob is set to desired function. See **Setting Oven Controls**.

Be sure regulator gas valve is "ON". See installation instructions.

<b>Entire oven does not operate.</b>	<p>Controls are not set properly. See instructions under <b>Setting Oven Controls</b> or <b>Oven Cleaning</b> to set the controls.</p> <hr/> <p>Automatic timed oven (Timed Bake feature) set incorrectly. Follow steps under "To Set the Automatic Timer (Timed Bake Feature)" in <b>Setting Oven Controls</b> .</p> <hr/> <p>Make sure cord/plug is plugged tightly into outlet.</p> <hr/> <p>Service wiring not complete. Contact servicer or dealer.</p> <hr/> <p>Power outage. Check house lights to be sure. Call your local electric company for service. Surface burner can be lit manually. See <b>Setting Surface Controls</b> in this Owner's Guide.</p> <hr/> <p>Be sure gas supply is turned on.</p>
<b>Oven and/or cooktop light does not work.</b>	<p>Burned-out or loose bulb. See <b>Changing Cooktop and Oven Lights</b> in this Owner's Guide to replace or tighten the bulb.</p>
<b>Oven smokes excessively during broiling.</b>	<p>Meat too close to broil burner. Reposition the rack to provide more clearance between the meat and the broiler.</p> <hr/> <p>Meat not properly prepared. Remove excess fat from meat. Slash remaining fatty edges to prevent curling, but do not cut into the lean.</p> <hr/> <p>Broiler pan used without grid or grid covered with foil. <b>DO NOT</b> use the broiler pan without grid or cover grid with foil.</p> <hr/> <p>Broiler drawer/door open. Make sure drawer/door is closed when broiling.</p> <hr/> <p>Broiler drawer/door needs cleaning. Excessive smoke is caused by old grease or food spatters. If the broiler is used often, clean on a regular basis.</p>
<b>Poor baking results.</b>	<p>If baked food are too dark on top or bottom, allow the oven to preheat to set temperature before placing food in oven. Make sure the proper rack position is used when baking. Set temperature 25°F (12°C) lower than recommended. If food is not done after recommended time, increase the set temperature 25°F (12°C).</p>
<b>Self-Cleaning Cycle does not work.</b>	<p>Controls are not set properly. Follow instructions under <b>Oven Cleaning</b>.</p> <hr/> <p>Self-cleaning cycle was interrupted. Stop time must be set 2 to 4 hours past the start time. Follow steps under "Stopping or Interrupting a Self-Clean Cycle" under <b>Oven Cleaning</b>.</p>
<b>Soil is not completely removed after self-cleaning cycle.</b>	<p>Failure to clean bottom front, top of oven or door area outside the oven seal. These areas are not in the self-cleaning area, but get hot enough to burn on residue. Clean these areas before starting the self-clean cycle. Burned-on residue may be cleaned with a stiff nylon brush and water or a nylon scrubber. Be careful not to damage the oven seal.</p> <hr/> <p>Excessive spillovers in oven. Set self-clean cycle for a longer cleaning time.</p>
<b>Flames inside oven or smoke from vent.</b>	<p>Excessive spillovers in oven. This is normal, especially for high oven temperatures, pie spillovers or large amounts of grease on the oven bottom. Wipe up excessive spillovers before starting the self-clean cycle.</p>



## Major Appliance Warranty Information

Your appliance is covered by a one year limited warranty. For one year from your original date of purchase, Electrolux will pay all costs for repairing or replacing any parts of this appliance that prove to be defective in materials or workmanship when such appliance is installed, used and maintained in accordance with the provided instructions.

**Exclusions**      **This warranty does not cover the following:**

1. Products with original serial numbers that have been removed, altered or cannot be readily determined.
2. Product that has been transferred from its original owner to another party or removed outside the USA or Canada.
3. Rust on the interior or exterior of the unit.
4. Products purchased "as-is" are not covered by this warranty.
5. Food loss due to any refrigerator or freezer failures.
6. Products used in a commercial setting.
7. Service calls which do not involve malfunction or defects in materials or workmanship, or for appliances not in ordinary household use or used other than in accordance with the provided instructions.
8. Service calls to correct the installation of your appliance or to instruct you how to use your appliance.
9. Expenses for making the appliance accessible for servicing, such as removal of trim, cupboards, shelves, etc., which are not a part of the appliance when it is shipped from the factory.
10. Service calls to repair or replace appliance light bulbs, air filters, water filters, other consumables, or knobs, handles, or other cosmetic parts.
11. Surcharges including, but not limited to, any after hour, weekend, or holiday service calls, tolls, ferry trip charges, or mileage expense for service calls to remote areas, including the state of Alaska.
12. Damages to the finish of appliance or home incurred during installation, including but not limited to floors, cabinets, walls, etc.
13. Damages caused by: services performed by unauthorized service companies; use of parts other than genuine Electrolux parts or parts obtained from persons other than authorized service companies; or external causes such as abuse, misuse, inadequate power supply, accidents, fires, or acts of God.

**DISCLAIMER OF IMPLIED WARRANTIES; LIMITATION OF REMEDIES**

CUSTOMER'S SOLE AND EXCLUSIVE REMEDY UNDER THIS LIMITED WARRANTY SHALL BE PRODUCT REPAIR OR REPLACEMENT AS PROVIDED HEREIN. CLAIMS BASED ON IMPLIED WARRANTIES, INCLUDING WARRANTIES OF MERCHANTABILITY OR FITNESS FOR A PARTICULAR PURPOSE, ARE LIMITED TO ONE YEAR OR THE SHORTEST PERIOD ALLOWED BY LAW, BUT NOT LESS THAN ONE YEAR. ELECTROLUX SHALL NOT BE LIABLE FOR CONSEQUENTIAL OR INCIDENTAL DAMAGES SUCH AS PROPERTY DAMAGE AND INCIDENTAL EXPENSES RESULTING FROM ANY BREACH OF THIS WRITTEN LIMITED WARRANTY OR ANY IMPLIED WARRANTY. SOME STATES AND PROVINCES DO NOT ALLOW THE EXCLUSION OR LIMITATION OF INCIDENTAL OR CONSEQUENTIAL DAMAGES, OR LIMITATIONS ON THE DURATION OF IMPLIED WARRANTIES, SO THESE LIMITATIONS OR EXCLUSIONS MAY NOT APPLY TO YOU. THIS WRITTEN WARRANTY GIVES YOU SPECIFIC LEGAL RIGHTS. YOU MAY ALSO HAVE OTHER RIGHTS THAT VARY FROM STATE TO STATE.

**If You Need Service**      Keep your receipt, delivery slip, or some other appropriate payment record to establish the warranty period should service be required. If service is performed, it is in your best interest to obtain and keep all receipts. Service under this warranty must be obtained by contacting Electrolux at the addresses or phone numbers below.

This warranty only applies in the USA and Canada. In the USA, your appliance is warranted by Electrolux Major Appliances North America, a division of Electrolux Home Products, Inc. In Canada, your appliance is warranted by Electrolux Canada Corp. Electrolux authorizes no person to change or add to any obligations under this warranty. Obligations for service and parts under this warranty must be performed by Electrolux or an authorized service company. Product features or specifications as described or illustrated are subject to change without notice.

**USA**  
**1.800.944.9044**  
Electrolux Major Appliances  
North America  
P.O. Box 212378  
Augusta, GA 30907



**Canada**  
**1.800.668.4606**  
Electrolux Canada Corp.  
5855 Terry Fox Way  
Mississauga, Ontario, Canada  
L5V 3E4

## Free Manuals Download Website

<http://myh66.com>

<http://usermanuals.us>

<http://www.somanuals.com>

<http://www.4manuals.cc>

<http://www.manual-lib.com>

<http://www.404manual.com>

<http://www.luxmanual.com>

<http://aubethermostatmanual.com>

Golf course search by state

<http://golfingnear.com>

Email search by domain

<http://emailbydomain.com>

Auto manuals search

<http://auto.somanuals.com>

TV manuals search

<http://tv.somanuals.com>