

SHARP®

DATA PROJECTOR

MODEL

PG-LX3000

PG-LX3500

PG-LW3000

PG-LW3500

OPERATION MANUAL



Introduction

Easy Start

Setup

Connections

Basic
Operation

Useful
Features

Appendix



IMPORTANT

- For your assistance in reporting the loss or theft of your Projector, please record the Model and Serial Number located on the bottom of the projector and retain this information.
- Before recycling the packaging, please ensure that you have checked the contents of the carton thoroughly against the list of "Supplied accessories" on page 3.

Model No.:

Serial No.:

SPECIAL NOTE FOR USERS IN THE U.K.

The mains lead of this product is fitted with a non-rewireable (moulded) plug incorporating a 10A fuse. Should the fuse need to be replaced, a BSI or ASTA approved BS 1362 fuse marked  or  and of the same rating as above, which is also indicated on the pin face of the plug, must be used.

Always refit the fuse cover after replacing the fuse. Never use the plug without the fuse cover fitted.

In the unlikely event of the socket outlet in your home not being compatible with the plug supplied, cut off the mains plug and fit an appropriate type.

DANGER:

The fuse from the cut-off plug should be removed and the cut-off plug destroyed immediately and disposed of in a safe manner.

Under no circumstances should the cut-off plug be inserted elsewhere into a 13A socket outlet, as a serious electric shock may occur.

To fit an appropriate plug to the mains lead, follow the instructions below:

WARNING:

THIS APPARATUS MUST BE EARTHED.

IMPORTANT:

The wires in this mains lead are coloured in accordance with the following code:

Green-and-yellow	: Earth
Blue	: Neutral
Brown	: Live

As the colours of the wires in the mains lead of this apparatus may not correspond with the coloured markings identifying the terminals in your plug proceed as follows:

- The wire which is coloured green-and-yellow must be connected to the terminal in the plug which is marked by the letter E or by the safety earth symbol  or coloured green or green-and-yellow.
- The wire which is coloured blue must be connected to the terminal which is marked with the letter N or coloured black.
- The wire which is coloured brown must be connected to the terminal which is marked with the letter L or coloured red.

IF YOU HAVE ANY DOUBT, CONSULT A QUALIFIED ELECTRICIAN.

Before using the projector, please read this operation manual carefully.

Introduction

ENGLISH

There are two important reasons for prompt warranty registration of your new SHARP Projector, using the REGISTRATION CARD packed with the projector.

1. WARRANTY

This is to assure that you immediately receive the full benefit of the parts, service and labor warranty applicable to your purchase.

2. CONSUMER PRODUCT SAFETY ACT

To ensure that you will promptly receive any safety notification of inspection, modification, or recall that SHARP may be required to give under the 1972 Consumer Product Safety Act, PLEASE READ CAREFULLY THE IMPORTANT "LIMITED WARRANTY" CLAUSE.



U.S.A. ONLY

WARNING: High brightness light source. Do not stare into the beam of light, or view directly. Be especially careful that children do not stare directly into the beam of light.



WARNING: To reduce the risk of fire or electric shock, do not expose this product to rain or moisture.

See bottom of projector.

	CAUTION RISK OF ELECTRIC SHOCK. DO NOT REMOVE SCREWS EXCEPT SPECIFIED USER SERVICE SCREW.	
CAUTION: TO REDUCE THE RISK OF ELECTRIC SHOCK, DO NOT REMOVE COVER. NO USER-SERVICEABLE PARTS EXCEPT LAMP UNIT. REFER SERVICING TO QUALIFIED SERVICE PERSONNEL.		



The lightning flash with arrowhead symbol, within an equilateral triangle, is intended to alert the user to the presence of uninsulated "dangerous voltage" within the product's enclosure that may be of sufficient magnitude to constitute a risk or electric shock to persons.



The exclamation point within a triangle is intended to alert the user to the presence of important operating and maintenance (servicing) instructions in the literature accompanying the product.

WARNING:

This is a Class A product. In a domestic environment this product may cause radio interference in which case the user may be required to take adequate measures.

WARNING: FCC Regulations state that any unauthorized changes or modifications to this equipment not expressly approved by the manufacturer could void the user's authority to operate this equipment.

U.S.A. ONLY

The enclosed computer cable must be used with the device. The cable is provided to ensure that the device complies with FCC Class A verification.

U.S.A. ONLY

INFORMATION

This equipment has been tested and found to comply with the limits for a Class A digital device, pursuant to Part 15 of the FCC Rules. These limits are designed to provide reasonable protection against harmful interference when the equipment is operated in a commercial environment. This equipment generates, uses, and can radiate radio frequency energy and, if not installed and used in accordance with the operation manual, may cause harmful interference to radio communications. Operation of this equipment in a residential area is likely to cause harmful interference, in which case the user will be required to correct the interference at his own expense.

U.S.A. ONLY

PRODUCT DISPOSAL

This product utilizes lamp containing a small amount of mercury. Disposal of these materials may be regulated due to environmental considerations. For disposal or recycling information, please contact your local authorities, the Electronics Industries Alliance: www.eiae.org, the lamp recycling organization www.lamprecycle.org, or Sharp at 1-800-BE-SHARP.

U.S.A. ONLY

Caution Concerning Lamp Replacement

- This projector utilizes a pressurized mercury lamp. A loud sound may indicate lamp failure. Lamp failure can be attributed to numerous sources such as: excessive shock, improper cooling, surface scratches or deterioration of the lamp due to a lapse of usage time.
The period of time up to failure largely varies depending on the individual lamp and/or the condition and the frequency of use. It is important to note that failure can often result in the bulb cracking.
- When the lamp replacement indicator and on-screen display icon are illuminated, it is recommended that the lamp be replaced with a new one immediately, even if the lamp appears to be operating normally.
- Should the lamp break, there is also a possibility that glass particles may spread inside of the projector. In such a case, it is recommended you contact your nearest Sharp Authorized Projector Dealer or Service Center to assure safe operation.
- Should the lamp break, the glass particles may spread inside the lamp cage or gas contained in the lamp may be vented into the room from the exhaust vent. Because the gas in this lamp includes mercury, ventilate the room well if the lamp breaks and avoid all exposure to the released gas. In case of exposure to the gas, consult a doctor as soon as possible.



Caution

- Do not remove the lamp unit from the projector right after use. The lamp will be very hot and may cause burns or injury.
 - Wait at least one hour after the power cord is disconnected to allow the surface of the lamp unit to fully cool before removing the lamp unit.
 - Do not touch the glass surface of the lamp unit or the inside of the projector.
 - Do not loosen other screws except for the lamp unit cover and lamp unit.
 - Make sure to reset the lamp timer only when replacing the lamp. If you reset the lamp timer and continue to use the same lamp, this may cause the lamp to become damaged or explode.
- **Carefully change the lamp by following the instructions described on pages 63 to 65.**
* **If you wish, you may have the lamp replaced at your nearest Sharp Authorized Projector Dealer or Service Center.**

* If the new lamp does not light after replacement, take your projector to the nearest Sharp Authorized Projector Dealer or Service Center for repair.

Accessories

Supplied accessories

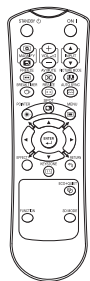

Remote control
<RRMCGB015WJSB>



Two LR03 batteries
("AAA" size, UM/SUM-4,
HP-16 or similar)

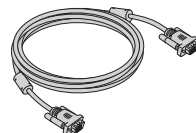

RGB cable
(6' (1.8 m))
<QCNWGA173WJPZ>

Power cord*

(1)

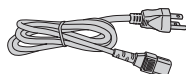

For U.S. and
Canada, etc.
(6' (1.8 m))
<QACCD A083WJPZ>

(2)

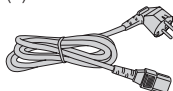

For Europe,
except U.K.
(6' (1.8 m))
<QACCV A025WJPZ>

(3)

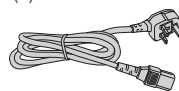

For U.K. and
Singapore
(6' (1.8 m))
<QACCB A105WJPZ>

* Which power cords are supplied along with your projector depends on the region. Use the power cord that corresponds to the wall outlet in your country.

- Initial setup guide <TINS-F649WJZZ>
- CD-ROM <UDSKAA139WJZZ>

Note

- Codes in "< >" are Replacement parts codes.

Optional accessories

- | | |
|--------------------------------|-----------------------------|
| ■ Lamp unit | AN-LX30LP |
| ■ Ceiling-mount adaptor | AN-60KT |
| ■ Ceiling-mount bracket | AN-XRCM30 (for U.S.A. only) |
| ■ Ceiling-mount unit | AN-TK201 <for AN-60KT> |
| | AN-TK202 <for AN-60KT> |
| ■ Ceiling-mount extension tube | AN-EP101B <for AN-XRCM30> |
| | (for U.S.A. only) |

Note

- Some of the optional accessories may not be available depending on the region. Please check with your nearest Sharp Authorized Projector Dealer or Service Center.

Contents

Preparing

Introduction

Accessories	3
Contents	4
IMPORTANT SAFEGUARDS	6
Part Names and Functions.....	10
Top View	10
Front View	10
Rear View (Terminals).....	11
Inserting the Batteries.....	13
Usable Range.....	13

Easy Start

Easy Start	14
Setup and Projection	14

Setup

Setting Up the Projector.....	16
Video Setup.....	16
Setting Up the Projector	16
Standard Setup (Front Projection).....	16
Screen Size and Projection	
Distance (PG-LW3500/PG-LW3000)....	17
Screen Size and Projection	
Distance (PG-LX3500/PG-LX3000).....	18
Projection (PRJ) Mode.....	19
Ceiling-Mount Setup.....	19

Connections

Connecting the Projector to Other Equipment.....	20
Controlling the Projector by a Computer	23
Connecting the Power Cord	24

Using

Basic Operation

Turning the Projector On/Off	25
Turning the Projector On.....	25
Turning the Power Off (Putting the Projector into Standby Mode)	25
Image Projection	26
About the Setup Guide.....	26
Adjusting the Projected Image	26
Correcting Trapezoidal Distortion	28
Switching the Input Mode.....	29
Adjusting the Volume.....	29

Displaying the Black Screen and Turning Off the Sound Temporarily	29
Resize Mode	30

Useful Features

Operating with the Remote Control.....	34
Displaying and Setting the	
Break Timer	34
Displaying the Pointer	34
Using the Spot Function	34
Switching the Eco+Quiet Mode	34
Auto Sync (Auto Sync Adjustment)	35
Freezing a Moving Image.....	35
Selecting the Picture Mode.....	35
Displaying an Enlarged Portion of an Image	35
Menu Items.....	36
Using the Menu Screen	39
Menu Selections (Quick Start Menu)	39
Quick Start Menu.....	39
Menu Selections (Complete Menu)	40
Picture Adjustment (“Picture” Menu)	42
Selecting the Picture Mode.....	42
Adjusting the Image.....	43
Adjusting the Color Temperature.....	43
Adjusting the Colors	43
Selecting the Film Mode	44
Reducing Image Noise (DNR)	44
Eco+Quiet	44
Signal Adjustment (“SIG-ADJ” Menu)	45
Adjusting the Computer Image	45
Resolution Setting	45
Signal Type Setting	45
Selecting the Dynamic Range.....	45
Setting the Video System	46
Setting the Video Setup.....	46
Checking the Input Signal.....	46
Adjusting the Projected Image	
(“SCR-ADJ” Menu).....	47
Setting the Resize Mode.....	47
Adjusting the Image Position	47
Keystone Correction.....	47
Setting the Overscan	48
Setting the On-screen Display	48
Closed Caption	48
Selecting the Background Image.....	49
Selecting the Setup Guide	49
Reversing/Inverting Projected Images.....	49
Selecting the Wall Color.....	49
Selecting the On-screen Display Language	49
Adjusting the Projector Function	
(“PRJ-ADJ1/2” Menu)	50
Auto Sync (Auto Sync Adjustment)	50
Auto Power Off Function	50

Auto Restart Function.....	50
Speaker Setting.....	50
Fan Mode Setting.....	50
System Lock Function.....	51
Keylock Function.....	52
Selecting the Quick Start Menu	52
COMPUTER2 Select	52
Setting the FUNCTION Button Operation..	53
STANDBY Mode.....	53
STANDBY Audio Out.....	53
DLP® Link™.....	53
DLP® Link™ Invert	53
Returning to the Default Settings	53
Checking the Lamp Life Status.....	53
Setting Up the Projector Network Environment (“Network”Menu)	54
Setting a Password	54
DHCP Client Setting	55
TCP/IP Setting.....	55
Returning to Default Settings (Network) ..	55
Restart Network Function.....	55
Confirming the Projector Information.....	56
Viewing Stereoscopic 3D Images.....	57
Precautions on Viewing Stereoscopic 3D Images.....	57
Information on the 3D Projection Function	58
Appendix.....	58
Using 3D Viewing Mode	59

Reference

Appendix

Maintenance.....	60
Maintenance Indicators.....	61
Regarding the Lamp.....	63
Lamp.....	63
Caution Concerning the Lamp.....	63
Replacing the Lamp	63
Removing and Installing the Lamp Unit...	64
Resetting the Lamp Timer	65
Compatibility Chart	66
Troubleshooting.....	68
For SHARP Assistance.....	71
Specifications.....	72
Dimensions.....	73
Index.....	74

- In this operation manual, the illustration and the screen display are simplified for explanation, and may differ slightly from the actual display.

IMPORTANT SAFEGUARDS

CAUTION: Please read all of these instructions before you operate this product and save these instructions for later use.

Electrical energy can perform many useful functions. This product has been engineered and manufactured to assure your personal safety. BUT IMPROPER USE CAN RESULT IN POTENTIAL ELECTRICAL SHOCK OR FIRE HAZARDS. In order not to defeat the safeguards incorporated in this product, observe the following basic rules for its installation, use and servicing.

1. Read Instructions

All the safety and operating instructions should be read before the product is operated.

2. Retain Instructions

The safety and operating instructions should be retained for future reference.

3. Heed Warnings

All warnings on the product and in the operating instructions should be adhered to.

4. Follow Instructions

All operating and use instructions should be followed.

5. Cleaning

Unplug this product from the wall outlet before cleaning. Do not use liquid cleaners or aerosol cleaners. Use a damp cloth for cleaning.

6. Attachments

Do not use attachments not recommended by the product manufacturer as they may cause hazards.

7. Water and Moisture

Do not use this product near water—for example, near a bath tub, wash bowl, kitchen sink, or laundry tub; in a wet basement; or near a swimming pool; and the like.

8. Accessories

Do not place this product on an unstable cart, stand, tripod, bracket, or table. The product may fall, causing serious injury to a child or adult, and serious damage to the product. Use only with a cart, stand, tripod, bracket, or table recommended by the manufacturer, or sold with the product. Any mounting of the product should follow the manufacturer's instructions, and should use a mounting accessory recommended by the manufacturer.

9. Transportation

A product and cart combination should be moved with care. Quick stops, excessive force, and uneven surfaces may cause the product and cart combination to overturn.



10. Ventilation

Slots and openings in the cabinet are provided for ventilation to ensure reliable operation of the product and to protect it from overheating, and these openings must not be blocked or covered. The openings should never be blocked by placing the product on a bed, sofa, rug, or other similar surface. This product should not be placed in a built-in installation such as a bookcase or rack unless proper ventilation is provided or the manufacturer's instructions have been adhered to.

11. Power Sources

This product should be operated only from the type of power source indicated on the marking label. If you are not sure of the type of power supply to your home, consult your product dealer or local power company. For products intended to operate from battery power, or other sources, refer to the operating instructions.

12. Grounding or Polarization

This product is provided with one of the following types of plugs. If the plug should fail to fit into the power outlet, please contact your electrician.

Do not defeat the safety purpose of the plug.

- Two-wire type (mains) plug.
- Three-wire grounding type (mains) plug with a grounding terminal.
This plug will only fit into a grounding type power outlet.

13. Power-Cord Protection

Power-supply cords should be routed so that they are not likely to be walked on or pinched by items placed upon or against them, paying particular attention to cords at plugs, convenience receptacles, and the point where they exit from the product.

14. Lightning

For added protection for this product during a lightning storm, or when it is left unattended and unused for long periods of time, unplug it from the wall outlet and disconnect the cable system. This will prevent damage to the product due to lightning and power-line surges.

15. Overloading

Do not overload wall outlets, extension cords, or integral convenience receptacles as this can result in a risk of fire or electric shock.

16. Object and Liquid Entry

Never push objects of any kind into this product through openings as they may touch dangerous voltage points or short-out parts that could result in a fire or electric shock. Never spill liquid of any kind on the product.

17. Servicing

Do not attempt to service this product yourself as opening or removing covers may expose you to dangerous voltage or other hazards. Refer all servicing to qualified service personnel.

18. Damage Requiring Service

Unplug this product from the wall outlet and refer servicing to qualified service personnel under the following conditions:

- When the power-supply cord or plug is damaged.
- If liquid has been spilled, or objects have fallen into the product.
- If the product has been exposed to rain or water.
- If the product does not operate normally by following the operating instructions. Adjust only those controls that are covered by the operating instructions, as an improper adjustment of other controls may result in damage and will often require extensive work by a qualified technician to restore the product to normal operation.
- If the product has been dropped or damaged in any way.
- When the product exhibits a distinct change in performance, this indicates a need for service.

19. Replacement Parts

When replacement parts are required, be sure the service technician has used replacement parts specified by the manufacturer or have the same characteristics as the original part. Unauthorized substitutions may result in fire, electric shock, or other hazards.

20. Safety Check

Upon completion of any service or repairs to this product, ask the service technician to perform safety checks to determine that the product is in proper operating condition.

21. Wall or Ceiling Mounting

This product should be mounted to a wall or ceiling only as recommended by the manufacturer.

22. Heat

This product should be situated away from heat sources such as radiators, heat registers, stoves, or other products (including amplifiers) that produce heat.

- DLP® and the DLP logo are registered trademarks of Texas Instruments and BrilliantColor™ and DLP® Link™ are trademarks of Texas Instruments.
- PC/AT is a registered trademark of International Business Machines Corporation in the United States.
- Macintosh® is a registered trademark of Apple Computer, Inc. in the United States and/or other countries.
- HDMI, the HDMI logo and High-Definition Multimedia Interface are trademarks or registered trademarks of HDMI Licensing LLC.
- All other company or product names are trademarks or registered trademarks of their respective companies.
- Some IC chips in this product include confidential and/or trade secret property belonging to Texas Instruments. Therefore you may not copy, modify, adapt, translate, distribute, reverse engineer, reverse assemble or discompile the contents thereof.

Observe the following safeguards when setting up your projector.

Caution concerning the lamp unit

- Potential hazard of glass particles if lamp ruptures. In case of lamp rupture, contact your nearest Sharp Authorized Projector Dealer or Service Center for replacement. See "Regarding the Lamp" on page 63.



Caution concerning the setup of the projector

- For minimal servicing and to maintain high image quality, SHARP recommends that this projector be installed in an area free from humidity, dust and cigarette smoke. When the projector is subjected to these environments, the vents and lens must be cleaned more often. As long as the projector is regularly cleaned, use in these environments will not reduce the overall operation life of the unit. Internal cleaning should only be performed by a Sharp Authorized Projector Dealer or Service Center.

Rest your eyes occasionally.

- Continuously watching the screen for long hours will cause eye strain. Take regular breaks to rest your eyes.

Do not set up the projector in places exposed to direct sunlight or bright light.

- Position the screen so that it is not in direct sunlight or room light. Light falling directly on the screen washes out the colors, making viewing difficult. Close the curtains and dim the lights when setting up the screen in a sunny or bright room.

Caution regarding placing of the projector

- Place the projector on a level site within the adjustment range (9 degrees) of the adjustment foot.

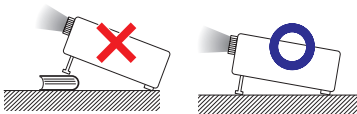

- After the projector is purchased, a faint smell from the vent may appear when the power is first turned on. This is normal and is not a malfunction. It will disappear after the projector is used for a while.

When using the projector in high-altitude areas such as mountains (at altitudes of approximately 1,500 meters (4,900 feet) or more)

- When you use the projector in high-altitude areas with thin air, set "Fan Mode" to "High". Neglecting this can affect the longevity of the optical system.
- Use the projector at altitudes of 2,300 meters (7,500 feet) or less.

Warning about placing the projector in a high position

- When placing the projector in a high position, make certain it is carefully secure to avoid personal injury caused by the projector falling down.

Do not subject the projector to hard impact and/or vibration.

- Protect the lens so as not to hit or damage the surface of the lens.

Avoid locations with extremes of temperature.

- The operating temperature of the projector is from 41°F to 95°F (+5°C to +35°C).
- The storage temperature of the projector is from -4°F to 140°F (-20°C to +60°C).

Do not block the exhaust and intake vents.

- Allow at least 11 ¹³/₁₆ inches (30 cm) of space between the exhaust vent and the nearest wall or obstruction.
- Ensure that the intake vent and the exhaust vent are not obstructed.
- If the cooling fan becomes obstructed, a protection circuit will automatically put the projector into Standby mode to prevent overheat damage. This does not indicate a malfunction. (See pages 61 and 62.) Remove the projector power cord from the wall outlet and wait at least 10 minutes. Place the projector where the intake and exhaust vents are not blocked, plug the power cord back in and turn on the projector. This will return the projector to the normal operating condition.

Caution regarding usage of the projector

- If you are not to use the projector for a long time or before moving the projector, make certain you unplug the power cord from the wall outlet, and disconnect any other cables connected to it.
- Do not carry the projector by holding the lens.
- Do not expose the projector to direct sunlight or place next to heat sources. Doing so may affect the cabinet color or cause deformation of the plastic cover.

Other connected equipment

- When connecting a computer or other audio-visual equipment to the projector, make the connections AFTER unplugging the power cord of the projector from the AC outlet and turning off the equipment to be connected.
- Please read the operation manuals of the projector and the equipment to be connected for instructions on how to make the connections.

Using the projector in other countries

- The power supply voltage and the shape of the plug may vary depending on the region or country you are using the projector in. When using the projector overseas, make sure you use an appropriate power cord for the country you are in.

Temperature monitor function



- If the temperature inside the projector increases, due to blockage of the air vents, or the setting location, the temperature warning indicator will blink. And if the temperature keeps on rising, “ TEMP.” will illuminate in the lower left corner of the picture with the temperature warning indicator blinking. If this state continues, the lamp will turn off, the cooling fan will run and then the projector will enter Standby mode. Refer to “Maintenance Indicators” on pages 61 and 62 for details.

Info

- The cooling fan regulates the internal temperature, and its performance is automatically controlled. The sound of the fan may change during projector operation due to changes in the fan speed. This does not indicate malfunction.

Closed Caption uses Bitstream Vera fonts

Copyright (c) 2003 by Bitstream, Inc. All Rights Reserved. Bitstream Vera is a trademark of Bitstream, Inc. Permission is hereby granted, free of charge, to any person obtaining a copy of the fonts accompanying this license (“Fonts”) and associated documentation files (the “Font Software”), to reproduce and distribute the Font Software, including without limitation the rights to use, copy, merge, publish, distribute, and/or sell copies of the Font Software, and to permit persons to whom the Font Software is furnished to do so, subject to the following conditions:

The above copyright and trademark notices and this permission notice shall be included in all copies of one or more of the Font Software typefaces.

The Font Software may be modified, altered, or added to, and in particular the designs of glyphs or characters in the Fonts may be modified and additional glyphs or characters may be added to the Fonts, only if the fonts are renamed to names not containing either the words “Bitstream” or the word “Vera”.

This License becomes null and void to the extent applicable to Fonts or Font Software that has been modified and is distributed under the “Bitstream Vera” names.

The Font Software may be sold as part of a larger software package but no copy of one or more of the Font Software typefaces may be sold by itself.

THE FONT SOFTWARE IS PROVIDED “AS IS”, WITHOUT WARRANTY OF ANY KIND, EXPRESS OR IMPLIED, INCLUDING BUT NOT LIMITED TO ANY WARRANTIES OF MERCHANTABILITY, FITNESS FOR A PARTICULAR PURPOSE AND NONINFRINGEMENT OF COPYRIGHT, PATENT, TRADEMARK, OR OTHER RIGHT. IN NO EVENT SHALL BITSTREAM OR THE GNOME FOUNDATION BE LIABLE FOR ANY CLAIM, DAMAGES OR OTHER LIABILITY, INCLUDING ANY GENERAL, SPECIAL, INDIRECT, INCIDENTAL, OR CONSEQUENTIAL DAMAGES, WHETHER IN AN ACTION OF CONTRACT, TORT OR OTHERWISE, ARISING FROM, OUT OF THE USE OR INABILITY TO USE THE FONT SOFTWARE OR FROM OTHER DEALINGS IN THE FONT SOFTWARE.

Except as contained in this notice, the names of Gnome, the Gnome Foundation, and Bitstream Inc., shall not be used in advertising or otherwise to promote the sale, use or other dealings in this Font Software without prior written authorization from the Gnome Foundation or Bitstream Inc., respectively. For further information, contact: fonts at gnome dot org.

Part Names and Functions

Numbers in **■** refer to the main pages in this operation manual where the topic is explained.

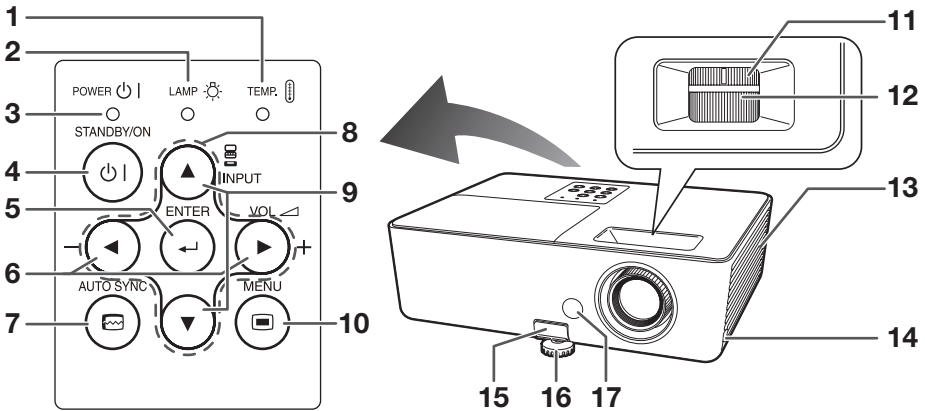

Top View

- 1 Temperature warning indicator **61**
- 2 Lamp indicator **61**
- 3 Power indicator **61**
- 4 STANDBY/ON button **25**
For turning the power on and putting the projector into Standby mode.
- 5 ENTER button **39**
For setting items selected or adjusted on the menu.
- 6 VOL (Volume) buttons (-◀/▶+) **29**
For adjusting the speaker sound level.
- 7 AUTO SYNC button **35**
For automatically adjusting images when connected to a computer.
- 8 Adjustment buttons (▲/▼/◀/▶) **39**
For selecting menu items.
- 9 INPUT buttons (▲/▼) **29**
For switching Input mode.
- 10 MENU button **39**
For displaying adjustment and setting screens.

Front View

- 11 Zoom ring **27**
For enlarging/reducing the picture.
- 12 Focus ring **26**
For adjusting the focus.
- 13 Intake vent **60**
- 14 Security bar
- 15 HEIGHT ADJUST lever **27**
- 16 Adjustment foot **27**
- 17 Remote control sensor **13**

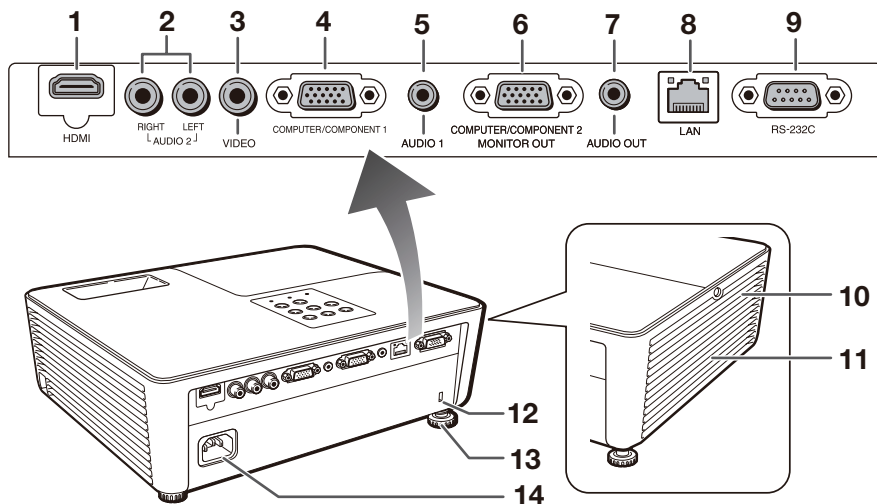

Rear View (Terminals)

- 1 HDMI terminal **20, 21, 22**
Terminal for HDMI input.
 - 2 AUDIO 2 input terminal **21**
 - 3 VIDEO input terminal **21**
Terminal for connecting video equipment.
 - 4 COMPUTER/COMPONENT 1 input terminal **20, 21**
Terminal for computer RGB and component signals.
 - 5 AUDIO 1 input terminal **22**
 - 6 MONITOR OUT* terminal **22, 52**
(Output terminal for computer RGB and component signals)
Terminal for connecting a monitor.
COMPUTER/COMPONENT 2* input terminal **20, 21**
Terminal for computer RGB and component signals.
- * You must switch the setting depending on whether you are using the terminal for MONITOR OUT or COMPUTER/COMPONENT 2 input.
- 7 AUDIO OUT terminal **22**
Audio output terminal of equipment connected to the audio input terminal.

- 8 LAN terminal **24**
Terminal for controlling the projector using a computer via network.
- 9 RS-232C terminal **23**
Terminal for controlling the projector using a computer.
- 10 Exhaust vent **60**
- 11 Speaker **50**
- 12 Kensington Security Standard connector
- 13 Rear adjustment foot **27**
- 14 AC socket **24**
Connect the supplied power cord.

Using the Kensington Lock

- This projector has a Kensington Security Standard connector for use with a Kensington MicroSaver Security System. Refer to the information that came with the system for instructions on how to use it to secure the projector.

Part Names and Functions (Continued)

Numbers in refer to the main pages in this operation manual where the topic is explained.

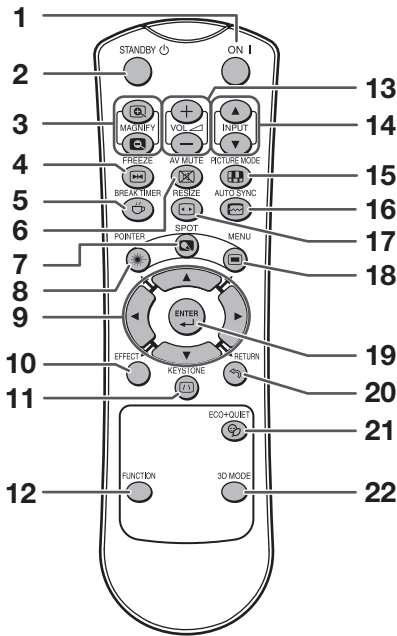

- 1 ON button 25
For turning the power on.
- 2 STANDBY button 25
For putting the projector into the Standby mode.
- 3 MAGNIFY buttons 35
For enlarging/reducing part of the image.
- 4 FREEZE button 35
For freezing images.
- 5 BREAK TIMER button 34
For displaying the break time.
- 6 AV MUTE button 29
For temporarily displaying a black screen and turning off the sound.
- 7 SPOT button 34
For displaying the spotlight.

- 8 POINTER button 34
For displaying the pointer.
- 9 Adjustment buttons (\blacktriangle / \blacktriangledown / \blacktriangleleft / \blacktriangleright) 39
For selecting and adjusting menu items.
- 10 EFFECT button 34
For changing the pointer or spot area.
- 11 KEYSTONE button 28
For entering the Keystone Correction mode.
- 12 FUNCTION button 53
For operating and executing a function assigned to "FUNCTION Button".
- 13 VOL +/- (Volume) buttons 29
For adjusting the speaker sound level.
- 14 INPUT buttons (\blacktriangle / \blacktriangledown) 29
For switching Input mode.
- 15 PICTURE MODE button 35
For selecting the appropriate picture.
- 16 AUTO SYNC button 35, 50
For automatically adjusting images when connected to a computer.
- 17 RESIZE button 30
For switching the picture size (NORMAL, 16:9, etc.).
- 18 MENU button 39
For displaying adjustment and setting screens.
- 19 ENTER button 39
For setting items selected or adjusted on the menu.
- 20 RETURN button 39
For returning to the previous menu screen during menu operations.
- 21 ECO+QUIET button 34
For lowering the noise of the cooling fan and extending the lamp life.
- 22 3D MODE button 59
For displaying the 3D MODE menu screen.

Inserting the Batteries

1 Pull down the tab on the cover and remove the cover towards the direction of the arrow.

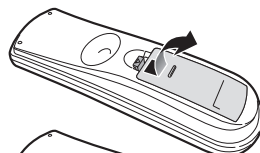

2 Insert the batteries.

- Insert the batteries making sure the polarities correctly match the \oplus and \ominus marks inside the battery compartment.

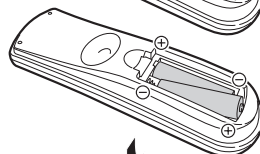

3 Insert the lower tab of the cover into the opening, and lower the cover until it clicks in place.

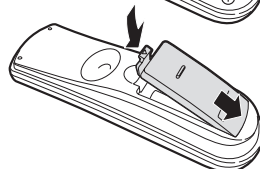

Incorrect use of the batteries may cause them to leak or explode. Please follow the precautions below



Caution

- Danger of explosion if battery is incorrectly replaced. Replace only with alkaline or manganese batteries.
- Insert the batteries making sure the polarities correctly match the \oplus and \ominus marks inside the battery compartment.
- Batteries of different types have different properties, therefore do not mix batteries of different types.
- Do not mix new and old batteries.
- This may shorten the life of new batteries or may cause old batteries to leak.
- Remove the batteries from the remote control once they have run out, as leaving them in can cause them to leak. Battery fluid from leaked batteries is harmful to skin, therefore ensure you wipe them first and then remove them using a cloth.
- The batteries included with this projector may run down in a short period, depending on how they are kept. Be sure to replace them as soon as possible with new batteries.
- Remove the batteries from the remote control if you will not be using the remote control for a long time.
- Comply with the rules (ordinance) of each local government when disposing of worn-out batteries.

Usable Range

The remote control can be used to control the projector within the ranges shown in the illustration.

Note

- The signal from the remote control can be reflected off a screen for easy operation. However, the effective distance of the signal may differ depending on the screen material.

When using the remote control

- Ensure that you do not drop it or expose it to moisture or high temperature.
- The remote control may malfunction under a fluorescent lamp. In this case, move the projector away from the fluorescent lamp.

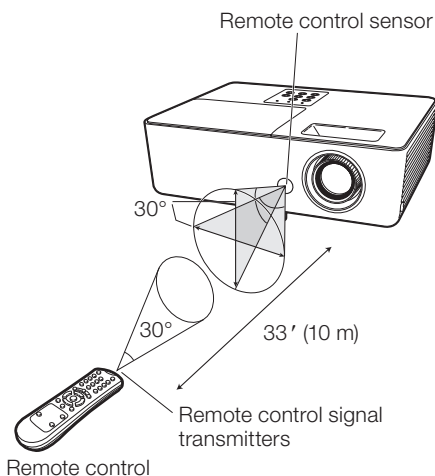

Easy Start

This section shows the basic operation (projector connecting with the computer). For details, see the page described below for each step.

Setup and Projection

In this section, connection of the projector and the computer is explained using one example.

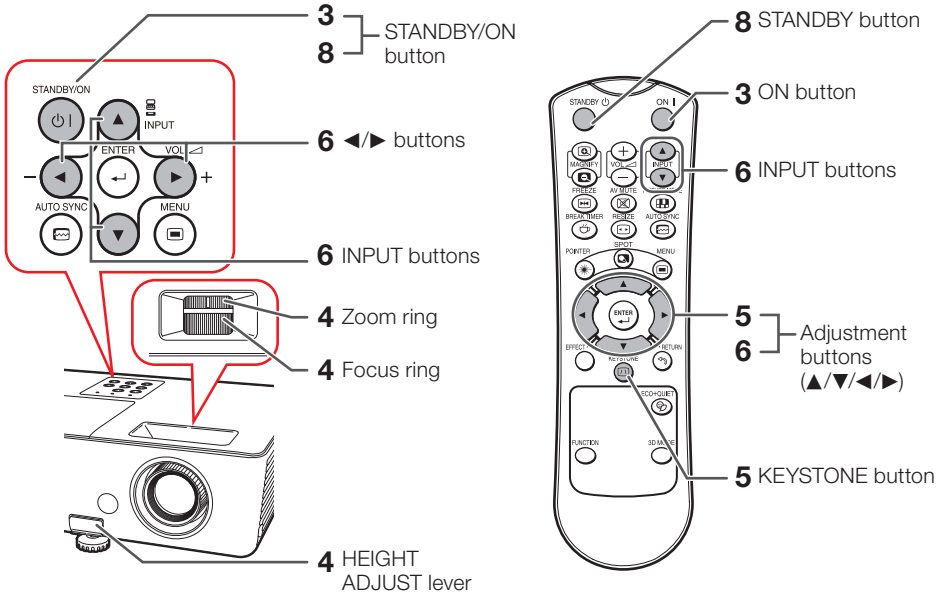

1. Place the projector facing a wall or a screen → P. 16

2. Connect the projector to the computer and plug the power cord into the AC socket of the projector

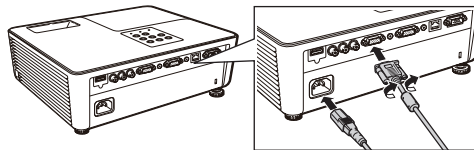

When connecting equipment other than a computer, see pages **21** and **22**.

→ P. 20, 22

3. Turn the projector on

Press **STANDBY/ON** on the projector or **ON** on the remote control.

→ P. 25

4. Adjust the projected image with the Setup Guide

- 1 After the projector turns on, the Setup Guide appears.
(When "Setup Guide" is set to "On". See page 49.)
- 2 Follow the steps in the Setup Guide and adjust the focus, height (angle) and picture size.
- 3 After adjusting the focus, height (angle) and picture size, press **ENTER** to finish the Setup Guide.

→ P. 26

5. Correct trapezoidal distortion

Correcting trapezoidal distortion using Keystone Correction.

On the remote control

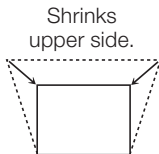

Shrinks upper side.

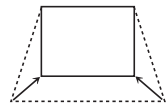

Shrinks lower side.

→ P. 28

6. Select the Input mode

Press **INPUT** ▲/▼ to display the INPUT list. Use **INPUT** ▲/▼ to select the Input mode, and use < / > to select the audio input terminal.

On the projector



On the remote control



INPUT list

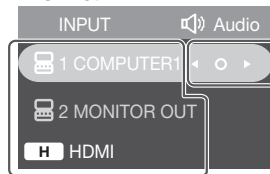

On the projector



On the remote control



→ P. 29

7. Turn the computer on

8. Turn the power off

Press **STANDBY/ON** on the projector or **STANDBY** on the remote control, and then press the button again while the confirmation message is displayed to put the projector into Standby mode.

On the projector



On the remote control



On-screen display



Enter STANDBY mode?

Yes : Press Again

No : Please Wait

→ P. 25

Setting Up the Projector

Video Setup

If using this projector outside the U.S.A., please change setting to "0 IRE" in Video Setup. (See page 46.)

Setting Up the Projector

For optimal image quality, position the projector perpendicular to the screen with the projector's feet flat and level. Doing so will eliminate the need for Keystone correction and provide the best image quality. (See page 28.)

Standard Setup (Front Projection)

- Place the projector at the required distance from the screen according to the desired picture size. (See page 17.)

Indication of the Projection Image Size and Projection Distance

[PG-LW3000/PG-LW3500]

Example: 16:10 Signal Input (Normal Mode)

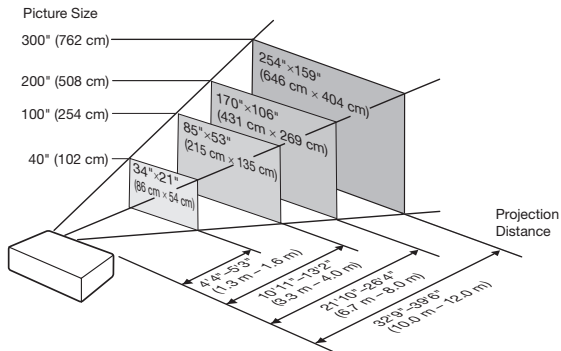

[PG-LX3000/PG-LX3500]

Example: 4:3 Signal Input (Normal Mode)

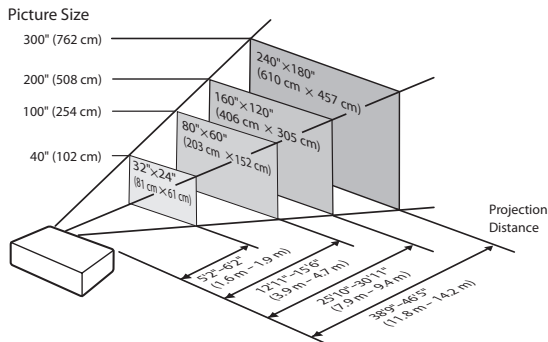

Screen Size and Projection Distance

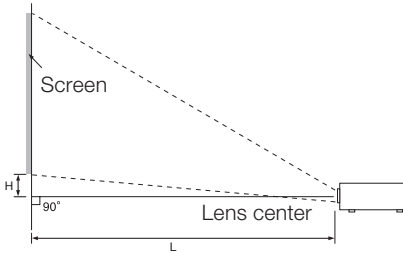

Note

- Allow a margin of error in the values in the diagrams below.

[PG-LW3000/PG-LW3500]

16:10 Signal Input (Normal Mode)

Picture (Screen) size			Projection distance [L]		Distance from the lens center to the bottom of the image [H]
Diag. [χ]	Width	Height	Minimum [L1]	Maximum [L2]	
300" (762 cm)	646 cm (254")	404 cm (159")	10.0 m (32' 9")	12.0 m (39' 6")	7 cm (2 ³⁷ / ₆₄ "
250" (635 cm)	538 cm (212")	337 cm (132")	8.3 m (27' 4")	10.0 m (32' 11")	5 cm (2 ⁹ / ₆₄ "
200" (508 cm)	431 cm (170")	269 cm (106")	6.7 m (21' 10")	8.0 m (26' 4")	4 cm (1 ²³ / ₃₂ "
150" (381 cm)	323 cm (127")	202 cm (79")	5.0 m (16' 5")	6.0 m (19' 9")	3 cm (1 ⁹ / ₃₂ "
120" (305 cm)	258 cm (102")	162 cm (64")	4.0 m (13' 1")	4.8 m (15' 10")	3 cm (1 ¹ / ₃₂ "
100" (254 cm)	215 cm (85")	135 cm (53")	3.3 m (10' 11")	4.0 m (13' 2")	2 cm (0 ⁵⁵ / ₆₄ "
80" (203 cm)	172 cm (68")	108 cm (42")	2.7 m (8' 9")	3.2 m (10' 6")	2 cm (0 ¹¹ / ₁₆ "
60" (152 cm)	129 cm (51")	81 cm (32")	2.0 m (6' 7")	2.4 m (7' 11")	1 cm (0 ³³ / ₆₄ "
40" (102 cm)	86 cm (34")	54 cm (21")	1.3 m (4' 4")	1.6 m (5' 3")	1 cm (0 ¹¹ / ₃₂ "

4:3 Signal Input (Normal Mode)

Picture (Screen) size			Projection distance [L]		Distance from the lens center to the bottom of the image [H]
Diag. [χ]	Width	Height	Minimum [L1]	Maximum [L2]	
300" (762 cm)	610 cm (240")	457 cm (180")	11.3 m (37' 1")	13.6 m (44' 9")	7 cm (2 ²⁹ / ₃₂ "
250" (635 cm)	508 cm (200")	381 cm (150")	9.4 m (30' 11")	11.4 m (37' 3")	6 cm (2 ²⁷ / ₆₄ "
200" (508 cm)	406 cm (160")	305 cm (120")	7.5 m (24' 9")	9.1 m (29' 10")	5 cm (1 ¹⁵ / ₁₆ "
150" (381 cm)	305 cm (120")	229 cm (90")	5.7 m (18' 7")	6.8 m (22' 4")	4 cm (1 ²⁹ / ₆₄ "
120" (305 cm)	244 cm (96")	183 cm (72")	4.5 m (14' 10")	5.5 m (17' 11")	3 cm (1 ¹¹ / ₆₄ "
100" (254 cm)	203 cm (80")	152 cm (60")	3.8 m (12' 4")	4.5 m (14' 11")	2 cm (0 ³¹ / ₃₂ "
80" (203 cm)	163 cm (64")	122 cm (48")	3.0 m (9' 11")	3.6 m (11' 11")	2 cm (0 ²⁵ / ₃₂ "
70" (178 cm)	142 cm (56")	107 cm (42")	2.6 m (8' 5")	3.2 m (10' 5")	2 cm (0 ⁴³ / ₆₄ "
60" (152 cm)	122 cm (48")	91 cm (36")	2.3 m (7' 5")	2.7 m (8' 11")	1 cm (0 ³⁷ / ₆₄ "
40" (102 cm)	81 cm (32")	61 cm (24")	1.5 m (4' 11")	1.8 m (6' 0")	1 cm (0 ²⁵ / ₆₄ "

When using the projector with screen sizes not listed in the above charts, calculate the values according to the formulas.

	16:10 Signal		4:3 Signal	
	[m/cm]	[Feet/inches]	[m/cm]	[Feet/inches]
L1: Minimum projection distance (m/ft)	0.03328χ	0.03328χ / 0.3048	0.03768χ	0.03768χ / 0.3048
L2: Maximum projection distance (m/ft)	0.04013χ	0.04013χ / 0.3048	0.04543χ	0.04543χ / 0.3048
H: Distance from the lens center to the bottom of the image (cm/in)	0.02178χ	0.02178χ / 2.54	0.02466χ	0.02466χ / 2.54

χ : Picture diagonal size : 40"-300"

Screen Size and Projection Distance (Continued)

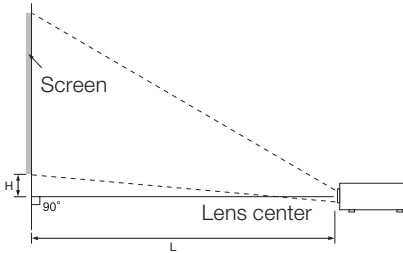

Note

- Allow a margin of error in the values in the diagrams below.

[PG-LX3000/PG-LX3500] 4:3 Signal Input (Normal Mode)

Picture (Screen) size			Projection distance [L]		Distance from the lens center to the bottom of the image [H]
Diag. [χ]	Width	Height	Minimum [L1]	Maximum [L2]	
300" (762 cm)	610 cm (240")	457 cm (180")	11.8 m (38' 9")	14.2 m (46' 5")	17 cm (6 ²³ / ₃₂ ")
250" (635 cm)	508 cm (200")	381 cm (150")	9.9 m (32' 4")	11.8 m (38' 8")	14 cm (5 ¹⁹ / ₃₂ ")
200" (508 cm)	406 cm (160")	305 cm (120")	7.9 m (25' 10")	9.4 m (30' 11")	11 cm (4 ³¹ / ₆₄ ")
150" (381 cm)	305 cm (120")	229 cm (90")	5.9 m (19' 5")	7.1 m (23' 3")	9 cm (3 ²³ / ₆₄ ")
120" (305 cm)	244 cm (96")	183 cm (72")	4.7 m (15' 6")	5.7 m (18' 7")	7 cm (2 ¹¹ / ₁₆ ")
100" (254 cm)	203 cm (80")	152 cm (60")	3.9 m (12' 11")	4.7 m (15' 6")	6 cm (2 ¹⁵ / ₆₄ ")
80" (203 cm)	163 cm (64")	122 cm (48")	3.2 m (10' 4")	3.8 m (12' 5")	5 cm (1 ⁵¹ / ₆₄ ")
70" (178 cm)	142 cm (56")	107 cm (42")	2.8 m (9' 1")	3.3 m (10' 10")	4 cm (1 ⁹ / ₁₆ ")
60" (152 cm)	122 cm (48")	91 cm (36")	2.4 m (7' 9")	2.8 m (9' 3")	3 cm (1 ¹¹ / ₃₂ ")
40" (102 cm)	81 cm (32")	61 cm (24")	1.6 m (5' 2")	1.9 m (6' 2")	2 cm (6 ⁷ / ₆₄ ")

16:9 Signal Input (16:9 Mode)

Picture (Screen) size			Projection distance [L]		Distance from the lens center to the bottom of the image [H]	Adjustable range of image position [S]
Diag. [χ]	Width	Height	Minimum [L1]	Maximum [L2]		
300" (762 cm)	664 cm (261")	374 cm (147")	12.9 m (42' 3")	15.4 m (50' 7")	81 cm (31 ⁵³ / ₆₄ ")	±62 cm (±24 ³³ / ₆₄ ")
250" (635 cm)	553 cm (218")	311 cm (123")	10.7 m (35' 3")	12.8 m (42' 2")	67 cm (26 ¹⁷ / ₃₂ ")	±52 cm (±20 ²⁷ / ₆₄ ")
200" (508 cm)	443 cm (174")	249 cm (98")	8.6 m (28' 2")	10.3 m (33' 9")	54 cm (21 ⁷ / ₃₂ ")	±42 cm (±16 ¹¹ / ₃₂ ")
150" (381 cm)	332 cm (131")	187 cm (74")	6.4 m (21' 2")	7.7 m (25' 3")	40 cm (15 ⁵⁹ / ₆₄ ")	±31 cm (±12 ¹ / ₄ ")
120" (305 cm)	266 cm (105")	149 cm (59")	5.2 m (16' 11")	6.2 m (20' 3")	32 cm (12 ⁴⁷ / ₆₄ ")	±25 cm (±9 ¹³ / ₁₆ ")
100" (254 cm)	221 cm (87")	125 cm (49")	4.3 m (14' 1")	5.1 m (16' 10")	27 cm (10 ³⁹ / ₆₄ ")	±21 cm (±8 ¹¹ / ₆₄ ")
80" (203 cm)	177 cm (70")	100 cm (39")	3.4 m (11' 3")	4.1 m (13' 6")	22 cm (8 ³¹ / ₆₄ ")	±17 cm (±6 ¹⁷ / ₃₂ ")
60" (152 cm)	133 cm (52")	75 cm (29")	2.6 m (8' 5")	3.1 m (10' 1")	16 cm (6 ²³ / ₆₄ ")	±12 cm (±4 ²⁹ / ₃₂ ")
40" (102 cm)	89 cm (35")	50 cm (20")	1.7 m (5' 8")	2.1 m (6' 9")	11 cm (4 ¹ / ₄ ")	±8 cm (±3 ¹⁷ / ₆₄ ")

When using the projector with screen sizes not listed in the above charts, calculate the values according to the formulas.

	16:10 Signal		4:3 Signal	
	[m/cm]	[Feet/inches]	[m/cm]	[Feet/inches]
L1: Minimum projection distance (m/ft)	0.03941χ	0.03941χ / 0.3048	0.04294χ	0.04294χ / 0.3048
L2: Maximum projection distance (m/ft)	0.04717χ	0.04717χ / 0.3048	0.05139χ	0.05139χ / 0.3048
H: Distance from the lens center to the bottom of the image (cm/in)	0.05689χ	0.05689χ / 2.54	0.26952χ	0.26952χ / 2.54
S: Adjustable range of image position (cm/in) See page 43.	-	-	±0.20754χ	±0.20754χ / 2.54

χ : Picture diagonal size : 40"-300"

Setting Up the Projector (Continued)

Projection (PRJ) Mode

The projector can use any of the 4 projection modes shown in the diagram below. Select the mode most appropriate for the projection setting in use. (You can set the PRJ mode in "SCR-ADJ" menu. See page 49.)

- Table mounted, front projection
[Menu item → "Front"]

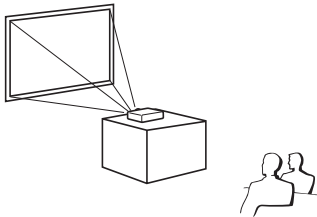

- Ceiling mounted, front projection
[Menu item → "Ceiling + Front"]

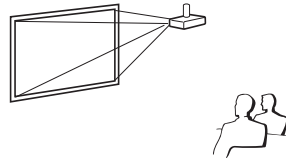

- Table mounted, rear projection
(with a translucent screen)
[Menu item → "Rear"]

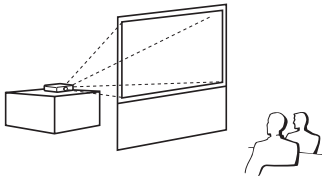

- Ceiling mounted, rear projection
(with a translucent screen)
[Menu item → "Ceiling + Rear"]

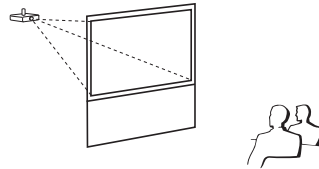

■ Ceiling-Mount Setup

It is recommended that you use the optional Sharp ceiling-mount adaptor and unit for this installation. Before mounting the projector, contact your nearest Sharp Authorized Projector Dealer or Service Center to obtain the recommended ceiling-mount adaptor and unit (sold separately).

Connecting the Projector to Other Equipment

Before connecting, ensure that the power cord of the projector is unplugged from the AC outlet and turn off the equipment to be connected. After making all connections, turn on the projector and then the other pieces of equipment. When connecting a computer, ensure that it is the last equipment to be turned on after all the connections are made.







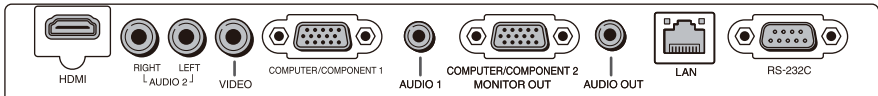

IMPORTANT:

Ensure that the appropriate input mode has been selected on the projector before you turn on the connected equipment.

- For more details of connection and cables, refer to the operation manual of the connecting equipment.
- You may need other cables or connectors not listed below.

Terminals on the Projector

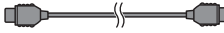











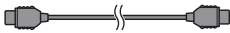

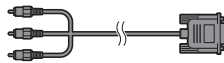
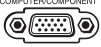

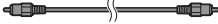

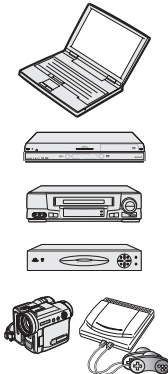

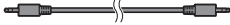
Equipment	Terminal on connected equipment	Cable	Terminal on the projector
	RGB output terminal 	RGB cable (supplied) 	COMPUTER/COMPONENT 1, 2   <small>MONITOR OUT</small>
	HDMI output terminal 	HDMI cable (commercially available) 	HDMI  <small>HDMI</small>

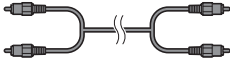
Note



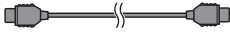







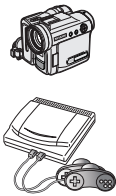

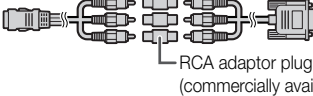

- Depending on specifications of equipment or the DVI⇔HDMI digital cable, the signal transmission may not work properly. (The HDMI specification does not support all connections to equipment that has digital output terminal using a DVI⇔HDMI digital cable.)
- You can also use the COMPUTER/COMPONENT 2 terminal as the MONITOR OUT terminal. To use this terminal as an input terminal, set "COMPUTER2 Select" to "Input" before connecting the external equipment. (See page 52.)
- See page 67 "Compatibility Chart" for a list of computer signals compatible with the projector. Use with computer signals other than those listed may cause some of the functions to not work.
- A Macintosh adaptor may be required for use with some Macintosh computers. Contact your nearest Macintosh Dealer.
- **Depending on the computer you are using, an image may not be projected unless the computer's external output port is switched on (e.g. Press "Fn" and "F5" keys simultaneously when using a SHARP notebook computer).** Refer to the specific instructions in your computer's operation manual to enable your computer's external output port.

Connecting the Projector to Other Equipment (Continued)

Equipment	Terminal on connected equipment	Cable	Terminal on the projector
	HDMI output terminal 	HDMI cable (commercially available) 	HDMI 
	Component video output terminal 	3 RCA to mini D-sub 15 pin cable (commercially available) 	COMPUTER/ COMPONENT 1, 2  
	Video output terminal 	Video cable (commercially available) 	VIDEO 
	ø3.5 mm audio output terminal 	ø3.5 mm stereo or mono audio cable (commercially available or available as Sharp service part QCNWGA038WJPZ) 	AUDIO 1 
	RCA audio output terminal 	RCA audio cable (commercially available) 	AUDIO 2 
	Audio output terminal 	Cables for a camera or a video game 	
	HDMI output terminal 	HDMI cable (commercially available) 	HDMI 

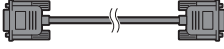
Note

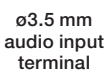
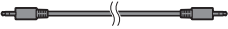
- Depending on specifications of equipment or the DVI-to-HDMI digital cable, the signal transmission may not work properly. (The HDMI specification does not support all connections to equipment that has digital output terminal using a DVI-to-HDMI digital cable.)
- HDMI (High-Definition Multimedia Interface) is a digital AV interface that can deliver a high-definition video signal, multi-channel audio signal, and bi-directional control signal all in just one cable.
- Because it is compatible with the HDCP (High-bandwidth Digital Content Protection) system, the digital video signal does not degrade when transmitted, and a high-quality image with a simple connection can be enjoyed.
- The HDMI terminal does not support the CEC signal.
- You can also use the COMPUTER/COMPONENT 2 terminal as the MONITOR OUT terminal. To use this terminal as an input terminal, set "COMPUTER2 Select" to "Input" before connecting the external equipment. (See page 52.)
- When you connect video equipment with a 21-pin RGB output (Euro-scart) to the projector, use a commercially available cable that fits in the projector terminal you want to connect.
- The projector does not support RGBC signals via the Euro-scart.

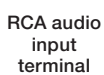
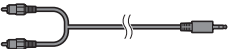
Equipment	Terminal on connected equipment	Cable	Terminal on the projector
Camera/Video game 	Component video output terminal 	Cables for a camera or a video game/3 RCA to mini D-sub 15 pin cable (commercially available)  RCA adaptor plug (commercially available)	COMPUTER/COMPONENT 1, 2  COMPUTER/COMPONENT 2  MONITOR OUT
	Video output terminal 	Cables for a camera or a video game 	VIDEO 
Monitor 	RGB input terminal 	RGB cable (supplied or commercially available) 	MONITOR OUT  COMPUTER/COMPONENT 2 MONITOR OUT
Amplifier 	ø3.5 mm audio input terminal 	ø3.5 mm stereo or mono audio cable (commercially available or available as Sharp service part QCNWGA038WJPZ) 	AUDIO OUT 
	RCA audio input terminal 	ø3.5 mm stereo minijack to RCA audio cable (commercially available) 	

 **Note**

- You can also use the MONITOR OUT terminal as the COMPUTER/COMPONENT 2 terminal. To use this terminal as an output terminal, set "COMPUTER2 Select" to "Monitor Output" before connecting the external equipment. (See page 52.)
- When using the ø3.5 mm mono audio cable, the volume level will be half of when using the ø3.5 mm stereo audio cable.
- You can select AUDIO 1 or AUDIO 2 in the INPUT list. (See page 30.)
- RGB signals and Component signals can be output to the monitor.

This projector is able to process the following signals when connected to HDMI equipment:

- Video signal: For details, see "Digital Support" in the list of "Compatibility Chart" on page 67.
- Audio signal: Linear PCM audio
- Sampling frequency: 48kHz/44.1kHz/32kHz

Controlling the Projector by a Computer

When the RS-232C terminal on the projector is connected to a computer with an RS-232C serial control cable (cross type, commercially available), the computer can be used to control the projector and check the status of the projector. Refer to the "SETUP MANUAL" contained on the supplied CD-ROM for "RS-232C Specifications and Commands".

When connecting to a computer using an RS-232C serial control cable

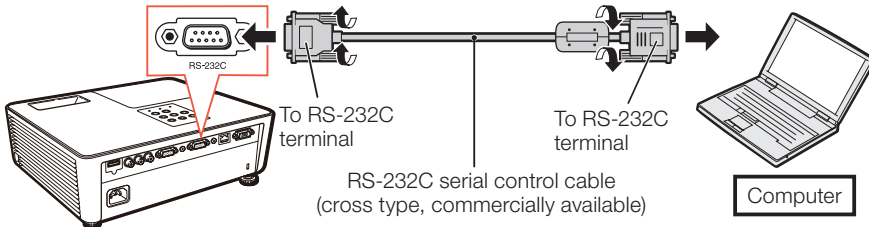

Note

- The RS-232C function may not operate if your computer terminal is not correctly set up. Refer to the operation manual of the computer for details.

Info

- Do not connect the RS-232C cable to a port other than the RS-232C terminal on the computer. This may damage your computer or projector.
- Do not connect or disconnect an RS-232C serial control cable to or from the computer while it is on. This may damage your computer.

RS-232C Terminal: D-sub 9 pin male connector

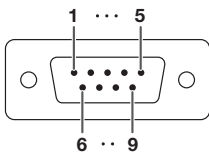

Pin No.	Signal	Name	I/O	Reference
1.				Not connected
2.	RD	Receive Data	Input	Connected to internal circuit
3.	SD	Send Data	Output	Connected to internal circuit
4.				Not connected
5.	SG	Signal Ground		Connected to internal circuit
6.				Not connected
7.	RS	Request to Send		Connected to CS in internal circuit
8.	CS	Clear to Send		Connected to RS in internal circuit
9.				Not connected

RS-232C Cable recommended connection: D-sub 9 pin female connector

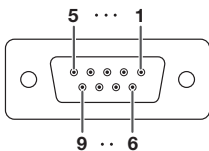

Pin No.	Signal	Pin No.	Signal
1.	CD	1.	CD
2.	RD	2.	RD
3.	SD	3.	SD
4.	ER	4.	ER
5.	SG	5.	SG
6.	DR	6.	DR
7.	RS	7.	RS
8.	CS	8.	CS
9.	CI	9.	CI

Note

- Depending on the controlling device used, it may be necessary to connect Pin 4 and Pin 6 on the controlling device (e.g. computer).

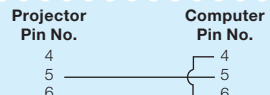

When connecting to the LAN terminal using a LAN cable

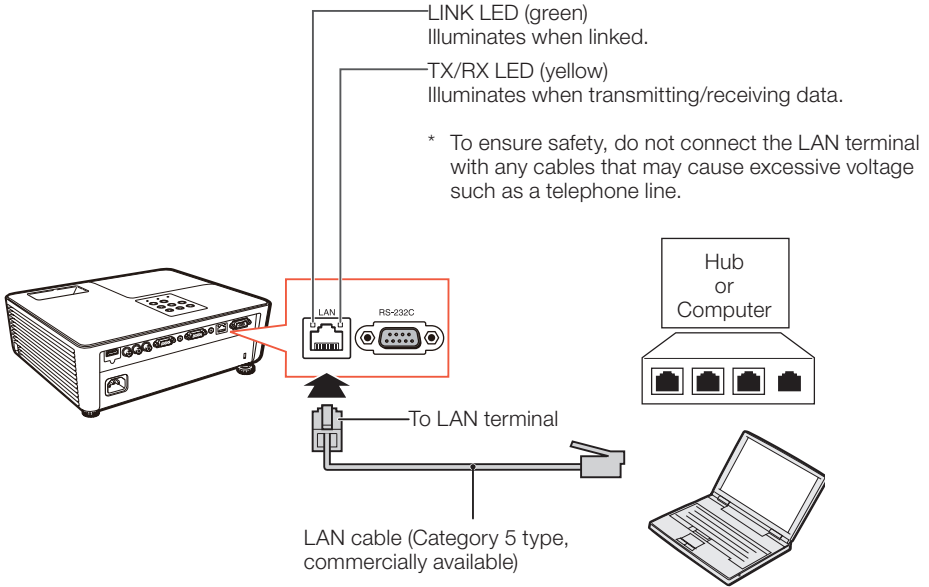

Note

- When connecting to a hub, use a straight-through Category 5 (CAT.5) type cable (commercially available).
- When connecting to a computer, use a cross-over Category 5 (CAT.5) type cable (commercially available).

Connecting the Power Cord

Plug the supplied power cord into the AC socket on the rear of the projector. Then plug into AC outlet.

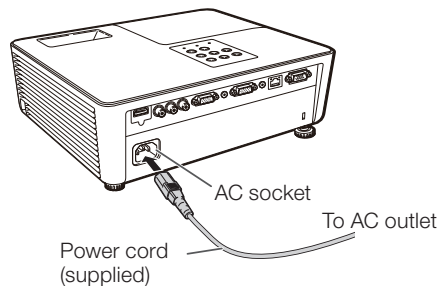

Turning the Projector On/Off

Turning the Projector On

Note that the connections to external equipment and power outlet should be done before performing the operations written below. (See pages 20 to 22.)

Press **STANDBY/ON** on the projector or **ON** on the remote control.

- The power indicator illuminates green.
- After the lamp indicator illuminates, the projector is ready to start operation.

Note

About the Lamp Indicator

The lamp indicator illuminates to indicate the status of the lamp.

Green: The lamp is on.

Blinking in green: The lamp is warming up.

Red: The lamp is shut down abnormally or the lamp should be replaced.

- When switching on the projector, a slight flickering of the image may be experienced within the first minute after the lamp has been illuminated. This is normal operation as the lamp's control circuitry is stabilising the lamp output characteristics. It should not be regarded as faulty operation.
- If the projector is put into Standby mode and immediately turned on again, the lamp may take some time to start projection.
- When System Lock is set, the keycode input box appears. To cancel the keycode setting, input the keycode that you have already set. See page 51 for details.

Turning the Power Off (Putting the Projector into Standby Mode)

Press **STANDBY/ON** on the projector or **STANDBY** on the remote control, then press that button again while the confirmation message is displayed, to put the projector into Standby mode.

- The projector cannot be turned on while cooling.

Info

When "Auto Restart" is set to "On":

- If the power cord is unplugged from the outlet or the breaker switch is turned off when the projector is on, then the projector automatically turns on when the power cord is plugged into the AC outlet or the breaker switch is turned on. (See page 50.)
- English is the factory default language. If you want to change the on-screen display to another language, change the language according to the procedure on page 49.

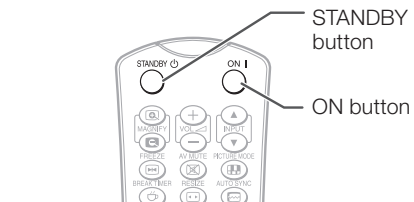
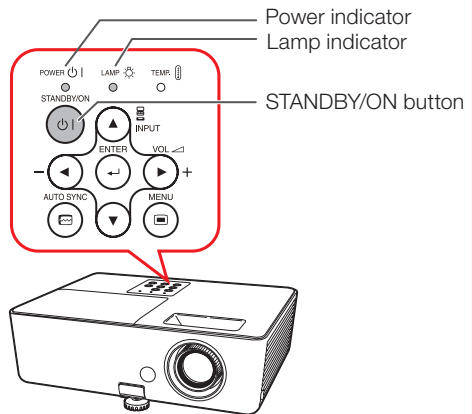

On-screen display (confirmation message)

 Enter STANDBY mode?
Yes : Press Again
No : Please Wait

Info

Direct Power Off function:

You can unplug the power cord from the AC outlet even if the cooling fan is still running.

Image Projection

About the Setup Guide

After turning on the projector, the Setup Guide screen appears to assist you with projector setup.

- Guidance items
- 1 FOCUS
- 2 HEIGHT ADJUST
- 3 ZOOM

Press **ENTER** to exit the Setup Guide screen.

Note

- The Setup Guide screen automatically highlights the items in the following order:

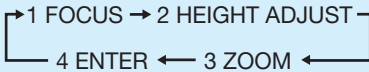

However, you can adjust the focus, height (angle) or zoom regardless of the highlighted item.

- If you do not want to display the Setup Guide for the next time, set "Menu" - "SCR-ADJ" - "Setup Guide" to "Off". (See page 49.)

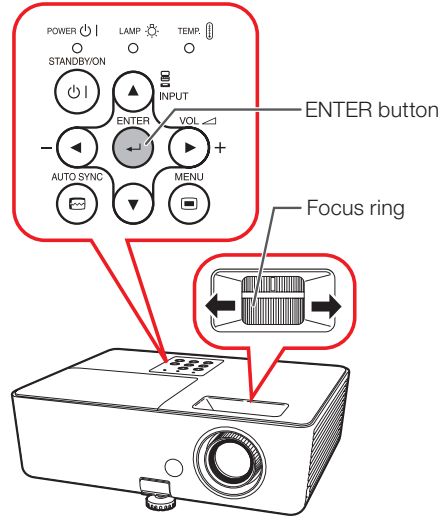

Adjusting the Projected Image

1 Adjusting the Focus

You can adjust the focus with the focus ring on the projector.

Rotate the focus ring to adjust the focus while watching the projected image.

- Using the knob on the focus ring will make the adjustments easier.

2 Adjusting the Height

The height of the projector can be adjusted using the adjustment feet at the front and rear of the projector.

When the screen is above the projector, the projection image can be made higher by adjusting the projector.

- 1 Lift the projector to adjust its height while lifting the HEIGHT ADJUST lever.**

- 2 Remove your hands from the HEIGHT ADJUST lever of the projector after its height has been finely adjusted.**

- The angle of projection is adjustable up to 9 degrees from the surface on which the projector is placed.

- 3 Use the rear adjustment foot to make the projector level.**

- The projector is adjustable ± 2 degrees from the standard position.

Note

- When adjusting the height of the projector, trapezoidal distortion occurs. Follow the procedures in Keystone Correction to correct the distortion. (See pages 28 and 47.)

3 Adjusting the Picture Size

You can adjust the picture size using the zoom ring on the projector.

Rotate the zoom ring to enlarge or shrink the picture size.

- Using the knob on the zoom ring will make the adjustments easier.

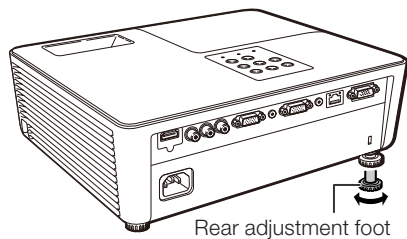
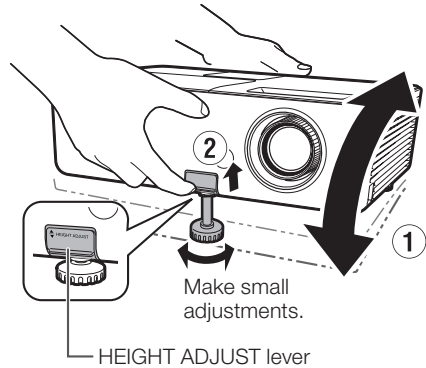

Info

- Do not apply too much pressure on the projector when the front adjustment foot comes out.
- When lowering the projector, be careful not to get your fingers caught in the area between the adjustment foot and the projector.
- Hold the projector firmly while lifting or carrying.
- Do not hold by the lens area.

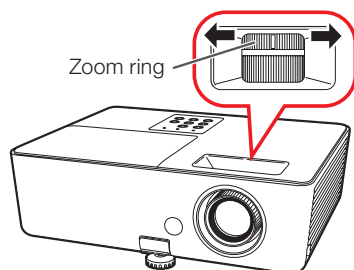

Image Projection (Continued)

Correcting Trapezoidal Distortion

When the image is projected either from the top or from the bottom towards the screen at an angle, the image becomes distorted trapezoidally. The function for correcting trapezoidal distortion is called Keystone Correction.

Note

- The Keystone Correction can be adjusted up to an angle of approximately ± 40 degrees and the screen can also be set up to an angle of approximately ± 40 degrees (When the Resize mode is set to "NORMAL" (see page 30)).

1 Press **KEYSTONE** to enter the Keystone Correction mode.

2 Press **▲/▶** or **◀/▼** to adjust the Keystone Correction.

Note

- To return to the default setting, press **RETURN** while the on-screen display of the Keystone Correction mode is on the screen.

3 Press **KEYSTONE**.

- The on-screen display of the Keystone Correction mode will disappear.

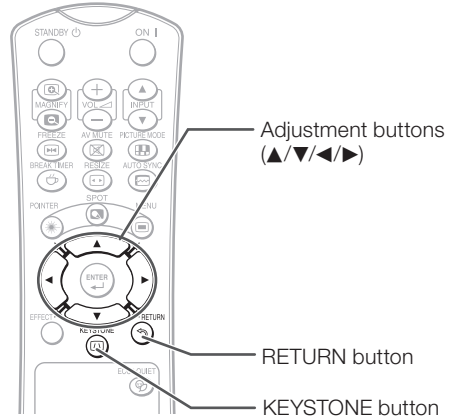

On-screen display
(Keystone Correction mode)

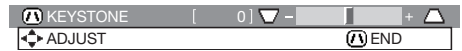

Shrinks upper side.
(Move the slide bar in the + direction.)

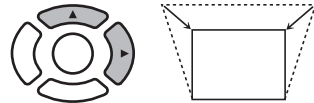

Shrinks lower side.
(Move the slide bar in the - direction.)

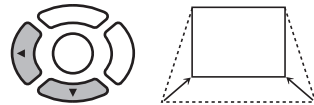

Info

- While adjusting the image using Keystone Correction, straight lines and the edges of the image may appear jagged.

Switching the Input Mode

Select the appropriate Input mode for the connected equipment.

Press **INPUT ▲/▼** to display the **INPUT** list.

Use **INPUT ▲/▼** to select the Input mode.

When you select HDMI input, use **◀/▶** to select the audio input terminal (HDMI or AUDIO).

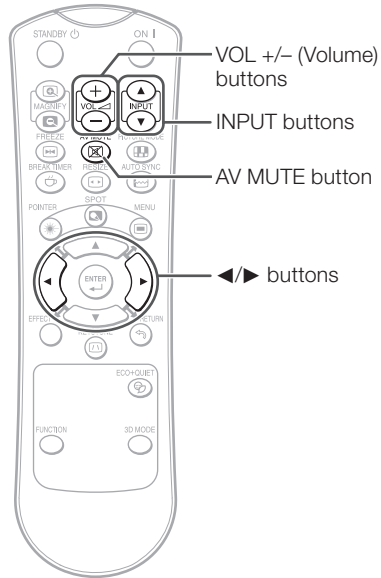

Adjusting the Volume

Press **VOL +/-** on the remote control or **-◀/▶+** on the projector to adjust the volume.



Note

- Pressing **VOL-/-◀** will lower the volume.
- Pressing **VOL+/>▶+** will raise the volume.

On-screen display



Displaying the Black Screen and Turning Off the Sound Temporarily

Press **AV MUTE** on the remote control to temporarily display a black screen and turn off the sound.



Note

- Pressing **AV MUTE** again will turn the projected image back on.

On-screen display



Image Projection (Continued)

Resize Mode

This function allows you to modify or customize the Resize mode to enhance the input image. Depending on the input signal, you can choose a desired image.

Press **RESIZE**.

- See page 47 for setting on menu screen.

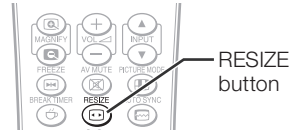

RESIZE button

COMPUTER [PG-LW3000/PG-LW3500]

		NORMAL	FULL	NATIVE	16:9
4:3 aspect ratio	SVGA (800 × 600)	1068 × 800	1280 × 800	800 × 600	1280 × 720
	XGA (1024 × 768)			1024 × 768	
	SXGA (1152 × 864)			1152 × 864	
	SXGA+ (1400 × 1050)			1400 × 1050	
Other aspect ratios	SXGA (1280 × 1024)	1000 × 800	1280 × 800	1280 × 1024	—
	1280 × 720	1280 × 720			
	1360 × 768	1280 × 722			
	1366 × 768	1280 × 720		1360 × 768	—
	1280 × 768	1280 × 768			
	1280 × 800	1280 × 800		—	

Input signal		Output screen image			
Computer	Image type	NORMAL	FULL	NATIVE	16:9
Resolution XGA and below	 4:3 aspect ratio				
Resolution higher than XGA					
SXGA (1280 × 1024)	 5:4 aspect ratio				
1280 × 720	 16:9 aspect ratio			—*2	—*2
1360 × 768 1366 × 768	 16:9 aspect ratio				
1280 × 768	 15:9 aspect ratio			—*2	
1280 × 800	 16:10 aspect ratio		—*2	—*2	

: Cutout area on which images cannot be projected































: Area where the signals are off screen

*1 The Image Shift function can be used for these images.

*2 Same as NORMAL mode.

*3 In case SXGA+ input.

VIDEO/DTV [PG-LW3000/PG-LW3500]

Input signal		Output screen image			
Video/DTV	Image type	NORMAL	AREA ZOOM	V-STRETCH	16:9
480I, 480P, 576I, 576P, NTSC, PAL, SECAM	 4:3 aspect ratio				 *1
	 Squeeze				 *1
	 Letter box				 *1
720P, 1035I, 1080I, 1080P	 16:9 aspect ratio	 *1			— *2
	 16:9 aspect ratio	 *1			
540P	 16:9 aspect ratio	 *1			
	 16:9 aspect ratio (4:3 aspect ratio in 16:9)	 *1			

 : Cutout area on which images cannot be projected

 : Area on which the image is not included in the original signals

*1 The Image Shift function can be used for these images.

*2 Same as NORMAL mode.

About Copyrights

- When using the Resize function to select an image size with a different aspect ratio to a TV program or video image, the image will look different from its original appearance. Keep this in mind while choosing an image size.
- The use of the Resize or Keystone Correction function to compress or stretch the image for commercial purposes/public displays in a café, hotel, etc. may be an infringement of copyright protected by law for copyright holders. Please use caution.

Image Projection (Continued)

Resize Mode

This function allows you to modify or customize the Resize mode to enhance the input image. Depending on the input signal, you can choose a desired image.

Press **RESIZE**.

- See page 47 for setting on menu screen.



RESIZE button

COMPUTER [PG-LX3000/PG-LX3500]

	Main resolution	NORMAL	FULL	NATIVE	BORDER	16:9
4:3 aspect ratio	SVGA (800 × 600)	1024 × 768	—	800 × 600	768 × 576	1024 × 576
	XGA (1024 × 768)			—		
	SXGA (1152 × 864)			1152 × 864		
	UXGA (1600 × 1200)			1600 × 1200		
Other aspect ratios	SXGA (1280 × 1024)	968 × 768	1024 × 768	1280 × 1024	720 × 576	1024 × 576
	1280 × 720	1024 × 576		1280 × 720	—	
	1360 × 768	1024 × 578		1360 × 768	—	
	1366 × 768	1024 × 576		1366 × 768	—	
	1280 × 768	1024 × 614		1280 × 768	960 × 576	
	1280 × 800	1024 × 640		1280 × 800	922 × 576	

Input signal		For 4:3 screen			For 16:9 screen		
Computer	Image type	NORMAL	FULL	NATIVE	BORDER	16:9	
Resolution lower than XGA	 4:3 aspect ratio		—*2		 *1	 *1	
XGA				—*2			—*2
Resolution higher than XGA							
SXGA (1280 × 1024)	 5:4 aspect ratio						
1280 × 720	 16:9 aspect ratio	 *1			—*2	—*2	
1360 × 768 1366 × 768							
1280 × 768							
1280 × 800	 16:10 aspect ratio	 *1			 *1	 *1	

























: Cutout area on which images cannot be projected

: Area where the signals are off screen

*1 The Image Shift function can be used for these images.

*2 Same as NORMAL mode

VIDEO/DTV [PG-LX3000/PG-LX3500]

Input signal		For 4:3 screen			For 16:9 screen	
Video/DTV	Image type	NORMAL	AREA ZOOM	V-STRETCH	BORDER	16:9
480I, 480P, 576I, 576P, NTSC, PAL, SECAM	 4:3 aspect ratio				 *1	 *1
	 Squeeze				 *1	 *1
	 Letter box					 *1
720P, 1035I, 1080I, 1080P	 16:9 aspect ratio	 *1				
540P	 16:9 aspect ratio	 *1			—*2	—*2
	 (4:3 aspect ratio in 16:9)	 *1				

 : Cutout area on which images cannot be projected

 : Area on which the image is not included in the original signals

*1 The Image Shift function can be used for these images.

*2 Same as NORMAL mode.

About Copyrights

- When using the Resize function to select an image size with a different aspect ratio to a TV program or video image, the image will look different from its original appearance. Keep this in mind while choosing an image size.
- The use of the Resize or Keystone Correction function to compress or stretch the image for commercial purposes/public displays in a café, hotel, etc. may be an infringement of copyright protected by law for copyright holders. Please use caution.

Operating with the Remote Control

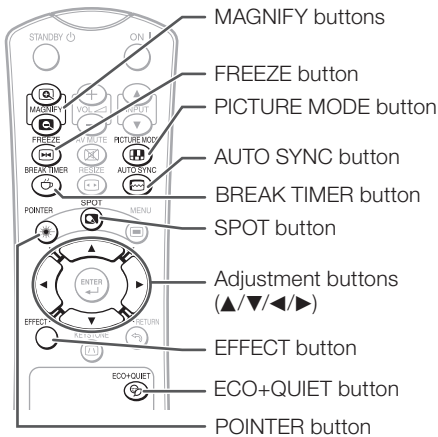

Displaying the Pointer

- 1 Press **POINTER** and press ▲/▼/◀/▶ on the remote control to move the pointer.
 - Press **EFFECT** to change the pointer icon (5 types).

Star	Finger1	Finger2	Heart	Underline

- 2 Press **POINTER** again.
 - The pointer will disappear.

Displaying and Setting the Break Timer

- 1 Press **BREAK TIMER**.
 - The timer starts to count down from 5 minutes.

On-screen display



- 2 Press ▲/▼/◀/▶ to adjust the length of the break time.
 - **Increases with ▲ or ▶**
5 minutes → 6 minutes → 60 minutes
 - **Shortens with ◀ or ▼**
4 minutes → 3 minutes → 1 minute
 - The break time can be set in units of one minute (up to 60 minutes).

Canceling the break timer display function

Press **BREAK TIMER**.

Note

- The Break Timer is not available while the projector is operating the following functions.
 - Auto Sync
 - Freeze
 - AV Mute
 - Input Search

Using the Spot Function

- 1 Press **SPOT** and press ▲/▼/◀/▶ on the remote control to move the spot area.
 - Press **EFFECT** to change the spot area size (3 types).

1/9	1/25	1/8

- 2 Press **SPOT** again.
 - The spot area will disappear.

Switching the Eco+Quiet Mode

Press **ECO+QUIET** to switch the Eco+Quiet mode between on and off.

- When the Eco+Quiet Mode is set to "ON", the sound of the cooling fan will turn down, the power consumption will decrease, and the lamp life will extend.

Note

- Refer to "Eco+Quiet" on page 44 for details.

Auto Sync (Auto Sync Adjustment)

Auto Sync function works when detecting input signal after the projector turns on.

Press **AUTO SYNC** to manually adjust with Auto Sync function.

Note

- When the optimum image cannot be achieved with Auto Sync adjustment, use manual adjustments. (See page 45.)

Freezing a Moving Image

1 Press **FREEZE**.
• The projected image is frozen.

2 Press **FREEZE** again to return to the moving image from the currently connected device.

Selecting the Picture Mode

You can select the appropriate Picture mode for the projected image, such as movie or video game.

Press **PICTURE MODE**.

- When pressing **PICTURE MODE**, the Picture mode changes in the following order:

→ STANDARD → PRESENTATION → MOVIE → GAME → sRGB*

Note

- See page 42 for details on the Picture mode.

* "sRGB" is displayed only when RGB signal is input.

Displaying an Enlarged Portion of an Image

Graphs, tables and other portions of projected images can be enlarged. This is helpful when providing more detailed explanations.

1 Press **MAGNIFY** on the remote control.
• Enlarges the image.
• Pressing **MAGNIFY** enlarges or reduces the projected image.

Note

Press **MAGNIFY**.

→

×1 ×2 ×3 ×4

←

Press **MAGNIFY**.

- You can change the location of the enlarged image using **▲**, **▼**, **◀** and **▶**.

2 Press **RETURN** on the remote control to cancel the operation.
• The magnification then returns to ×1.

Note

- The selectable magnifications differ depending on the input signal.
- In the following cases, the image will return to the normal size (×1).
 - When switching the Input mode.
 - When **RETURN** has been pressed.
 - When the input signal is changed.
 - When the input signal resolution and refresh rate (vertical frequency) change.
 - When the Resize mode is changed.



Menu Items

The following shows the items that can be set in the projector.

“Quick Start Menu”

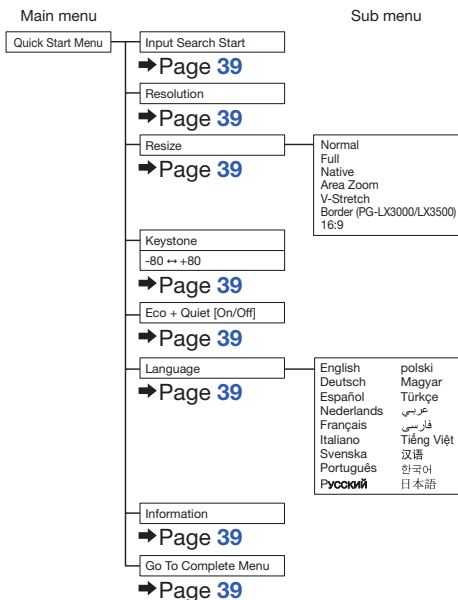

“Picture” menu

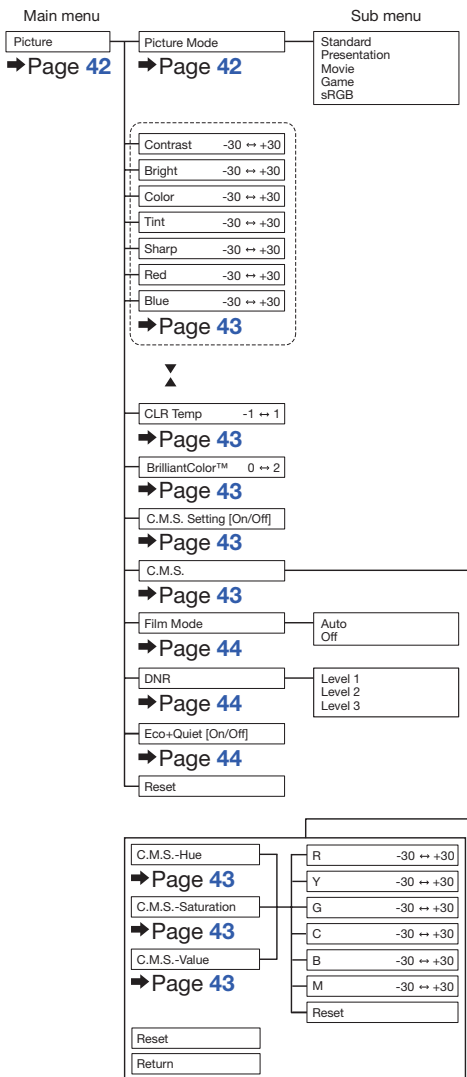

“Signal adjustment (SIG-ADJ)” menu

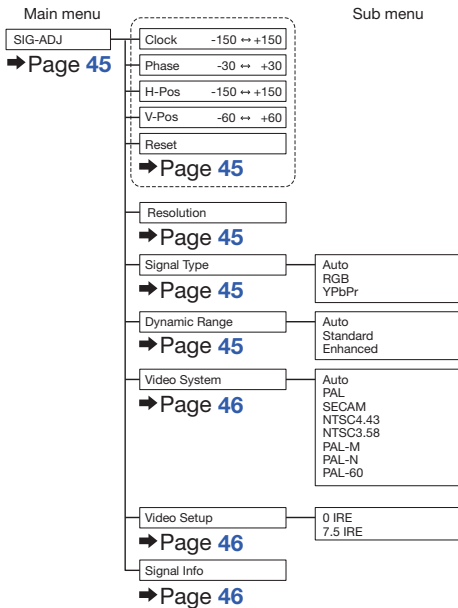

“Screen adjustment (SCR-ADJ)” menu

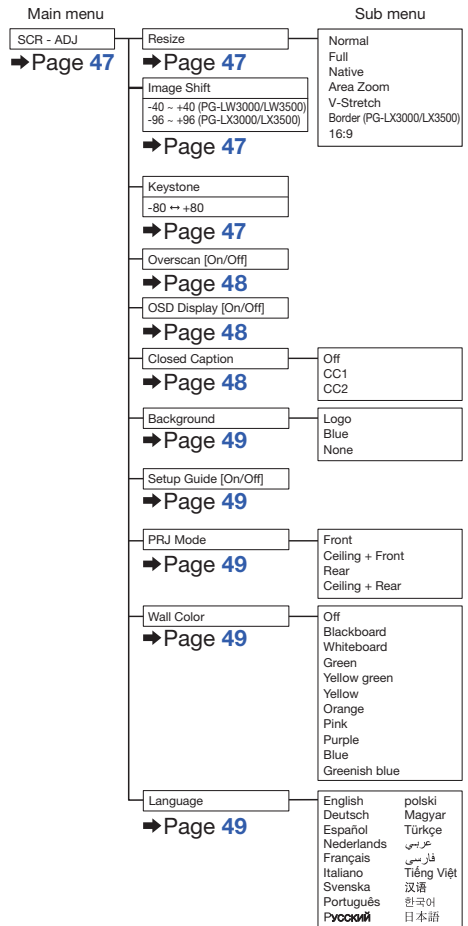



Menu Items (Continued)

“Projector adjustment (PRJ-ADJ1/2)” menu

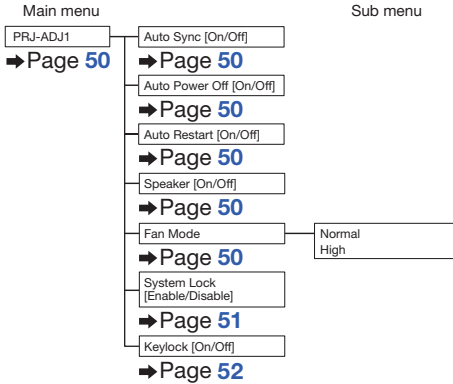

“Network” menu

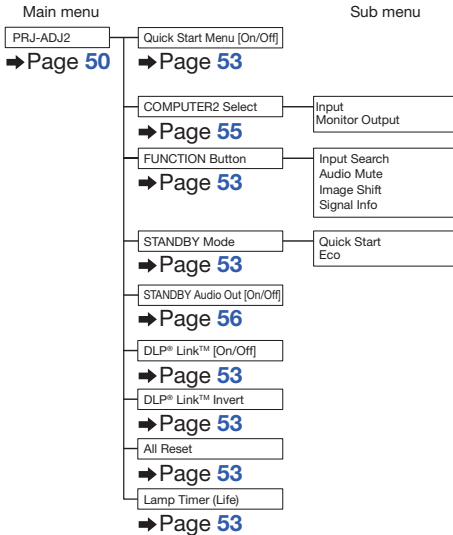
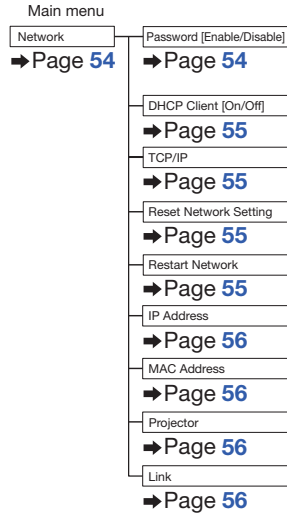

Using the Menu Screen

Select from the Quick Start Menu, which is a collection of the most frequently used functions, or the Complete Menu, which enables advanced settings and adjustments.

Adjustment buttons (▲/▼/◀/▶)

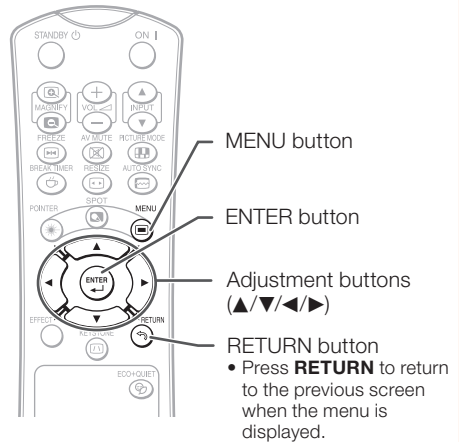
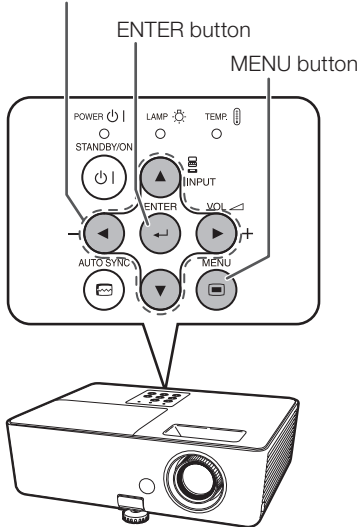

Menu Selections (Quick Start Menu)

• This operation can also be performed by using the buttons on the projector.

- 1 Press MENU.**
 - The "Quick Start Menu" screen for the selected Input mode is displayed.
- 2 Press ▲ or ▼ to select the desired item, then press ENTER.**
- 3 Press ▲/▼/◀/▶ to adjust the item selected, then press ENTER.**

Example

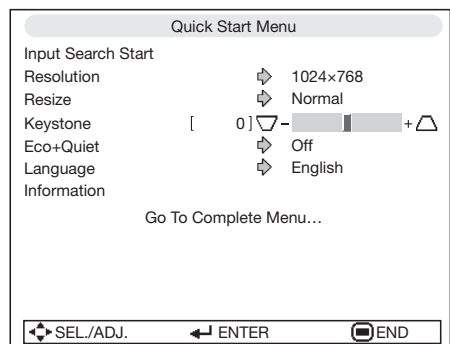

Info

- To display the advanced settings and adjustments, select "Go To Complete Menu". Press **ENTER** to display the Complete Menu screen.
- If you do not want to display the Quick Start Menu, set "Go To Complete Menu" - "PRJ-ADJ2" - "Quick Start Menu" to "Off". (See page 53.)

Using the Menu Screen (Continued)

Quick Start Menu

The following items can be configured on the Quick Start Menu.

Selectable items	Description
Input Search Start	Automatically searches for and switches to the appropriate Input mode. Pressing an operation button during input searching cancels the search.
Resolution	Manually change the resolution. Use this function when the image and screen size do not match with the resolution selected automatically. (See page 45.)
Resize	Changes the Resize mode. Use this function to stretch the image vertically or horizontally or when the edges of the image cannot be seen. (See page 47.)
Keystone	Corrects the keystone distortion of projected images. Use this function to correct the trapezoidal distortion of images caused when projecting images at an angle to the screen. (See page 47.)
Eco+Quiet	When set to "On", this function reduces the cooling fan noise and power consumption, thereby prolonging the operating life of the lamp. (See page 44.)
Language	Selects the language displayed on the screen. (See page 49.)
Information	Displays the input signal, lamp use time, remaining lamp life, etc.
Go To Complete Menu	Displays the Complete Menu for advanced settings and adjustments.



Note

- The setting of Resize mode will be made independently for each Input mode.
- The setting of Eco+Quiet mode will be made independently for each Input mode and each Picture mode.

Menu Selections (Complete Menu)

Example: Adjusting "Bright".

- This operation can also be performed by using the buttons on the projector.

1

Press **MENU**.

- The "Quick Start Menu" screen is displayed.

2

Press **▲** or **▼** to select "Go To Complete Menu".

3

Press **▶** or **◀** and select "Picture" to adjust.



Info

- When "PRJ-ADJ2" - "Quick Start Menu" is set to "On", pressing **MENU** displays the Quick Start Menu screen.

Example: "Picture" screen menu for COMPUTER (RGB) input

Menu item

Picture	SIG	SCR	PRJ1	PRJ2
Picture Mode			Standard	
Contrast	[0]			+ []
Bright	[0]			+ []
Red	[0]			+ []
Blue	[0]			+ []
CLR Temp	[0]			+ []
BrilliantColor™	[1]			+ []
C.M.S. Setting			On	
C.M.S.				
DNR			Level 2	
Eco+Quiet			Off	
◆◆◆ Reset				
◀ SEL./ADJ. ENTER END ▶				

4 Press ▲ or ▼ and select “Bright” to adjust.

- The selected item is highlighted.

To adjust the projected image while watching it

Press ENTER.

- The selected item (e.g. “Bright”) is displayed by itself at the bottom of the screen.
- When pressing ▲ or ▼, the following item (“Red” after “Bright”) will be displayed.



Note

- Press **ENTER** again to return to the previous screen.

5 Press ◀ or ▶ to adjust the item selected.

- The adjustment is stored.

6 Press MENU.

- The menu screen will disappear.



Note

- The **MENU** button is not available while the projector is operating:
 - Auto Sync/Break Timer/Freeze/AV Mute/Input Search

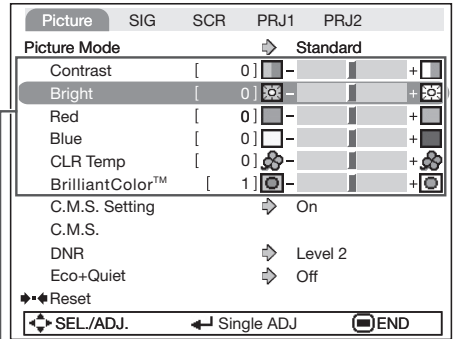

Items to be adjusted



Press **ENTER**.

The item displayed by itself

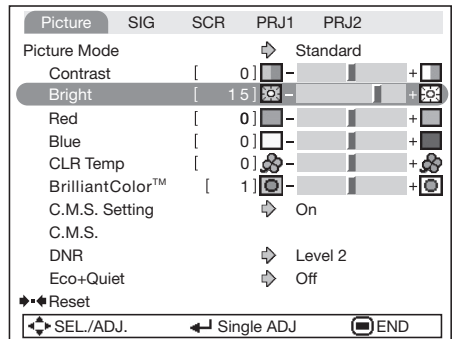
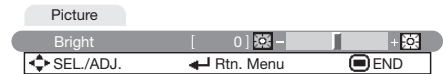

Picture Adjustment (“Picture” Menu)

Menu operation → Page 40

▶ PAGE1

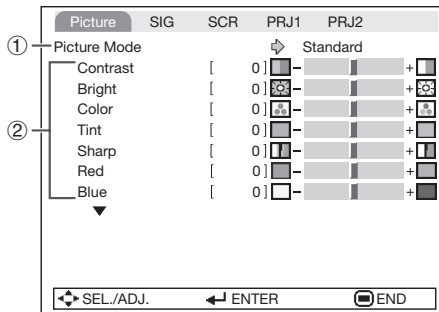

▶ PAGE2

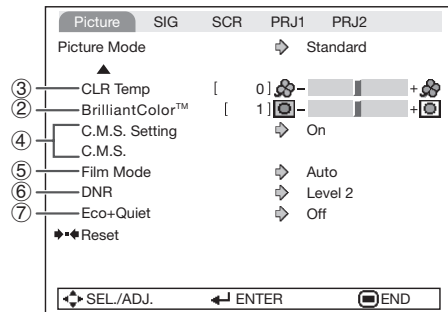

① Selecting the Picture Mode

Selectable items	Description	The default settings of each item when selecting Picture Mode		
		CLR Temp	BrilliantColor™	Eco+Quiet
Standard	For standard image	0	1	Off
Presentation	Brightens portions of image for more enhanced presentations.	0	2	Off
Movie	Gives natural tint to the projected image.	-1	0	On
Game	Gives sharpness to the projected image.	0	1	Off
*sRGB	For high fidelity reproduction of images from a computer.	-	-	Off

- “sRGB” is displayed only when RGB signal is input.
- You can set or adjust each item in the “Picture” menu to your preference. Any changes you make are retained in memory.

Note

- You can also press **PICTURE MODE** on the remote control to select the Picture mode. (See page 35.)
- *sRGB is an international standard of color reproduction regulated by the IEC (International Electrotechnical Commission). As the fixed color area has been decided by the IEC, the images are displayed in a natural tint based on an original image, when “sRGB” is selected. You cannot set the items, “Red”, “Blue”, “CLR Temp”, “BrilliantColor™” and “C.M.S.”, when “sRGB” is selected.

Info

- When “sRGB” is selected, the projected image may become dark, but this does not indicate a malfunction.

② Adjusting the Image

Adjustment items	◀ button	▶ button
Contrast	For less contrast.	For more contrast.
Bright	For less brightness.	For more brightness.
Color*1	For less color intensity.	For more color intensity.
Tint*1	For making skin tones purplish.	For making skin tones greenish.
Sharp*1	For less sharpness.	For more sharpness.
Red*2	For weaker red.	For stronger red.
Blue*2	For weaker blue.	For stronger blue.
BrilliantColor™*2 *3	For making the effect weaker.	For making the effect stronger.

*1 Not displayed in the RGB input mode.

*2 Not adjustable/selectable when selecting "sRGB".

*3 BrilliantColor™ uses Texas Instruments' BrilliantColor™ technology. As the BrilliantColor™ level is increased, the image becomes brighter while the color reproduction is kept at a high level.



Note

- To reset all adjustment items, select "Reset" and press **ENTER**.

③ Adjusting the Color Temperature

Selectable items	Description
-1	For lower color temperature for warmer, reddish incandescent-like images.
0	↕
1	For higher color temperature for cooler, bluish, fluorescent-like images.



Note

- Values on "CLR Temp" are only for general standard purposes.

④ Adjusting the Colors

This function adjusts each of the six main colors that comprise the color wheel, altering their "Hue", "Saturation", or "Value".

Selectable items	Description
C.M.S.-Hue	Sets the hue of the main colors.
C.M.S.-Saturation	Sets the saturation of the main colors
C.M.S.-Value	Sets the brightness of the main colors.
Reset	The adjustments of "Hue", "Saturation" and "Value" of all colors are reset to the default setting.
Return	Returns to the "Picture" menu screen.

Adjusting "Hue", "Saturation", or "Value".

- Select "On" for "C.M.S. Setting" in the "Picture" menu and then press **ENTER**.
- Select "C.M.S." in the "Picture" menu and then press **ENTER**.
- Press ▲ or ▼ to select either "Hue", "Saturation", or "Value" and then press **ENTER**.
- Select the color to be adjusted with ▲ or ▼ and adjust it with ◀ or ▶.

Example of adjusting the "Hue"

Main colors	◀ button	▶ button
R (Red)	Closer to magenta	Closer to yellow
Y (Yellow)	Closer to red	Closer to green
G (Green)	Closer to yellow	Closer to cyan
C (Cyan)	Closer to green	Closer to blue
B (Blue)	Closer to cyan	Closer to magenta
M (Magenta)	Closer to blue	Closer to red

- When "Saturation" is selected, the selected color becomes
◀: lighter. ▶: thicker.
- When "Value" is selected, the selected color becomes
◀: darker. ▶: brighter.
- To reset the adjustment values of each color to the default settings, select "Reset" and press **ENTER**.

Picture Adjustment (“Picture” Menu) (Continued)

Menu operation → Page 40

⑤ Selecting the Film Mode

This function provides high-quality playback of images originally projected at 24 fps, such as movies on DVDs.

Selectable items	Description
Auto	Films are detected automatically.
Off	Films are not detected.

Note

- This function is available for the following signals.
With COMPUTER/COMPONENT input:
 - 480I
 - 576I
 - 1035I (PG-LW3000/LW3500 only)
 - 1080I (PG-LW3000/LW3500 only)With VIDEO input:
 - All signals

⑥ Reducing Image Noise (DNR)

Video digital noise reduction (DNR) provides high quality images with minimal dot crawl and cross color noise.

Selectable items	Description
Level 1	Sets the DNR level for viewing a clearer picture.
Level 2	
Level 3	

Note

- This function is not available for some signals.

⑦ Eco+Quiet

Selectable items	Brightness and Power consumption
On	Approx. 65%
Off	100%

Note

- When “Eco+Quiet” is set to “On”, the fan sound and power consumption are lower than they are when “Off” is selected. (Projection brightness decreases as shown in the chart.)

Signal Adjustment (“SIG-ADJ” Menu)

Menu operation → Page 40

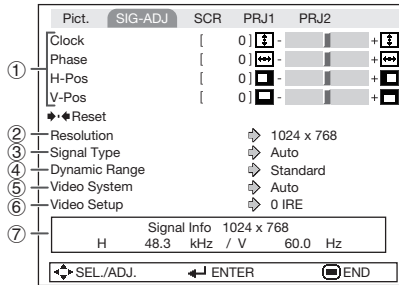

① Adjusting the Computer Image

If the optimum image cannot be obtained with Auto Sync adjustment, use the SIG-ADJ function.

Selectable items	Description
Clock	Adjusts vertical noise.
Phase	Adjusts horizontal noise (similar to tracking on your VCR).
H-Pos	Centers the on-screen image by moving it to the left or right.
V-Pos	Centers the on-screen image by moving it up or down.

Note

- To reset all adjustment items, select “Reset” and press **ENTER**.
- The adjustable range of “H-Pos” (H-Position) and “V-Pos” (V-Position) may vary depending on the screen resolution of the computer.

② Resolution Setting

Ordinarily, the type of input signal is detected and the correct Resolution mode is automatically selected. However, for some signals, the optimal Resolution mode in “Resolution” may need to be selected to match the computer display mode.

Note

- See “Checking the Input Signal” on page 46 for information on the currently selected input signal.

③ Signal Type Setting

This function allows you to select the input signal type RGB or Component for COMPUTER/COMPONENT.

Selectable items	Description
Auto	Input signals are automatically recognized as RGB or component.
RGB	Set when RGB signals are received.
YPbPr	Set when Component signals are received.

④ Selecting the Dynamic Range

An optimum picture may not be displayed if an HDMI-capable device’s output signal type and the projector’s input signal type do not match. If this should occur, switch “Dynamic Range”.

Selectable items	Description
Auto	In most circumstances, “Auto” should be selected.
Standard	When the black levels of the image show banding or appear faded, select the item that results in the best picture quality.
Enhanced	

Note

- The Dynamic Range can be selected only when “HDMI” input mode is selected.

Signal Adjustment (“SIG-ADJ” Menu) (Continued)

Menu operation → Page 40

⑤ Setting the Video System

The video input system mode is factory preset to “Auto”; however, a clear picture from the connected audio-visual equipment may not be received, depending on the Video signal difference.

In that case, switch the Video signal.

Selectable items
Auto
PAL
SECAM
*NTSC4.43
NTSC3.58
PAL-M
PAL-N
PAL-60

* When reproducing NTSC signals in PAL video equipment.

Note

- The Video signal can only be set in VIDEO mode.
- When “Video System” is set to “Auto”, you may not receive a clear picture due to signal differences. Should this occur, switch to the video system of the source signal.

⑥ Setting the Video Setup

Selectable items	Description
0 IRE	Sets the black level to 0 IRE.
7.5 IRE	Sets the black level to 7.5 IRE.

Note

- This function is available for the following signals.
With COMPUTER/COMPONENT input:
- 480I
With VIDEO input:
- NTSC3.58

⑦ Checking the Input Signal

This function allows you to check the current input signal information.

Adjusting the Projected Image (“SCR-ADJ” Menu)

Menu operation → Page 40

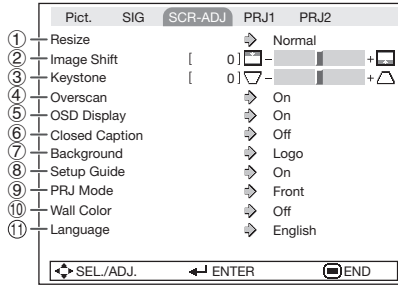

① Setting the Resize Mode

Use this function to stretch the image vertically or horizontally or when the edges of the image cannot be seen.

Note

- For details of the Resize mode, see pages 30 and 31.
- You can also press **RESIZE** on the remote control to set the Resize mode. (See page 30.)

② Adjusting the Image Position

You can move the projected image vertically.

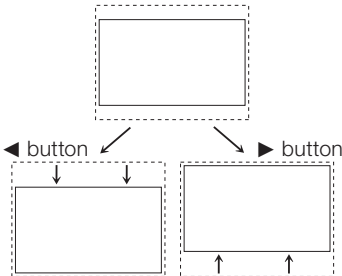

Note

- This function only works in some Resize modes. (See pages 30 and 31.)

③ Keystone Correction

When the image is projected either from the top or from the bottom towards the screen at an angle, the image becomes distorted trapezoidally. The function for correcting trapezoidal distortion is called Keystone Correction.

Select “Keystone” on the “SCR-ADJ” menu and adjust with the slide bar.

See page 28 for details of Keystone Correction.

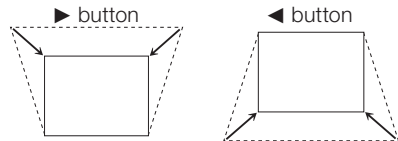

Note

- The Keystone Correction can be adjusted up to an angle of approximately ± 40 degrees (When the Resize mode is set to “NORMAL”).
- You can also press **KEYSTONE** on the remote control to adjust Keystone Correction.

Adjusting the Projected Image (“SCR-ADJ” Menu) (Continued)

Menu operation → Page 40

④ Setting the Overscan

This function allows you to set the overscan area (display area).

Selectable items	Description
On	The input area is displayed without the screen edges.
Off	The whole input area is displayed.

Note

- This function is available for the following signals.
With COMPUTER/COMPONENT or HDMI* input:
 - 480P
 - 540P
 - 576P
 - 720P
 - 1035I
 - 1080I/1080P
- If noise appears at the screen edges when “Off” is selected, set the function to “On”.
- Also see “About Copyrights” on page 31.

⑤ Setting the On-screen Display

Selectable items	Description
On	All on-screen displays are displayed.
Off	VOLUME/AV MUTE/FREEZE/AUTO SYNC/RESIZE/PICTURE MODE/ECO+QUIET/MAGNIFY/Input Search/Audio Mute/“An invalid button has been pressed.” are not displayed.

⑥ Closed Caption

<For Americas only>

Info

- This function is available for NTSC3.58 signal.
- This function does not work when the Resize mode is set to “Border”.
- This function is available in the following cases only:

Resize mode	Keystone Correction
Normal Area Zoom V-Stretch	-40 – +40
16:9	-12 – +12

- “Closed Caption” is a system which allows conversations, narration, and sound effects in TV programs (Limited regions) and home videos to be viewed as captions on the screen.
- Not all programs and videos will offer closed captioning. Please look for the **CC** symbol to ensure that captions will be shown.
- Two channels are available: CC1 and CC2.

Selectable items	Description
Off	—
CC1	Closed Caption mode for CH1 data
CC2	Closed Caption mode for CH2 data

Note

- Closed Caption may malfunction (white blocks, strange characters, etc.) if signal conditions are poor or if there are problems at the broadcast source. This does not necessarily indicate a problem with the projector.
- If any button is pressed to call up the on-screen display while viewing a Closed Caption broadcast, the closed captions will disappear.

⑦ Selecting the Background Image

Selectable items	Description
Logo	Sharp logo screen
Blue	Blue screen
None	—

⑧ Selecting the Setup Guide

Selectable items	Description
On	Displaying the Setup Guide when turning the projector on.
Off	Not displaying the Setup Guide.

⑨ Reversing/Inverting Projected Images

Selectable items	Description
Front	Normal image (Projected from the front of the screen)
Ceiling + Front	Inverted image (Projected from the front of the screen with an inverted projector)
Rear	Reversed image (Projected from the rear of the screen or with a mirror)
Ceiling + Rear	Reversed and inverted image (Projected with a mirror)

See page 19 for details of Projection (PRJ) Mode.

⑩ Selecting the Wall Color

This function allows you to project the image to a colored surface or wall without using a screen.

Selectable items	Description
Off	The Wall Color function is not activated.
Blackboard	Projects images onto a blackboard (dark green).
Whiteboard	Projects images onto a whiteboard.
Green Yellow green Yellow Orange Pink Purple Blue Greenish blue	Projects images onto a colored wall.

⑪ Selecting the On-screen Display Language

The projector can switch the on-screen display language among 18 languages.

English	polski
Deutsch	Magyar
Español	Türkçe
Nederlands	عربي
Français	فارسی
Italiano	Tiếng Việt
Svenska	汉语
Português	한국어
Русский	日本語

Adjusting the Projector Function (“PRJ-ADJ1/2” Menu)

Menu operation → Page 40

▶ PRJ-ADJ1

	Pict.	SIG	SCR	PRJ-ADJ1	PRJ2
①				⇒ On	
②				⇒ On	
③				⇒ On	
④				⇒ On	
⑤				⇒ Normal	
⑥				⇒ Disable	
⑦				⇒ Off	

SEL/ADJ.
 ENTER
 END

▶ PRJ-ADJ2

	Pict.	SIG	SCR	PRJ1	PRJ-ADJ2	Net.
⑧				⇒ On		
⑨				⇒ Monitor Output		
⑩				⇒ Input Search		
⑪				⇒ Quick Start		
⑫				⇒ On		
⑬				⇒ Off		
⑭						
⑮						
⑯						

Lamp Timer(Life) [0] h [0] min (100%)

SEL/ADJ.
 ENTER
 END

① Auto Sync (Auto Sync Adjustment)

Selectable items	Description
On	Auto Sync adjustment will occur when the projector is turned on or when the input signals are switched, when connected to a computer.
Off	Auto Sync adjustment is not automatically performed.

Note

- Auto Sync adjustment is also performed by pressing **AUTO SYNC**.
- The Auto Sync adjustment may take some time to complete, depending on the image of the computer connected to the projector.
- When the optimum image cannot be achieved with Auto Sync adjustment, use manual adjustments. (See page 45.)

② Auto Power Off Function

Selectable items	Description
On	When no input signal is detected for more than 15 minutes, the projector will automatically enter Standby mode.
Off	The Auto Power Off function will be disabled.

Note

- When the Auto Power Off function is set to “On”, 5 minutes before the projector enters Standby mode, the message “Enter STANDBY mode in X min.” will appear on the screen to indicate the remaining minutes.

③ Auto Restart Function

Selectable items	Description
On	If the power cord is unplugged from the outlet or the breaker switch is turned off when the projector is on, then the projector automatically turns on when the power cord is plugged into the AC outlet or the breaker switch is turned on.
Off	The projector does not turn on automatically when the power cord is plugged into the AC outlet or the breaker switch is turned on.

④ Speaker Setting

Selectable items	Description
On	The audio signal is output from the internal speaker.
Off	The audio signal is not output from the internal speaker.

⑤ Fan Mode Setting

This function changes the fan rotation speed.

Selectable items	Description
Normal	Suitable for normal environments.
High	Set when using the projector at altitudes of approximately 1,500 meters (4,900 feet) or more.

When “Fan Mode” is set to “High”, the fan rotation speeds up, and the fan noise becomes louder.

⑥ System Lock Function

This function prevents unauthorized use of the projector. Once this function is activated, users must enter the correct keycode each time the projector is turned on. **We suggest you record the keycode in a safe place where only authorized users have access.**

Info

- If you lose or forget your keycode, contact your nearest Sharp Authorized Projector Dealer or Service Center (see page 71). Even if the product warranty is valid, the keycode reset will incur a charge.

Setting/Changing the Keycode

1 Select “System Lock”, then press **ENTER** or **▶**.

2 Select “Next”, then press **ENTER**.

- The screen for entering the keycode appears.

3 Press the 4 buttons on the remote control or on the projector to enter the preset keycode in “Old Code”.

- When setting the keycode for the first time, press **▼** on the projector for four times.

PRJ - ADJ1	
Setting the System Lock	
Old Code	----
New Code	----
Reconfirm	----

Note

- If you input a wrong keycode, the cursor returns to the first point of the “Old Code”.
- The preset keycode is 4 **▼** buttons on the projector. When you press the **▼** button four times, the keycode input screen disappears.

4 Press the 4 buttons on the remote control or on the projector to enter the new keycode in “New Code”.

Note

- You cannot use the following buttons for keycode: **STANDBY/ON, ON, STANDBY, ENTER, RETURN** and **MENU**
- **System Lock function recognizes each button on the remote control or on the projector as an individual button, even if they share the same button name. If you used the buttons on the projector in setting your keycode, the keycode cannot be canceled with the remote control.**

PRJ - ADJ1	
Setting the System Lock	
Old Code	****
New Code	----
Reconfirm	----

5 Enter the same keycode in “Reconfirm”.

Note

To cancel the keycode that you have already set

- Press **▼** on the projector for four times in steps 4 and 5 above.

When the System Lock is set

- When System Lock is set, the keycode input screen appears after the power is turned on. When it appears, enter the right keycode to start projection.

Input screen for keycode

System Lock	----
-------------	------

Adjusting the Projector Function (“PRJ-ADJ1/2” Menu) (Continued)

Menu operation → Page 40

7 Keylock Function

Use this function to lock the operation buttons on the projector.

This function can be set using either the menu screen or **ENTER** on the projector.

Setting with the menu screen

Selectable items	Description
On	All buttons on the projector, except STANDBY/ON , are locked.
Off	Turns off the Keylock function.

Setting with the projector buttons

Locking the Operation Buttons

- 1 Hold down **ENTER** on the projector for about 5 seconds while the projector is being turned on.

- The Keylock function screen is displayed.

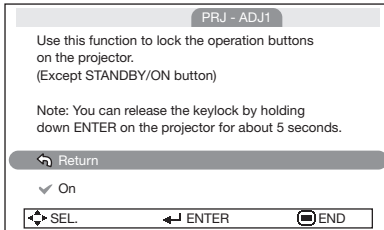

- 2 Select “On”, then press **ENTER**.

On-screen display

Keylock function On

- The Keylock function does not affect the operation with the remote control buttons.
- You cannot use the Keylock function while the projector is warming up.

Taking the Keylock Off

Hold down **ENTER** on the projector for about 5 seconds.

On-screen display

Keylock function Off

Info

- Even when Keylock function is set to “On”, **STANDBY/ON** on the projector can be used to turn on and off the power.
- Keylock cannot be set while the projector is: displaying the “Setup Guide” or “Menu” screens, in Standby mode, warming up, changing input signals, operating the Auto Sync or Input Search function, in Freeze mode or on the “System Lock” screen during warming up.

8 Selecting the Quick Start Menu

Selectable items	Description
On	Pressing MENU displays the Quick Start Menu screen.
Off	Pressing MENU displays the Complete Menu screen.

9 COMPUTER2 Select

You can also use the MONITOR OUT terminal as the COMPUTER/COMPONENT 2 terminal. Select whether to use the terminal as an input terminal or output terminal.

Selectable items	Description
Input	The terminal can be used as an input terminal (COMPUTER/COMPONENT 2).
Monitor Output	The terminal can be used as an output terminal (MONITOR OUT).

Note

- Set this before connecting the external equipment.
- The setting cannot be changed when Input mode is “COMPUTER 2”.

10 Setting the FUNCTION Button Operation

You can assign one of the following functions to the **FUNCTION** button on the remote control. The assigned function can be performed by just pressing **FUNCTION**.

Selectable items	Description
Input Search	Automatically searches for and switches to the appropriate Input mode.
Audio Mute	For temporarily turning off the sound. Press FUNCTION again to turn on the sound
Image Shift	For moving the projected image vertically. (See page 47.)
Signal Info	Input signal information is displayed.

11 STANDBY Mode

Selectable items	Description
Eco	Power consumption is reduced in Standby mode.
Quick Start	The period of startup time is reduced.

12 STANDBY Audio Out

You can set audio output from the **AUDIO OUTPUT** terminal of the projector that is in Standby mode.

Selectable items	Description
On	The audio signal is output from the AUDIO OUTPUT terminal in Standby mode.
Off	The audio signal is not output from the AUDIO OUTPUT terminal in Standby mode.

Note

- When "Eco" is selected for "STANDBY Mode", "STANDBY Audio Out" is set to "Off" automatically and you cannot change the setting.
- The HDMI audio will not output from the **AUDIO OUTPUT** terminal when the projector is in Standby mode.

13 DLP® Link™

See "Using 3D Viewing Mode" on page 59 for details.

14 DLP® Link™ Invert

See "Using 3D Viewing Mode" on page 59 for details.

15 Returning to the Default Settings

This function allows you to initialize the settings you have made in the projector.

Note

- The following items or menu cannot be initialized.
 - Resolution
 - Language
 - Lamp Timer (Life)
 - System Lock
 - COMPUTER2 Select

16 Checking the Lamp Life Status

You can confirm the cumulative lamp usage time and the remaining lamp life (percentage).

Lamp usage condition	Remaining lamp life	
	"Life"	
	100%	5%
Operated exclusively with "Eco+Quiet" set to "On"	Approx. 5,000 hours	Approx. 250 hours
Operated exclusively with "Eco+Quiet" set to "Off"	Approx. 2,000 hours	Approx. 100 hours

Note

- It is recommended that the lamp be changed when the remaining lamp life becomes 5%.
- The lamp life may vary depending on the usage condition.

Setting Up the Projector Network Environment (“Network” Menu)

Menu operation → Page 40

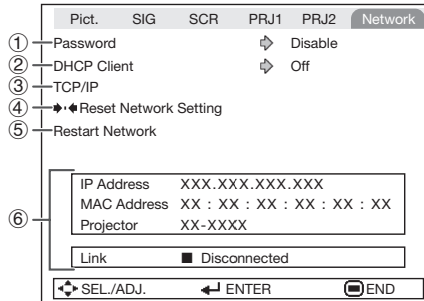

① Setting a Password

If you do not want others to change the setting for the “Network” menu, set a password.

■ Setting a Password

1 Select “Password”, then press **ENTER** or **▶**.

- The screen for entering the password appears.

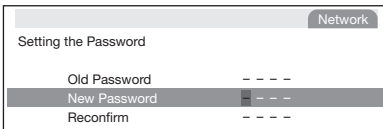

2 Press **▲** or **▼** to set the first digit in “New Password”, then press **▶**.

3 Enter the remaining 3 digits, then press **ENTER**.

- To return to the previous digit, press **◀**.

4 Enter the same password in “Reconfirm”, then press **ENTER**.

- The status for “Password” changes to “Enable”.

Note

- Once the password is set, you must enter the password to change the “Network” menu settings.

■ Changing the Password

1 Select “Password”, then press **ENTER** or **▶**.

- The screen for entering the password appears.

2 Enter the password in “Old Password” using **▲**, **▼**, **▶** and **◀**, then press **ENTER**.

3 Enter the password in “New Password” using **▲**, **▼**, **▶** and **◀**, then press **ENTER**.

4 Enter the same password again in “Reconfirm” using **▲**, **▼**, **▶** and **◀**, then press **ENTER**.

Note

- If you do not need the password protection for the “Network” menu settings anymore, press **ENTER** without entering the new password in steps 3 and 4.
- To cancel the password settings, press **RETURN**.

If you forget the password

If you forget the password, perform the following procedure to delete it, then set a new password.

On the projector, press



Note

- If **ENTER** is held down for more than 5 seconds, the operation buttons on the projector will be locked. (See page 50.)
- You cannot use the buttons on the remote control to delete the password.

② DHCP Client Setting

Connect the LAN cable before turning the projector on. If not, the DHCP Client function does not work.

Selectable items	Description
On	Obtains configuration parameters for TCP/IP network automatically.
Off	Sets the TCP/IP manually.

Select "On" for "DHCP Client". "Obtaining IP Address..." appears, then the menu screen appears. Confirm the parameters of IP Address, Subnet Mask and Gateway on the TCP/IP screen.

If the DHCP server is not available, "Could not obtain IP Address." appears.

In this case, set the TCP/IP manually. (See the item ③.)

③ TCP/IP Setting

Set the TCP/IP manually.

1 Select "Off" for "DHCP Client", then press **ENTER**.

2 Select "TCP/IP", then press **ENTER**.

3 Enter "IP Address" using **▲**, **▼**, **▶** and **◀**, then press **ENTER**.

Network	
Setting the TCP/IP	
IP Address	1 9 2 . 1 6 8 . 1 5 0 . 0 0 2
Subnet Mask	2 5 5 . 2 5 5 . 2 5 5 . 0 0 0
Gateway	0 0 0 . 0 0 0 . 0 0 0 . 0 0 0

4 Enter "Subnet Mask" using **▲**, **▼**, **▶** and **◀**, then press **ENTER**.

5 Enter "Gateway" using **▲**, **▼**, **▶** and **◀**, then press **ENTER**.

Selectable items	Description
IP Address	Factory default setting: 192.168.150.002 Enter an IP address appropriate for the network.
Subnet Mask	Factory default setting: 255.255.255.000 Set the subnet mask to the same as that of the computer and equipment on the network.
Gateway	Factory default setting: 000.000.000.000 * When not in use, set to "000.000.000.000".

Note

- Confirm the existing network's segment (IP address group) to avoid setting an IP address that duplicates the IP addresses of other network equipment or computers. If "192.168.150.002" is not used in a network with an IP address of "192.168.150.XXX", you don't have to change the projector IP address.
- For details about each setting, consult your network administrator.

④ Returning to Default Settings (Network)

This function allows you to initialize the Network settings you have made in the projector.

Note

- If the values for IP Address, Subnet Mask or Gateway of the projector have been returned to the default settings, the computer cannot be connected to the projector depending on the computer's network settings.

⑤ Restart Network Function

Restarts the network function.
Perform this function when the projector cannot be controlled via the network.

Setting Up the Projector Network Environment (“Network” Menu) (Continued)

Menu operation → Page 40

⑥ Confirming the Projector Information

You can confirm the following items.

Selectable items	Description	
IP Address	The IP address of the projector is displayed.	
MAC Address	The MAC address of the projector is displayed.	
Projector	The projector name is displayed.	
Link	Displays the network connection status.	
	Connected	Connected to the network.
	Disconnected	Disconnected from the network.



Note

- For information on how to change the projector name, see “SETUP MANUAL” contained in the supplied CD-ROM.

Viewing Stereoscopic 3D Images

Precautions on Viewing Stereoscopic 3D Images

Before viewing stereoscopic 3D images, please read this section carefully.

WARNING

- Under normal conditions, viewing stereoscopic 3D images is safe for any duration that you would normally view your screen. However, some people may experience discomfort. The following precautions are recommended to minimize the potential for experiencing visual problems or any adverse symptoms.
- Take regular breaks, at least 5 to 15 minutes after every 30 to 60 minutes of stereoscopic 3D viewing.
 - * Based on the guidelines issued by the 3D Consortium revised December 10, 2008.
- Maintain an appropriate distance from the screen. Viewing from too close a distance can strain your eyes. If you experience eye strain, immediately discontinue viewing.
If you experience any of the following symptoms during viewing:
 - nausea, queasiness/dizziness, headache, blurry vision or double vision that lasts longer than few secondsDo not engage in any potentially hazardous activity (for example, driving a vehicle) until your symptoms have completely gone away. If symptoms persist, discontinue use and do not resume stereoscopic 3D viewing without discussing your symptoms with a physician.
- As you get more comfortable viewing stereoscopic 3D:
 - Adjust the parallax on the 3D-video playback equipment. (You may not be able to adjust the parallax on some models of equipment.)
 - Adjust the projected image to the most comfortable viewing size by zooming. (Projecting images on the smallest or largest screen size possible may eliminate the stereoscopic effect and strain your eyes.)
 - Use the DLP® Link™ Invert function to properly set the video for your left and right eyes. (For details on using “DLP® Link™ Invert”, see the section on its operation in this operation manual.)
- The following people should limit stereoscopic 3D viewing:
 - Children under 6 years of age (to protect the eye growth process)
 - People with a history of photosensitivity
 - People with heart disease
 - People in poor health
 - People who are sleep deprived
 - People who are physically tired
 - People under the influence of drugs or alcohol

■ Epilepsy

A small percentage of the population may experience epileptic seizures when viewing certain types of images that contain flashing patterns of light.

IF YOU OR ANY MEMBER OF YOUR FAMILY HAS A HISTORY OF EPILEPSY

The following people should consult a physician before viewing stereoscopic 3D images.

- Anyone with a history of epilepsy, or who has a family member with a history of epilepsy
- Children under 6 years of age
- Anyone who has ever experienced epileptic seizures or sensory disturbances triggered by flashing light effects

SOME LIGHT PATTERNS MAY INDUCE SEIZURES IN PERSONS WITH NO PRIOR HISTORY OF EPILEPSY

Discontinue use if you experience any of the following symptoms while viewing stereoscopic 3D images.

- Involuntary movements, eye or muscle twitching
- Muscle cramps
- Nausea, dizziness, or queasiness
- Convulsions
- Disorientation, confusion, or loss of awareness of your surroundings

Information on the 3D Projection Function

- To display 3D images, this projector requires:
WHAT YOU WILL NEED
 - 1) Source devices that support the field sequential format
 - For details on the supported signals, see the Compatibility Chart in this operation manual.
 - 2) 3D LCD shutter glasses that support the DLP® Link™* system
 - Contact your nearest Sharp Authorized Projector Dealer for purchasing details.
 - * DLP® Link™ is a trademark of Texas Instruments.
- The projected image may become dark when using the 3D projection function (with “DLP® Link™” set to “On”).
- When “DLP® Link™” is set to “On”, the following functions may not work fully or may not be available at all.
 - Keystone/Resize/Magnify
- 3D formats except for the field sequential method, such as ones used for Blu-ray 3D or DVD prepackaged media, are not compatible with this projector. (As of November 2012)
- If the power of your left and right eyes greatly differs and you primarily use one eye for viewing the images, the images will not appear in 3D.
In addition, images may be difficult to view in 3D or images may not be able to be viewed in 3D depending on the individual or the content being displayed.
The stereoscopic effect varies with the individual.
- 3D viewing is possible within the range that the 3D LCD shutter glasses are able to receive light signals reflected by the screen. However, most 3D images are manufactured to be viewed from directly in front of the screen, so 3D viewing is recommended directly in front of the screen as much as possible.
 - The range for receiving signals varies depending on the 3D LCD shutter glasses. For details, see the operation manual of your 3D LCD shutter glasses.
- 3D images may not be able to be played back correctly on your computer.

Appendix

- How the 3D Projection Function (DLP Link™) Works
The 3D projection function of this projector is compatible with the DLP® Link™ system. To watch 3D images, you use a pair of 3D LCD shutter glasses that alternately display the projected images for the left and right eyes and are synchronized with a control (light) signal.

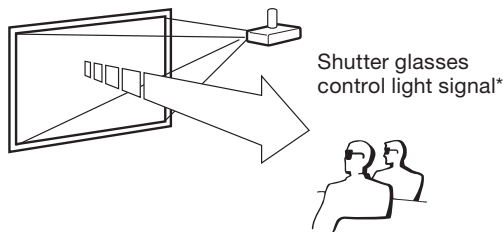

- * The control light signal is transmitted from the lens of the projector, reflected by the screen, and received by the light reception sensor on the 3D LCD shutter glasses. Therefore, the range of 3D viewing varies depending on the specifications of the 3D LCD shutter glasses (light signal receiving sensitivity).
For details, see the operation manual of your 3D LCD shutter glasses.

Viewing Stereoscopic 3D Images (Continued)

Using 3D Viewing Mode

Use the following procedure to project 3D images.

For operation of the 3D LCD shutter glasses and the 3D-video playback equipment, see the corresponding operation manual.

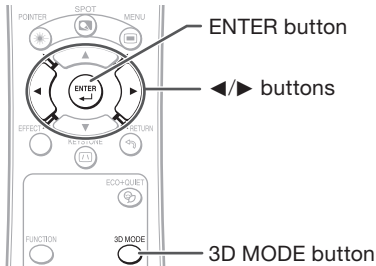

Projecting 3D images

- 1 Turn the projector on.
- 2 Turn the 3D-video playback equipment on.
 - Set the 3D-video playback equipment so that it outputs one of the signals listed in the Compatibility Chart in this operation manual.
- 3 Switch the Input mode of the projector to enable input of 3D video signals.
- 4 Operate the 3D-video playback equipment and play back the 3D content.
- 5 Turn the 3D LCD shutter glasses on and place them over your eyes.

- 6 Press **3D MODE** on the remote control to display the 3D MODE menu.

Info

- If “An invalid button has been pressed.” is displayed, a 3D-compatible signal is not being input. Check the output signal on the playback equipment.

- 7 Press **▶** to set “DLP® Link™” to “On”.

- 8 Press **ENTER** to switch the mode and enable more natural 3D image viewing.

Warning!

- If the projector, 3D-video playback equipment, and 3D LCD shutter glasses are not properly set, you may experience eye strain in addition to not being able to view the images in 3D.

- 9 Press **3D MODE**.
 - The 3D MODE menu will disappear.

Note

- If the images are not displayed in 3D, repeat steps 6 to 8.
- You can also use “DLP® Link™” and “DLP® Link™ Invert” on the menu screen to change the 3D setting.

Ending 3D projection

- 1 Press **3D MODE** on the remote control to display the 3D MODE menu.
- 2 Press **◀** to set “DLP® Link™” to “Off”.
- 3 Press **3D MODE**.
 - The 3D MODE menu will disappear.

Maintenance

Cleaning the projector

- Ensure that you have unplugged the power cord before cleaning the projector.
- The cabinet as well as the operation panel is made of plastic. Avoid using benzene or thinner, as these can damage the finish on the cabinet.
- Do not use volatile agents such as insecticides on the projector. Do not attach rubber or plastic items to the projector for long periods. The effects of some of the agents in the plastic may cause damage to the quality or finish of the projector.
- Wipe off dirt gently with a soft flannel cloth. Using a chemical cloth (wet/dry sheet type cloth, etc.) may deform the components of the cabinet or cause cracking.
- Wiping with a hard cloth or using strong force may scratch the cabinet surface.
- When the dirt is hard to remove, soak a cloth in a mild detergent diluted with water, wring the cloth well and then wipe the projector. Strong cleaning detergents may discolor, warp or damage the coating on the projector. Make sure to test on a small, inconspicuous area on the projector before use.

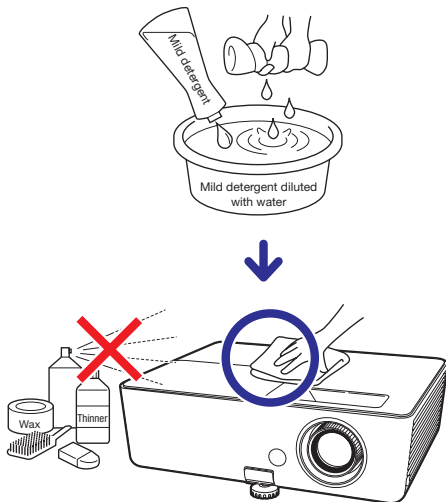

Cleaning the lens

- Use a commercially available blower or lens cleaning paper (for glasses and camera lenses) for cleaning the lens. Do not use any liquid type cleaning agents, as they may wear off the coating film on the surface of the lens.
- As the surface of the lens can easily get damaged, be careful not to scrape or hit the lens.

! Caution

- Do not use any glass cleaner to clean the lens.
- Avoid touching the lens with your hands to prevent fingerprints on or damage to the lens surface.

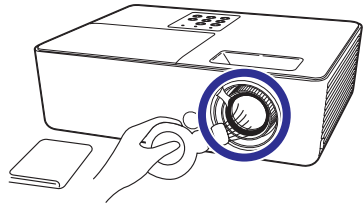

Cleaning the exhaust and intake vents

- Use a vacuum cleaner to clean dust from the exhaust vent and the intake vent.

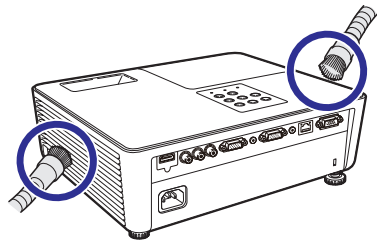

Info

- If you want to clean the air vents during projector operation, ensure you press **STANDBY/ON** on the projector or **STANDBY** on the remote control and put the projector into Standby mode. After the cooling fan has stopped, clean the vents.

Maintenance Indicators

- The warning lights (power indicator, lamp indicator and temperature warning indicator) on the projector indicate problems inside the projector.
- If a problem occurs, either the temperature warning indicator or the lamp indicator will illuminate red, and the projector will enter Standby mode. After the projector has entered Standby mode, follow the procedures given below.

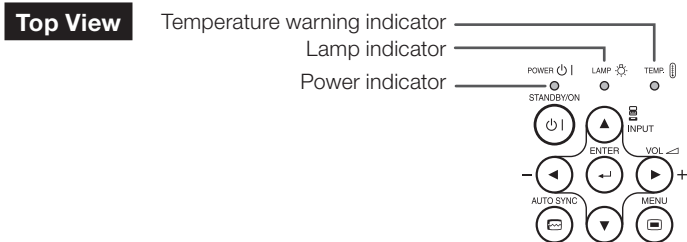

About the temperature warning indicator



If the temperature inside the projector increases, due to blockage of the air vents, or the setting location, the temperature warning indicator will blink. And if the temperature keeps on rising, "TEMP." will illuminate in the lower left corner of the picture with the temperature warning indicator blinking. If this state continues, the lamp will turn off, the cooling fan will run and then the projector will enter Standby mode. When you find the temperature warning indicator blinking, be sure to perform the measures described on page 63.

About the lamp indicator



- When the remaining lamp life becomes 5% or less, (yellow) and "Change The Lamp" will be displayed on the screen. When the percentage becomes 0%, it will change to (red), the lamp will automatically turn off and then the projector will automatically enter Standby mode. At this time, the lamp indicator will illuminate in red.
- **If you try to turn on the projector a fourth time without replacing the lamp, the projector will not turn on.**

Indicators on the Projector

Power indicator	Red on	Normal (Standby)
	Green on	Normal (Power on)
	Red blinks	Abnormal (See page 62.)
	Green blinks	Normal (Cooling)
Lamp indicator	Green on	Normal
	Green blinks	The lamp is warming up.
	Red on	The lamp is shut down abnormally or requires to be changed. (See page 62.)
Temperature warning indicator	Off	Normal
	Red on/Red blinks	The internal temperature is abnormally high. (See page 62.)

Maintenance indicator			Problem	Cause	Possible Solution
	Normal	Abnormal			
Temperature warning indicator	Off	Red blinks (On)/ Red on (Standby)	The internal temperature is abnormally high.	<ul style="list-style-type: none"> • Temperatures around the projector are high. • Blocked air intake 	<ul style="list-style-type: none"> • Use the projector in an area with a temperature of lower than 95°F (+35°C). • Relocate the projector to an area with proper ventilation. (See page 8.)
				<ul style="list-style-type: none"> • Cooling fan breakdown • Internal circuit failure • Clogged air intake 	
Lamp indicator	Green on (Green blinks when the lamp is warming up.)	Red on	The lamp does not illuminate.	<ul style="list-style-type: none"> • The lamp is shut down abnormally. 	<ul style="list-style-type: none"> • Disconnect the power cord from the AC outlet, and then connect it again. • Carefully replace the lamp. (See page 63.) • Take the projector to your nearest Sharp Authorized Projector Dealer or Service Center (see page 71) for repair. • Please exercise care when replacing the lamp. • Securely install the cover.
		Red on (Standby)	Time to change the lamp. The lamp does not illuminate.	<ul style="list-style-type: none"> • Remaining lamp life becomes 5% or less. • Burnt-out lamp • Lamp circuit failure 	
Power indicator	Green on/ Red on Green blinks (Cooling)	Red blinks	The power indicator blinks in red when the projector is on.	<ul style="list-style-type: none"> • The lamp unit cover is open. 	<ul style="list-style-type: none"> • If the power indicator blinks in red even when the lamp unit cover are securely installed, contact your nearest Sharp Authorized Projector Dealer or Service Center (see page 71) for advice.

Info

- If the temperature warning indicator illuminates, and the projector enters Standby mode, follow the possible solutions above and then wait until the projector has cooled down completely before plugging in the power cord and turning the power back on. (At least 10 minutes.)
- If the power is turned off for a brief moment due to power outage or some other cause while using the projector, and the power supply recovers immediately after that, the lamp indicator will illuminate in red and the lamp may not be lit. In this case, unplug the power cord from the AC outlet, replace the power cord in the AC outlet and then turn the power on again.
- The cooling fan keeps the internal temperature of the projector constant and this function is controlled automatically. The sound of the cooling fan may change during operation because the fan speed may change and this is not a malfunction.

Regarding the Lamp

Lamp

- It is recommended that the lamp (sold separately) be replaced when the remaining lamp life becomes 5% or less, or when you notice a significant deterioration in the picture and color quality. The lamp life (percentage) can be checked with the on-screen display. (See page 53.)
- Purchase a replacement lamp of type AN-LX30LP from your place of purchase, nearest Sharp Authorized Projector Dealer or Service Center.

IMPORTANT NOTE TO U.S. CUSTOMERS:

The lamp included with this projector is backed by a 90-day parts and labor limited warranty. All service of this projector under warranty, including lamp replacement, must be obtained through a Sharp Authorized Projector Dealer or Service Center. For the name of the nearest Sharp Authorized Projector Dealer or Service Center, please call toll-free: 1-888-GO-SHARP (1-888-467-4277).

Hg LAMP CONTAINS MERCURY For State Lamp Disposal Information

www.lamprecycle.org or 1-800-BE-SHARP

U.S.A ONLY

Caution Concerning the Lamp

- This projector utilizes a pressurized mercury lamp. A loud sound may indicate lamp failure. Lamp failure can be attributed to numerous sources such as: excessive shock, improper cooling, surface scratches or deterioration of the lamp due to a lapse of usage time.
The period of time up to failure largely varies depending on the individual lamp and/or the condition and the frequency of use. It is important to note that failure can often result in the bulb cracking.
- When the lamp replacement indicator and on-screen display icon are illuminated, it is recommended that the lamp be replaced with a new one immediately, even if the lamp appears to be operating normally.
- Should the lamp break, there is also a possibility that glass particles may spread inside of the projector. In such a case, it is recommended you contact your nearest Sharp Authorized Projector Dealer or Service Center to assure safe operation.
- Should the lamp break, the glass particles may spread inside the lamp cage or gas contained in the lamp may be vented into the room from the exhaust vent. Because the gas in this lamp includes mercury, ventilate the room well if the lamp breaks and avoid all exposure to the released gas. In case of exposure to the gas, consult a doctor as soon as possible.

Replacing the Lamp



Caution

- Do not remove the lamp unit from the projector right after use. The lamp will be very hot and may cause burns or injury.
- Wait at least one hour after the power cord is disconnected to allow the surface of the lamp unit to fully cool before removing the lamp unit.
- **Carefully change the lamp by following the instructions described in this section.**
 - * **If you wish, you may have the lamp replaced at your nearest Sharp Authorized Projector Dealer or Service Center.**
 - * If the new lamp does not light after replacement, take your projector to the nearest Sharp Authorized Projector Dealer or Service Center for repair.

Removing and Installing the Lamp Unit



Warning!

- Do not remove the lamp unit from the projector right after use. The lamp and parts around the lamp will be very hot and may cause burns or injury.



Info

- Do not touch the glass surface of the lamp unit or the inside of the projector.
- To avoid injury to yourself and damage to the lamp, make sure you carefully follow the steps below.
- Do not loosen other screws except for the lamp unit cover and lamp unit.

- 1 Press **STANDBY/ON** on the projector or **STANDBY** on the remote control to put the projector into Standby mode.**

- 2 Disconnect the power cord.**

- Unplug the power cord from the AC socket.
- Leave the lamp until it has fully cooled down (about 1 hour).

- 3 Remove the lamp unit cover.**

- Loosen the user service screw (1) that secures the lamp unit cover. Slide the lamp unit cover in the direction of the arrow and then lift it up (2).

Optional
accessory

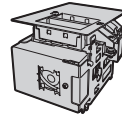

Lamp unit
AN-LX30LP

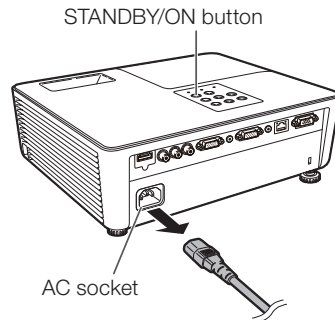

STANDBY/ON button

AC socket

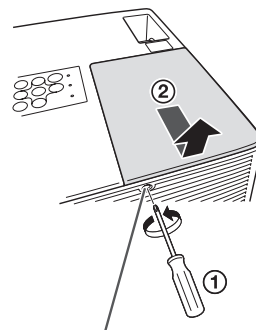

User service screw
(for lamp unit cover)

Regarding the Lamp (Continued)

4 Remove the lamp unit.

- Loosen the securing screw from the lamp unit. Hold the lamp unit and pull it in the direction of the arrow. At this time, keep the lamp unit horizontal and do not tilt it.

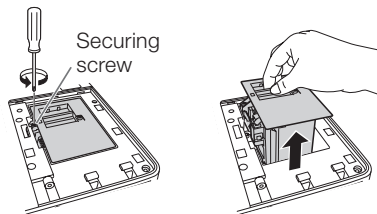

5 Insert the new lamp unit.

- Press the lamp unit firmly into the lamp unit compartment to align the lamp connectors. Fasten the securing screw.

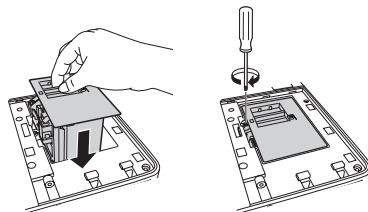

6 Replace the lamp unit cover.

- Slide the lamp unit cover horizontally back into place and align the tabs (①). Then tighten the user service screw (②) to secure the lamp unit cover.

Info

- If the lamp unit and lamp unit cover are not correctly installed, the power will not turn on, even if the power cord is connected to the projector.

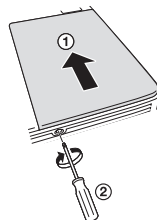

Resetting the Lamp Timer

Reset the lamp timer after replacing the lamp.

Info

- Make sure to reset the lamp timer only when replacing the lamp. If you reset the lamp timer and continue to use the same lamp, this may cause the lamp to become damaged or explode.

1 Connect the power cord.

- Plug the power cord into the AC socket of the projector.

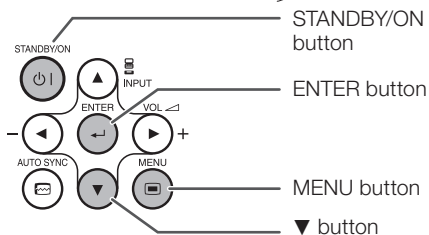
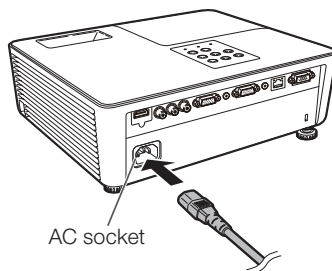

2 Reset the lamp timer.

- While simultaneously holding down **MENU**, **ENTER** and **▼** on the projector, press **STANDBY/ON** on the projector and keep all four buttons pressed down until the lamp indicator starts blinking green.
- "LAMP 0000H" is displayed, indicating that the lamp timer is reset.

Compatibility Chart

Computer

- Multiple signal support
Horizontal Frequency: 15-110 kHz,
Vertical Frequency: 45-85 Hz,

Pixel Clock: 12-165 MHz
Sync signal: Compatible with TTL level

- Compatible with sync on green signal

PC/MAC	Mode	Resolution	Horizontal frequency [kHz]	Vertical frequency [Hz]	Analog Support	Digital Support	Display					
							PG-LW3000/PG-LW3500	PG-LX3500/PG-LX3000				
PC	VGA	640 × 480	31.5	60	✓	✓	Upscale	Upscale				
			37.9	72	✓	✓						
			37.5	75	✓	✓						
	SVGA	800 × 600	43.3	85	✓	✓			Upscale	Upscale		
			35.2	56	✓	✓						
			37.9	60	✓	✓						
			48.1	72	✓	✓						
			46.9	75	✓	✓						
			53.7	85	✓	✓						
	XGA	1024 × 768	48.4	60	✓	✓			Upscale	Upscale		
			56.5	70	✓	✓						
			60.0	75	✓	✓						
	WXGA	1280 × 800	68.7	85	✓	✓	TRUE	TRUE				
			45.0	60	✓	✓						
			47.8	60	✓	✓						
			49.7	60	✓	✓						
			62.8	75	✓	✓						
			WXGA+	1440 × 900	47.7	60			✓	✓	Intelligent Compression	Intelligent Compression
					47.8	60			✓	✓		
			SXGA	1280 × 960	55.0	60			✓	✓	Intelligent Compression	Intelligent Compression
					68.2	70			✓	✓		
					67.5	75			✓	✓		
	60.0	60			✓	✓						
75.0	75	✓			✓							
64.0	60	✓			✓							
SXGA+	1400 × 1024	80.0	75	✓	✓	Intelligent Compression	Intelligent Compression					
		64.0	60	✓	✓							
WSXGA+	1600 × 1200	65.3	60	✓	✓	Intelligent Compression	Intelligent Compression					
		65.3	60	✓	✓							
MAC 13"	VGA	640 × 480	75.0	60	✓	✓	Upscale	Upscale				
			34.9	67	✓	✓						
MAC 16"	SVGA	832 × 624	49.7	75	✓	✓	Upscale	Upscale				
MAC 19"	XGA	1024 × 768	60.2	75	✓	✓	TRUE	TRUE				
MAC 21"	SXGA	1152 × 870	68.7	75	✓	✓	Intelligent Compression	Intelligent Compression				

Note

- Optimum image quality will be achieved by matching your computer's output resolution to the resolution that corresponds to "TRUE" in the "Display" column shown above.
- When "Screen resolution" of the computer is different from the resolution displayed on the projected image, follow the procedures shown below.
 - Refer to "Resolution" on the "SIG-ADJ" menu and select the same resolution as the resolution in "Screen resolution" of the computer.
 - Depending on the computer you are using, the output signal may not be faithful to the "Screen resolution" adjustment. Check the settings of the computer's signal output. If the settings cannot be changed, it is recommended that the resolution be set to the one that corresponds to "TRUE" in the "Display" column.

3D Supported Signals

Signal		Horizontal Frequency (kHz)	Vertical Frequency (Hz)	Analog Support	Digital Support
SVGA	800 × 600	77.1	120	✓	✓
XGA	1024 × 768	98.6	120	✓	✓
WXGA *2	1280 × 720	92.6	120	✓	✓
	1280 × 800	101.6	120 *1	✓	✓

*1 Reduced Blanking

*2 PG-LW3500/PG-LW3000 only







Note

- Your computer graphics card must be able to display 3D stereoscopic signals. Please check with your computer/graphic card specifications or call your computer manufacturer to ensure this capability.

DTV

Signal	Horizontal Frequency (kHz)	Vertical Frequency (Hz)	Analog Support	Digital Support	Signal	Horizontal Frequency (kHz)	Vertical Frequency (Hz)	Analog Support	Digital Support
480I	15.7	60	✓		1080I	28.1	50	✓	✓
480P	31.5	60	✓	✓	1080I	33.8	60	✓	✓
540P	33.8	60	✓		1080P	27.0	24		✓
576I	15.6	50	✓		1080P	28.1	25		✓
576P	31.3	50	✓	✓	1080P	33.8	30		✓
720P	37.5	50	✓	✓	1080P	56.3	50	✓	✓
720P	45.0	60	✓	✓	1080P	67.5	60	✓	✓
1035I	33.8	60	✓						

Troubleshooting

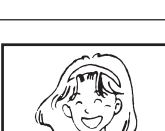
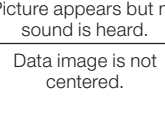
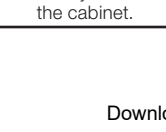
Problem	Check	Page
 <p>No picture and no sound or projector does not start.</p>	• Projector power cord is not plugged into the wall outlet.	22
	• Power to the external connected devices is off.	–
	• The selected Input mode is wrong.	29
	• The AV Mute function is working.	29
	• Cables are incorrectly connected to the projector.	20–24
	• Remote control battery has run out.	13
 <p>Sound is heard but no picture appears (or picture is dark).</p>	• External output has not been set when connecting a notebook computer.	20
	• The lamp unit cover is not installed correctly.	64, 65
Dark or bluish image	• Cables are incorrectly connected to the projector.	20–24
	• “Bright” is set to minimum position.	43
 <p>Color is faded or poor.</p>	• Depending on the computer you are using, an image may not be projected unless the signal output setting of the computer is switched to the external output. Refer to the computer’s operation manual for how to switch its signal output settings.	–
	• Is “On” selected in “DLP® Link™”?	59
	• Check that “Wall Color” is configured correctly.	49
 <p>Color is faded or poor.</p>	• Image adjustments are incorrectly set.	43
	• Make adjustments of “Color” and “Tint” in “Picture Mode” and lower the “BrilliantColor™” value.	–
	(Video Input only) • Video input system is incorrectly set. (COMPUTER/COMPONENT Input only) • Input signal type (RGB/Component) is incorrectly set.	46 45
 <p>Picture is blurred; noise appears.</p>	• Adjust the focus.	26
	• The projection distance exceeds the focus range.	17
 <p>Picture is blurred; noise appears.</p>	• There is fog on the lens. If the projector is carried from a cold room into a warm room, or if it is suddenly heated, condensation may form on the surface of the lens and the image will become blurred. Set up the projector at least one hour before it is to be used. If condensation should form, remove the power cord from the wall outlet and wait for it to clear.	–
	(Computer Input only) • Perform “SIG-ADJ” Adjustments (“Clock” and “Phase” Adjustment)	45
	• Noise may appear depending on the computer.	–
 <p>Picture appears but no sound is heard.</p>	• Cables are incorrectly connected to the projector.	20–24
	• Volume is set to minimum. • When the projector is connected to an external device and the volume is set to minimum, the sound is not output even if you turn up the volume of the external device.	29
Data image is not centered.	• “Speaker” is set to “Off”.	50
	• The Audio Mute function is working.	53
An unusual sound is occasionally heard from the cabinet.	• Make the necessary adjustments of each item in the “SIG-ADJ” menu.	45
	• Depending on the computer you are using, the output resolution signal may be different from the one you have set. For details, refer to the operation manual of the computer.	–
	• If the picture is normal, the sound is due to cabinet shrinkage caused by room temperature changes. This will not affect operation or performance.	–

Problem	Check	Page
Maintenance indicator on the projector illuminates or blinks in red.	<ul style="list-style-type: none"> • See "Maintenance Indicators". 	61
Picture is green on COMPUTER (YPbPr)/HDMI (YPbPr)	<ul style="list-style-type: none"> • Change the input signal type setting. 	45
Picture is pink (no green) on COMPUTER (RGB)/HDMI (RGB)		
Picture is too bright and whitish.	<ul style="list-style-type: none"> • Image adjustments are incorrectly set. 	43
The cooling fan becomes noisy.	<ul style="list-style-type: none"> • When temperature inside the projector increases, the cooling fan runs faster. 	8, 9 60, 61, 62
The lamp does not light up even after the projector turns on.	<ul style="list-style-type: none"> • The lamp indicator is illuminating in red. Replace the lamp. 	61, 64, 65
The lamp suddenly turns off during projection.		
The image sometimes flickers.	<ul style="list-style-type: none"> • Cables are incorrectly connected to the projector or the connected equipment works improperly. • If this happens frequently, replace the lamp. 	20-24 64
The lamp needs much time to turn on.	<ul style="list-style-type: none"> • The lamp will eventually need to be changed. While the remaining lamp life draws to a close, replace the lamp. 	64
Picture is dark.		
The remote control cannot be used.	<ul style="list-style-type: none"> • Operate the remote control while pointing it at the projector's remote control sensor. • The remote control may be too far away from the projector. • If direct sunlight or a strong fluorescent lamp is shining on the projector's remote control sensor, place the projector where it will not be affected by strong light. 	13
	<ul style="list-style-type: none"> • The batteries may be depleted or inserted incorrectly. Make sure the batteries are inserted correctly or insert new ones. 	13

Troubleshooting (Continued)

Problem	Check	Page
3D images flicker when watching in a room.	<ul style="list-style-type: none"> • Images may appear to flicker when fluorescent light or ambient light enters your vision. <ul style="list-style-type: none"> – Turn off the lights. – Block any ambient light. 	–
Ghosting (a double image) occurs without the image appearing in 3D.	<ul style="list-style-type: none"> • Check that you are using 3D LCD shutter glasses that support the DLP® Link™ system. <ul style="list-style-type: none"> – Be sure to use 3D LCD shutter glasses that support the DLP® Link™ system. 	–
	<ul style="list-style-type: none"> • Check that the shutters on the 3D LCD shutter glasses are working properly. <ul style="list-style-type: none"> – Turn the 3D LCD shutter glasses off and then on again. – Check the batteries of the 3D LCD shutter glasses. – Check that the 3D LCD shutter glasses are set to 3D viewing mode. Some 3D LCD shutter glasses are equipped with a special viewing mode (such as “dual view mode”) in addition to the normal 3D viewing mode. See the operation manual of your 3D LCD shutter glasses. 	–
	<ul style="list-style-type: none"> • Check the settings of the projector. <ul style="list-style-type: none"> – Turn the DLP® Link™ function “On”. – Use “DLP® Link™ Invert” to change the setting. 	–
	<ul style="list-style-type: none"> • Check whether a signal that is not supported is being input. <ul style="list-style-type: none"> – Configure your 3D application at the correct resolution and refresh rate. Make sure you are running your 3D application in resolutions that support 3D. To support 3D, your 3D application must be configured to run at the correct settings for this projector. For details on the supported signals, see “3D Supported Signals” of the Compatibility Chart. 	67
	<ul style="list-style-type: none"> • If the projector is connected to a computer for 3D image playback, check that a stereoscopically-enabled application is being used. <ul style="list-style-type: none"> – Use the applicable software. – Set the applicable software to the field sequential format. 	–
	<ul style="list-style-type: none"> • Check that there are no obstructions between the screen and the 3D LCD shutter glasses. <ul style="list-style-type: none"> – Remove any obstructions. Any obstructions may cause the glasses not to function properly causing the lenses to flicker or turn off. Do not place your hand or other objects in front of the 3D control signal sensor on the glasses. 	–
	<ul style="list-style-type: none"> • Check whether there is a source of high intensity lighting nearby. <ul style="list-style-type: none"> – Block the light or turn it off. High intensity lighting can interfere with communication between the 3D LCD shutter glasses and the screen resulting in some flicker. 	–
	<ul style="list-style-type: none"> • Check whether two or more projectors are projecting 3D images at the same time. <ul style="list-style-type: none"> – Use only one projector at a time. 	–

This unit is equipped with a microprocessor. Its performance could be adversely affected by incorrect operation or interference. If this should happen, unplug the Unit and plug it in again after more than 5 minutes.

For SHARP Assistance

If you encounter any problems during setup or operation of this projector, first refer to the "Troubleshooting" section on pages 68 to 70. If this operation manual does not answer your question, please contact the SHARP Service departments listed below.

U.S.A.	Sharp Electronics Corporation 1-888-GO-SHARP (1-888-467-4277) lcdsupport@sharpsec.com http://www.sharppusa.com	Denmark	SHARP Electronics (Nordic) AB (0) 70 230 810 helpdesksverige@sharp.se www.sharp.dk
Canada	Sharp Electronics of Canada Ltd. (905) 568-7140 http://www.sharp.ca	Austria	SHARP Electronics (Europe) GmbH 0820 - 50 08 20 EUR 0,145/min, Anrufe aus dem Mobilfunknetz können teurer sein www.sharp.at
Mexico	Sharp Electronics Corporation Mexico Branch (525) 716-9000 http://www.sharp.com.mx	Benelux	SHARP Electronics Benelux BV 0900-SHARPCOE (0900-7427723) Nederland 9900-0159 Belgium http://www.sharp.nl http://www.sharp.be http://www.sharp.lu
Latin America	Sharp Electronics Corp. Latin American Group (305) 264-2277 www.servicio@sharpsec.com http://www.siempresharp.com	Australia	Sharp Corporation of Australia Pty. Ltd. 1300-135-022 http://www.sharp.net.au
Germany	Sharp Electronics (Europe) GmbH 01805- 29 95 29 0,14 €/Min. aus dem dt. Festnetz, Mobilfunkpreis max. 0,42 €/Min. http://www.sharp.de	New Zealand	Sharp Corporation of New Zealand Phone: (09) 573-0111 Fax: (09) 573-0112 http://www.sharp.net.nz
U.K.	Sharp Electronics (U.K.) Ltd. 08705 274277 http://www.sharp.co.uk/customersupport	Singapore	Sharp-Roxy Sales (S) Pte. Ltd. 65-226-6556 ckng@srs.global.sharp.co.jp http://www.sharp.com.sg
Italy	Sharp Electronics (Italy) S.P.A. (39) 02-89595-1 http://www.sharp.it	Hong Kong	Sharp-Roxy (HK) Ltd. (852) 2410-2623 dcmktg@srh.global.sharp.co.jp http://www.sharp.com.hk
France	SHARP ELECTRONICS FRANCE Tel: 0820 856 333 http://www.sharp.fr	Taiwan	Sharp Corporation (Taiwan) 0800-025111 http://www.sharp-scot.com.tw
Spain	SHARP ELECTRONICA ESPAÑA, S.A. 902 10 13 88 servicio-soporte.es@sharp.eu http://www.sharp.es	Malaysia	Sharp-Roxy Sales & Service Co. (60) 3-5125678
Switzerland	SHARP ELECTRONICS (SCHWEIZ) AG Sharp Infoline deutsch: 0848 074 277 (Montag bis Freitag von 09:00-18:00 Uhr) Sharp Infoline français: 0848 274 277 (Lundi jusqu'à vendredi de 09:00-18:00 heures) http://www.sharp.ch	U.A.E.	Sharp Middle East Fze 971-4-81-5311 helpdesk@smef.global.sharp.co.jp
Sweden	SHARP Electronics (Nordic) AB 0200 120 800 helpdesksverige@sharp.se www.sharp.se	Thailand	Sharp Thebnakorn Co. Ltd. 02-236-0170 svc@stcl.global.sharp.co.jp http://www.sharp-th.com
Norway	SHARP Electronics (Nordic) AB 22 07 42 82 helpdesksverige@sharp.se www.sharp.no	Korea	Sharp Electronics Incorporated of Korea (82) 2-3660-2002 lcd@sharp-korea.co.kr http://www.sharpkorea.co.kr
Finland	SHARP Electronics (Nordic) AB (09) 146 1500 helpdesksverige@sharp.se www.sharp.fi	India	Sharp Business Systems (India) Limited (91) 11- 6431313 service@sharp-oa.com

Specifications

Model		PG-LW3500	PG-LW3000	PG-LX3500	PG-LX3000
Display devices		0.65" DLP® Chip x1		0.55" DLP® Chip x1	
Resolution		WXGA (1280 × 800)		XGA (1024 × 768)	
Lens (Varifocal Lens)	F number	F 2.5 – 2.7			
	Zoom	Manual, x 1.2			
	Focus	Manual			
		f = 21.8 – 25.6 mm			
Input terminals	HDMI	x1			
	Computer/Component (mini D-sub 15 pin)	x2			
	Video (RCA)	x1			
	Audio (ø3.5 mm stereo minijack)	x1			
	Audio (RCA)	x1 (L/R)			
Output terminals	Computer/Component (mini D-sub 15 pin)	x1 (Shared with COMPUTER/COMPONENT 2; switchable)			
	Audio (ø3.5 mm stereo minijack)	x1 (variable audio output)			
Control and communication terminals	LAN (RJ-45)	x1			
	RS-232C (D-sub 9 pin)	x1			
Speaker		2 W (Mono)			
Projection lamp		250 W			
Rated voltage		AC 100 – 240 V			
Rated frequency		50/60 Hz			
Input current		3.1 A			
Power consumption	Eco+Quiet Off	AC 100 V	312 W		
		AC 240 V	306 W		
	Eco+Quiet On	AC 100 V	218 W		
		AC 240 V	218 W		
Power consumption (STANDBY Mode)	Quick Start	AC 100 V	4.85 W	4.47 W	
		AC 240 V	5.34 W	4.99 W	
	Eco	AC 100 V	0.35 W		
		AC 240 V	0.78 W		
Operation temperature		41°F to 95°F (+5°C to +35°C)			
Cabinet		Plastic			
Dimensions (main body only) [W × H × D]		3/32" × 3 45/64" × 9 21/32" (307 × 94 × 245 mm)			
Weight (approx.)		5.7lbs. (2.6kg)	5.5lbs. (2.5kg)	5.7lbs. (2.6kg)	5.5lbs. (2.5kg)

As a part of policy of continuous improvement, SHARP reserves the right to make design and specification changes for product improvement without prior notice. The performance specification figures indicated are nominal values of production units. There may be some deviations from these values in individual units.

This SHARP projector uses a DLP® chip. This very sophisticated panel contains 1,024,000 (PG-LW3500/PG-LW3000)/786,432 (PG-LX3500/PG-LX3000) pixels (micromirrors). As with any high technology electronic equipment such as large screen TVs, video systems and video cameras, there are certain acceptable tolerances that the equipment must conform to. This unit has some inactive pixels within acceptable tolerances which may result in inactive dots on the picture screen. This will not affect the picture quality or the life expectancy of the unit.



Dimensions

Units: inches (mm)

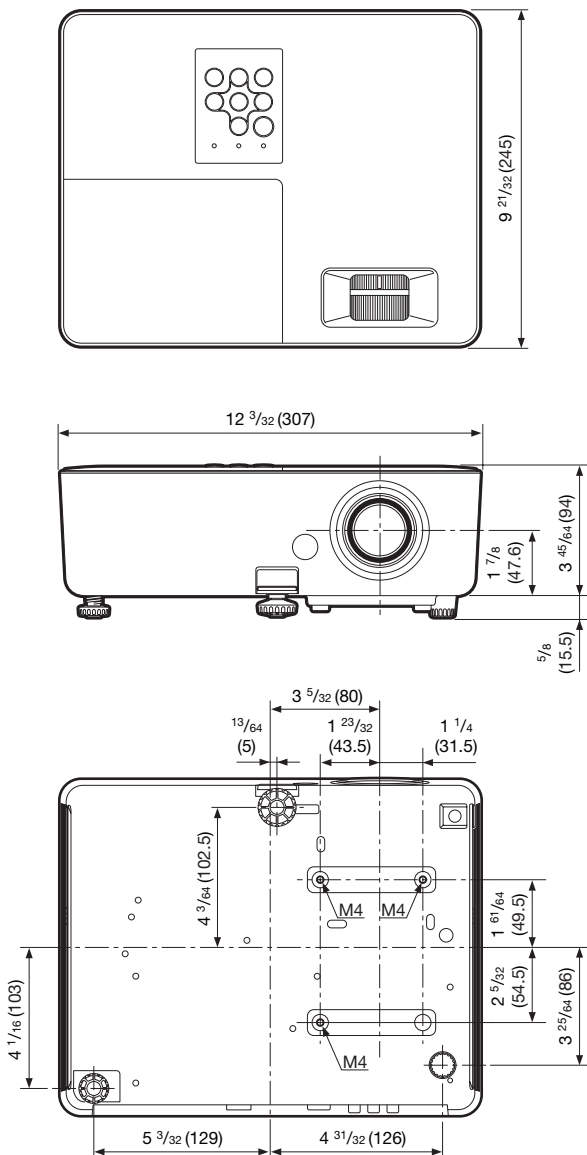

- Screw hole specs: 75 mm × 104 mm
- Depth of mounting holes: 8 mm
- Standard screw: M4 (pitch 0.7 mm)
- Quantity: 3

Index

16:9	30, 31
3D MODE button	59
Accessories	3
AC socket	22
Adjustment buttons	39, 40
Adjustment foot	27
All Reset	53
AREA ZOOM	31
Aspect ratio	30
Audio input	29
AUDIO terminal	22
Audio Mute	53
Auto Power Off	50
Auto Restart	50
Auto Sync (Auto Sync adjustment)	35, 50
AUTO SYNC button	35
AV MUTE button	29
Background	49
Batteries	13
Blue	43
BORDER	30, 31
BREAK TIMER button	34
Bright	43
BrilliantColor™	43
Clock	45
Closed Caption	49
CLR Temp (Color Temperature)	43
C.M.S.	43
Color	43
Complete Menu	40
COMPUTER/COMPONENT input terminal	20, 21
Contrast	43
DLP® Link™	59
DLP® Link™ Invert	59
DNR	45
Dynamic Range	46
Eco+Quiet	34, 44
ECO+QUIET button	34
EFFECT button	34
ENTER button	39
Exhaust vent	11, 60
Fan Mode	50
Film Mode	44
Focus ring	26
FREEZE button	35
FULL	30
FUNCTION button	12
FUNCTION Button setting	53
HDMI terminal	20-22
HEIGHT ADJUST lever	27
H-Pos	45
Image shift	47
Information	40
INPUT modes	29
Input Search Start	40
Intake vent	10, 60
Kensington Security Standard connector	11
Keycode	51
Keylock	52
KEYSTONE button	28
Keystone Correction	28, 47
Lamp	63
Lamp indicator	61
Lamp Timer (Life)	53
Lamp unit	64
Language (on-screen display language)	49
MAGNIFY buttons	35
MENU button	39
NATIVE	30
NORMAL	30, 31
ON button	25
Optional accessories	3
OSD Display	48
Overscan	48
Phase	46
Picture Adjustment	42
Picture Mode	35, 42
PICTURE MODE button	35
POINTER button	34
Power cord	22
Power indicator	61
PRJ-ADJ1/2	50
PRJ Mode	19, 49
Quick Start Menu	40
Red	43
Remote control	12
Remote control sensor	13
Replacing the lamp	63, 64
Resize	30, 47
RESIZE button	30
Resolution	45
RETURN button	39
RGB cable	20
RS-232C terminal	23
SCR-ADJ	47
Screen Size and Projection Distance	17
Security bar	10
Setup Guide	26, 49
Sharp	43
SIG-ADJ	45
Signal Info	46
Signal Type	45
Speaker	50
SPOT button	34
STANDBY button	25
STANDBY Mode	53
STANDBY/ON button	25
Supplied accessories	3
System Lock	51
Temperature warning indicator	61
Tint	43
Video Setup	45
Video System	45
VIDEO terminal	21
VOL (Volume) buttons	29
V-Pos	45
V-STRETCH	31
Wall Color	49
Zoom ring	27



Free Manuals Download Website

<http://myh66.com>

<http://usermanuals.us>

<http://www.somanuals.com>

<http://www.4manuals.cc>

<http://www.manual-lib.com>

<http://www.404manual.com>

<http://www.luxmanual.com>

<http://aubethermostatmanual.com>

Golf course search by state

<http://golfingnear.com>

Email search by domain

<http://emailbydomain.com>

Auto manuals search

<http://auto.somanuals.com>

TV manuals search

<http://tv.somanuals.com>