

DATA PROJECTOR

MODEL

XG-P560W

XG-P560W-N

SETUP MANUAL

Setting up the Screen	2	Default Gateway Setting ([3]Default Gateway)	36
Screen Size and Projection Distance	3	User Name Setting ([4]User Name)	36
Connecting Pin Assignments	11	Password Setting ([5>Password)	37
Wired Remote Control Terminal Specifications	13	RS-232C Baud Rate Setting	
RS-232C Specifications and Commands	14	([6]RS-232C Baud Rate)	37
Setting up the Projector Network Environment ...	20	Projector Name Setting ([7]Projector Name)	37
1. Connecting the Projector to a Computer	21	DHCP Client Setting ([8]DHCP Client)	37
2. Setting an IP Address for the Computer	22	Disconnecting All Connections	
3. Setting up a Network Connection for the Projector ...	24	([D]Disconnect All)	38
Controlling the Projector via LAN	26	Entering ADVANCED SETUP MENU	
Controlling the Projector Using Internet Explorer		([A]Advanced Setup)	38
(Version 5.0 or later)	26	Setting Auto Logout Time	
Confirming the Projector Status (Status)	27	(ADVANCED[1]Auto Logout Time)	38
Controlling the Projector (Control)	27	Data Port Setting (ADVANCED[2]Data Port)	38
Setting and Adjusting the Projector		Carrying out Network Ping Test	
(Settings & Adjustments)	28	(ADVANCED[5]Network Ping Test)	39
Setting the Security (Network – Security)	28	Setting of Accept IP Address (ADVANCED	
Making General Settings for the Network		[6]Accept IP Addr(1) – [8]Accept IP Addr(3)) ..	39
(Network – General)	29	Accepting All IP Addresses	
Setting for Sending E-mail when an Error Occurs		(ADVANCED[9]Accept All IP Addr)	39
(Mail – Originator Settings)	29	Setting of Search Port	
Setting Error Items and Destination Addresses		(ADVANCED[0]Search Port)	40
to which E-mail is to be Sent when an		Return to Default Settings	
Error Occurs (Mail – Recipient Settings) ...	30	(ADVANCED[!]Restore Default Setting)	40
Setting Error Items and the URL that are to be		Return to Main Menu	
Displayed when an Error Occurs		(ADVANCED[Q]Return to Main Menu)	40
(Service & Support – Access URL)	30	Stack Projection	41
Setting the Projector Using RS-232C or Telnet ...	31	Setting up the Stack Projection	42
When Connecting Using RS-232C	31	Video Wall Projection	44
When Connecting Using Telnet	32	Setting up the Video Wall Projection [Basic]	45
SETUP MENU (Main Menu)	33	Adjusting the Position Horizontally and Vertically ...	47
ADVANCED SETUP MENU	33	Returning to the Default Video Wall Setup	47
Controlling the Projector Using RS-232C or Telnet ...	34	Assigning the Projected Image on the	
View Setting Detail List ([V]View All Setting)	34	Video Wall Setup	47
Set Items	34	Notes on the Wide Video Wall Projection	48
Save Settings and Quit ([S]Save & Quit)	35	Setting up the Video Wall Projection [Application]..	49
Quit without Saving Settings ([Q]Quit Unchanged) ...	35	Resetting the Lamp Timer of the Projector via LAN ...	53
IP Address Setting ([1]IP Address)	36	Troubleshooting	55
Subnet Mask Setting ([2]Subnet Mask)	36	Dimensions	58

Setting up the Screen

For optimal image quality, position the projector perpendicular to the screen with the projector's feet flat and level. Doing so will eliminate the need for Keystone correction and provide the best image quality.

Note

- The projector lens should be centered in the middle of the screen. If the horizontal line passing through the lens center is not perpendicular to the screen, the image will be distorted, making viewing difficult.
- For an optimal image, position the screen so that it is not in direct sunlight or room light. Light falling directly on the screen washes out the colors, making viewing difficult. Close the curtains and dim the lights when setting up the screen in a sunny or bright room.

Standard Setup (Front Projection)

- Place the projector at the required distance from the screen according to the desired picture size.

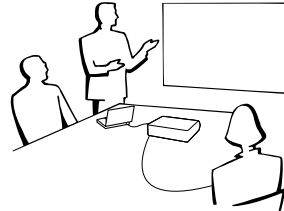

Example of standard setup

Side View

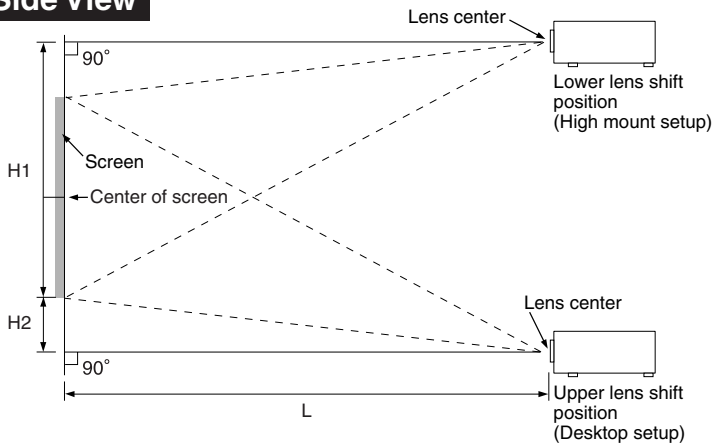

- The distance from the screen to the projector may vary depending on the size of the screen.

- The default setting can be used, when placing the projector in front of the screen. If the projected image is reversed, readjust the setting to "Front" in the "PRJ Mode" menu. (See page 62 of the projector's operation manual.)

Top View

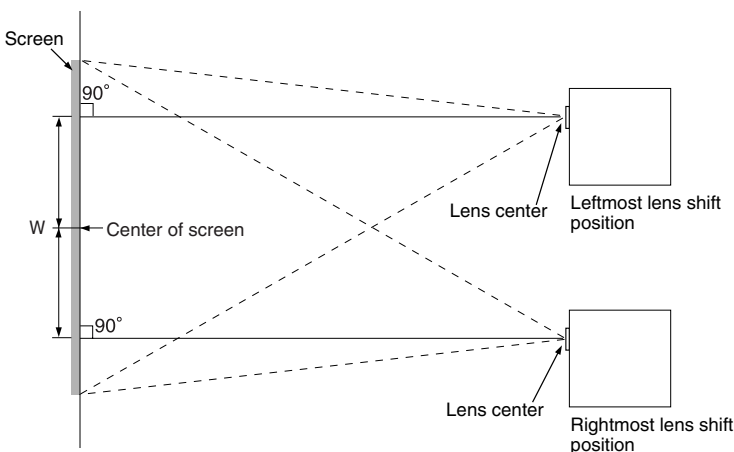

- Place the projector so that an imaginary horizontal line that passes through the center of the lens is perpendicular to the screen.

Screen Size and Projection Distance

The projection screen size varies according to the distance from the lens of the projector to the screen. The optional lenses from Sharp are also available for specialized application. Please see your nearest Sharp Authorized Projector Dealer to details on all the lenses. (Refer to the lens operation manual when using a lens.)

Install the projector so that projected images are projected onto the screen at the optimum size by referring to the table. Use the values in the table as a reference when installing the projector.

Throw Distance

The graph below is for 100 inches (254 cm) screen with 16:10 normal mode

Screen

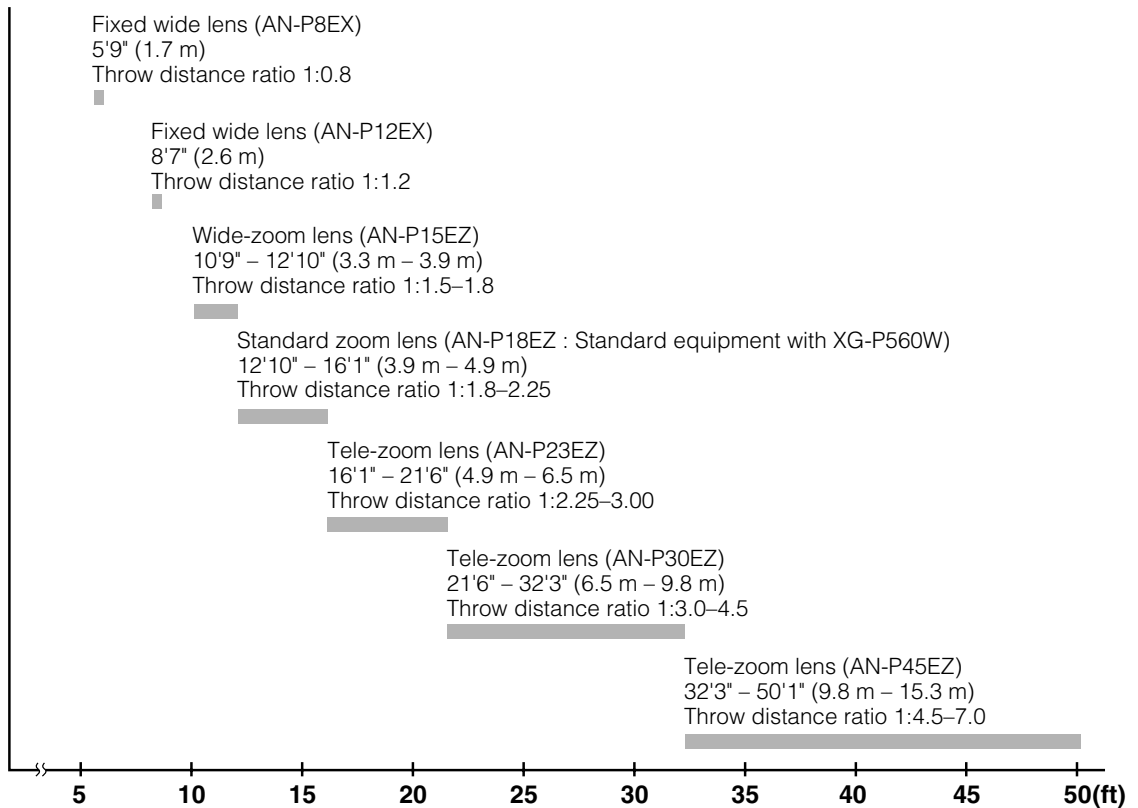

Screen Size and Projection Distance

Standard Zoom Lens (AN-P18EZ : Standard Equipment with XG-P560W) F2.5, f=25.5-32 mm

16:10 Signal Input (Normal Mode)

Picture (Screen) size			Projection distance [L]		Distance from the lens center to the bottom of the image [H]		Distance from the lens center to the center of the image [W]
Diag. [X]	Width	Height	Minimum [L1]	Maximum [L2]	Lower [H1]	Upper [H2]	
280" (711 cm)	603 cm (237")	377 cm (148")	11.0 m (36' 0")	13.7 m (45' 1")	-439.1 cm (-172 ^{55/64} ")	62.2 cm (24 ^{31/64} ")	±211.1 cm (83 ^{3/32} ")
250" (635 cm)	538 cm (212")	337 cm (132")	9.8 m (32' 2")	12.3 m (40' 3")	-392.0 cm (-154 ^{11/32} ")	55.5 cm (21 ^{55/64} ")	±188.4 cm (74 ^{3/16} ")
200" (508 cm)	431 cm (170")	269 cm (106")	7.8 m (25' 9")	9.8 m (32' 3")	-313.6 cm (-123 ^{15/32} ")	44.4 cm (17 ^{31/64} ")	±150.8 cm (59 ^{23/64} ")
150" (381 cm)	323 cm (127")	202 cm (79")	5.9 m (19' 3")	7.4 m (24' 2")	-235.2 cm (-92 ^{39/64} ")	33.3 cm (13 ^{7/64} ")	±113.1 cm (44 ^{33/64} ")
120" (305 cm)	258 cm (102")	162 cm (64")	4.7 m (15' 5")	5.9 m (19' 4")	-188.2 cm (-74 ^{9/64} ")	26.7 cm (10 ^{1/2} ")	±90.5 cm (35 ^{39/64} ")
100" (254 cm)	215 cm (85")	135 cm (53")	3.9 m (12' 10")	4.9 m (16' 1")	-156.8 cm (-61 ^{47/64} ")	22.2 cm (8 ^{3/4} ")	±75.4 cm (29 ^{43/64} ")
80" (203 cm)	172 cm (68")	108 cm (42")	3.1 m (10' 3")	3.9 m (12' 11")	-125.5 cm (-49 ^{25/64} ")	17.8 cm (7")	±60.3 cm (23 ^{47/64} ")
60" (152 cm)	129 cm (51")	81 cm (32")	2.4 m (7' 9")	2.9 m (9' 8")	-94.1 cm (-37 ^{3/64} ")	13.3 cm (5 ^{1/4} ")	±45.2 cm (17 ^{13/16} ")

X: Picture size (diag.) (in/cm)
 L1: Minimum projection distance (m/ft)
 L2: Maximum projection distance (m/ft)
 H1: Lower distance from the lens center to the bottom of the image (cm/in)
 H2: Upper distance from the lens center to the bottom of the image (cm/in)
 W: Distance from the lens center to the center of the image (cm/in)

The formula for picture size and projection distance

[m/cm]
 L1 (m) = 0.0392X
 L2 (m) = 0.0491X
 H1 (cm) = -1.56815X
 H2 (cm) = 0.2221X
 W (cm) = ±0.75379X
[Feet/inches]
 L1 (ft) = 0.0392X / 0.3048
 L2 (ft) = 0.0491X / 0.3048
 H1 (in) = -1.56815X / 2.54
 H2 (in) = 0.2221X / 2.54
 W (in) = ±0.75379X / 2.54

4:3 Signal Input (Normal Mode)

Picture (Screen) size			Projection distance [L]		Distance from the lens center to the bottom of the image [H]		Distance from the lens center to the center of the image [W]
Diag. [X]	Width	Height	Minimum [L1]	Maximum [L2]	Lower [H1]	Upper [H2]	
240" (610 cm)	488 cm (192")	366 cm (144")	10.7 m (34' 11")	13.3 m (43' 9")	-426.1 cm (-167 ^{47/64} ")	60.3 cm (23 ^{3/4} ")	±204.8 cm (80 ^{41/64} ")
200" (508 cm)	406 cm (160")	305 cm (120")	8.9 m (29' 1")	11.1 m (36' 6")	-355.1 cm (-139 ^{25/32} ")	50.3 cm (19 ^{51/64} ")	±170.7 cm (67 ^{13/64} ")
150" (381 cm)	305 cm (120")	229 cm (90")	6.7 m (21' 10")	8.3 m (27' 4")	-266.3 cm (-104 ^{21/32} ")	37.7 cm (14 ^{27/32} ")	±128.0 cm (50 ^{13/32} ")
120" (305 cm)	244 cm (96")	183 cm (72")	5.3 m (17' 6")	6.7 m (21' 11")	-213.0 cm (-83 ^{7/8} ")	30.2 cm (11 ^{7/8} ")	±102.4 cm (40 ^{5/16} ")
100" (254 cm)	203 cm (80")	152 cm (60")	4.4 m (14' 7")	5.6 m (18' 3")	-177.5 cm (-69 ^{57/64} ")	25.1 cm (9 ^{29/32} ")	±85.3 cm (33 ^{19/32} ")
80" (203 cm)	163 cm (64")	122 cm (48")	3.6 m (11' 8")	4.4 m (14' 7")	-142.0 cm (-55 ^{29/32} ")	20.1 cm (7 ^{59/64} ")	±68.3 cm (26 ^{7/8} ")
70" (178 cm)	142 cm (56")	107 cm (42")	3.1 m (10' 2")	3.9 m (12' 9")	-124.3 cm (-48 ^{59/64} ")	17.6 cm (6 ^{59/64} ")	±59.7 cm (23 ^{33/64} ")
60" (152 cm)	122 cm (48")	91 cm (36")	2.7 m (8' 9")	3.3 m (10' 11")	-106.5 cm (-41 ^{15/16} ")	15.1 cm (5 ^{15/16} ")	±51.2 cm (20 ^{5/32} ")

X: Picture size (diag.) (in/cm)
 L1: Minimum projection distance (m/ft)
 L2: Maximum projection distance (m/ft)
 H1: Lower distance from the lens center to the bottom of the image (cm/in)
 H2: Upper distance from the lens center to the bottom of the image (cm/in)
 W: Distance from the lens center to the center of the image (cm/in)

The formula for picture size and projection distance

[m/cm]
 L1 (m) = 0.04438X
 L2 (m) = 0.05559X
 H1 (cm) = -1.77527X
 H2 (cm) = 0.25143X
 W (cm) = ±0.85344X
[Feet/inches]
 L1 (ft) = 0.04438X / 0.3048
 L2 (ft) = 0.05559X / 0.3048
 H1 (in) = -1.77527X / 2.54
 H2 (in) = 0.25143X / 2.54
 W (in) = ±0.85344X / 2.54



- Allow a margin of error in the value in the diagrams above.
- When the distance from the lens center to the bottom of the image [H] is a negative number, this indicates that the bottom of the image is below the lens center.

Fixed Wide Lens (AN-P8EX)

F2.5, f=11.6 mm

16:10 Signal Input (Normal Mode)

Picture (Screen) size			Projection distance [L]	Distance from the lens center to the bottom of the image [H]		Distance from the lens center to the center of the image [W]
Diag. [χ]	Width	Height		Lower [H1]	Upper [H2]	
140" (356 cm)	302 cm (119")	188 cm (74")	2.4 m (8' 0")	-135.7 cm (-53 ²⁷ / ₆₄ "	-52.8 cm (-20 ²⁵ / ₃₂ "	±33.2cm (13 ¹ / ₁₆ "
120" (305 cm)	258 cm (102")	162 cm (64")	2.1 m (6' 10")	-116.3 cm (-45 ²⁵ / ₃₂ "	-45.2 cm (-17 ¹³ / ₁₆ "	±28.4cm (11 ³ / ₁₆ "
100" (254 cm)	215 cm (85")	135 cm (53")	1.7 m (5' 9")	-96.9 cm (-38 ⁵ / ₃₂ "	-37.7 cm (-14 ²⁷ / ₃₂ "	±23.7cm (9 ²¹ / ₆₄ "
80" (203 cm)	172 cm (68")	108 cm (42")	1.4 m (4' 7")	-77.5 cm (-30 ¹⁷ / ₃₂ "	-30.2 cm (-11 ⁷ / ₈ "	±19.0cm (7 ¹⁵ / ₃₂ "

χ: Picture size (diag.) (in/cm)

L: Projection distance (m/ft)

H1: Lower distance from the lens center to the bottom of the image (cm/in)

H2: Upper distance from the lens center to the bottom of the image (cm/in)

W: Distance from the lens center to the center of the image (cm/in)

The formula for picture size and projection distance

[m/cm]

L (m) = 0.01744χ

H1 (cm) = -0.96916χ

H2 (cm) = -0.37689χ

W (cm) = ±0.23691χ

[Feet/inches]

L (ft) = 0.01744χ / 0.3048

H1 (in) = -0.96916χ / 2.54

H2 (in) = -0.37689χ / 2.54

W (in) = ±0.23691χ / 2.54

4:3 Signal Input (Normal Mode)

Picture (Screen) size			Projection distance [L]	Distance from the lens center to the bottom of the image [H]		Distance from the lens center to the center of the image [W]
Diag. [χ]	Width	Height		Lower [H1]	Upper [H2]	
120" (305 cm)	244 cm (96")	183 cm (72")	2.4 m (7' 9")	-131.7 cm (-51 ⁵³ / ₆₄ "	-51.2 cm (-20 ⁵ / ₃₂ "	±32.2cm (12 ⁴³ / ₆₄ "
100" (254 cm)	203 cm (80")	152 cm (60")	2.0 m (6' 6")	-109.7 cm (-43 ³ / ₁₆ "	-42.7 cm (-16 ⁵¹ / ₆₄ "	±26.8cm (10 ⁹ / ₁₆ "
80" (203 cm)	163 cm (64")	122 cm (48")	1.6 m (5' 2")	-87.8 cm (-34 ⁹ / ₁₆ "	-34.1 cm (-13 ⁷ / ₁₆ "	±21.5cm (8 ²⁹ / ₆₄ "
70" (178 cm)	142 cm (56")	107 cm (42")	1.4 m (4' 6")	-76.8 cm (-30 ¹⁵ / ₆₄ "	-29.9 cm (-11 ⁴⁹ / ₆₄ "	±18.8cm (7 ²⁵ / ₆₄ "

χ: Picture size (diag.) (in/cm)

L: Projection distance (m/ft)

H1: Lower distance from the lens center to the bottom of the image (cm/in)

H2: Upper distance from the lens center to the bottom of the image (cm/in)

W: Distance from the lens center to the center of the image (cm/in)

The formula for picture size and projection distance

[m/cm]

L (m) = 0.01974χ

H1 (cm) = -1.09716χ

H2 (cm) = -0.42667χ

W (cm) = ±0.26823χ

[Feet/inches]

L (ft) = 0.01974χ / 0.3048

H1 (in) = -1.09716χ / 2.54

H2 (in) = -0.42667χ / 2.54

W (in) = ±0.26823χ / 2.54



Note

- Allow a margin of error in the value in the diagrams above.
- When the distance from the lens center to the bottom of the image [H] is a negative number, this indicates that the bottom of the image is below the lens center.

Screen Size and Projection Distance

Fixed Wide Lens (AN-P12EX)

F2.5, f=17.1 mm

16:10 Signal Input (Normal Mode)

Picture (Screen) size			Projection distance [L]	Distance from the lens center to the bottom of the image [H]		Distance from the lens center to the center of the image [W]
Diag. [χ]	Width	Height		Lower [H1]	Upper [H2]	
230" (584 cm)	495 cm (195")	310 cm (122")	6.0 m (19' 9")	-222.9 cm (-87 ⁴⁹ / ₆₄ ")	-86.7 cm (-34 ¹ / ₈ ")	±54.5cm (21 ²⁹ / ₃₂ ")
200" (508 cm)	431 cm (170")	269 cm (106")	5.2 m (17' 2")	-193.8 cm (-76 ⁵ / ₁₆ ")	-75.4 cm (-29 ⁴³ / ₆₄ ")	±47.4cm (18 ²¹ / ₃₂ ")
150" (381 cm)	323 cm (127")	202 cm (79")	3.9 m (12' 11")	-145.4 cm (-57 ¹⁵ / ₆₄ ")	-56.5 cm (-22 ¹ / ₄ ")	±35.5cm (13 ⁶³ / ₆₄ ")
120" (305 cm)	258 cm (102")	162 cm (64")	3.1 m (10' 4")	-116.3 cm (-45 ²⁵ / ₃₂ ")	-45.2 cm (-17 ¹³ / ₁₆ ")	±28.4cm (11 ³ / ₁₆ ")
100" (254 cm)	215 cm (85")	135 cm (53")	2.6 m (8' 7")	-96.9 cm (-38 ⁵ / ₃₂ ")	-37.7 cm (-14 ²⁷ / ₃₂ ")	±23.7cm (9 ²¹ / ₃₂ ")
80" (203 cm)	172 cm (68")	108 cm (42")	2.1 m (6' 10")	-77.5 cm (-30 ¹⁷ / ₃₂ ")	-30.2 cm (-11 ⁷ / ₈ ")	±19.0cm (7 ¹⁵ / ₃₂ ")
60" (152 cm)	129 cm (51")	81 cm (32")	1.6 m (5' 2")	-58.1 cm (-22 ⁵⁷ / ₆₄ ")	-22.6 cm (-8 ²⁹ / ₃₂ ")	±14.2cm (5 ¹⁹ / ₃₂ ")

χ: Picture size (diag.) (in/cm)

L: Projection distance (m/ft)

H1: Lower distance from the lens center to the bottom of the image (cm/in)

H2: Upper distance from the lens center to the bottom of the image (cm/in)

W: Distance from the lens center to the center of the image (cm/in)

The formula for picture size and projection distance

[m/cm]

L (m) = 0.02619χ

H1 (cm) = -0.96916χ

H2 (cm) = -0.37689χ

W (cm) = ±0.23691χ

[Feet/inches]

L (ft) = 0.02619χ / 0.3048

H1 (in) = -0.96916χ / 2.54

H2 (in) = -0.37689χ / 2.54

W (in) = ±0.23691χ / 2.54

4:3 Signal Input (Normal Mode)

Picture (Screen) size			Projection distance [L]	Distance from the lens center to the bottom of the image [H]		Distance from the lens center to the center of the image [W]
Diag. [χ]	Width	Height		Lower [H1]	Upper [H2]	
200" (508 cm)	406 cm (160")	305 cm (120")	5.9 m (19' 5")	-219.4 cm (-86 ²⁵ / ₆₄ ")	-85.3 cm (-33 ¹⁹ / ₃₂ ")	±53.6cm (21 ¹ / ₈ ")
150" (381 cm)	305 cm (120")	229 cm (90")	4.4 m (14' 7")	-164.6 cm (-64 ⁵¹ / ₆₄ ")	-64.0 cm (-25 ¹³ / ₆₄ ")	±40.2cm (15 ²⁷ / ₃₂ ")
120" (305 cm)	244 cm (96")	183 cm (72")	3.6 m (11' 8")	-131.7 cm (-51 ⁵³ / ₆₄ ")	-51.2 cm (-20 ⁵ / ₃₂ ")	±32.2cm (12 ⁴³ / ₆₄ ")
100" (254 cm)	203 cm (80")	152 cm (60")	3.0 m (9' 9")	-109.7 cm (-43 ³ / ₁₆ ")	-42.7 cm (-16 ⁵¹ / ₆₄ ")	±26.8cm (10 ⁹ / ₁₆ ")
80" (203 cm)	163 cm (64")	122 cm (48")	2.4 m (7' 9")	-87.8 cm (-34 ⁹ / ₁₆ ")	-34.1 cm (-13 ⁷ / ₁₆ ")	±21.5cm (8 ²⁹ / ₆₄ ")
70" (178 cm)	142 cm (56")	107 cm (42")	2.1 m (6' 10")	-76.8 cm (-30 ¹⁵ / ₆₄ ")	-29.9 cm (-11 ⁴⁹ / ₆₄ ")	±18.8cm (7 ²⁵ / ₆₄ ")
60" (152 cm)	122 cm (48")	91 cm (36")	1.8 m (5' 10")	-65.8 cm (-25 ⁵⁹ / ₆₄ ")	-25.6 cm (-10 ⁵ / ₆₄ ")	±16.1cm (6 ¹¹ / ₃₂ ")

χ: Picture size (diag.) (in/cm)

L: Projection distance (m/ft)

H1: Lower distance from the lens center to the bottom of the image (cm/in)

H2: Upper distance from the lens center to the bottom of the image (cm/in)

W: Distance from the lens center to the center of the image (cm/in)

The formula for picture size and projection distance

[m/cm]

L (m) = 0.02965χ

H1 (cm) = -1.09716χ

H2 (cm) = -0.42667χ

W (cm) = ±0.26823χ

[Feet/inches]

L (ft) = 0.02965χ / 0.3048

H1 (in) = -1.09716χ / 2.54

H2 (in) = -0.42667χ / 2.54

W (in) = ±0.26823χ / 2.54

Note

- Allow a margin of error in the value in the diagrams above.
- When the distance from the lens center to the bottom of the image [H] is a negative number, this indicates that the bottom of the image is below the lens center.

Wide-zoom Lens (AN-P15EZ)

F2.5, f=21.2-25.8 mm

16:10 Signal Input (Normal Mode)

Picture (Screen) size			Projection distance [L]		Distance from the lens center to the bottom of the image [H]		Distance from the lens center to the center of the image [W]
Diag. [χ]	Width	Height	Minimum [L1]	Maximum [L2]	Lower [H1]	Upper [H2]	
230" (584 cm)	495 cm (195")	310 cm (122")	7.5 m (24' 8")	9.0 m (29' 7")	-360.7 cm (-142")	51.1 cm (20 7/64")	±173.4cm (68 1/4")
200" (508 cm)	431 cm (170")	269 cm (106")	6.5 m (21' 6")	7.8 m (25' 9")	-313.6 cm (-123 15/32")	44.4 cm (17 31/64")	±150.8cm (59 23/64")
150" (381 cm)	323 cm (127")	202 cm (79")	4.9 m (16' 1")	5.9 m (19' 3")	-235.2 cm (-92 39/64")	33.3 cm (13 7/64")	±113.1cm (44 33/64")
120" (305 cm)	258 cm (102")	162 cm (64")	3.9 m (12' 11")	4.7 m (15' 5")	-188.2 cm (-74 5/64")	26.7 cm (10 1/2")	±90.5cm (35 39/64")
100" (254 cm)	215 cm (85")	135 cm (53")	3.3 m (10' 9")	3.9 m (12' 10")	-156.8 cm (-61 47/64")	22.2 cm (8 3/4")	±75.4cm (29 43/64")
80" (203 cm)	172 cm (68")	108 cm (42")	2.6 m (8' 7")	3.1 m (10' 3")	-125.5 cm (-49 25/64")	17.8 cm (7")	±60.3cm (23 47/64")
60" (152 cm)	129 cm (51")	81 cm (32")	2.0 m (6' 5")	2.4 m (7' 9")	-94.1 cm (-37 3/64")	13.3 cm (5 1/4")	±45.2cm (17 13/16")

χ: Picture size (diag.) (in/cm)
 L1: Minimum projection distance (m/ft)
 L2: Maximum projection distance (m/ft)
 H1: Lower distance from the lens center to the bottom of the image (cm/in)
 H2: Upper distance from the lens center to the bottom of the image (cm/in)
 W: Distance from the lens center to the center of the image (cm/in)

The formula for picture size and projection distance

[m/cm]
 L1 (m) = 0.03274χ
 L2 (m) = 0.0392χ
 H1 (cm) = -1.56815χ
 H2 (cm) = 0.2221χ
 W (cm) = ±0.75379χ
[Feet/inches]
 L1 (ft) = 0.03274χ / 0.3048
 L2 (ft) = 0.0392χ / 0.3048
 H1 (in) = -1.56815χ / 2.54
 H2 (in) = 0.2221χ / 2.54
 W (in) = ±0.75379χ / 2.54

4:3 Signal Input (Normal Mode)

Picture (Screen) size			Projection distance [L]		Distance from the lens center to the bottom of the image [H]		Distance from the lens center to the center of the image [W]
Diag. [χ]	Width	Height	Minimum [L1]	Maximum [L2]	Lower [H1]	Upper [H2]	
200" (508 cm)	406 cm (160")	305 cm (120")	7.4 m (24' 4")	8.9 m (29' 1")	-355.1 cm (-139 29/32")	50.3 cm (19 51/64")	±170.7cm (67 13/64")
150" (381 cm)	305 cm (120")	229 cm (90")	5.6 m (18' 3")	6.7 m (21' 10")	-266.3 cm (-104 27/32")	37.7 cm (14 27/32")	±128.0cm (50 13/32")
120" (305 cm)	244 cm (96")	183 cm (72")	4.4 m (14' 7")	5.3 m (17' 6")	-213.0 cm (-83 7/8")	30.2 cm (11 7/8")	±102.4cm (40 5/16")
100" (254 cm)	203 cm (80")	152 cm (60")	3.7 m (12' 2")	4.4 m (14' 7")	-177.5 cm (-69 57/64")	25.1 cm (9 29/32")	±85.3cm (33 19/32")
80" (203 cm)	163 cm (64")	122 cm (48")	3.0 m (9' 9")	3.6 m (11' 8")	-142.0 cm (-55 29/32")	20.1 cm (7 59/64")	±68.3cm (26 7/8")
70" (178 cm)	142 cm (56")	107 cm (42")	2.6 m (8' 6")	3.1 m (10' 2")	-124.3 cm (-48 59/64")	17.6 cm (6 59/64")	±59.7cm (23 33/64")
60" (152 cm)	122 cm (48")	91 cm (36")	2.2 m (7' 4")	2.7 m (8' 9")	-106.5 cm (-41 15/16")	15.1 cm (5 15/16")	±51.2cm (20 5/32")

χ: Picture size (diag.) (in/cm)
 L1: Minimum projection distance (m/ft)
 L2: Maximum projection distance (m/ft)
 H1: Lower distance from the lens center to the bottom of the image (cm/in)
 H2: Upper distance from the lens center to the bottom of the image (cm/in)
 W: Distance from the lens center to the center of the image (cm/in)

The formula for picture size and projection distance

[m/cm]
 L1 (m) = 0.03706χ
 L2 (m) = 0.04438χ
 H1 (cm) = -1.77527χ
 H2 (cm) = 0.25143χ
 W (cm) = ±0.85344χ
[Feet/inches]
 L1 (ft) = 0.03706χ / 0.3048
 L2 (ft) = 0.04438χ / 0.3048
 H1 (in) = -1.77527χ / 2.54
 H2 (in) = 0.25143χ / 2.54
 W (in) = ±0.85344χ / 2.54



Note

- Allow a margin of error in the value in the diagrams above.
- When the distance from the lens center to the bottom of the image [H] is a negative number, this indicates that the bottom of the image is below the lens center.

Screen Size and Projection Distance

Tele-zoom Lens (AN-P23EZ)

F2.5, f=31.9-42.5 mm

16:10 Signal Input (Normal Mode)

Picture (Screen) size			Projection distance [L]		Distance from the lens center to the bottom of the image [H]		Distance from the lens center to the center of the image [W]
Diag. [χ]	Width	Height	Minimum [L1]	Maximum [L2]	Lower [H1]	Upper [H2]	
230" (584 cm)	495 cm (195")	310 cm (122")	11.3 m (37' 1")	15.1 m (49' 5")	-360.7 cm (-142")	51.1 cm (20 7/64")	±173.4cm (68 1/4")
200" (508 cm)	431 cm (170")	269 cm (106")	9.8 m (32' 3")	13.1 m (43' 0")	-313.6 cm (-123 15/32")	44.4 cm (17 31/64")	±150.8cm (59 23/64")
150" (381 cm)	323 cm (127")	202 cm (79")	7.4 m (24' 2")	9.8 m (32' 3")	-235.2 cm (-92 39/64")	33.3 cm (13 7/64")	±113.1cm (44 33/64")
120" (305 cm)	258 cm (102")	162 cm (64")	5.9 m (19' 4")	7.9 m (25' 9")	-188.2 cm (-74 5/64")	26.7 cm (10 1/2")	±90.5cm (35 39/64")
100" (254 cm)	215 cm (85")	135 cm (53")	4.9 m (16' 1")	6.5 m (21' 6")	-156.8 cm (-61 47/64")	22.2 cm (8 3/4")	±75.4cm (29 43/64")
80" (203 cm)	172 cm (68")	108 cm (42")	3.9 m (12' 11")	5.2 m (17' 2")	-125.5 cm (-49 25/64")	17.8 cm (7")	±60.3cm (23 47/64")
60" (152 cm)	129 cm (51")	81 cm (32")	2.9 m (9' 8")	3.9 m (12' 11")	-94.1 cm (-37 3/64")	13.3 cm (5 1/4")	±45.2cm (17 13/16")

χ: Picture size (diag.) (in/cm)

L1: Minimum projection distance (m/ft)

L2: Maximum projection distance (m/ft)

H1: Lower distance from the lens center to the bottom of the image (cm/in)

H2: Upper distance from the lens center to the bottom of the image (cm/in)

W: Distance from the lens center to the center of the image (cm/in)

The formula for picture size and projection distance

[m/cm]

L1 (m) = 0.0491χ

L2 (m) = 0.06547χ

H1 (cm) = -1.56815χ

H2 (cm) = 0.2221χ

W (cm) = ±0.75379χ

[Feet/inches]

L1 (ft) = 0.0491χ / 0.3048

L2 (ft) = 0.06547χ / 0.3048

H1 (in) = -1.56815χ / 2.54

H2 (in) = 0.2221χ / 2.54

W (in) = ±0.75379χ / 2.54

4:3 Signal Input (Normal Mode)

Picture (Screen) size			Projection distance [L]		Distance from the lens center to the bottom of the image [H]		Distance from the lens center to the center of the image [W]
Diag. [χ]	Width	Height	Minimum [L1]	Maximum [L2]	Lower [H1]	Upper [H2]	
200" (508 cm)	406 cm (160")	305 cm (120")	11.1 m (36' 6")	14.8 m (48' 8")	-355.1 cm (-139 23/32")	50.3 cm (19 51/64")	±170.7cm (67 13/32")
150" (381 cm)	305 cm (120")	229 cm (90")	8.3 m (27' 4")	11.1 m (36' 6")	-266.3 cm (-104 27/32")	37.7 cm (14 27/32")	±128.0cm (50 13/32")
120" (305 cm)	244 cm (96")	183 cm (72")	6.7 m (21' 11")	8.9 m (29' 2")	-213.0 cm (-83 7/8")	30.2 cm (11 7/8")	±102.4cm (40 5/16")
100" (254 cm)	203 cm (80")	152 cm (60")	5.6 m (18' 3")	7.4 m (24' 4")	-177.5 cm (-69 57/64")	25.1 cm (9 29/32")	±85.3cm (33 19/32")
80" (203 cm)	163 cm (64")	122 cm (48")	4.4 m (14' 7")	5.9 m (19' 5")	-142.0 cm (-55 29/32")	20.1 cm (7 59/64")	±68.3cm (26 7/8")
70" (178 cm)	142 cm (56")	107 cm (42")	3.9 m (12' 9")	5.2 m (17' 0")	-124.3 cm (-48 59/64")	17.6 cm (6 59/64")	±59.7cm (23 33/64")
60" (152 cm)	122 cm (48")	91 cm (36")	3.3 m (10' 11")	4.4 m (14' 7")	-106.5 cm (-41 15/16")	15.1 cm (5 15/16")	±51.2cm (20 5/32")

χ: Picture size (diag.) (in/cm)

L1: Minimum projection distance (m/ft)

L2: Maximum projection distance (m/ft)

H1: Lower distance from the lens center to the bottom of the image (cm/in)

H2: Upper distance from the lens center to the bottom of the image (cm/in)

W: Distance from the lens center to the center of the image (cm/in)

The formula for picture size and projection distance

[m/cm]

L1 (m) = 0.05559χ

L2 (m) = 0.07412χ

H1 (cm) = -1.77527χ

H2 (cm) = 0.25143χ

W (cm) = ±0.85344χ

[Feet/inches]

L1 (ft) = 0.05559χ / 0.3048

L2 (ft) = 0.07412χ / 0.3048

H1 (in) = -1.77527χ / 2.54

H2 (in) = 0.25143χ / 2.54

W (in) = ±0.85344χ / 2.54

Note

- Allow a margin of error in the value in the diagrams above.
- When the distance from the lens center to the bottom of the image [H] is a negative number, this indicates that the bottom of the image is below the lens center.

Tele-zoom Lens (AN-P30EZ)

F2.5, f=40.8-62.8 mm

16:10 Signal Input (Normal Mode)

Picture (Screen) size			Projection distance [L]		Distance from the lens center to the bottom of the image [H]		Distance from the lens center to the center of the image [W]
Diag. [χ]	Width	Height	Minimum [L1]	Maximum [L2]	Lower [H1]	Upper [H2]	
230" (584 cm)	495 cm (195")	310 cm (122")	15.1 m (49' 5")	22.6 m (74' 1")	-360.7 cm (-142")	51.1 cm (20 7/64")	±173.4cm (68 1/4")
200" (508 cm)	431 cm (170")	269 cm (106")	13.1 m (43' 0")	19.6 m (64' 5")	-313.6 cm (-123 15/32")	44.4 cm (17 31/64")	±150.8cm (59 23/64")
150" (381 cm)	323 cm (127")	202 cm (79")	9.8 m (32' 3")	14.7 m (48' 4")	-235.2 cm (-92 39/64")	33.3 cm (13 7/64")	±113.1cm (44 33/64")
120" (305 cm)	258 cm (102")	162 cm (64")	7.9 m (25' 9")	11.8 m (38' 8")	-188.2 cm (-74 5/64")	26.7 cm (10 1/2")	±90.5cm (35 39/64")
100" (254 cm)	215 cm (85")	135 cm (53")	6.5 m (21' 6")	9.8 m (32' 3")	-156.8 cm (-61 47/64")	22.2 cm (8 3/4")	±75.4cm (29 43/64")
80" (203 cm)	172 cm (68")	108 cm (42")	5.2 m (17' 2")	7.9 m (25' 9")	-125.5 cm (-49 25/64")	17.8 cm (7")	±60.3cm (23 47/64")
60" (152 cm)	129 cm (51")	81 cm (32")	3.9 m (12' 11")	5.9 m (19' 4")	-94.1 cm (-37 3/64")	13.3 cm (5 1/4")	±45.2cm (17 13/16")

χ: Picture size (diag.) (in/cm)
 L1: Minimum projection distance (m/ft)
 L2: Maximum projection distance (m/ft)
 H1: Lower distance from the lens center to the bottom of the image (cm/in)
 H2: Upper distance from the lens center to the bottom of the image (cm/in)
 W: Distance from the lens center to the center of the image (cm/in)

The formula for picture size and projection distance
[m/cm]
 L1 (m) = 0.06547X
 L2 (m) = 0.09821X
 H1 (cm) = -1.56815X
 H2 (cm) = 0.2221X
 W (cm) = ±0.75379X
[Feet/inches]
 L1 (ft) = 0.06547X / 0.3048
 L2 (ft) = 0.09821X / 0.3048
 H1 (in) = -1.56815X / 2.54
 H2 (in) = 0.2221X / 2.54
 W (in) = ±0.75379X / 2.54

4:3 Signal Input (Normal Mode)

Picture (Screen) size			Projection distance [L]		Distance from the lens center to the bottom of the image [H]		Distance from the lens center to the center of the image [W]
Diag. [χ]	Width	Height	Minimum [L1]	Maximum [L2]	Lower [H1]	Upper [H2]	
200" (508 cm)	406 cm (160")	305 cm (120")	14.8 m (48' 8")	22.2 m (72' 11")	-355.1 cm (-139 25/32")	50.3 cm (19 51/64")	±170.7cm (67 13/64")
150" (381 cm)	305 cm (120")	229 cm (90")	11.1 m (36' 6")	16.7 m (54' 9")	-266.3 cm (-104 27/32")	37.7 cm (14 27/32")	±128.0cm (50 13/32")
120" (305 cm)	244 cm (96")	183 cm (72")	8.9 m (29' 2")	13.3 m (43' 9")	-213.0 cm (-83 7/8")	30.2 cm (11 7/8")	±102.4cm (40 5/16")
100" (254 cm)	203 cm (80")	152 cm (60")	7.4 m (24' 4")	11.1 m (36' 6")	-177.5 cm (-69 57/64")	25.1 cm (9 29/32")	±85.3cm (33 19/32")
80" (203 cm)	163 cm (64")	122 cm (48")	5.9 m (19' 5")	8.9 m (29' 2")	-142.0 cm (-55 29/32")	20.1 cm (7 59/64")	±68.3cm (26 7/8")
70" (178 cm)	142 cm (56")	107 cm (42")	5.2 m (17' 0")	7.8 m (25' 6")	-124.3 cm (-48 59/64")	17.6 cm (6 59/64")	±59.7cm (23 33/64")
60" (152 cm)	122 cm (48")	91 cm (36")	4.4 m (14' 7")	6.7 m (21' 11")	-106.5 cm (-41 15/16")	15.1 cm (5 15/16")	±51.2cm (20 5/32")

χ: Picture size (diag.) (in/cm)
 L1: Minimum projection distance (m/ft)
 L2: Maximum projection distance (m/ft)
 H1: Lower distance from the lens center to the bottom of the image (cm/in)
 H2: Upper distance from the lens center to the bottom of the image (cm/in)
 W: Distance from the lens center to the center of the image (cm/in)

The formula for picture size and projection distance
[m/cm]
 L1 (m) = 0.07412X
 L2 (m) = 0.11118X
 H1 (cm) = -1.77527X
 H2 (cm) = 0.25143X
 W (cm) = ±0.85344X
[Feet/inches]
 L1 (ft) = 0.07412X / 0.3048
 L2 (ft) = 0.11118X / 0.3048
 H1 (in) = -1.77527X / 2.54
 H2 (in) = 0.25143X / 2.54
 W (in) = ±0.85344X / 2.54



Note

- Allow a margin of error in the value in the diagrams above.
- When the distance from the lens center to the bottom of the image [H] is a negative number, this indicates that the bottom of the image is below the lens center.

Screen Size and Projection Distance

Tele-zoom Lens (AN-P45EZ)

F2.5, f=62.1-97.8 mm

16:10 Signal Input (Normal Mode)

Picture (Screen) size			Projection distance [L]		Distance from the lens center to the bottom of the image [H]		Distance from the lens center to the center of the image [W]
Diag. [χ]	Width	Height	Minimum [L1]	Maximum [L2]	Lower [H1]	Upper [H2]	
230" (584 cm)	495 cm (195")	310 cm (122")	22.6 m (74' 1")	35.1 m (115' 3")	-360.7 cm (-142")	51.1 cm (20 7/64")	±173.4cm (68 1/4")
200" (508 cm)	431 cm (170")	269 cm (106")	19.6 m (64' 5")	30.5 m (100' 2")	-313.6 cm (-123 15/32")	44.4 cm (17 31/64")	±150.8cm (59 23/64")
150" (381 cm)	323 cm (127")	202 cm (79")	14.7 m (48' 4")	22.9 m (75' 2")	-235.2 cm (-92 39/64")	33.3 cm (13 7/64")	±113.1cm (44 33/64")
120" (305 cm)	258 cm (102")	162 cm (64")	11.8 m (38' 8")	18.3 m (60' 1")	-188.2 cm (-74 5/64")	26.7 cm (10 1/2")	±90.5cm (35 39/64")
100" (254 cm)	215 cm (85")	135 cm (53")	9.8 m (32' 3")	15.3 m (50' 1")	-156.8 cm (-61 47/64")	22.2 cm (8 3/4")	±75.4cm (29 43/64")
80" (203 cm)	172 cm (68")	108 cm (42")	7.9 m (25' 9")	12.2 m (40' 1")	-125.5 cm (-49 25/64")	17.8 cm (7")	±60.3cm (23 47/64")
60" (152 cm)	129 cm (51")	81 cm (32")	5.9 m (19' 4")	9.2 m (30' 1")	-94.1 cm (-37 3/64")	13.3 cm (5 1/4")	±45.2cm (17 13/16")

χ: Picture size (diag.) (in/cm)

L1: Minimum projection distance (m/ft)

L2: Maximum projection distance (m/ft)

H1: Lower distance from the lens center to the bottom of the image (cm/in)

H2: Upper distance from the lens center to the bottom of the image (cm/in)

W: Distance from the lens center to the center of the image (cm/in)

The formula for picture size and projection distance

[m/cm]

L1 (m) = 0.09821χ

L2 (m) = 0.1527χ

H1 (cm) = -1.56815χ

H2 (cm) = 0.2221χ

W (cm) = ±0.75379χ

[Feet/inches]

L1 (ft) = 0.09821χ / 0.3048

L2 (ft) = 0.1527χ / 0.3048

H1 (in) = -1.56815χ / 2.54

H2 (in) = 0.2221χ / 2.54

W (in) = ±0.75379χ / 2.54

4:3 Signal Input (Normal Mode)

Picture (Screen) size			Projection distance [L]		Distance from the lens center to the bottom of the image [H]		Distance from the lens center to the center of the image [W]
Diag. [χ]	Width	Height	Minimum [L1]	Maximum [L2]	Lower [H1]	Upper [H2]	
200" (508 cm)	406 cm (160")	305 cm (120")	22.2 m (72' 11")	34.6 m (113' 5")	-355.1 cm (-139 23/32")	50.3 cm (19 51/64")	±170.7cm (67 13/64")
150" (381 cm)	305 cm (120")	229 cm (90")	16.7 m (54' 9")	25.9 m (85' 1")	-266.3 cm (-104 27/32")	37.7 cm (14 27/32")	±128.0cm (50 13/32")
120" (305 cm)	244 cm (96")	183 cm (72")	13.3 m (43' 9")	20.7 m (68' 1")	-213.0 cm (-83 7/8")	30.2 cm (11 7/8")	±102.4cm (40 5/16")
100" (254 cm)	203 cm (80")	152 cm (60")	11.1 m (36' 6")	17.3 m (56' 9")	-177.5 cm (-69 57/64")	25.1 cm (9 29/32")	±85.3cm (33 19/32")
80" (203 cm)	163 cm (64")	122 cm (48")	8.9 m (29' 2")	13.8 m (45' 4")	-142.0 cm (-55 29/32")	20.1 cm (7 59/64")	±68.3cm (26 7/8")
70" (178 cm)	142 cm (56")	107 cm (42")	7.8 m (25' 6")	12.1 m (39' 8")	-124.3 cm (-48 59/64")	17.6 cm (6 59/64")	±59.7cm (23 33/64")
60" (152 cm)	122 cm (48")	91 cm (36")	6.7 m (21' 11")	10.4 m (34' 0")	-106.5 cm (-41 15/16")	15.1 cm (5 15/16")	±51.2cm (20 5/32")

χ: Picture size (diag.) (in/cm)

L1: Minimum projection distance (m/ft)

L2: Maximum projection distance (m/ft)

H1: Lower distance from the lens center to the bottom of the image (cm/in)

H2: Upper distance from the lens center to the bottom of the image (cm/in)

W: Distance from the lens center to the center of the image (cm/in)

The formula for picture size and projection distance

[m/cm]

L1 (m) = 0.11118χ

L2 (m) = 0.17287χ

H1 (cm) = -1.77527χ

H2 (cm) = 0.25143χ

W (cm) = ±0.85344χ

[Feet/inches]

L1 (ft) = 0.11118χ / 0.3048

L2 (ft) = 0.17287χ / 0.3048

H1 (in) = -1.77527χ / 2.54

H2 (in) = 0.25143χ / 2.54

W (in) = ±0.85344χ / 2.54



Note

- Allow a margin of error in the value in the diagrams above.
- When the distance from the lens center to the bottom of the image [H] is a negative number, this indicates that the bottom of the image is below the lens center.

Connecting Pin Assignments

COMPUTER/COMPONENT input and COMPUTER/COMPONENT output Terminals: mini D-sub 15 pin female connector

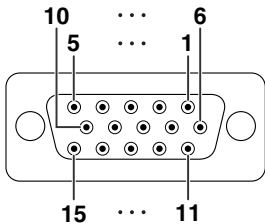

RGB Input

1. Video input (red)
2. Video input (green/sync on green)
3. Video input (blue)
4. Not connected
5. Not connected
6. Earth (red)
7. Earth (green/sync on green)
8. Earth (blue)
9. Not connected
10. GND
11. Not connected
12. Bi-directional data
13. Horizontal sync signal: TTL level
14. Vertical sync signal: TTL level
15. Data clock

Component Input

1. P_R (C_R)
2. Y
3. P_B (C_B)
4. Not connected
5. Not connected
6. Earth (P_R)
7. Earth (Y)
8. Earth (P_B)
9. Not connected
10. Not connected
11. Not connected
12. Not connected
13. Not connected
14. Not connected
15. Not connected

DVI-D Terminal: 24 pin connector

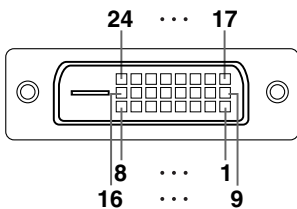

Pin No.	Name
1	T.M.D.S. Data 2-
2	T.M.D.S. Data 2+
3	T.M.D.S. Data 2 Shield
4	Not connected
5	Not connected
6	DDC Clock
7	DDC Data
8	Not connected
9	T.M.D.S. Data 1-
10	T.M.D.S. Data 1+
11	T.M.D.S. Data 1 Shield
12	Not connected
13	Not connected
14	+5 V Power
15	Ground
16	Hot Plug Detect

Pin No.	Name
17	T.M.D.S. Data 0-
18	T.M.D.S. Data 0+
19	T.M.D.S. Data 0 Shield
20	Not connected
21	Not connected
22	T.M.D.S. Clock Shield
23	T.M.D.S. Clock+
24	T.M.D.S. Clock-

HDMI Terminal

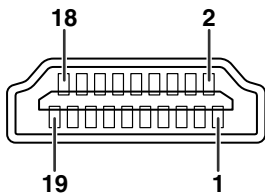

Pin No.	Name	Pin No.	Name	Pin No.	Name
1	T.M.D.S data 2+	8	T.M.D.S data 0 shield	14	Reserved
2	T.M.D.S data 2 shield	9	T.M.D.S data 0-	15	SCL
3	T.M.D.S data 2-	10	T.M.D.S clock+	16	SDA
4	T.M.D.S data 1+	11	T.M.D.S clock shield	17	DDC/CEC ground
5	T.M.D.S data 1 shield	12	T.M.D.S clock-	18	+5V power
6	T.M.D.S data 1-	13	CEC	19	Hot plug detection
7	T.M.D.S data 0+				

Connecting Pin Assignments

RS-232C Terminal: D-sub 9 pin male connector

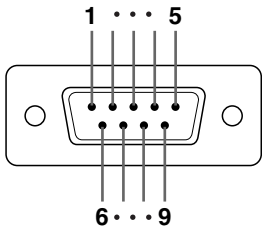

Pin No.	Signal	Name	I/O	Reference
1				Not connected
2	RD	Receive Data	Input	Connected to internal circuit
3	SD	Send Data	Output	Connected to internal circuit
4				Not connected
5	SG	Signal Ground		Connected to internal circuit
6				Not connected
7	RS	Request to Send		Connected to CS in internal circuit
8	CS	Clear to Send		Connected to RS in internal circuit
9				Not connected

RS-232C Cable recommended connection: D-sub 9-pin female connector

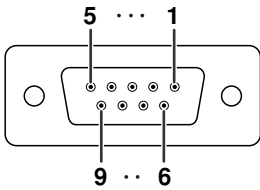

Pin No.	Signal	Pin No.	Signal
1	CD	1	CD
2	RD	2	RD
3	SD	3	SD
4	ER	4	ER
5	SG	5	SG
6	DR	6	DR
7	RS	7	RS
8	CS	8	CS
9	CI	9	CI

Note

- Depending on the controlling device used, it may be necessary to connect Pin 4 and Pin 6 on the controlling device (e.g. computer).



LAN Terminal: LAN (RJ-45)

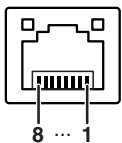

Pin No.	Signal	Pin No.	Signal
1	TX+	5	
2	TX-	6	RX-
3	RX+	7	
4		8	

Wired Remote Control Terminal Specifications

Specifications of wired remote control input

- ø3.5 mm minijack
- External: GND
- Internal: +3.3V

Function and transmission codes

CONTROL ITEM	SYSTEM CODE					DATA CODE								JUDGEMENT CODE	
	C1	C2	C3	C4	C5	C6	C7	C8	C9	C10	C11	C12	C13	C14	C15
STANDBY	1	0	1	1	0	0	1	1	0	1	0	0	1	1	0
ON	1	0	1	1	0	0	1	1	0	1	0	1	0	1	0
ZOOM +	1	0	1	1	0	0	0	0	1	0	1	0	1	1	0
ZOOM -	1	0	1	1	0	1	0	0	1	0	1	0	1	1	0
FOCUS +	1	0	1	1	0	0	0	1	0	0	1	1	1	1	0
FOCUS -	1	0	1	1	0	1	0	1	0	0	1	1	1	1	0
H&V LENS SHIFT	1	0	1	1	0	0	0	1	1	0	0	0	1	1	0
KEYSTONE	1	0	1	1	0	1	1	0	1	0	0	0	1	1	0
MENU	1	0	1	1	0	0	0	1	0	0	0	1	1	1	0
▲	1	0	1	1	0	0	0	1	1	1	0	0	1	1	0
◀	1	0	1	1	0	0	0	0	0	1	0	1	0	1	0
▶	1	0	1	1	0	1	1	1	1	0	0	1	0	1	0
▼	1	0	1	1	0	1	0	1	1	1	0	0	1	1	0
ENTER	1	0	1	1	0	1	1	1	0	1	0	1	0	1	0
UNDO	1	0	1	1	0	1	0	0	1	1	0	1	0	1	0
MAGNIFY +	1	0	1	1	0	1	0	1	1	0	1	1	0	1	0
MAGNIFY -	1	0	1	1	0	1	0	1	1	0	1	0	1	1	0

CONTROL ITEM	SYSTEM CODE					DATA CODE								JUDGEMENT CODE	
	C1	C2	C3	C4	C5	C6	C7	C8	C9	C10	C11	C12	C13	C14	C15
FREEZE	1	0	1	1	0	1	0	1	1	0	0	0	1	1	0
VOL +	1	0	1	1	0	0	0	1	0	1	0	0	0	0	1
VOL -	1	0	1	1	0	1	0	1	0	1	0	0	0	0	1
BREAK TIMER	1	0	1	1	0	0	0	1	0	1	1	0	1	1	0
SHUTTER OPEN	1	0	1	1	0	0	1	0	0	1	0	0	1	1	0
SHUTTER CLOSE	1	0	1	1	0	1	1	0	0	1	0	0	1	1	0
MUTE	1	0	1	1	0	1	1	1	0	1	0	0	0	0	1
AUTO SYNC	1	0	1	1	0	0	1	0	1	1	1	1	1	1	0
PICTURE MODE	1	0	1	1	0	1	0	0	1	1	1	0	0	0	1
RESIZE	1	0	1	1	0	0	1	1	1	1	0	1	0	1	0
COMPUTER1	1	0	1	1	0	1	0	1	0	1	1	0	0	0	1
COMPUTER2	1	0	1	1	0	0	1	1	0	1	1	0	0	0	1
DVI-D	1	0	1	1	0	1	0	1	0	1	1	0	1	1	0
HDMI	1	0	1	1	0	1	0	0	0	1	0	0	1	1	0
VIDEO	1	0	1	1	0	0	1	0	0	1	1	0	0	0	1
S-VIDEO	1	0	1	1	0	1	1	0	0	1	1	0	0	0	1

Wired remote control function code

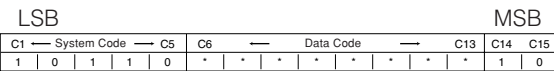

- System codes C1 to C5 are fixed at "10110".
- Codes C14 and C15 are reverse confirmation bits, with "10" indicating "Front" and "01" indicating "Rear".

Sharp remote control signal format

Transmission format: 15-bit format

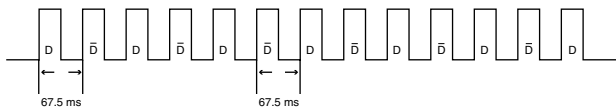

Wave form of output signal: Output using pulse position modulation

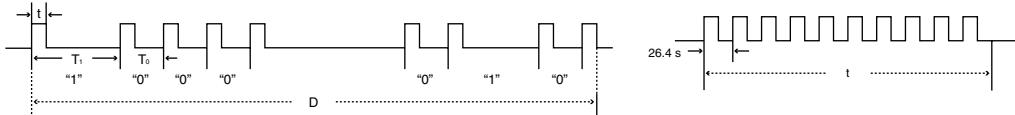

- $t = 264 \mu s$
- $T_0 = 1.05 ms$
- $T_1 = 2.10 ms$
- Pulse carrier frequency = 455/12 kHz
- Duty ratio = 1:1

Transmission control code

15 bit

C1	C2	C3	C4	C5	C6	C7	C8	C9	C10	C11	C12	C13	C14	C15	
System Address					Function Key Data Bit								Data Expansion	Mask	Data Determination
D to \bar{D} Common Data Bit					Reverse in \bar{D}										

Example of Reverse D to \bar{D}

D	C1	C2	C3	C4	C5	C6	C7	C8	C9	C10	C11	C12	C13	C14	C15
1	1	0	1	1	0	1	0	0	0	0	0	0	0	1	0
\bar{D}	C1	C2	C3	C4	C5	C6	C7	C8	C9	C10	C11	C12	C13	C14	C15
0	1	0	1	1	0	0	1	1	1	1	1	1	1	0	1

RS-232C Specifications and Commands

Computer control

A computer can be used to control the projector by connecting an RS-232C serial control cable (cross type, commercially available) to the projector. (See page 27 of the projector's operation manual for connection.)

Communication conditions

Set the serial port settings of the computer to match that of the table.

Signal format: Conforms to RS-232C standard.

Parity bit: None

Baud rate*: 9,600 bps / 38,400 bps / 115,200 bps

Stop bit: 1 bit

Data length: 8 bits

Flow control: None

*Set the projector's baud rate to the same rate as used by the computer.

Basic format

Commands from the computer are sent in the following order: command, parameter, and return code. After the projector processes the command from the computer, it sends a response code to the computer.

Command format

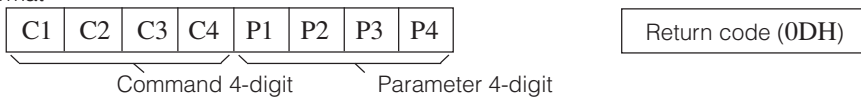

Response code format

Normal response



Problem response (communication error or incorrect command)



Info

- When you have more than one command to give to the projector, send each of them only after the response code for the previous one is received.
- "POWER????", "TABN ___ 1", "TLPS ___ 1", "TLPS ___ 2", "TPOW ___ 1", "TLPN ___ 1", "TLTT ___ 1", "TLTT ___ 2", "TLTM ___ 1", "TLTM ___ 2", "TLTL ___ 1", "TLTL ___ 2", "TNAM ___ 1", "MNRD ___ 1", "SNRD ___ 1", "PJNO ___ 1"
- When the projector receives the special commands shown above :
 - * The on-screen display will not disappear.
 - * The "Auto Power Off" timer will not be reset.
- The special commands are available for applications that require continuous polling.
(Do not repeatedly or periodically send any commands other than these special commands in STANDBY mode as it will cause problems.)

Note

- When controlling the projector using the RS-232C commands, you cannot confirm the projector setting values from the computer. To confirm each setting value, send the display command for each menu (e.g. RARE ___ 0), and then refer to the on-screen display. When using the setting/adjustment commands other than the menu display commands, the settings/adjustments are executed without the on-screen display.
- If an underbar (_) appears in the parameter column, enter a space.
- If an asterisk (*) appears in the parameter column, enter a value in the range indicated in brackets under Control Contents.

PJLink™ Compliant:

This product conforms with the PJLink standard Class 1 and all Class 1 commands are implemented.

This product conforms with the PJLink standard specification version 1.00.

For additional information, visit "<http://pjlink.jbmia.or.jp/english/>".

Commands

Example: When turning on the projector, make the following setting.

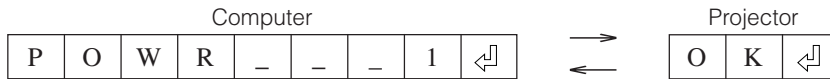

CONTROL CONTENTS		COMMAND	PARAMETER	RETURN		
				Power ON	Standby mode (or 40-second startup time)	
Power	On	P O W R	- - - - 1	OK	OK or ERR	
	Off	P O W R	- - - - 0	OK or ERR	OK	
Status		P O W R	? ? ? ? 1	1	0	
Projector Condition		T A B N	- - - - 1	0: Normal, 1: Temp High 8: Lamp Life 5% or less 16: Lamp Burn-out 32: Lamp Ignition Failure	0: Normal, 1: Temp High 2: Fan Error, 4: Cover Open 8: Lamp Life 5% or less 16: Lamp Burn-out 32: Lamp Ignition Failure 64: Temp Abnormally High	
Lamp	Lamp 1 Status	T L P S	- - - - 1	0:Off, 1:On, 2:Retry, 3:Waiting, 4:Lamp Error	0:Off, 4:Lamp Error	
	Lamp 2 Status	T L P S	- - - - 2	0:Off, 1:On, 2:Retry, 3:Waiting, 4:Lamp Error	0:Off, 4:Lamp Error	
	Lamp Power Status	T P O W	- - - - 1	1:On, 2:Cooling	0:Off	
	Quantity	T L P N	- - - - 1 2			
	Lamp 1 Usage Time(Hour)	T L T T	- - - - 1	0 - 9999 (Integer)		
	Lamp 2 Usage Time(Hour)	T L T T	- - - - 2	0 - 9999 (Integer)		
	Lamp 1 Usage Time(Minute)	T L T M	- - - - 1	0, 15, 30, 45		
	Lamp 2 Usage Time(Minute)	T L T M	- - - - 2	0, 15, 30, 45		
	Lamp 1 Life(Percentage)	T L T L	- - - - 1	0% - 100% (Integer)		
	Lamp 2 Life(Percentage)	T L T L	- - - - 2	0% - 100% (Integer)		
	Lamp 1 Lamp Timer Reset *1	L P R E	0 0 0 1	ERR	OK or ERR	
	Lamp 2 Lamp Timer Reset *1	L P R E	0 0 0 2	ERR	OK or ERR	
	Name	Model Name Check	T N A M	- - - - 1	XGP560W	
		Model Name Check	M N R D	- - - - 1	XG-P560W	
Serial No. Check *2		S N R D	- - - - 1	Serial No.		
Projector Name Setting 1 (First 4 characters) *3		P J N 1	* * * *	OK or ERR		
Projector Name Setting 2 (Middle 4 characters) *3		P J N 2	* * * *	OK or ERR		
Projector Name Setting 3 (Last 4 characters) *3		P J N 3	* * * *	OK or ERR		
Projector Name Check		P J N 0	- - - - 1	Projector Name		
Input Change		COMPUTER1	I R G B	- - - - 1	OK or ERR	ERR
	COMPUTER2	I R G B	- - - - 2	OK or ERR	ERR	
	DVI	I R G B	- - - - 3	OK or ERR	ERR	
	HDMI	I R G B	- - - - 4	OK or ERR	ERR	
	VIDEO	I V E D	- - - - 1	OK or ERR	ERR	
	S-VIDEO	I V E D	- - - - 2	OK or ERR	ERR	
	Input RGB Check	I R G B	? ? ? ?	1:COMPUTER1, 2:COMPUTER2, 3: DVI, 4: HDMI	ERR	
	Input Video Check	I V E D	? ? ? ?	1:VIDEO, 2: S-VIDEO	ERR	
	Input Mode Check	I M O D	? ? ? ?	1:RGB, 2:Video	ERR	
	Input Check	I C H K	? ? ? ?	1:COMPUTER1, 2:COMPUTER2 3: DVI, 4: HDMI, 5: VIDEO, 6: S-VIDEO	ERR	
Lens Focus	L N F O	* * * *	OK or ERR	ERR		
Lens Zoom	L N Z O	* * * *	OK or ERR	ERR		
Vertical Lens Shift	-800 - +800	L N S H	* * * *	OK or ERR	ERR	
	-800 - +800	L N U D	* * * *	OK or ERR	ERR	
Horizontal Lens Shift	L N L R	* * * *	OK or ERR	ERR		
Lens Shift Center	L N P D	- - - - 1	OK or ERR	ERR		
Lens Shutter	Close	L N S T	- - - - 1	OK or ERR	ERR	
	Open	L N S T	- - - - 0	OK or ERR	ERR	
Vertical Keystone	-80 - +80	K E Y S	- * * *	OK or ERR	ERR	
	-80 - +80	K E Y V	- * * *	OK or ERR	ERR	
Horizontal Keystone	-60 - +60	K E Y H	- * * *	OK or ERR	ERR	
Image Resizing	-30 - +30	I M R S	- * * *	OK or ERR	ERR	
Volume	Volume(0 - 60)	V O L A	- * * *	OK or ERR	ERR	
	Volume up/down(-10 - +10)	V O U D	- * * *	OK or ERR	ERR	
Mute	On	M U T E	- - - - 1	OK or ERR	ERR	
	Off	M U T E	- - - - 0	OK or ERR	ERR	
Freeze	On	F R E Z	- - - - 1	OK or ERR	ERR	
	Off	F R E Z	- - - - 0	OK or ERR	ERR	
Auto Sync	Start	A D J S	- - - - 1	OK or ERR	ERR	
Resize	COMPUTER1	Normal	R A S R	- - - - 1	OK or ERR	
		Stretch	R A S R	- - - - 2	OK or ERR	
		Dot By Dot	R A S R	- - - - 3	OK or ERR	
		Smart Stretch	R A S R	- - - - 4	OK or ERR	
		Full	R A S R	- - - - 5	OK or ERR	
		Area Zoom	R A S R	- - - - 1 0	OK or ERR	
		V-Stretch	R A S R	- - - - 1 1	OK or ERR	

RS-232C Specifications and Commands

CONTROL CONTENTS			COMMAND	PARAMETER	RETURN		
					Power ON	Standby mode (or 40-second startup time)	
Resize	COMPUTER2	Normal	R B S R	-- 1	OK or ERR	ERR	
		Stretch	R B S R	-- 2	OK or ERR	ERR	
		Dot By Dot	R B S R	-- 3	OK or ERR	ERR	
		Smart Stretch	R B S R	-- 4	OK or ERR	ERR	
		Full	R B S R	-- 5	OK or ERR	ERR	
		Area Zoom	R B S R	-- 1 0	OK or ERR	ERR	
		V-Stretch	R B S R	-- 1 1	OK or ERR	ERR	
	DVI	Normal	R C S R	-- 1	OK or ERR	ERR	
		Stretch	R C S R	-- 2	OK or ERR	ERR	
		Dot By Dot	R C S R	-- 3	OK or ERR	ERR	
		Smart Stretch	R C S R	-- 4	OK or ERR	ERR	
		Full	R C S R	-- 5	OK or ERR	ERR	
		Area Zoom	R C S R	-- 1 0	OK or ERR	ERR	
		V-Stretch	R C S R	-- 1 1	OK or ERR	ERR	
	HDMI	Normal	R D S R	-- 1	OK or ERR	ERR	
		Stretch	R D S R	-- 2	OK or ERR	ERR	
		Dot By Dot	R D S R	-- 3	OK or ERR	ERR	
		Smart Stretch	R D S R	-- 4	OK or ERR	ERR	
		Full	R D S R	-- 5	OK or ERR	ERR	
		Area Zoom	R D S R	-- 1 0	OK or ERR	ERR	
		V-Stretch	R D S R	-- 1 1	OK or ERR	ERR	
	VIDEO	Normal	R A S V	-- 1	OK or ERR	ERR	
		Stretch	R A S V	-- 2	OK or ERR	ERR	
		Smart Stretch	R A S V	-- 4	OK or ERR	ERR	
		Area Zoom	R A S V	-- 1 0	OK or ERR	ERR	
		V-Stretch	R A S V	-- 1 1	OK or ERR	ERR	
		S-VIDEO	Normal	R B S V	-- 1	OK or ERR	ERR
			Stretch	R B S V	-- 2	OK or ERR	ERR
	Smart Stretch		R B S V	-- 4	OK or ERR	ERR	
	Area Zoom		R B S V	-- 1 0	OK or ERR	ERR	
V-Stretch	R B S V		-- 1 1	OK or ERR	ERR		
COMPUTER1 input	Picture Mode		Standard	R A P S	-- 1 0	OK or ERR	ERR
			Presentation	R A P S	-- 1 1	OK or ERR	ERR
		Movie	R A P S	-- 1 2	OK or ERR	ERR	
		Custom	R A P S	-- 1 3	OK or ERR	ERR	
	Contrast	-30 ~ +30	R A P I	-- * * *	OK or ERR	ERR	
	Bright	-30 ~ +30	R A B R	-- * * *	OK or ERR	ERR	
	Color	-30 ~ +30	R A C O	-- * * *	OK or ERR	ERR	
	Tint	-30 ~ +30	R A T I	-- * * *	OK or ERR	ERR	
	Red	-30 ~ +30	R A R D	-- * * *	OK or ERR	ERR	
	Green	-30 ~ +30	R A G N	-- * * *	OK or ERR	ERR	
	Blue	-30 ~ +30	R A B E	-- * * *	OK or ERR	ERR	
	Sharp	-30 ~ +30	R A S H	-- * * *	OK or ERR	ERR	
	CLR Temp *4		R A C T	-- * * *	OK or ERR	ERR	
	Progressive	2D Progressive	R A I P	-- 0	OK or ERR	ERR	
		3D Progressive	R A I P	-- 1	OK or ERR	ERR	
	Film	Off	R A I P	-- 2	OK or ERR	ERR	
		Level 1	R A N R	-- 0	OK or ERR	ERR	
		Level 2	R A N R	-- 1	OK or ERR	ERR	
		Level 3	R A N R	-- 2	OK or ERR	ERR	
	Adjustment Reset	Signal Type	R A R E	-- 1	OK or ERR	ERR	
		Auto	I A S I	-- 0	OK or ERR	ERR	
		RGB	I A S I	-- 1	OK or ERR	ERR	
		Component	I A S I	-- 2	OK or ERR	ERR	
	Display (Status display)		R A R E	-- 0	OK or ERR	ERR	
	COMPUTER2 input	Picture Mode	Standard	R B P S	-- 1 0	OK or ERR	ERR
			Presentation	R B P S	-- 1 1	OK or ERR	ERR
			Movie	R B P S	-- 1 2	OK or ERR	ERR
			Custom	R B P S	-- 1 3	OK or ERR	ERR
		Contrast	-30 ~ +30	R B P I	-- * * *	OK or ERR	ERR
		Bright	-30 ~ +30	R B B R	-- * * *	OK or ERR	ERR
Color		-30 ~ +30	R B C O	-- * * *	OK or ERR	ERR	
Tint		-30 ~ +30	R B T I	-- * * *	OK or ERR	ERR	
Red		-30 ~ +30	R B R D	-- * * *	OK or ERR	ERR	
Green		-30 ~ +30	R B G N	-- * * *	OK or ERR	ERR	
Blue		-30 ~ +30	R B B E	-- * * *	OK or ERR	ERR	
Sharp		-30 ~ +30	R B S H	-- * * *	OK or ERR	ERR	
CLR Temp *4			R B C T	-- * * *	OK or ERR	ERR	
Progressive		2D Progressive	R B I P	-- 0	OK or ERR	ERR	
		3D Progressive	R B I P	-- 1	OK or ERR	ERR	
Film		Off	R B I P	-- 2	OK or ERR	ERR	
		Level 1	R B N R	-- 0	OK or ERR	ERR	
		Level 2	R B N R	-- 1	OK or ERR	ERR	
		Level 3	R B N R	-- 2	OK or ERR	ERR	
Adjustment Reset		Signal Type	R B R E	-- 1	OK or ERR	ERR	
		Auto	I B S I	-- 0	OK or ERR	ERR	
		RGB	I B S I	-- 1	OK or ERR	ERR	
		Component	I B S I	-- 2	OK or ERR	ERR	
Display (Status display)			R B R E	-- 0	OK or ERR	ERR	

RS-232C Specifications and Commands

CONTROL CONTENTS			COMMAND	PARAMETER	RETURN		
					Power ON	Standby mode (or 40-second startup time)	
DVI input	Picture Mode	Standard	R C P S	- - 1 0	OK or ERR	ERR	
		Presentation	R C P S	- - 1 1	OK or ERR	ERR	
		Movie	R C P S	- - 1 2	OK or ERR	ERR	
		Custom	R C P S	- - 1 3	OK or ERR	ERR	
	Contrast	-30 +30	R C P I	- * * *	OK or ERR	ERR	
	Bright	-30 +30	R C B R	- * * *	OK or ERR	ERR	
	Color	-30 +30	R C C O	- * * *	OK or ERR	ERR	
	Tint	-30 +30	R C T I	- * * *	OK or ERR	ERR	
	Red	-30 +30	R C R D	- * * *	OK or ERR	ERR	
	Green	-30 +30	R C G N	- * * *	OK or ERR	ERR	
	Blue	-30 +30	R C B E	- * * *	OK or ERR	ERR	
	Sharp	-30 +30	R C S H	- * * *	OK or ERR	ERR	
	CLR Temp *4		R C C T	- * * *	OK or ERR	ERR	
	Progressive	2D Progressive	R C I P	- - - 0	OK or ERR	ERR	
		3D Progressive	R C I P	- - - 1	OK or ERR	ERR	
		Film	R C I P	- - - 2	OK or ERR	ERR	
	DNR	Off	R C N R	- - - 0	OK or ERR	ERR	
		Level 1	R C N R	- - - 1	OK or ERR	ERR	
		Level 2	R C N R	- - - 2	OK or ERR	ERR	
		Level 3	R C N R	- - - 3	OK or ERR	ERR	
	Adjustment Reset		R C R E	- - - 1	OK or ERR	ERR	
	Signal Type	D. PC RGB	I C S I	- - - 3	OK or ERR	ERR	
		D. PC Component	I C S I	- - - 4	OK or ERR	ERR	
		D. Video RGB	I C S I	- - - 5	OK or ERR	ERR	
		D. Video Component	I C S I	- - - 6	OK or ERR	ERR	
				I C S I	- - - 6	OK or ERR	ERR
	Dynamic Range	Auto	H M C D	- - - 0	OK or ERR	ERR	
		Standard	H M C D	- - - 1	OK or ERR	ERR	
		Enhanced	H M C D	- - - 2	OK or ERR	ERR	
	Color Space	Auto	H M C C	- - - 0	OK or ERR	ERR	
		ITU601	H M C C	- - - 1	OK or ERR	ERR	
		ITU709	H M C C	- - - 2	OK or ERR	ERR	
	Display (Status display)		R C R E	- - - 0	OK or ERR	ERR	
	HDMI input	Picture Mode	Standard	R D P S	- - 1 0	OK or ERR	ERR
			Presentation	R D P S	- - 1 1	OK or ERR	ERR
			Movie	R D P S	- - 1 2	OK or ERR	ERR
			Custom	R D P S	- - 1 3	OK or ERR	ERR
		Contrast	-30 +30	R D P I	- * * *	OK or ERR	ERR
		Bright	-30 +30	R D B R	- * * *	OK or ERR	ERR
		Color	-30 +30	R D C O	- * * *	OK or ERR	ERR
Tint		-30 +30	R D T I	- * * *	OK or ERR	ERR	
Red		-30 +30	R D R D	- * * *	OK or ERR	ERR	
Green		-30 +30	R D G N	- * * *	OK or ERR	ERR	
Blue		-30 +30	R D B E	- * * *	OK or ERR	ERR	
Sharp		-30 +30	R D S H	- * * *	OK or ERR	ERR	
CLR Temp *4			R D C T	- * * *	OK or ERR	ERR	
Progressive		2D Progressive	R D I P	- - - 0	OK or ERR	ERR	
		3D Progressive	R D I P	- - - 1	OK or ERR	ERR	
		Film	R D I P	- - - 2	OK or ERR	ERR	
DNR		Off	R D N R	- - - 0	OK or ERR	ERR	
		Level 1	R D N R	- - - 1	OK or ERR	ERR	
		Level 2	R D N R	- - - 2	OK or ERR	ERR	
		Level 3	R D N R	- - - 3	OK or ERR	ERR	
Adjustment Reset			R D R E	- - - 1	OK or ERR	ERR	
Signal Type		D. Video Auto	I D S I	- - - 2	OK or ERR	ERR	
		D. Video RGB	I D S I	- - - 5	OK or ERR	ERR	
		D. Video Component	I D S I	- - - 6	OK or ERR	ERR	
		D. PC RGB	I D S I	- - - 3	OK or ERR	ERR	
		D. PC Component	I D S I	- - - 4	OK or ERR	ERR	
Dynamic Range		Auto	H M D D	- - - 0	OK or ERR	ERR	
		Standard	H M D D	- - - 1	OK or ERR	ERR	
		Enhanced	H M D D	- - - 2	OK or ERR	ERR	
Color Space		Auto	H M D C	- - - 0	OK or ERR	ERR	
		ITU601	H M D C	- - - 1	OK or ERR	ERR	
		ITU709	H M D C	- - - 2	OK or ERR	ERR	
Display (Status display)			R D R E	- - - 0	OK or ERR	ERR	
VIDEO input		Picture Mode	Standard	V A P S	- - 1 0	OK or ERR	ERR
			Presentation	V A P S	- - 1 1	OK or ERR	ERR
			Movie	V A P S	- - 1 2	OK or ERR	ERR
			Custom	V A P S	- - 1 3	OK or ERR	ERR
		Contrast	-30 +30	V A P I	- * * *	OK or ERR	ERR
		Bright	-30 +30	V A B R	- * * *	OK or ERR	ERR
		Color	-30 +30	V A C O	- * * *	OK or ERR	ERR
	Tint	-30 +30	V A T I	- * * *	OK or ERR	ERR	
	Red	-30 +30	V A R D	- * * *	OK or ERR	ERR	
	Green	-30 +30	V A G N	- * * *	OK or ERR	ERR	
	Blue	-30 +30	V A B E	- * * *	OK or ERR	ERR	
	Sharp	-30 +30	V A S H	- * * *	OK or ERR	ERR	
	CLR Temp *4		V A C T	- * * *	OK or ERR	ERR	
	Progressive	2D Progressive	V A I P	- - - 0	OK or ERR	ERR	
		3D Progressive	V A I P	- - - 1	OK or ERR	ERR	
		Film	V A I P	- - - 2	OK or ERR	ERR	
	DNR	Off	V A N R	- - - 0	OK or ERR	ERR	
		Level 1	V A N R	- - - 1	OK or ERR	ERR	
		Level 2	V A N R	- - - 2	OK or ERR	ERR	
		Level 3	V A N R	- - - 3	OK or ERR	ERR	
	Adjustment Reset		V A R E	- - - 1	OK or ERR	ERR	
	Display (Status display)		V A R E	- - - 0	OK or ERR	ERR	

RS-232C Specifications and Commands

CONTROL CONTENTS			COMMAND	PARAMETER	RETURN	
					Power ON	Standby mode (or 40-second startup time)
S-VIDEO input	Picture Mode	Standard	V B P S	--10	OK or ERR	ERR
		Presentation	V B P S	--11	OK or ERR	ERR
		Movie	V B P S	--12	OK or ERR	ERR
		Custom	V B P S	--13	OK or ERR	ERR
	Contrast	-30 ~ +30	V B P I	--**	OK or ERR	ERR
	Bright	-30 ~ +30	V B B R	--**	OK or ERR	ERR
	Color	-30 ~ +30	V B C O	--**	OK or ERR	ERR
	Tint	-30 ~ +30	V B T I	--**	OK or ERR	ERR
	Red	-30 ~ +30	V B R D	--**	OK or ERR	ERR
	Green	-30 ~ +30	V B G N	--**	OK or ERR	ERR
	Blue	-30 ~ +30	V B B E	--**	OK or ERR	ERR
	Sharp	-30 ~ +30	V B S H	--**	OK or ERR	ERR
	CLR Temp *4		V B C T	--**	OK or ERR	ERR
	Progressive	2D Progressive	V B I P	--0	OK or ERR	ERR
		3D Progressive	V B I P	--1	OK or ERR	ERR
		Film	V B I P	--2	OK or ERR	ERR
	DNR	Off	V B N R	--0	OK or ERR	ERR
		Level 1	V B N R	--1	OK or ERR	ERR
		Level 2	V B N R	--2	OK or ERR	ERR
		Level 3	V B N R	--3	OK or ERR	ERR
	Adjustment Reset		V B R E	--1	OK or ERR	ERR
	Display (Status display)		V B R E	--0	OK or ERR	ERR
	C.M.S. Adjustment	COMPUTER1	Standard	C S R A	--00	OK or ERR
sRGB			C S R A	--01	OK or ERR	ERR
Custom1			C S R A	--11	OK or ERR	ERR
Custom2			C S R A	--12	OK or ERR	ERR
Custom3			C S R A	--13	OK or ERR	ERR
COMPUTER2			Standard	C S R B	--00	OK or ERR
sRGB		C S R B	--01	OK or ERR	ERR	
Custom1		C S R B	--11	OK or ERR	ERR	
Custom2		C S R B	--12	OK or ERR	ERR	
Custom3		C S R B	--13	OK or ERR	ERR	
DVI		Standard	C S R C	--00	OK or ERR	ERR
		sRGB	C S R C	--01	OK or ERR	ERR
		Custom1	C S R C	--11	OK or ERR	ERR
		Custom2	C S R C	--12	OK or ERR	ERR
Custom3		C S R C	--13	OK or ERR	ERR	
HDMI		Standard	C S R D	--00	OK or ERR	ERR
		sRGB	C S R D	--01	OK or ERR	ERR
		Custom1	C S R D	--11	OK or ERR	ERR
		Custom2	C S R D	--12	OK or ERR	ERR
Custom3		C S R D	--13	OK or ERR	ERR	
VIDEO		Standard	C S V A	--00	OK or ERR	ERR
		Custom1	C S V A	--11	OK or ERR	ERR
		Custom2	C S V A	--12	OK or ERR	ERR
		Custom3	C S V A	--13	OK or ERR	ERR
S-VIDEO		Standard	C S V B	--00	OK or ERR	ERR
		Custom1	C S V B	--11	OK or ERR	ERR
		Custom2	C S V B	--12	OK or ERR	ERR
		Custom3	C S V B	--13	OK or ERR	ERR
Target		Red	C M T G	--1	OK or ERR	ERR
		Yellow	C M T G	--2	OK or ERR	ERR
		Green	C M T G	--3	OK or ERR	ERR
		Cyan	C M T G	--4	OK or ERR	ERR
		Blue	C M T G	--5	OK or ERR	ERR
		Magenta	C M T G	--6	OK or ERR	ERR
		Lightness	-30 ~ +30	C M S L	--**	OK or ERR
Chroma		-30 ~ +30	C M S C	--**	OK or ERR	ERR
Hue		-30 ~ +30	C M S H	--**	OK or ERR	ERR
Reset (This Color)			C M R E	--1	OK or ERR	ERR
Reset (All Colors)			C M R E	--2	OK or ERR	ERR
Clock		-150 ~ +150	I N C L	--**	OK or ERR	ERR
Phase		-30 ~ +30	I N P H	--**	OK or ERR	ERR
H-position		-150 ~ +150	I A H P	--**	OK or ERR	ERR
V-position		-60 ~ +60	I A V P	--**	OK or ERR	ERR
Fine Sync Adjustment Reset			I A R E	--1	OK or ERR	ERR
Save Setting		1 ~ 7	M E M S	--*	OK or ERR	ERR
Select Setting		1 ~ 7	M E M L	--*	OK or ERR	ERR
RGB Frequency Check		Horizontal	T F R Q	--1	kHz (***, * or ERR)	ERR
		Vertical	T F R Q	--2	Hz (***, * or ERR)	ERR
Auto Sync		Off	A A D J	--0	OK or ERR	ERR
		Normal	A A D J	--1	OK or ERR	ERR
	High Speed	A A D J	--2	OK or ERR	ERR	
Auto Sync Display	Background	I M A S	--1	OK or ERR	ERR	
	Adjusting Disp.	I M A S	--0	OK or ERR	ERR	
Fine Sync Display (Status display)		I A R E	--0	OK or ERR	ERR	
Balance	-30 ~ +30	A A B L	--**	OK or ERR	ERR	
Treble	-30 ~ +30	A A T E	--**	OK or ERR	ERR	
Bass	-30 ~ +30	A A B A	--**	OK or ERR	ERR	
Audio Adjustment Reset		A A R E	--1	OK or ERR	ERR	
Audio Out	FAO	A O U T	--1	OK or ERR	ERR	
	VAO	A O U T	--2	OK or ERR	ERR	
Speaker	On	A S P K	--1	OK or ERR	ERR	
	Off	A S P K	--0	OK or ERR	ERR	
Audio Display (Status display)		A A R E	--0	OK or ERR	ERR	
Pict in Pict	Bottom Right	P I N P	--11	OK or ERR	ERR	
	Bottom Left	P I N P	--12	OK or ERR	ERR	
	Upper Right	P I N P	--13	OK or ERR	ERR	
	Upper Left	P I N P	--14	OK or ERR	ERR	
	Off	P I N P	--0	OK or ERR	ERR	

RS-232C Specifications and Commands

CONTROL CONTENTS		COMMAND	PARAMETER	RETURN	
				Power ON	Standby mode (or 40-second startup time)
Digital Shift	-40 ~ +40	L N D S	* * *	OK or ERR	ERR
OSD Display	Normal	I M D I	1	OK or ERR	ERR
	Level A	I M D I	2	OK or ERR	ERR
	Level B	I M D I	0	OK or ERR	ERR
Video System Selection	Auto	M E S Y	1	OK or ERR	ERR
	PAL	M E S Y	2	OK or ERR	ERR
	SECAM	M E S Y	3	OK or ERR	ERR
	NTSC 4.43	M E S Y	4	OK or ERR	ERR
	NTSC 3.58	M E S Y	5	OK or ERR	ERR
	PAL - M	M E S Y	6	OK or ERR	ERR
	PAL - N	M E S Y	7	OK or ERR	ERR
Background Selection	Logo	I M B G	1	OK or ERR	ERR
	Custom	I M B G	2	OK or ERR	ERR
	Blue	I M B G	3	OK or ERR	ERR
	None	I M B G	4	OK or ERR	ERR
Startup Image Selection	Logo	I M S I	1	OK or ERR	ERR
	Custom	I M S I	2	OK or ERR	ERR
	None	I M S I	3	OK or ERR	ERR
Eco Mode	On	T H M D	1	OK or ERR	ERR
	Off	T H M D	0	OK or ERR	ERR
Auto Search	On	I N S E	1	OK or ERR	ERR
	Off	I N S E	0	OK or ERR	ERR
Auto Power Off	On	A P O W	1	OK or ERR	ERR
	Off	A P O W	0	OK or ERR	ERR
Lamp Mode	Both Lamps	L P M D	0	OK or ERR	ERR
	Lamp 1 Only	L P M D	1	OK or ERR	ERR
	Lamp 2 Only	L P M D	2	OK or ERR	ERR
	Equal Use	L P M D	3	OK or ERR	ERR
Lens Type	Type 1 (AN-P8EX)	L N T Y	1	OK or ERR	ERR
	Type 2 (AN-P12EX)	L N T Y	2	OK or ERR	ERR
	Type 3 (AN-P15EZ)	L N T Y	3	OK or ERR	ERR
	Type 4 (AN-P18EZ)	L N T Y	4	OK or ERR	ERR
	Type 5 (AN-P23EZ)	L N T Y	5	OK or ERR	ERR
	Type 6 (AN-P30EZ)	L N T Y	6	OK or ERR	ERR
	Type 7 (AN-P45EZ)	L N T Y	7	OK or ERR	ERR
PRJ Mode	Reverse	On	I M R E	1	OK or ERR
		Off	I M R E	0	OK or ERR
	Invert	On	I M I N	1	OK or ERR
		Off	I M I N	0	OK or ERR
Stack Setting	Normal	S T A K	0	OK or ERR	ERR
	Master	S T A K	1	OK or ERR	ERR
	Slave	S T A K	2	OK or ERR	ERR
Keylock Level	Normal	K E Y L	0	OK or ERR	ERR
	Level A	K E Y L	1	OK or ERR	ERR
	Level B	K E Y L	2	OK or ERR	ERR
Set Inputs	COMPUTER1	ON	R A S I	1	OK or ERR
		OFF	R A S I	0	OK or ERR
	COMPUTER2	ON	R B S I	1	OK or ERR
		OFF	R B S I	0	OK or ERR
	DVI	ON	R C S I	1	OK or ERR
		OFF	R C S I	0	OK or ERR
	HDMI	ON	R D S I	1	OK or ERR
		OFF	R D S I	0	OK or ERR
	VIDEO	ON	V A S I	1	OK or ERR
		OFF	V A S I	0	OK or ERR
	S-VIDEO	ON	V B S I	1	OK or ERR
		OFF	V B S I	0	OK or ERR
Fan Mode	Normal	H L M D	0	OK or ERR	ERR
	High	H L M D	1	OK or ERR	ERR
Auto Restart	On	A R E S	1	OK or ERR	ERR
	Off	A R E S	0	OK or ERR	ERR
Monitor Out	Enable	M O U T	1	OK or ERR	ERR
	Disable	M O U T	0	OK or ERR	ERR
LAN/RS232C	Enable	L N R S	1	OK or ERR	ERR
	Disable	L N R S	0	OK or ERR	*5
Language	ENGLISH	M E L A	1	OK or ERR	ERR
	DEUTSCH	M E L A	2	OK or ERR	ERR
	ESPAÑOL	M E L A	3	OK or ERR	ERR
	NEDERLANDS	M E L A	4	OK or ERR	ERR
	FRANÇAIS	M E L A	5	OK or ERR	ERR
	ITALIANO	M E L A	6	OK or ERR	ERR
	SVENSKA	M E L A	7	OK or ERR	ERR
	日本語	M E L A	8	OK or ERR	ERR
	PORTUGUES	M E L A	9	OK or ERR	ERR
	汉语	M E L A	10	OK or ERR	ERR
	한국어	M E L A	11	OK or ERR	ERR
	Русский	M E L A	12	OK or ERR	ERR
	عربي	M E L A	13	OK or ERR	ERR
	polski	M E L A	14	OK or ERR	ERR
	Türkçe	M E L A	15	OK or ERR	ERR
	فارسی	M E L A	16	OK or ERR	ERR
All Reset *6		A L R E	1	OK or ERR	ERR

*1 Lamp Timer Reset command is available only in standby mode.

*2 Serial No. Check command is used to read out the 12 digits of serial No..

*3 For setting the projector name, send the commands in order of PJN1, PJN2 and PJN3.

*4 Parameters of CLR Temp settings are as follows.

CLR Temp	Parameter	CLR Temp	Parameter	CLR Temp	Parameter
4500K	0 4 5	7500K	0 7 5	10500K	1 0 5
5500K	0 5 5	8500K	0 8 5		
6500K	0 6 5	9300K	0 9 3		

*5 Because the RS-232C function stops, the projector send no response code.

*6 See page 65 of the projector's operation manual for the initialized items by using "All Reset".

Setting up the Projector Network Environment

This section describes the basic procedure for using the projector via the network.

If the network is already constructed, the projector's network settings may need to be changed. Please consult your network administrator for assistance with these settings. You can make network settings both on the projector and on the computer. The following procedure is for making settings on the computer.

Network settings on the computer

1. Connecting the projector to a computer

Connect a commercially available LAN cable (UTP cable, Category 5, cross-over type) between the computer and projector.

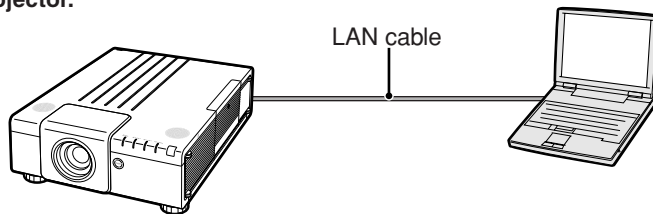

➔ Page 21

2. Setting an IP address for the computer

Adjust the IP settings of the computer to enable one-to-one communications with the projector.

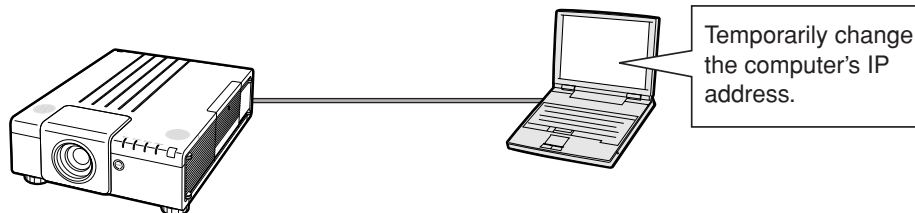

➔ Pages 22, 23

3. Setting up a network connection for the projector

Adjust the projector network settings to conform to your network.

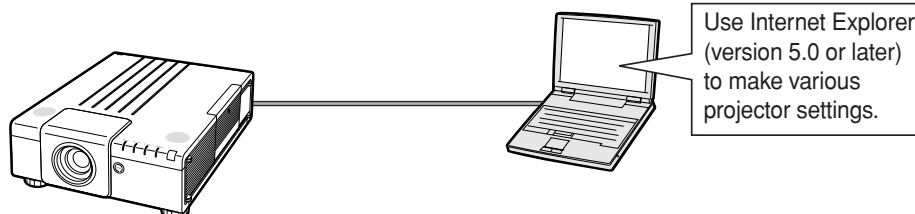

➔ Pages 24, 25

- Microsoft®, Windows® and Windows Vista® are registered trademarks of Microsoft Corporation in the United States and/or other countries.
- PJLink is a registered trademark or an application trademark in Japan, the United States and/or other countries/regions.
- All other company or product names are trademarks or registered trademarks of their respective companies.

1. Connecting the Projector to a Computer

Establishing a one-to-one connection from the projector to a computer. Using a commercially available LAN cable (UTP cable, Category 5, cross-over type) you can configure the projector via the computer.

- 1 Disconnect the computer's LAN cable from the existing network.

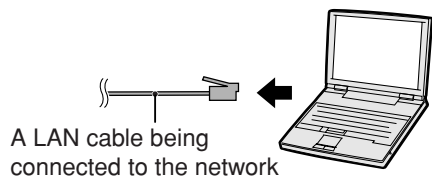

- 2 Connect a commercially available LAN cable (UTP cable, Category 5, cross-over type) to the projector's LAN terminal and connect the other end of the cable to the computer's LAN terminal.

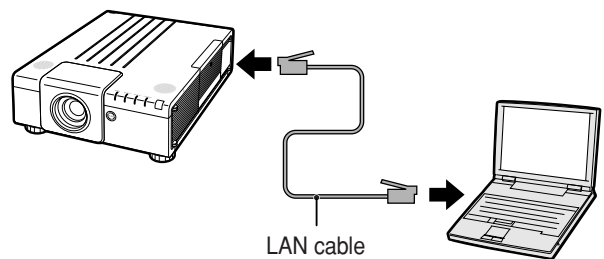

- 3 Plug the power cord into the AC socket of the projector.

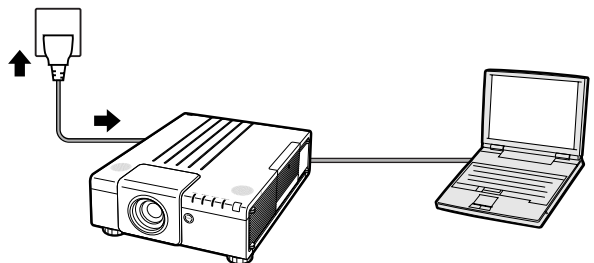

- 4 Turn on the computer.

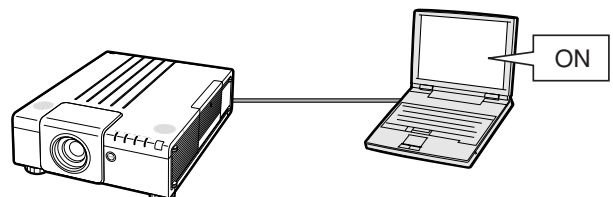

Info

Confirm that the LINK LED on the rear of the projector illuminates. If the LINK LED does not illuminate, check the following :

- The LAN cable is properly connected.
- The power switches of both the projector and the computer are on.

This completes the connection. Now proceed to “2. Setting an IP Address for the Computer”.

Setting up the Projector Network Environment

2. Setting an IP Address for the Computer

The following describes how to make settings in Windows Vista®.

1 Log on the network using the administrator's account for the computer.

2 Click "start", and click "Control Panel".

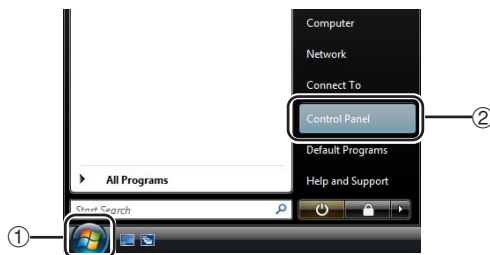

3 Click "View network status and tasks" of "Network and Internet", and click "View status" in the new window.

- This manual uses examples to explain the operations in Category View. If you are using Classic View, double-click "Network and Sharing Center".

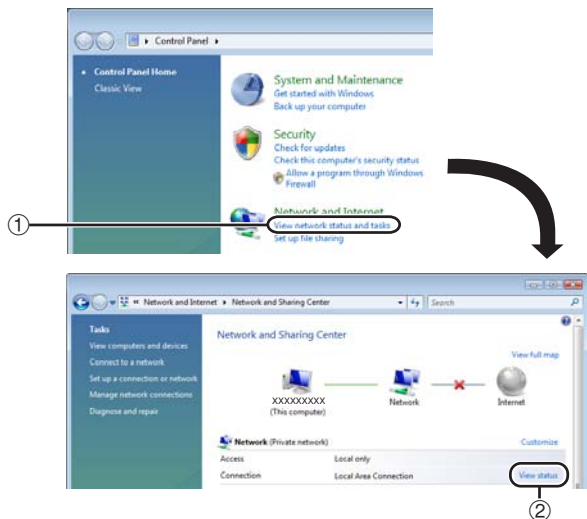

4 Click "Properties".

- When the user account control display is displayed, Click "Continue".

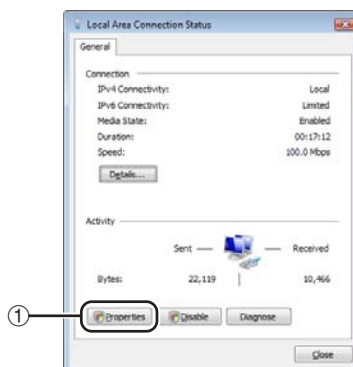

- 5** Click “Internet Protocol Version 4 (TCP/IPv4)”, and click the “Properties” button.

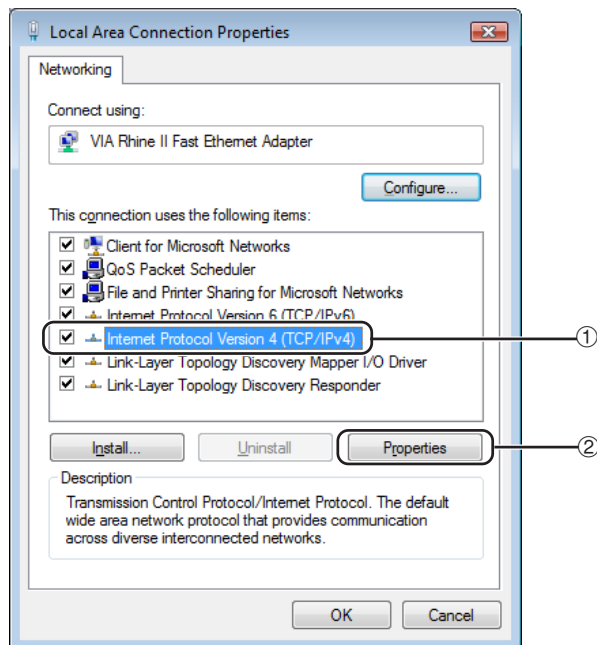

- 6** Confirm or change an IP address for the setup computer.

- ① Confirm and note the current IP address, Subnet mask and Default gateway.

Make sure to note the current IP address, Subnet mask and Default gateway as you will be required to reset them later.

- ② Set temporarily as follows :

IP address : 192.168.150.3

Subnet mask : 255.255.255.0

Default gateway : (Do not input any values.)

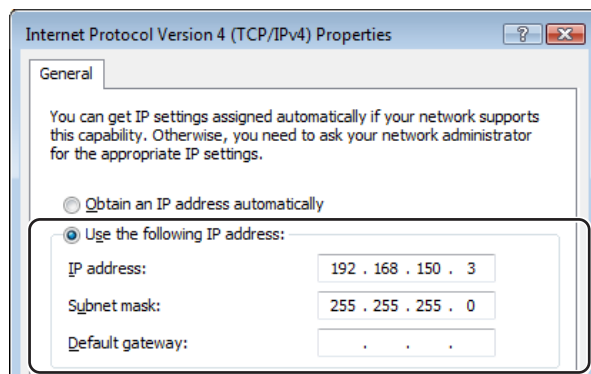

Note

- The factory default settings for the projector are as follows:
DHCP Client : OFF
IP address : 192.168.150.2
Subnet mask : 255.255.255.0
Default gateway : 0.0.0.0

- 7** After setting, click the “OK” button, and then restart the computer.

After confirming or setting, proceed to “3. Setting up Network Connection for the Projector”.

Setting up the Projector Network Environment

3. Setting up a Network Connection for the Projector

Settings for such items as the projector's IP address and subnet mask are compatible with the existing network.

Set each item on the projector as follows. (See page 64 of the projector's operation manual for setting.)

DHCP Client : OFF

IP Address : 192.168.150.002

Subnet Mask : 255.255.255.000

1 Start Internet Explorer (version 5.0 or later) on the computer, and enter "http://192.168.150.2/" in "Address", and then press the "Enter" key.

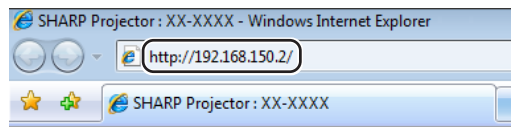

2 If a user name and a password have not yet been set, just click the "OK" button.

- If a user name and a password have been set, input the user name and the password, and click the "OK" button.
- If the user name or password is entered incorrectly three times, an error message will be displayed.
- When you are using Internet Explorer 7, other setup screen may be displayed. In this case, make the proper adjustments for the setup screen.

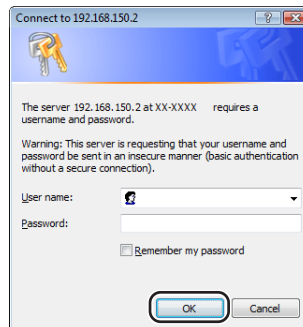

3 When the screen as shown on the right appears, click "TCP/IP".

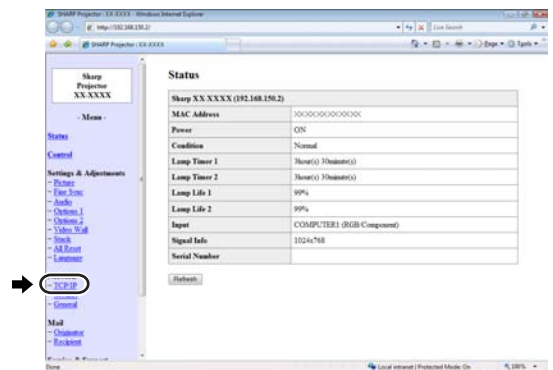

4 The TCP/IP setting screen appears, ready for network settings for the projector.

Items	Setting example / Remarks
DHCP Client	Select "ON" or "OFF" to determine whether to use DHCP Client.
IP Address	You can set this item when "DHCP Client" is set to "OFF". Factory default setting: 192.168.150.2 Enter an IP address appropriate for the network.
Subnet Mask	You can set this item when "DHCP Client" is set to "OFF". Factory default setting: 255.255.255.0 Set the subnet mask to the same as that of the computer and equipment on the network.
Default Gateway	You can set this item when "DHCP Client" is set to "OFF". Factory default setting: 0.0.0.0 * When not in use, set to "0.0.0.0".
DNS Server	Factory default setting: 0.0.0.0 * When not in use, set to "0.0.0.0".

Note

- Confirm the existing network's segment (IP address group) to avoid setting an IP address that duplicates the IP addresses of other network equipment or computers. If "192.168.150.2" is not used in the network having an IP address of "192.168.150.XXX", you don't have to change the projector IP address.
- For details about each setting, consult your network administrator.

5 Click the "Apply" button.

6 The set values appear. Confirm that the values are set properly, and then click the "Confirm" button.

- Close the browser.
- This completes the network settings.
- After setting items, wait for 10 seconds and then re-access.
- Change the IP address of the setting computer back to its original address, which you have noted down in Step 6-① on page 23, and then connect the computer and the projector to the network.

Network - TCP/IP

DHCP Client	<input checked="" type="radio"/> OFF <input type="radio"/> ON
IP Address	192 . 168 . 150 . 2
Subnet Mask	255 . 255 . 255 . 0
Default Gateway	0 . 0 . 0 . 0 * "0.0.0.0" means "Using no default gateway."
DNS Server	0 . 0 . 0 . 0 * "0.0.0.0" means "Using no DNS server."

Network - TCP/IP

DHCP Client	<input checked="" type="radio"/> OFF <input type="radio"/> ON
IP Address	192 . 168 . 150 . 2
Subnet Mask	255 . 255 . 255 . 0
Default Gateway	0 . 0 . 0 . 0 * "0.0.0.0" means "Using no default gateway."
DNS Server	0 . 0 . 0 . 0 * "0.0.0.0" means "Using no DNS server."



Apply
Refresh

Network - TCP/IP

The TCP/IP settings will be changed as below.

DHCP Client : OFF
IP Address : 192.168.150.2
Subnet Mask : 255.255.255.0
Default Gateway : 0.0.0.0
DNS Server : 0.0.0.0

Do you want to change the TCP/IP settings?



Confirm Cancel

After you click "Confirm", if you want to continue to operate this projector via the network, please wait for 10 seconds and then re-access to "192.168.150.2".

Controlling the Projector via LAN

After connecting the projector to your network, enter the projector IP address in “Address” on Internet Explorer (version 5.0 or later) using a computer on the network to start a setup screen that will enable control of the projector via the network.

Controlling the Projector Using Internet Explorer (Version 5.0 or later)

Complete connections to external equipment before starting the operation. (See pages 24-27 of the projector’s operation manual.)
Complete the AC cord connection. (See page 28 of the projector’s operation manual.)

Note

- When connecting the projector to the LAN, use a commercially available LAN cable (UTP cable, Category 5, cross-over type). When connecting the projector to a hub, use a straight-through cable.

1 Start Internet Explorer (version 5.0 or later) on the computer.

2 Enter “http://” followed by the projector IP address set by the procedure on page 25 followed by “/” in “Address”, and then press the “Enter” key.

- The factory default setting for the projector : “DHCP Client” is “OFF” and IP address is “192.168.150.2”. If you did not change the IP address in “3. Setting up a Network Connection for the Projector” (pages 24, 25), enter “http://192.168.150.2/”.

3 A screen for controlling the projector appears, ready for performing various status conditions, control, and settings.

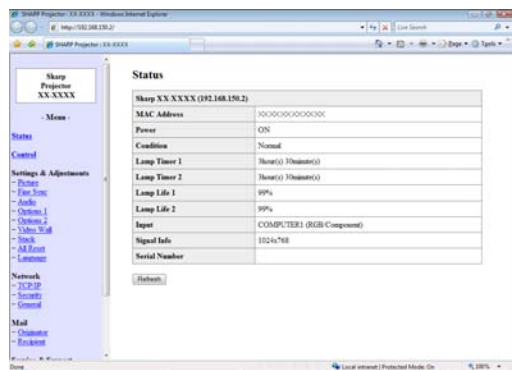
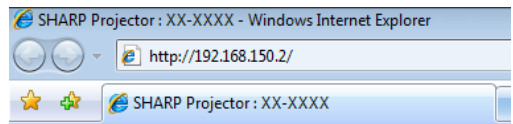

Confirming the Projector Status (Status)

Status

Sharp XX.XXXX (192.168.150.2)	
MAC Address	XXXXXXXXXXXX
Power	ON
Condition	Normal
Lamp Timer 1	3hour(s) 30minute(s)
Lamp Timer 2	3hour(s) 30minute(s)
Lamp Life 1	99%
Lamp Life 2	99%
Input	COMPUTER1 (RGB/Component)
Signal Info	1024x768
Serial Number	

Refresh

On this screen, you can confirm the projector status. You can confirm the following items :

- MAC Address
- Power
- Condition
- Lamp Timer 1
- Lamp Timer 2
- Lamp Life 1
- Lamp Life 2
- Input
- Signal Info
- Serial Number

Note

- If you click the “Refresh” button before the screen is displayed completely, an error message (“Server Busy Error”) will be displayed. Wait for a moment and then operate again.
- For details about each item, refer to the projector’s operation manual.

Controlling the Projector (Control)

Control

POWER	<input type="radio"/> STANDBY <input checked="" type="radio"/> ON
INPUT Select	COMPUTER1 (RGB/Component) ▾
VOLUME	1 ▾
MUTE	<input checked="" type="radio"/> OFF <input type="radio"/> On
SHUTTER	<input checked="" type="radio"/> OPEN <input type="radio"/> CLOSE

Refresh

On this screen, you can perform projector control. You can control the following items :

- Power
- Input Select
- Volume
- Mute (Audio)
- Shutter

Note

- If you click the “Refresh” button before the screen is displayed completely, an error message (“Server Busy Error”) will be displayed. Wait for a moment and then operate again.
- You cannot operate this page while the projector is warming up.
- While the projector is in standby mode, you can only control “Power ON”.
- For details about each item, refer to the projector’s operation manual.

Setting and Adjusting the Projector (Settings & Adjustments)

Example: "Picture" screen display for COMPUTER1
Settings & Adjustments - Picture (COMPUTER1)

Picture Mode	Standard ▾	<input type="button" value="Reset"/>
CLR Temp	7500K ▾	
Progressive	3D Progressive ▾	
C.M.S. Adjustment	Standard ▾	
DNR	Off ▾	
Signal Type	Auto ▾	

On these screens, you can make projector settings or adjustments. You can set or adjust the following items :

- Picture Mode
- CLR Temp
- Progressive
- C.M.S. Adjustment
- DNR
- Signal Type
- Dynamic Range
- Color Space
- Auto Sync
- Auto Sync Disp
- Audio Out
- Internal Speaker
- Resize
- OSD Display
- Video System (VIDEO/S-VIDEO)
- Background
- Startup Image
- Eco Mode
- Auto Search
- Auto Power Off
- Password
- Lamp Mode
- Lens Type
- Projection Mode
- Keylock Level
- Set Inputs
- Fan Mode
- Auto Restart
- RS-232C Speed
- Monitor Out (Standby)
- Video Wall (See page 44.)
- Stack Setting (See page 41.)
- All Reset
- OSD Language

Note

- If you click the "Refresh" button before the screen is displayed completely, an error message ("Server Busy Error") will be displayed. Wait for a moment and then operate again.
- You cannot operate this page while the projector is warming up.
- While the projector is in standby mode, you can only control "Power ON".
- For details about each item, refer to the projector's operation manual.
- For details about the items that will be initialized in "All Reset", refer to the projector's operation manual. (The network setting items will not be initialized.)

Setting the Security (Network - Security)

Network - Security

User Name	<input type="text"/> (MAX 8 characters)
Password	<input type="text"/> (MAX 8 characters)

This user name / password is for accessing via Web browser and Telnet.

*You will need to re-login with the new user name / new password after you change the user name / password.

Accept IP Address	<input checked="" type="radio"/> All IP Addresses <input type="radio"/> From only specific IP addresses Address 1 <input type="text"/> 0 <input type="text"/> 0 <input type="text"/> 0 <input type="text"/> 0 Address 2 <input type="text"/> 0 <input type="text"/> 0 <input type="text"/> 0 <input type="text"/> 0 Address 3 <input type="text"/> 0 <input type="text"/> 0 <input type="text"/> 0 <input type="text"/> 0
-------------------	---

On this screen, you can make settings relating to security.

Items	Description
User Name	Setting of user name for security protection.
Password	Setting of password for security protection.
Accept IP Address	It is possible to set up to three IP addresses allowing connection to the projector.
All IP Addresses	No limits are set to IP addresses connecting to the projector.
From only specific IP addresses	For security improvement, only an IP address set by "Address 1-3" can be connected to the projector.

After clicking the "Apply" button, the set values appear. Confirm that the values are set properly, and then click the "Confirm" button.

Note

- After setting items, wait for 10 seconds and then re-access.
- User Name and Password can be up to 8 characters.
- You can input the characters below : a-z, A-Z, 0-9, -, _
- To cancel User Name and Password, enter nothing and then press "Apply" button.

Making General Settings for the Network (Network - General)

Network - General

Projector Name	<input type="text" value="XX-XXXX"/> (MAX 12 characters)
Auto Logout Time	<input type="text" value="5"/> minute(s) (0-65535) * If the set value is made 0, the Auto Logout function is disabled.
Data Port	<input type="text" value="10002"/> (1025-65535)
Search Port	<input type="text" value="5006"/> (1025-65535)

On this screen, you can make general settings relating to the network.

Items	Description
Projector Name	Setting the projector name.
Auto Logout Time	Setting the time interval in which the projector will be automatically disconnected from the network in units of a minute (from 1 to 65535 minutes). If the set value is made 0, the Auto Logout function is disabled.
Data Port	Setting the TCP port number used when exchanging data with the projector (from 1025 to 65535).
Search Port	Setting the port number used when searching for the projector (from 1025 to 65535).

After clicking the “Apply” button, the set values appear. Confirm that the values are set properly, and then click the “Confirm” button.

Note

- After setting items, wait for 10 seconds and then re-access.
- Projector Name can be up to 12 characters.
- You can input the characters below : A-Z, 0-9, -, _, (,), space (When “a-z” are input, they are converted to “A-Z” automatically.)

Setting for Sending E-mail when an Error Occurs (Mail - Originator Settings)

Mail - Originator Settings

SMTP Server	<input type="text"/> (MAX 64 characters)
Originator E-mail Address	<input type="text"/> (MAX 64 characters)
Originator Name	<input type="text"/> (MAX 64 characters)

On this screen, you can make settings for sending e-mail to report when the projector has generated an error.

Items	Setting example / Remarks
SMTP Server	Setting an SMTP server address for e-mail transmission. e.g.1 : 192.168.150.253 e.g.2 : smtp123.sharp.co.jp * When using a domain name, make settings for the DNS server.
Originator E-mail Address	Setting the projector's e-mail address. The e-mail address set here becomes Originator E-mail Address.
Originator Name	Setting the sender's name. The name set here appears in the “Originator Name” column of the body of the message.

Note

- SMTP Server, Originator E-mail Address and Originator Name can be up to 64 characters.
- You can input the characters below : SMTP Server and Originator E-mail Address : a-z, A-Z, 0-9, !, #, \$, %, &, *, +, -, /, =, ?, ^, {, |, }, ~, _, ' , , @, ` (You can input “@” only one time for “Originator E-mail Address”.)
Originator Name : a-z, A-Z, 0-9, -, _, (,), space
- If the settings of “3. Setting up a Network Connection for the Projector” on pages 24 and 25 are incorrectly set, e-mail will not be sent.

Setting Error Items and Destination Addresses to which E-mail is to be Sent when an Error Occurs (Mail – Recipient Settings)

Mail – Recipient Settings

Recipient Addresses	E-mail Address (MAX 64 characters)	Error Mail				Test
		Lamp	Temp	Fan	Cover	
1	<input type="text"/>	<input type="checkbox"/>	<input type="checkbox"/>	<input type="checkbox"/>	<input type="checkbox"/>	Test
2	<input type="text"/>	<input type="checkbox"/>	<input type="checkbox"/>	<input type="checkbox"/>	<input type="checkbox"/>	Test
3	<input type="text"/>	<input type="checkbox"/>	<input type="checkbox"/>	<input type="checkbox"/>	<input type="checkbox"/>	Test
4	<input type="text"/>	<input type="checkbox"/>	<input type="checkbox"/>	<input type="checkbox"/>	<input type="checkbox"/>	Test
5	<input type="text"/>	<input type="checkbox"/>	<input type="checkbox"/>	<input type="checkbox"/>	<input type="checkbox"/>	Test

On this screen, you can input e-mail destinations to which error notification (error items) e-mails are sent.

Items	Description
E-mail Address	Set addresses to which error notification e-mail is sent. You can set up to five addresses.
Error Mail (Lamp, Temp, Fan, Cover)	Error e-mail is sent on the error items checked in their check boxes.
Test	Send test e-mail. This allows you to confirm that the settings for e-mail transmission are properly set.

Note

- E-mail Address can be up to 64 characters.
- You can input the characters below :
a-z, A-Z, 0-9, !, #, \$, %, &, *, +, -, /, =, ?, ^, {, |, }, ~, ~~, '., @, `
- (You can input “@” only one time.)
- For details about error items, refer to the projector’s operation manual.

Setting Error Items and the URL that are to be Displayed when an Error Occurs (Service & Support – Access URL)

Service & Support – Access URL Registration

Access URL (MAX 64 characters)	Condition				Test
	Always	Lamp	Temp	Fan Cover	
1 <input type="text"/>	<input type="checkbox"/>	<input type="checkbox"/>	<input type="checkbox"/>	<input type="checkbox"/>	Test
2 <input type="text"/>	<input type="checkbox"/>	<input type="checkbox"/>	<input type="checkbox"/>	<input type="checkbox"/>	Test
3 <input type="text"/>	<input type="checkbox"/>	<input type="checkbox"/>	<input type="checkbox"/>	<input type="checkbox"/>	Test
4 <input type="text"/>	<input type="checkbox"/>	<input type="checkbox"/>	<input type="checkbox"/>	<input type="checkbox"/>	Test
5 <input type="text"/>	<input type="checkbox"/>	<input type="checkbox"/>	<input type="checkbox"/>	<input type="checkbox"/>	Test

On this screen, you can make settings of the URL and error items that are to be displayed when the projector has generated an error.

Items	Description
Access URL	Set the URL that is to be displayed when an error occurs. You can set up to five addresses.
Condition (Always, Lamp, Temp, Fan, Cover)	The URL is displayed when an error checked in their check boxes occurs.
Test	The set URL site is test-displayed. This allows you to confirm that the URL site is properly displayed.

Example of the display when an error occurs

Status

Sharp XX-XXXX (192.168.150.2)	
MAC Address	XXXXXXXXXXXXXX
Power	STANDBY
The cooling fan is not operating.	
Condition	Access URL
	1 http://www.sharp-world.com/projector/
Lamp Timer 1	3hour(s) 30minute(s)
Lamp Timer 2	3hour(s) 30minute(s)
Lamp Life 1	99%
Lamp Life 2	99%
Input	----
Signal Info	----
Serial Number	-----

Setting the Projector Using RS-232C or Telnet

Connect the projector to a computer using RS-232C or Telnet, and open the SETUP MENU on the computer to carry out various settings for the projector.

When Connecting Using RS-232C

1 Launch general purpose terminal emulator.

2 Input settings for the RS-232C port of the terminal emulator as follows.

Baud Rate : 9600 bps*
Data Length : 8 bit
Parity Bit : None
Stop Bit : 1 bit
Flow Control : None

* This is the factory default setting. If the value of Baud Rate for the projector has been changed, set Baud Rate here according to the changed value on the projector.

3 Input "PJS11234" and press the "Enter" key.

4 "OK" is displayed. Input "PJS25678" and press the "Enter" key within 10 seconds.

5 "OK" is displayed. Press the "Enter" key.

6 "User Name:" is displayed. Input the user name and press the "Enter" key.

• If a user name has not yet been set, just press the "Enter" key.

7 "Password:" is displayed. Input the password and press the "Enter" key.

• If a password has not yet been set, just press the "Enter" key.

8 Input "setup" and press the "Enter" key.

• SETUP MENU will be displayed.

▼SETUP MENU

```
-----SETUP MENU-----  
[1]IP Address      [2]Subnet Mask    [3]Default Gateway  
[4]User Name      [5]Password  
[6]RS-232C Baud Rate [7]Projector Name [8]DHCP Client  
[A]Advanced Setup  [D]Disconnect All  
[V]View All Setting [S]Save & Quit    [Q]Quit Unchanged  
  
setup>
```

Note

- User name and password are not set in the factory default settings.
- If the user name or password is entered incorrectly three times, SETUP MENU will be quit.

Setting the Projector Using RS-232C or Telnet

When Connecting Using Telnet

1 Click “start” from the Windows® desktop and select “Run”.

2 Enter “telnet 192.168.150.2” in the text box that opens up. (If the IP address of the projector is 192.168.150.2.)

3 Click the “OK” button.

4 “User Name:” is displayed. Input the user name and press the “Enter” key.

- If a user name has not yet been set, just press the “Enter” key.

5 “Password:” is displayed. Input the password and press the “Enter” key.

- If a password has not yet been set, just press the “Enter” key.

6 Input “setup” and press the “Enter” key.

- SETUP MENU will be displayed.

▼SETUP MENU

```
-----SETUP MENU-----
[1]IP Address      [2]Subnet Mask    [3]Default Gateway
[4]User Name      [5]Password
[6]RS-232C Baud Rate [7]Projector Name [8]DHCP Client
[A]Advanced Setup [D]Disconnect All
[V]View All Setting [S]Save & Quit    [Q]Quit Unchanged

setup>
```

Note

- If the IP address has been changed, be sure to enter the new IP address in step 2.
- User name and password are not set in the factory default settings.
- If the user name or password is entered incorrectly three times in steps 4 or 5, SETUP MENU will be quit.
- If you are using Windows Vista®, activate Telnet Client. For details, see the operation manual of your computer.

SETUP MENU (Main Menu)

▼ SETUP MENU

```

-----SETUP MENU-----
[1]IP Address      [2]Subnet Mask    [3]Default Gateway
[4]User Name      [5]Password       [6]RS-232C Baud Rate
[7]Projector Name [8]DHCP Client
[A]Advanced Setup [D]Disconnect All
[V]View All Setting [S]Save & Quit    [Q]Quit Unchanged

setup>
    
```

- [1] IP Address (Factory default setting : 192.168.150.2)**
IP address settings. (Page 36)
- [2] Subnet Mask (Factory default setting : 255.255.255.0)**
Subnet mask settings. (Page 36)
- [3] Default Gateway (Factory default setting : Not Used)**
Default gateway settings. (Page 36)
- [4] User Name (Factory default setting : Not Required)**
Setting of user name for security protection. (Page 36)
- [5] Password (Factory default setting : Not Required)**
Setting of password for security protection. (Page 37)
- [6] RS-232C Baud Rate (Factory default setting : 9600 bps)**
Baud rate settings for the RS-232C terminals. (Page 37)
- [7] Projector Name**
It is possible to assign a projector name. (Page 37)
- [8] DHCP Client**
DHCP Client settings. (Page 37)
- [A] Advanced Setup**
Enters ADVANCED SETUP MENU. (Page 38)
- [D] Disconnect All**
Disconnect all connections. (Page 38)
- [V] View All Setting**
Displays all setting values. (Page 34)
Can also be used with ADVANCED SETUP MENU.
- [S] Save & Quit**
Save set values and quit menu. (Page 35)
- [Q] Quit Unchanged**
Quit menu without saving setting values. (Page 35)

Note

- The factory default settings for the projector are as follows:
DHCP Client : OFF
IP address : 192.168.150.002
Subnet mask : 255.255.255.000
Default gateway : 000.000.000.000

ADVANCED SETUP MENU

▼ ADVANCED SETUP MENU

```

***** ADVANCED SETUP MENU *****
[1]Auto Logout Time [2]Data Port
[5]Network Ping Test
[6]Accept IP Addr(1) [7]Accept IP Addr(2) [8]Accept IP Addr(3)
[9]Accept All IP Addr [0]Search Port

[!]Restore Default Setting
[Q]Return to Main Menu

advanced>
    
```

- [1] Auto Logout Time (Factory default setting : 5 minutes)**
Setting of time until automatic disconnection of network connection. (Page 38)
- [2] Data Port (Factory default setting : 10002)**
Setting the TCP port number used when exchanging data. (Page 38)
- [5] Network Ping Test**
It is possible to confirm that a network connection between the projector and a computer etc. is working normally. (Page 39)
- [6] Accept IP Addr(1)**
- [7] Accept IP Addr(2)**
- [8] Accept IP Addr(3)**
- [9] Accept All IP Addr (Factory default setting : Accept All)**
For improved security, it is possible to set up to three IP addresses allowing connection to the projector. Set IP addresses can be cancelled using [9] Accept All IP Addr. (Page 39)
- [0] Search Port (Factory default setting : 5006)**
Setting the port number used when searching for the projector. (Page 40)
- [!] Restore Default Setting**
Restores all setting values that can be set using the menu to the default state. (Page 40)
- [Q] Return to Main Menu**
Return to the main SETUP MENU. (Page 40)

Controlling the Projector Using RS-232C or Telnet

Enter number or symbol of item to be selected on the SETUP MENU. When setting, input the details to be set. Setting is carried out one item at a time, and saved at the end.

View Setting Detail List ([V]View All Setting)

▼SETUP MENU

```

-----SETUP MENU-----
[1]IP Address      [2]Subnet Mask  [3]Default Gateway
[4]User Name      [5>Password      [6]RS-232C Baud Rate
[7]Projector Name [8]DHCP Client  [A]Advanced Setup
[V]View All Setting [S]Save & Quit  [Q]Quit Unchanged

setup>v
Model Name       : XX-XXXX
Projector Name   : XX-XXXX
MAC Address      : XX:XX:XX:XX:XX:XX
DHCP Client      : Off
IP Address       : 192.168.150.2
Subnet Mask      : 255.255.255.0
Default Gateway  : Not Used
RS-232 Baud Rate : 9600 bps
Password         : Not Required
***** (Advanced Status) *****
Data Port        : 10002
Accept IP Address : Accept All
Auto Logout Time : 5 minutes
Search Port      : 5006
    
```

- ① Enter “v” and press the “Enter” key.
Display all setting values(*).

Set Items

Example: When setting IP Address (change from 192.168.150.2 to 192.168.150.3)

▼SETUP MENU

```

-----SETUP MENU-----
[1]IP Address      [2]Subnet Mask  [3]Default Gateway
[4]User Name      [5>Password      [6]RS-232C Baud Rate
[7]Projector Name [8]DHCP Client  [A]Advanced Setup
[V]View All Setting [S]Save & Quit  [Q]Quit Unchanged

setup>1
IP Address       : 192.168.150.2
Please Enter     : 192.168.150.3
(change)        -> 192.168.150.3

-----SETUP MENU-----
[1]IP Address      [2]Subnet Mask  [3]Default Gateway
[4]User Name      [5>Password      [6]RS-232C Baud Rate
[7]Projector Name [8]DHCP Client  [A]Advanced Setup
[V]View All Setting [S]Save & Quit  [Q]Quit Unchanged

setup>v
Model Name       : XX-XXXX
Projector Name   : XX-XXXX
MAC Address      : XX:XX:XX:XX:XX:XX
DHCP Client      : Off
IP Address       : 192.168.150.3
Subnet Mask      : 255.255.255.0
Default Gateway  : Not Used
RS-232 Baud Rate : 9600 bps
Password         : Not Required
***** (Advanced Status) *****
Data Port        : 10002
Accept IP Address : Accept All
Auto Logout Time : 5 minutes
Search Port      : 5006
    
```

- ① Enter “1” (number of item to be set), and press the “Enter” key.
Display current IP address (*1).
- ② Enter IP address to be set and press the “Enter” key.
Display IP address after change (*2).
- ③ Enter “v” and press the “Enter” key to verify setting detail list.
IP address is being changed (*3).

Note

- Verification of setting detail list can be omitted.
- Setting details are not effective until they have been saved. (Page 35)
- If an invalid number is entered, an error message (“Parameter Error!”) will be displayed.

Save Settings and Quit ([S]Save & Quit)

Save set values and quit menu.

▼SETUP MENU

```
-----SETUP MENU-----
[1]IP Address      [2]Subnet Mask   [3]Default Gateway
[4]User Name      [5]Password
[6]RS-232C Baud Rate [7]Projector Name [8]DHCP Client
[A]Advanced Setup [D]Disconnect All
[V]View All Setting [S]Save & Quit   [Q]Quit Unchanged

setup>s
All Connection will be disconnect.
Continue(y/n)? y
Apply New setting...Done.
```

- ① Enter “s” and press the “Enter” key.
- ② Enter “y” and press the “Enter” key.

Quit without Saving Settings ([Q]Quit Unchanged)

Quit menu without saving setting values.

▼SETUP MENU

```
-----SETUP MENU-----
[1]IP Address      [2]Subnet Mask   [3]Default Gateway
[4]User Name      [5]Password
[6]RS-232C Baud Rate [7]Projector Name [8]DHCP Client
[A]Advanced Setup [D]Disconnect All
[V]View All Setting [S]Save & Quit   [Q]Quit Unchanged

setup>q
Quit Without Saving(y/n)? y
Setting Unchanged.
```

- ① Enter “q” and press the “Enter” key.
- ② Enter “y” and press the “Enter” key.

Controlling the Projector Using RS-232C or Telnet

The setting procedure for each item will be explained. For the basic procedure, please refer to “Set Items” on page 34.

IP Address Setting ([1]IP Address)

Setting of IP address.

```
setup>1
IP Address      :192.168.150.2
Please Enter    :192.168.150.3
(change)  ->  192.168.150.3 *
```

- 1 Enter “1” and press the “Enter” key.
- 2 Enter numerical value to be set and press the “Enter” key.
Display IP address after change (*).

Subnet Mask Setting ([2]Subnet Mask)

Setting subnet mask.

```
setup>2
Subnet Mask    :255.255.255.0
Please Enter    :255.0.0.0
(change)  ->  255.0.0.0 *
```

- 1 Enter “2” and press the “Enter” key.
- 2 Enter numerical value to be set and press the “Enter” key.
Display subnet mask after change (*).

Default Gateway Setting ([3]Default Gateway)

Setting default gateway.

```
setup>3
note: “0.0.0.0” means “Using no default gateway.”
Gateway Address :0.0.0.0
Please Enter    :192.168.150.1
(change)  ->  192.168.150.1 *
```

- 1 Enter “3” and press the “Enter” key.
- 2 Enter numerical value to be set and press the “Enter” key.
Display gateway address after change (*).

Note

- If the values for IP Address, Subnet Mask or Gateway of the projector have been changed via Telnet, the computer cannot be connected to the projector depending on the computer’s network settings.

User Name Setting ([4]User Name)

Carrying out security protection using user name.

```
Setup>4
User Name      :
Please Enter    :XX-XXXX
(change)  ->  XX-XXXX *
```

- 1 Enter “4” and press the “Enter” key.
- 2 Enter user name and press the “Enter” key.
Display set user name (*).

Note

- User name can be up to 8 characters.
- You can input the characters below :
a-z, A-Z, 0-9, -, _
- In the default state, user name is not set.

Password Setting ([5]Password)

Carrying out security protection using password.

```

setup>5
Password      :
(Please Enter : sharpj)
(change)     -> sharpj
    
```

- ① Enter "5" and press the "Enter" key.
- ② Enter password and press the "Enter" key.
Display set password (*).

Note

- Password can be up to 8 characters.
- You can input the characters below :
a-z, A-Z, 0-9, -, _
- In the default state, the password is not set.

RS-232C Baud Rate Setting ([6]RS-232C Baud Rate)

Setting of baud rate for RS-232C (COMPUTER and PROJECTOR) terminals.

```

setup>6
note: It sets both RS-232C (COMPUTER) and RS-232C (PROJECTOR).
0 ... 9600 bps
1 ... 38400 bps
2 ... 115200 bps
(Baud Rate Select[0-2] :2)
RS-232C Baud Rate : 115200 bps
    
```

- ① Enter "6" and press the "Enter" key.
- ② Select and enter the number 0, 1 or 2 and press the "Enter" key.
Display set baud rate (*).

Note

- Set the projector's baud rate to the same rate as that used by the computer.

Projector Name Setting ([7]Projector Name)

It is possible to assign a projector name.

```

setup>7
Projector Name : XX-XXXX
(Please Enter  : MY XX-XXXX)
(change)     -> MY XX-XXXX
    
```

- ① Enter "7" and press the "Enter" key.
- ② Enter projector name.
Display set projector name (*).

Note

- Projector name can be up to 12 characters.
- You can input the characters below :
A-Z, 0-9, -, _, (,), space
(When "a-z" are input, they are converted to "A-Z" automatically.)
- It is the same as the name which can be confirmed or set, using RS-232C commands "PJO", "PJO1", "PJO2" and "PJO3".

DHCP Client Setting ([8]DHCP Client)

Setting DHCP Client to "On" or "Off".

Example: When setting DHCP Client to "On"

```

setup>8
note: It sets DHCP Client.
0 ... Off
1 ... On
(DHCP Select[0-1] :1)
DHCP Client : On

Success get data from DHCP server.
[MAC Address   ] : [XX:XX:XX:XX:XX:XX]
[IP Address    ] : [192.168.150.2]
[Subnet Mask   ] : [255.255.255.0]
[Default Gateway] : [0.0.0.0]
[DHCP IP Address] : [192.168.150.1]
    
```

- ① Enter "8" and press the "Enter" key.
- ② Enter "1" and press the "Enter" key.
Display the obtained values (*).

Disconnecting All Connections ([D]Disconnect All)

It is possible to disconnect all the TCP/IP connections currently recognized by the projector. Even if the COM Redirect port is fixed in the Busy status due to a problem, it is possible to force the Ready status back by carrying out this disconnection.

```
setup>d
Disconnect All Connections(y/n)?y
Now Disconnecting...
```

- 1 Enter “d” and press the “Enter” key.
- 2 Enter “y” and press the “Enter” key.

Note

- If Disconnect All is performed, the connection to the projector via network will be forcibly disconnected.

Entering ADVANCED SETUP MENU ([A]Advanced Setup)

Enters ADVANCED SETUP MENU.

```
setup>a
***** ADVANCED SETUP MENU *****
[1]Auto Logout Time  [2]Data Port
[5]Network Ping Test
[6]Accept IP Addr(1) [7]Accept IP Addr(2) [8]Accept IP Addr(3)
[9]Accept All IP Addr [0]Search Port

[!]Restore Default Setting
[Q]Return to Main Menu

advanced->
```

- 1 Enter “a” and press the “Enter” key.

Setting Auto Logout Time (ADVANCED[1]Auto Logout Time)

If there is no input after a fixed time, the projector automatically disconnects network connection using the Auto Logout function. It is possible to set the time until the projector is automatically disconnected in units of a minute (from 1 to 65535 minutes).

```
advanced>1
Valid range      : 0 to 65535 (minute)
note: if you enter "0", auto logout function will be disable.
Auto Logout Time : 5
Please Enter     :15
(change)        -> 15 *
```

- 1 Enter “1” and press the “Enter” key.
- 2 Enter numerical value and press the “Enter” key. Display set numerical value (*).

Note

- If the set value is made 0, the Auto Logout function is disabled.
- If an invalid number is entered, an error message (“Parameter Error!”) will be displayed and the screen returns to the ADVANCED SETUP MENU.

Data Port Setting (ADVANCED[2]Data Port)

Setting of TCP port number. It is possible to set in the range of 1025 to 65535.

```
advanced>2
Valid range      :1025 to 65535
Data Port       :10002
Please Enter     :10005
(change)        -> 10005 *
```

- 1 Enter “2” and press the “Enter” key.
- 2 Enter numerical value and press the “Enter” key. Display set numerical value (*).

Note

- Set according to need. Normally, use with the factory default setting.

Carrying out Network Ping Test (ADVANCED[5]Network Ping Test)

It is possible to confirm that a network connection between the projector and a computer etc. is working normally.

```

advanced>5
Ping Test IP addr :192.168.150.1
Please Enter :192.168.150.152
(change) -> 192.168.150.152
32 bytes from 192.168.150.152: icmp_seq = 1, time = 0 ms
32 bytes from 192.168.150.152: icmp_seq = 2, time = 0 ms
32 bytes from 192.168.150.152: icmp_seq = 3, time = 0 ms
32 bytes from 192.168.150.152: icmp_seq = 4, time = 0 ms
    
```

- ① Enter “5” and press the “Enter” key.
- ② Enter IP address of device to be tested and press the “Enter” key.
Display entered IP address (*1).
Display test result (*2).

Note

- If the “Enter” key is pressed without entering an IP address, the Ping Test IP address used previously is entered.
- If there is a fault with the connection, “Error: No answer” is displayed after a 5 second retry. In this case, please confirm the settings for the projector and the computer, and contact your network administrator.

Setting of Accept IP Address (ADVANCED[6]Accept IP Addr(1) - [8]Accept IP Addr(3))

It is possible to improve security of the projector by allowing connection from only a prescribed IP address. It is possible to set up to three IP addresses allowing connection to the projector.

```

advanced>6
Accept IP Addr(1) : 0.0.0.0
Please Enter : 192.168.150.152
(change) -> 192.168.150.152
    
```

- ① Enter “6”, “7” or “8” and press the “Enter” key.
- ② Enter numerical value and press the “Enter” key.
Display set numerical value (*).

Note

- To invalidate the Accept IP Addr being currently set, enter “0.0.0.0”.
- If there is one or more Accept IP Addr being set, no connections are allowed from IP addresses that are not yet set. They can be cancelled using [9]Accept All IP Addr.

Accepting All IP Addresses (ADVANCED[9]Accept All IP Addr)

Removes IP addresses set with “Accept IP Addr”.

```

advanced>9
Accept All IP Addresses(y/n)? y
    
```

- ① Enter “9” and press the “Enter” key.
- ② Enter “y” and press the “Enter” key.

Note

- At the point in time where “y” was entered, the numerical values for Accept IP Addr(1)-(3) are reset to “0.0.0.0”.
- If “n” is entered, setting is not altered.

Controlling the Projector Using RS-232C or Telnet

Setting of Search Port (ADVANCED[0]Search Port)

Sets the port number used when searching for the projector from the network.

```
advanced>0
Please Enter Port Number for Search from Computer.
Valid range      : 1025 to 65535
Search Port      : 5006
Please Enter      : 5004
(change)         -> 5004
```

- ① Enter “0” and press the “Enter” key.
- ② Enter numerical value and press the “Enter” key. Display set numerical value (*).

Note

- Set according to need. Normally, use with the factory default setting.

Return to Default Settings (ADVANCED[!]Restore Default Setting)

Returns all menu setting values to the default state.

```
advanced>!
Restore All Setting to Default(y/n)? y
— User Setting Initialized —
```

- ① Enter “!” and press the “Enter” key.
- ② Enter “y” and press the “Enter” key.

Note

- If the values for IP Address, Subnet Mask or Gateway of the projector have been returned to the default settings via Telnet, the computer cannot be connected to the projector depending on the computer's network settings.

Return to Main Menu (ADVANCED[q]Return to Main Menu)

Returns to the main SETUP MENU.

```
advanced>q
-----SETUP MENU-----
[1]IP Address      [2]Subnet Mask    [3]Default Gateway
[4]User Name       [5]Password
[6]RS-232C Baud Rate [7]Projector Name [8]DHCP Client
[A]Advanced Setup  [D]Disconnect All
[V]View All Setting [S]Save & Quit    [Q]Quit Unchanged
setup>
```

- ① Enter “q” and press the “Enter” key. Returns to the SETUP MENU.

Stack Projection

The stack projection allows you to increase the brightness of an image by stacking two projectors and projecting same image simultaneously.

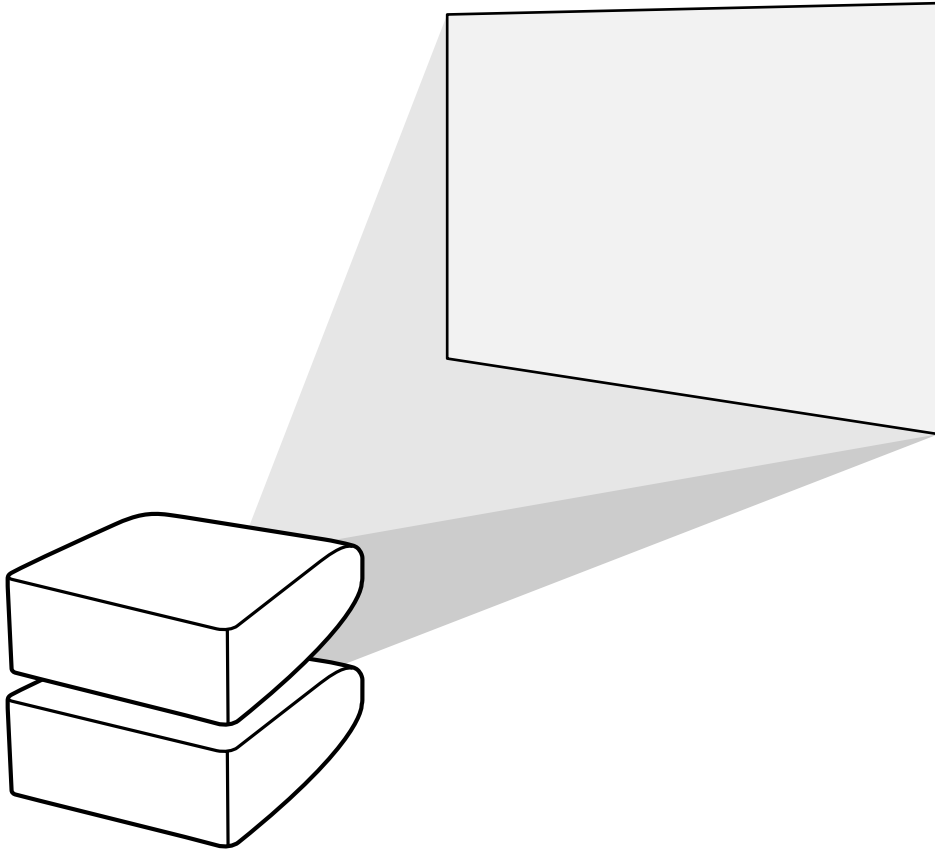

Info

- To set up the stack projection, assign a projector as the master and the other projector as the slave and connect the projectors with commercially available LAN cables (UTP cable, Category 5, cross-over type). In this way, you can control the both projectors with one remote control.
- The buttons below can control both the master and the slave at one time.
 - ON button
 - STANDBY button
 - SHUTTER button
 - COMPUTER1/2, DVI, HDMI, VIDEO, S-VIDEO buttons
 - MUTE button
 - VOLUME buttons
 - AUTO SYNC button
 - RESIZE button
 - PICTURE MODE button
 - BREAK TIMER button
 - FREEZE button
- In normal operation, the projector set as the slave cannot be controlled by the remote control. Only while the remote control is connected to the projector with a $\varnothing 3.5$ mm minijack cable (commercially available or available as Sharp service part QCNWGA038WJPZ), the projector set as the slave can be controlled by the remote control.
- Even while the projector is set as the slave, the buttons on the projector can be used.

Setting up the Stack Projection

Basic

This part shows an example for setting up the stack projection of a computer image with two projectors.

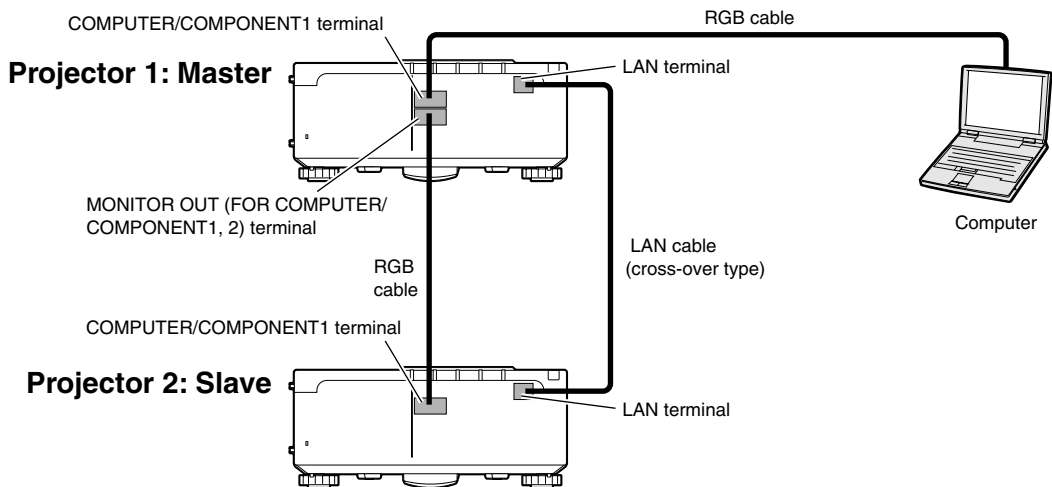

1 Set the “Stack Setting” of the projector 1 to “Master”.

(See page 62 on the projector operation manual.)

2 Set the “Stack Setting” of the projector 2 to “Slave”.

(See page 62 on the projector operation manual.)

3 Perform “Pair Stack” of the both projectors.

(See page 63 on the projector operation manual.)

4 Select inputs as specified in the table below.

(See page 63 on the projector operation manual.)

Projector 1		Projector 2	
Master		Slave	
Set Inputs		Set Inputs	
COMPUTER1	ON	COMPUTER1	ON
COMPUTER2	OFF	COMPUTER2	OFF
DVI	OFF	DVI	OFF
HDMI	OFF	HDMI	OFF
VIDEO	OFF	VIDEO	OFF
S-VIDEO	OFF	S-VIDEO	OFF

5 Turn off the both projectors.

6 Connect the **COMPUTER/COMPONENT1** terminal on the projector 1 to the **RGB** output terminal on the computer using the **RGB** cable.
(See page 24 on the projector operation manual.)

7 Connect the **MONITOR OUT (FOR COMPUTER/COMPONENT1, 2)** terminal on the projector 1 to the **COMPUTER/COMPONENT1** terminal on the projector 2 using an **RGB** cable.
(See page 27 on the projector operation manual.)

8 Connect the **LAN** terminal on the projector 1 to the **LAN** terminal on the projector 2 using a commercially available **LAN** cable (**UTP** cable, **Category 5**, **cross-over** type).

9 Turn on the projectors first, then turn on the computer.

 **Note**

- When connecting an RGB cable to the projector 2, use the input terminal that has the same number as the projector 1. (COMPUTER/COMPONENT1 terminal, in this case)

Application

When inputting multiple image sources, refer to the example below.

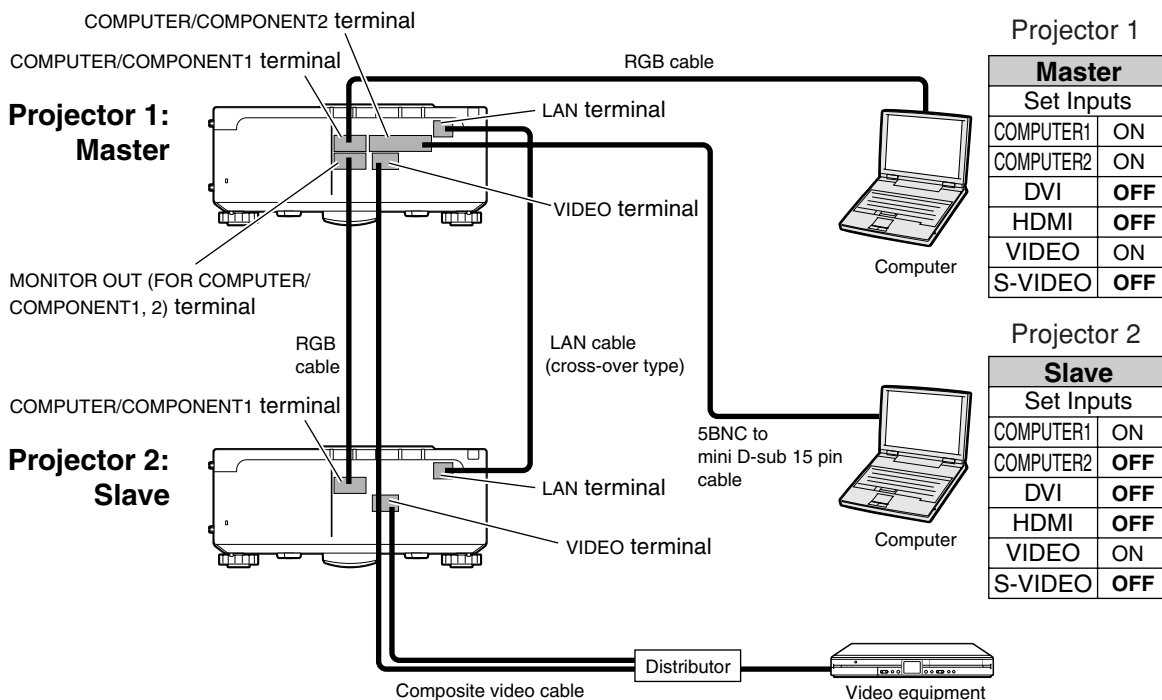

Video Wall Projection

Usually, a costly image-processing device is required to set up a video wall projection. This projector has built-in video wall capability that doesn't require additional equipment.

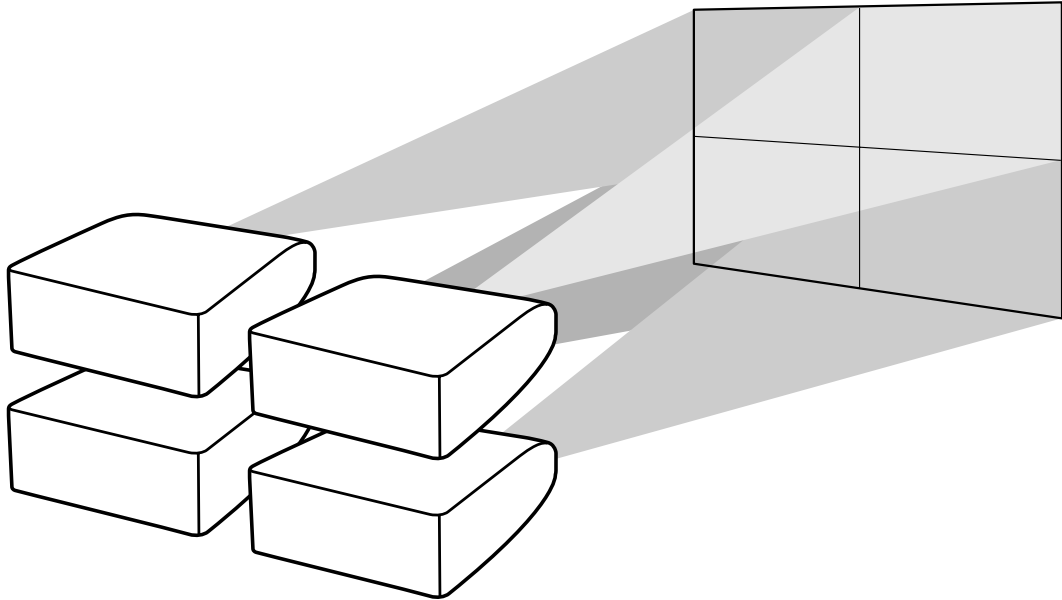

Info

- Before setting up the video wall projection, install Internet Explorer (version 5.0 or later).
- Video wall is not compatible with resolutions higher than SXGA.
- Image quality may deteriorate when picture signals are input through multiple projectors with an RGB cable or an RCA cable in a daisy chain connection.

Setting up the Video Wall Projection **Basic**

Following is an example of how to build a 2 X 2 video wall using 4 projectors.

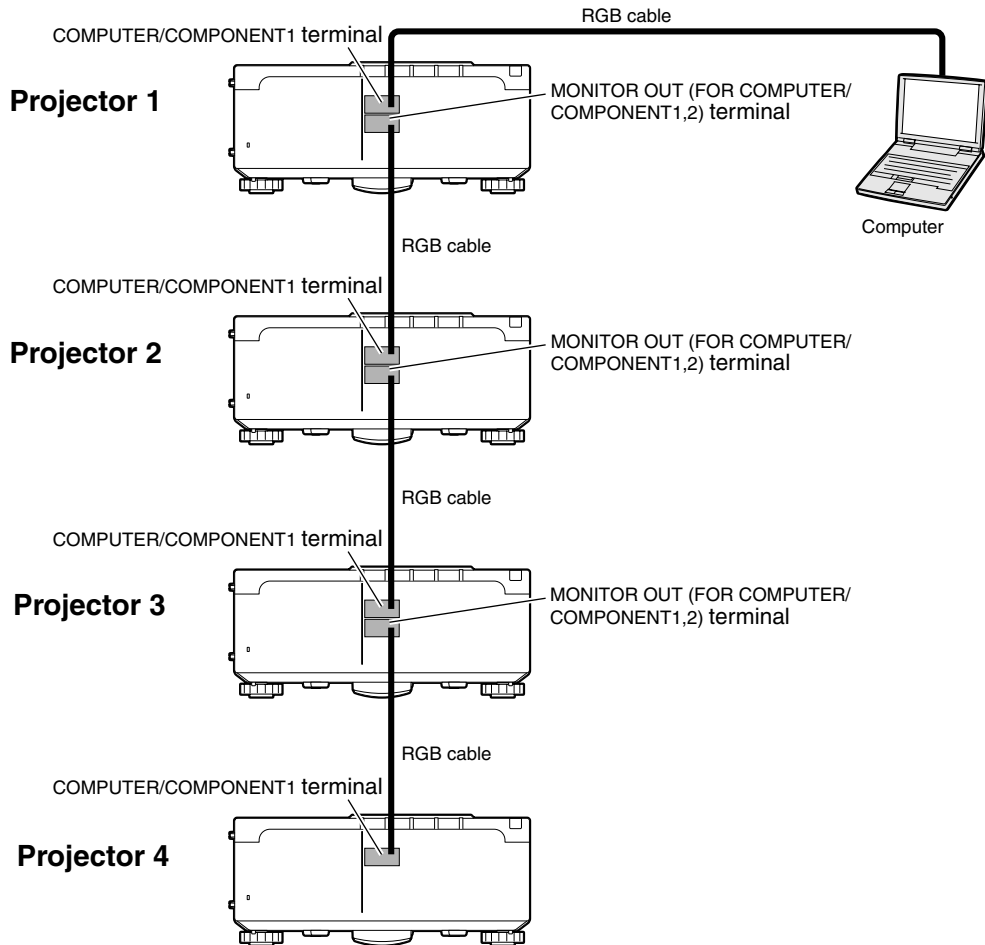

Video Wall Projection

1 Access one of the four projectors via Internet Explorer.

(See “Controlling the Projector Using Internet Explorer (Version 5.0 or later)” (page 26) for the details.)

2 Click “Video Wall” on the menu.

- “Video Wall” display will appear.

3 Select “2 X 2” on “Division”.

4 Click the assigning button for the desired position.

- The projector will be assigned to the part of the video wall.

Note

- For more details on the assigned position and the actual position of the projector, see “Assigning the Projected Image on the Video Wall Setup” (page 47).

5 Repeat the same procedure from the step 1 to 4 for the other three projectors.

That completes the video wall setup. When the same image signal is input to all the projectors, the video wall projection starts.

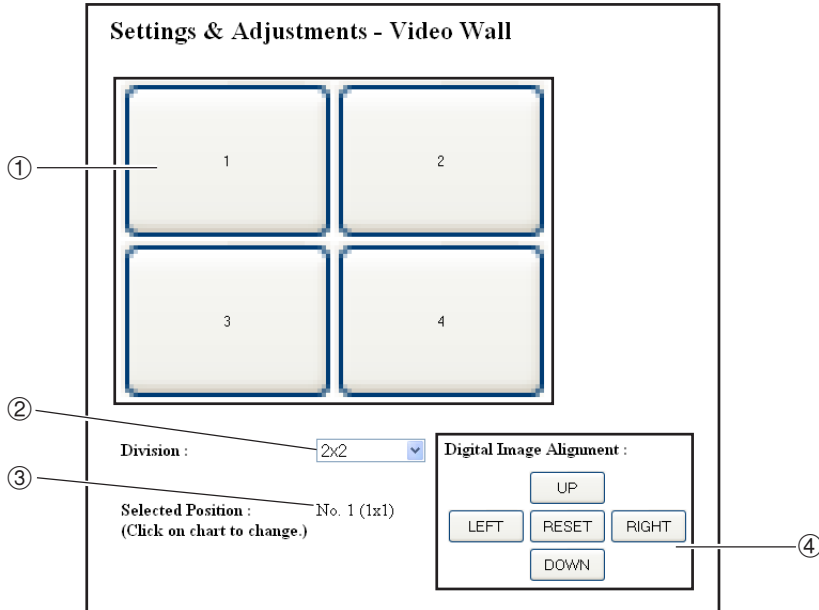

- ① Selects a position for each projector. (the assigning buttons)
- ② Selects a number of positions where the video wall is divided.
- ③ Displays the current status for the video wall setup.
- ④ Adjusts the position of the projected image horizontally and vertically.

Adjusting the Position Horizontally and Vertically

Click “UP”, “DOWN”, “LEFT” or “RIGHT” to the position of the projected image.

Returning to the Default Video Wall Setup

1 Select “1 X 1” on “Division”.

2 Click the assigning button 1.
 • The video wall setup will return to the default settings.

Assigning the Projected Image on the Video Wall Setup

Followings are examples for assigning the projected images for the front and rear projections.

Front Projection

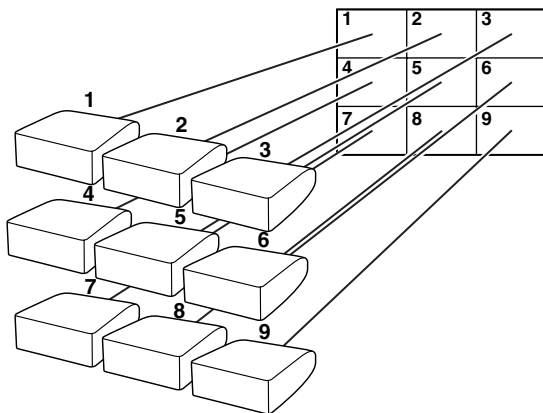

The numbers of the projector refer to the numbers of the projected positions.

Rear Projection

The numbers of the projector refer to the numbers of the projected positions.

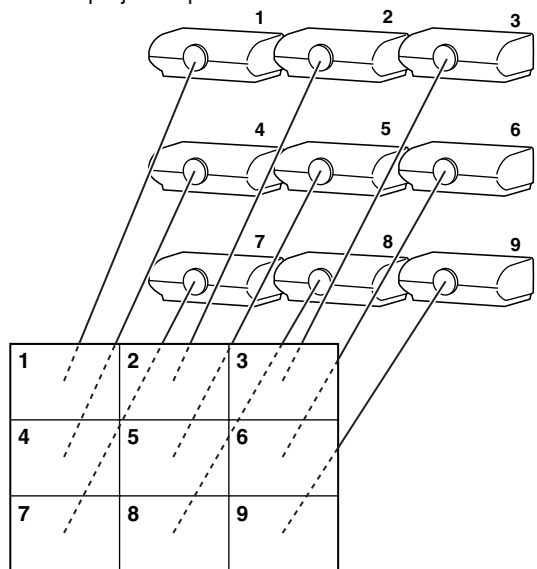

Notes on the Wide Video Wall Projection

Selecting “2 X 1”, “3 X 1”, “4 X 1”, “5 X 1”, “6 X 1”, “7 X 1” or “8 X 1” on “Division” (see page 46) allows you to create the wide video wall.

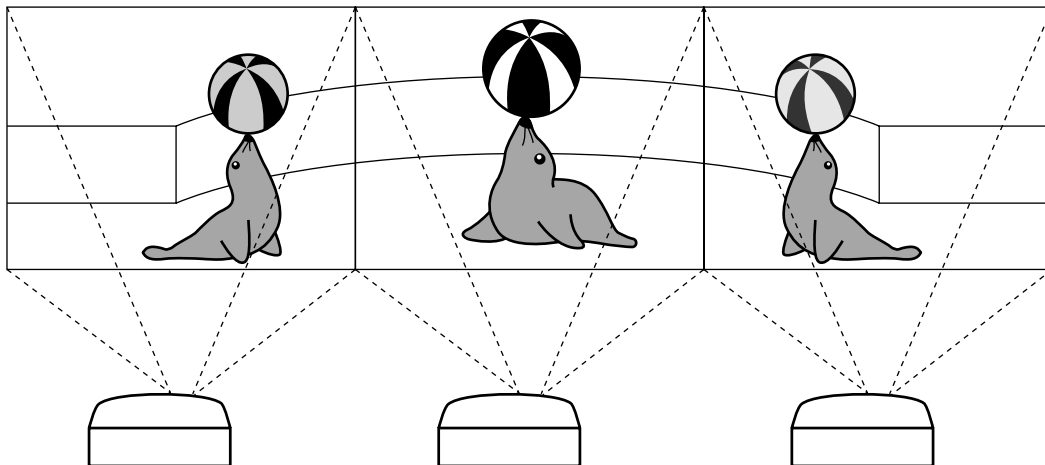

To create the wide video wall with three projectors lining up in single file from left to right (as shown above), select “3 X 1” on “Division”, select a position for each projector, and then input the image which width is compressed at 1/3 (as shown below).

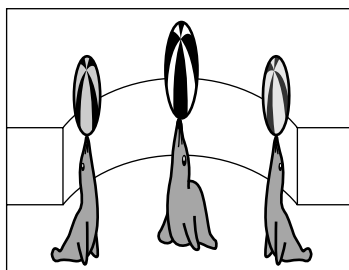

Setting up the Video Wall Projection **Application**

Using “Stack Setting” and “Set Inputs” functions together allows you to control the video wall with one remote control.

This part shows an example of a connecting procedure for inputting the video signals to the video wall based on the example in the previous section.

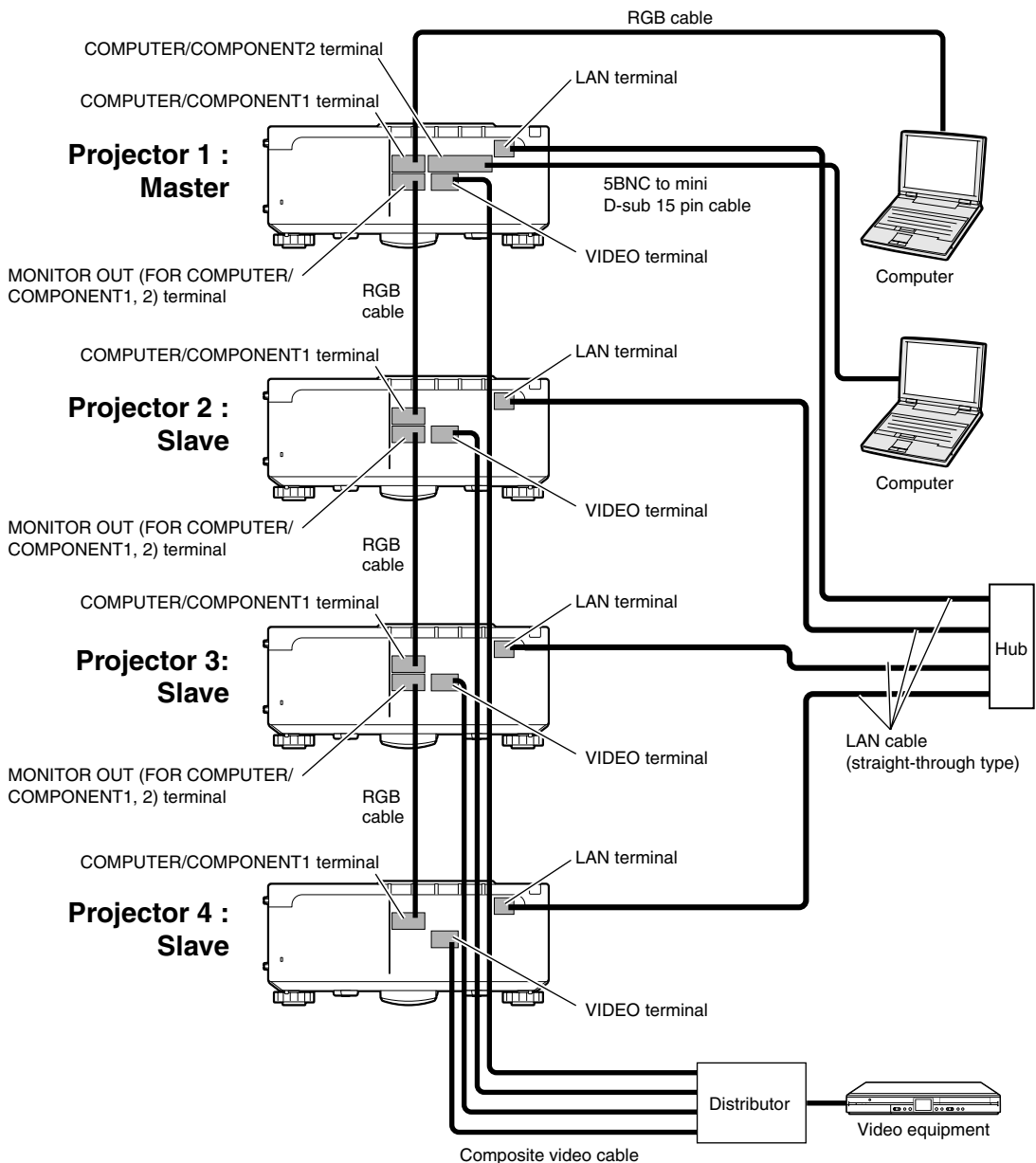

Video Wall Projection

■ Preparation

- Follow the procedure below after setting up the basic connection.
- When “User Name” and “Password” have been set to the projector, reset them before the stack projection setup. To set “User Name” and “Password”, use the same user name and password for both of the master and slave projectors. (See page 28.)
- Set “Data Port” with the same number for both of the master and slave projectors. (See page 29.)

Info

- Do not use network software or equipment while it is accessing the projector via the port of the same number used for the master or slave projector, otherwise you cannot properly control multiple projectors with one remote control.

1 Change the TCP/IP settings for the computer as shown below.

(See “Setting an IP Address for the Computer” on page 22 for the details.)

- IP address : 192.168.150.2
- Subnet mask : 255.255.255.0
- Default gateway : (Do not input any values.)

Note

- The TCP/IP settings shown are examples to make connections following the diagram.
- When using other equipment in the same network, be careful about the IP address overlap or other network settings.
- Consult your network administrator for assistance with the network settings.

2 Change the TCP/IP settings for each projector as shown below.

(See “Setting up a Network Connection for the Projector” on page 24 for the details.)

- IP address Projector 1 : 192.168.150.3
Projector 2 : 192.168.150.4
Projector 3 : 192.168.150.5
Projector 4 : 192.168.150.6
- Subnet mask : 255.255.255.0
- Default gateway : 0.0.0.0

3 Connect the computer and the projectors as shown below.

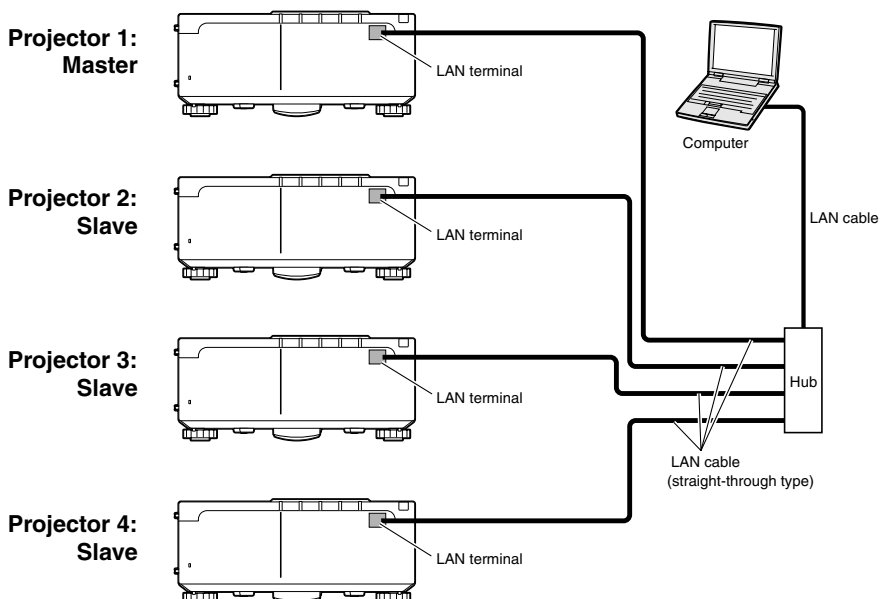

4 Turn on all of the projectors.

5 Access the projector 1 from the computer via Internet Explorer.

(See “Controlling the Projector Using Internet Explorer (Version 5.0 or later)” on page 26 for the details.)

6 Click “Stack” on the menu.

7 Select “Master” on “Stack Setting”.

• “Slave Address” display will appear.

Settings & Adjustments - Stack	
Stack Setting	Master
Slave 1	0 0 0 0 (IP Address)
Slave 2	0 0 0 0 (IP Address)
Slave 3	0 0 0 0 (IP Address)
Slave 4	0 0 0 0 (IP Address)
Slave 5	0 0 0 0 (IP Address)

8 Make the IP address for each projector as shown below.

- Slave 1 : 192.168.150.4
- Slave 2 : 192.168.150.5
- Slave 3 : 192.168.150.6

9 Click the “Apply” button.

10 Access the projector 2 from the computer via Internet Explorer.

(See “Controlling the Projector Using Internet Explorer (Version 5.0 or later)” on page 26 for the details.)

11 Click “Stack” on the menu.

12 Select “Slave” on “Stack Setting”.

Video Wall Projection

13 Repeat the same procedure from the step 10 to 12 for the projector 3 and 4.

14 Select inputs as specified in the table on the right.
(See page 63 on the projector operation manual.)

 **Note**

- Set input terminals you will use to “ON”. Set input terminals you will not use to “OFF”.

Projector 1

Master	
Set Inputs	
COMPUTER1	ON
COMPUTER2	ON
DVI	OFF
HDMI	OFF
VIDEO	ON
S-VIDEO	OFF

Projector 2-4

Slave	
Set Inputs	
COMPUTER1	ON
COMPUTER2	OFF
DVI	OFF
HDMI	OFF
VIDEO	ON
S-VIDEO	OFF

15 Turn off all of the projectors.

16 Make connections following the diagram shown on page 49.

17 Turn on the projectors first, then turn on the computers and the video equipment.

 **Note**

- Image quality may deteriorate when picture signals are input through multiple projectors with an RGB cable in a daisy chain connection.

Resetting the Lamp Timer of the Projector via LAN

When the projector is connected to a network, you can use the communications program to send a command to reset the lamp timer. The example below uses Windows® XP as the operating system. When you use Windows Vista®, use other communications program referring to the following steps, because Windows Vista® does not come with HyperTerminal.

1 Click “Start” – “All Programs” – “Accessories” – “Communications” – “HyperTerminal”.

- If you do not have HyperTerminal installed, see the operation manual of your computer.
- Depending on the settings of your computer, you may be required to enter your area code and other details. Enter the information as required.

2 Enter a name in the “Name” field, and click “OK”.

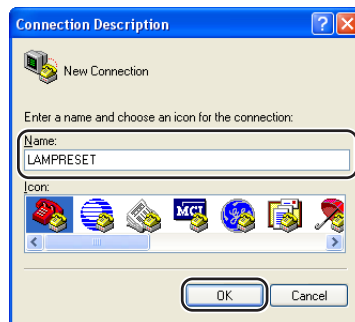

3 If you are required to enter the area code, enter it in the “Area code” field. From the “Connect using” drop-down menu, select “TCP/IP (Winsock)”, and click “OK”.



4 Enter the IP address of the projector in the “Host address” field (see “TCP/IP” on the “Network” menu of the projector), and enter the data port of the projector in the “Port number” field (“10002” is the factory default setting), and click “OK”.

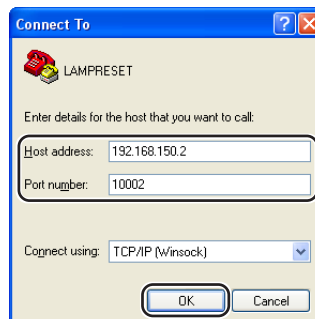

Resetting the Lamp Timer of the Projector via LAN

5 Click “Properties” on the “File” menu.

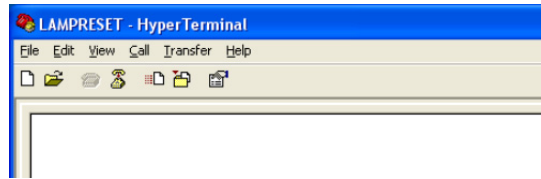

6 Click the “Settings” tab, and then click “ASCII Setup”.

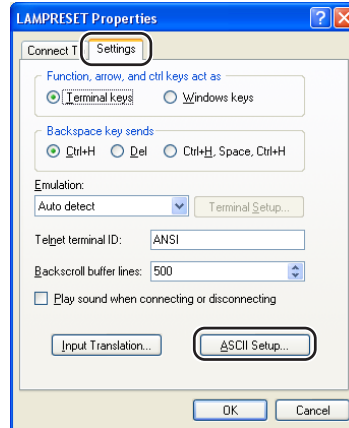

7 Select the check boxes next to “Send line ends with line feeds”, “Echo typed characters locally”, and “Append line feeds to incoming line ends”, and click “OK”.

- The LAMPRESET Properties window appears, click “OK”.

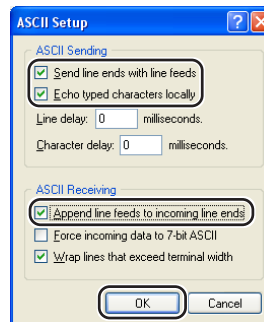

8 If a user name and/or password is set for the projector, enter the user name and password.

9 Send the lamp reset command.
“LPRE0001” for LAMP 1
“LPRE0002” for LAMP 2

- These commands can only be sent when the projector is in standby mode.
- When “OK” is received, this indicates that the lamp was successfully reset.

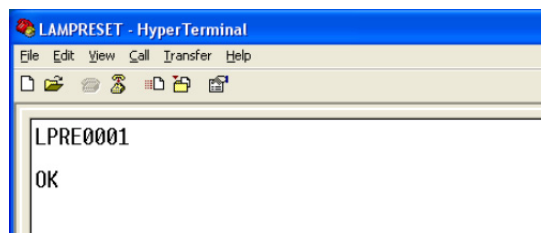

10 Close HyperTerminal.

Communication cannot be established with the projector

When connecting the projector using serial-connection

- ◀ Check that the RS-232C terminal of the projector and a computer or the commercially available controller are connected correctly.
- ◀ Check that the RS-232C cable is a cross-over cable.
- ◀ Check that the RS-232C port setting for the projector corresponds to the setting for the computer or the commercially available controller.

When connecting the projector to a computer using network (LAN)-connection

- ◀ Check that the cable's connector is firmly inserted in the LAN terminal of the projector.
- ◀ Check that the cable is firmly inserted into a LAN port for a computer or a network device such as a hub.
- ◀ Check that the LAN cable is a Category 5 cable.
- ◀ Check that the LAN cable is a cross-over cable when connecting the projector to a computer directly.
- ◀ Check that the LAN cable is a straight-through cable when connecting the projector with a network device such as a hub.
- ◀ Check that the power supply is turned on for the network device such as a hub between the projector and a computer.

Check the network settings for the computer and the projector

- ◀ Check the following network settings for the projector.
 - IP Address
Check that the IP address for the projector is not duplicated on the network.
 - Subnet Mask
When the gateway setting for the projector is "0.0.0.0" (Not Used), or the gateway setting for the projector and the default gateway setting for the computer are the same:
 - The subnet masks for the projector and the computer should be the same.
 - The IP address parts shown by the subnet mask for the projector and the computer should be the same.
(Example)
When the IP address is "192.168.150.2" and the subnet mask is "255.255.255.0" for the projector, the IP address for the computer should be "192.168.150.X" (X=3-254) and the subnet mask should be "255.255.255.0".
 - Gateway
When the gateway setting for the projector is "0.0.0.0" (Not Used), or the gateway setting for the projector and the default gateway setting for the computer are the same:
 - The subnets for the projector and the computer should be the same.
 - The IP address parts shown by the subnet mask for the projector and the computer should be the same.
(Example)
When the IP address is "192.168.150.2" and the subnet mask is "255.255.255.0" for the projector, the IP address for the computer should be "192.168.150.X" (X=3-254) and the subnet mask should be "255.255.255.0".
 - Data Port
Other computers should not use the data port of the projector.
The data port should be used for communication during the stack projection.

Note

- The factory default settings for the projector are as follows:
DHCP Client : OFF
IP address : 192.168.150.2
Subnet mask : 255.255.255.0
Gateway address : 0.0.0.0 (Not Used)
- For network settings for the projector, refer to page [24](#).

Troubleshooting

- ◀ Take the following steps for checking the network settings for the computer.
 1. Open a command prompt.
 - In the case of Windows® 2000: click “start” → “Programs” → “Accessories” → “Command Prompt” in order.
 - In the case of Windows® XP, Windows Vista®: click “start” → “All Programs” → “Accessories” → “Command Prompt” in order.
 2. After launching the command prompt, enter the command “ipconfig”, and press the “Enter” key.

Note

- Communication may not be established even after carrying out the network settings for the computer. In such cases, restart your computer.

C:\>ipconfig

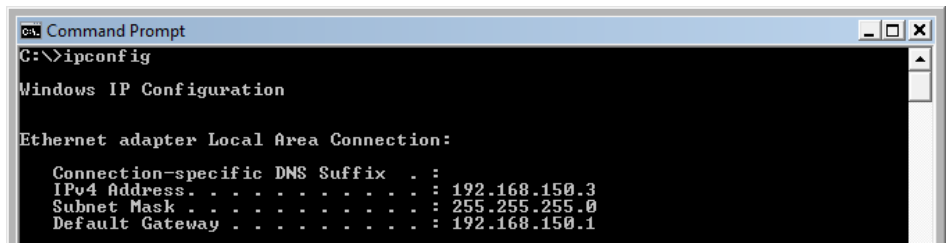

```
cs Command Prompt
C:\>ipconfig

Windows IP Configuration

Ethernet adapter Local Area Connection:

    Connection-specific DNS Suffix  . : 
    IPv4 Address. . . . . : 192.168.150.3
    Subnet Mask . . . . . : 255.255.255.0
    Default Gateway . . . . . : 192.168.150.1
```

Note

- Usage examples of ipconfig
 - C:\>ipconfig /? displays how to use “ipconfig.exe”.
 - C:\>ipconfig displays the set IP address, subnet mask and default gateway.
 - C:\>ipconfig /all displays all the setting information related to TCP/IP.

3. To return to the Windows® screen, enter “exit” and press the “Enter” key.

- ◀ Check if the “TCP/IP” protocol is operating correctly using the “PING” command. Also, check if an IP address is set.
 1. Open a command prompt.
 - In the case of Windows® 2000: click “start” → “Programs” → “Accessories” → “Command Prompt” in order.
 - In the case of Windows® XP, Windows Vista®: click “start” → “All Programs” → “Accessories” → “Command Prompt” in order.
 2. After launching the command prompt enter a command “PING”.
Entry example C:\>ping XXX.XXX.XXX.XXX
“XXX.XXX.XXX.XXX” should be entered with an IP address to be connected to, such as the projector.
 3. When connecting normally, the display will be as follows.
(The screen may be slightly different depending on the OS type.)
<Example> when the IP address connected to is “192.168.150.1”

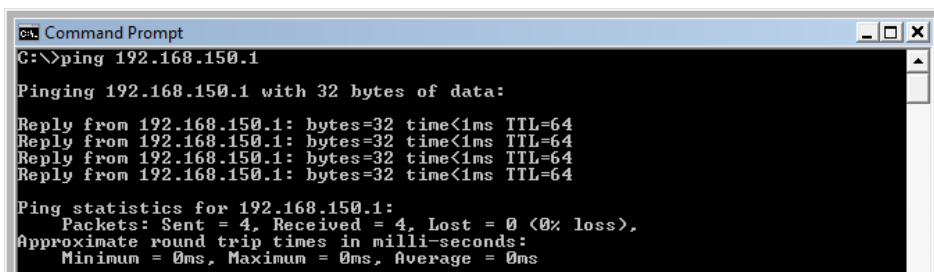

```
C:\> Command Prompt
C:\>ping 192.168.150.1

Pinging 192.168.150.1 with 32 bytes of data:

Reply from 192.168.150.1: bytes=32 time<1ms TTL=64
Reply from 192.168.150.1: bytes=32 time<1ms TTL=64
Reply from 192.168.150.1: bytes=32 time<1ms TTL=64
Reply from 192.168.150.1: bytes=32 time<1ms TTL=64

Ping statistics for 192.168.150.1:
    Packets: Sent = 4, Received = 4, Lost = 0 (0% loss),
    Approximate round trip times in milli-seconds:
        Minimum = 0ms, Maximum = 0ms, Average = 0ms
```

4. When a command cannot be sent, “Request time out” will be displayed.
Check the network setting again.
If communication can still not be established properly, contact your network administrator.
5. To return to the Windows® screen, enter “exit” and then press the “Enter” key.

A connection cannot be made because you have forgotten your user name or your password.

- ◀ Initialize the settings. (See page 65 of the projector’s operation manual.)
- ◀ After the initialization, carry out setting again.

Dimensions

Units: inches (mm)

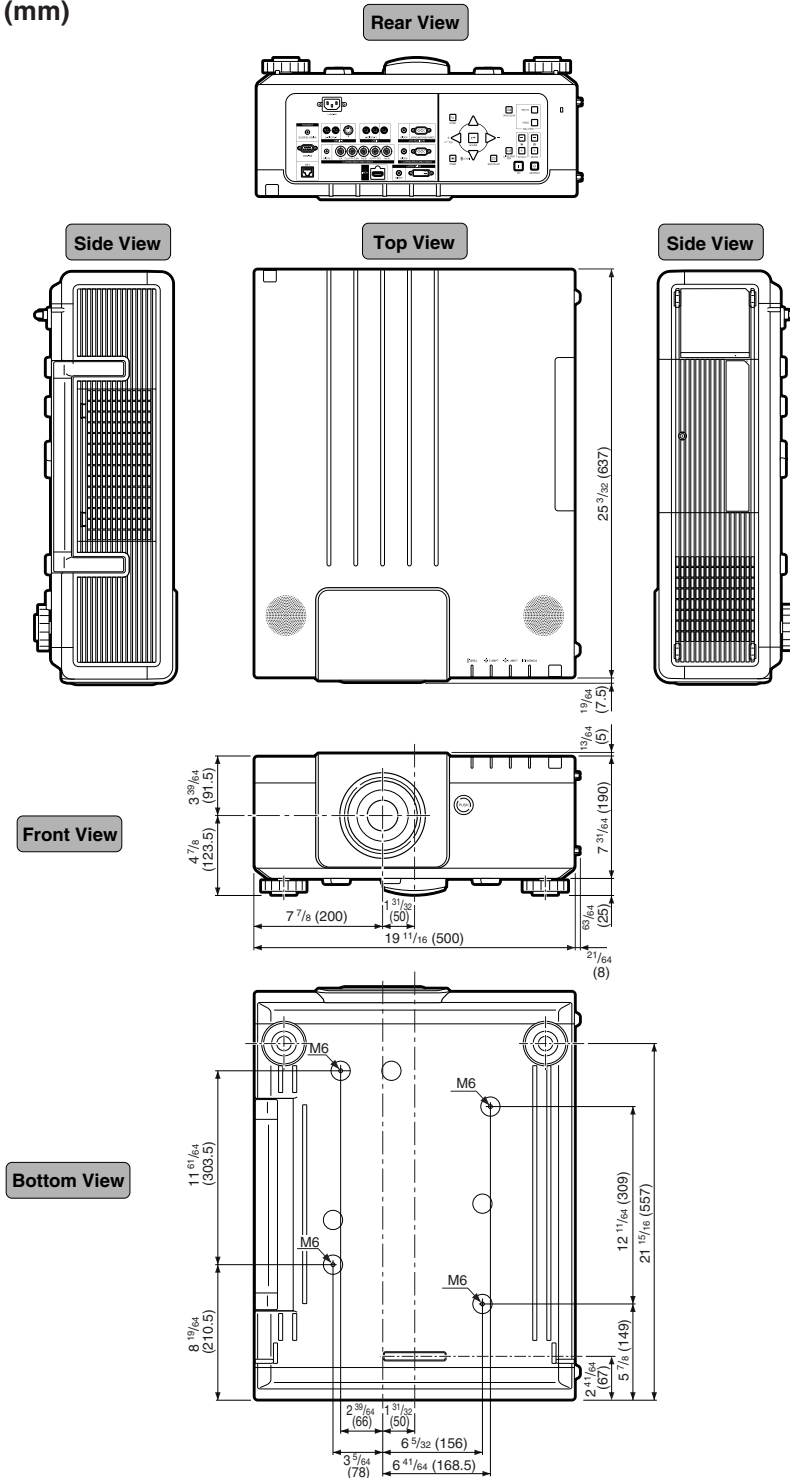

Projector and Lens Dimensions

[When AN-P8EX is installed]

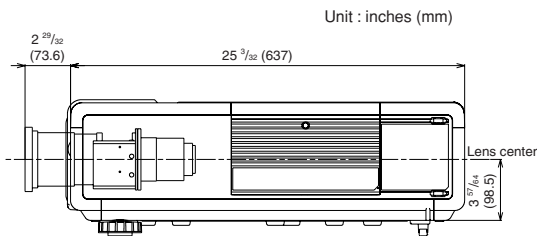

[When AN-P12EX is installed]

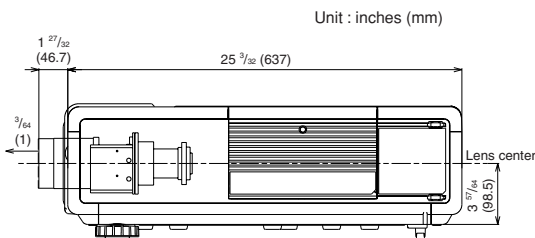

[When AN-P15EZ is installed]

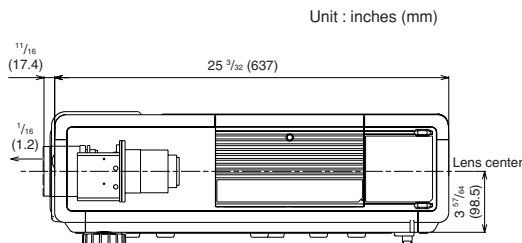

[When AN-P18EZ is installed]

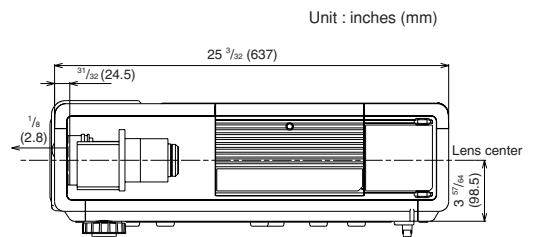

[When AN-P23EZ is installed]

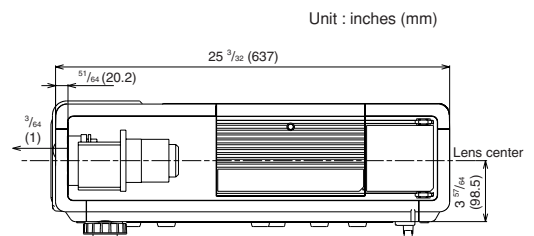

[When AN-P30EZ is installed]

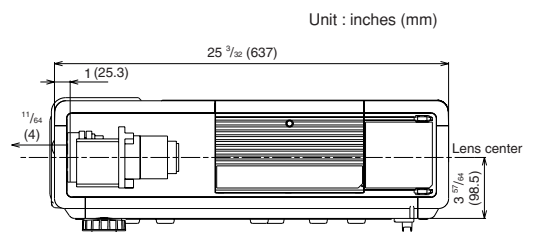

[When AN-P45EZ is installed]

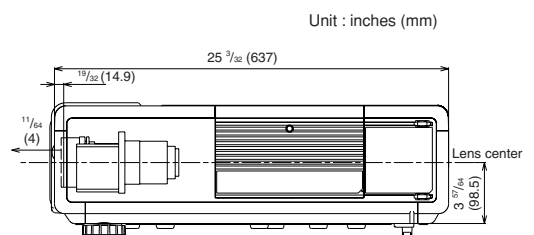

Free Manuals Download Website

<http://myh66.com>

<http://usermanuals.us>

<http://www.somanuals.com>

<http://www.4manuals.cc>

<http://www.manual-lib.com>

<http://www.404manual.com>

<http://www.luxmanual.com>

<http://aubethermostatmanual.com>

Golf course search by state

<http://golfingnear.com>

Email search by domain

<http://emailbydomain.com>

Auto manuals search

<http://auto.somanuals.com>

TV manuals search

<http://tv.somanuals.com>