

# SHARP®



**IMAGE  
QUALITY**

Important  
Information



Setup & Connections



Operation Buttons



Basic Operation



Useful Features &  
Network Function



Maintenance &  
Troubleshooting



Appendix



## OPERATION MANUAL

MODEL

# XG-V10XU

## LCD PROJECTOR

*Conference Series*



Lenses are sold separately.

Before using the LCD projector, please read this operation manual carefully.



# Introduction

ENGLISH

## IMPORTANT

For your assistance in reporting the loss or theft of your Color LCD Projector, please record the Serial Number located on the bottom of the projector and retain this information. Before recycling the packaging, please be sure that you have checked the contents of the carton thoroughly against the list of "Supplied Accessories" on page 13.

**Model No.: XG-V10XU**

**Serial No.:**

There are two important reasons for prompt warranty registration of your new SHARP LCD Projector, using the REGISTRATION CARD packed with the projector.

### 1. WARRANTY

This is to assure that you immediately receive the full benefit of the parts, service and labor warranty applicable to your purchase.

### 2. CONSUMER PRODUCT SAFETY ACT



To ensure that you will promptly receive any safety notification of inspection, modification, or recall that SHARP may be required to give under the 1972 Consumer Product Safety Act, PLEASE READ CAREFULLY THE IMPORTANT "LIMITED WARRANTY" CLAUSE.

U.S.A. ONLY

**WARNING:** High brightness light source. Do not stare into the beam of light, or view directly. Be especially careful that children do not stare directly into the beam of light.

**WARNING:** To reduce the risk of fire or electric shock, do not expose this product to rain or moisture.

See bottom of actual set.

	<b>CAUTION</b> <b>RISK OF ELECTRIC SHOCK.</b> <b>DO NOT REMOVE SCREWS</b> <b>EXCEPT SPECIFIED USER</b> <b>SERVICE SCREW.</b>	
<b>CAUTION: TO REDUCE THE RISK OF ELECTRIC SHOCK,</b> <b>DO NOT REMOVE COVER.</b> <b>NO USER-SERVICEABLE PARTS EXCEPT LAMP UNIT.</b> <b>REFER SERVICING TO QUALIFIED SERVICE</b> <b>PERSONNEL.</b>		



The lightning flash with arrowhead symbol, within an equilateral triangle, is intended to alert the user to the presence of uninsulated "dangerous voltage" within the product's enclosure that may be of sufficient magnitude to constitute a risk or electric shock to persons.



The exclamation point within a triangle is intended to alert the user to the presence of important operating and maintenance (servicing) instructions in the literature accompanying the product.

**WARNING:** FCC Regulations state that any unauthorized changes or modifications to this equipment not expressly approved by the manufacturer could void the user's authority to operate this equipment.

U.S.A. ONLY

## INFORMATION

This equipment has been tested and found to comply with the limits for a Class A digital device, pursuant to Part 15 of the FCC Rules. These limits are designed to provide reasonable protection against harmful interference when the equipment is operated in a commercial environment. This equipment generates, uses, and can radiate radio frequency energy and, if not installed and used in accordance with the operation manual, may cause harmful interference to radio communications. Operation of this equipment in a residential area is likely to cause harmful interference, in which case the user will be required to correct the interference at his own expense.

U.S.A. ONLY

The enclosed computer cable must be used with the device. The cable is provided to ensure that the device complies with FCC Class A verification.

U.S.A. ONLY



# IMPORTANT SAFEGUARDS



Electrical energy can perform many useful functions. This product has been engineered and manufactured to ensure your personal safety. But IMPROPER USE CAN RESULT IN POTENTIAL ELECTRICAL SHOCK OR FIRE HAZARD. In order not to defeat the safeguards incorporated into this LCD Projector, observe the following basic rules for its installation, use and servicing. For your own protection and reliable usage of your LCD Projector, please be sure to read these "IMPORTANT SAFEGUARDS" carefully before use.

## 1. Read Instructions

All the safety and operating instructions should be read before the product is operated.

## 2. Retain Instructions

The safety and operating instructions should be retained for future reference.

## 3. Heed Warnings

All warnings on the product and in the operating instructions should be adhered to.

## 4. Follow Instructions

All operating and use instructions should be followed.

## 5. Cleaning

Unplug this product from the wall outlet before cleaning. Do not use liquid cleaners or aerosol cleaners. Use a damp cloth for cleaning.

## 6. Attachments

Do not use attachments not recommended by the product manufacturer as they may cause hazards.

## 7. Water and Moisture

Do not use this product near water—for example, near a bathtub, wash bowl, kitchen sink, or laundry tub; in a wet basement; or near a swimming pool; and the like.

## 8. Accessories

Do not place this product on an unstable cart, stand, tripod, bracket, or table. The product may fall, causing serious injury to a child or adult, and serious damage to the product. Use only with a cart, stand, tripod, bracket, or table recommended by the manufacturer, or sold with the product. Any mounting of the product should follow the manufacturer's instructions, and should use a mounting accessory recommended by the manufacturer.

## 9. Transportation

A product and cart combination should be moved with care. Quick stops, excessive force, and uneven surfaces may cause the product and cart combination to overturn.



## 10. Ventilation

Slots and openings in the cabinet are provided for ventilation to ensure reliable operation of the product and to protect it from overheating. The openings should never be covered or blocked by placing the product on a bed, sofa, rug, or other similar surface. This product should not be placed in a built-in installation such as a bookcase or rack unless proper ventilation is provided or the manufacturer's instructions have been adhered to.

## 11. Power Sources

This product should be operated only from the type of power source indicated on the marking label. If you are not sure of the type of power supply to your home, consult your product dealer or local power company. For products intended to operate from battery power, or other sources, refer to the operating instructions.

## 12. Grounding or Polarization

This product is equipped with a three-wire grounding-type plug, a plug having a third (grounding) pin. This plug will only fit into a grounding-type power outlet. This is a safety feature. If you are unable to insert the plug into the outlet, contact your electrician to replace your obsolete outlet. Do not defeat the safety purpose of the grounding-type plug.

## 13. Power-Cord Protection

Power-supply cords should be routed so that they are not likely to be walked on or pinched by items placed upon or against them, paying particular attention to cords at plugs, convenience receptacles, and the point where they exit from the product.

## 14. Lightning

For added protection for this product during a lightning storm, or when it is left unattended and unused for long periods of time, unplug it from the wall outlet and disconnect the cable system. This will prevent damage to the product due to lightning and power-line surges.

## 15. Overloading

Do not overload wall outlets, extension cords, or integral convenience receptacles as this can result in a risk of fire or electric shock.

## 16. Object and Liquid Entry

Never push objects of any kind into this product through openings as they may touch dangerous voltage points or short-out parts that could result in a fire or electric shock. Never spill liquid of any kind on the product.

## 17. Servicing

Do not attempt to service this product yourself as opening or removing covers may expose you to dangerous voltage or other hazards. Refer all servicing to qualified service personnel.

## 18. Damage Requiring Service

Unplug this product from the wall outlet and refer servicing to qualified service personnel under the following conditions:

- If the power-supply cord or plug is damaged.
- If liquid has been spilled, or objects have fallen into the product.
- If the product has been exposed to rain or water.
- If the product does not operate normally by following the operating instructions. Adjust only those controls that are covered by the operating instructions, as an improper adjustment of other controls may result in damage and will often require extensive work by a qualified technician to restore the product to normal operation.
- If the product has been dropped or damaged in any way.
- If the product exhibits a distinct change in performance, this indicates a need for service.

## 19. Replacement Parts

When replacement parts are required, be sure the service technician has used replacement parts specified by the manufacturer or with the same characteristics as the original part. Unauthorized substitutions may result in fire, electric shock, or other hazards.

## 20. Safety Check

Upon completion of any service or repairs to this product, ask the service technician to perform safety checks to determine that the product is in proper operating condition.

## 21. Wall or Ceiling Mounting

This product should be mounted to a wall or ceiling only as recommended by the manufacturer.

## 22. Heat

This product should be situated away from heat sources such as radiators, heat registers, stoves, or other products (including amplifiers) that produce heat.



# IMPORTANT SAFEGUARDS

<b>CAUTION</b> LASER RADIATION- DO NOT STARE INTO BEAM  WAVE LENGTH : 650nm MAX. OUTPUT : 1mW CLASS II LASER PRODUCT	*COMPLIES WITH 21 CFR SUBCHAPTER J* SHARP ELECTRONICS CORPORATION SHARP PLAZA, MAHWAH, NEW JERSEY 07430 TEL : 1-800-BE-SHARP (U.S.A. ONLY)
	REMOTE CONTROL MODEL NO. : RRMC01564CESA DCIV (L33KPCS) MADE IN CHINA FABRIQUE AU CHINE

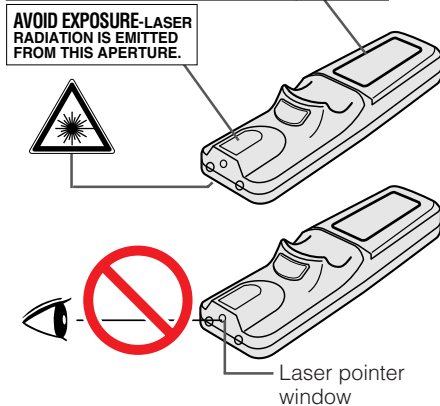
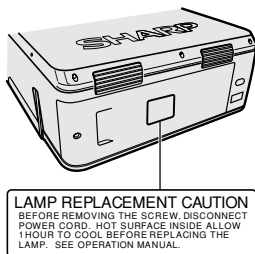
**LAMP REPLACEMENT CAUTION**  
 BEFORE REMOVING THE SCREW, DISCONNECT POWER CORD. HOT SURFACE INSIDE ALLOW 1 HOUR TO COOL BEFORE REPLACING THE LAMP. SEE OPERATION MANUAL.

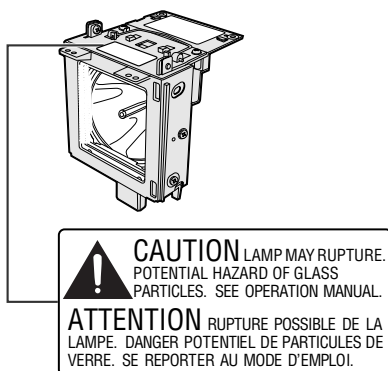

**CAUTION** LAMP MAY RUPTURE. POTENTIAL HAZARD OF GLASS PARTICLES. SEE OPERATION MANUAL.  
**ATTENTION** RUPTURE POSSIBLE DE LA LAMPE. DANGER POTENTIEL DE PARTICULES DE VERRE. SE REPORTER AU MODE D'EMPLOI.

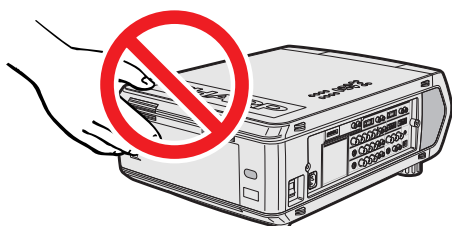
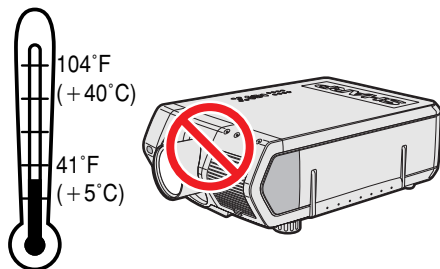

## Cautions Concerning the Laser Pointer

The laser pointer on the remote control emits a laser beam from the laser pointer window. This is a Class II laser which may impair your sight if directed into the eyes. The three marks shown on the left are caution labels for the laser beam.

- Do not look into the laser pointer window or shine the laser beam on yourself or others. (The laser beam used in this product is harmless when directed onto the skin. However, be careful not to project the beam directly into the eyes.)
- Always use the laser pointer at temperatures between 41°F and 104°F (+5°C and +40°C).
- Use of controls or adjustments, or performance of procedures other than those specified herein may result in hazardous radiation exposure.

## Caution Concerning the Lamp Replacement

See "Replacing the Lamp" on pages 71 and 72.

## Caution Concerning the Lamp Unit

Potential hazard of glass particles if lamp ruptures. In case of lamp rupture, contact your nearest Authorized Sharp Industrial LCD Products Dealer or Service Center for a replacement.

See "Replacing the Lamp" on pages 71 and 72.

## Cautions Concerning the Setup of the Projector

For minimal servicing and to maintain high image quality, SHARP recommends that this projector be installed in an area free from humidity, dust and cigarette smoke. When the projector is subjected to these environments, the lens must be cleaned more often. As long as the projector is properly maintained in this manner, use in these environments will not reduce the overall operation life. Please note that all internal cleaning must be performed by an Authorized Sharp Industrial LCD Products Dealer or Service Center.

## Notes on Operation

- The exhaust vent, the lamp cage cover and adjacent areas may be extremely hot during projector operation. To prevent injury, do not touch these areas until they have sufficiently cooled.
- Allow at least 4 inches (10 cm) of space between the exhaust vent and the nearest wall or obstruction.
- If the cooling fan becomes obstructed, a protection device will automatically turn off the projector lamp. This does not indicate a malfunction. Remove the projector power cord from the wall outlet and wait at least 10 minutes. Then turn on the power by plugging the power cord back in. This will return the projector to the normal operating condition.



## IMPORTANT SAFEGUARDS



### Temperature Monitor Function

If the projector starts to overheat due to setup problems or a dirty air filter, "TEMP." and "X" will flash in the lower-left corner of the picture. If the temperature continues to rise, the lamp will turn off, the TEMPERATURE WARNING indicator on the projector will flash, and after a 90-second cooling-off period the power will shut off. Refer to "Lamp/Maintenance Indicators" on page 69, for details.

#### NOTE

- The cooling fan regulates the internal temperature, and its performance is automatically controlled. The sound of the fan may change during projector operation due to changes in the fan speed.



### Lamp Monitor Function

When the projector is turned on after the lamp has been used for 900 hours, "LAMP" and "L" will flash in the lower-left corner of the picture to advise you to replace the lamp. Check the "Lamp Timer" menu to confirm which lamp has been used for 900 hours and needs to be replaced. See pages 71 and 72 for lamp replacement. If the lamp has been used for 1,000 hours, the projector power will automatically turn off and the projector will enter standby mode. Refer to "Lamp/Maintenance Indicators" on page 69, for details.

### Using the Carrying Handle

When transporting the projector, carry it by the carrying handle on the side.

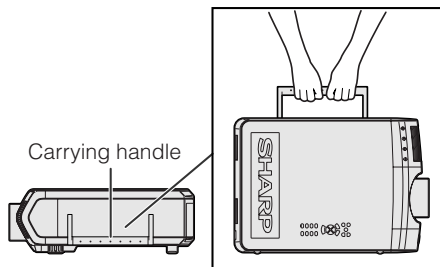

#### CAUTION

- Always put on the lens cap to prevent damage to the lens when transporting the projector.
- Do not lift or carry the projector by the lens or the lens cap as this may damage the lens.
- This equipment is very heavy, so to prevent injury take special care when carrying on your own.
- Do not put down the equipment when the BNC-RCA adapters are connected.

### Using the Terminal Cover

- When ceiling-mounting the projector, attach the terminal cover (supplied) to hide the connecting cables.
- Use the terminal cover to hide the connecting cables when the projector is used on a desktop or high mounted.

- ① Attach the terminal cover by aligning with the tabs on the projector.
- ② Install the terminal cover using the two supplied user service screws attached.

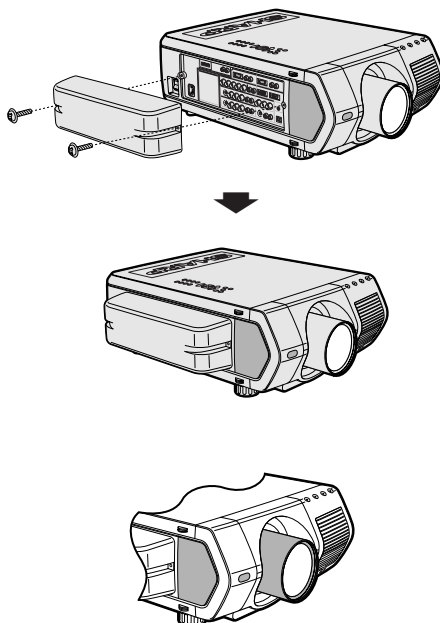

### Optional lenses

- Lenses are sold separately.
- Be sure to have service personnel install optional lenses.



## Outstanding Features

### 1. High-end LCD Projector with Ultra High Brightness

- **200 W UHP Lamps**  
Uses two 200 W UHP lamps for excellent color uniformity and ultra high brightness.
- **Newly developed prism enables efficient combination of light from two lamps.**  
A light axis separation and synthesis prism developed by Sharp enables the efficient combination of light from the two lamps.
- **Single-/Double-lamp Switching Feature**  
Projection can continue without interruption even if one lamp burns out. Lamps can be used separately to double the usage time.

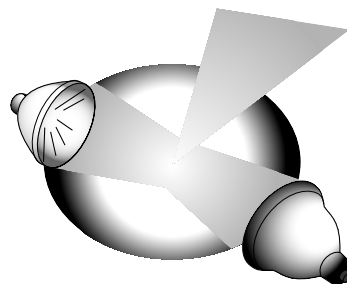

### 2. Computer Compatibility

- **Compatible with resolutions including VGA-SVGA (expanded), XGA (true resolution) and SXGA-UXGA (compressed) as well as DTV formats (480i, 480P, 720P and 1080i).**

### 3. XGA Image Quality

- **OCS LCD panel enhances color uniformity.**
- **Various other circuits are also used to provide high quality video images.**

### 4. Computer & Video Integrated Composer Technology

- **New Progressive Mode**  
I/P conversion with new algorithm used to achieve beautiful image quality.
- **Enhanced Up-scaling and Digital Image Enlargement**  
Enables sharper image quality without jaggies even for enlarged images.
- **Superior 16:9 Image**  
4:3 images can be converted to 16:9 images using Smart Stretch (sides stretched, center untouched), previously not achievable with LCD projectors.
- **Intelligent Digital Keystone Correction**  
Smooths out jaggies on keystone images and compresses the image not only horizontally but vertically keeping the 4 : 3 aspect ratio, and at the same time, calculates the aspect ratio automatically adjusting to the lens shift width.
- **New Intelligent Compression**  
Efficiently compresses UXGA (1,600 × 1,200) images to XGA (1,024 × 768).
- **Enhanced three-two pull down**  
Converts cinema mode DVD images transformed with three-two pull down enhancement to progressive mode images for easier viewing by Film Mode.

### 5. 3D Digital Uniformity and Digital Convergence

- **Three-Dimensional Digital Uniformity compensates uneven picture brightness even for pictures at any brightness level from white to dark. And, with Digital Convergence, a slight distortion of convergence can be easily adjusted on the service menu screen without having to touch the LCD panel.**

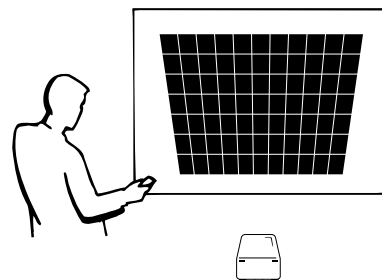



## 6. Network Capability

- **Self-Diagnosis/Projector Status**

Self-diagnosis/Projector status function sends e-mail messages to a specified computer about lamp usage time and any malfunctions.

- **Multiple & Group Projector Control**

Up to 250 projectors can be controlled over a network. Projector RS-232C OUT can be used for daisy chain connection.

- **Simple Stacking and Videowall Display**

Comes with software for easy stacking and videowall processing even for input from a single source.

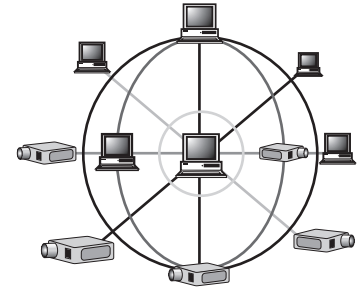

## 7. Six Optional Lenses for Maximum Flexibility

- **Standard Zoom Lens, Fixed Wide Lens, Wide-Zoom Lens, Mid-Range Zoom Lens, Tele-Zoom Lens, Super Zoom Lens**

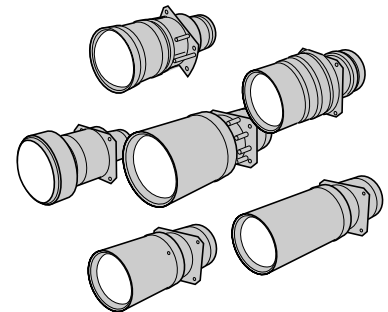

## 8. Multiple Input and Output Terminals

- **BNC Terminal for RGB/Component/Video Signal**
- **PC Digital Input (DVI)**
- **Expansion Terminal for Optional Boards**

Board for Network Capability: RS-422 Board, LAN Board (Soon-to-be-released)

Expansion Video Board: Serial Digital Interface (SDI) Board

## 9. Easy Setup

- **Power Lens Shift, Power Zoom & Focus, Digital Keystone Correction**
- **High Speed AutoSync Technology (4 to 8 sec.)**

## 10. Advanced Presentation Features

- **Built-in Presentation Tools, Picture-in-Picture, Digital Enlargement, Freeze**
- **Customizable Startup Screen & Background Screen**

## 11. Application Software

- **“Sharp Advanced Presentation Software—Professional Edition” (Network and Remote Control)**

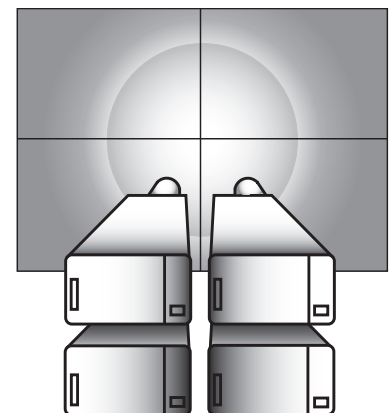
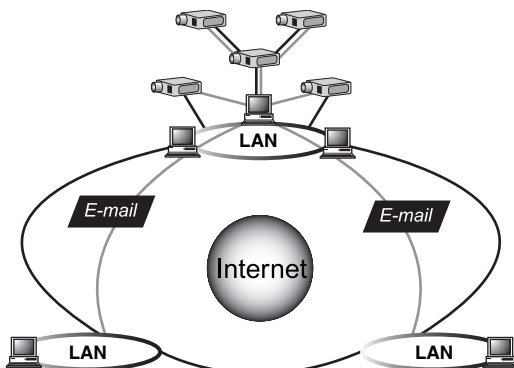



# Contents



## Important Information

Introduction .....	1
<b>IMPORTANT SAFEGUARDS .....</b>	<b>2</b>
<b>Outstanding Features .....</b>	<b>5</b>
<b>Contents .....</b>	<b>7</b>
<b>How to Access the PDF Operation</b>	
<b>Manuals .....</b>	<b>9</b>
<b>Part Names .....</b>	<b>10</b>
<b>Supplied Accessories .....</b>	<b>13</b>



## Setup & Connections

<b>Connections .....</b>	<b>14</b>
Power Supply .....	14
Projecting Computer Images .....	14
Watching Video Images and	
Laser Disc Images .....	17
Watching DVD and Digital TV Images .....	18
For Better Sound .....	18
Power ON/OFF .....	19
<b>Setting Up the Screen .....</b>	<b>20</b>
Using the Adjustment Feet .....	20
Adjusting the Projection Distance .....	21
LENS Button .....	29
<b>Image Projection .....</b>	<b>30</b>
Rear Projection .....	30
Projection Using a Mirror .....	30
Ceiling-mount Projection .....	30



## Operation Buttons

<b>Using the Operation Buttons .....</b>	<b>31</b>
Selecting the Input Signal Source .....	31
Adjusting the Volume .....	31
Muting the Sound .....	31
Superimposing a Black Screen .....	32
Displaying a Still Image .....	32
Magnifying a Specific Portion	
of an Image .....	33
Adjusting the Picture Aspect Ratio .....	34
Gamma Correction Function .....	35
Selecting the Remote Control Mode .....	36
Operating the Remote Control .....	36
Connecting the Mouse Receiver .....	38
Using as a Laser Pointer .....	39
Using as a Wired Remote Control .....	39





# Contents



## Basic Operation

<b>Using the GUI (Graphical User Interface) Menu Screen .....</b>	<b>40</b>
Basic Operations .....	40
Menu Bars .....	41
Adjusting the Picture .....	43
Adjusting the Computer Images (RGB menu only) .....	46
Adjusting the Sound .....	50
Displaying Dual Pictures (RGB menu only) .....	51
Reducing Image Noise (VIDEO menu only) .....	52
Turning On/Off the On-screen Display .....	53
Setting the Video Signal (VIDEO menu only) .....	53
Selecting a Background Image .....	54
Selecting a Startup Image .....	54
Selecting the Economy Mode .....	55
Reversing/Inverting Projected Images .....	56
Selecting the On-screen Display Language .....	57
Displaying the Adjustment Settings .....	58



## Useful Features & Network Function

<b>Useful Features .....</b>	<b>59</b>
Locking the Operation Buttons on the Projector .....	59
Deselecting Inputs .....	59
Selecting the Transmission Speed (RS-232C) .....	60
Protecting Important Settings with a Password .....	61
<b>Network Function .....</b>	<b>62</b>
Setting Up the Optional Boards .....	62
Controlling Multiple Projectors with ID Numbers .....	63
Setting the Stacking Mode .....	63
Using the Presentation Tools .....	64
Operating the Network Function .....	65



## Maintenance & Troubleshooting

<b>Lamp/Maintenance Indicators .....</b>	<b>69</b>
<b>Lamp Maintenance .....</b>	<b>70</b>
Confirming the Lamp Usage Time .....	70
Setting the Lamp Mode .....	71
Replacing the Lamp .....	71
<b>Replacing the Air Filter .....</b>	<b>73</b>
<b>Troubleshooting .....</b>	<b>74</b>
<b>For SHARP Assistance (U.S.A. only) .....</b>	<b>74</b>



## Appendix

<b>Guide to Effective Presentations .....</b>	<b>75</b>
<b>Connecting Pin Assignments (RS-232C) Specifications and Command Settings .....</b>	<b>79</b>
<b>Wired Remote Control Terminal Specifications .....</b>	<b>83</b>
<b>Computer Compatibility Chart .....</b>	<b>84</b>
<b>Dimensions .....</b>	<b>85</b>
<b>Specifications .....</b>	<b>86</b>
<b>Glossary .....</b>	<b>87</b>
<b>Index .....</b>	<b>88</b>





# How to Access the PDF Operation Manuals

PDF operation manuals in several languages are included in the CD-ROM. To utilize these manuals, you need to install Adobe Acrobat Reader on your PC (Windows or Macintosh). If you have not installed Acrobat Reader yet, you can download it from the Internet (<http://www.adobe.com>) or install it from the CD-ROM.

## To Install Acrobat Reader from the CD-ROM

### For Windows:

- ① Insert the CD-ROM in the CD-ROM drive.
- ② Double click on the "My Computer" icon.
- ③ Double click on the "CD-ROM" drive.
- ④ Double click on the "manuals" folder.
- ⑤ Double click on the "acrobat" folder.
- ⑥ Double click on the "windows" folder.
- ⑦ Double click on the desired installation program and follow the instructions on the screen.

### For Macintosh:

- ① Insert the CD-ROM in the CD-ROM drive.
- ② Double click on the "CD-ROM" icon.
- ③ Double click on the "manuals" folder.
- ④ Double click on the "acrobat" folder.
- ⑤ Double click on the "mac" folder.
- ⑥ Double click on the desired installation program and follow the instructions on the screen.

### For other operating systems:

Please download Acrobat Reader from the Internet (<http://www.adobe.com>).

### For other languages:

If you prefer using Acrobat Reader for languages other than those included in the CD-ROM, please download the appropriate version from the Internet.

## Accessing the PDF Manuals

### For Windows:

- ① Insert the CD-ROM in the CD-ROM drive.
- ② Double click on the "My Computer" icon.
- ③ Double click on the "CD-ROM" drive.
- ④ Double click on the "manuals" folder.
- ⑤ Double click on the "xg-v10xu" folder.
- ⑥ Double click on the language (name of the folder) that you want to view.
- ⑦ Double click on the "v10x" pdf file to access the projector manuals.  
Double click on the "saps" pdf file to access the Sharp Advanced Presentation Software manual.
- ⑧ Double click on the pdf file.

### For Macintosh:

- ① Insert the CD-ROM in the CD-ROM drive.
- ② Double click on the "CD-ROM" icon.
- ③ Double click on the "manuals" folder.
- ④ Double click on the "xg-v10xu" folder.
- ⑤ Double click on the language (name of the folder) that you want to view.
- ⑥ Double click on the "v10x" pdf file to access the projector manuals.  
Double click on the "saps" pdf file to access the Sharp Advanced Presentation Software manual.
- ⑦ Double click on the pdf file.

### NOTE

- If the desired pdf file cannot be opened by double clicking the mouse, start Acrobat Reader first, then specify the desired file using the "File", "Open" menu.
- See the "readme.txt" file on the CD-ROM for important information on the CD-ROM not included in this operation manual.



# Part Names



Numbers next to the part names refer to the main pages in this manual where the topic is explained.

## Projector

### Front and Top View

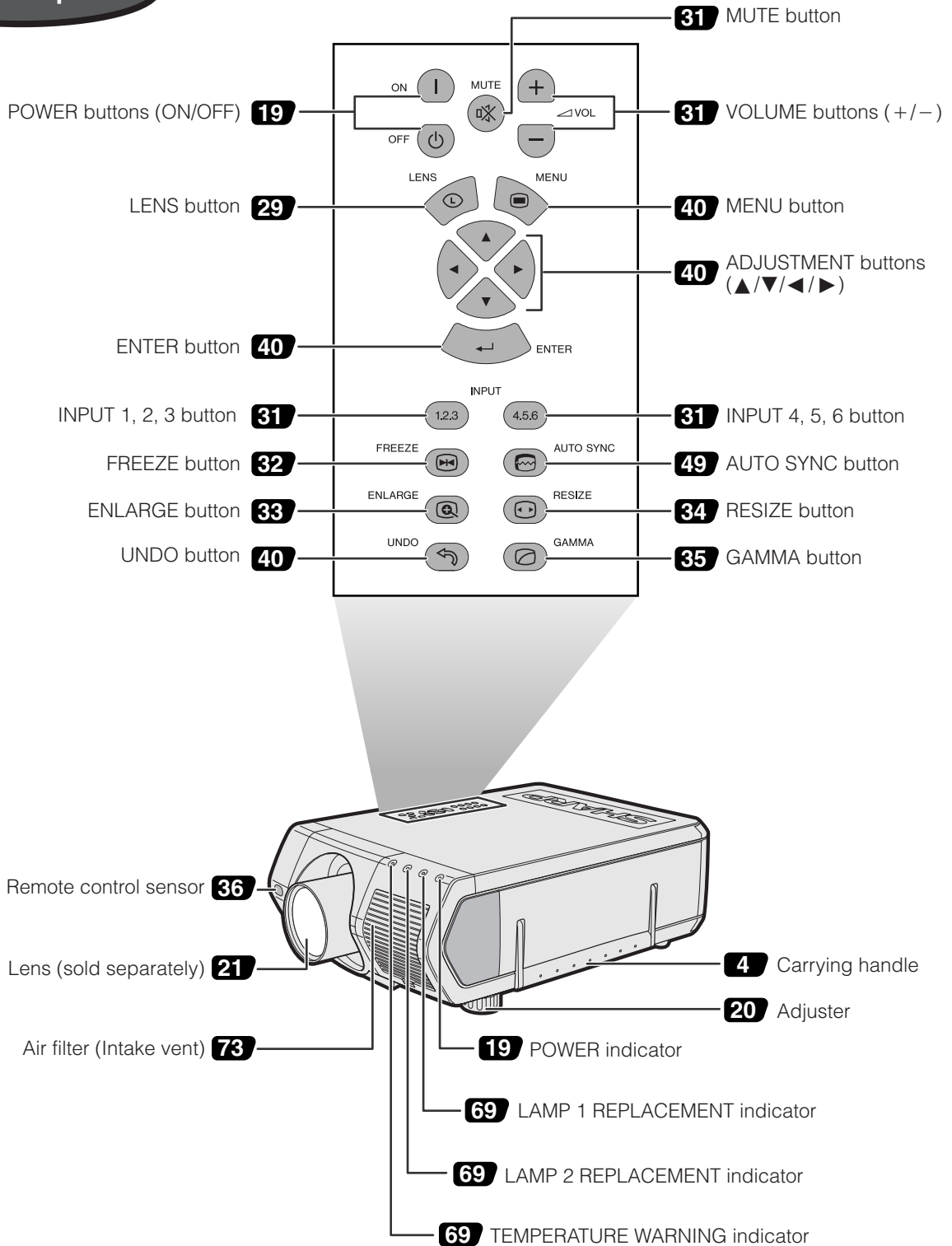



# Part Names

Numbers next to the part names refer to the main pages in this manual where the topic is explained.

## Projector

### Side and Rear View

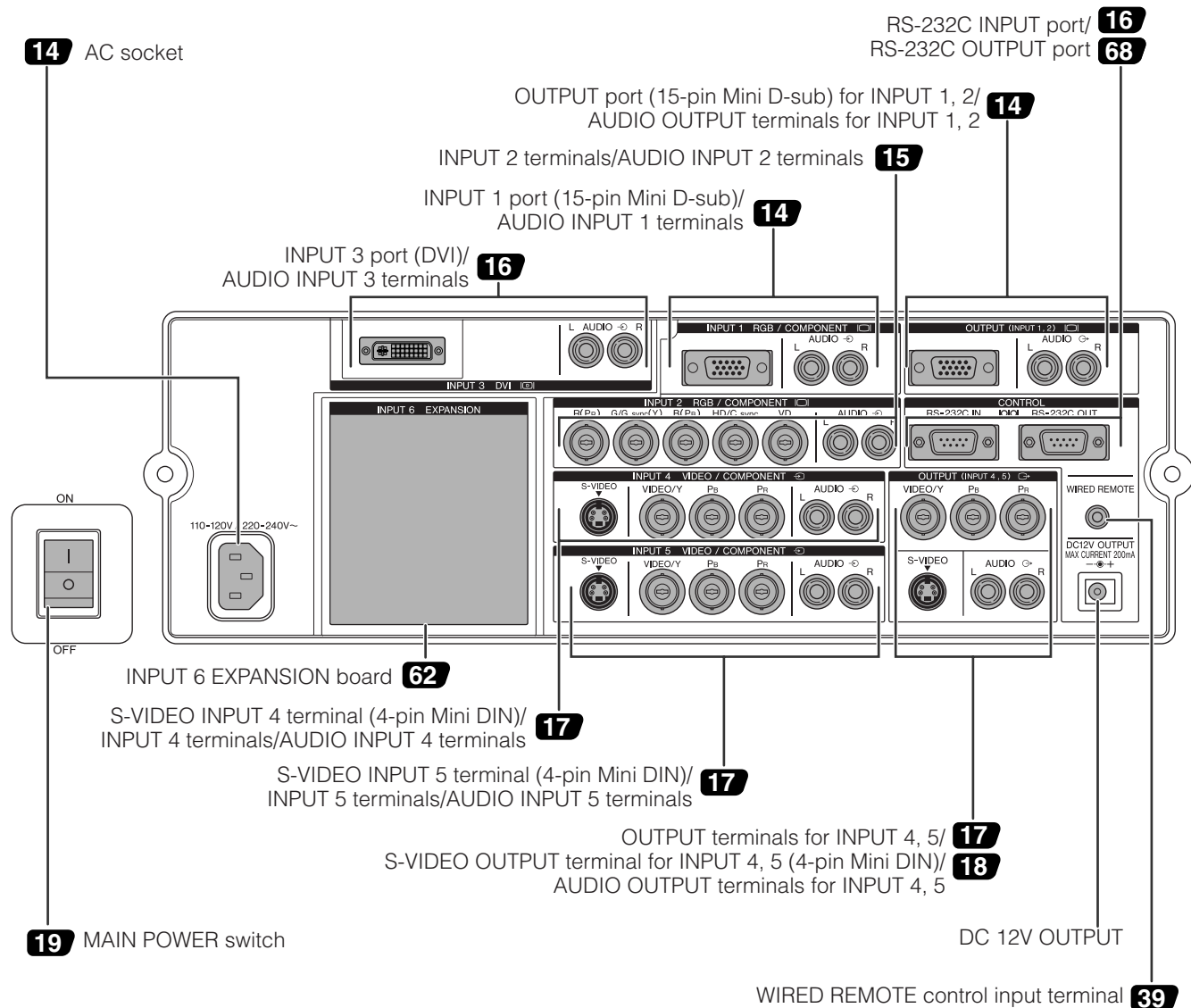
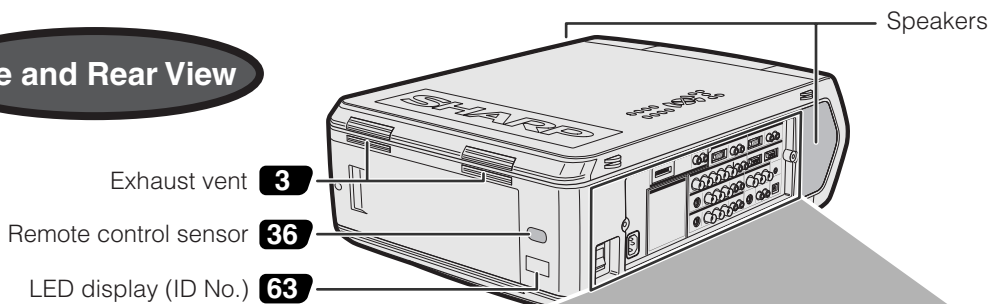



# Part Names



## Remote Control

### Front View

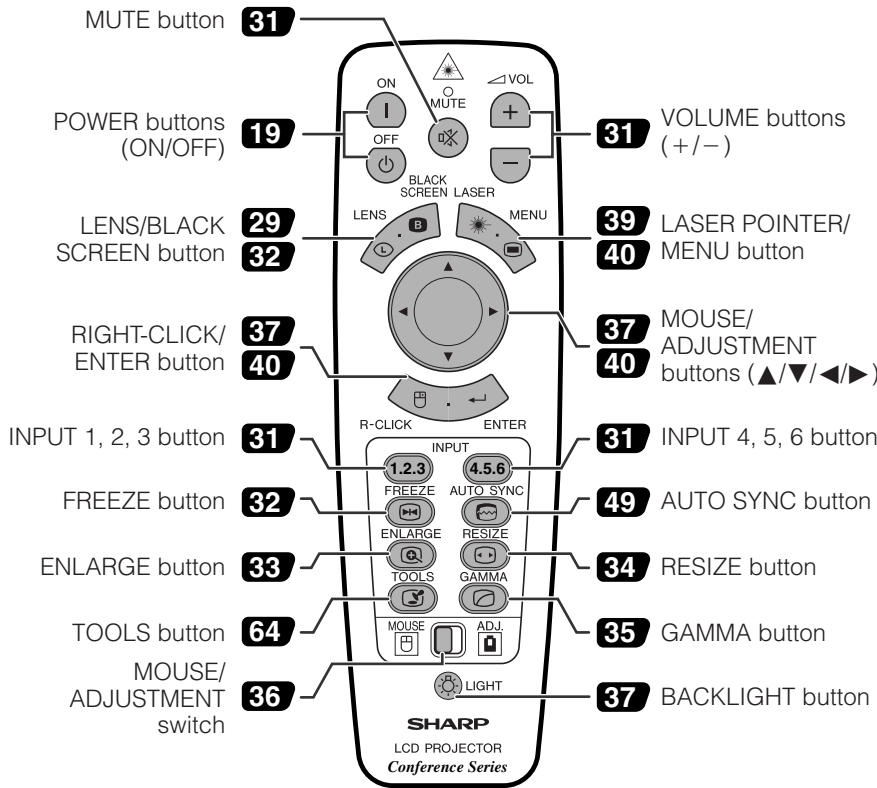

### Top View

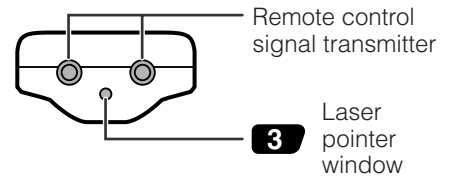

### Rear View

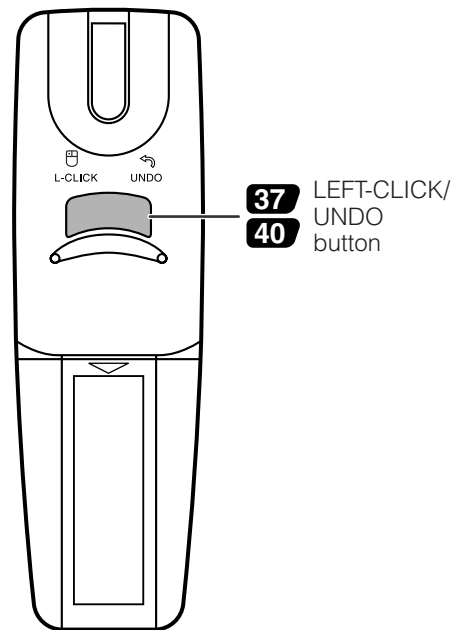

### Bottom View



## Inserting the batteries

**1** Press in on the arrow mark and slide in the direction of the arrow to remove the battery cover.

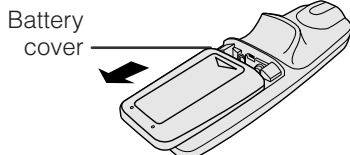

**2** Insert two AA size batteries, making sure the polarities match the + and - marks inside the battery compartment.

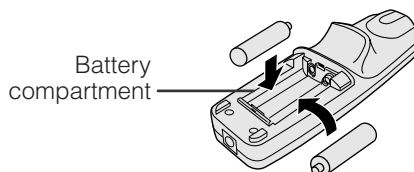

**3** Insert the side tabs of the battery cover into the slots and press the cover in until it is properly seated.

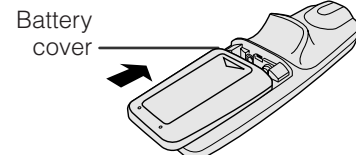



# Supplied Accessories

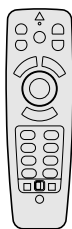

Remote control  
RRMCG1564CESA



Two AA size batteries

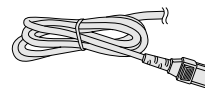

Power cord  
QACCU5013CEZZ

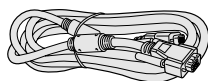

RGB cable  
QCNW-5304CEZZ

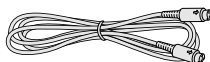

PS/2 mouse control cable  
QCNW-5113CEZZ

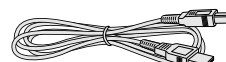

USB mouse control cable  
QCNW-5680CEZZ

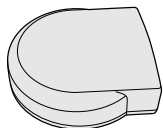

Remote mouse receiver  
RUNT0673CEZZ

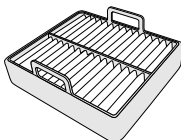

Extra air filter  
PFILD0110CEZZ

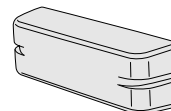

Terminal cover  
CCOVA1789CE01

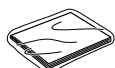

CD-ROM  
UDSKA0030CEN1

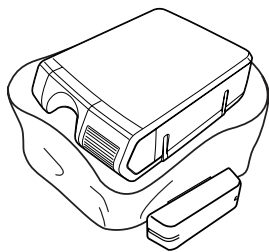

LCD projector operation manual  
TINS-7222CEZZ

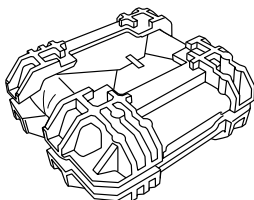

LCD projector quick reference  
TINS-7223CEZZ

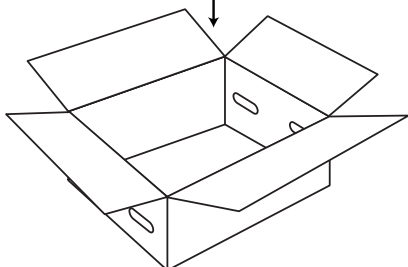

Sharp Advanced Presentation Software operation manual  
TINS-7224CEZZ



# Connections



## Power Supply

### Connecting the Power Cord

Plug the supplied power cord into the AC socket on the side of the projector.

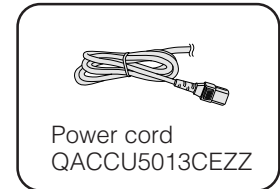
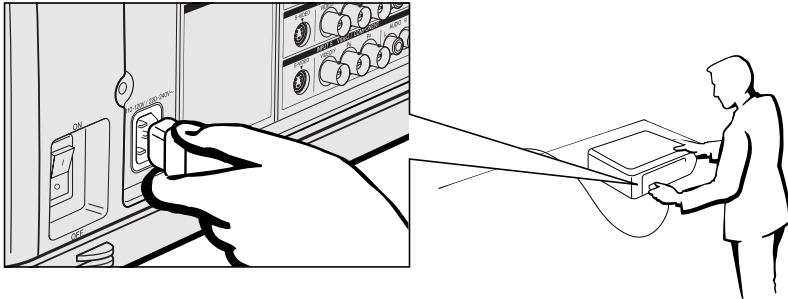

Power cord  
QACCU5013CEZZ



## Projecting Computer Images

### Connecting the Projector to a Computer

You can connect your projector to a computer for projection of full color computer images.

#### Connecting to a computer using the standard 15-pin Input

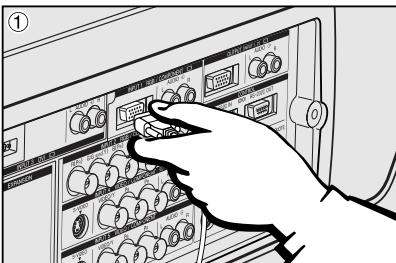

RGB cable  
QCNW-5304CEZZ

- ① Connect one end of the supplied RGB cable to the INPUT 1 port on the projector.
- ② Connect the other end to the monitor output port on the computer. Secure the connectors by tightening the thumb screws.
- ③ To use the built-in audio system, connect one end of the audio cable (sold separately) to the AUDIO INPUT 1 terminal on the projector.
- ④ Connect the other end to the audio output terminal on the computer.

#### CAUTION

- Before connecting, be sure to turn both the projector and the computer off. After making all connections, turn the projector on first. The computer should always be turned on last.

#### NOTE

- Please read the computer's operation manual carefully before making connections.
- Refer to page 84 "Computer Compatibility Chart" for a list of computer signals compatible with the projector. Use with computer signals other than those listed may cause some of the functions not to work.
- A 3.5 mm stereo minijack to stereo RCA audio cable adaptor may be necessary.

When connecting this projector to a computer, select "RGB" for "Signal Type" on the GUI menu. (See page 45.)

#### NOTE

- A Macintosh adaptor may be required for use with some Macintosh computers. Contact your nearest Authorized Sharp Industrial LCD Products Dealer or Service Center.
- AUDIO INPUT 1 can be used to input audio corresponding to the INPUT 1.

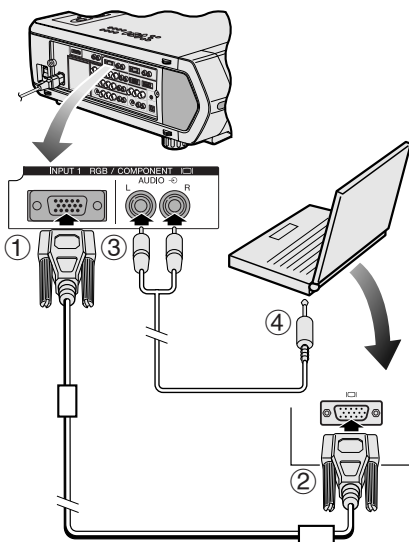



- This projector uses a 5 BNC computer input to prevent deterioration of image quality.
- Connect the R (P<sub>R</sub>), G/G sync (Y), B (P<sub>B</sub>), HD/C sync and VD cables (sold separately) to the correct input terminals on the projector and an RGB switcher (sold separately) connected to the computer, or connect a 5 BNC cable (sold separately) directly from the input terminals on the projector to the computer.

## Connecting to an external RGB switcher or other compatible computers using the BNC Input (Typically used in larger installations)

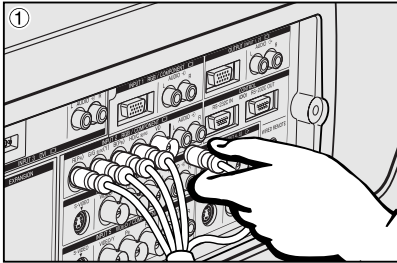

- ① Connect each BNC connector of a 5 BNC cable to the corresponding INPUT 2 terminals on the projector.
- ② Connect the other end of the 5 BNC cable to the corresponding BNC terminals on the external RGB switcher. Connect the RGB switcher to the computer using a RGB cable.
- ③ To use the built-in audio system, connect one end of the audio cable (sold separately) to the AUDIO INPUT 2 terminal on the projector.
- ④ Connect the other end to the audio output terminal on the computer or external audio system.

### NOTE

- A 3.5 mm stereo minijack to stereo RCA audio cable adaptor may be necessary.

When connecting the projector to a compatible computer other than a PC (VGA/SVGA/XGA/SXGA/UXGA) or Macintosh (i.e. Workstation), a separate cable may be needed. Please contact your dealer for more information.

When connecting this projector to a computer, select "RGB" for "Signal Type" on the GUI menu. (See page 45.)

### NOTE

- Connecting computers other than the recommended types may result in damage to the projector, the computer, or both.
- AUDIO INPUT 2 can be used to input audio corresponding to the INPUT 2.

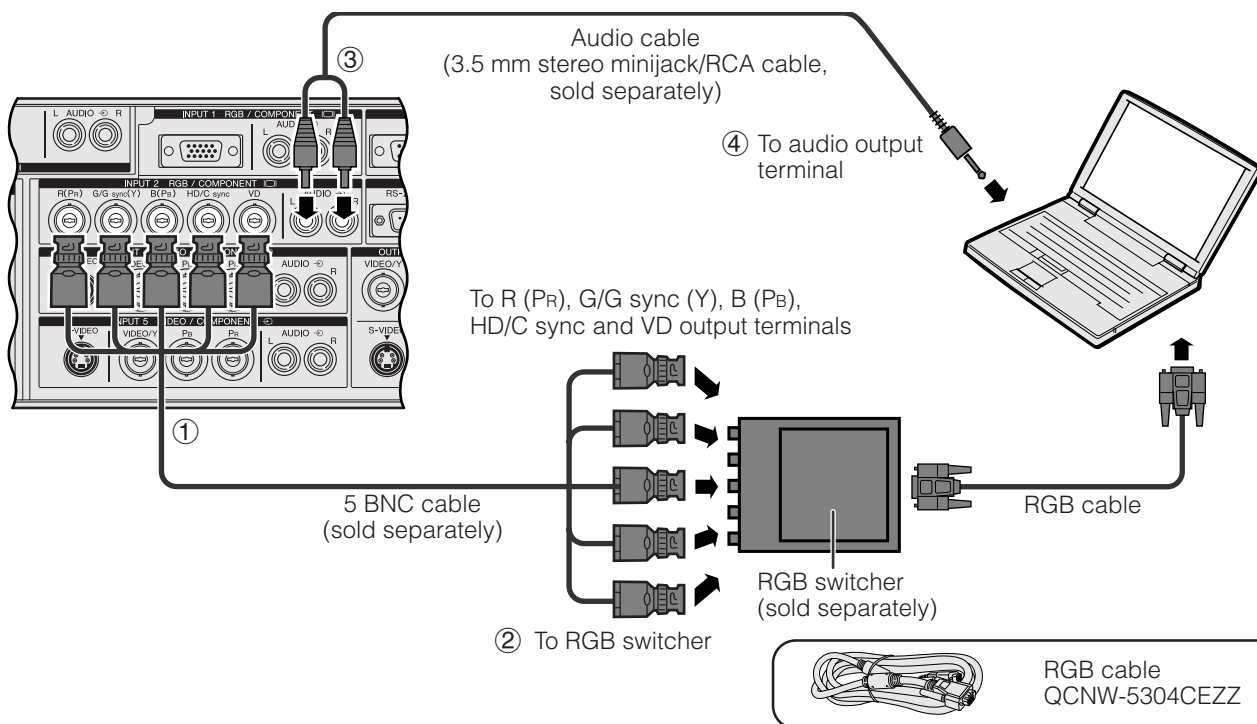

## “Plug and Play” function (when connecting to a 15-pin terminal)

- This projector is compatible with VESA-standard DDC 1/DDC 2B. The projector and a VESA DDC compatible computer will communicate their setting requirements, allowing for quick and easy setup.
- Before using the “Plug and Play” function, be sure to turn on the projector first and the connected computer last.

### NOTE

- The DDC “Plug and Play” function of this projector operates only when used in conjunction with a VESA DDC compatible computer.





## Connecting to a computer using the RS-232C Port

When the RS-232C port on the projector is connected to a computer with an RS-232C cable (null modem, cross type, sold separately), the computer can be used to control the projector and check the status of the projector. See pages 80, 81 and 82 for details.

Connect an RS-232C cable (null modem, cross type, sold separately) to the serial port on the computer.

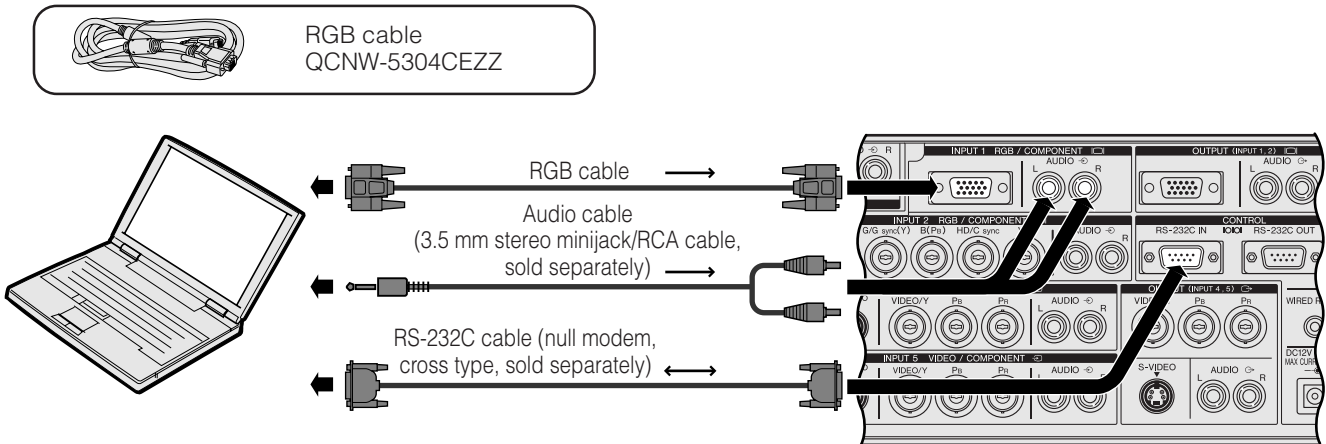

### CAUTION

- Do not connect or disconnect an RS-232C cable to or from the computer while it is on. This may damage your computer.

### NOTE

- The wireless mouse or RS-232C function may not operate if your computer port is not correctly set up. Please refer to the operation manual of the computer for details on setting up/installing the correct mouse driver.
- The arrows (→, ↔) indicate the direction of the signals.
- A Macintosh adaptor may be required for use with some Macintosh computers. Contact your nearest Authorized Sharp Industrial LCD Products Dealer or Service Center.

## Connecting to a computer using the direct digital input port

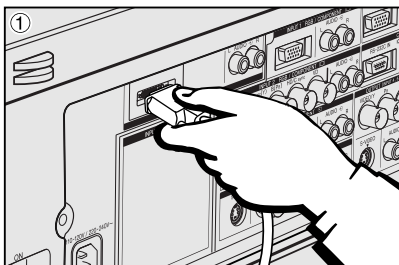

- Connect one end of the DVI cable to the INPUT 3 port on the projector.
- Connect the other end to the corresponding terminal on a computer.
- To use the built-in audio system, connect one end of an audio cable (sold separately) to AUDIO INPUT 3 terminal on the projector.
- Connect the other end to the audio output terminal on the computer.

### NOTE

- This DVI port is DVI version 1.0 compatible. Therefore when the signal is input from copy guard system compatible (DVI version 2.0) equipment, no signal will be received.

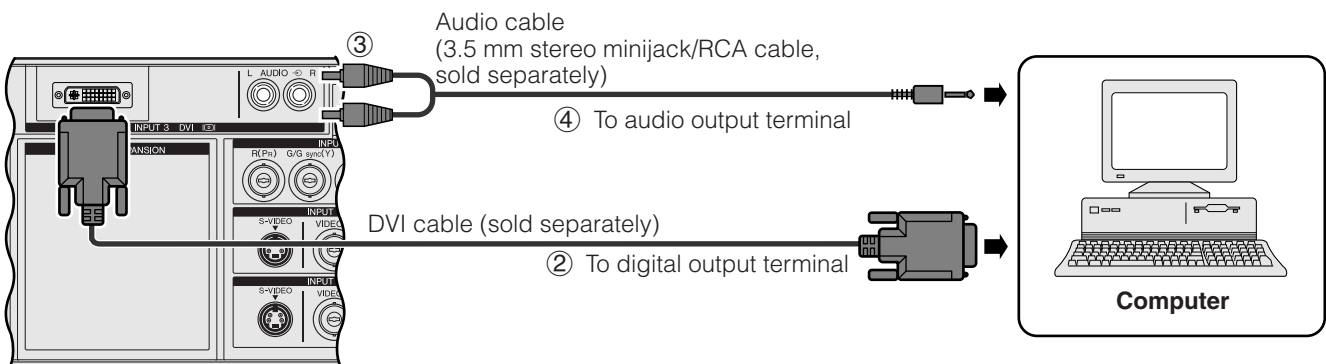



# Watching Video Images and Laser Disc Images

## Connecting to a VCR, laser disc player and other audiovisual equipment using the BNC video Input

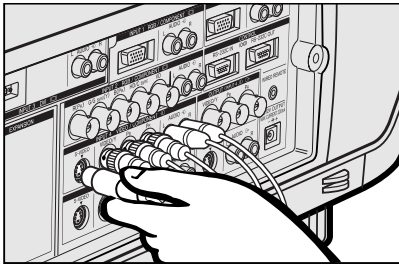

- ① Connect each BNC connector of a component or video cable to the corresponding BNC INPUT 4 or 5 terminals on the projector.

**NOTE**

- BNC-RCA adaptors are needed for use with RCA type cables and sources.

- ② Connect the other end of the cable to the corresponding terminals on a VCR or laser disc player.
- ③ To use the built-in audio system, connect one end of an audio cable (sold separately) to AUDIO INPUT 4 or 5 terminal on the projector.
- ④ Connect the other end to the audio output terminal on the video component.

The S-VIDEO INPUT terminal uses a video signal system in which the picture is separated into a color and a luminance signal to realize a higher-quality image. When cables are connected to both the S-VIDEO INPUT 4 or 5 and VIDEO INPUT 4 or 5 terminals, images input through the S-VIDEO INPUT 4 or 5 terminal have priority over images input through the VIDEO INPUT 4 or 5 terminal.

**NOTE**

- For higher quality video, you may use the S-VIDEO INPUT terminal on the projector. S-video cable is sold separately.
- If your video equipment does not have an S-video output terminal, use a composite video cable.

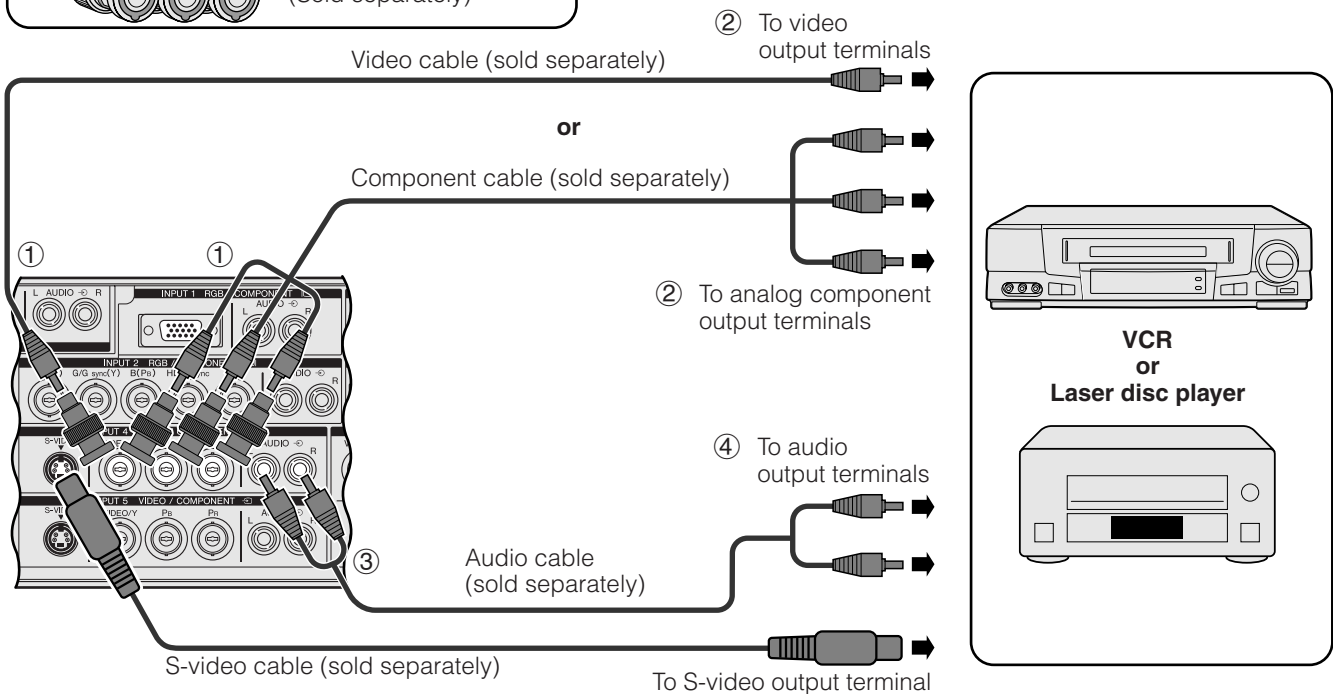

**CAUTION**

- Always turn off the projector before connecting to video equipment, in order to protect both the projector and the equipment being connected.



# Watching DVD and Digital TV Images

## Connecting to a DVD player, DTV decoder and other component video equipment using the 5 BNC Input

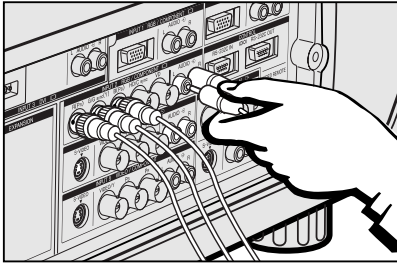

- 1 Connect each BNC connector of a component cable to the corresponding BNC INPUT 2 terminals on the projector.

### NOTE

- BNC-RCA adaptors are needed for use with RCA type cables and sources.

- 2 Connect the other end of the cable to the corresponding terminals on a DVD player or DTV decoder.
- 3 To use the built-in audio system, connect one end of an audio cable (sold separately) to the AUDIO INPUT 2 terminal on the projector.
- 4 Connect the other end to the audio output terminal on the DVD player or DTV decoder.

When connecting this projector to a DVD player or DTV decoder, select "Component" for "Signal Type" on the GUI menu. (See page 45.)

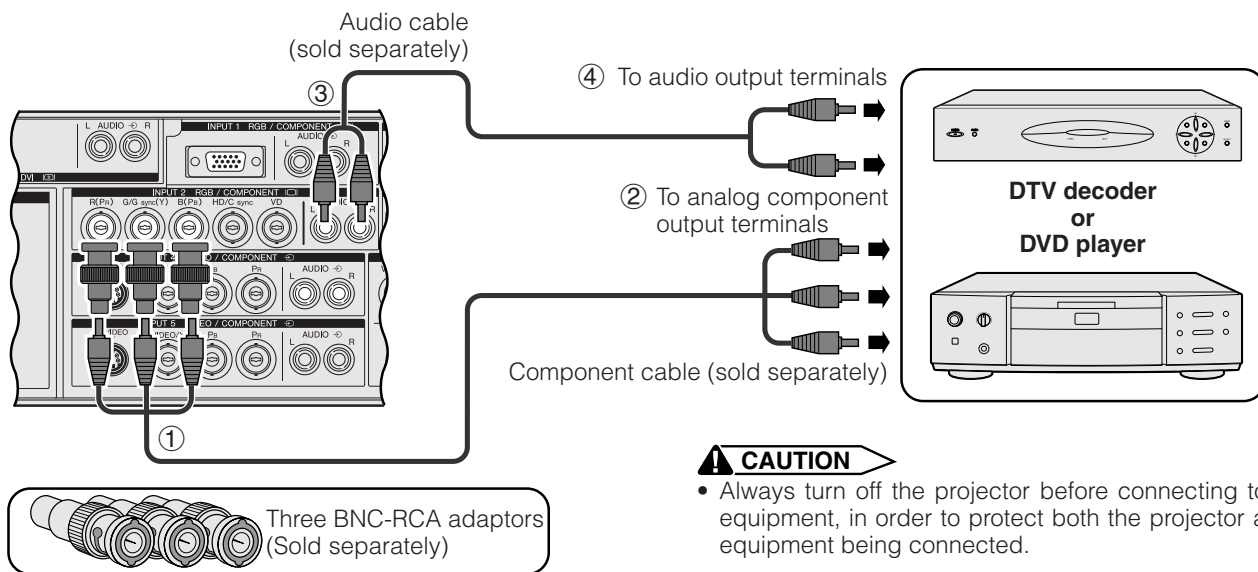

### CAUTION

- Always turn off the projector before connecting to video equipment, in order to protect both the projector and the equipment being connected.



# For Better Sound

## Connecting to an amplifier and other audio components

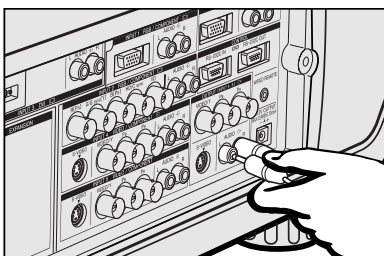

### CAUTION

- Always turn off the projector before connecting to audio components, in order to protect both the projector and the components being connected.

### NOTE

- By using external audio components, the volume can be amplified for better sound.
- The AUDIO OUTPUT terminals allow you to output audio to audio components from the selected AUDIO INPUT 1 to 5 terminals connected to audiovisual equipment.

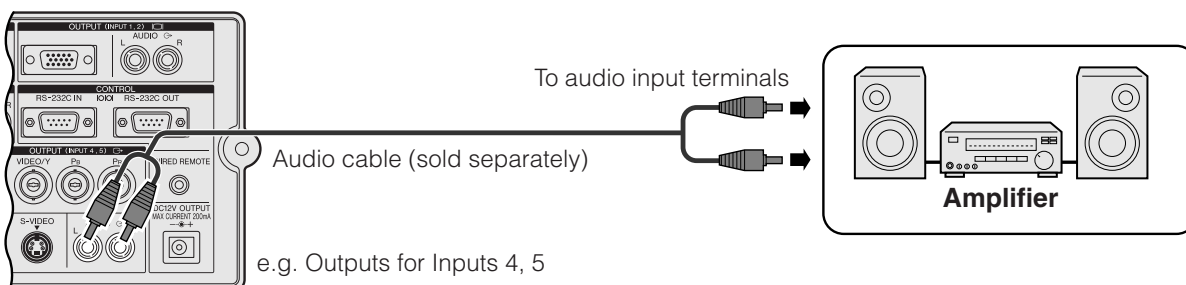



# Power ON/OFF

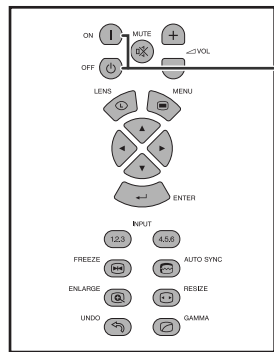
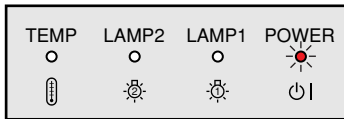
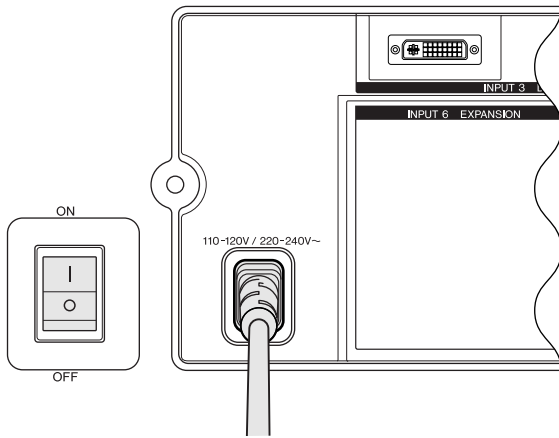

POWER buttons

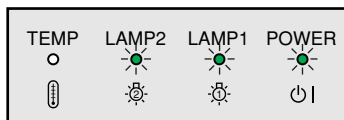
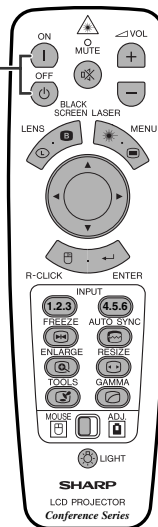

## Turning on the Main Power

Press the MAIN POWER switch on the side of the projector. The POWER indicator lights up red and the projector enters standby mode.

### NOTE

- When the main power is not on, the remote control cannot be used to operate the projector.

## Press POWER ON.

- The flashing green LAMP REPLACEMENT indicator shows that the lamp is warming up. Wait until the indicator stops flashing before operating the projector.
- If the power is turned off and then immediately turned on again, it may take a short while before the lamp turns on.

### NOTE

- After the projector is unpacked and turned on for the first time, a slight odor may be emitted from the exhaust vent. This odor will soon disappear with use.

When the power is on, the LAMP REPLACEMENT indicator lights, indicating the status of the lamp.

**Green:** Lamp is ready.

**Flashing green:** Warming up.

**Red:** Change the lamp.

### NOTE

- When setting the lamp mode to "Lamp 1 only" or "Lamp 2 only", only the LAMP REPLACEMENT indicator corresponding to the lamp set is lit.

## Press POWER OFF.

Press **POWER OFF** again while the message is displayed.

### NOTE

- If you accidentally pressed **POWER OFF** and do not want to turn off the power, wait until the power off screen disappears.
- When **POWER OFF** is pressed twice, the POWER indicator will light up red and the cooling fan will run for about 90 seconds. The projector will then enter standby mode.
- Wait until the cooling fan stops before disconnecting the power cord.
- The power can be turned on again by pressing **POWER ON**. When the power is turned on, the POWER indicator and the LAMP REPLACEMENT indicators light green.
- The POWER indicator flashes if the front filter is not securely installed.





## Setting Up the Screen



## Using the Adjustment Feet

### Using the Adjustment Feet

Rotate feet to adjust height of the projector.

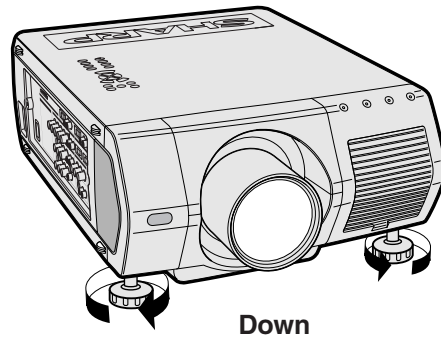
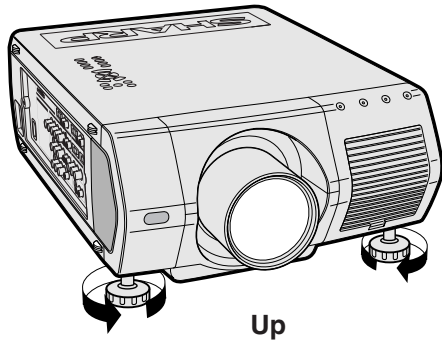

#### NOTE

- The projector is adjustable up to approximately 5° from the standard position.
- When the height of the projector is adjusted, the image may become distorted (keystoned), depending on the relative positions of the projector and the screen.

#### CAUTION

- Do not hold the lens when lifting or lowering the projector.
- When lowering the projector, be careful not to get your fingers caught in the area between the adjustment feet and the projector.





# Adjusting the Projection Distance

Position the projector perpendicular to the screen with all feet flat and level to achieve an optimal image. Move the projector forward or backward if the edges of the image are distorted.

## NOTE

- The projector lens should be centered in the middle of the screen. If the lens center is not perpendicular to the screen, the image will be distorted, making viewing difficult.
- Position the screen so that it is not in direct sunlight or room light. Light falling directly onto the screen washes out colors, making viewing difficult. Close the curtains and dim the lights when setting up the screen in a sunny or bright room.
- A polarizing screen cannot be used with this projector.

Six optional lenses from Sharp are also available for specialized application. Please see your local Sharp Industrial LCD Products Dealer to details on all the lenses. (Refer to the lens operation manual when attaching a lens.) Be sure to have service personnel install optional lenses.

## Throw Distance

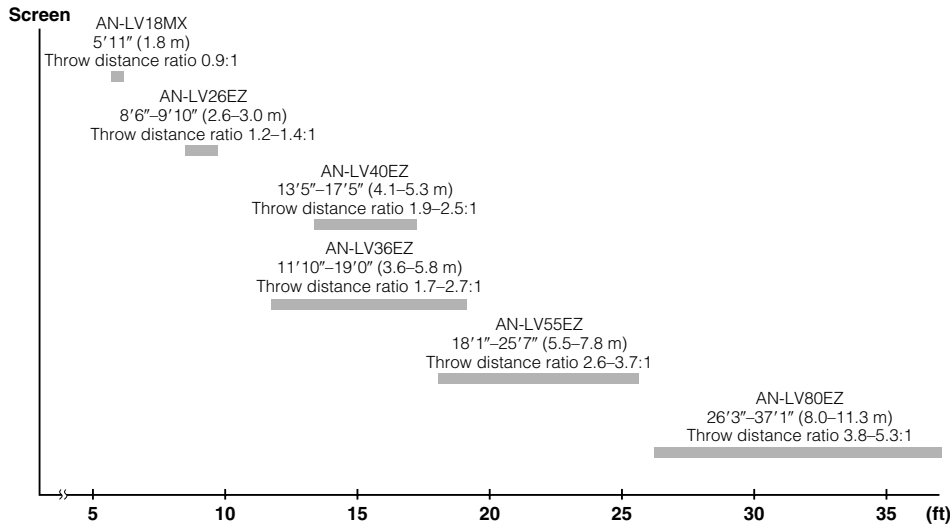

e.g. Screen size: 100 inches (254 cm)  
Computer Input: 4:3

## Standard Setup (Front Projection)

Place the projector at the required distance from the screen according to the desired picture size. (See pages 22-27.)

## NOTE

- Six optional lenses from Sharp are available for specialized application. Please see your local Sharp Industrial LCD Products Dealer for details on all the lenses.

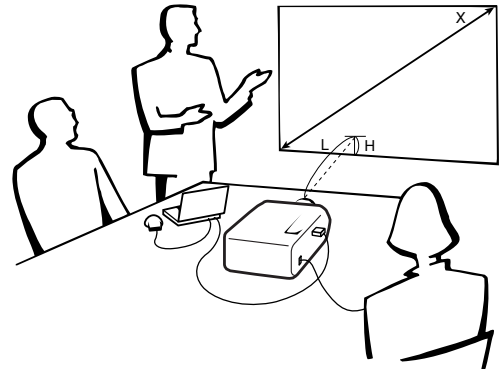

## Computer and Video Input (4:3)

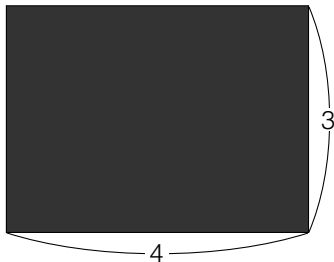

■ : Screen size and Picture size (4:3)

## Video Input (16:9)

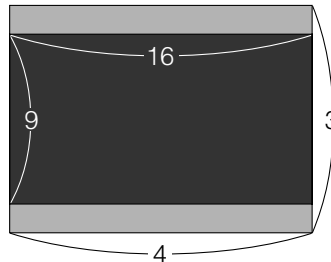

■ : Screen size and Picture size (16:9)  
■ : Signal mask area



## Adjusting the Projection Distance

### AN-LV40EZ

Throw distance ratio  
1.9 to 2.5:1

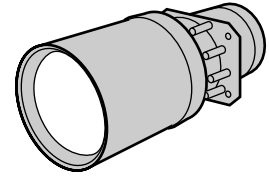

#### Computer and Video Input (4:3)

Screen size (4:3)			Projection distance (L)		Lens center to the lower edge of the screen (H)	
Diag.	Width	Height	Maximum	Minimum	Upper	Lower
600"	480"	360"	106' 8" (32.5 m)	82' 0" (25.0 m)	15' 0" (457.2 cm)	-3' 0" (-91.4 cm)
500"	400"	300"	88' 11" (27.1 m)	68' 3" (20.8 m)	12' 6" (381.0 cm)	-2' 6" (-76.2 cm)
400"	320"	240"	70' 10" (21.6 m)	54' 6" (16.6 m)	10' 0" (304.8 cm)	-2' 0" (-61.0 cm)
300"	240"	180"	53' 2" (16.2 m)	40' 8" (12.4 m)	7' 6" (228.6 cm)	-1' 6" (-45.7 cm)
200"	160"	120"	35' 5" (10.8 m)	27' 3" (8.3 m)	5' 0" (152.4 cm)	-1' 0" (-30.5 cm)
150"	120"	90"	26' 3" (8.0 m)	20' 4" (6.2 m)	3' 9" (114.3 cm)	-9.0" (-22.9 cm)
100"	80"	60"	17' 5" (5.3 m)	13' 5" (4.1 m)	2' 6" (76.2 cm)	-6.0" (-15.2 cm)
84"	67"	50"	14' 9" (4.5 m)	11' 2" (3.4 m)	2' 1" (64.0 cm)	-5.0" (-12.8 cm)
72"	58"	43"	12' 6" (3.8 m)	9' 6" (2.9 m)	1' 10" (54.9 cm)	-4.3" (-11.0 cm)
60"	48"	36"	10' 6" (3.2 m)	7' 10" (2.4 m)	1' 6" (45.7 cm)	-3.6" (-9.1 cm)
40"	32"	24"	6' 11" (2.1 m)	5' 3" (1.6 m)	1' 0" (30.5 cm)	-2.4" (-6.1 cm)

The formula for screen size and projection distance

$$y_1(\text{Max.}) = (0.0544x - 0.1166) \times 3.28$$

$$y_2(\text{Min.}) = (0.0418x - 0.1060) \times 3.28$$

$$z_1(\text{Upper}) = 0.300x$$

$$z_2(\text{Lower}) = -0.060x$$

x: Screen size (diag.) (inches)

y: Projection distance (L) (feet)

z: Lens center to the lower edge of the screen (H) (inches)

#### Video Input (16:9)

Screen size (4:3)			Projection distance (L)		Lens center to the lower edge of the screen (H)	
Diag.	Width	Height	Maximum	Minimum	Upper	Lower
500"	435"	245"	96' 9" (29.5 m)	74' 6" (22.7 m)	10' 3" (311.3 cm)	-6' 2" (-186.8 cm)
400"	348"	196"	77' 5" (23.6 m)	59' 5" (18.1 m)	8' 2" (249.1 cm)	-4' 11" (-149.4 cm)
300"	261"	147"	58' 1" (17.7 m)	44' 3" (13.5 m)	6' 2" (186.8 cm)	-3' 8" (-112.1 cm)
200"	174"	98"	38' 5" (11.7 m)	29' 6" (9.0 m)	4' 1" (124.5 cm)	-2' 5" (-74.7 cm)
150"	131"	74"	28' 10" (8.8 m)	22' 0" (6.7 m)	3' 1" (93.4 cm)	-1' 10" (-56.0 cm)
133"	116"	65"	25' 7" (7.8 m)	19' 8" (6.0 m)	2' 9" (82.8 cm)	-1' 8" (-49.7 cm)
106"	92"	52"	20' 4" (6.2 m)	15' 5" (4.7 m)	2' 2" (66.0 cm)	-1' 4" (-39.6 cm)
100"	87"	49"	19' 0" (5.8 m)	14' 5" (4.4 m)	2' 1" (62.3 cm)	-1' 3" (-37.4 cm)
92"	80"	45"	17' 5" (5.3 m)	13' 5" (4.1 m)	1' 11" (57.3 cm)	-1' 2" (-34.4 cm)
84"	73"	41"	16' 1" (4.9 m)	12' 2" (3.7 m)	1' 9" (52.3 cm)	-1' 0" (-31.4 cm)
72"	63"	35"	13' 9" (4.2 m)	10' 6" (3.2 m)	1' 6" (44.8 cm)	-10.6" (-26.9 cm)
60"	52"	29"	11' 2" (3.4 m)	8' 6" (2.6 m)	1' 3" (37.4 cm)	-8.8" (-22.4 cm)
40"	35"	20"	7' 7" (2.3 m)	5' 7" (1.7 m)	9.8" (24.9 cm)	-5.9" (-14.9 cm)

The formula for screen size and projection distance

$$y_1(\text{Max.}) = (0.0593x - 0.1166) \times 3.28$$

$$y_2(\text{Min.}) = (0.0455x - 0.1060) \times 3.28$$

$$z_1(\text{Upper}) = 0.245x$$

$$z_2(\text{Lower}) = -0.147x$$

x: Screen size (diag.) (inches)

y: Projection distance (L) (feet)

z: Lens center to the lower edge of the screen (H) (inches)

#### NOTE

- There is an error of  $\pm 3\%$  in the formula above.
- Values with a minus (-) sign indicate the distance of the lens center below the bottom of the screen.





## Adjusting the Projection Distance

### AN-LV18MX

Throw distance ratio

0.9 : 1

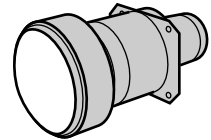

#### Computer and Video Input (4:3)

Screen size (4:3)			Projection distance (L)	Lens center to the lower edge of the screen (H)	
Diag.	Width	Height		Upper	Lower
600"	480"	360"	36' 5" (11.1 m)	15' 0" (457.2 cm)	13' 6" (411.5 cm)
500"	400"	300"	30' 2" (9.2 m)	12' 6" (381.0 cm)	11' 3" (342.9 cm)
400"	320"	240"	24' 3" (7.4 m)	10' 0" (304.8 cm)	9' 0" (274.3 cm)
300"	240"	180"	18' 1" (5.5 m)	7' 6" (228.6 cm)	6' 9" (205.7 cm)
200"	160"	120"	12' 2" (3.7 m)	5' 0" (152.4 cm)	4' 6" (137.2 cm)
150"	120"	90"	8' 10" (2.7 m)	3' 9" (114.3 cm)	3' 5" (102.9 cm)
100"	80"	60"	5' 11" (1.8 m)	2' 6" (76.2 cm)	2' 3" (68.6 cm)
84"	67"	50"	4' 11" (1.5 m)	2' 1" (64.0 cm)	1' 11" (57.6 cm)
72"	58"	43"	4' 3" (1.3 m)	1' 10" (54.9 cm)	1' 7" (49.4 cm)
60"	48"	36"	3' 7" (1.1 m)	1' 6" (45.7 cm)	1' 4" (41.1 cm)
40"	32"	24"	2' 4" (0.7 m)	1' 0" (30.5 cm)	10.8" (27.4 cm)

The formula for screen size and projection distance

$$y = (0.0186x - 0.0561) \times 3.28$$

$$z_1 (\text{Upper}) = 0.300x$$

$$z_2 (\text{Lower}) = 0.270x$$

x: Screen size (diag.) (inches)

y: Projection distance (L) (feet)

z: Lens center to the lower edge of the screen (H) (inches)

#### Video Input (16:9)

Screen size (4:3)			Projection distance (L)	Lens center to the lower edge of the screen (H)	
Diag.	Width	Height		Upper	Lower
500"	435"	245"	33' 2" (10.1 m)	10' 3" (311.3 cm)	8' 10" (269.8 cm)
400"	348"	196"	26' 7" (8.1 m)	8' 2" (249.1 cm)	7' 1" (215.8 cm)
300"	261"	147"	19' 8" (6.0 m)	6' 2" (186.8 cm)	5' 4" (161.9 cm)
200"	174"	98"	13' 1" (4.0 m)	4' 1" (124.5 cm)	3' 6" (107.9 cm)
150"	131"	74"	9' 10" (3.0 m)	3' 1" (93.4 cm)	2' 8" (80.9 cm)
133"	116"	65"	8' 6" (2.6 m)	2' 9" (82.8 cm)	2' 4" (71.8 cm)
106"	92"	52"	6' 11" (2.1 m)	2' 2" (66.0 cm)	1' 11" (57.2 cm)
100"	87"	49"	6' 7" (2.0 m)	2' 1" (62.3 cm)	1' 9" (54.0 cm)
92"	80"	45"	5' 11" (1.8 m)	1' 11" (57.3 cm)	1' 8" (49.6 cm)
84"	73"	41"	5' 7" (1.7 m)	1' 9" (52.3 cm)	1' 6" (45.3 cm)
72"	63"	35"	4' 7" (1.4 m)	1' 6" (44.8 cm)	1' 3" (38.9 cm)
60"	52"	29"	3' 11" (1.2 m)	1' 3" (37.4 cm)	1' 1" (32.4 cm)
40"	35"	20"	2' 7" (0.8 m)	9.8" (24.9 cm)	8.5" (21.6 cm)

The formula for screen size and projection distance

$$y = (0.0203x - 0.0561) \times 3.28$$

$$z_1 (\text{Upper}) = 0.245x$$

$$z_2 (\text{Lower}) = 0.212x$$

x: Screen size (diag.) (inches)

y: Projection distance (L) (feet)

z: Lens center to the lower edge of the screen (H) (inches)

#### NOTE

- There is an error of  $\pm 3\%$  in the formula above.
- Values with a minus (-) sign indicate the distance of the lens center below the bottom of the screen.





## Adjusting the Projection Distance

### AN-LV26EZ

Throw distance ratio  
1.2 to 1.4 :1

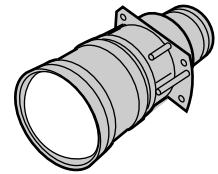

#### Computer and Video Input (4:3)

Screen size (4:3)			Projection distance (L)		Lens center to the lower edge of the screen (H)	
Diag.	Width	Height	Maximum	Minimum	Upper	Lower
600"	480"	360"	60' 8" (18.5 m)	52' 10" (16.1 m)	15' 0" (457.2 cm)	0.0" (0.0 cm)
500"	400"	300"	50' 6" (15.4 m)	44' 0" (13.4 m)	12' 6" (381.0 cm)	0.0" (0.0 cm)
400"	320"	240"	40' 4" (12.3 m)	35' 1" (10.7 m)	10' 0" (304.8 cm)	0.0" (0.0 cm)
300"	240"	180"	30' 2" (9.2 m)	26' 3" (8.0 m)	7' 6" (228.6 cm)	0.0" (0.0 cm)
200"	160"	120"	20' 0" (6.1 m)	17' 5" (5.3 m)	5' 0" (152.4 cm)	0.0" (0.0 cm)
150"	120"	90"	15' 1" (4.6 m)	13' 1" (4.0 m)	3' 9" (114.3 cm)	0.0" (0.0 cm)
100"	80"	60"	9' 10" (3.0 m)	8' 6" (2.6 m)	2' 6" (76.2 cm)	0.0" (0.0 cm)
84"	67"	50"	8' 2" (2.5 m)	7' 3" (2.2 m)	2' 1" (64.0 cm)	0.0" (0.0 cm)
72"	58"	43"	6' 11" (2.1 m)	6' 3" (1.9 m)	1' 10" (54.9 cm)	0.0" (0.0 cm)
60"	48"	36"	5' 11" (1.8 m)	4' 11" (1.5 m)	1' 6" (45.7 cm)	0.0" (0.0 cm)
40"	32"	24"	3' 11" (1.2 m)	3' 3" (1.0 m)	1' 0" (30.5 cm)	0.0" (0.0 cm)

The formula for screen size and projection distance

$$y_1 (\text{Max.}) = (0.0310x - 0.0841) \times 3.28$$

$$y_2 (\text{Min.}) = (0.0269x - 0.0841) \times 3.28$$

$$z_1 (\text{Upper}) = 0.300x$$

$$z_2 (\text{Lower}) = 0$$

x: Screen size (diag.) (inches)

y: Projection distance (L) (feet)

z: Lens center to the lower edge of the screen (H) (inches)

#### Video Input (16:9)

Screen size (4:3)			Projection distance (L)		Lens center to the lower edge of the screen (H)	
Diag.	Width	Height	Maximum	Minimum	Upper	Lower
500"	435"	245"	55' 1" (16.8 m)	47' 11" (14.6 m)	10' 3" (311.3 cm)	-3' 5" (-103.8 cm)
400"	348"	196"	44' 0" (13.4 m)	38' 1" (11.6 m)	8' 2" (249.1 cm)	-2' 9" (-83.0 cm)
300"	261"	147"	33' 2" (10.1 m)	28' 7" (8.7 m)	6' 2" (186.8 cm)	-2' 1" (-62.3 cm)
200"	174"	98"	22' 0" (6.7 m)	19' 0" (5.8 m)	4' 1" (124.5 cm)	-1' 4" (-41.5 cm)
150"	131"	74"	16' 5" (5.0 m)	14' 1" (4.3 m)	3' 1" (93.4 cm)	-1' 0" (-31.1 cm)
133"	116"	65"	14' 5" (4.4 m)	12' 6" (3.8 m)	2' 9" (82.8 cm)	-10.9" (-27.6 cm)
106"	92"	52"	11' 6" (3.5 m)	9' 10" (3.0 m)	2' 2" (66.0 cm)	-8.7" (-22.0 cm)
100"	87"	49"	10' 10" (3.3 m)	9' 6" (2.9 m)	2' 1" (62.3 cm)	-8.2" (-20.8 cm)
92"	80"	45"	9' 10" (3.0 m)	8' 6" (2.6 m)	1' 11" (57.3 cm)	-7.5" (-19.1 cm)
84"	73"	41"	9' 2" (2.8 m)	7' 10" (2.4 m)	1' 9" (52.3 cm)	-6.9" (-17.4 cm)
72"	63"	35"	7' 10" (2.4 m)	6' 7" (2.0 m)	1' 6" (44.8 cm)	-5.9" (-14.9 cm)
60"	52"	29"	6' 3" (1.9 m)	5' 7" (1.7 m)	1' 3" (37.4 cm)	-4.9" (-12.5 cm)
40"	35"	20"	4' 3" (1.3 m)	3' 7" (1.1 m)	9.8" (24.9 cm)	-3.3" (-8.3 cm)

The formula for screen size and projection distance

$$y_1 (\text{Max.}) = (0.0338x - 0.0841) \times 3.28$$

$$y_2 (\text{Min.}) = (0.0293x - 0.0841) \times 3.28$$

$$z_1 (\text{Upper}) = 0.245x$$

$$z_2 (\text{Lower}) = -0.082x$$

x: Screen size (diag.) (inches)

y: Projection distance (L) (feet)

z: Lens center to the lower edge of the screen (H) (inches)

#### NOTE

- There is an error of  $\pm 3\%$  in the formula above.
- Values with a minus (-) sign indicate the distance of the lens center below the bottom of the screen.





## Adjusting the Projection Distance

### AN-LV36EZ

Throw distance ratio  
1.7 to 2.7 :1

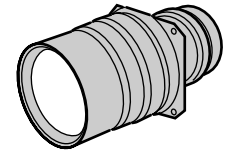

#### Computer and Video Input (4:3)

Screen size (4:3)			Projection distance (L)		Lens center to the lower edge of the screen (H)	
Diag.	Width	Height	Maximum	Minimum	Upper	Lower
600"	480"	360"	115' 10" (35.3 m)	72' 6" (22.1 m)	15' 0" (457.2 cm)	0.0" (0.0 cm)
500"	400"	300"	96' 5" (29.4 m)	60' 4" (18.4 m)	12' 6" (381.0 cm)	0.0" (0.0 cm)
400"	320"	240"	77' 1" (23.5 m)	48' 3" (14.7 m)	10' 0" (304.8 cm)	0.0" (0.0 cm)
300"	240"	180"	57' 9" (17.6 m)	36' 1" (11.0 m)	7' 6" (228.6 cm)	0.0" (0.0 cm)
200"	160"	120"	38' 5" (11.7 m)	23' 11" (7.3 m)	5' 0" (152.4 cm)	0.0" (0.0 cm)
150"	120"	90"	28' 7" (8.7 m)	18' 1" (5.5 m)	3' 9" (114.3 cm)	0.0" (0.0 cm)
100"	80"	60"	19' 0" (5.8 m)	11' 10" (3.6 m)	2' 6" (76.2 cm)	0.0" (0.0 cm)
84"	67"	50"	15' 9" (4.8 m)	9' 10" (3.0 m)	2' 1" (64.0 cm)	0.0" (0.0 cm)
72"	58"	43"	13' 5" (4.1 m)	8' 6" (2.6 m)	1' 10" (54.9 cm)	0.0" (0.0 cm)
60"	48"	36"	11' 2" (3.4 m)	6' 11" (2.1 m)	1' 6" (45.7 cm)	0.0" (0.0 cm)
40"	32"	24"	7' 3" (2.2 m)	4' 7" (1.4 m)	1' 0" (30.5 cm)	0.0" (0.0 cm)

The formula for screen size and projection distance

$$y_1(\text{Max.}) = (0.0591x - 0.1391) \times 3.28$$

$$y_2(\text{Min.}) = (0.0370x - 0.0804) \times 3.28$$

$$z_1(\text{Upper}) = 0.300x$$

$$z_2(\text{Lower}) = 0$$

x: Screen size (diag.) (inches)

y: Projection distance (L) (feet)

z: Lens center to the lower edge of the screen (H) (inches)

#### Video Input (16:9)

Screen size (4:3)			Projection distance (L)		Lens center to the lower edge of the screen (H)	
Diag.	Width	Height	Maximum	Minimum	Upper	Lower
500"	435"	245"	105' 4" (32.1 m)	65' 11" (20.1 m)	10' 3" (311.3 cm)	-3' 5" (-103.8 cm)
400"	348"	196"	84' 0" (25.6 m)	52' 6" (16.0 m)	8' 2" (249.1 cm)	-2' 9" (-83.0 cm)
300"	261"	147"	63' 0" (19.2 m)	39' 4" (12.0 m)	6' 2" (186.8 cm)	-2' 1" (-62.3 cm)
200"	174"	98"	41' 8" (12.7 m)	26' 3" (8.0 m)	4' 1" (124.5 cm)	-1' 4" (-41.5 cm)
150"	131"	74"	31' 2" (9.5 m)	19' 8" (6.0 m)	3' 1" (93.4 cm)	-1' 0" (-31.1 cm)
133"	116"	65"	27' 7" (8.4 m)	17' 5" (5.3 m)	2' 9" (82.8 cm)	-10.9" (-27.6 cm)
106"	92"	52"	22' 0" (6.7 m)	13' 9" (4.2 m)	2' 2" (66.0 cm)	-8.7" (-22.0 cm)
100"	87"	49"	20' 8" (6.3 m)	13' 1" (4.0 m)	2' 1" (62.3 cm)	-8.2" (-20.8 cm)
92"	80"	45"	19' 0" (5.8 m)	11' 10" (3.6 m)	1' 11" (57.3 cm)	-7.5" (-19.1 cm)
84"	73"	41"	17' 5" (5.3 m)	10' 10" (3.3 m)	1' 9" (52.3 cm)	-6.9" (-17.4 cm)
72"	63"	35"	14' 9" (4.5 m)	9' 2" (2.8 m)	1' 6" (44.8 cm)	-5.9" (-14.9 cm)
60"	52"	29"	12' 2" (3.7 m)	7' 7" (2.3 m)	1' 3" (37.4 cm)	-4.9" (-12.5 cm)
40"	35"	20"	7' 10" (2.4 m)	4' 11" (1.5 m)	9.8" (24.9 cm)	-3.3" (-8.3 cm)

The formula for screen size and projection distance

$$y_1(\text{Max.}) = (0.0644x - 0.1391) \times 3.28$$

$$y_2(\text{Min.}) = (0.0403x - 0.0804) \times 3.28$$

$$z_1(\text{Upper}) = 0.245x$$

$$z_2(\text{Lower}) = -0.082x$$

x: Screen size (diag.) (inches)

y: Projection distance (L) (feet)

z: Lens center to the lower edge of the screen (H) (inches)

#### NOTE

- There is an error of  $\pm 3\%$  in the formula above.
- Values with a minus (-) sign indicate the distance of the lens center below the bottom of the screen.





## Adjusting the Projection Distance

### AN-LV55EZ

Throw distance ratio  
2.6 to 3.7 :1

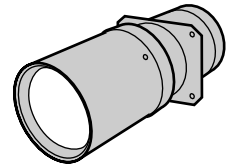

#### Computer and Video Input (4:3)

Screen size (4:3)			Projection distance (L)		Lens center to the lower edge of the screen (H)	
Diag.	Width	Height	Maximum	Minimum	Upper	Lower
600"	480"	360"	156' 2" (47.6 m)	111' 7" (34.0 m)	15' 0" (457.2 cm)	0.0" (0.0 cm)
500"	400"	300"	130' 3" (39.7 m)	92' 10" (28.3 m)	12' 6" (381.0 cm)	0.0" (0.0 cm)
400"	320"	240"	104' 0" (31.7 m)	74' 2" (22.6 m)	10' 0" (304.8 cm)	0.0" (0.0 cm)
300"	240"	180"	77' 9" (23.7 m)	55' 5" (16.9 m)	7' 6" (228.6 cm)	0.0" (0.0 cm)
200"	160"	120"	51' 10" (15.8 m)	36' 9" (11.2 m)	5' 0" (152.4 cm)	0.0" (0.0 cm)
150"	120"	90"	38' 9" (11.8 m)	27' 7" (8.4 m)	3' 9" (114.3 cm)	0.0" (0.0 cm)
100"	80"	60"	25' 7" (7.8 m)	18' 1" (5.5 m)	2' 6" (76.2 cm)	0.0" (0.0 cm)
84"	67"	50"	21' 4" (6.5 m)	15' 1" (4.6 m)	2' 1" (64.0 cm)	0.0" (0.0 cm)

The formula for screen size and projection distance

$$y_1 (\text{Max.}) = (0.0797x - 0.1868) \times 3.28$$

$$y_2 (\text{Min.}) = (0.0569x - 0.1862) \times 3.28$$

$$z_1 (\text{Upper}) = 0.300x$$

$$z_2 (\text{Lower}) = 0$$

x: Screen size (diag.) (inches)

y: Projection distance (L) (feet)

z: Lens center to the lower edge of the screen (H) (inches)

#### Video Input (16:9)

Screen size (4:3)			Projection distance (L)		Lens center to the lower edge of the screen (H)	
Diag.	Width	Height	Maximum	Minimum	Upper	Lower
500"	435"	245"	141' 9" (43.2 m)	101' 1" (30.8 m)	10' 3" (311.3 cm)	-3' 5" (-103.8 cm)
400"	348"	196"	113' 2" (34.5 m)	80' 9" (24.6 m)	8' 2" (249.1 cm)	-2' 9" (-83.0 cm)
300"	261"	147"	85' 0" (25.9 m)	60' 4" (18.4 m)	6' 2" (186.8 cm)	-2' 1" (-62.3 cm)
200"	174"	98"	56' 5" (17.2 m)	40' 0" (12.2 m)	4' 1" (124.5 cm)	-1' 4" (-41.5 cm)
150"	131"	74"	42' 0" (12.8 m)	29' 10" (9.1 m)	3' 1" (93.4 cm)	-1' 0" (-31.1 cm)
133"	116"	65"	37' 5" (11.4 m)	26' 7" (8.1 m)	2' 9" (82.8 cm)	-10.9" (-27.6 cm)
106"	92"	52"	29' 6" (9.0 m)	21' 0" (6.4 m)	2' 2" (66.0 cm)	-8.9" (-22.0 cm)
100"	87"	49"	27' 11" (8.5 m)	19' 8" (6.0 m)	2' 1" (62.3 cm)	-8.2" (-20.8 cm)
92"	80"	45"	25' 7" (7.8 m)	18' 1" (5.5 m)	1' 11" (57.3 cm)	-7.5" (-19.1 cm)
84"	73"	41"	23' 4" (7.1 m)	16' 5" (5.0 m)	1' 9" (52.3 cm)	-6.9" (-17.4 cm)

The formula for screen size and projection distance

$$y_1 (\text{Max.}) = (0.0868x - 0.1868) \times 3.28$$

$$y_2 (\text{Min.}) = (0.0620x - 0.1862) \times 3.28$$

$$z_1 (\text{Upper}) = 0.245x$$

$$z_2 (\text{Lower}) = -0.082x$$

x: Screen size (diag.) (inches)

y: Projection distance (L) (feet)

z: Lens center to the lower edge of the screen (H) (inches)

#### NOTE

- There is an error of  $\pm 3\%$  in the formula above.
- Values with a minus (-) sign indicate the distance of the lens center below the bottom of the screen.





## Adjusting the Projection Distance

### AN-LV80EZ

Throw distance ratio  
3.8 to 5.3 :1

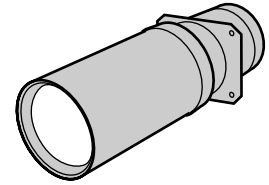

#### Computer and Video Input (4:3)

Screen size (4:3)			Projection distance (L)		Lens center to the lower edge of the screen (H)	
Diag.	Width	Height	Maximum	Minimum	Upper	Lower
600"	480"	360"	224' 5" (68.4 m)	160' 1" (48.8 m)	15' 0" (457.2 cm)	0.0" (0.0 cm)
500"	400"	300"	186' 8" (56.9 m)	133' 2" (40.6 m)	12' 6" (381.0 cm)	0.0" (0.0 cm)
400"	320"	240"	149' 3" (45.5 m)	106' 8" (32.5 m)	10' 0" (304.8 cm)	0.0" (0.0 cm)
300"	240"	180"	111' 11" (34.1 m)	79' 9" (24.3 m)	7' 6" (228.6 cm)	0.0" (0.0 cm)
200"	160"	120"	74' 6" (22.7 m)	53' 2" (16.2 m)	5' 0" (152.4 cm)	0.0" (0.0 cm)
150"	120"	90"	55' 9" (17.0 m)	39' 8" (12.1 m)	3' 9" (114.3 cm)	0.0" (0.0 cm)
100"	80"	60"	37' 1" (11.3 m)	26' 3" (8.0 m)	2' 6" (76.2 cm)	0.0" (0.0 cm)
84"	67"	50"	30' 10" (9.4 m)	22' 0" (6.7 m)	2' 1" (64.0 cm)	0.0" (0.0 cm)

The formula for screen size and projection distance

$$y_1 (\text{Max.}) = (0.1142x - 0.1593) \times 3.28$$

$$y_2 (\text{Min.}) = (0.0816x - 0.1592) \times 3.28$$

$$z_1 (\text{Upper}) = 0.300x$$

$$z_2 (\text{Lower}) = 0$$

x: Screen size (diag.) (inches)

y: Projection distance (L) (feet)

z: Lens center to the lower edge of the screen (H) (inches)

#### Video Input (16:9)

Screen size (4:3)			Projection distance (L)		Lens center to the lower edge of the screen (H)	
Diag.	Width	Height	Maximum	Minimum	Upper	Lower
500"	435"	245"	203' 5" (62.0 m)	145' 4" (44.3 m)	10' 3" (311.3 cm)	-3' 5" (-103.8 cm)
400"	348"	196"	162' 9" (49.6 m)	116' 2" (35.4 m)	8' 2" (249.1 cm)	-2' 9" (-83.0 cm)
300"	261"	147"	122' 1" (37.2 m)	86' 11" (26.5 m)	6' 2" (186.8 cm)	-2' 1" (-62.3 cm)
200"	174"	98"	81' 0" (24.7 m)	57' 9" (17.6 m)	4' 1" (124.5 cm)	-1' 4" (-41.5 cm)
150"	131"	74"	60' 8" (18.5 m)	43' 4" (13.2 m)	3' 1" (93.4 cm)	-1' 0" (-31.1 cm)
133"	116"	65"	53' 10" (16.4 m)	38' 5" (11.7 m)	2' 9" (82.8 cm)	-10.9" (-27.6 cm)
106"	92"	52"	42' 8" (13.0 m)	30' 6" (9.3 m)	2' 2" (66.0 cm)	-8.7" (-22.0 cm)
100"	87"	49"	40' 4" (12.3 m)	28' 7" (8.7 m)	2' 1" (62.3 cm)	-8.2" (-20.8 cm)
92"	80"	45"	37' 1" (11.3 m)	26' 3" (8.0 m)	1' 11" (57.3 cm)	-7.5" (-19.1 cm)
84"	73"	41"	33' 10" (10.3 m)	23' 11" (7.3 m)	1' 9" (52.3 cm)	-6.9" (-17.4 cm)

The formula for screen size and projection distance

$$y_1 (\text{Max.}) = (0.1244x - 0.1593) \times 3.28$$

$$y_2 (\text{Min.}) = (0.0889x - 0.1592) \times 3.28$$

$$z_1 (\text{Upper}) = 0.245x$$

$$z_2 (\text{Lower}) = -0.082x$$

x: Screen size (diag.) (inches)

y: Projection distance (L) (feet)

z: Lens center to the lower edge of the screen (H) (inches)

#### NOTE

- There is an error of  $\pm 3\%$  in the formula above.
- Values with a minus (-) sign indicate the distance of the lens center below the bottom of the screen.





### Upper and Lower Lens Shift Position

- This projector is equipped with a lens shift function that lets you adjust the projection height.
- Adjust to match the setup configuration.

Screen size: 100 inches (254 cm)  
 Computer and Video Input: 4:3  
 AN-LV40EZ as an example

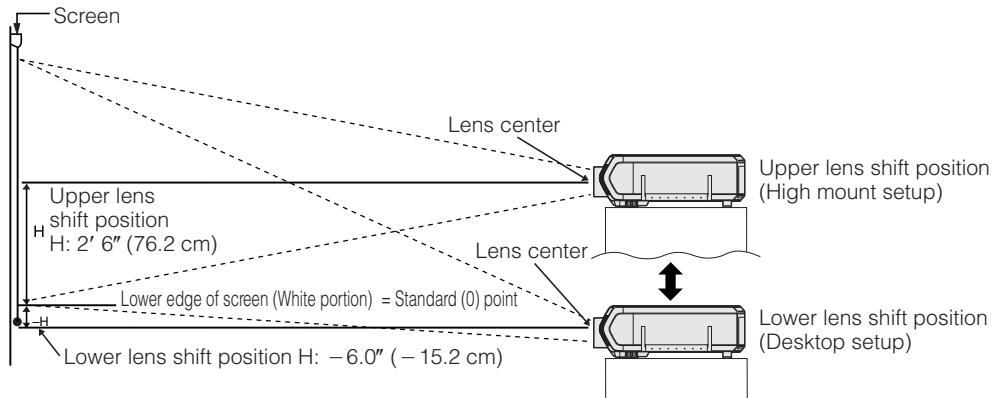

### Upper and Lower Lens Shift Position (Ceiling Mount)

When the projector is in the inverted position, use the upper edge of the screen as the base line, and exchange the lower and upper lens shift values.

Screen size: 100 inches (254 cm)  
 Computer and Video Input: 4:3  
 AN-LV40EZ as an example

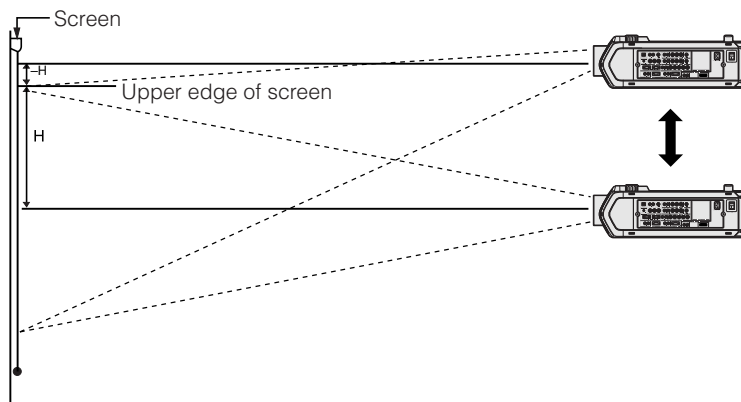

#### NOTE

- Optimal image quality is produced with the projector positioned perpendicular to the screen with all feet flat and level. Tilting or angling the projector will reduce the effectiveness of the lens shift function.



# LENS Button

## Projector

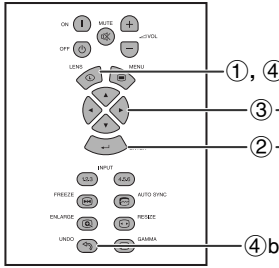

## Remote Control

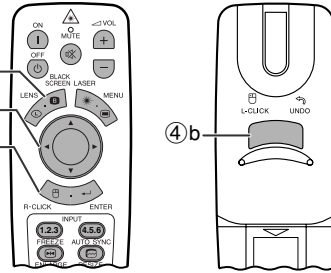

### On-screen Display (Example: 4:3 NORMAL image)

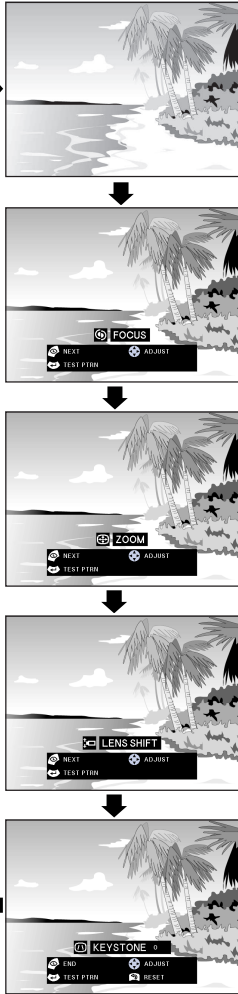

### On-screen Display (Example: 16:9 WIDE image)

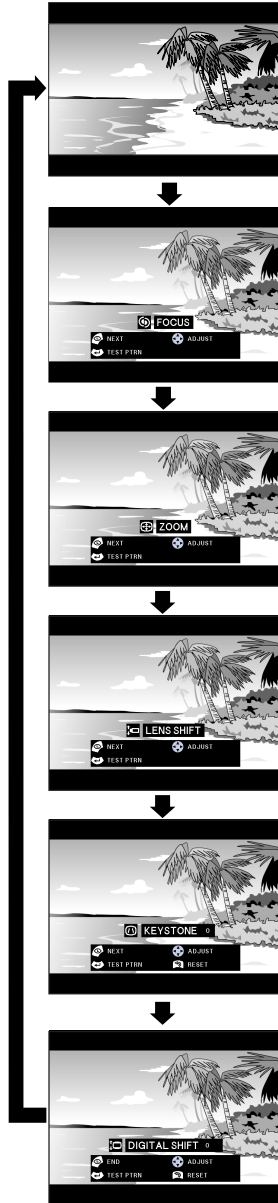

## Digital Image Adjustments

This function can be used to adjust the focus, zoom, lens shift, keystone and digital shift settings.

(Slide the **MOUSE/ADJUSTMENT** switch on the remote control to the ADJ. position.)



- ① Press **LENS** to select mode. Each time **LENS** is pressed, the screen changes as shown on the left.
- ② Press **ENTER** to display test pattern.
- ③ Press **▲/▼/◀▶** to make adjustments.
- ④ a. Press **LENS** until normal screen appears.  
b. To reset the "KEYSTONE" and "DIGITAL SHIFT" setting, press **UNDO**.

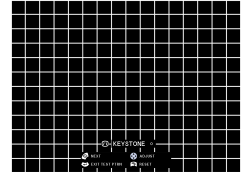

### NOTE

- At first when the button is pushed, "LENS SHIFT" function moves slowly allowing for fine adjustments to be made. Keep holding the button to move it faster.
- Straight lines and the edges of the displayed image may appear jagged, when adjusting the KEYSTONE setting.
- Do not touch the lens when adjusting the focus or zoom.
- Digital shift function only works with BORDER, STRETCH or SMART STRETCH of VIDEO and DTV inputs. (See page 34 for details.) The DIGITAL SHIFT screen is not displayed when projecting images other than WIDE.

### Digital Shift

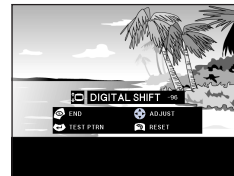

Press ▲.

or



Press ▼.



## Image Projection



### Rear Projection

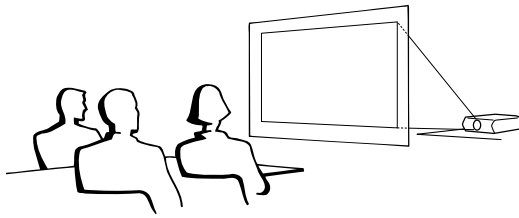

- Place a translucent screen between the projector and the audience.
- Use the projector's menu system to reverse the projected image. (See page 56 for use of this function.)

#### NOTE

- Optimal image quality can be achieved when the projector is positioned perpendicular to the screen with all feet flat and level.



### Projection Using a Mirror

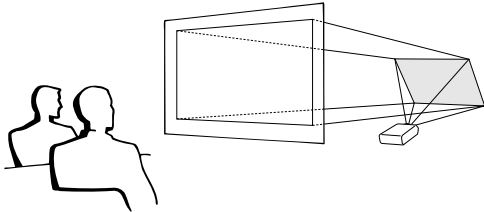

- When the distance between the projector and screen is not sufficient for normal rear projection, you can use a mirror to reflect the image onto the screen.
- Place a mirror (normal flat type) in front of the lens.
- Project the normal image onto the mirror.
- The image reflected from the mirror is projected onto the translucent screen.

#### CAUTION

- When using a mirror, be sure to carefully position both the projector and the mirror so the light does not shine into the eyes of the audience.



### Ceiling-mount Projection

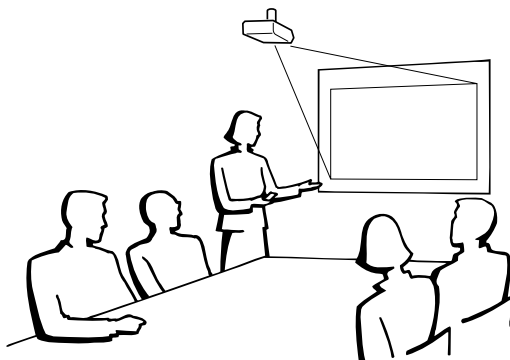

- It is recommended that you use the optional Sharp ceiling-mount bracket for this installation.
- Before mounting the projector, contact your nearest Authorized Sharp Industrial LCD Products Dealer or Service Center to obtain the recommended ceiling-mount bracket (sold separately). (AN-XGCM70 ceiling-mount bracket, AN-EP101AP extension tube for AN-XGCM70.)
- When the projector is in the inverted position, use the upper edge of the screen as the base line.
- Use the projector's menu system to select the appropriate projection mode. (See page 56 for use of this function.)





# Using the Operation Buttons



## Selecting the Input Signal Source

### Projector

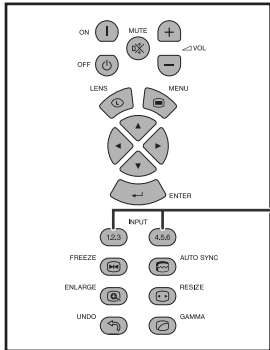

### Remote Control

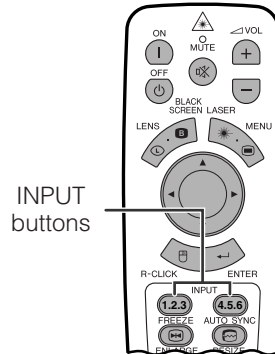

Press **INPUT 1.2.3** or **INPUT 4.5.6** again to change the mode.

#### NOTE

- When no signal is received, "NO SIGNAL" will be displayed.
- When a signal that the projector is not preset to receive is received, "NOT REG." will be displayed.

### On-screen Display

#### INPUT 1 Mode



#### INPUT 2 Mode



#### INPUT 3 Mode



#### INPUT 4 Mode



#### INPUT 5 Mode



#### INPUT 6 Mode



## Adjusting the Volume

### Projector

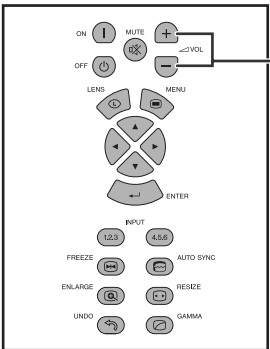

### Remote Control

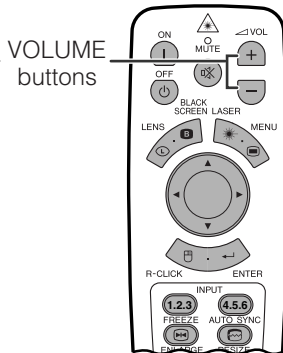

Press **VOLUME +/-** to adjust the volume.

### On-screen Display

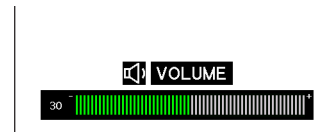

## Muting the Sound

### Projector

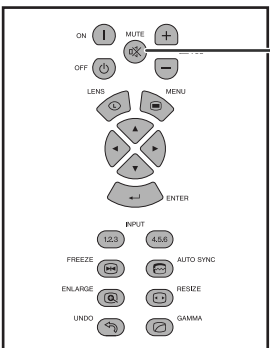

### Remote Control

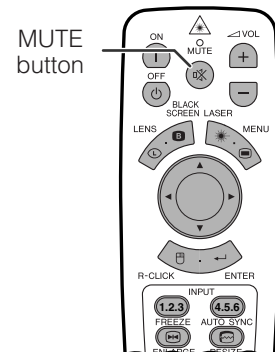

Press **MUTE** to temporarily turn off the sound. Press **MUTE** again to turn the sound back on.

### On-screen Display







# Superimposing a Black Screen

## Projector

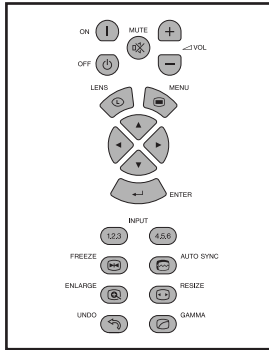

## Remote Control

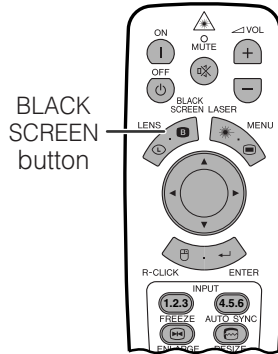

This function can be used to superimpose a black screen over the projected image.

### Blacking out the Projected Image

Press **BLACK SCREEN**. The screen turns black and "BLACK SCREEN" is displayed on the screen. To return to the original projected image, press **BLACK SCREEN** again.

#### NOTE

- To use the remote control to operate this function, slide the **MOUSE/ADJUSTMENT** switch to the **MOUSE** position before pressing **BLACK SCREEN**.

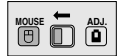

## Projected Image

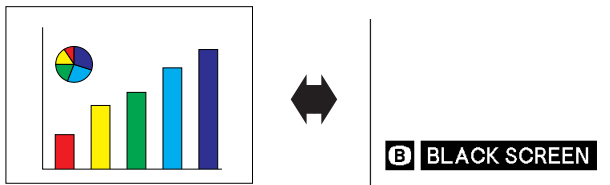

# Displaying a Still Image

## Projector

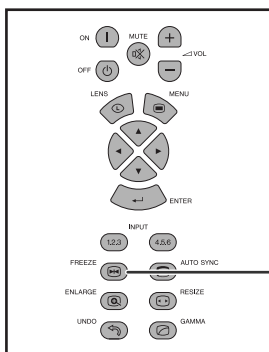

## Remote Control

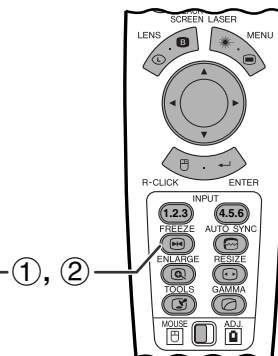

This function allows you to instantly freeze a moving image. This is useful when you want to display a still image from a computer or video, giving you more time to explain the image to the audience.

You can also use this function to display a still image from a computer while you make preparations for the next computer images to be presented.

- Press **FREEZE** to freeze the image.
- Press **FREEZE** again to return to the moving image.

## On-screen Display





# Magnifying a Specific Portion of an Image

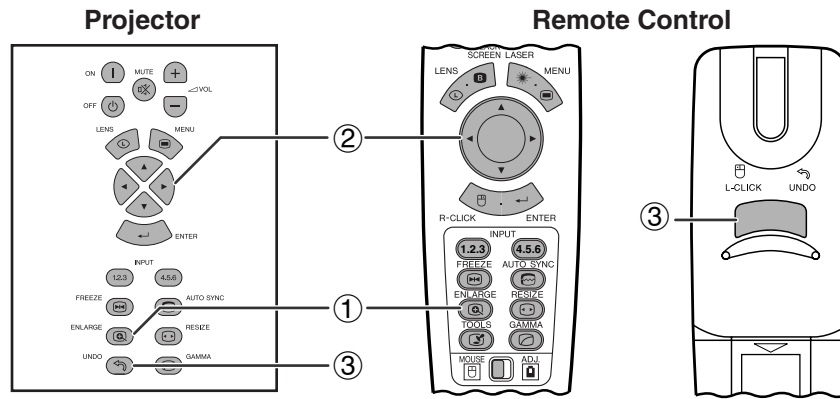

## On-screen Display

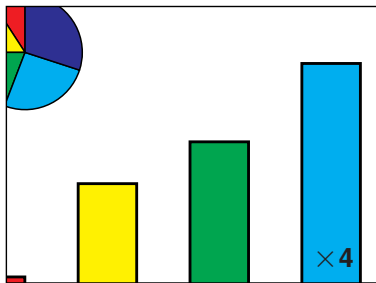
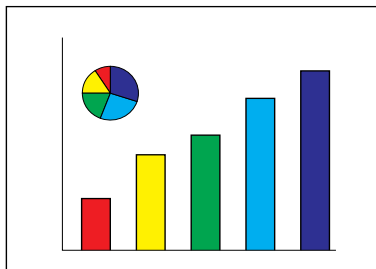

This function allows you to magnify a specific portion of an image. This is useful when you want to display a detailed portion of the image.

(Slide the **MOUSE/ADJUSTMENT** switch on the remote control to the ADJ. position)



- ① Press **ENLARGE**. Each time **ENLARGE** is pressed, the image will be magnified.
- ② When the image is magnified, you can pan and scan around the image by using  $\blacktriangle/\blacktriangledown/\blacktriangleleft/\blacktriangleright$ .

### NOTE

- **ENLARGE** does not work with UXGA signal image.
- Each time **ENLARGE** is pressed, image magnification toggles as shown below.

$\times 1 \rightarrow \times 4 \rightarrow \times 9 \rightarrow \times 16 \rightarrow \times 36 \rightarrow \times 64$

- If the input signal is changed during digital image magnification, the image will return to  $\times 1$ . The input signal is changed
  - (a) when **INPUT 1.2.3** or **INPUT 4.5.6** is pressed,
  - (b) when the input signal is interrupted, or
  - (c) when the input resolution and refresh rate changes.

- ③ To return to  $\times 1$ , press **UNDO**.





# Adjusting the Picture Aspect Ratio

## Projector

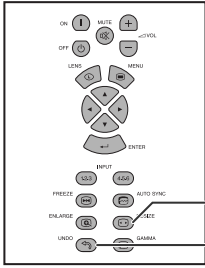

## Remote Control

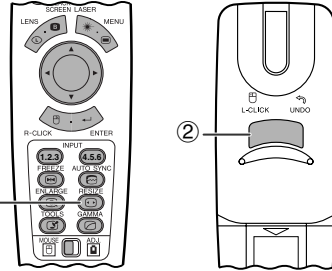

This function allows you to modify or customize the picture display mode to enhance the input image. Depending on the input signal, you can choose **NORMAL**, **FULL**, **DOT BY DOT**, **BORDER**, **STRETCH** or **SMART STRETCH** image.

- 1 Press **RESIZE**. Each time **RESIZE** is pressed, the picture mode changes as shown below.
- 2 To return to the standard image, press **UNDO** while "RESIZE" is displayed on the screen.

## COMPUTER

Input Signal	Output screen image		
	NORMAL	FULL	DOT BY DOT
 FOR 4:3 aspect ratio	 RESIZE NORMAL	 RESIZE FULL	 RESIZE DOT BY DOT
 FOR 4:3 aspect ratio (1024 × 768)	 RESIZE NORMAL		
 FOR 5:4 aspect ratio (1280 × 1024)	 RESIZE NORMAL	 RESIZE FULL	 RESIZE DOT BY DOT

## EXAMPLE

		NORMAL	FULL	DOT BY DOT
For 4:3 aspect ratio	SVGA (800 × 600)	1024 × 768	–	800 × 600
	XGA (1024 × 768)	1024 × 768	–	–
	SXGA (1280 × 960)	1024 × 768	–	1024 × 768
	UXGA (1600 × 1200)	1024 × 768	–	1024 × 768
For without 4:3 aspect ratio	SXGA (1280 × 1024)	960 × 768	1024 × 768	1024 × 768



## VIDEO/DTV

Input Signal	Output screen image			
	NORMAL	BORDER	STRETCH	SMART STRETCH
480i 480P NTSC PAL SECAM  FOR 4:3 aspect ratio	 RESIZE NORMAL	 RESIZE BORDER	 RESIZE STRETCH	 RESIZE SMART STRETCH
 with squeeze	 RESIZE NORMAL	 RESIZE BORDER	 RESIZE STRETCH	 RESIZE SMART STRETCH
720P 1080i  FOR 16:9 aspect ratio			 RESIZE STRETCH	

## EXAMPLE

		NORMAL	BORDER	STRETCH	SMART STRETCH
For 4:3 aspect ratio	NTSC, SECAM, 480i	1024 × 768	768 × 576	1024 × 576*	1024 × 576*
	PAL, 580i	1024 × 768	768 × 576	1024 × 576*	1024 × 576*
For 16:9 aspect ratio	480P	1024 × 768	768 × 576	1024 × 576*	1024 × 576*
	720P	–	–	1024 × 576*	–
	1080i	–	–	1024 × 576*	–

\* The digital image shift function can be used with these picture display modes.



# Gamma Correction Function

Projector

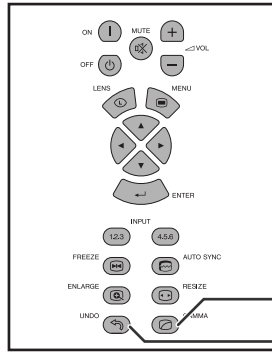

Remote Control

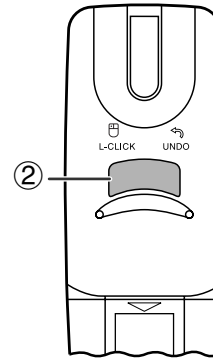
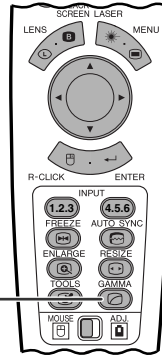

On-screen Display

STANDARD

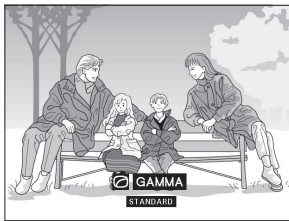

GAMMA 1

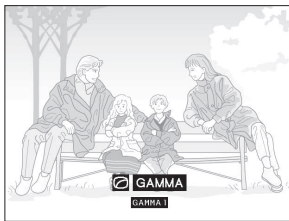

GAMMA 2

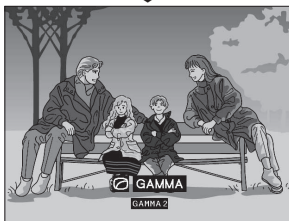

CUSTOM

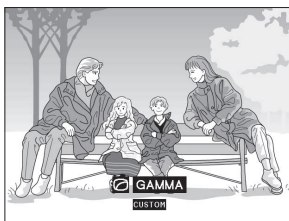

- Gamma is an image quality enhancement function that offers a richer image by brightening the darker portions of the image without altering the brightness of the brighter portions.
- Four gamma settings are available to allow for differences in the images displayed and in the brightness of the room.
- When you are displaying images with frequent, dark scenes, such as a film or concert, or when you are displaying images in a bright room, this feature makes the dark scenes easier to see and gives the impression of greater depth in the image.

## Gamma Modes

Selected Mode	Gamma mode
STANDARD	Standard picture without gamma correction.
GAMMA 1	Brightens darker portions of image for more enhanced presentations.
GAMMA 2	Gives greater depth to darker portions of image for a more exciting theater experience.
CUSTOM	Allows you to adjust gamma value using Sharp Advanced Presentation Software.

(Slide the **MOUSE/ADJUSTMENT** switch on the remote control to the ADJ. position.)

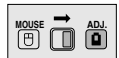

- ① Press **GAMMA**. Each time **GAMMA** is pressed, the gamma level toggles as shown on the left.
- ② To return to the standard image, press **UNDO** while "GAMMA" is displayed on the screen.





# Selecting the Remote Control Mode

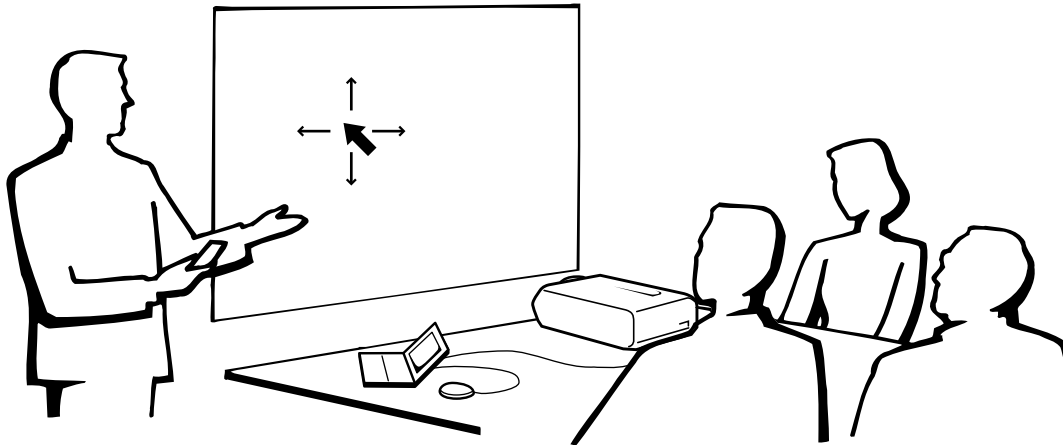

## Using the Remote Control as a Wireless Mouse

The remote control has the following three functions:

- Projector control
- Wireless mouse
- Laser pointer

### MOUSE/ADJUSTMENT switch (Remote control)

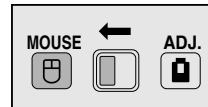

Wireless mouse/  
Laser pointer

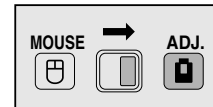

Projector control



# Operating the Remote Control

## Remote Control/Mouse Receiver Positioning

- The remote control can be used to control the projector within the ranges shown below.
- The remote mouse receiver can be used with the remote control to control the mouse functions of a connected computer within the ranges shown below.

### NOTE

- The signal from the remote control can be reflected off a screen for easy operation. However, the effective distance of the signal may differ due to the screen material.

## Controlling the Projector

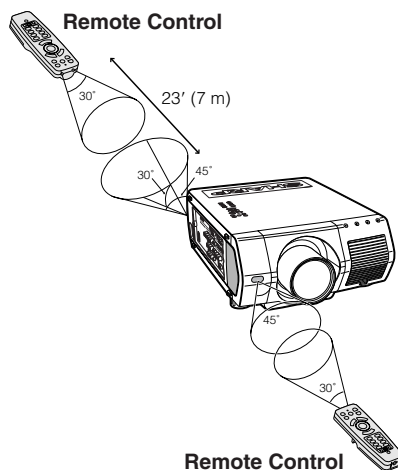

## Using the Wireless Mouse

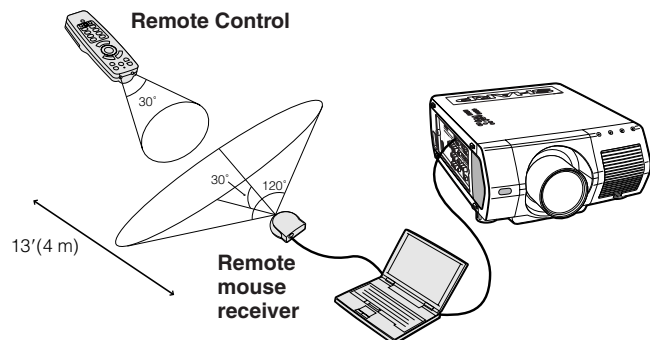



## Use as a Wireless Mouse

Be sure the supplied remote mouse receiver is connected to your computer.

Slide the **MOUSE/ADJUSTMENT** switch to **MOUSE**.

### MOUSE mode buttons

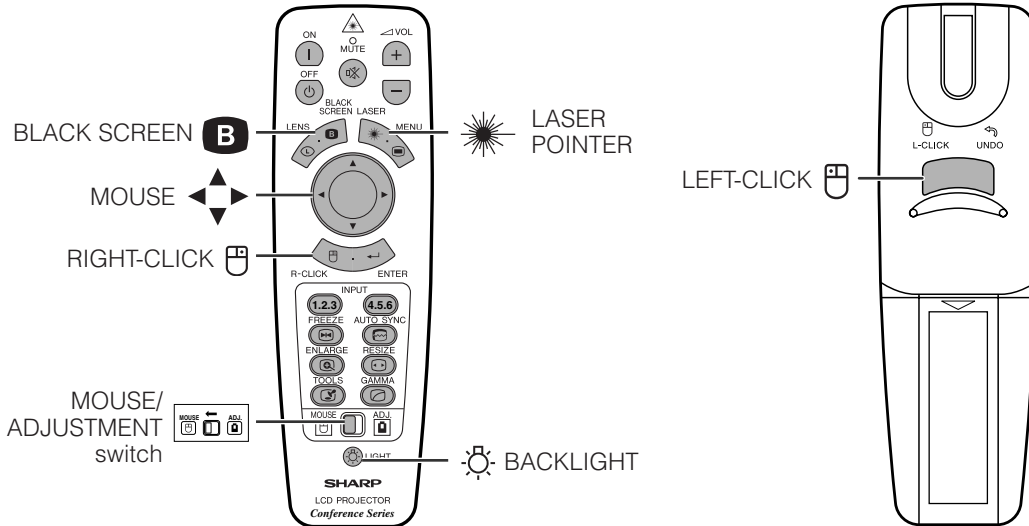

#### NOTE

- For one-button mouse systems, use either the **LEFT-CLICK** or **RIGHT-CLICK** button.
- Press **BACKLIGHT**, and the buttons will light up. Green lights refer to mouse operations, and red lights to projector adjustments.

Button name	Position of <b>MOUSE/ADJUSTMENT</b> switch	
	<b>MOUSE</b> (M)	<b>ADJ.</b> (A)
LASER POINTER/MENU	LASER POINTER (GREEN)	MENU (RED)
BLACK SCREEN/LENS	BLACK SCREEN (GREEN)	LENS (RED)
RIGHT-CLICK/ENTER	RIGHT-CLICK (GREEN)	ENTER (RED)
MOUSE/ADJUSTMENT	MOUSE (NOT LIT)	ADJUSTMENT (NOT LIT)
LEFT-CLICK/UNDO	LEFT-CLICK (NOT LIT)	UNDO (NOT LIT)
POWER ON/OFF	ON (RED)	
VOLUME +/-		
MUTE		

Button name	Position of <b>MOUSE/ADJUSTMENT</b> switch	
	<b>MOUSE</b> (M)	<b>ADJ.</b> (A)
INPUT 1, 2, 3	ON (RED)	
INPUT 4, 5, 6		
FREEZE		
AUTO SYNC		
ENLARGE		
RESIZE		
TOOLS		
GAMMA		



# Connecting the Mouse Receiver

## Connecting the Remote Mouse Receiver

You can use the remote control as a remote mouse to operate computers compatible with PS/2 or USB type mouse systems.

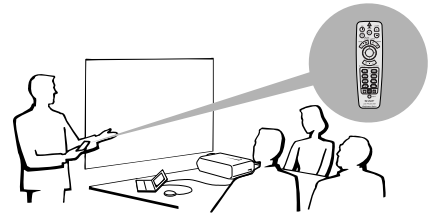

## Connecting to the USB port on a PC or Macintosh

- 1 Connect one end of the supplied USB mouse control cable to the corresponding terminal on the computer.
- 2 Connect the other end to the USB port on the remote mouse receiver.

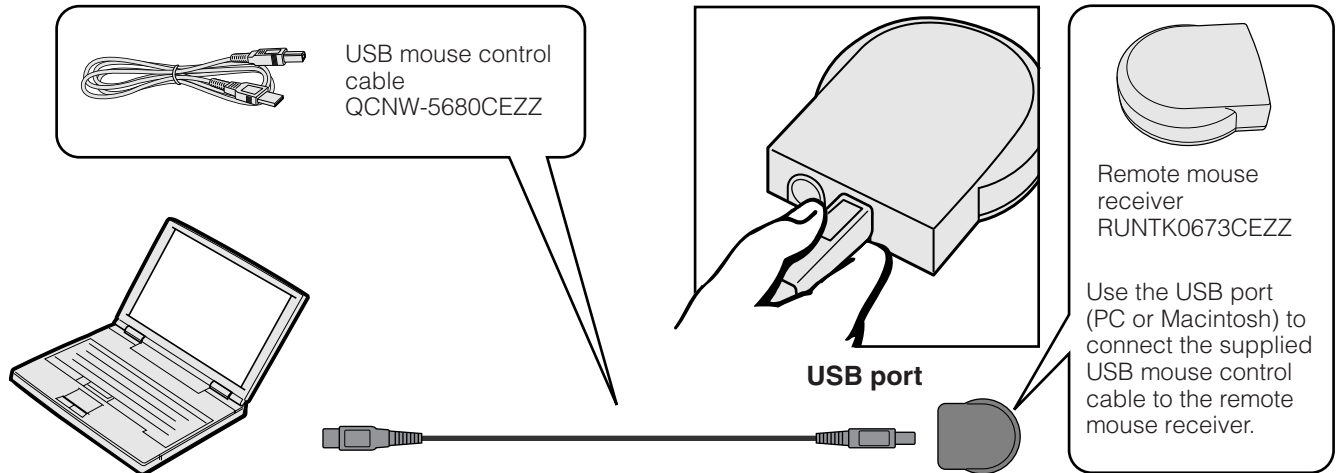

## Connecting to the PS/2 port on a PC

- 1 Turn off the power of the PC.
- 2 Connect one end of the supplied PS/2 mouse control cable to the corresponding terminal on the PC.
- 3 Connect the other end to the PS/2 port on the remote mouse receiver.
- 4 Turn on the power of the PC.

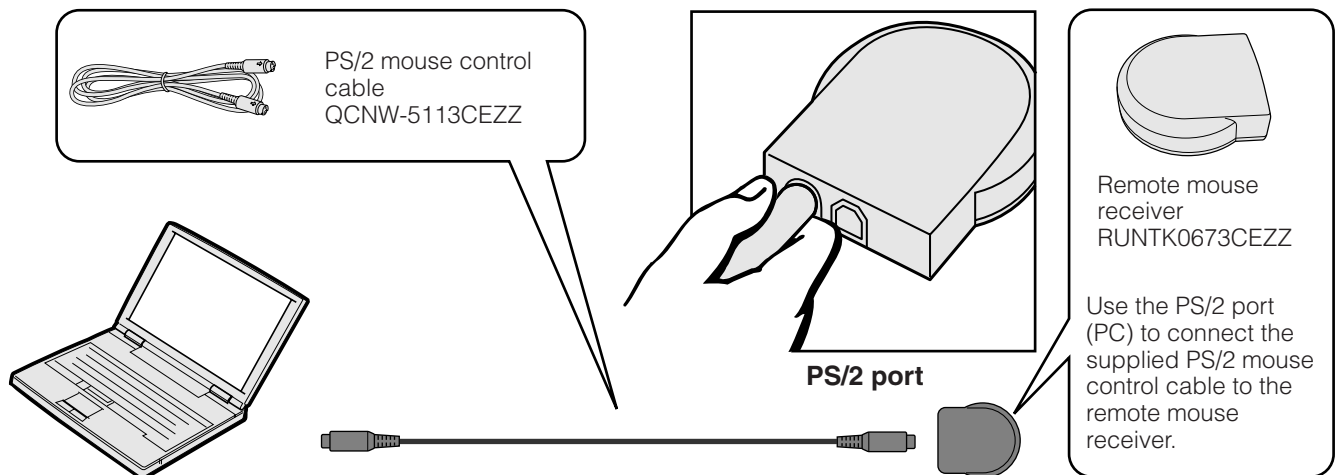

### CAUTION

- Do not connect or disconnect the mouse control cables to or from the computer while it is on. This may damage your computer.
- Do not connect both the PS/2 and USB mouse control cables to the remote mouse receiver.
- Windows 95 does not support USB mouse driver software.
- The minimum system requirements for the USB type mouse system are shown below.

#### Windows

Hardware: PC/AT compatible machine with USB port that has Windows 98/Windows NT 5.0 or higher installed.

OS: Windows 98/Windows NT 5.0 or higher

#### Macintosh

Hardware: Macintosh series with USB port

OS: Mac OS 8.5 or higher

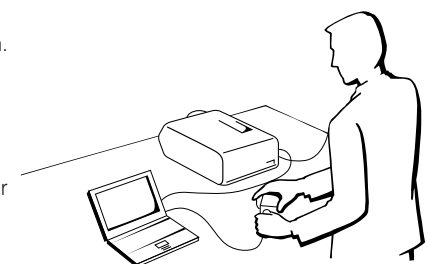



# Using as a Laser Pointer

## Use as a Laser Pointer

Slide the **MOUSE/ADJUSTMENT** switch to **MOUSE**, and press **LASER POINTER** (☀) to activate the laser pointer.

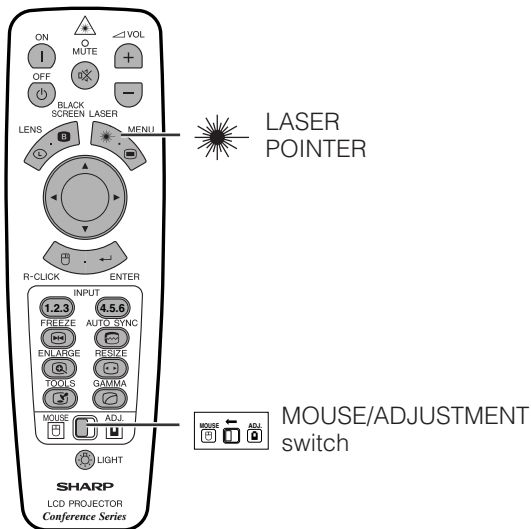

### NOTE

- When the button is released, the light automatically goes off.
- For safety reasons, the laser pointer automatically goes off after 1 minute of continuous use. To turn it on, release **LASER POINTER** (☀) and press again.

### CAUTION

- Do not look into the laser pointer window or shine the laser beam on yourself or others. (The laser beam used in this product is harmless when directed onto the skin. However, be careful not to project the beam directly into the eyes.)



# Using as a Wired Remote Control

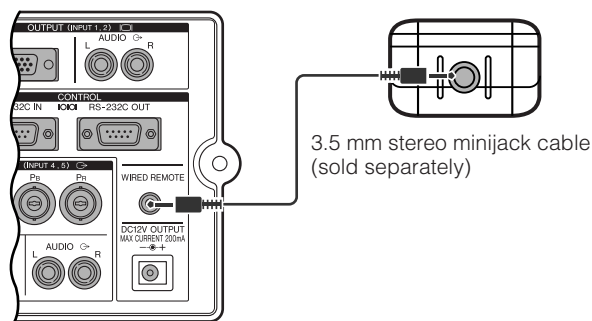

## Wired Remote Control

When the remote control cannot be used due to the range or positioning of the projector (rear projection, etc.), connect a 3.5 mm stereo minijack cable (sold separately) from the wired remote control input on the bottom of the remote control to the **WIRED REMOTE** control input terminal on the side of the projector.

### NOTE

- The laser pointer and wireless mouse functions can still be operated with the wired remote control.







# Using the GUI (Graphical User Interface) Menu Screen



## Basic Operations

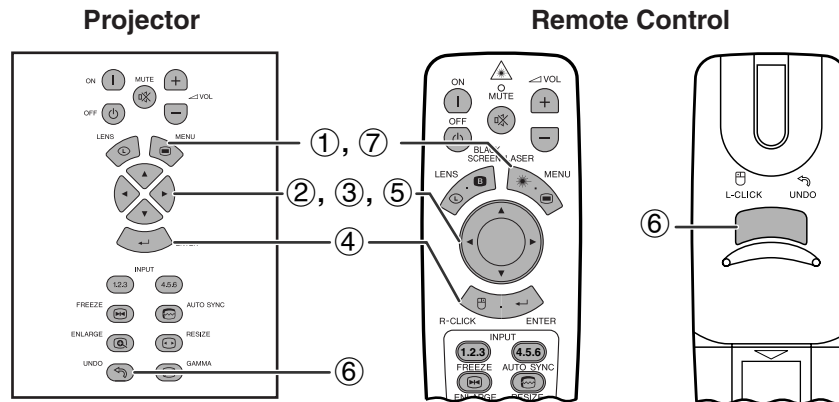

This projector has two sets of menu screens that allow you to adjust the image and various projector settings. These menu screens can be operated from the projector or the remote control with the following procedure.

### (GUI) On-screen Display

#### INPUT 1, 2 (RGB) or 3 (DIGITAL) mode

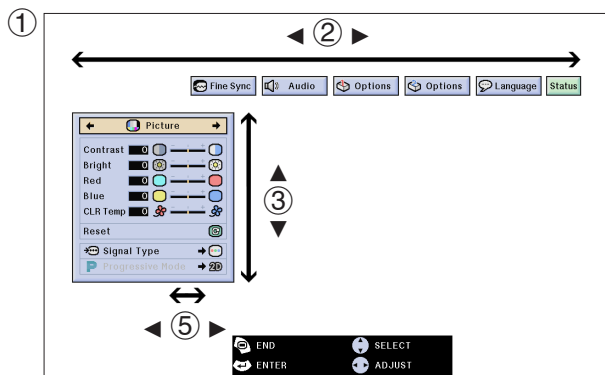

#### INPUT 4, 5 (VIDEO) mode

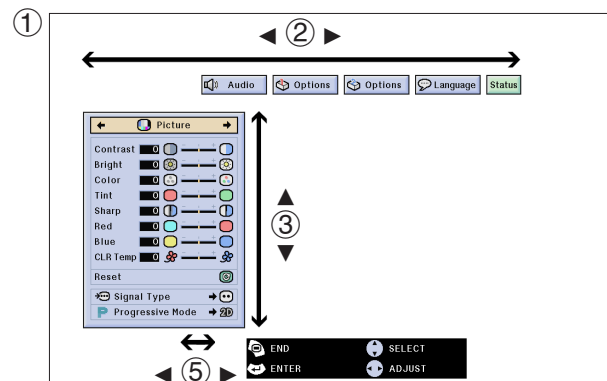

(Slide the **MOUSE/ADJUST** switch on the remote control to the ADJ. position.)

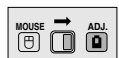

- ① Press **MENU** to display the INPUT 1, 2, 3, 4 or 5 mode menu bar.
- ② Press **◀/▶** to select an adjustment menu on the menu bar.
- ③ Press **▲/▼** to select a specific adjustment item.
- ④ To display a single adjustment item, press **ENTER** after selecting the item. Only the menu bar and the selected adjustment item will appear.
- ⑤ Press **◀/▶** to adjust the item.
- ⑥ Press **UNDO** to return to the previous screen.
- ⑦ To exit from the GUI, press **MENU**.

#### NOTE

- For details on items on the menu screen, see the tree charts on pages 41 and 42.





# Menu Bars

## Items on the INPUT 1, 2 or 3 Mode Menu Bar

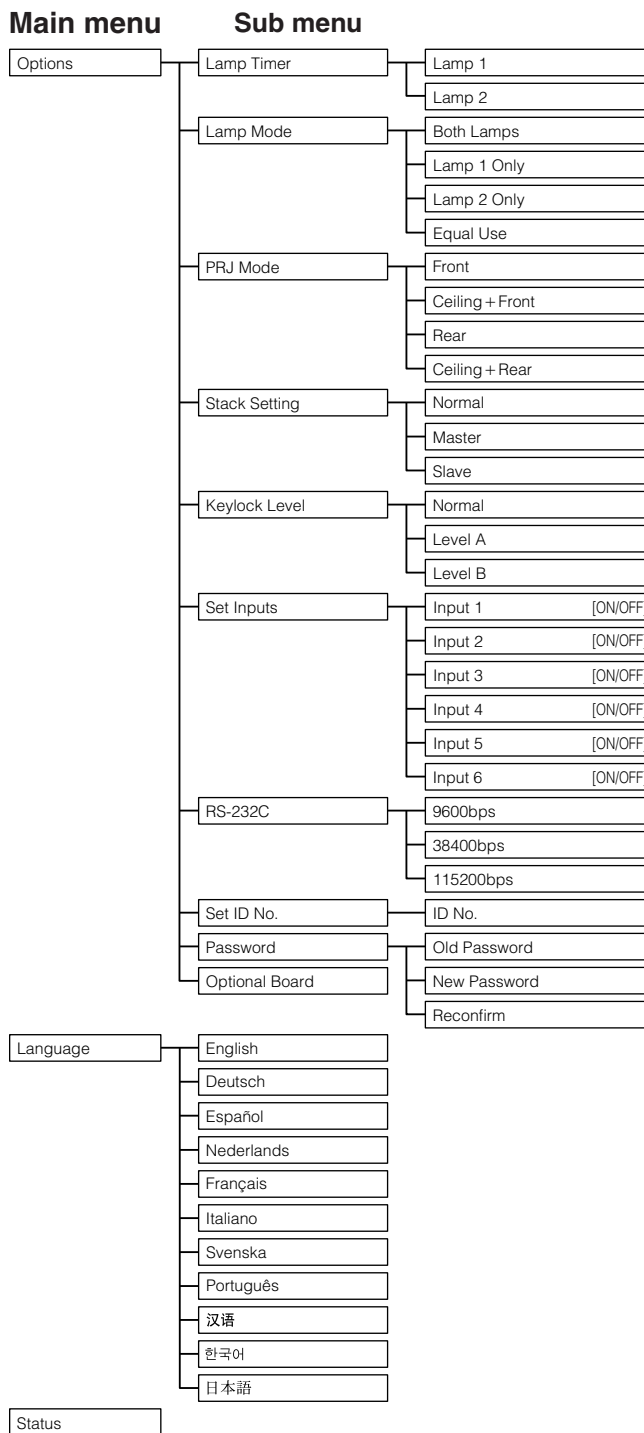
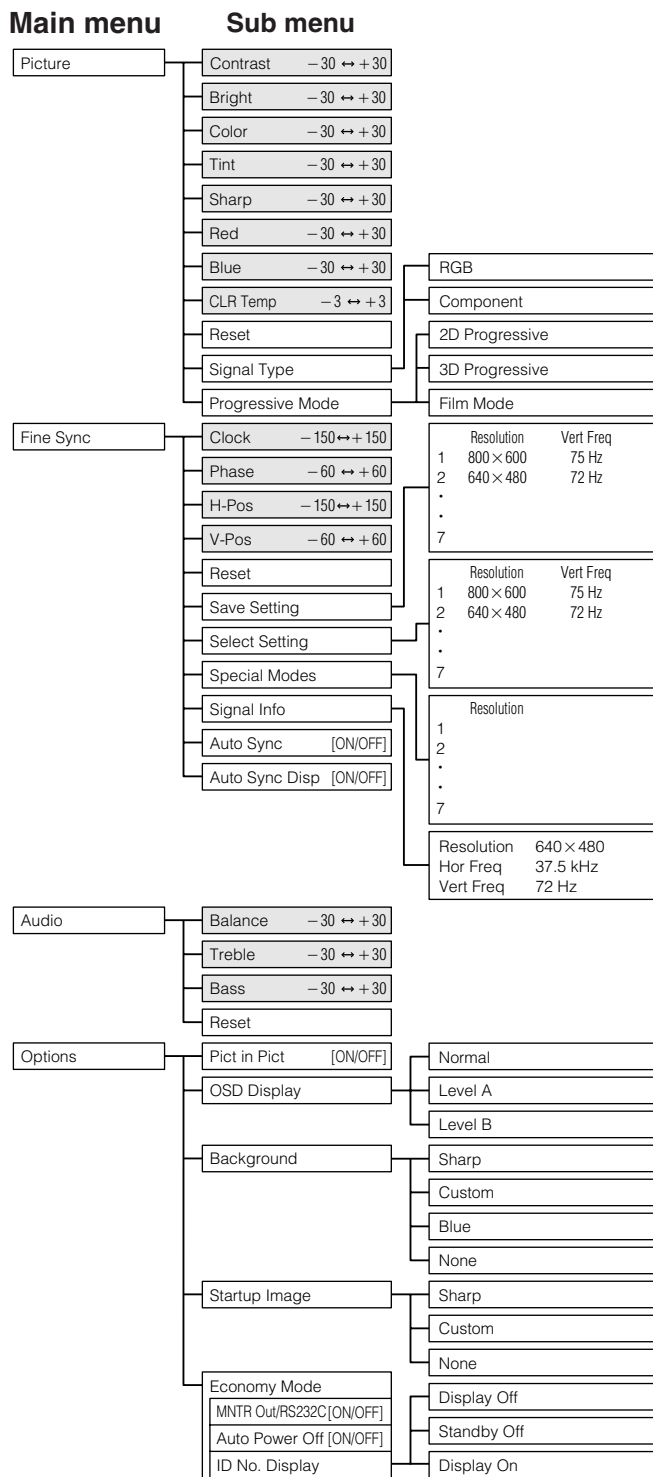

### NOTE

- The resolution, vertical frequency and horizontal frequency figures displayed above are for example purposes only.
- “Color”, “Tint”, and “Sharp” appear only when Component input is selected in INPUT 1 or 2 mode. For INPUT 3 (DVI), in “Picture” menu, only “CLR Temp” is active and the other menus are displayed in gray. In “Fine Sync” menu, only “Signal Info” is active and the other menus are displayed in gray.
- Only the items highlighted in the tree charts above can be adjusted.
- To adjust the items under the sub menu, press ► after selecting the sub menu.



### Items on the INPUT 4 or 5 Mode Menu Bar

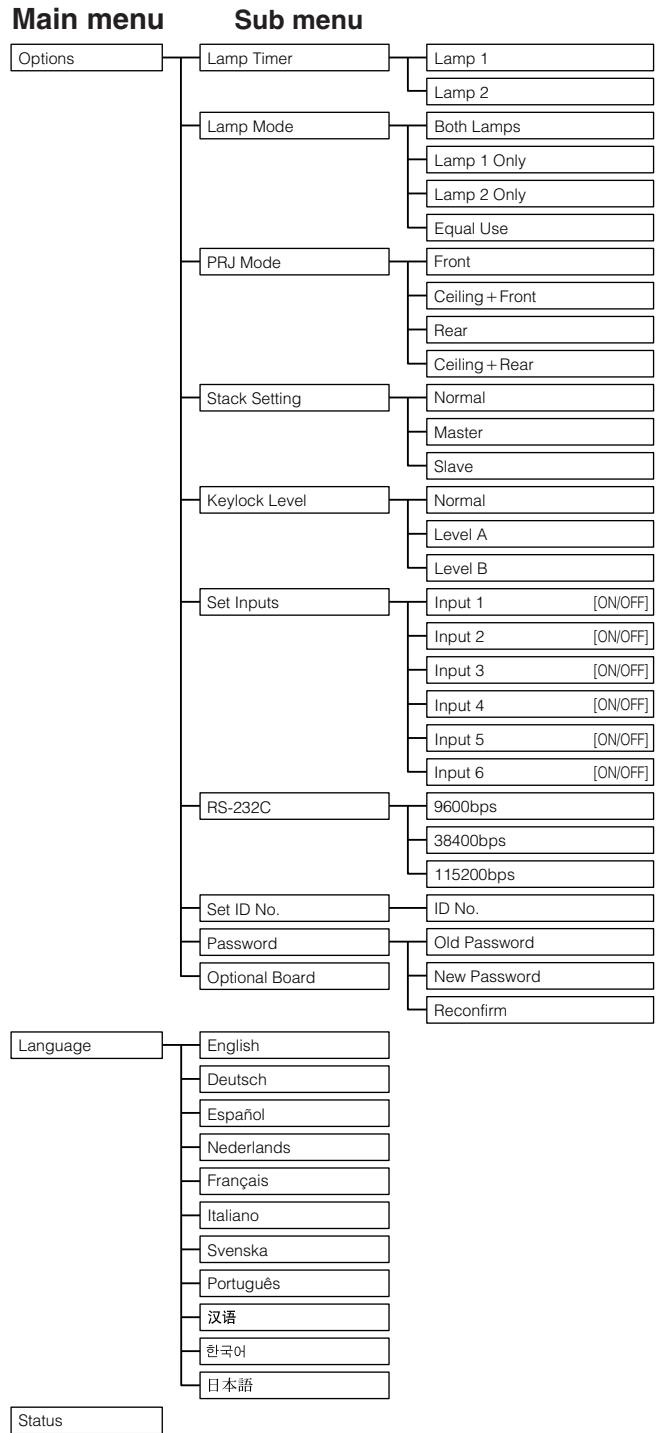
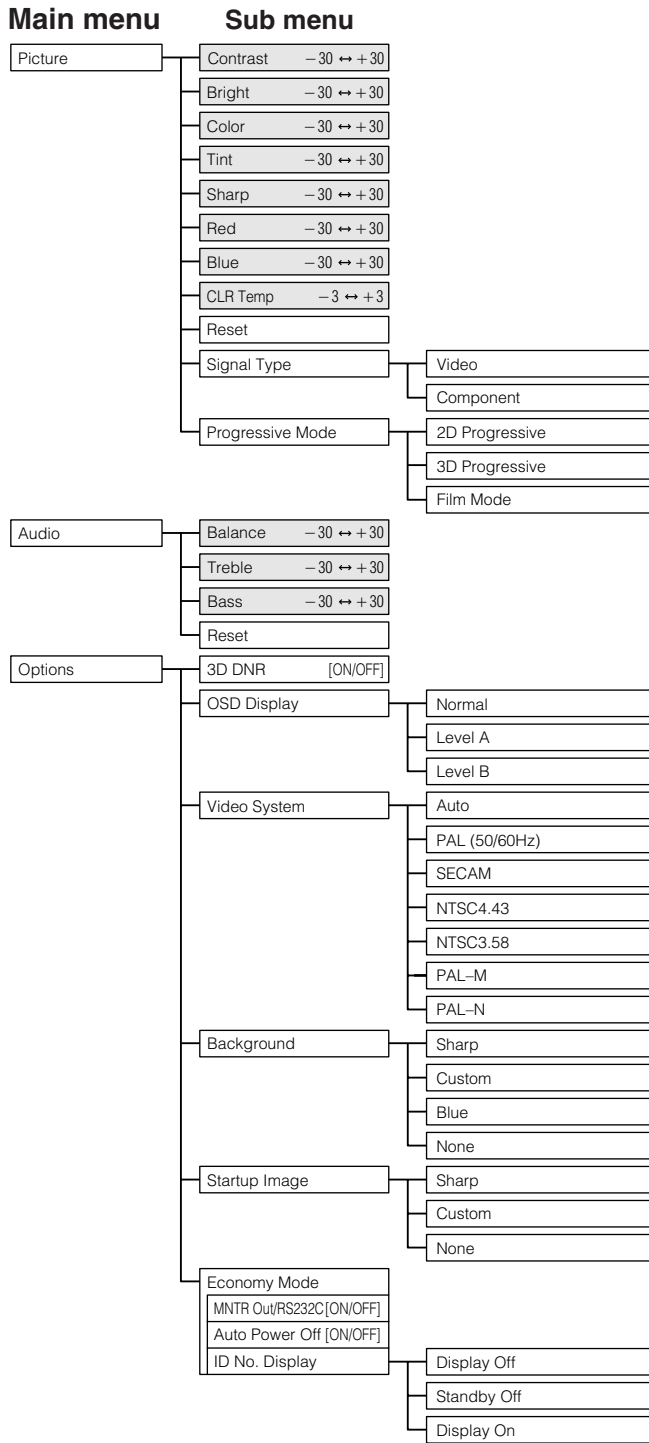

**NOTE**

- Only the items highlighted in the tree charts above can be adjusted.
- To adjust the items under the sub menu, press ► after selecting the sub menu.
- When selecting "Component" on "Signal Type", the tree chart becomes the same as the one in INPUT 1, 2 or 3 mode.





# Adjusting the Picture

## Projector

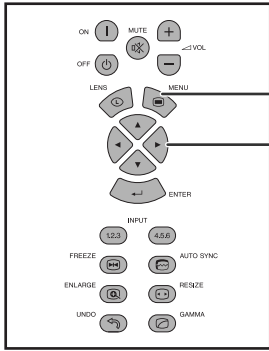

## Remote Control

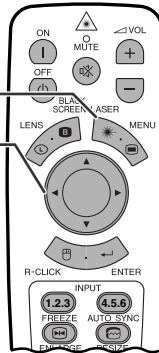

You can adjust the projector's picture to your preferences with the following picture settings.

### Description of Adjustment Items

Selected item	◀ button	▶ button
<b>Contrast</b>	For less contrast	For more contrast
<b>Bright</b>	For less brightness	For more brightness
<b>Color</b>	For less color intensity	For more color intensity
<b>Tint</b>	Skin tones become purplish	Skin tones become greenish
<b>Sharp</b>	For less sharpness	For more sharpness
<b>Red</b>	For weaker red	For stronger red
<b>Blue</b>	For weaker blue	For stronger blue
<b>Reset</b>	All image adjustment items are returned to the factory preset settings.	

### (GUI) On-screen Display e. g. (RGB input in INPUT 1 or 2 mode)

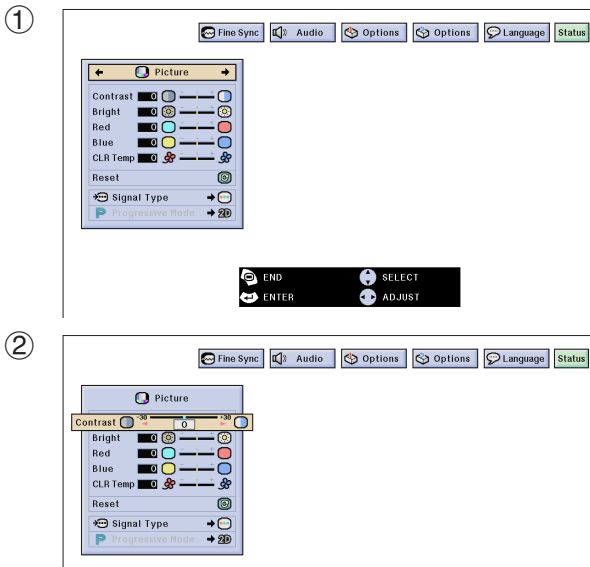

### NOTE

- “Color”, “Tint” and “Sharp” do not appear for RGB input in INPUT 1 or 2 mode.

(Slide the **MOUSE/ADJUSTMENT** switch on the remote control to the **ADJ.** position.)



- 1 Press **MENU**. Menu bar and “Picture” menu screen appear. GUI operation guide is also displayed.
- 2 Press **▲/▼** to select a specific adjustment item.
- 3 Press **◀/▶** to move the **■** mark of the selected adjustment item to the desired setting.
- 4 To exit from the GUI, press **MENU**.

### NOTE

- To reset all adjustment items, select “Reset” on the “Picture” menu screen and press **ENTER**.
- The adjustments can be stored separately in the INPUT 1 to 5 modes.
- Depending on the type of signal received, “Sharp” may not be adjustable for COMPONENT input in INPUT 1 or 2 mode.



## Adjusting the Picture

### Projector

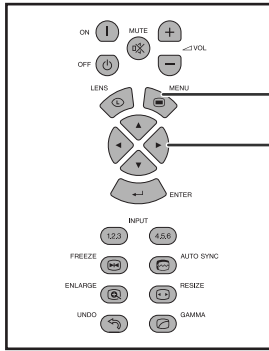

### Remote Control

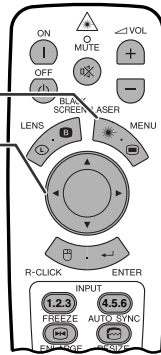

### (GUI) On-screen Display

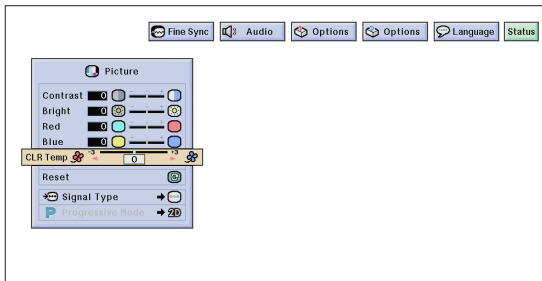

## Adjusting the Color Temperature

This function can be used to adjust the color temperature to suit the type of image input to the projector (video, computer image, TV broadcast, etc.). Decrease the color temperature to create warmer, reddish images for natural flesh tones, or increase to create cooler, bluish images for a brighter picture.

### Description of Color Temperature

<p><b>(Red) ◀ button</b></p> <p>Decreases color temperature for warmer, reddish, incandescent-like images. (Low color temperature)</p>	<p><b>▶ button (Blue)</b></p> <p>Increases color temperature for cooler, bluish, florescent-like images. (High color temperature)</p>

(Slide the **MOUSE/ADJUSTMENT** switch on the remote control to the ADJ. position.)



- ① Press **MENU**. Menu bar and "Picture" menu screen appear. GUI operation guide is also displayed.
- ② Press **▲/▼** to select "CLR Temp".
- ③ Press **◀/▶** to move the **■** mark of the selected adjustment item to the desired setting.
- ④ To exit from the GUI, press **MENU**.





## Adjusting the Picture

### Projector

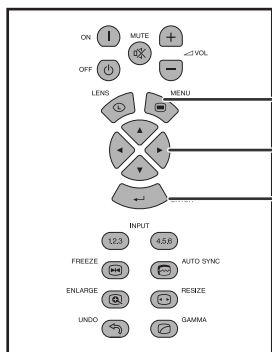

### Remote Control

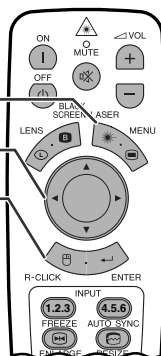

### (GUI) On-screen Display

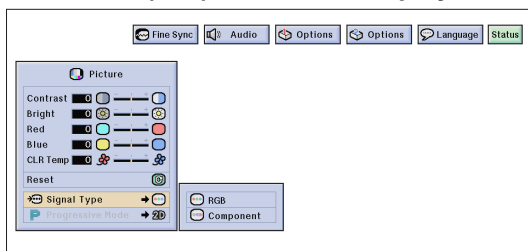

## Selecting the Signal Type

This function allows you to select the input signal type RGB (VIDEO) or COMPONENT for INPUT 1, 2, 4 or 5 port.

(Slide the **MOUSE/ADJUSTMENT** switch on the remote control to the ADJ. position.)



- 1 Press **MENU**. Menu bar and "Picture" menu screen appear. GUI operation guide is also displayed.
- 2 Press **▲/▼** to select "Signal Type", and then press **▶**.
- 3 Press **▲/▼** to select "RGB (VIDEO)" or "Component".
- 4 Press **ENTER** to save the setting.
- 5 To exit from the GUI, press **MENU**.

### Projector

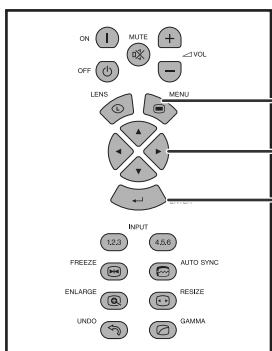

### Remote Control

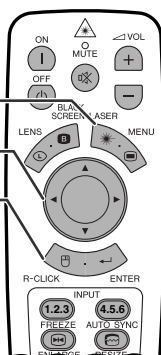

### (GUI) On-screen Display

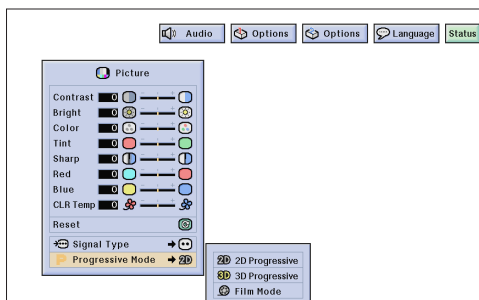

## Progressive Mode

This function allows you to select the progressive display of a video signal. The progressive display projects a smoother video image.

(Slide the **MOUSE/ADJUSTMENT** switch on the remote control to the ADJ. position.)



- 1 Press **MENU**. Menu bar and "Picture" menu screen appear. GUI operation guide is also displayed.
- 2 Press **▲/▼** to select "Progressive Mode", and then press **▶**.
- 3 Press **▲/▼** to select "2D Progressive", "3D Progressive" or "Film Mode".
- 4 Press **ENTER** to save the setting.
- 5 To exit from the GUI, press **MENU**.

## Progressive Mode

Selects the progressive conversion mode.

### 2D Progressive

This function is useful to display fast-moving images such as sports and action films. Mode that optimizes the image in a displayed frame.

### 3D Progressive

This function is useful to display relatively slow-moving images such as drama and documentary more clearly.

Mode that optimizes the image by estimating the movement of a number of preceding and succeeding frames.

### Film Mode

Reproduces the image of film software clearly. Displays the optimized image of film transformed with three-two pull down enhancement to progressive mode images.

### NOTE

- Film Mode cannot work with PAL 50 Hz.



# Adjusting the Computer Images (RGB menu only)

## Projector

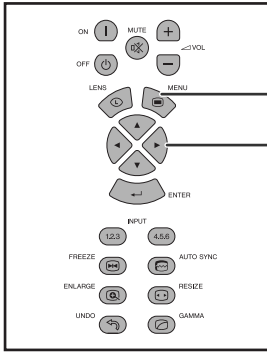

## Remote Control

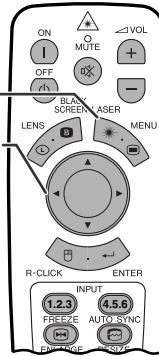

When displaying computer patterns which are very detailed (tiling, vertical stripes, etc.), interference may occur between the LCD pixels, causing flickering, vertical stripes, or contrast irregularities in portions of the screen. Should this occur, adjust “Clock”, “Phase”, “H-Pos” and “V-Pos” for the optimum computer image.

### Description of Adjustment Items

Selected item	Description
<b>Clock</b>	Adjusts vertical noise.
<b>Phase</b>	Adjusts horizontal noise (similar to tracking on your VCR).
<b>H-Pos</b>	Centers the on-screen image by moving it to the left or right.
<b>V-Pos</b>	Centers the on-screen image by moving it up or down.

### NOTE

- Computer image adjustments can be made easily by pressing **AUTO SYNC** (🔊). See page 49 for details.

(Select the desired computer input mode with **INPUT 1** or **2**.)

(Slide the **MOUSE/ADJUSTMENT** switch on the remote control to the ADJ. position.)

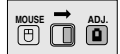

### (GUI) On-screen Display

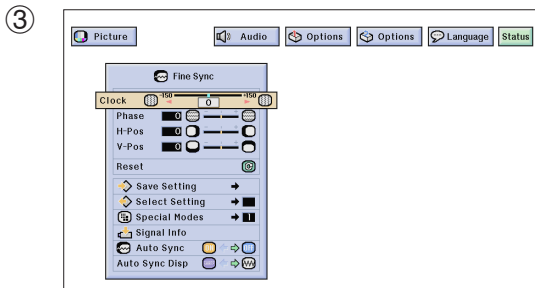
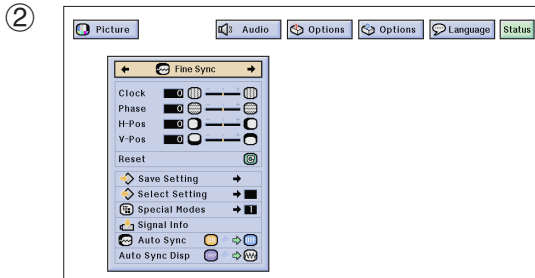

① Press **MENU**.

② Press ◀/▶ to select “Fine Sync”.

③ Press ▲/▼ to select a specific adjustment item.

④ Press ◀/▶ to move the ■ mark of the selected adjustment item to the desired setting.

⑤ To exit from the GUI, press **MENU**.

### NOTE

- To reset all adjustment items, select “Reset” on the “Fine Sync” menu screen and press **ENTER**.





## Adjusting the Computer Images (RGB menu only)

### Projector

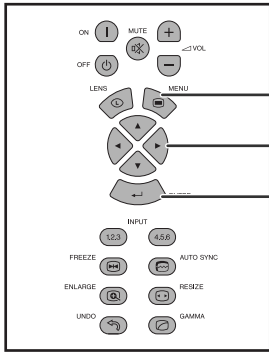

### Remote Control

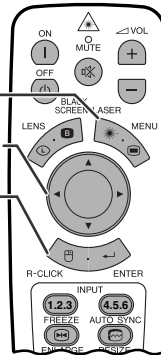

### (GUI) On-screen Display

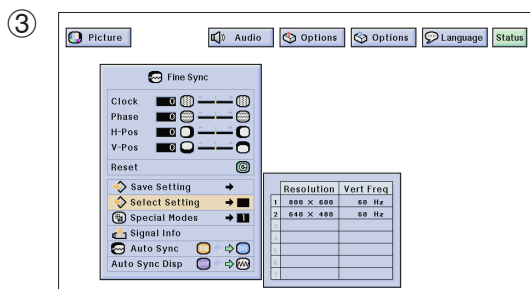
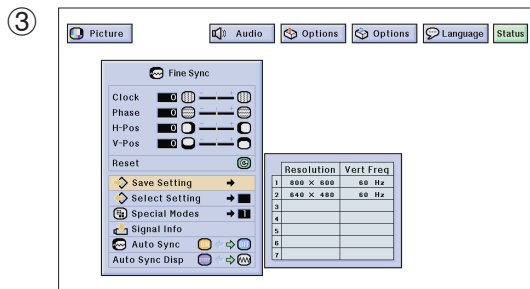
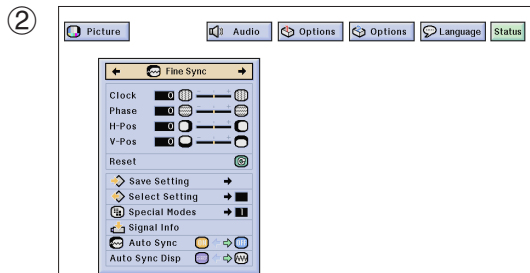

## Saving and Selecting Adjustment Settings

This projector allows you to store up to seven adjustment settings for use with various computers. Once these settings are stored, they can be easily selected each time you connect a computer to the projector.

### Saving the adjustment setting

(Slide the **MOUSE/ADJUSTMENT** switch on the remote control to the ADJ. position.)

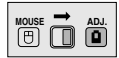

- ① Press **MENU**.
- ② Press ◀/▶ to select “Fine Sync”.
- ③ Press ▲/▼ to select “Save Setting”, and then press ▶.
- ④ Press ▲/▼ to select the desired memory location of the setting.
- ⑤ Press **ENTER** to save the setting.
- ⑥ To exit from the GUI, press **MENU**.

### Selecting a saved setting

(Slide the **MOUSE/ADJUSTMENT** switch on the remote control to the ADJ. position.)

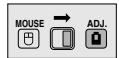

- ① Press **MENU**.
- ② Press ◀/▶ to select “Fine Sync”.
- ③ Press ▲/▼ to select “Select Setting”, and then press ▶.
- ④ Press ▲/▼ to select the desired memory setting.
- ⑤ Press **ENTER** to select the setting.
- ⑥ To exit from the GUI, press **MENU**.

### NOTE

- If a memory position has not been set, a resolution and frequency setting will not be displayed.
- When selecting the stored adjustment setting with “Select Setting”, the computer system should match the stored setting.





## Adjusting the Computer Images (RGB menu only)

### Projector

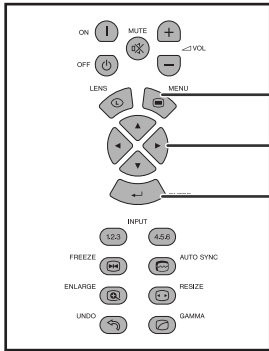

### Remote Control

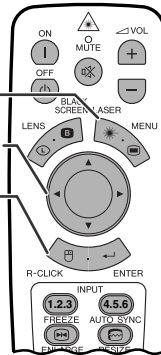

### (GUI) On-screen Display

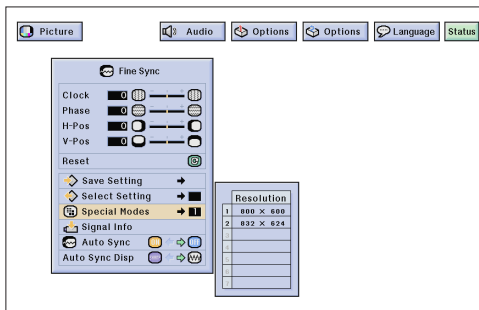

## Special Mode Adjustment

Ordinarily, the type of input signal is detected and the correct resolution mode is automatically selected. However, for some signals, the optimal resolution mode in "Special Modes" on the "Fine Sync" menu screen may need to be selected to match the computer display mode.

(Slide the **MOUSE/ADJUSTMENT** switch on the remote control to the ADJ. position.)

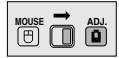

- ① Press **MENU**.
- ② Press ◀/▶ to select "Fine Sync".
- ③ Press ▲/▼ to select "Special Modes", and then press ▶.
- ④ Press ▲/▼ to select the optimal resolution mode.
- ⑤ Press **ENTER** to save the setting.
- ⑥ To exit from the GUI, press **MENU**.

### NOTE

- Avoid displaying computer patterns which repeat every other line (horizontal stripes). (Flickering may occur, making the image hard to see.)
- When inputting DTV 480P or 1080i signals, select the corresponding type of signal in step ④ above.

### Projector

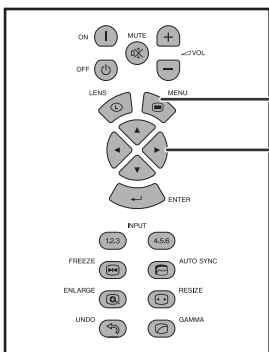

### Remote Control

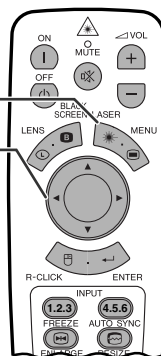

### (GUI) On-screen Display

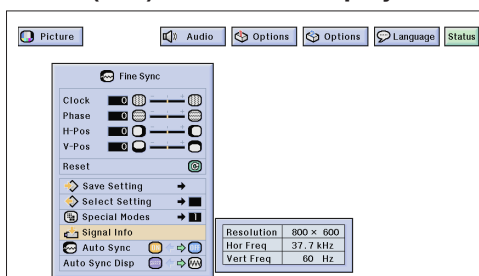

## Checking the Input Signal

This function allows you to check the current input signal information.

(Slide the **MOUSE/ADJUSTMENT** switch on the remote control to the ADJ. position.)

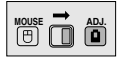

- ① Press **MENU**.
- ② Press ◀/▶ to select "Fine Sync".
- ③ Press ▲/▼ to select "Signal Info" to display the current input signal.
- ④ To exit from the GUI, press **MENU**.





## Adjusting the Computer Images (RGB menu only)

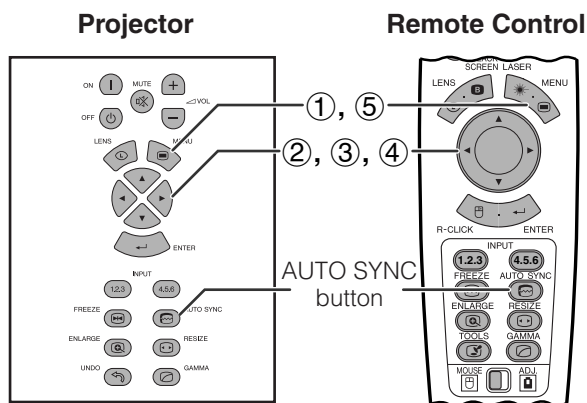

### (GUI) On-screen Display

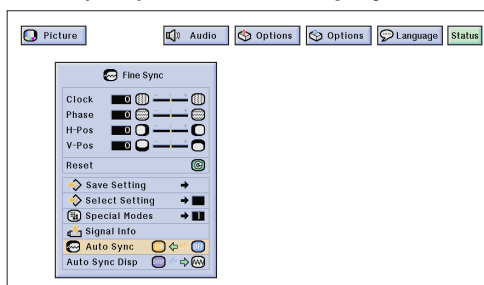

### On-screen Display



### (GUI) On-screen Display

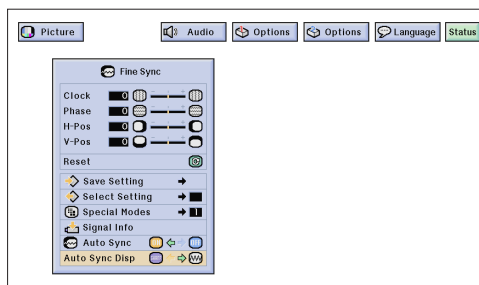

## Auto Sync Adjustment

- Used to automatically adjust a computer image.
- Auto Sync adjustment can be made manually by pressing **AUTO SYNC**, or automatically by setting "Auto Sync" to "ON" in the projector's GUI menu.

### When "Auto Sync" is set to "ON":

- The sync adjustment is automatically made each time the projector is turned on while connected to a computer or the input selection is changed.
- The Auto Sync adjustment setting previously made is cleared when the projector's setting is changed.

(Slide the **MOUSE/ADJUSTMENT** switch on the remote control to the ADJ. position.)



- 1 Press **MENU**.
- 2 Press ◀/▶ to select "Fine Sync".
- 3 Press ▲/▼ to select "Auto Sync".
- 4 Press ◀/▶ to select "ON".
- 5 To exit from the GUI, press **MENU**.

### NOTE

- Automatic adjustments can be made by pressing **AUTO SYNC**.
- When the optimum image cannot be achieved with Auto Sync adjustment, use manual adjustments. (See page 46.)

During Auto Sync adjustment, the On-screen Display changes as shown on the left.

### NOTE

- Auto Sync adjustment may take some time to complete, depending on the image of the computer connected to the projector.

## Auto Sync Display Function

Normally, an image is not superimposed during Auto Sync adjustment. You can, however, choose to superimpose a background image during Auto Sync adjustment.

(Slide the **MOUSE/ADJUSTMENT** switch on the remote control to the ADJ. position.)



- 1 Press **MENU**.
- 2 Press ◀/▶ to select "Fine Sync".
- 3 Press ▲/▼ to select "Auto Sync Disp".
- 4 Press ◀/▶ to select "Ⓜ" to superimpose a background image or "Ⓜ" to remove the background image during Auto Sync adjustment.
- 5 To exit from the GUI, press **MENU**.



# Adjusting the Sound

## Projector

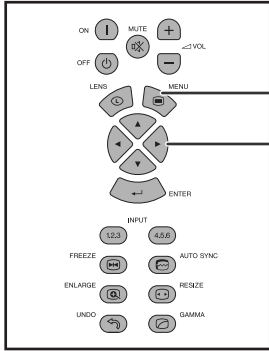

## Remote Control

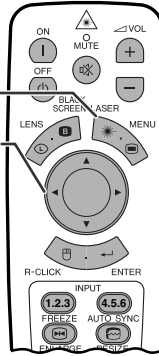

This projector's audio is factory preset to standard settings. However, you can adjust it to suit your own preferences by adjusting the following audio settings.

### Description of Adjustment Items

Selected item	◀ button	▶ button
<b>Balance</b>	Increased audio from the left speaker	Increased audio from the right speaker
<b>Treble</b>	For weaker treble	For stronger treble
<b>Bass</b>	For weaker bass	For stronger bass
<b>Reset</b>	All audio adjustment items are returned to the factory preset settings.	

### (GUI) On-screen Display

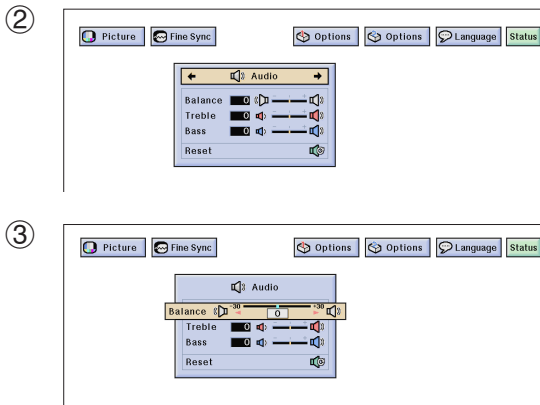

(Slide the **MOUSE/ADJUSTMENT** switch on the remote control to the ADJ. position.)

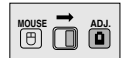

- ① Press **MENU**.
- ② Press ◀/▶ to select "Audio".
- ③ Press ▲/▼ to select a specific adjustment item.
- ④ Press ◀/▶ to move the ■ mark of the selected adjustment item to the desired setting.
- ⑤ To exit from the GUI, press **MENU**.

### NOTE

- To reset all adjustment items, select "Reset" on the "Audio" menu screen and press **ENTER**.





# Displaying Dual Pictures (RGB menu only)

## Projector

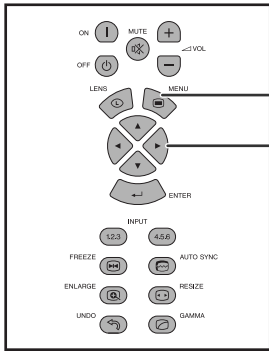

## Remote Control

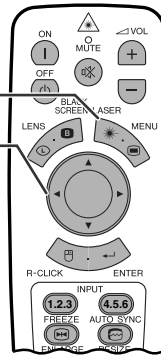

Picture in Picture function allows you to display two pictures on the same screen. You can display the image input from INPUT 4 or 5 as an inset picture overlapping the main picture input from INPUT 1, 2 or 3.

(Slide the **MOUSE/ADJUSTMENT** switch on the remote control to the ADJ. position.)



- ① Press **MENU**.
- ② Press ◀/▶ to select "Options (1)".
- ③ Press ▲/▼ to select "Pict in Pict".
- ④ Press ◀/▶ to select "□" to display an inset picture (Factory preset to INPUT 4).

## (GUI) On-screen Display

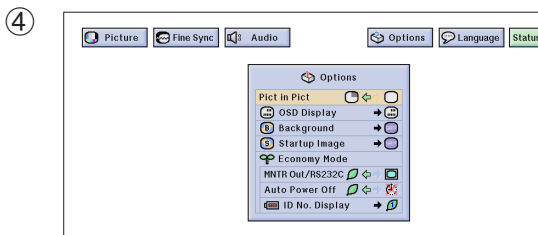
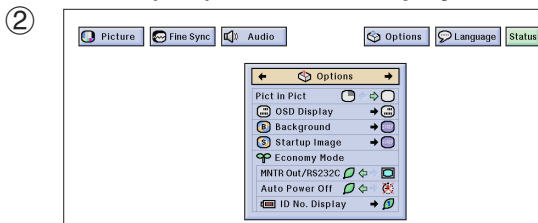

### NOTE

- The image from INPUT 1, 2 or 3 is displayed as the main picture and the image from INPUT 4 or 5 is displayed as the inset picture.
  - The last displayed image from INPUT 4 or 5 is displayed as the inset picture.
- For example, when you want to display the image from INPUT 5 as the inset picture, select INPUT 5, then select the main picture, and then select "Pict in Pict".

- ⑤ Press ◀/▶/▲/▼ to move the inset picture to one of four preset positions.

- ⑥ To exit from the GUI, press **MENU**.

### NOTE

- Inset picture can only be displayed in composite signal of NTSC/PAL/SECAM.
- When selecting the image for the inset picture, only the images being input will be displayed.
- The audio of the insert picture will come out of the projector's speakers.
- Picture in Picture does not work in case of the following RGB signals.
  - UXGA signal image
  - Interlaced signal
  - DTV (480P/720P/1080i)
- You can only use the following functions while in Picture in Picture mode.
  - FREEZE: Works for the inset picture only.
  - TOOLS: Works with Picture in Picture, but the cursor is used for TOOLS. The inset picture cannot be moved.

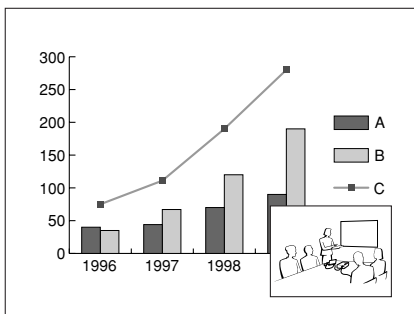



# Reducing Image Noise (VIDEO menu only)

## Projector

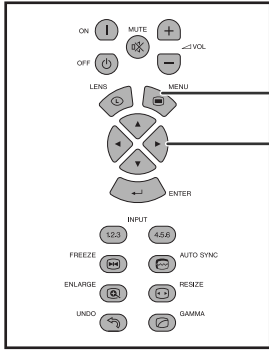

## Remote Control

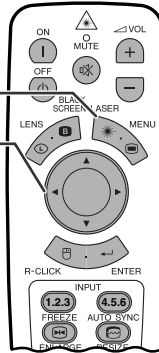

3D Digital Noise Reduction (3D DNR) provides high quality images with minimal dot crawl and cross color noise.

(Slide the **MOUSE/ADJUSTMENT** switch on the remote control to the ADJ. position.)



- ① Press **MENU**.
- ② Press ◀▶ to select "Options (1)".
- ③ Press ▲/▼ to select "3D DNR", and then select "0".
- ④ To exit from the GUI, press **MENU**.

## (GUI) On-screen Display

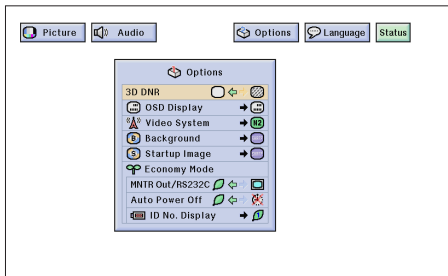

### NOTE

- If the image is clear, select "0" to prevent any blurring.





# Turning On/Off the On-screen Display

## Projector

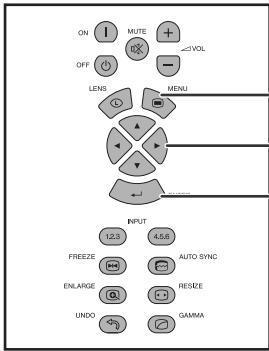

## Remote Control

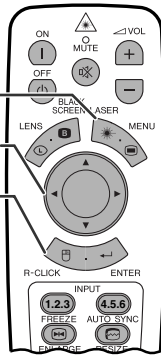

This function allows you to turn on or off the on-screen messages that appear during input select.

### Description of OSD Display

Selected item	Description
Normal	All On-screen Display are displayed.
Level A	<b>INPUT, CUSTOM, FREEZE, ENLARGE, AUTO SYNC, VOLUME, MUTE, BLACK SCREEN</b> are not displayed.
Level B	All On-screen Display are not displayed (except <b>MENU, TOOLS, LENS</b> and warning display ( <b>Power off, Temp., Lamp</b> etc.)).

(Slide the **MOUSE/ADJUSTMENT** switch on the remote control to the **ADJ.** position.)



### (GUI) On-screen Display

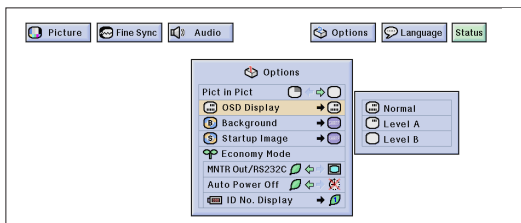

- 1 Press **MENU**.
- 2 Press **◀/▶** to select "Options (1)".
- 3 Press **▲/▼** to select "OSD Display", and then press **▶**.
- 4 Press **▲/▼** to select the desired On-screen Display.
- 5 Press **ENTER** to save the setting.
- 6 To exit from the GUI, press **MENU**.



# Setting the Video Signal (VIDEO menu only)

## Projector

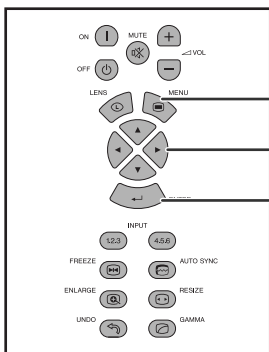

## Remote Control

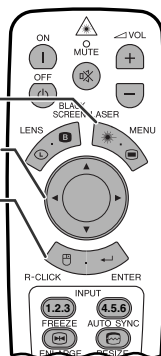

The video input system mode is preset to "Auto"; however, it can be changed to a specific system mode if the selected system mode is not compatible with the connected audiovisual equipment.

(Slide the **MOUSE/ADJUSTMENT** switch on the remote control to the **ADJ.** position.)

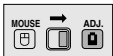

### (GUI) On-screen Display

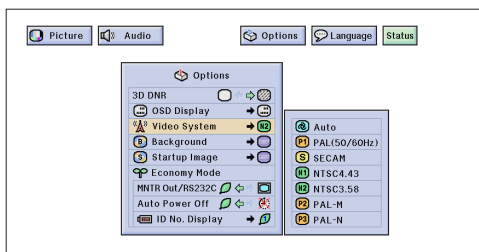

- 1 Press **MENU**.
- 2 Press **◀/▶** to select "Options (1)".
- 3 Press **▲/▼** to select "Video System", and then press **▶**.
- 4 Press **▲/▼** to select the desired video system mode.
- 5 Press **ENTER** to save the setting.
- 6 To exit from the GUI, press **MENU**.

### NOTE

- When the system mode is set to "Auto", you may not receive a clear picture due to signal differences. Should this occur, switch to the video system of the source signal.
- AUTO cannot be set for PAL-M and PAL-N input signals. Select "PAL-M" or "PAL-N" in "Video System" menu for PAL-M and PAL-N input signals.



# Selecting a Background Image

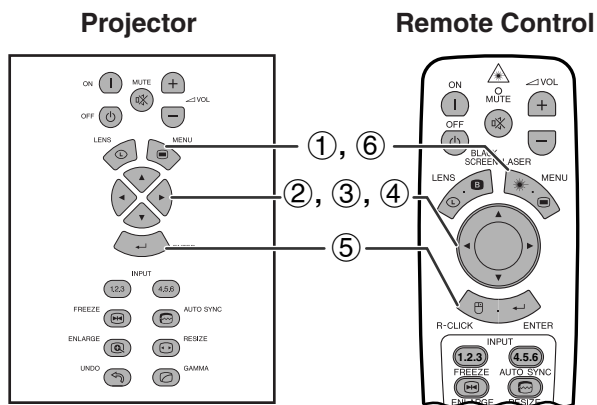

## (GUI) On-screen Display

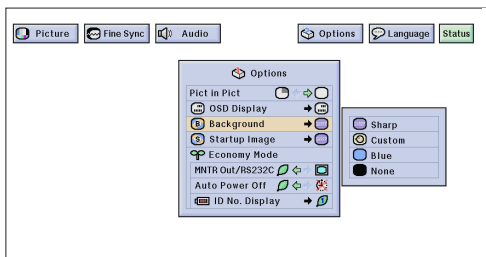

This function allows you to select the image displayed when no signal is being sent to the projector.

## Description of Background Images

Selected item	Description
Sharp	SHARP default image
Custom	User customized image (i.e. company logo)
Blue	Blue screen
None	Black screen

(Slide the **MOUSE/ADJUSTMENT** switch on the remote control to the ADJ. position.)



- ① Press **MENU**.
- ② Press **◀/▶** to select "Options (1)".
- ③ Press **▲/▼** to select "Background", and then press **▶**.
- ④ Press **▲/▼** to select the background image you want to display on the screen.
- ⑤ Press **ENTER** to save the setting.
- ⑥ To exit from the GUI, press **MENU**.

### NOTE

- By selecting "Custom", the projector can display a custom image (i.e. your company logo) as the background image. The custom image must be a 256-color BMP file with a picture size no larger than 1,024 × 768 pixels. Please see the Sharp Advanced Presentation Software operation manual for how to save (or change) a custom image.



# Selecting a Startup Image

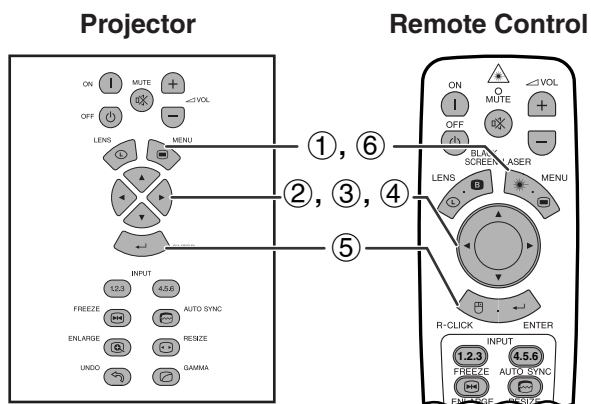

## (GUI) On-screen Display

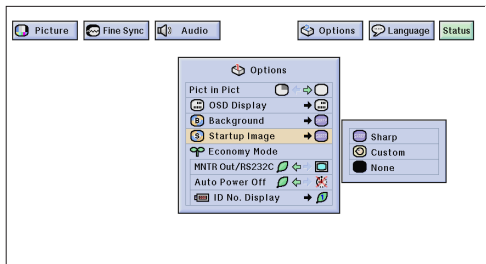

- This function allows you to specify the image to be displayed upon the projector's startup.
- A custom image (i.e. your company logo) can be uploaded to the projector via an RS-232C cable. See page 16 in this operation manual, and also the supplied Sharp Advanced Presentation Software operation manual for detailed instructions.

## Description of Startup Images

Selected item	Description
Sharp	SHARP default image
Custom	User customized image (i.e. company logo)
None	Black screen

(Slide the **MOUSE/ADJUSTMENT** switch on the remote control to the ADJ. position.)



- ① Press **MENU**.
- ② Press **◀/▶** to select "Options (1)".
- ③ Press **▲/▼** to select "Startup Image", and then press **▶**.
- ④ Press **▲/▼** to select the startup image you want to display on the screen.
- ⑤ Press **ENTER** to save the setting.
- ⑥ To exit from the GUI, press **MENU**.

### NOTE

- By selecting "Custom", the projector can display a custom image (i.e. your company logo) as the startup image. The custom image must be a 256-color BMP file with a picture size no larger than 1,024 × 768 pixels. Please see the Sharp Advanced Presentation Software operation manual for how to save (or change) a custom image.





# Selecting the Economy Mode

## Projector

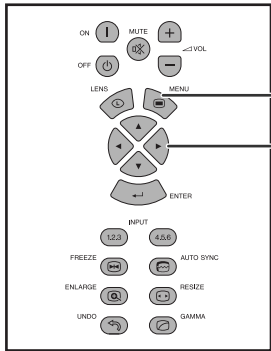

## Remote Control

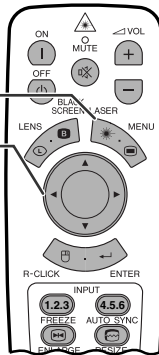

These functions allow you to reduce the power consumption when the projector is in standby mode.

## Monitor Out/RS-232C Off Function

This projector consumes power when using a monitor connected to the OUTPUT port for INPUT 1, 2 and a computer connected to the RS-232C port. When not using these ports, "MNTR Out/RS232C" can be set to "🌿" to reduce standby power consumption.

### Description of Monitor Out/RS-232C Off

	Standby power for Monitor Out/RS-232C connection turned off.
	Monitor Out/RS-232C on

## (GUI) On-screen Display

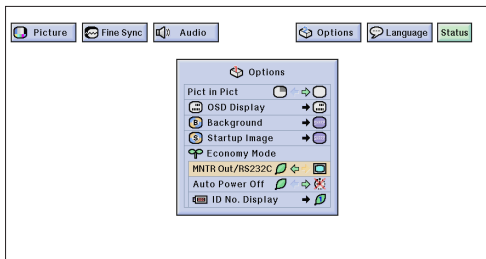

(Slide the **MOUSE/ADJUSTMENT** switch on the remote control to the ADJ. position.)



- 1 Press **MENU**.
- 2 Press **◀/▶** to select "Options (1)".
- 3 Press **▲/▼** to select "MNTR Out/RS232C".
- 4 Press **◀/▶** to select "🌿" or "🖥️".
- 5 To exit from the GUI, press **MENU**.

### CAUTION

- Set "MNTR Out/RS232C" to "🖥️" when using the Sharp Advanced Presentation Software (supplied).

## On-screen Display

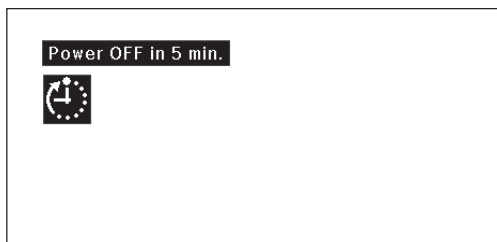

## (GUI) On-screen Display

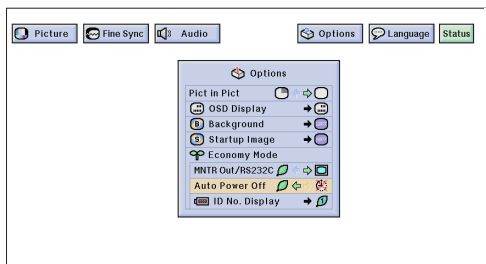

## Automatic Power Shutoff Function

When no input signal is detected for more than 15 minutes, the projector will automatically shut off. The on-screen message on the left will appear five minutes before the power is automatically turned off.

### Description of Automatic Power Shutoff

	Power automatically shuts off after 15 minutes of no signal input.
	Automatic Power Shutoff disabled.

(Slide the **MOUSE/ADJUSTMENT** switch on the remote control to the ADJ. position.)



- 1 Press **MENU**.
- 2 Press **◀/▶** to select "Options (1)".
- 3 Press **▲/▼** to select "Auto Power Off".
- 4 Press **◀/▶** to select "🌿" or "🚫".
- 5 To exit from the GUI, press **MENU**.

### NOTE

- "MNTR Out/RS232C" is factory preset to "🖥️", and "Auto Power Off" is factory preset to "🌿".





## Selecting the Economy Mode

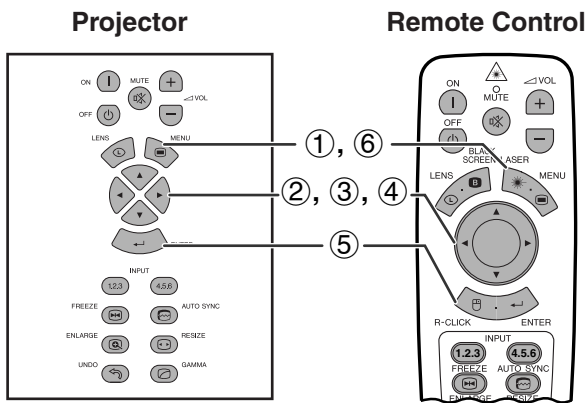

### (GUI) On-screen Display

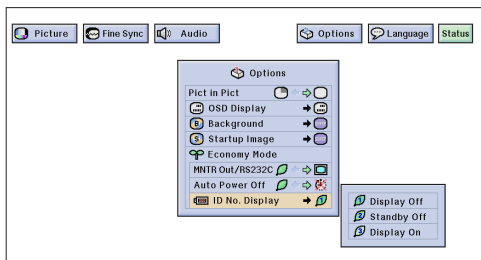

## ID No. Display Off Function

The LED ID number display on the rear of the projector, used when controlling multiple projectors, can be turned on or off.

### Description of ID No. Display

Selected item	Description
Display Off	Not displayed
Standby Off	Displayed except when the projector is in standby mode.
Display On	Always displayed

(Slide the **MOUSE/ADJUSTMENT** switch on the remote control to the ADJ. position.)

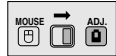

- 1 Press **MENU**.
- 2 Press ◀▶ to select "Options (1)".
- 3 Press ▲/▼ to select "ID No. Display", and then press ▶.
- 4 Press ▲/▼ to select "Display Off", "Standby Off" or "Display On".
- 5 Press **ENTER** to save the setting.
- 6 To exit from the GUI, press **MENU**.



## Reversing/Inverting Projected Images

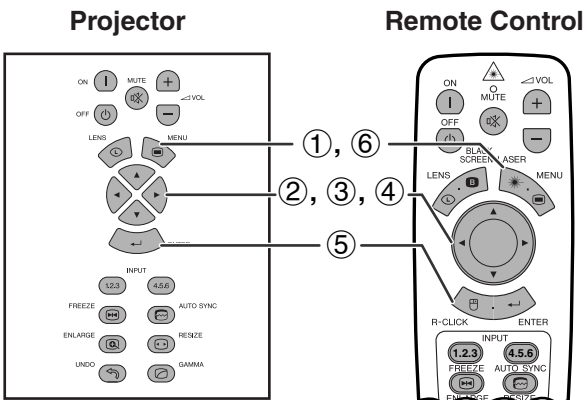

### (GUI) On-screen Display

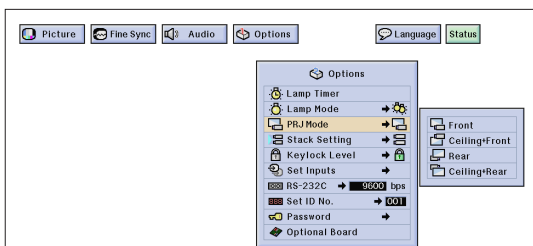

This projector is equipped with a reverse/invert image function which allows you to reverse or invert the projected image for various applications.

### Description of Projected Images

Selected item	Description
Front	Normal image
Ceiling + Front	Inverted image
Rear	Reversed image
Ceiling + Rear	Reversed and inverted image

(Slide the **MOUSE/ADJUSTMENT** switch on the remote control to the ADJ. position.)

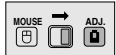

- 1 Press **MENU**.
- 2 Press ◀▶ to select "Options (2)".
- 3 Press ▲/▼ to select "PRJ Mode", and then press ▶.
- 4 Press ▲/▼ to select the desired projection mode.
- 5 Press **ENTER** to save the setting.
- 6 To exit from the GUI, press **MENU**.

### NOTE

- This function is used for the reversed image and ceiling-mount setups. See page 30 for these setups.





# Selecting the On-screen Display Language

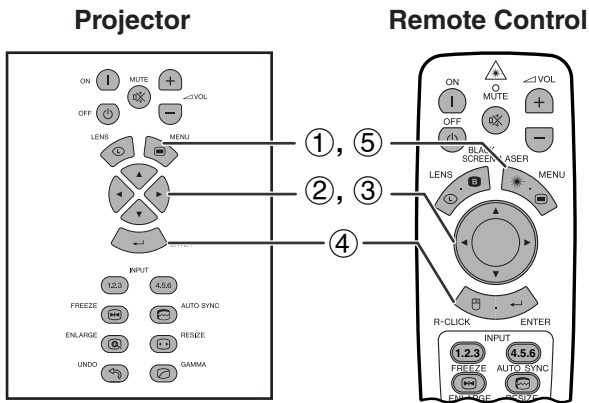

English is the preset language for the On-screen Display; however, this can be changed to German, Spanish, Dutch, French, Italian, Swedish, Portuguese, Chinese, Korean or Japanese.

(Slide the **MOUSE/ADJUSTMENT** switch on the remote control to the ADJ. position.)

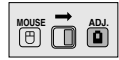

- ① Press **MENU**.
- ② Press **◀/▶** to select "Language".
- ③ Press **▲/▼** to select the desired language.
- ④ Press **ENTER** to save the setting. The On-screen Display is now programmed to display in the language selected.
- ⑤ To exit from the GUI, press **MENU**.

## (GUI) On-screen Display

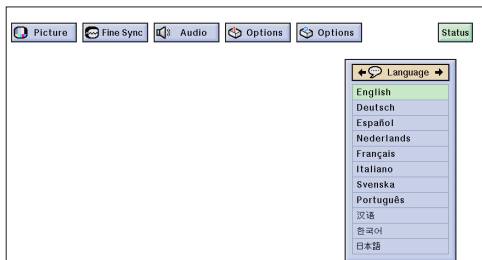



# Displaying the Adjustment Settings

## Projector

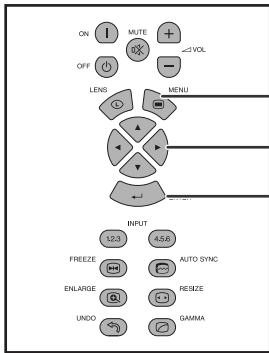

## Remote Control

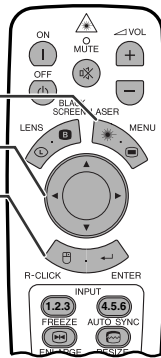

This function can be used to display all the adjusted settings on the screen simultaneously.

(Slide the **MOUSE/ADJUSTMENT** switch on the remote control to the **ADJ.** position.)

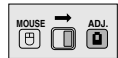

- ① Press **MENU**.
- ② Press **◀/▶** to select "Status".
- ③ Press **ENTER** to display all the adjustment settings.
- ④ To exit from the GUI, press **MENU**.

## (GUI) On-screen Display

### INPUT 1, 2 (RGB) or 3 (DIGITAL) mode

②

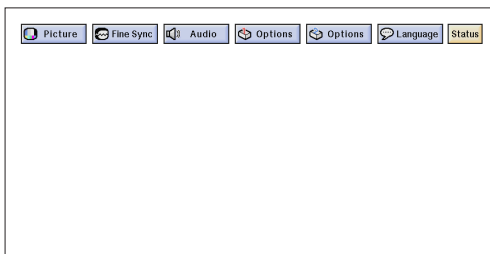

③

Picture	Fine Sync	Audio	Options	Options	Language
Contrast	0	Balance	0	Pict In Pict	6h, 6h
Brightness	0	Phase	0	Lamp Timer	Language
Red	0	Treble	0	OSD Display	Lamp Mode
Blue	0	Bass	0	Background	PRJ Mode
CLR Temp	0	Y-Pos	0	Startup Image	Stack Setting
Signal Type	0	Auto Sync	0	Keylock Level	Gamma
Progressive Mode	0	Auto Sync Disp	0	MNTR Out/RS232C	Normal
				Auto Power Off	Resize
				ID No. Display	9600bps
				RS-232C	RS-232C
				Set ID No.	001
				Password	

### INPUT 4, 5 (VIDEO) mode

②

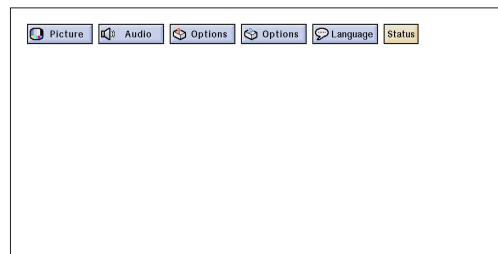

③

Picture	Audio	Options	Options	Language
Contrast	0	Balance	0	6h, 6h
Brightness	0	Treble	0	Language
Red	0	Bass	0	Lamp Mode
Blue	0	Y-Pos	0	PRJ Mode
CLR Temp	0	Auto Sync	0	Stack Setting
Signal Type	0	Auto Sync Disp	0	Gamma
Progressive Mode	0	Auto Sync Disp	0	Normal
				Resize
				9600bps
				RS-232C
				001
				Password





# Useful Features



## Locking the Operation Buttons on the Projector

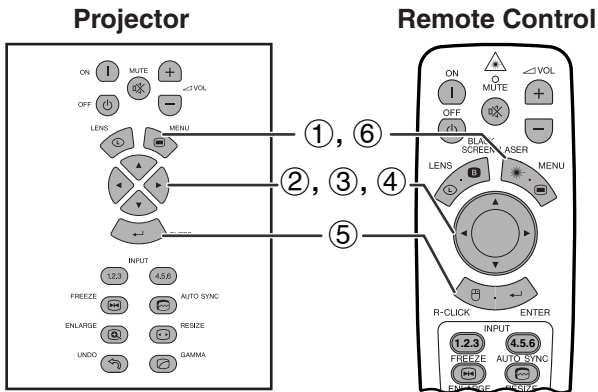

(GUI) On-screen Display

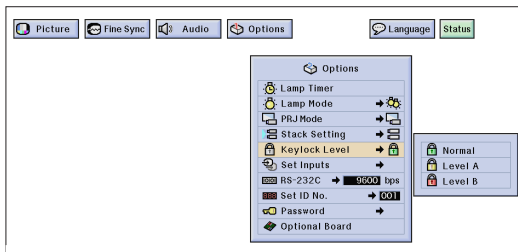

This function can be used to lock the use of certain operation buttons on the projector. The user can still operate the projector fully with the remote control.

### Description of Keylock Levels

Selected item	Description
<b>Normal</b>	All operation buttons are functional.
<b>Level A</b>	Only <b>INPUT</b> , <b>VOLUME</b> , <b>MUTE</b> , on the projector are available.
<b>Level B</b>	All operation buttons on the projector are unavailable.

(Slide the **MOUSE/ADJUSTMENT** switch on the remote control to the ADJ. position.)

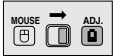

- ① Press **MENU**.
- ② Press ◀/▶ to select "Options (2)".
- ③ Press ▲/▼ to select "Keylock Level", and then press ▶.
- ④ Press ▲/▼ to select the desired level.
- ⑤ Press **ENTER** to save the setting.
- ⑥ To exit from the GUI, press **MENU**.

### NOTE

- To cancel the Keylock Level, perform the above procedure using the remote control.
- See page 61 for details using the password function.



## Deselecting Inputs

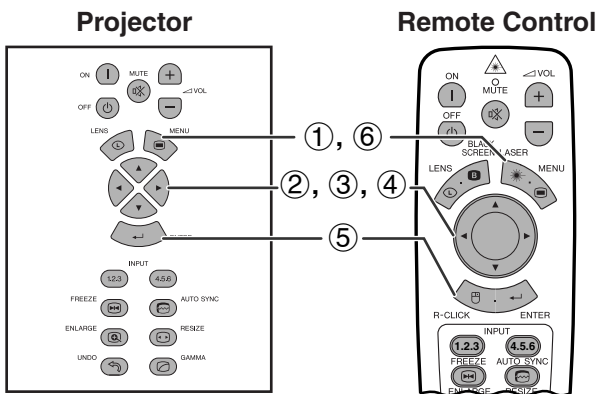

(GUI) On-screen Display

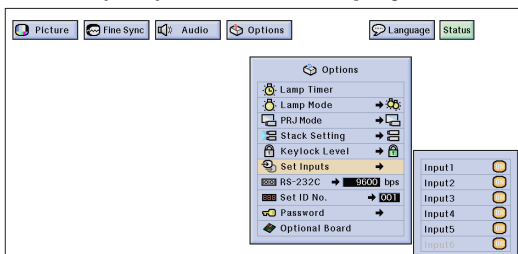

This function allows you to deselect unwanted signal input.

(Slide the **MOUSE/ADJUSTMENT** switch on the remote control to the ADJ. position.)

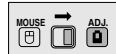

- ① Press **MENU**.
- ② Press ◀/▶ to select "Options (2)".
- ③ Press ▲/▼ to select "Set Inputs", and then press ▶.
- ④ Press ▲/▼ to select the input you want to set to block.
- ⑤ Press **ENTER** to select "ON" or "OFF".
- ⑥ To exit from the GUI, press **MENU**.

### NOTE

- Input 6 can be selected only when an SDI board is installed. Otherwise it is displayed in gray.
- When stack projecting, multi-screen projecting and so on, this function can be used to cancel the RS-232C control.
- Up to two input signals can be blocked for both Input 1, 2, 3 or Input 4, 5, 6.
- For details on intended purpose, see pages 67 and 68.



# Selecting the Transmission Speed (RS-232C)

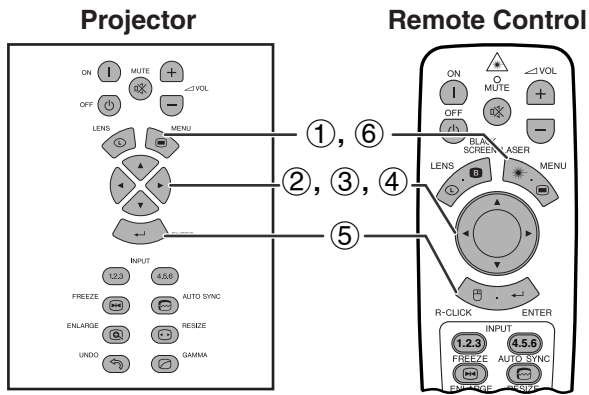

This menu allows you to adjust the transmission speed of the RS-232C connection by selecting the baud rate.

(Slide the **MOUSE/ADJUSTMENT** switch on the remote control to the ADJ. position.)



- ① Press **MENU**.
- ② Press ◀▶ to select “Options (2)”.
- ③ Press ▲/▼ to select “RS-232C”, and then press ▶.
- ④ Press ▲/▼ to select the desired baud rate.
- ⑤ Press **ENTER** to save the setting.
- ⑥ To exit from the GUI, press **MENU**.

## (GUI) On-screen Display

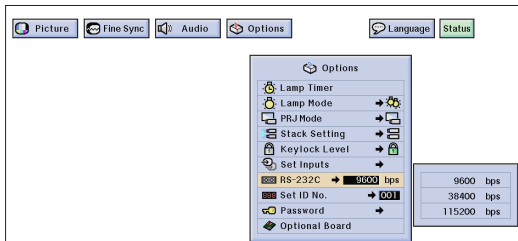

### NOTE

- Make sure that both the projector and computer are set for the same baud rate. Refer to the computer's operation manual for instructions for setting the baud rate.





# Protecting Important Settings with a Password

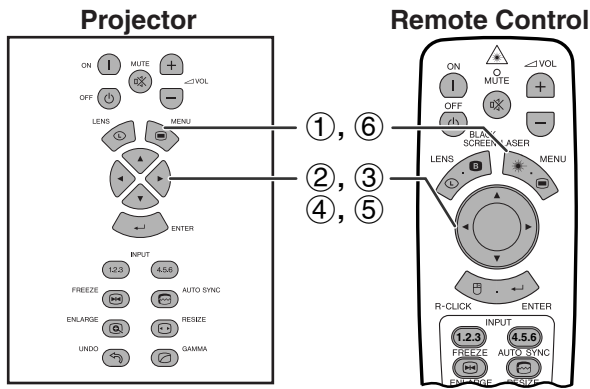

A password can be set by the user and used with the keylock level to prevent adjustments to certain settings on the GUI.

## NOTE

- When password is set, you need to enter the password to use "Lamp Mode", "PRJ Mode", "Stack Setting", "Keylock Level", "Set Inputs", "RS-232C" and "Set ID No." menus.

## Setting the Password

(Slide the **MOUSE/ADJUSTMENT** switch on the remote control to the ADJ. position.)

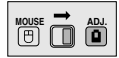

### (GUI) On-screen Display Setting the Password

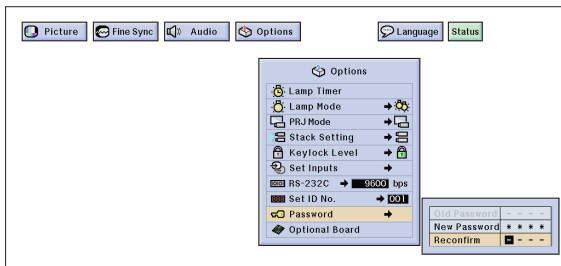
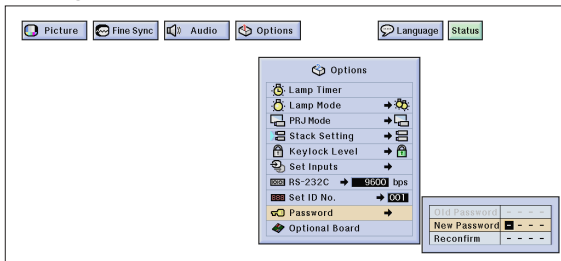

- Press **MENU**.
- Press **◀/▶** to select "Options (2)".
- Press **▲/▼** to select "Password", and then press **▶**.
- Enter the new password using **▲/▼** to select the desired number, and then press **▶** to select the next digit. Continue this procedure for the remaining three digits, and then press **ENTER**.
- Enter the password again ("Reconfirm") using **▲/▼/◀/▶**, and then press **ENTER**.
- To exit from the GUI, press **MENU**.

## NOTE

- After setting the password, be sure to write it down in a secure location in case you can not remember it.

### Changing the Password

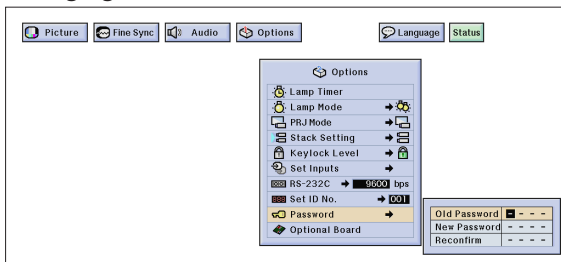

## Changing the Password

(Slide the **MOUSE/ADJUSTMENT** switch on the remote control to the ADJ. position.)

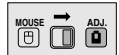

- Follow steps ① to ③ in "Setting the Password" above.
- Enter the old password using **▲/▼/◀/▶**, and then press **ENTER**.
- Enter the new password using **▲/▼/◀/▶**, and then press **ENTER**.
- Enter the password again ("Reconfirm") using **▲/▼/◀/▶**, and then press **ENTER**.



# Network Function



## Setting Up the Optional Boards

Three optional Expansion Boards from Sharp are also available for specialized application. Please see your local Sharp Industrial LCD Products Dealer for details on these boards. Be sure to have service personnel install optional boards.

### Boards for Network Capability

#### RS-422 Board

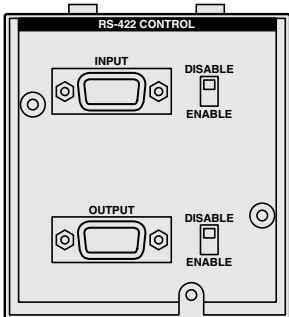

#### LAN Board



### Expansion Video Board

#### SDI (Serial Digital Interface)

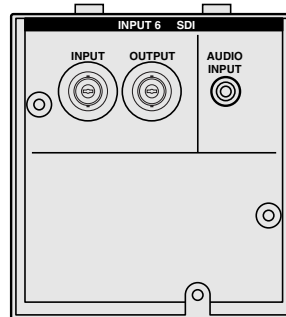

#### Projector

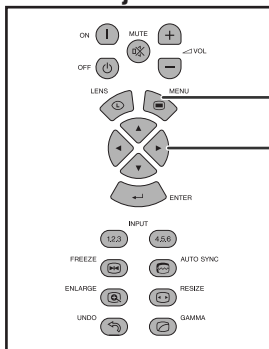

#### Remote Control

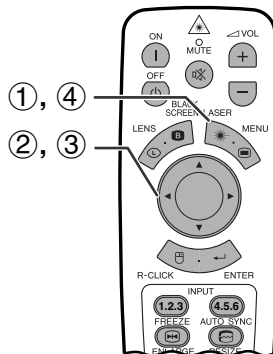

The **Optional Board** function allows you to set and confirm the optional boards.

(Slide the **MOUSE/ADJUSTMENT** switch on the remote control to the ADJ. position.)



- ① Press **MENU**.
- ② Press ◀▶ to select "Options (2)".
- ③ Press ▲▼ to select "Optional Board".
- ④ To exit from the GUI, press **MENU**.

The type of board and the board status are displayed as shown below.

#### (GUI) On-screen Display

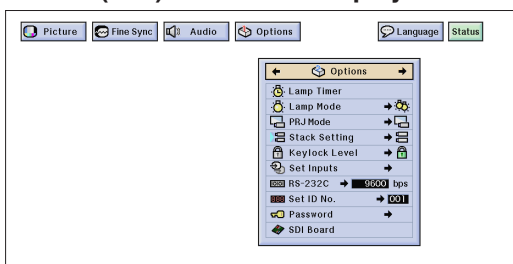

e.g. when installing SDI board

- **LAN Board (10BASE-T)**  
Set the IP Address, Gateway and Subnet mask in accordance with the sub menu.
- **SDI Board**  
The status of the SDI Board is displayed.
- **RS-422 Board**  
The input and output control signals are displayed.

#### NOTE

- For details on intended purpose, see the optional boards operation manuals.





# Controlling Multiple Projectors with ID Numbers

## Projector

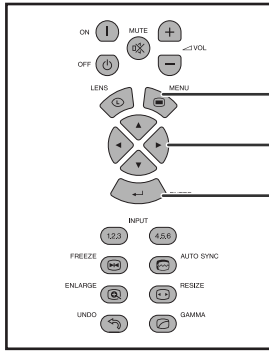

## Remote Control

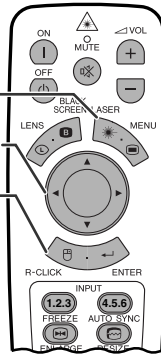

This projector can form a network of up to 250 projectors. To identify separately and control specified projector, you need to set ID No.. The ID No. you set is displayed on the LED.

(Slide the **MOUSE/ADJUSTMENT** switch on the remote control to the ADJ. position.)



## Setting the ID No.

- ① Press **MENU**.
- ② Press **◀/▶** to select "Options (2)".
- ③ Press **▲/▼** to select "Set ID No.". (The ID No. is factory preset to "001".)
- ④ Press **▶** to select the first digit and **▲/▼** to select the desired number. Continue this procedure for the remaining two digits.
- ⑤ Press **ENTER** to save the setting.
- ⑥ To exit from the GUI, press **MENU**.

### NOTE

- When ID NO. is not be displayed, refer to the setting of "ID No. Display". See page 56 for setting "Display Off" function.
- The ID No. can be set from 001 to 250.
- For details on intended purpose, see pages 65 to 68.

## (GUI) On-screen Display

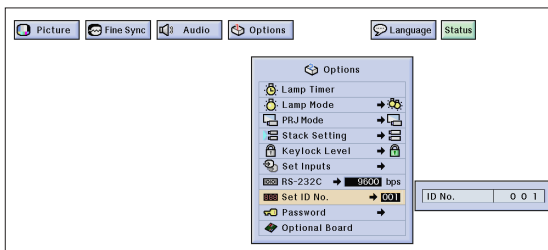

# Setting the Stacking Mode

## Projector

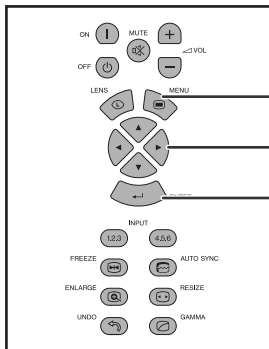

## Remote Control

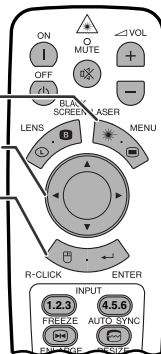

You can double the brightness of an image by stacking two projectors and projecting same picture simultaneously. To control two projectors, assign one as the master and one as the slave. The slave projector will duplicate any operational settings made to the master projector.

(Slide the **MOUSE/ADJUSTMENT** switch on the remote control to the ADJ. position.)

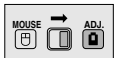

- ① Press **MENU**.
- ② Press **◀/▶** to select "Options (2)".
- ③ Press **▲/▼** to select "Stack Setting", and then press **▶**.
- ④ Press **▲/▼** to select "Normal", "Master" or "Slave".
- ⑤ Press **ENTER** to save the setting.
- ⑥ To exit from the GUI, press **MENU**.

### NOTE

- When the projector is set to "Master", button operation signals will be transmitted through RS-232C.
- When the projector is set to "Slave", operations follow the button operations sent from the "Master".
- If you set slave, only **▲/▼/◀/▶**, **ENTER**, **UNDO**, **Power ON**, **Power OFF**, **LENS** and **MENU** can be used. Other buttons cannot be used and are controlled by the master projector or computer through the RS-232C connection.
- For details on intended purpose, see pages 67 and 68.

## (GUI) On-screen Display

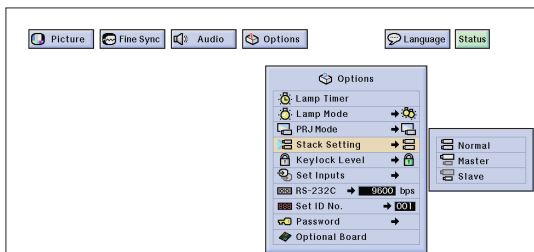





# Using the Presentation Tools

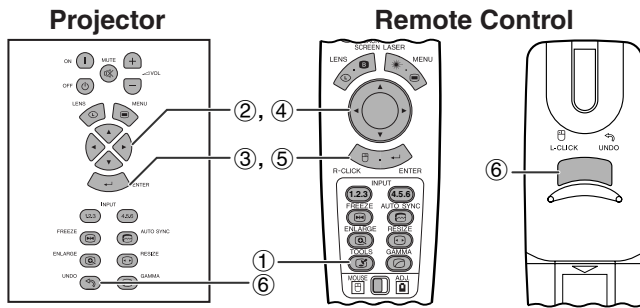

## On-screen Display

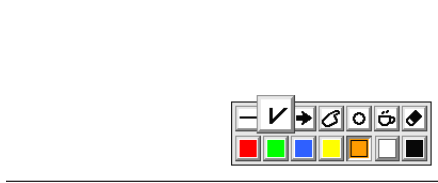

## Menu Window

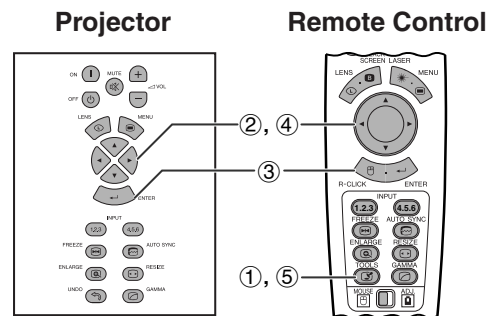
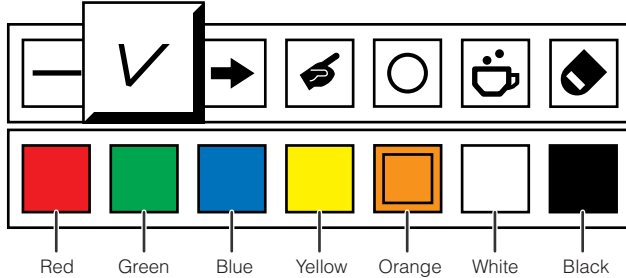

## When selecting Sharp default image



This projector is equipped with presentation tools that can be used to emphasize keypoints within your presentation.

(Slide the **MOUSE/ADJUSTMENT** switch on the remote control to the ADJ. position.)

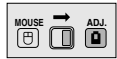

- ① Press **TOOLS** to display the presentation tools menu window on the screen.
- ② Press **▲/▼/◀/▶** to select the desired tool and color.
- ③ Press **ENTER** to select it.
- ④ Once the tool is displayed on the screen, press **▲/▼/◀/▶** to move it around the screen.
- ⑤ Press **ENTER** to stamp the tool on the screen.
- ⑥ Press **UNDO** to individually delete tools stamped on the screen.

## NOTE

- You can stamp each tool as many times as you want on the screen.
- To clear all the stamped presentation tools from the screen, press **▲/▼/◀/▶** to select "☒" and then press **ENTER**.

## Displaying the Break Time

(Slide the **MOUSE/ADJUSTMENT** switch on the remote, control to the ADJ. position.)

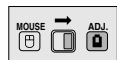

- ① Press **TOOLS** to display the presentation tools menu window on the screen.
- ② Press **▲/▼/◀/▶** to select "☒" in the menu window.
- ③ Press **ENTER** to start counting down the break time.
- ④ Press **▲** to increase or **▼** to decrease the break time.
- ⑤ To return to normal screen, press **TOOLS**.

## NOTE

- The break time is displayed against the background image selected in "Selecting a Startup Image". (See page 54.)





# Operating the Network Function

This projector has outstanding network capability.

- Internet access for self-diagnosis
- Multiple and group projector control
- Simultaneous multiple projector control

## 1. Internet access for self-diagnosis, status information and preventive maintenance

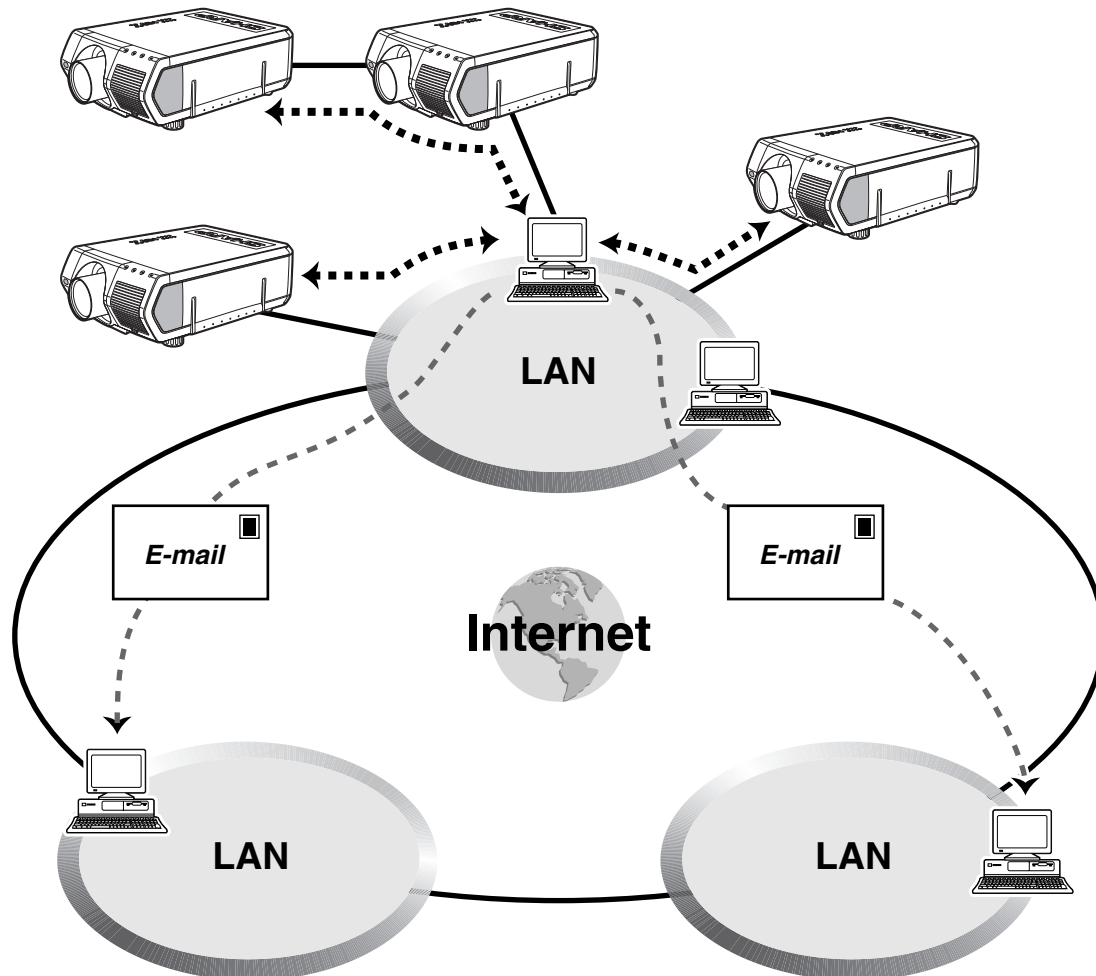

This projector can be used in a network of up to 250 projectors managed from a single PC with the accompanied Sharp Advanced Presentation Software—Professional Edition. This projector can be connected to a PC using an RS-232C, RS-422, or LAN (10BASE-T) connection. (An optional board is required for RS-422 or LAN connection.) Output terminals are provided (RS-232C on the projector, RS-422 on the optional board) enabling a daisy chain configuration and eliminating the need for a distributor. The projector can also be managed over a network via an Ethernet connection.

This projector is also equipped with a function to send status information (lamp usage time, etc.) to a Sharp Service Center or outside contractor for quick and efficient customer service.

### NOTE

- For more information on these features, see the operation manuals accompanying the Sharp Advanced Presentation Software—Professional Edition and optional boards.





## 2. Multiple and group projector control via computer

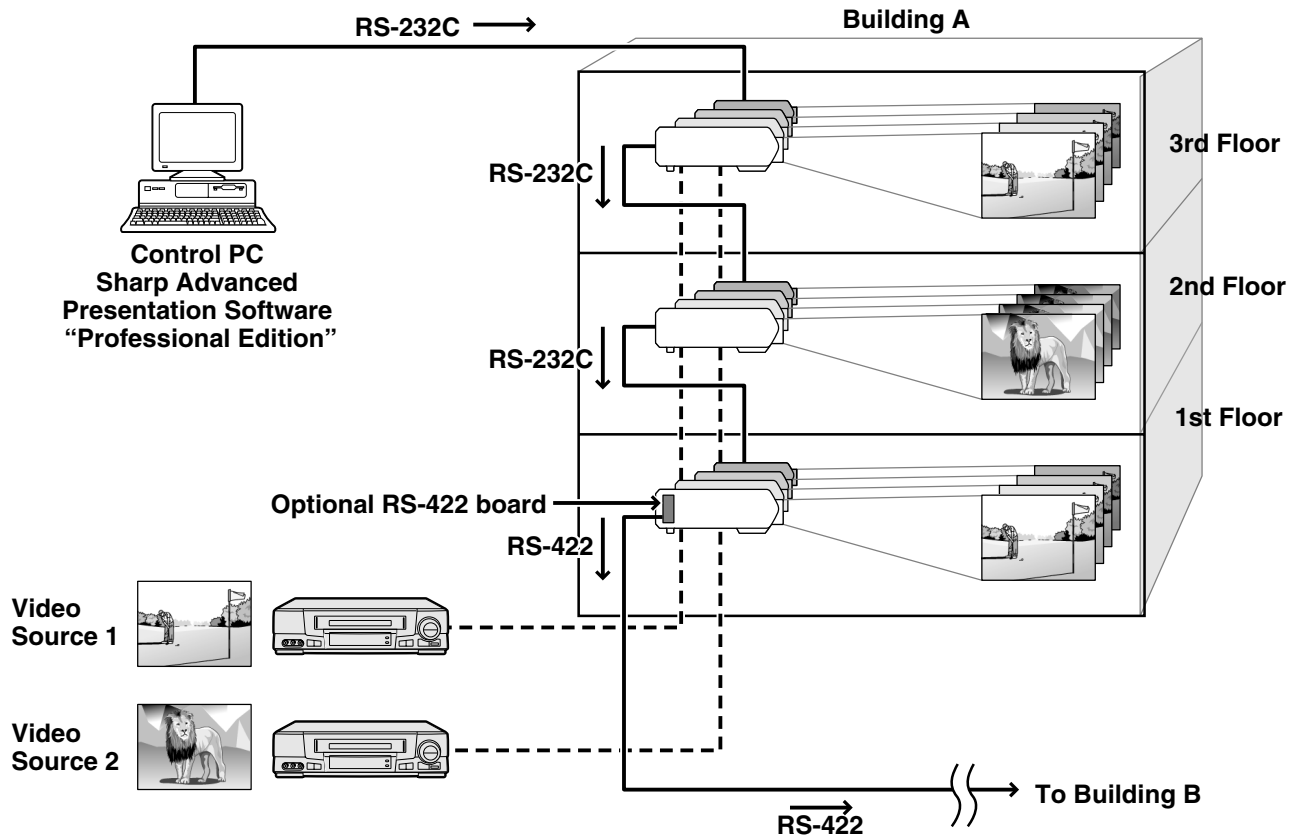

This projector can be used in a network of projectors managed from a single PC with the accompanied Sharp Advanced Presentation Software—Professional Edition. Projectors in conference rooms on the first and third floors of a building, for example, can be used for video presentations, while projectors on the second floor can be used for PC-assisted presentations. Projectors can even be powered down at different times (e.g., projectors on the first and second floors are powered down in one hour, while those on the third floor are powered down in two hours). An optional RS-422 board enables control of group projectors on different floors or buildings via cables connecting up to 3,937 feet (1.2 km), and an optional LAN board can provide management of projectors over an existing network.

### NOTE

- For more information on these features, see the operation manuals accompanying the Sharp Advanced Presentation Software—Professional Edition and optional RS-422 board.





### 3. Simultaneous multiple projector control for stacking and videowall projection

#### Stack Projection

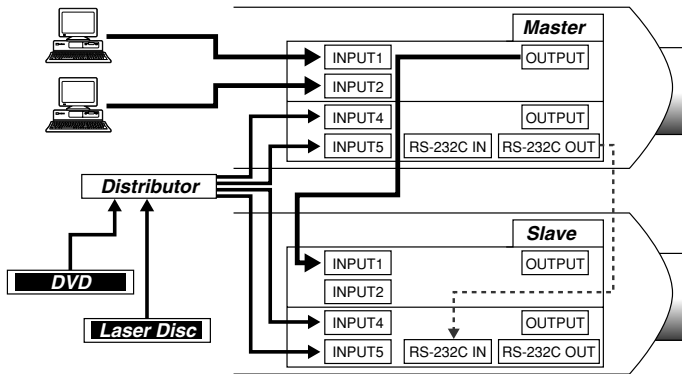
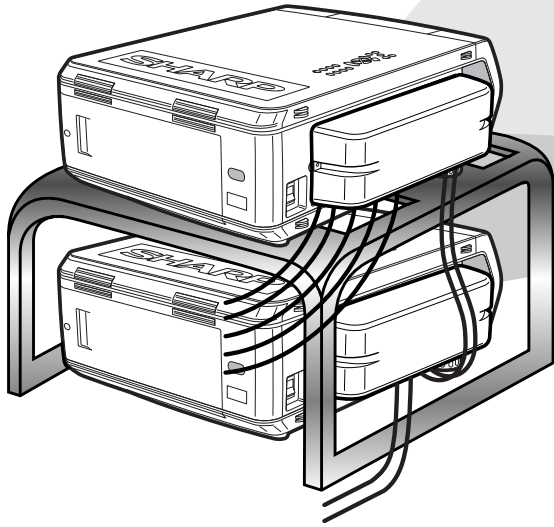

Stack Setting
<b>Master</b>

Set Inputs	
INPUT1	Yes
INPUT2	Yes
INPUT3	<b>No</b>
INPUT4	Yes
INPUT5	Yes
INPUT6	No

Stack Setting
<b>Slave</b>

Set Inputs	
INPUT1	Yes
INPUT2	<b>No</b>
INPUT3	<b>No</b>
INPUT4	Yes
INPUT5	Yes
INPUT6	No

For brighter images, two projectors can be stacked using the Stack Setting function, with one projector set as the Master and the other as the Slave. The operations of the Slave projector are controlled by the Master projector during projection through an RS-232C connection. The RS-232C cable (null modem, cross type, sold separately) is connected from the RS-232C output on the Master projector to the RS-232C input on the Slave projector.

Projectors can be stacked using an RS-232C cable (null modem, cross type, sold separately).

**NOTE**

- See page 59, "Deselecting Inputs", and page 63, "Setting the Stacking Mode".



## Videowall

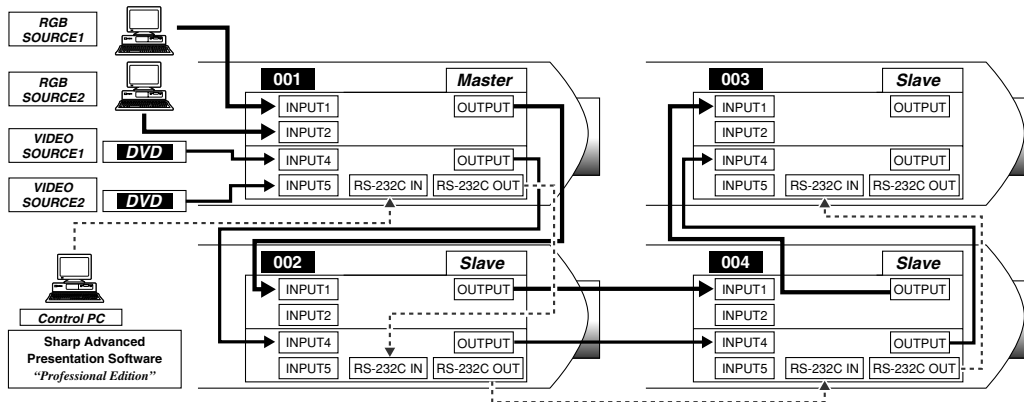
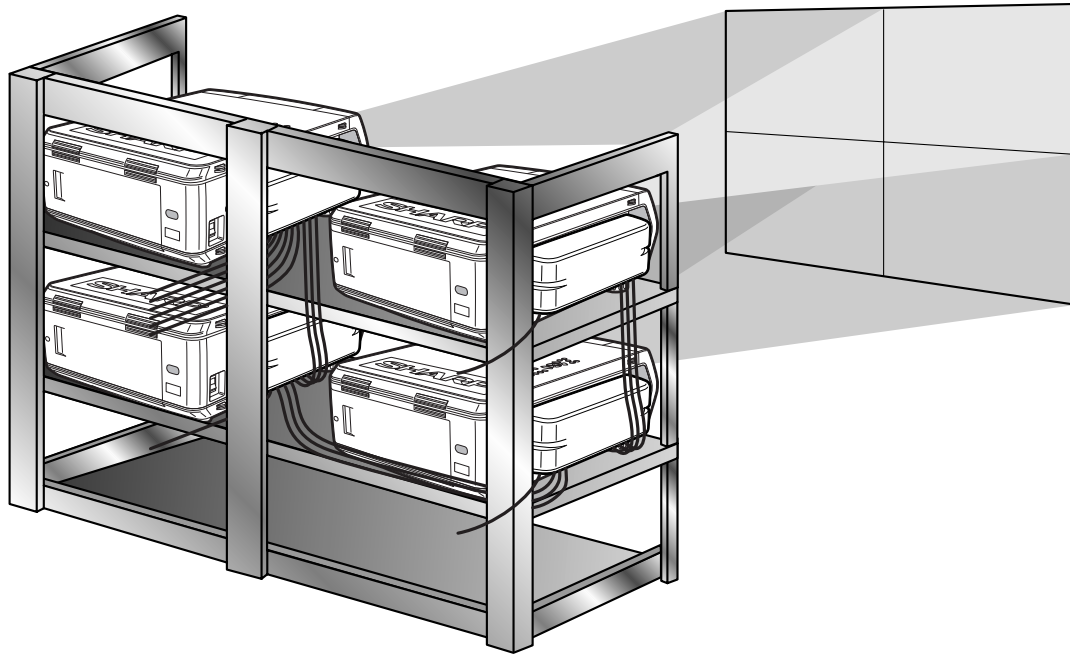

<b>Master</b>	
Set Inputs	
INPUT1	Yes
INPUT2	Yes
INPUT3	No
INPUT4	Yes
INPUT5	Yes
INPUT6	No

<b>Slave</b>	
Set Inputs	
INPUT1	Yes
INPUT2	No
INPUT3	No
INPUT4	Yes
INPUT5	No
INPUT6	No

This projector can be used together with other projectors managed using the accompanied Sharp Advanced Presentation Software—Professional Edition to create a videowall projection. Whereas conventional videowall technology required the use of an image distributor, this projector videowall feature enables easy image settings from a PC when inputting a single video source. This function greatly simplifies videowall setup. RS-232C OUTPUTS also realize the simple daisy chain connection. The master projector directly connected to the computer can make the daisy chain connection with multiple slave projectors. For details on setting master or slave, see page 63.

- Use a videowall projector stand, sold separately, when using this function.
- Image quality may deteriorate when picture signals are input through multiple projectors in a daisy chain connection.

### NOTE

- For more information on this feature, see the operation manuals accompanying the Sharp Advanced Presentation Software—Professional Edition.
- When UXGA signal is displayed, the videowall can not be set by Sharp Advanced Presentation Software—Professional Edition.





# Lamp/Maintenance Indicators

## Maintenance Indicators

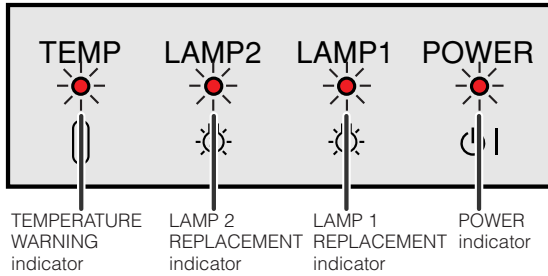

- The warning lights on the projector indicate problems inside the projector.
- There are three warning lights: a TEMPERATURE WARNING indicator that warns you when the projector is too hot, and two LAMP REPLACEMENT indicators that warn you when to change a lamp.
- If a problem occurs, either the TEMPERATURE WARNING indicator or the LAMP REPLACEMENT indicators will light up red. After turning off the power, follow the procedures given below.

Maintenance Indicator	Condition	Problem	Possible Solution
TEMPERATURE WARNING indicator	The internal temperature is abnormally high.	• Blocked air intake.	• Relocate the projector to an area with proper ventilation.
		• Clogged air filter.	• Replace the filter. (See page 73.)
		• Cooling fan breakdown. • Internal circuit failure.	• Take the projector to your nearest Authorized Sharp Industrial LCD Products Dealer or Service Center for repair.
LAMP REPLACEMENT indicator	The lamp does not light up.	• Burnt-out lamp. • Lamp circuit failure.	• Carefully replace the lamp. (See pages 71 and 72.)
	The lamp requires replacement.	• Lamp has been used for over 900 hours.	• Take the projector to your nearest Authorized Sharp Industrial LCD Products Dealer or Service Center for repair.
POWER indicator	The POWER indicator flashes in red when the projector is on.	• The filter cover is open.	• Securely install the filter cover.
		• The lens cover* is not securely installed.	• Securely install the lens cover.

\* The lens cover is as shown below.

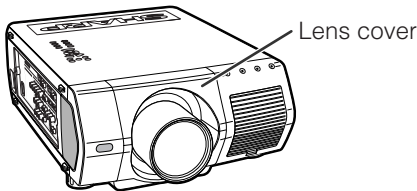

### NOTE

- If the TEMPERATURE WARNING indicator lights up, follow the above possible solutions and then wait until the projector has cooled down completely before turning the power back on. (At least 5 minutes.)
- If the power is turned off and then turned on again, as during a brief rest, the LAMP REPLACEMENT indicators may be triggered, preventing the power from going on. Should this occur, take the power cord out of the wall outlet and put it back in again.





# Lamp Maintenance



## Confirming the Lamp Usage Time

### Lamp

The lamp in this projector operates for approximately 1,000 cumulative hours, depending on the usage environment. (As the usage environment can vary significantly, the projector lamp may not operate for 1,000 hours.) It is recommended that the lamp be replaced after approximately 900 cumulative hours of use or when you notice a significant deterioration of the picture and color quality. The lamp usage time can be checked with the On-screen Display.

### CAUTION

- Intense light hazard. Do not attempt to look into the aperture and lens while the projector is operating.

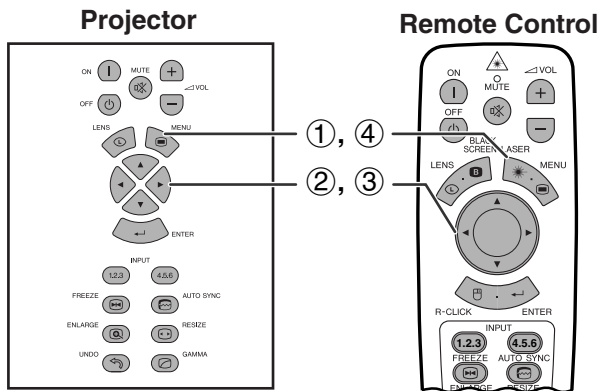

This function allows you to check the accumulated lamp usage time.

(Slide the **MOUSE/ADJUSTMENT** switch on the remote control to the ADJ. position.)

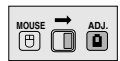

- Press **MENU**.
- Press **◀/▶** to select "Options (2)".
- Press **▲/▼** to select "Lamp Timer". The lamp usage time will be displayed.
- To exit from the GUI, press **MENU**.

### (GUI) On-screen Display

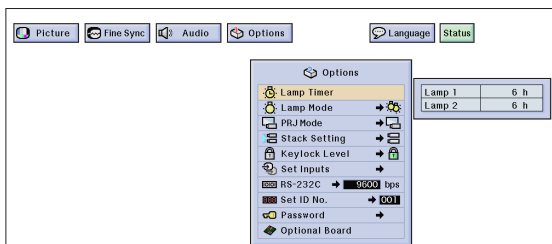

### NOTE

- It is recommended that the lamp be replaced after approximately 900 cumulative hours of use. See pages 71 and 72 for lamp replacement.

Condition	Problem	Possible Solution
The LAMP REPLACEMENT indicator lights up red, and "LAMP" and "⚠" will flash in yellow in the lower-left corner of the picture.	<ul style="list-style-type: none"> <li>Lamp has been used for over 900 hours.</li> </ul>	<ul style="list-style-type: none"> <li>Purchase a replacement lamp unit (lamp/cage module) of the current type BQC-XGV10WU/1 from your nearest Authorized Sharp Industrial LCD Products Dealer or Service Center.</li> <li>Replace the lamp. (See pages 71 and 72.) If you wish, you may have the lamp replaced at your nearest Authorized Sharp Industrial LCD Products Dealer or Service Center.</li> </ul>
A significant deterioration of the picture and color quality occurs.		
The power will automatically turn off and the projector will enter standby mode.	<ul style="list-style-type: none"> <li>Lamp has been used for over 1,000 hours.</li> </ul>	
"LAMP" and "⚠" will flash in red in the lower-left corner of the picture, and the power will turn off.		





# Setting the Lamp Mode

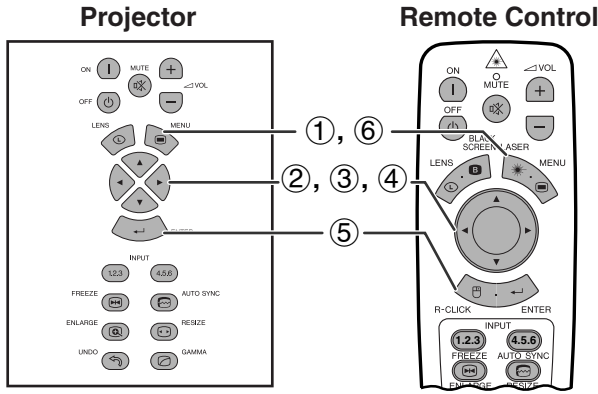

## (GUI) On-screen Display

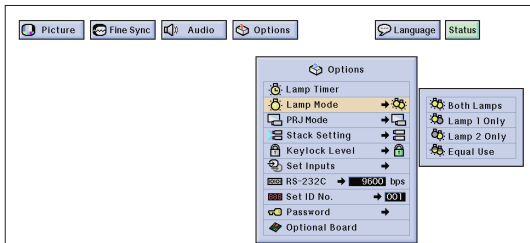

This function can be used to set the lamp mode. The mode can be set to double the effective lamp usage time.

## Description of Lamp Mode

Selected item	Description
<b>Both Lamps</b>	Both lamps are used for greater brightness.
<b>Lamp 1 Only</b>	Lamp 1 is used. When lamp 1 burns out, automatically switches to lamp 2.
<b>Lamp 2 Only</b>	Lamp 2 is used. When lamp 2 burns out, automatically switches to lamp 1.
<b>Equal Use</b>	Both lamps are used alternately. Switches after every 100 hrs. of use.

(Slide the **MOUSE/ADJUSTMENT** switch on the remote control to the ADJ. position.)



- ① Press **MENU**.
- ② Press **◀/▶** to select “Options (2)”.
- ③ Press **▲/▼** to select “Lamp Mode”, and then press **▶**.
- ④ Press **▲/▼** to select the desired Lamp Mode.
- ⑤ Press **ENTER** to save the setting.
- ⑥ To exit from the GUI, press **MENU**.

### NOTE

- In “Equal Use” mode, when the projector is used for more than 24 hrs. continuously, it switches in shift of 100 hrs.



# Replacing the Lamp

## CAUTION

- **Potential hazard of glass particles if lamp ruptures. In case of lamp rupture, contact your nearest Authorized Sharp Industrial LCD Products Dealer or Service Center for a replacement.**
- **Do not remove the lamp cage directly after operation of the projector. The lamp may be extremely hot. Wait at least one hour after the power cord is disconnected to allow the surface of the lamp cage to fully cool before removing the lamp cage.**

It is recommended that the lamp be replaced after approximately 900 cumulative hours of use or when you notice a significant deterioration of the picture and color quality. Carefully change the lamp by following the steps on the next page.

If the new lamp does not light after replacement, take your projector to the nearest Authorized Sharp Industrial LCD Products Dealer or Service Center for repair. Purchase a replacement lamp unit (lamp/cage module) of the current type BQC-XGV10WU/1 from your nearest Authorized Sharp Industrial LCD Products Dealer or Service Center. Then carefully change the lamp by following the instructions on the next page. If you wish, you may have the lamp replaced at your nearest Authorized Sharp Industrial LCD Products Dealer or Service Center.

### IMPORTANT NOTE TO U.S. CUSTOMERS:

The lamp included with this projector is backed by a 90-day parts and labor limited warranty. All service of this projector under warranty, including lamp replacement, must be obtained through an Authorized Sharp Industrial LCD Products Dealer or Service Center. For the name of the nearest Authorized Sharp Industrial LCD Products Dealer or Service Center, please call toll-free: 1-888-GO-SHARP (1-888-467-4277).

U.S.A. ONLY







## Replacing the Lamp

### Removing and installing the lamp unit

#### CAUTION

- Be sure to remove the lamp cage by the handle. Be sure not to touch the glass surface of the lamp cage or the inside of the projector.
- To avoid injury to yourself and damage to the lamp, be sure to carefully follow the steps below.
- Replace the lamp more safely by unplugging the power cord after turning off the main power.

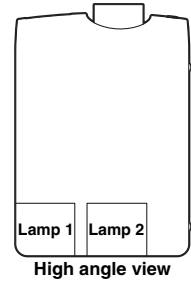

<p><b>1 Turn off the power.</b></p> <p>Press <b>POWER OFF</b>. Wait until the cooling fan stops.</p>	<p><b>2 Turn off the main power.</b></p> <p>Turn off the MAIN POWER switch. (Unplug the power cord.)</p>	<p><b>3 Remove the lamp cage cover.</b></p> <p>Loosen the user service screw that secures the lamp cage cover on the back of the projector. Then slide the cover in the direction of the arrow (to the open mark).</p>
<p><b>4 Remove the lamp cage.</b></p> <p>Remove the securing screws from the lamp cage. Hold the lamp cage by the handle and pull it horizontally towards you.</p>	<p><b>5 Attach the lamp cage cover and turn on the main power.</b></p> <p>Slide the lamp cage cover in the direction of the arrow (to the close mark) on the back of the projector. Then turn on the MAIN POWER switch.</p>	<p><b>6 Press POWER ON on projector. LAMP REPLACEMENT indicator flashes red. Then press ENTER to reset lamp timer.</b></p> <p>Press <b>POWER ON</b>, and then press <b>ENTER</b> on the projector.</p>
<p><b>7 Turn off the main power again and remove the lamp cage cover.</b></p> <p>Turn off the main power switch and slide the lamp cage cover in the direction of the arrow (to the open mark) on the back of the projector.</p>	<p><b>8 Insert the new lamp cage.</b></p> <p>Press the lamp cage firmly into the lamp cage compartment. Fasten the securing screws.</p>	<p><b>9 Attach the lamp cage cover.</b></p> <p>Slide the lamp cage cover in the direction of the arrow (to the close mark) on the back of the projector. Then tighten the user service screw.</p>

#### NOTE

- You need to reset lamp timer every time when replacing the lamp and confirm it to be reset on "Lamp Timer" menu.





# Replacing the Air Filter

- This projector is equipped with one air filter to ensure the optimal operating condition of the projector.
- The air filter should be exchanged after every 2,000 hours of use.
- Have your nearest Authorized Sharp Industrial LCD Products Dealer or Service Center exchange the filter (PFILD0110CEZZ).

## Front View

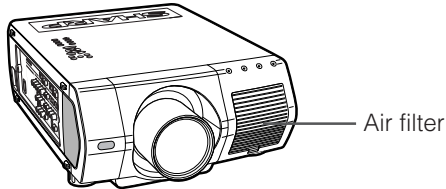

## Replacing the front air filter

<p><b>1 Turn off the power.</b></p>	<p><b>2 Turn off the main power and unplug the power cord.</b></p>	<p><b>3 Remove the front filter cover.</b></p> <p>Grasp the tab and lift open the filter cover in the direction of the arrow.</p>
<p><b>4 Remove the air filter.</b></p> <p>Grasp the air filter tabs between your fingers and pull it out of the filter compartment.</p>	<p><b>5 Replace the air filter.</b></p> <p>Press the air filter firmly into the filter compartment.</p>	<p><b>6 Reset the filter cover.</b></p> <p>Insert the tab on the end of the filter cover into the filter cover opening and press the filter cover into position.</p>

### NOTE

- When resetting the filter cover, be sure the filter is securely installed. The power will not turn on unless it is correctly installed.





# Troubleshooting

Problem	Check
Power cannot be turned on or off using the POWER buttons (ON/OFF) on the projector.	<ul style="list-style-type: none"> <li>• Keylock level is set to "Level A" or "Level B", preventing operation of some or all buttons. (See page 59.)</li> </ul>
Cannot be operated by remote control.	<ul style="list-style-type: none"> <li>• When the projector is set to slave, use the buttons on the master projector or change the setting by RS-232C commands from the computer. (See page 63.)</li> </ul>
Cannot be operated by all buttons of the projector and remote control.	<ul style="list-style-type: none"> <li>• When using slave setting in combination with Keylock Level B or C, all the buttons on the projector and the remote control are disabled. Use the SAPS or RS-232C commands to release slave and Keylock setting and enable buttons to operate. Without a computer, you can release slave and Keylock setting by entering the buttons on the projector as follows. <i>ON → ENTER → ON → ENTER → ON → ENTER → MENU</i> However, this operation also releases the password set.</li> </ul>
No picture and no sound.	<ul style="list-style-type: none"> <li>• Projector power cord is not plugged into the wall outlet.</li> <li>• The front filter cover is not securely installed.</li> <li>• Selected input is wrong. (See page 31.)</li> <li>• Cables incorrectly connected to side panel of the projector. (See pages 14–18.)</li> <li>• Remote control batteries have run down. (See page 12.)</li> <li>• Remote control's MOUSE/ADJUSTMENT switch is set to MOUSE.</li> </ul>
Sound is heard but no picture appears.	<ul style="list-style-type: none"> <li>• Cables incorrectly connected to side panel of the projector. (See pages 14–18.)</li> <li>• "Contrast" and "Bright" adjustments are set to minimum position. (See page 43.)</li> <li>• On-screen Display ("BLACK SCREEN") is turned off and Black Screen function is turned on, creating a black image. (See page 32.)</li> </ul>
Color is faded or poor.	<ul style="list-style-type: none"> <li>• "Color" and "Tint" adjustments are not correct. (See page 43.)</li> </ul>
Picture is blurred.	<ul style="list-style-type: none"> <li>• Adjust the focus. (See page 29.)</li> <li>• Projection distance is too long or too short to allow for proper focus. (See pages 21–28.)</li> </ul>
Picture appears but no sound is heard.	<ul style="list-style-type: none"> <li>• Cables incorrectly connected to side panel of the projector. (See pages 14–18.)</li> <li>• Volume is set to minimum. (See page 31.)</li> </ul>
No OSD appears.	<ul style="list-style-type: none"> <li>• OSD Display is set to "Level A" or "Level B", preventing to display some or all On-screen Displays. (See page 53.)</li> </ul>
An unusual sound is occasionally heard from the cabinet.	<ul style="list-style-type: none"> <li>• If the picture is normal, the sound is due to cabinet shrinkage caused by temperature changes. This will not affect operation or performance.</li> </ul>
Maintenance indicator lights up.	<ul style="list-style-type: none"> <li>• Refer to "Lamp/Maintenance Indicators" on page 69.</li> </ul>
Picture noise appears.	<ul style="list-style-type: none"> <li>• Adjust the "Phase" setting. (See page 46.)</li> <li>• Noise may appear when used with certain computers. Set the NOISE FILTER to ON using the RS-232C command. (See pages 80–82.)</li> </ul>
480P images do not appear.	<ul style="list-style-type: none"> <li>• Set the resolution mode to 480P. (See page 48.)</li> </ul>
Image is green on INPUT 1, 2, 4 or 5 COMPONENT. Image is pink (no green) on INPUT 1, 2 RGB.	<ul style="list-style-type: none"> <li>• Change the input signal type. (See page 45.)</li> </ul>
Lens comes off.	<ul style="list-style-type: none"> <li>• Align the mark on the lens with the corresponding mark on the projector, push the lens firmly in place, and rotate to the right.</li> </ul>



## For SHARP Assistance (U.S.A. only)

If you encounter any problems during setup or operation of this projector, first refer to the "Troubleshooting" section on this page. If this operation manual does not answer your question, please call toll free 1-888-GO-SHARP (1-888-467-4277) for further assistance. Or, send us an e-mail at [lcdsupport@sharplcd.com](mailto:lcdsupport@sharplcd.com). Our World Wide Web address is <http://www.sharplcd.com>.





# Guide to Effective Presentations

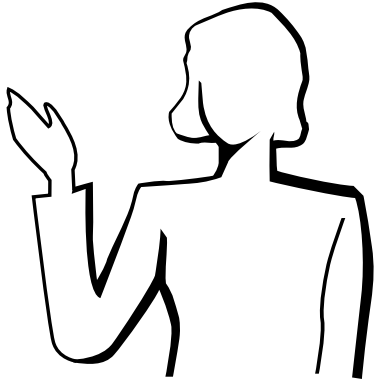

Electronic presentations are one of the most effective tools presenters can use to persuade an audience. There are several ways to enhance your presentation and maximize your effectiveness. The following are guidelines to help you create and deliver a dynamic presentation.

## a. Types of Presentations

### Computer Presentations

- To present basic information such as graphs, spreadsheets, documents and images, use word processing and spreadsheet applications.
- To convey more complex information and create more dynamic presentations which allow you to control the pace of your delivery, utilize software such as Astound®, Freelance®, Persuasion® or PowerPoint®.
- For high-end multimedia and interactive presentations, use software such as Macromedia Director®.

#### NOTE

- Astound®, Freelance®, Persuasion®, PowerPoint® and Macromedia Director® are trademarks of their respective companies.

### Video Presentations

Use of video equipment, such as a VCR, DVD player and laser disc player, can be effective for delivering instructional or illustrative information that is difficult to present.

### Digital Cameras and Personal Digital Assistants (PDAs)

For highly compact and portable presentations, digital still cameras, digital video cameras, document cameras and PDAs are ideal for transferring data without cumbersome conversions.

### Multimedia Presentations

You can integrate all of the above methods for a full multimedia presentation including video, audio, computer applications and World Wide Web information.

## b. Creative Presentations

Oftentimes presenters do not take advantage of the many subtle ways they can manipulate their electronic slides to more effectively persuade the audience.

Color has a great effect on the audience during a presentation. When used correctly and legibly, studies show that background and foreground colors establish an emotional tone for a presentation, help viewers understand and retain information, and influence an audience to take a desired course of action.

### Color Considerations

- Choose legible colors.
- Text and graphics colors need sufficient contrast.
- Use darker colors for the background since a lighter background can create uncomfortable glare. (Yellow on black creates an ideal contrast.)

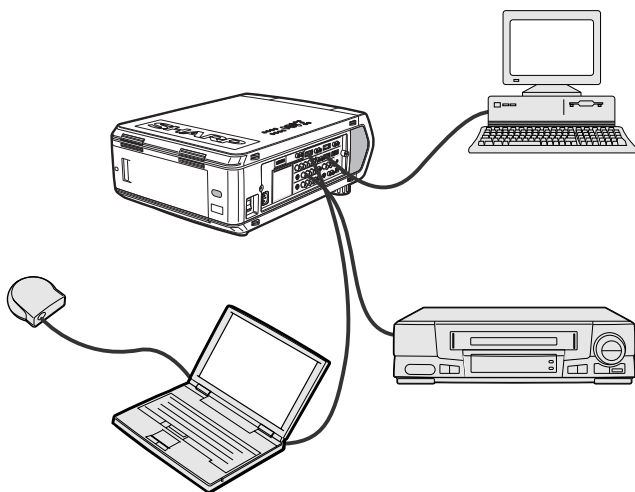
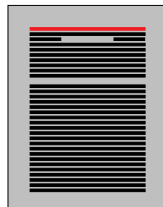
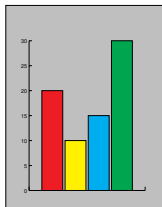

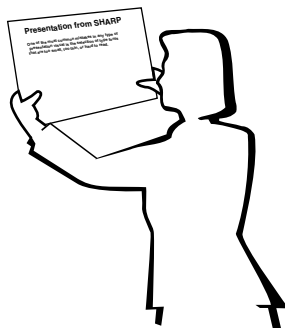
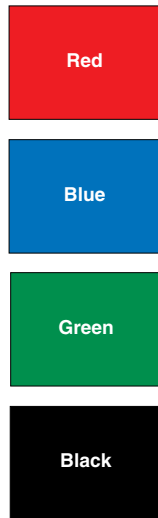

**Sans-serif**  
**Serif**

- Background colors can subconsciously affect the audience:

**Red**—increases viewers' pulse and breathing and encourages risk taking but can also be associated with financial loss.

**Blue**—has a calming and conservative affect on the audience but can also create boredom among corporate audiences that are often inundated with this background color.

**Green**—stimulates interaction.

**Black**—conveys finality and certainty. Use it as a transitional color between slides when moving from one idea to another.

- Foreground colors create a major impact on how well an audience understands and remembers a message.
  - Use one or two bright colors for emphasis.
  - Highlight important messages.
- The eye has a difficult time reading certain colored text on certain colored backgrounds. For example, text and background colors in red and green, and blue and black make for difficult viewing.
- Colorblind individuals may find it difficult to distinguish between red and green, brown and green, and purple and blue. Avoid using these colors together.

## Fonts

- One of the most common mistakes in any type of presentation visual is the selection of type fonts that are too small, too thin, or too difficult to read.
- If you are not sure how well a given font will read on a screen at various sizes, try this: Draw a 6" × 8" box on a piece of paper and print out several lines of text inside the box with your computer printer at 300 or 600 dpi resolution. Vary the sizes of text to simulate headline, body and text call-outs for any charts or graphs. Hold the printout at arm's length. This is how your text will look on a 4' (1.2 meter)-wide screen at 10' (3 meters), on a 7.5' (2.3 meter)-wide screen at 20' (6.1 meters) and a 12' (3.7 meter)-wide screen at 30' (9.1 meters). If you cannot read the text easily, you should put less copy on your visuals or use larger typefaces.
- Design your visuals so that they are visible by the viewer in the last row.
- Nothing will ruin your presentation faster than misspelled words. Take the time to proofread and edit your work before your visuals become a permanent part of your presentation.
- Mixed case text is easier to read than text which is displayed in capital letters.
- Another important attribute of fonts is whether any particular face is serif or sans-serif. Serifs are small, usually horizontal cross strokes that are added to the end of a letter's main strokes. Because of their ability to coax the eye along the line of type, fonts with serifs are generally acknowledged to be more readable.



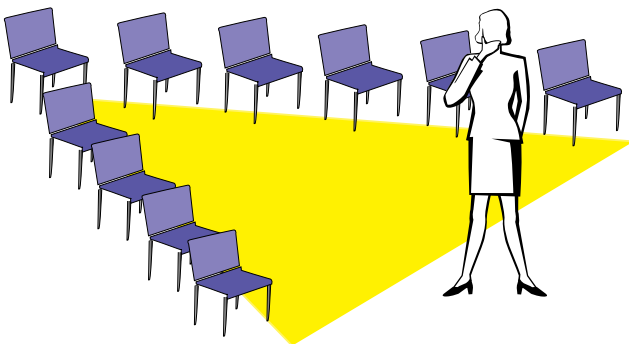
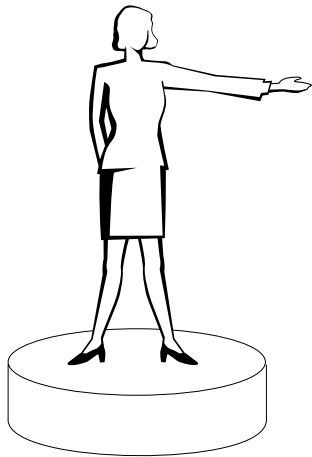
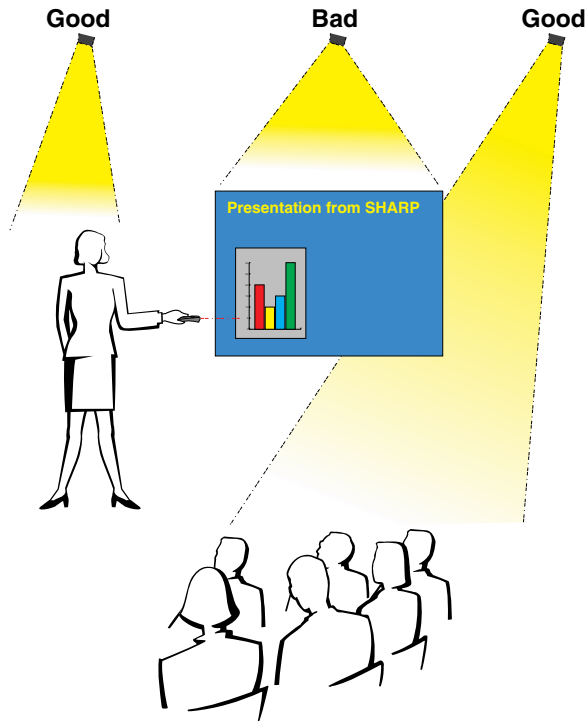

## c. Set-Up

When giving a presentation, you need to set the stage both figuratively and literally for success. The way you set up a presentation room will have a great impact on the audience's perception of you and your message. By manipulating the placement and use of the following tools, you will improve the impact of your presentation.

**Lighting**—Good lighting is an important component of a successful presentation. You should strive to create an unequal distribution of light. An audience should always see as much of the presenter's face as possible, so most of the light should be focused on you. Because it is important for you to be able to read the audience's faces and body language, some light should be shed upon them. However, no light should shine on the screen.

**Stage**—When presenting on the same level surface that your audience is on, most people can only see the top one-third of your body. Therefore, it is recommended that when giving a presentation to an audience of 25 or more, you stand on a stage or platform. As more of your body is visible, the easier it is to communicate with an audience.

**Podiums**—The best presenters avoid podiums because they hide 75% of the body and restrict movement. However, many people feel more comfortable with a podium to hold their notes and hide their discomfort. If you must use a podium, angle it at 45 degrees to the audience so that you are not completely hidden.

**Visuals**—It is imperative that you make sure your visuals are large enough and projected far enough for the audience to see. Eight times the height of an image is the optimal viewing distance to read 24 point type. The bottom of a screen should be at least 6' (1.8 meters) above the floor.

**Screen**—The screen should always be in the center of the room so that all audience members can see it. Because people read from left to right, you should always stand to the audience's left when discussing visuals.

**Seating**—Arrange seating according to the dynamics of your presentation. If the presentation is more than half-a-day, use classroom style seating—a chair and a desk. If you would like to encourage audience interaction, use chevron seating, angling the chairs into a "V" shape. When you have a very small audience, a "U" shaped arrangement will increase interchange.



### d. Rehearsing & Delivery

- The best time to rehearse is the day or evening before, not a couple of hours before, and the best place to rehearse is in the actual room. Rehearsing a speech in a small office is not the same as standing up in front of 100 people in a hotel ballroom or classroom.
- Due to varying processor speeds of computers, practice your slide transitions for proper timing.
- Whenever possible, set up your equipment well in advance to allow adequate time to resolve any unexpected issues such as lighting, power, seating and audio.
- Thoroughly check every piece of equipment you bring along. Make sure you have fresh batteries in your remote controls and laptop computer. Fully charge your computer's battery before the presentation and connect your AC adaptor for added safety.
- Make sure you are completely familiar with the control panel on your projector and remote controls.
- If you are using a microphone, check it out before hand and walk around to see where you might have problems with feedback. Avoid standing in these problem areas during your presentation.

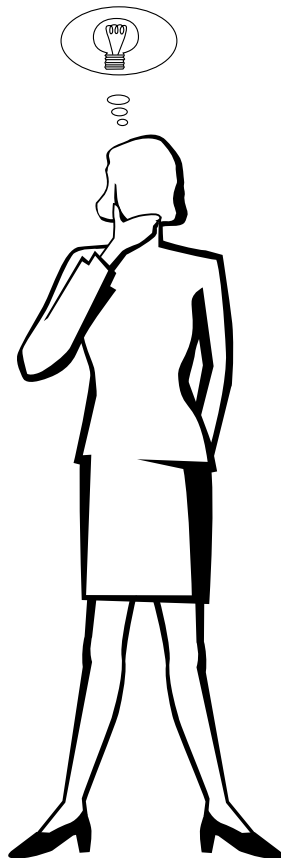

### e. Presentation Tips

- Before beginning, visualize yourself delivering an outstanding presentation.
- Know your speech, memorizing at least the first three minutes of your presentation will allow you to focus on your rhythm and pacing.
- Speak to early arrivals to help you build a rapport with the audience and make you feel more comfortable.
- Do not be overly dependent on your visuals by reciting what your audience is already reading. Know your material well enough to be able to deliver the presentation with ease. Use your visuals to emphasize keypoints.
- Be sure to project your voice clearly and use eye contact to maintain audience attention.
- Do not wait until halfway through your presentation to get your point across. If you wait and try to create a "build-up", you may lose some of your audience along the way.
- Keep your audience's attention. As most people only focus for 15 to 20 minutes during a one-hour presentation, it is important to recapture their attention periodically. Use phrases like, "This is critical to my point" or "This is absolutely fundamental" to remind them you are saying something they need to hear.





# Connecting Pin Assignments

**INPUT 1 RGB and OUTPUT (INPUT 1, 2) Signal Input Ports:** 15-pin Mini D-sub female connector

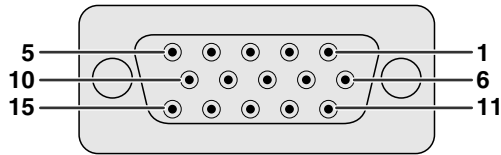

## RGB Input

Analog

- |                                      |                            |
|--------------------------------------|----------------------------|
| 1. Video input (red)                 | 8. Earth (blue)            |
| 2. Video input (green/sync on green) | 9. Not connected           |
| 3. Video input (blue)                | 10. GND                    |
| 4. Reserve input 1                   | 11. GND                    |
| 5. Composite sync                    | 12. Bi-directional data    |
| 6. Earth (red)                       | 13. Horizontal sync signal |
| 7. Earth (green/sync on green)       | 14. Vertical sync signal   |
|                                      | 15. Data clock             |

## Component Input

Analog

- |                                     |                   |
|-------------------------------------|-------------------|
| 1. P <sub>R</sub> (C <sub>R</sub> ) | 9. Not connected  |
| 2. Y                                | 10. Not connected |
| 3. P <sub>B</sub> (C <sub>B</sub> ) | 11. Not connected |
| 4. Not connected                    | 12. Not connected |
| 5. Not connected                    | 13. Not connected |
| 6. Earth (P <sub>R</sub> )          | 14. Not connected |
| 7. Earth (Y)                        | 15. Not connected |
| 8. Earth (P <sub>B</sub> )          |                   |

**RS-232C Port:** 9-pin D-sub male connector of the DIN-D-sub RS-232C cable

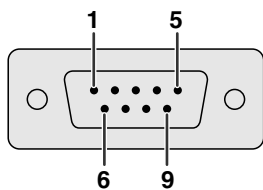

Pin No.	Signal	Name	I/O	Reference
1	CD			Not connected
2	RD	Receive Data	Input	Connected to internal circuit
3	SD	Send Data	Output	Connected to internal circuit
4	ER			Not connected
5	SG	Signal Ground		Connected to internal circuit
6	DR	Data Set Ready	Output	Not connected
7	RS	Request to Send	Output	Connected to internal circuit
8	CS	Clear to Send	Input	Connected to internal circuit
9	CI			Not connected

**DVI Port:** 29-pin

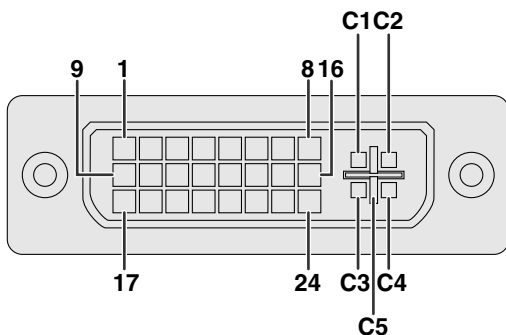

Pin No.	Name
1	T.M.D.S. Data 2 -
2	T.M.D.S. Data 2 +
3	T.M.D.S. Data 2/4 Shield
4	T.M.D.S. Data 4 - <sup>*3</sup>
5	T.M.D.S. Data 4 + <sup>*3</sup>
6	DDC Clock
7	DDC Data
8	Analog Vertical Sync
9	T.M.D.S. Data 1 -
10	T.M.D.S. Data 1 +
11	T.M.D.S. Data 1/3 Shield
12	T.M.D.S. Data 3 - <sup>*3</sup>
13	T.M.D.S. Data 3 + <sup>*3</sup>
14	+5 V Power
15	Ground <sup>*1</sup>
16	Hot Plug Detect
17	T.M.D.S. Data 0 -
18	T.M.D.S. Data 0 +
19	T.M.D.S. Data 0/5 Shield
20	T.M.D.S. Data 5 - <sup>*3</sup>
21	T.M.D.S. Data 5 + <sup>*3</sup>
22	T.M.D.S. Clock Shield
23	T.M.D.S. Clock +
24	T.M.D.S. Clock -
C1	Analog Red
C2	Analog Green
C3	Analog Blue
C4	Analog Horizontal sync
C5	Analog Ground <sup>*2</sup>

### NOTE

- \*1 Return for +5 V, Hsync. and Vsync.
- \*2 Analog R, G and B return
- \*3 These pins are not used on this equipment.





# (RS-232C) Specifications and Command Settings

## PC control

A computer can be used to control the projector by connecting an RS-232C cable (null modem, cross type, sold separately) to the projector. (See page 16 for connection.)

## Communication conditions

Set the serial port settings of the computer to match that of the table.

Signal format: Conforms to RS-232C standard.

Baud rate: 9,600 bps

Data length: 8 bits

Parity bit: NON

Stop bit: 1 bit

Flow control: None

## Basic format

Commands from the computer are sent in the following order: command, parameter, and return code. After the projector processes the command from the computer, it sends a response code to the computer.

### Command format

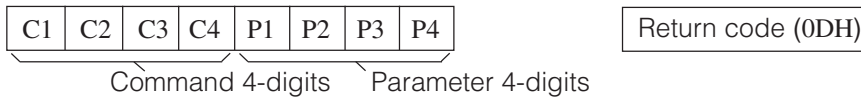

### Response code format

Normal response



Problem response (communication error or incorrect command)



When more than one code is being sent, send each command only after the OK response code for the previous command from the projector is verified.

## NOTE

- When using the computer control function of the projector, the projector operating status cannot be read to the computer. Therefore, confirm the status by transmitting the display commands for each adjustment menu and checking the status with the On-screen Display. If the projector receives a command other than a menu display command, it will execute the command without displaying the On-screen Display.

## Commands

### EXAMPLE

- When "BRIGHT" of INPUT 1 IMAGE ADJUSTMENT is set to -10.

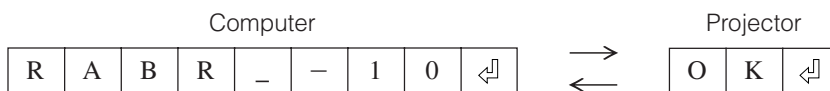

	CONTROL CONTENTS	COMMAND	PARAMETER	RETURN
BUTTONS & REMOTE CONTROL KEY	POWER ON	P O W R	_ _ _ 1	OK OR ERR
	POWER OFF	P O W R	_ _ _ 0	OK OR ERR
BUTTONS & REMOTE CONTROL KEY	VOLUME (0-60)	V O L A	_ _ * *	OK OR ERR
	MUTE ON	M U T E	_ _ _ 1	OK OR ERR
	MUTE OFF	M U T E	_ _ _ 0	OK OR ERR
	LENS FOCUS (-30 - +30)	L N F O	_ * * *	OK OR ERR
	LENS ZOOM (-30 - +30)	L N Z O	_ * * *	OK OR ERR
	LENS SHIFT (-30 - +30)	L N S H	_ * * *	OK OR ERR
	KEystone (-127 - +127)	K E Y S	_ * * *	OK OR ERR
	DIGITAL SHIFT (-96 - +96)	L N D S	_ * * *	OK OR ERR
	BLACK SCREEN ON	I M B K	_ _ _ 1	OK OR ERR

	CONTROL CONTENTS	COMMAND	PARAMETER	RETURN
BUTTONS & REMOTE CONTROL KEY	BLACK SCREEN OFF	I M B K	_ _ _ 0	OK OR ERR
	INPUT 1 (RGB 1)	I R G B	_ _ _ 1	OK OR ERR
	INPUT 2 (RGB 2)	I R G B	_ _ _ 2	OK OR ERR
	INPUT 3 (RGB 3)	I R G B	_ _ _ 3	OK OR ERR
	INPUT 4 (VIDEO 1)	I V E D	_ _ _ 1	OK OR ERR
	INPUT 5 (VIDEO 2)	I V E D	_ _ _ 2	OK OR ERR
BUTTONS & REMOTE CONTROL KEY	INPUT 6 (VIDEO 3)	I V E D	_ _ _ 3	OK OR ERR
	INPUT CHECK	I C H K	_ _ _ 0	OK OR ERR
	FREEZE ON	F R E Z	_ _ _ 1	OK OR ERR
	FREEZE OFF	F R E Z	_ _ _ 0	OK OR ERR
	AUTO SYNC START	A D J S	_ _ _ 1	OK OR ERR





# (RS-232C) Specifications and Command Settings

	CONTROL CONTENTS	COMMAND	PARAMETER	RETURN	
BUTTONS & REMOTE CONTROL KEY	INPUT 1 (RGB 1) RESIZE : NORMAL	R A S R	- - -	1 OK OR ERR	
	INPUT 1 (RGB 1) RESIZE : FULL	R A S R	- - -	5 OK OR ERR	
	INPUT 1 (RGB 1) RESIZE : DOT BY DOT	R A S R	- - -	3 OK OR ERR	
	INPUT 2 (RGB 2) RESIZE : NORMAL	R B S R	- - -	1 OK OR ERR	
	INPUT 2 (RGB 2) RESIZE : FULL	R B S R	- - -	5 OK OR ERR	
	INPUT 2 (RGB 2) RESIZE : DOT BY DOT	R B S R	- - -	3 OK OR ERR	
	INPUT 3 (RGB 3) RESIZE : NORMAL	R C S R	- - -	1 OK OR ERR	
	INPUT 3 (RGB 3) RESIZE : FULL	R C S R	- - -	5 OK OR ERR	
	INPUT 3 (RGB 3) RESIZE : DOT BY DOT	R C S R	- - -	3 OK OR ERR	
	INPUT 4 (VIDEO 1) RESIZE : NORMAL	R A S V	- - -	1 OK OR ERR	
	INPUT 4 (VIDEO 1) RESIZE : FULL	R A S V	- - -	5 OK OR ERR	
	INPUT 4 (VIDEO 1) RESIZE : BORDER	R A S V	- - -	3 OK OR ERR	
	INPUT 4 (VIDEO 1) RESIZE : STRETCH	R A S V	- - -	2 OK OR ERR	
	INPUT 4 (VIDEO 1) RESIZE : SMART STRETCH	R A S V	- - -	4 OK OR ERR	
	INPUT 5 (VIDEO 2) RESIZE : NORMAL	R B S V	- - -	1 OK OR ERR	
	INPUT 5 (VIDEO 2) RESIZE : FULL	R B S V	- - -	5 OK OR ERR	
	INPUT 5 (VIDEO 2) RESIZE : BORDER	R B S V	- - -	3 OK OR ERR	
	INPUT 5 (VIDEO 2) RESIZE : STRETCH	R B S V	- - -	2 OK OR ERR	
	INPUT 5 (VIDEO 2) RESIZE : SMART STRETCH	R B S V	- - -	4 OK OR ERR	
	INPUT 6 (VIDEO 3) RESIZE : NORMAL	R C S V	- - -	1 OK OR ERR	
	INPUT 6 (VIDEO 3) RESIZE : FULL	R C S V	- - -	5 OK OR ERR	
	INPUT 6 (VIDEO 3) RESIZE : BORDER	R C S V	- - -	3 OK OR ERR	
	INPUT 6 (VIDEO 3) RESIZE : STRETCH	R C S V	- - -	2 OK OR ERR	
	INPUT 6 (VIDEO 3) RESIZE : SMART STRETCH	R C S V	- - -	4 OK OR ERR	
	RGB GAMMA : STANDARD	G A M R	- - -	1 OK OR ERR	
	RGB GAMMA : GAMMA1	G A M R	- - -	2 OK OR ERR	
	RGB GAMMA : GAMMA2	G A M R	- - -	3 OK OR ERR	
	RGB GAMMA : CUSTOM	G A M R	- - -	4 OK OR ERR	
	VIDEO GAMMA : STANDARD	G A M V	- - -	1 OK OR ERR	
	VIDEO GAMMA : GAMMA1	G A M V	- - -	2 OK OR ERR	
	VIDEO GAMMA : GAMMA2	G A M V	- - -	3 OK OR ERR	
	VIDEO GAMMA : CUSTOM	G A M V	- - -	4 OK OR ERR	
	PICTURE	INPUT 1 (RGB 1) CONTRAST (-30 - +30)	R A P I	- * * *	OK OR ERR
		INPUT 1 (RGB 1) BRIGHT (-30 - +30)	R A B R	- * * *	OK OR ERR
		INPUT 1 (RGB 1) RED (-30 - +30)	R A R D	- * * *	OK OR ERR
		INPUT 1 (RGB 1) BLUE (-30 - +30)	R A B E	- * * *	OK OR ERR
		INPUT 1 (RGB 1) COLOR (-30 - +30)	R A C O	- * * *	OK OR ERR
		INPUT 1 (RGB 1) TINT (-30 - +30)	R A T I	- * * *	OK OR ERR
		INPUT 1 (RGB 1) SHARP (-30 - +30)	R A S H	- * * *	OK OR ERR
		INPUT 1 (RGB 1) CLR TEMP (-3 - +3)	R A C T	- - * *	OK OR ERR
		INPUT 1 (RGB 1) DISPLAY	R A R E	- - - 0	OK OR ERR
		INPUT 1 (RGB 1) ADJUSTMENT RESET	R A R E	- - - 1	OK OR ERR
INPUT 2 (RGB 2) CONTRAST (-30 - +30)		R B P I	- * * *	OK OR ERR	
INPUT 2 (RGB 2) BRIGHT (-30 - +30)		R B B R	- * * *	OK OR ERR	
INPUT 2 (RGB 2) RED (-30 - +30)		R B R D	- * * *	OK OR ERR	
INPUT 2 (RGB 2) BLUE (-30 - +30)		R B B E	- * * *	OK OR ERR	
INPUT 2 (RGB 2) COLOR (-30 - +30)		R B C O	- * * *	OK OR ERR	
INPUT 2 (RGB 2) TINT (-30 - +30)		R B T I	- * * *	OK OR ERR	
INPUT 2 (RGB 2) SHARP (-30 - +30)		R B S H	- * * *	OK OR ERR	
INPUT 2 (RGB 2) CLR TEMP (-3 - +3)		R B C T	- - * *	OK OR ERR	
INPUT 2 (RGB 2) DISPLAY		R B R E	- - - 0	OK OR ERR	
INPUT 2 (RGB 2) ADJUSTMENT RESET		R B R E	- - - 1	OK OR ERR	
INPUT 3 (RGB 3) CONTRAST (-30 - +30)		R C P I	- * * *	OK OR ERR	
INPUT 3 (RGB 3) BRIGHT (-30 - +30)		R C B R	- * * *	OK OR ERR	
INPUT 3 (RGB 3) RED (-30 - +30)		R C R D	- * * *	OK OR ERR	
INPUT 3 (RGB 3) BLUE (-30 - +30)		R C B E	- * * *	OK OR ERR	
INPUT 3 (RGB 3) COLOR (-30 - +30)		R C C O	- * * *	OK OR ERR	
INPUT 3 (RGB 3) TINT (-30 - +30)		R C T I	- * * *	OK OR ERR	
INPUT 3 (RGB 3) SHARP (-30 - +30)		R C S H	- * * *	OK OR ERR	
INPUT 3 (RGB 3) CLR TEMP (-3 - +3)		R C C T	- - * *	OK OR ERR	
INPUT 3 (RGB 3) DISPLAY		R C R E	- - - 0	OK OR ERR	
INPUT 3 (RGB 3) ADJUSTMENT RESET		R C R E	- - - 1	OK OR ERR	
INPUT 1 (RGB 1) SIGNAL TYPE : RGB		I A S I	- - - 0	OK OR ERR	
INPUT 1 (RGB 1) SIGNAL TYPE : COMPONENT		I A S I	- - - 1	OK OR ERR	

	CONTROL CONTENTS	COMMAND	PARAMETER	RETURN
PICTURE	INPUT 2 (RGB 2) SIGNAL TYPE : RGB	I B S I	- - - 0	OK OR ERR
	INPUT 2 (RGB 2) SIGNAL TYPE : COMPONENT	I B S I	- - - 1	OK OR ERR
	INPUT 1 (RGB 1) 2D PROGRESSIVE	R A I P	- - - 0	OK OR ERR
	INPUT 1 (RGB 1) 3D PROGRESSIVE	R A I P	- - - 1	OK OR ERR
	INPUT 1 (RGB 1) Film MODE	R A I P	- - - 2	OK OR ERR
	INPUT 2 (RGB 2) 2D PROGRESSIVE	R B I P	- - - 0	OK OR ERR
	INPUT 2 (RGB 2) 3D PROGRESSIVE	R B I P	- - - 1	OK OR ERR
	INPUT 2 (RGB 2) Film MODE	R B I P	- - - 2	OK OR ERR
	INPUT 3 (RGB 3) 2D PROGRESSIVE	R C I P	- - - 0	OK OR ERR
	INPUT 3 (RGB 3) 3D PROGRESSIVE	R C I P	- - - 1	OK OR ERR
	INPUT 3 (RGB 3) Film MODE	R C I P	- - - 2	OK OR ERR
	INPUT 4 (VIDEO 1) CONTRAST (-30 - +30)	V A P I	- * * *	OK OR ERR
	INPUT 4 (VIDEO 1) BRIGHT (-30 - +30)	V A B R	- * * *	OK OR ERR
	INPUT 4 (VIDEO 1) RED (-30 - +30)	V A R D	- * * *	OK OR ERR
	INPUT 4 (VIDEO 1) BLUE (-30 - +30)	V A B E	- * * *	OK OR ERR
	INPUT 4 (VIDEO 1) COLOR (-30 - +30)	V A C O	- * * *	OK OR ERR
	INPUT 4 (VIDEO 1) TINT (-30 - +30)	V A T I	- * * *	OK OR ERR
	INPUT 4 (VIDEO 1) SHARP (-30 - +30)	V A S H	- * * *	OK OR ERR
	INPUT 4 (VIDEO 1) CLR TEMP (-3 - +3)	V A C T	- - * *	OK OR ERR
	INPUT 4 (VIDEO 1) DISPLAY	V A R E	- - - 0	OK OR ERR
	INPUT 4 (VIDEO 1) ADJUSTMENT RESET	V A R E	- - - 1	OK OR ERR
	INPUT 5 (VIDEO 2) CONTRAST (-30 - +30)	V B P I	- * * *	OK OR ERR
	INPUT 5 (VIDEO 2) BRIGHT (-30 - +30)	V B B R	- * * *	OK OR ERR
	INPUT 5 (VIDEO 2) RED (-30 - +30)	V B R D	- * * *	OK OR ERR
	INPUT 5 (VIDEO 2) BLUE (-30 - +30)	V B B E	- * * *	OK OR ERR
	INPUT 5 (VIDEO 2) COLOR (-30 - +30)	V B C O	- * * *	OK OR ERR
	INPUT 5 (VIDEO 2) TINT (-30 - +30)	V B T I	- * * *	OK OR ERR
	INPUT 5 (VIDEO 2) SHARP (-30 - +30)	V B S H	- * * *	OK OR ERR
	INPUT 5 (VIDEO 2) CLR TEMP (-3 - +3)	V B C T	- - * *	OK OR ERR
	INPUT 5 (VIDEO 2) DISPLAY	V B R E	- - - 0	OK OR ERR
	INPUT 5 (VIDEO 2) ADJUSTMENT RESET	V B R E	- - - 1	OK OR ERR
	INPUT 6 (VIDEO 3) CONTRAST (-30 - +30)	V C P I	- * * *	OK OR ERR
	INPUT 6 (VIDEO 3) BRIGHT (-30 - +30)	V C B R	- * * *	OK OR ERR
	INPUT 6 (VIDEO 3) RED (-30 - +30)	V C R D	- * * *	OK OR ERR
	INPUT 6 (VIDEO 3) BLUE (-30 - +30)	V C B E	- * * *	OK OR ERR
	INPUT 6 (VIDEO 3) COLOR (-30 - +30)	V C C O	- * * *	OK OR ERR
	INPUT 6 (VIDEO 3) TINT (-30 - +30)	V C T I	- * * *	OK OR ERR
	INPUT 6 (VIDEO 3) SHARP (-30 - +30)	V C S H	- * * *	OK OR ERR
	INPUT 6 (VIDEO 3) CLR TEMP (-3 - +3)	V C C T	- - * *	OK OR ERR
	INPUT 6 (VIDEO 3) DISPLAY	V C R E	- - - 0	OK OR ERR
	INPUT 6 (VIDEO 3) ADJUSTMENT RESET	V C R E	- - - 1	OK OR ERR
	INPUT 4 (VIDEO 1) SIGNAL TYPE : VIDEO	I A S V	- - - 0	OK OR ERR
INPUT 4 (VIDEO 1) SIGNAL TYPE : COMPONENT	I A S V	- - - 1	OK OR ERR	
INPUT 5 (VIDEO 2) SIGNAL TYPE : VIDEO	I B S V	- - - 0	OK OR ERR	
INPUT 5 (VIDEO 2) SIGNAL TYPE : COMPONENT	I B S V	- - - 1	OK OR ERR	
INPUT 4 (VIDEO 1) 2D PROGRESSIVE	V A I P	- - - 0	OK OR ERR	
INPUT 4 (VIDEO 1) 3D PROGRESSIVE	V A I P	- - - 1	OK OR ERR	
INPUT 4 (VIDEO 1) Film MODE	V A I P	- - - 2	OK OR ERR	
INPUT 5 (VIDEO 2) 2D PROGRESSIVE	V B I P	- - - 0	OK OR ERR	
INPUT 5 (VIDEO 2) 3D PROGRESSIVE	V B I P	- - - 1	OK OR ERR	
INPUT 5 (VIDEO 2) Film MODE	V B I P	- - - 2	OK OR ERR	
INPUT 6 (VIDEO 3) 2D PROGRESSIVE	V C I P	- - - 0	OK OR ERR	
INPUT 6 (VIDEO 3) 3D PROGRESSIVE	V C I P	- - - 1	OK OR ERR	
INPUT 6 (VIDEO 3) Film MODE	V C I P	- - - 2	OK OR ERR	
(INPUT 1-6) 2D PROGRESSIVE	I M I P	- - - 0	OK OR ERR	
(INPUT 1-6) 3D PROGRESSIVE	I M I P	- - - 1	OK OR ERR	
(INPUT 1-6) Film MODE	I M I P	- - - 2	OK OR ERR	
FINE SYNC '1	CLOCK (-150 - +150)	I N C L	- * * *	OK OR ERR
	PHASE (-60 - +60)	I N P H	- * * *	OK OR ERR
	H-POSITION (-150 - +150)	I A H P	- * * *	OK OR ERR
	V-POSITION (-60 - +60)	I A V P	- * * *	OK OR ERR
	RGB INPUT DISPLAY	I A R E	- - - 0	OK OR ERR
	RGB ADJUSTMENT RESET	I A R E	- - - 1	OK OR ERR
	SAVE SETTING (1 - 7)	M E M S	- - - *	OK OR ERR



# (RS-232C) Specifications and Command Settings

	CONTROL CONTENTS	COMMAND	PARAMETER	RETURN
FINE SYNC *1	SELECT SETTING (1 - 7)	M E M L	_ _ _ *	OK OR ERR
	RGB HORIZONTAL FREQUENCY CHECK	T F R Q	_ _ _ 1	kHz (**, *OR_)
	RGB VERTICAL FREQUENCY CHECK	T F R Q	_ _ _ 2	Hz (**, *OR_)
	AUTO SYNC ON	A A D J	_ _ _ 1	OK OR ERR
	AUTO SYNC OFF	A A D J	_ _ _ 0	OK OR ERR
	AUTO SYNC DISPLAY ON	I M A S	_ _ _ 1	OK OR ERR
AUTO SYNC DISPLAY OFF	I M A S	_ _ _ 0	OK OR ERR	
AUDIO	BALANCE (-30 - +30)	A A B L	_ * * *	OK OR ERR
	TREBLE (-30 - +30)	A A T E	_ * * *	OK OR ERR
	BASS (-30 - +30)	A A B A	_ * * *	OK OR ERR
	AUDIO DISPLAY	A A R E	_ _ _ 0	OK OR ERR
	AUDIO ADJUSTMENT RESET	A A R E	_ _ _ 1	OK OR ERR
	OPTIONS (1)	PICT IN PICT : BOTTOM RIGHT	P I N P	_ _ _ 1
PICT IN PICT : BOTTOM LEFT		P I N P	_ _ _ 1	OK OR ERR
PICT IN PICT : UPPER RIGHT		P I N P	_ _ _ 1	OK OR ERR
PICT IN PICT : UPPER LEFT		P I N P	_ _ _ 1	OK OR ERR
PICT IN PICT RESET		P I N P	_ _ _ 0	OK OR ERR
VIDEO 3D DNR OFF		3 D N R	_ _ _ 0	OK OR ERR
VIDEO 3D DNR ON		3 D N R	_ _ _ 1	OK OR ERR
OSD DISPLAY ON		I M D I	_ _ _ 1	OK OR ERR
OSD DISPLAY OFF (LEVEL A)		I M D I	_ _ _ 2	OK OR ERR
OSD DISPLAY OFF (LEVEL B)		I M D I	_ _ _ 0	OK OR ERR
BLACK SCREEN DISPLAY ON		I M B O	_ _ _ 1	OK OR ERR
BLACK SCREEN DISPLAY OFF		I M B O	_ _ _ 0	OK OR ERR
VIDEO SYSTEM SELECTION : AUTO	M E S Y	_ _ _ 1	OK OR ERR	
VIDEO SYSTEM SELECTION : PAL	M E S Y	_ _ _ 2	OK OR ERR	
VIDEO SYSTEM SELECTION : SECAM	M E S Y	_ _ _ 3	OK OR ERR	
VIDEO SYSTEM SELECTION : NTSC4.43	M E S Y	_ _ _ 4	OK OR ERR	
VIDEO SYSTEM SELECTION : NTSC3.58	M E S Y	_ _ _ 5	OK OR ERR	
VIDEO SYSTEM SELECTION : PAL_M	M E S Y	_ _ _ 6	OK OR ERR	
VIDEO SYSTEM SELECTION : PAL_N	M E S Y	_ _ _ 7	OK OR ERR	
BACKGROUND SELECTION : SHARP	I M B G	_ _ _ 1	OK OR ERR	
BACKGROUND SELECTION : CUSTOM	I M B G	_ _ _ 2	OK OR ERR	
BACKGROUND SELECTION : BLUE	I M B G	_ _ _ 3	OK OR ERR	
BACKGROUND SELECTION : NONE	I M B G	_ _ _ 4	OK OR ERR	
STARTUP IMAGE SELECTION : SHARP	I M S I	_ _ _ 1	OK OR ERR	
STARTUP IMAGE SELECTION : CUSTOM	I M S I	_ _ _ 2	OK OR ERR	
STARTUP IMAGE SELECTION : NONE	I M S I	_ _ _ 3	OK OR ERR	
MONITOR OUT OFF	M O U T	_ _ _ 0	OK OR ERR	
MONITOR OUT ON	M O U T	_ _ _ 1	OK OR ERR	
AUTO POWER OFF : NO USE	A P O W	_ _ _ 0	OK OR ERR	
AUTO POWER OFF : USE	A P O W	_ _ _ 1	OK OR ERR	
ID NO. LED DISPLAY : DISPLAY OFF	I L E D	_ _ _ 0	OK OR ERR	
ID NO. LED DISPLAY : STANDBY OFF	I L E D	_ _ _ 1	OK OR ERR	
ID NO. LED DISPLAY : DISPLAY ON	I L E D	_ _ _ 2	OK OR ERR	
OPTIONS (2)	LAMP 1 USAGE TIME	T L T T	_ _ _ 1	0-9999 (INTEGER)
	LAMP 2 USAGE TIME	T L T T	_ _ _ 2	0-9999 (INTEGER)
	LAMP MODE : BOTH LAMPS	L P M D	_ _ _ 0	OK OR ERR
	LAMP MODE : LAMP 1 ONLY	L P M D	_ _ _ 1	OK OR ERR
	LAMP MODE : LAMP 2 ONLY	L P M D	_ _ _ 2	OK OR ERR
LAMP MODE : EQUAL USE	L P M D	_ _ _ 3	OK OR ERR	

	CONTROL CONTENTS	COMMAND	PARAMETER	RETURN
OPTIONS (2)	LAMP QUANTITY	T L P N	_ _ _ 1	1 OR 2
	LAMP 1 STATUS	T L P S	_ _ _ 1	0: OFF, 1: ON, 2: RETRY,
	LAMP 2 STATUS	T L P S	_ _ _ 2	3: WAITING, 4: LAMP ERROR
	PRJ MODE : REVERSE OFF	I M R E	_ _ _ 0	OK OR ERR
	PRJ MODE : REVERSE ON	I M R E	_ _ _ 1	OK OR ERR
	PRJ MODE : INVERT OFF	I M I N	_ _ _ 0	OK OR ERR
	PRJ MODE : INVERT ON	I M I N	_ _ _ 1	OK OR ERR
	STACK SETTING : NORMAL	S T A K	_ _ _ 0	OK OR ERR
	STACK SETTING : MASTER	S T A K	_ _ _ 1	OK OR ERR
	STACK SETTING : SLAVE	S T A K	_ _ _ 2	OK OR ERR
	KEYLOCK LEVEL : NORMAL	K E Y L	_ _ _ 0	OK OR ERR
	KEYLOCK LEVEL : LEVEL A	K E Y L	_ _ _ 1	OK OR ERR
	KEYLOCK LEVEL : LEVEL B	K E Y L	_ _ _ 2	OK OR ERR
	SET INPUTS : INPUT 1 NO USE	R A S I	_ _ _ 0	OK OR ERR
SET INPUTS : INPUT 1 USE	R A S I	_ _ _ 1	OK OR ERR	
SET INPUTS : INPUT 2 NO USE	R B S I	_ _ _ 0	OK OR ERR	
SET INPUTS : INPUT 2 USE	R B S I	_ _ _ 1	OK OR ERR	
SET INPUTS : INPUT 3 NO USE	R C S I	_ _ _ 0	OK OR ERR	
SET INPUTS : INPUT 3 USE	R C S I	_ _ _ 1	OK OR ERR	
SET INPUTS : INPUT 4 NO USE	V A S I	_ _ _ 0	OK OR ERR	
SET INPUTS : INPUT 4 USE	V A S I	_ _ _ 1	OK OR ERR	
SET INPUTS : INPUT 5 NO USE	V B S I	_ _ _ 0	OK OR ERR	
SET INPUTS : INPUT 5 USE	V B S I	_ _ _ 1	OK OR ERR	
SET INPUTS : INPUT 6 NO USE	V C S I	_ _ _ 0	OK OR ERR	
SET INPUTS : INPUT 6 USE	V C S I	_ _ _ 1	OK OR ERR	
ID NO. CHECK	R D I D	_ _ _ 1	001-250	
LANGUAGE	LANGUAGE SELECTION : ENGLISH	M E L A	_ _ _ 0	OK OR ERR
	LANGUAGE SELECTION : DEUTSCH	M E L A	_ _ _ 1	OK OR ERR
	LANGUAGE SELECTION : ESPAÑOL	M E L A	_ _ _ 2	OK OR ERR
	LANGUAGE SELECTION : NEDERLANDS	M E L A	_ _ _ 3	OK OR ERR
	LANGUAGE SELECTION : FRANÇAIS	M E L A	_ _ _ 4	OK OR ERR
	LANGUAGE SELECTION : ITALIANO	M E L A	_ _ _ 5	OK OR ERR
	LANGUAGE SELECTION : SVENSKA	M E L A	_ _ _ 6	OK OR ERR
	LANGUAGE SELECTION : 日本語	M E L A	_ _ _ 7	OK OR ERR
	LANGUAGE SELECTION : PORTUGUÊS	M E L A	_ _ _ 8	OK OR ERR
	LANGUAGE SELECTION : 汉语	M E L A	_ _ _ 9	OK OR ERR
LANGUAGE SELECTION : 한국어	M E L A	_ _ _ 1	OK OR ERR	
MODEL NAME CHECK	M N R D	_ _ _ 1	MODEL NAME	
NOISE FILTER OFF	N F I L	_ _ _ 0	OK OR ERR	
NOISE FILTER ON *2	N F I L	_ _ _ 1	OK OR ERR	
SERIAL NO. CHECK *3	S N R D	_ _ _ 1	SERIAL NO.	
PROJECTOR NAME *4	P J N A	_ _ _ 1	OK OR ERR	
	P J N A	_ _ _ 2	PROJECTOR NAME	

## NOTE

- If an underbar ( \_ ) appears in the parameter column, enter a space. If an asterisk ( \* ) appears, enter a value in the range indicated in brackets under CONTROL CONTENTS.
- \*1 FINE SYNC can only be set in the displayed RGB mode.
- \*2 Noise may appear when used with certain computers. Set the NOISE FILTER to ON using the RS-232C command.
- \*3 SERIAL NO. CHECK command is used to read out the 12 digits of serial No..
- \*4 After OK is returned, enter PROJECTOR NAME, up to 16-character memory. The PROJECTOR NAME in memory can then be output (confirmed).





# Wired Remote Control Terminal Specifications

## Specifications of wired remote control input

- ø3.5 mm minijack
- External: +5 V (1 A)
- Internal: GND

## Function and transmission codes

CONTROL ITEM	SYSTEM CODE					DATA CODE					EXTERNAL CODE				
	C1	C2	C3	C4	C5	C6	C7	C8	C9	C10	C11	C12	C13	C14	C15
ON	1	0	1	1	0	0	1	1	0	1	0	1	0	1	0
OFF	1	0	1	1	0	0	1	1	0	1	0	0	1	1	0
VOL +	1	0	1	1	0	0	0	1	0	1	0	0	0	1	0
VOL -	1	0	1	1	0	1	0	1	0	1	0	0	0	1	0
MUTE	1	0	1	1	0	1	1	1	0	1	0	0	0	1	0
MENU	1	0	1	1	0	0	0	1	0	0	0	1	1	1	0
LENS	1	0	1	1	0	1	1	0	1	0	0	0	1	1	0
TOOLS	1	0	1	1	0	0	1	0	1	0	1	1	1	1	0
BLACK SCREEN	1	0	1	1	0	1	0	0	1	0	1	1	0	1	0
ENTER	1	0	1	1	0	1	1	1	0	1	0	1	0	1	0
RESIZE	1	0	1	1	0	0	1	1	1	1	0	1	0	1	0

CONTROL ITEM	SYSTEM CODE					DATA CODE					EXTERNAL CODE				
	C1	C2	C3	C4	C5	C6	C7	C8	C9	C10	C11	C12	C13	C14	C15
UNDO	1	0	1	1	0	1	0	0	1	1	0	1	0	1	0
FREEZE	1	0	1	1	0	1	0	1	1	0	0	0	1	1	0
ENLARGE	1	0	1	1	0	1	0	1	1	0	1	1	0	1	0
AUTO SYNC	1	0	1	1	0	0	1	0	1	1	1	1	1	1	0
▲	1	0	1	1	0	0	0	1	1	1	0	0	1	1	0
▼	1	0	1	1	0	1	0	1	1	1	0	0	1	1	0
◀	1	0	1	1	0	0	0	0	0	1	0	1	0	1	0
▶	1	0	1	1	0	1	1	1	1	0	0	1	0	1	0
GAMMA	1	0	1	1	0	0	0	0	0	0	0	1	0	1	0
INPUT 1. 2. 3	1	0	1	1	0	0	0	1	1	0	1	1	1	1	0
INPUT 4. 5. 6	1	0	1	1	0	0	1	1	0	1	1	0	1	1	1

### NOTE

- To operate the mouse, left-click and right-click functions through the wired remote control input, connect the cable from the WIRED REMOTE control input terminal on the projector to the remote control. The codes for these functions are complex and are, therefore, not listed here.

### Wired remote control function code

LSB										MSB				
C1	C2	C3	C4	C5	C6	C7	C8	C9	C10	C11	C12	C13	C14	C15
1	0	1	1	0	*	*	*	*	*	*	*	*	1	0

- System codes C1 to C5 are fixed at "10110".
- Codes C14 and C15 are reverse confirmation bits, with "10" indicating "Front" and "01" indicating "Rear".

## Sharp remote control signal format

### Transmission format: 15-bit format

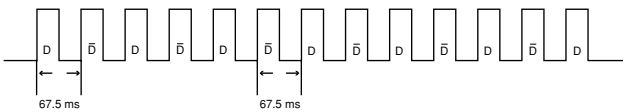

### Wave form of output signal: Output using Pulse Position Modulation

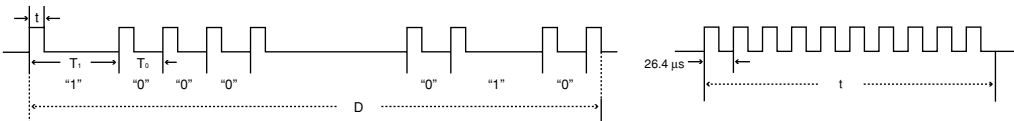

- $t = 264 \mu\text{s}$
- $T_0 = 1.05 \text{ ms}$
- $T_1 = 2.10 \text{ ms}$
- Pulse carrier frequency = 455/12 kHz
- Duty ratio = 1:1

### Transmission control code

15 bit

C1	C2	C3	C4	C5	C6	C7	C8	C9	C10	C11	C12	C13	C14	C15	
System Address					Function Key Data Bit					Data Expansion	Mask	Data Determination			
D to $\bar{D}$ Common Data Bit					Reverse in $\bar{D}$										

### Example of Reverse D to $\bar{D}$

D	C1	C2	C3	C4	C5	C6	C7	C8	C9	C10	C11	C12	C13	C14	C15
1	1	0	1	1	0	1	0	0	0	0	0	0	0	1	0
$\bar{D}$	C1	C2	C3	C4	C5	C6	C7	C8	C9	C10	C11	C12	C13	C14	C15
0	1	0	1	1	0	0	1	1	1	1	1	1	1	0	1



# Computer Compatibility Chart

Horizontal Frequency: 15–126 kHz

Vertical Frequency: 43–200 Hz

Pixel Clock: 12–230 MHz

Compatible with sync on green and composite sync signals

UXGA and SXGA compatible in advanced intelligent compression or intelligent compression

AICS (Advanced Intelligent Compression and Expansion System) resizing technology

PC/MAC/WS	Resolution	Horizontal Frequency (kHz)	Vertical Frequency (Hz)	VESA Standard	Display	
PC	640 × 350	27.0	60		Upscale	
		31.5	70			
		37.9	85	×		
	720 × 350	27.0	60			
		31.5	70			
		37.9	85	×		
	640 × 400	27.0	60			
		31.5	70			
		37.9	85	×		
	720 × 400	27.0	60			
		31.5	70			
		37.9	85	×		
	VGA	640 × 480	26.2	50		
			31.5	60		×
			34.7	70		
			37.9	72		×
			37.5	75		×
			43.3	85		×
			47.9	90		
			53.0	100		
			61.8	120		
			78.5	150		
	SVGA	800 × 600	80.9	160		
			100.4	200		
			31.4	50		
			35.1	56		×
			37.9	60		×
			44.5	70		
			48.1	72		×
			46.9	75		×
53.7			85	×		
56.8			90			
XGA	1,024 × 768	64.0	100			
		77.2	120			
		98.3	150			
		102.1	160			
		125.6	200			
		35.5	43	×		
		40.3	50			
		56.5	70	×		
		58.1	72			
		68.7	85	×		
PC	SXGA	1,152 × 864	54.3	60		
			64.0	70		
			64.1	72		
			67.5	75	×	
			75.7	80		
			77.3	85		
			90.2	100		
			111.1	120		
			54.8	60		
			65.9	72		
PC	UXGA	1,600 × 1,200	67.4	74		
			64.0	60	×	
			74.6	70		
			78.1	74		
			75.7	75		
			91.1	85	×	
			108.4	100		
			74.7	52		
			75.0	60	×	
			81.3	65	×	
PC/MAC/WS	SXGA	1,280 × 1,024	87.5	70	×	
			90.1	72		
			93.8	75	×	
			106.3	85	×	
			34.9	67		
			48.4	60	×	
			60.0	75	×	
			80.0	75	×	
			46.8	75		
			49.6	75		
68.5	75					
PC/MAC/WS	SXGA	1,280 × 960	78.1	72		
			60.0	60	×	
			85.9	85		
			53.5	50		
			76.8	72		
			60.9	66		
			71.9	76		
			77.2	96		
			80.6	100		
			98.8	120		
113.2	140					
125.6	150					
True						

## NOTE

- This projector may not be able to display images from notebook computers in simultaneous (CRT/LCD) mode. Should this occur, turn off the LCD display on the notebook computer and output the display data in "CRT only" mode. Details on how to change display modes can be found in your notebook computer's operation manual.
- This projector can receive 640 × 350 VESA format VGA signals, however, "640 × 400" will appear on the screen.
- When receiving 1,600 × 1,200 VESA format UXGA signals, sampling occurs and the image is displayed with 1,024 lines, causing part of the image to be blocked.





# Dimensions

Rear View

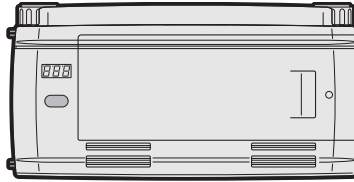

Side View

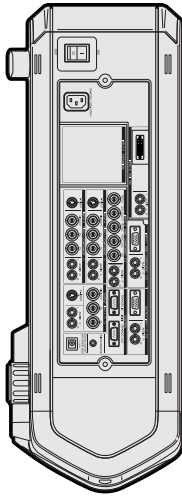

Top View

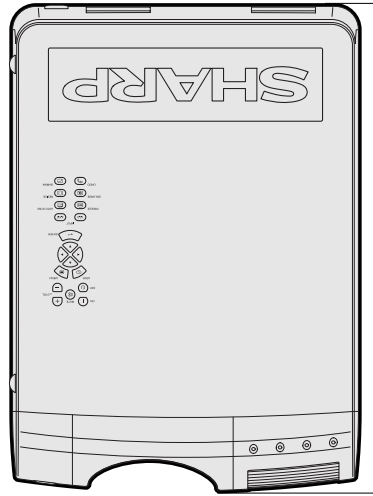

Side View

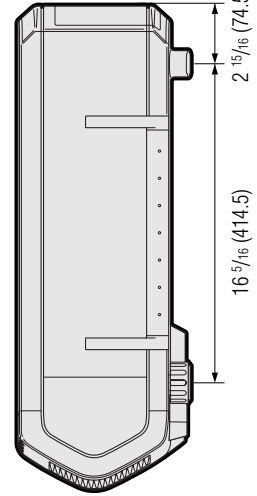

Front View

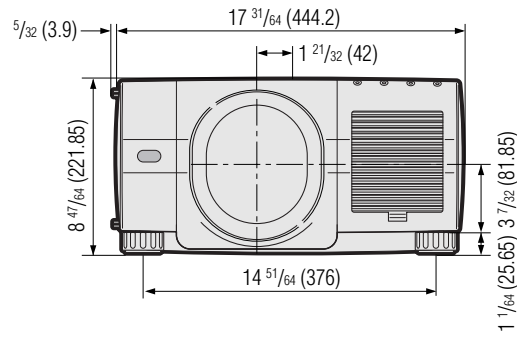

Bottom View

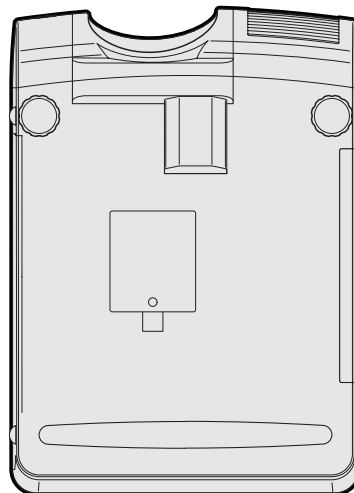

Units: inches (mm)



# Specifications

Product type	LCD Projector
Model	XG-V10XU
Video system	PAL/PAL 60/PAL-M/PAL-N/SECAM/NTSC 3.58/NTSC 4.43 DTV 480i/480P/720P/1080i
Display method	LCD panel × 3, RGB optical shutter method
LCD panel	Panel size: 1.8" (27.6 [H] × 36.9 [W] mm) Display method: Translucent TN liquid crystal panel Drive method: TFT (Thin Film Transistor) Active Matrix panel No. of dots: 786,432 dots (1,024 [H] × 768 [V])
Projection lamp	200 W UHP lamp × 2
Contrast ratio	400:1
Video input signal	BNC Connector: VIDEO (INPUT 4, 5), composite video, 1.0 Vp-p, sync negative, 75 Ω terminated RCA Connector: AUDIO (INPUT 4, 5), 0.5 Vrms more than 22 kΩ (stereo)
S-video input signal	4-pin Mini DIN connector (INPUT 4, 5) Y (luminance signal): 1.0 Vp-p, sync negative, 75 Ω terminated C (chrominance signal): Burst 0.286 Vp-p, 75 Ω terminated
Component input signal	BNC Connector (INPUT 2, 4, 5) Y: 1.0 Vp-p, sync negative, 75 Ω terminated Pb: 0.7 Vp-p, 75 Ω terminated Pr: 0.7 Vp-p, 75 Ω terminated
Horizontal resolution	620 TV lines (S-video input), 650 TV lines (DTV 720P input, STRETCH mode)
RGB input signal	15-PIN MINI D-SUB CONNECTOR (INPUT 1), 5 BNC CONNECTOR (INPUT 2): RGB separate/composite sync/sync on green type analog input: 0–0.7 Vp-p, positive, 75 Ω terminated DVI CONNECTOR (29-PIN) (INPUT 3), RGB (DIGITAL), 250–1,000 mV, 50 Ω HORIZONTAL SYNC. SIGNAL: TTL level (positive/negative) or composite sync (Apple only) VERTICAL SYNC. SIGNAL: Same as above
Pixel clock	12–230 MHz
Vertical frequency	43–200 Hz
Horizontal frequency	15–126 kHz
Computer control signal	9-pin D-sub connector (RS-232C Input Port/Output Port)
Speaker system	1 3 <sup>1</sup> / <sub>32</sub> " × 3 5 <sup>1</sup> / <sub>32</sub> " (5 × 8 cm) oval × 2, 3 W + 3 W (stereo)
Rated voltage	AC 110–120/220–240 V
Input current	6.2 A/3.1 A
Rated frequency	50/60 Hz
Power consumption	575 W
Power dissipation	< 2,100 BTU/hour
Operating temperature	41°F to 104°F (+5°C to +40°C)
Storage temperature	–4°F to 140°F (–20°C to +60°C)
Cabinet	Plastic
I/R carrier frequency	38 kHz
Laser pointer of remote control	Wave length: 650 nm / Max. output: 1 mW / Class II Laser Product
Dimensions (approx.)	17 3 <sup>1</sup> / <sub>64</sub> " (W) × 7 23 <sup>3</sup> / <sub>32</sub> " (H) × 24 29 <sup>6</sup> / <sub>64</sub> " (D) (444.2 × 196.2 × 621.3 mm) (main body only) 20 55 <sup>5</sup> / <sub>64</sub> " (W) × 8 23 <sup>3</sup> / <sub>32</sub> " (H) × 25 5 <sup>1</sup> / <sub>16</sub> " (D) (530.1 × 221.9 × 643.2 mm) (including standard lens, terminal cover, adjustment feet and projecting parts)
Weight (approx.)	41.7 lbs. (18.9 kg) (main body only)
Supplied accessories	Remote control, Two AA size batteries, Power cord (11' 10", 3.6 m), RGB cable (9' 10", 3 m), PS/2 mouse control cable (3' 3", 1 m), USB mouse control cable (3' 3", 1 m), Remote mouse receiver, Extra air filter, Terminal cover, CD-ROM, LCD projector operation manual, LCD projector quick reference, Sharp Advanced Presentation Software operation manual
Replacement parts	Lamp unit (Lamp/cage module) (BQC-XGV10WU/1), Remote control (RRMCG1564CESA), AA size batteries, Power cord (QACCU5013CEZZ), RGB cable (QCNW-5304CEZZ), PS/2 mouse control cable (QCNW-5113CEZZ), USB mouse control cable (QCNW-5680CEZZ), Remote mouse receiver (RUNTK0673CEZZ), Air filter (PFILD0110CEZZ), Terminal cover (CCOVA1789CE01), CD-ROM (UDSKA0030CEN1), LCD projector operation manual (TINS-7222CEZZ), LCD projector quick reference (TINS-7223CEZZ), Sharp Advanced Presentation Software operation manual (TINS-7224CEZZ)

This SHARP projector uses LCD (Liquid Crystal Display) panels. These very sophisticated panels contain 786,432 pixels (× RGB) TFTs (Thin Film Transistors). As with any high technology electronic equipment such as large screen TVs, video systems and video cameras, there are certain acceptable tolerances that the equipment must conform to.

This unit has some inactive TFTs within acceptable tolerances which may result in illuminated or inactive dots on the picture screen. This will not affect the picture quality or the life expectancy of the unit. If you have any questions about this matter, please call toll free 1-888-GO-SHARP (1-888-467-4277). U.S.A. ONLY

*Specifications are subject to change without notice.*





# Glossary

## **Aspect ratio**

Width and height ratio of an image. The normal aspect ratio of a computer and video image is 4 : 3. There are also wide images with an aspect ratio of 16 : 9 and 21 : 9.

## **Auto Sync**

Optimizes projected computer images by automatically adjusting certain characteristics.

## **Background**

Initial setting image projected when no signal is being input.

## **Border**

Displays the 4:3 image as the biggest size (768×576) that can be displayed on the WIDE mode screen (1024×576).

## **Clock**

Clock adjustment is used to adjust vertical noise when clock level is incorrect.

## **CLR Temp (Color temperature)**

Function that can be used to adjust the color temperature to suit the type of image input to the projector. Decrease the color temperature to create warmer, reddish images for natural flesh tones, or increase to create cooler, bluish images for a brighter picture.

## **Composite sync**

Signal combining horizontal and vertical sync pulses.

## **Digital shift**

Shifts image up or down easily by ▲/▼ buttons when RESIZE mode of input image is BORDER, STRETCH or SMART STRETCH of COMPUTER (except for SXGA and UXGA), VIDEO and DTV inputs.

## **Dot by dot**

Mode that projects images in their native resolution.

## **DVI**

Digital Visual Interface that supports both digital and analog displays.

## **GAMMA**

Image quality enhancement function that offers a richer image by brightening the darker portions of the image without altering the brightness of the brighter portions. You can select four different modes : STANDARD, GAMMA 1, GAMMA 2 and CUSTOM.

## **Intelligent compression and expansion**

High quality resizing of lower and higher resolution images to fit the projector's native resolution.

## **Intelligent digital keystone correction**

Function to digitally correct a distorted image when the projector is set up at an angle, smoothes out jaggies on keystone images and compresses the image not only horizontally but vertically keeping the 4 : 3 aspect ratio, and at the same time, calculates the aspect ratio automatically adjusting to the lens shift width.

## **Keylock level**

Mode that can lock the operation of projector buttons to prevent mischief.

## **Lamp Mode**

Mode that enables you to use two lamps in different combinations. You can select four different modes : Both Lamps (use two lamps simultaneously), Lamp 1 only (use only lamp 1), Lamp 2 only (use only lamp 2 ) and Equal Use (use lamp 1 and lamp 2 alternatingly).

## **Lens shift**

The lens can be easily raised and lowered to minimize or eliminate "Keystone" type effect.

## **Magnification (ENLARGE)**

Digitally zooms in on a portion of an image.

## **Optional Board**

The expansion board (sold separately) enables you to respond to the image signal for business-use and RS-422 control.

## **Phase**

Phase shift is a timing shift between isomorphic signals with the same resolution. When phase level is incorrect, the projected image typically displays horizontal flicker.

## **Picture in Picture**

Allows you to add video images onto a data screen image, providing you with even more effective presentations.

## **Presentation tools**

Helpful tools used to emphasize keypoints throughout a presentation.

## **Progressive Mode**

The progressive display projects a smoother video image. You can select three different modes : 2D Progressive, 3D Progressive and Film Mode.

## **RESIZE**

Allows you to modify or customize the picture display mode to enhance the input image. You can select six different modes: NORMAL, FULL, DOT BY DOT, BORDER, STRETCH and SMART STRETCH.

## **RS-232C**

Function to control the projector from the computer by using the RS-232C ports on the projector and computer.

## **Set Inputs**

Function to limit inputs. For example, when setting Input 2 to "OFF", the input is switchable only between Input 1 and Input 3, skipping Input 2.

## **Smart Stretch**

Mode that stretches the right and left sides of the 4:3 image horizontally while maintaining the aspect ratio around the center of the image to display it on the WIDE screen.

## **Stack Setting**

Prevents trouble with adjustment and operation when stack projecting. When setting two projectors, one to master and the other to slave, the slave follows the master's operation.

## **Status function**

Displays the settings of each adjustment item.

## **Stretch**

Mode that stretches the 4:3 image horizontally to display it on the WIDE screen.

## **Sync on green**

Video signal mode of a computer which overlaps horizontal and vertical sync signal to green color signal pin.

## **3D DNR (3D Digital Noise Reduction)**

Provides high quality images with minimal dot crawl and cross color noise.







# Index

## A

AC socket.....	14
Adjusting the Picture .....	43
Adjustment Feet .....	20
ADJUSTMENT switch.....	12
Air filter .....	73
Aspect ratio .....	34
Audio .....	50
Audio cable .....	18
AUDIO INPUT terminals .....	11
AUDIO OUTPUT terminals .....	11
Automatic power shutoff function .....	55
Auto sync adjustment .....	49
AUTO SYNC button.....	49

## B

Background .....	54
BACKLIGHT button .....	37
BLACK SCREEN button .....	32
BNC-RCA adaptors.....	17
BORDER .....	34

## C

Carrying handle .....	4
Ceiling-mount .....	30
Ceiling+Rear .....	56
Clock .....	46
CLR Temp (Color Temperature) .....	44

## D

Digital shift .....	29
DOT BY DOT .....	34
DVI INPUT port (INPUT 3) .....	16

## E

Economy Mode .....	55
ENLARGE button .....	33
ENTER button.....	10
Exhaust vent.....	3
Extra air filter .....	13

## F

FREEZE button .....	32
---------------------	----

## G

GAMMA button .....	35
GUI (Graphical User Interface) .....	40

## I

INPUT buttons .....	31
INPUT port .....	11
Intelligent digital keystone correction .....	29

## K

Keylock Levels .....	59
----------------------	----

## L

LAMP REPLACEMENT indicators .....	69
LASER POINTER button.....	39
LEFT-CLICK button .....	37
LENS button .....	29
Lens shift.....	29

## M

MENU button.....	40
Monitor Out/RS-232C Off Function .....	55
MOUSE/ADJUSTMENT buttons .....	12
MOUSE/ADJUSTMENT switch .....	36
MUTE button .....	31

## N

Network Function .....	65
------------------------	----

## O

On-screen display .....	53
On-screen display Language .....	57
Optional Board .....	62
OUTPUT port .....	11

## P

Password .....	61
PDF .....	9
Phase .....	46
Picture in Picture .....	51
POWER buttons .....	19
Power cord .....	14
POWER indicator .....	19
Presentation tools .....	64
Progressive Mode .....	45
PS/2 mouse control cable .....	38

## R

Rear projection .....	30
Remote control .....	12
Remote control sensor .....	36
Remote control signal transmitter .....	12
Remote mouse receiver .....	38
RESIZE button .....	34
RGB cable .....	14
RIGHT-CLICK button .....	37
RS-232C port .....	11

## S

Save Setting .....	47
Select Setting .....	47
Set ID No. ....	63
Set Inputs .....	59
Speakers .....	11
Stack Setting .....	63
Startup image .....	54
Status function .....	58
S-VIDEO INPUT terminal .....	11
SXGA .....	5
Sync .....	49
Sync on green .....	79

## T

TEMPERATURE WARNING indicator .....	69
TOOLS button .....	64
Transmission Speed (RS-232C) .....	60

## U

UNDO button .....	40
USB mouse control cable .....	38

## V

VIDEO INPUT terminal .....	11
Video System .....	53
Videowall .....	68
VOLUME buttons .....	31

## W

Wired remote control input .....	39
WIRED REMOTE control input terminal .....	39
Wireless mouse .....	37

## No.

1.2.3 button .....	31
3D DNR (3D Digital Noise Reduction) .....	52
4.5.6 button .....	31



# SHARP CORPORATION

## Free Manuals Download Website

<http://myh66.com>

<http://usermanuals.us>

<http://www.somanuals.com>

<http://www.4manuals.cc>

<http://www.manual-lib.com>

<http://www.404manual.com>

<http://www.luxmanual.com>

<http://aubethermostatmanual.com>

Golf course search by state

<http://golfingnear.com>

Email search by domain

<http://emailbydomain.com>

Auto manuals search

<http://auto.somanuals.com>

TV manuals search

<http://tv.somanuals.com>