



## MP 595 Modem

# User Guide



2130795  
Rev 1.3





## Important Notice

Due to the nature of wireless communications, transmission and reception of data can never be guaranteed. Data may be delayed, corrupted (i.e., have errors) or be totally lost. Although significant delays or losses of data are rare when wireless devices such as the Sierra Wireless modem are used in a normal manner with a well-constructed network, the Sierra Wireless modem should not be used in situations where failure to transmit or receive data could result in damage of any kind to the user or any other party, including but not limited to personal injury, death, or loss of property. Sierra Wireless accepts no responsibility for damages of any kind resulting from delays or errors in data transmitted or received using the Sierra Wireless modem, or for failure of the Sierra Wireless modem to transmit or receive such data.

## Safety and Hazards

Do not operate the Sierra Wireless modem in areas where blasting is in progress, where explosive atmospheres may be present, near medical equipment, near life support equipment, or any equipment which may be susceptible to any form of radio interference. In such areas, the Sierra Wireless modem **MUST BE POWERED OFF**. The Sierra Wireless modem can transmit signals that could interfere with this equipment.

Do not operate the Sierra Wireless modem in any aircraft, whether the aircraft is on the ground or in flight. In aircraft, the Sierra Wireless modem **MUST BE POWERED OFF**. When operating, the Sierra Wireless modem can transmit signals that could interfere with various onboard systems.

---

*Note: Some airlines may permit the use of cellular phones while the aircraft is on the ground and the door is open. Sierra Wireless modems may be used at this time.*

---

The driver or operator of any vehicle should not operate the Sierra Wireless modem while in control of a vehicle. Doing so will detract from the driver or operator's control and operation of that vehicle. In some states and provinces, operating such communications devices while in control of a vehicle is an offence.

## Limitation of Liability

The information in this manual is subject to change without notice and does not represent a commitment on the part of Sierra Wireless. SIERRA WIRELESS AND ITS AFFILIATES SPECIFICALLY DISCLAIM LIABILITY FOR ANY AND ALL DIRECT, INDIRECT, SPECIAL, GENERAL, INCIDENTAL, CONSEQUENTIAL, PUNITIVE OR EXEMPLARY DAMAGES INCLUDING, BUT NOT LIMITED TO, LOSS OF PROFITS OR

## Patents

REVENUE OR ANTICIPATED PROFITS OR REVENUE ARISING OUT OF THE USE OR INABILITY TO USE ANY SIERRA WIRELESS PRODUCT, EVEN IF SIERRA WIRELESS AND/OR ITS AFFILIATES HAS BEEN ADVISED OF THE POSSIBILITY OF SUCH DAMAGES OR THEY ARE FORESEEABLE OR FOR CLAIMS BY ANY THIRD PARTY.

Notwithstanding the foregoing, in no event shall Sierra Wireless and/or its affiliates aggregate liability arising under or in connection with the Sierra Wireless product, regardless of the number of events, occurrences, or claims giving rise to liability, be in excess of the price paid by the purchaser for the Sierra Wireless product.

Portions of this product may be covered by some or all of the following US patents:

5,515,013	5,629,960	5,845,216	5,847,553	5,878,234
5,890,057	5,929,815	6,169,884	6,191,741	6,199,168
6,339,405	6,359,591	6,400,336	6,516,204	6,561,851
6,643,501	6,653,979	6,697,030	6,785,830	6,845,249
6,847,830	6,876,697	6,879,585	6,886,049	6,968,171
6,985,757	7,023,878	7,053,843	7,106,569	7,145,267
7,200,512	D442,170	D459,303		

and other patents pending.

This product includes

technology licensed from:

QUALCOMM® 3G

Licensed by QUALCOMM Incorporated under one or more of the following United States patents and/or their counterparts in other nations:

4,901,307	5,056,109	5,101,501	5,109,390	5,228,054
5,267,261	5,267,262	5,337,338	5,414,796	5,416,797
5,490,165	5,504,773	5,506,865	5,511,073	5,535,239
5,544,196	5,568,483	5,600,754	5,657,420	5,659,569
5,710,784	5,778,338			

Manufactured or sold by Sierra Wireless or its licensees under one or more patents licensed from InterDigital Group.

Licensed under the following Nortel Networks Limited patents:

United States patent numbers: 5128925, 5398247

France patent numbers: 2665993, 2653959, 2659812, 2745091

## Copyright

© 2007 Sierra Wireless. All rights reserved.

## Trademarks

AirCard<sup>®</sup> and “Heart of the Wireless Machine<sup>®</sup>” are registered trademarks of Sierra Wireless. Watcher<sup>®</sup> is a trademark of Sierra Wireless, registered in the European Community. Sierra Wireless, the Sierra Wireless logo, the red wave design, and the red-tipped antenna are trademarks of Sierra Wireless.

Windows<sup>®</sup> is a registered trademark of Microsoft Corporation.

QUALCOMM<sup>®</sup> is a registered trademark of QUALCOMM Incorporated. Used under license.

Other trademarks are the property of the respective owners.

## Contact Information

Sales Desk:	Phone:	1-604-232-1488
	Hours:	8:00 AM to 5:00 PM Pacific Time
	E-mail:	sales@sierrawireless.com
Post:	Sierra Wireless 13811 Wireless Way Richmond, BC Canada V6V 3A4	
Fax:	1-604-231-1109	
Web:	www.sierrawireless.com	

Consult our website for up-to-date product descriptions, documentation, application notes, firmware upgrades, troubleshooting tips, and press releases:

[www.sierrawireless.com](http://www.sierrawireless.com)

## Revision History

Revision number	Release date	Changes
1.3	August 2007	<ul style="list-style-type: none"> <li>Removed detail about AT command parameters, instead directing users to the <i>MP 3G Modems AT Command Reference</i>. (Document #2130810.)</li> <li>Updated regulatory information for Canada and the USA. (See “Regulatory Information” on page 63.).</li> </ul>

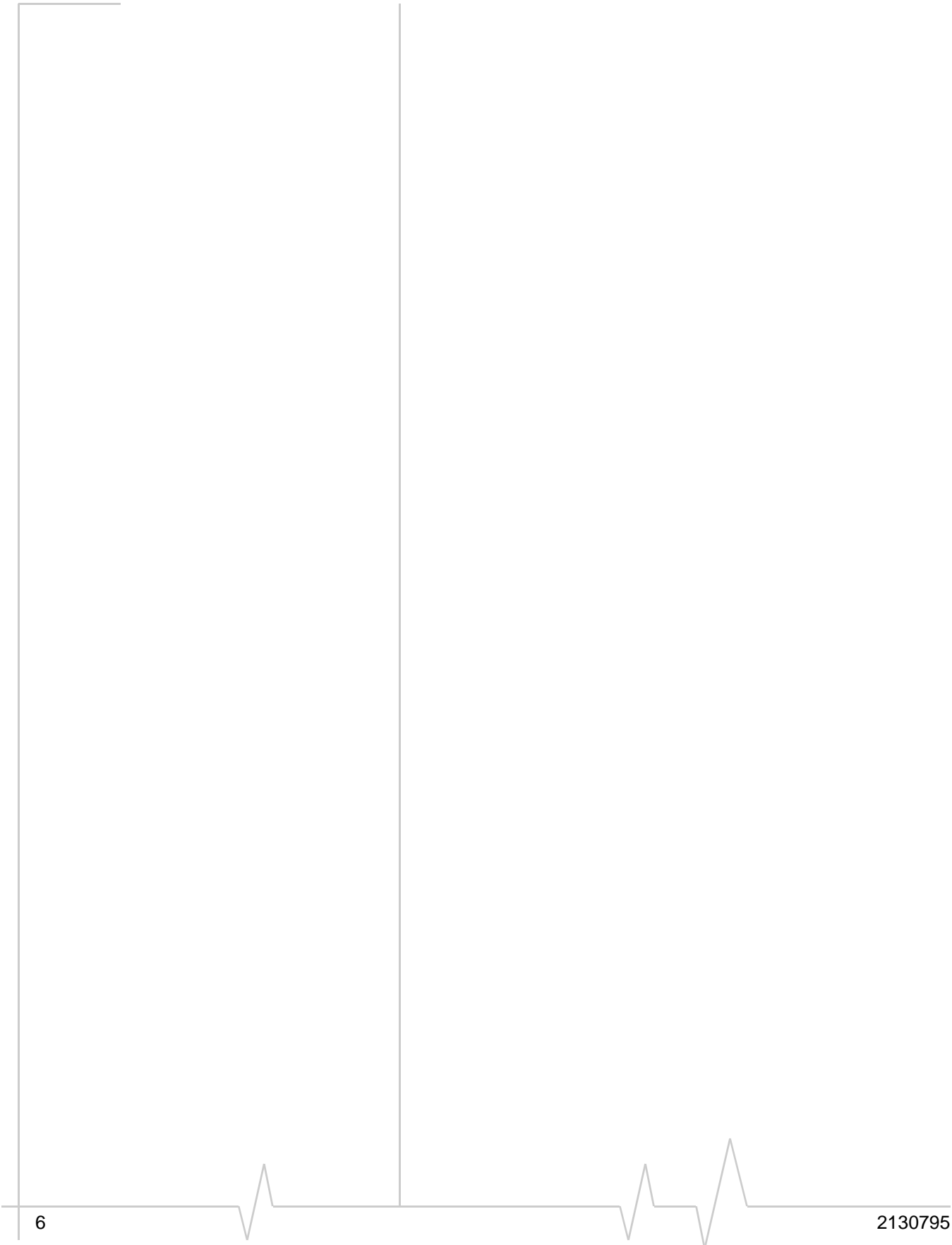

# >> Contents

<b>Introducing the MP 595 Modem</b> .....	<b>13</b>
About CDMA .....	14
CDMA account and coverage .....	15
Supported CDMA radio frequencies .....	16
Receive diversity .....	16
USB, Ethernet, or serial computer connection .....	16
Virtual serial port .....	16
VPN support for RNAP .....	17
Software .....	17
MP Modem Manager .....	18
Documentation .....	18
<b>Hardware and Software</b>	
<b>Installation</b> .....	<b>21</b>
Package contents .....	21
Required equipment .....	21
System requirements .....	22
MP Modem accessories .....	22
Installation overview .....	23
MP Modem housing .....	23
Connector panel .....	23
GPS and I/O options .....	24
Overview of installation steps .....	24

- Install the MP modem ..... 24
  - Step 1—Mount the MP modem ..... 24
    - Select a location for the MP modem ..... 24
    - Mounting procedure ..... 25
    - Ground the MP modem ..... 26
  - Step 2—Mount the antennas and install the cables ..... 26
    - RF antennas ..... 27
    - GPS antennas ..... 27
    - Antenna locations ..... 27
    - Install the antennas and cables ..... 28
  - Step 3—Install the Power Harness ..... 28
    - Power connector ..... 29
    - Power connector (Molex) pinouts ..... 29
    - Ignition sense on/off wiring ..... 30
    - Ignition sense options ..... 30
    - Ground the power harness ..... 31
    - Power connections ..... 31
    - Correct wire splicing ..... 31
    - Crimp terminals ..... 31
  - Step 4—Connect MP modem to computer cable to the MP modem .. 32
    - Serial connector (DB9) pinouts ..... 33
    - Install the USB, Ethernet or serial cable ..... 33
    - I/O port connections ..... 34
  - Step 5—Install the software ..... 34
  - Step 6—Activate your account ..... 34
    - The Activation Wizard ..... 34
    - Manual activation ..... 35
    - Automated activation ..... 35
  - Step 7—Test the system ..... 35
- Operating the MP Modem .....37**
  - Turning the MP modem on and off ..... 37
  - Reading the status indicators ..... 38
  - Resetting the MP modem ..... 39



3G Watcher software. . . . . 39

    3G Watcher Help . . . . . 39

    Launching 3G Watcher . . . . . 40

    3G Watcher window . . . . . 40

Establishing connections. . . . . 40

**Configuring the MP Modem to Report GPS and I/O Data . . . . . 41**

    GPS configuration and reporting . . . . . 41

        GPS protocols and commands . . . . . 42

        GPS display in 3G Watcher . . . . . 42

        GPS TAIP quick reference . . . . . 43

    I/O device installation and configuration . . . . . 43

        Connector pinouts . . . . . 44

            Port specifications . . . . . 44

        Digital input devices . . . . . 44

            Example: panic button connections . . . . . 45

        Digital output devices . . . . . 45

        Analog input devices . . . . . 46

            Example: analog sensor connections. . . . . 47

        I/O configuration using AT or 3G Watcher commands . . . . . 47

            Analog input setup . . . . . 48

            Digital I/O setup . . . . . 49

**Sending Data to Your Network Application . . . . . 51**

    Configuring the MP modem to route data to a server. . . . . 51

        Report frequency timers . . . . . 51

        Monitoring and Tracking configuration . . . . . 54

        IP Addressing . . . . . 54

        The problem created by Network Address Translation . . . . . 55

            Solutions to the NAT problem. . . . . 56

    Retrieving the Unique Mobile Device ID . . . . . 56

**Support and Warranty .....57**  
    Technical support ..... 57  
    Warranty..... 57

**Technical Specifications .....59**  
    Regulatory, radio frequency and electrical specifications ..... 59  
    Environmental specifications ..... 60  
    Weight and dimensions ..... 60  
    Host interfaces ..... 61  
    Other interfaces ..... 61  
    GPS specifications ..... 61  
    I/O port characteristics ..... 62  
    3G Watcher software ..... 62

**Regulatory Information .....63**  
    Canada ..... 63  
    U.S.A. .... 63







# 1: Introducing the MP 595 Modem

1

- About CDMA
- CDMA account and coverage
- Receive diversity
- USB, Ethernet, or serial computer connection
- Virtual serial port
- VPN support for RNAP
- Software
- Documentation

*Note: Do not connect the MP modem to a USB port on a computer before installing the software. (See “Step 5—Install the software” on page 34.)*



The Sierra Wireless MP modem provides a wireless network connection for portable computers installed in vehicles.

The MP modem is usually installed in the vehicle's trunk and connected to a notebook computer in the passenger compartment. A radio frequency (RF) antenna mounted on the roof of the vehicle enables the MP modem to communicate through a wireless network to a host computer.

A built-in Global Positioning System (GPS) module provides location and heading data that can also be remotely monitored.

The following diagram illustrates how the system works:

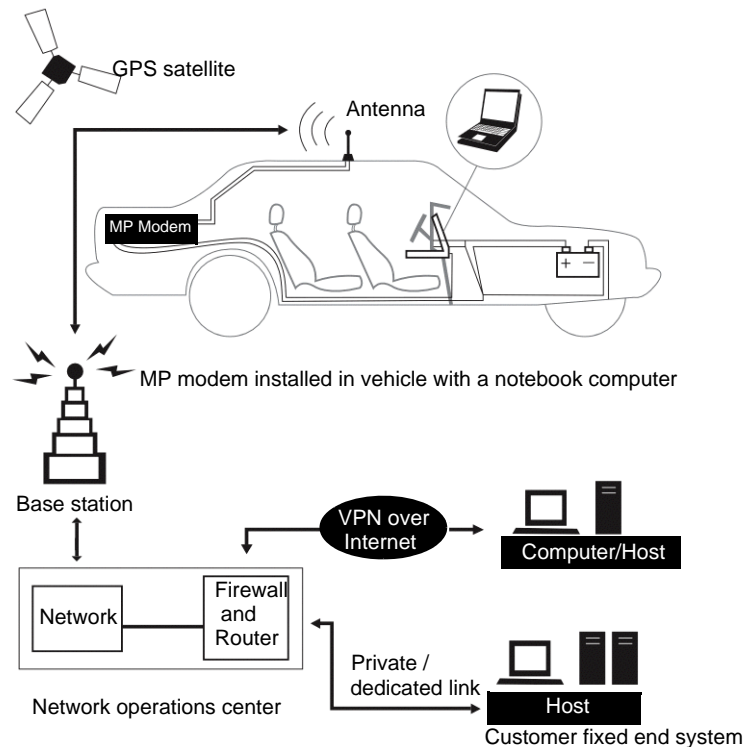

Figure 1-1: The MP modem and the network.

The MP modem has a rugged design that allows it to withstand the vibration, shock, humidity, and extremes of temperature experienced in the normal operation of police, emergency, utility, and field service vehicles.

You can use the network connection provided by the MP modem to access shared data, browse the Internet, and send and receive e-mail and text messages. The MP modem also allows for sensors, gauges, and alarms (such as panic buttons) to be installed in vehicles and remotely monitored from a central location.

## About CDMA

The MP 595 modem operates over a type of wireless network called Code Division Multiple Access (CDMA). CDMA Third Generation (3G) technology provides a variety of connectivity features, depending on your service provider and account:

- 1x Evolution-Data Optimized Revision A (1xEV-DO Rev. A) supports Internet connections with data

rates up to 3.1 Megabits per second (Mbps) downlink from the network and 1.8 Mbps uplink to the network. Average data rates are 450-800 kilobits per second (kbps) downlink and 300-400 kbps uplink. Actual speed depends on network conditions.

- 1xEV-DO Revision 0 (Rev. 0) supports Internet connections with data rates up to 2.4 Mbps downlink and 153 kbps uplink. Average data rates are 400–700 kbps downlink and 40-80 kbps uplink. Actual speed depends on network conditions.
- 1x supports Internet connections with data rates up to 153 kbps. Actual speed depends on the network conditions.
- Circuit switched (dial-up) data, using the earlier CDMA IS-95 specification, supports data connections to any dial-up service at rates up to 14.4 kbps.

The MP 595 modem is primarily designed to provide 1x or better data connections but it also allows for Circuit Switched Data (CSD) connections in areas that have CDMA IS-95 coverage but no 3G (1xEVDO or 1x) high-speed packet service.

Quick Net Connect (QNC) provides a simplified way to dial into an Internet connection using CSD, assuming CSD is supported by your service provider.

Once a connection is established, you can open your browser and connect to web sites and access other Internet services such as e-mail.

## CDMA account and coverage

You must set up an account with a CDMA service provider for each MP 595 modem you install. After installing the MP 595 modem software, you must configure it to use an account.

The ability of the MP 595 modem to obtain service and the type of service obtained in any area is determined by several factors:

**Network proximity and 1xEV-DO CDMA availability** To obtain service, you must be within the coverage area of a network operating in one of the radio frequency bands supported by the MP 595 modem. The type of connection depends on the service available in that area. For example, there are areas with 1x service in which 1xEV-DO has not yet been implemented.

**Roaming** If you are within the coverage of a network operated by a different service provider, your ability to obtain service depends on whether a roaming agreement exists between your service provider and the one operating your current local network. There may be additional fees for roaming service. Contact your reseller or service provider for information.

**Account provisions** Your account may restrict usage of certain networks or may limit your connection time or data transmission.

## Supported CDMA radio frequencies

CDMA networks operate on two sets of radio frequency bands. The MP 595 modem is a dual-band product that operates on both bands:

- **1900 MHz** (also called the PCS, or Personal Communications Services, band)
- **800 MHz** (Cellular band)

## Receive diversity

The MP 595 modem supports receive diversity for improved signal reception. Receive diversity uses two antennas to enhance the quality of the signal, but does not extend the MP modem's coverage area.

## USB, Ethernet, or serial computer connection

You can connect the MP modem to a USB, Ethernet (RJ45), or serial (DB9) port on a computer. When connected to a USB or Ethernet port, the MP modem behaves like a network card. When connected to a serial port, the MP modem behaves like a dial-up modem.

## Virtual serial port

The MP modem supports four virtual serial ports (VSPs). Three are reserved for internal use by the MP modem. The remaining VSP, which is called Sierra Wireless Application Interface 2, is assigned to a specific COM port that varies between users. This VSP can be used, for example, to send AT commands, or to run applications such as HyperTerminal®.



Special MP modem modes such as GPS that are supported on a serial port are also available on the virtual port. For example, with the virtual port enabled, a mapping application on your computer that normally listens for GPS messages on a serial port listens for those same messages on the virtual port.

The MP modem virtual serial port is available on both USB and Ethernet interfaces. For information on enabling a virtual serial port, see the *MP 3G Modems AT Command Reference* (document #2130810).

## VPN support for RNAP

This feature allows for the exchange of Remote Network Access Protocol (RNAP<sup>1</sup>) data between the MP modem and a remote server accessible only through a Virtual Private Network (VPN) connection. When using this feature, you must have 3G Watcher running on the computer.

The MP modem sends RNAP data over Ethernet or USB to 3G Watcher on the computer. 3G Watcher places the RNAP data in a User Datagram Protocol/Internet Protocol (UDP/IP) packet and sends it over the VPN connection to the server. When 3G Watcher receives a UDP/IP packet containing RNAP data over the VPN connection, it disassembles the packet and sends the RNAP data to the MP modem.

You can enable this option using 3G Watcher software or AT commands. See the 3G Watcher online help and the *MP 3G Modems AT Command Reference* (document #2130810) for details.

## Software

The MP modem comes with the following software:

- 3G Watcher, the software for the MP modem which allows you to manage and monitor your connections.
- The driver that forms the interface between the MP modem and your Windows operating system.
- The firmware that is stored in non-volatile memory.

The MP 595 modem has an embedded radio module (a Mini Card 5725), also made by Sierra Wireless, Inc. There are two firmware programs on the MP 595 modem—one

---

1. RNAP is a Sierra Wireless proprietary protocol that encapsulates the MTP data that is sent to and from the MP modem. It ensures that the MP modem and remote host alike recognize the data packets. See *The Monitoring and Tracking Protocol Guide* on [page 19](#).

stored on the controller board of the MP modem and one on the radio module.

The firmware was loaded into the radio module and controller board when the MP modem was assembled. As new versions of the software and firmware are released, they are posted at [www.sierrawireless.com](http://www.sierrawireless.com).

### **MP Modem Manager**

MP Modem Manager is a web-based diagnostic and management tool that allows you to remotely monitor and configure a fleet of MP modems. With MP Modem Manager you can:

- Diagnose and troubleshoot field issues.
- Identify MP modem firmware versions and remotely upgrade firmware.
- Organize MP modems into groups for table viewing of modem and network status.
- Configure GPS settings.

MP Modem Manager software is available free of charge. To request this software, complete and submit the form at:

[https://www.sierrawireless.com/product/mp\\_modem\\_mgr\\_request.aspx](https://www.sierrawireless.com/product/mp_modem_mgr_request.aspx).

## **Documentation**

This *MP 595 Modem User Guide* describes how to:

- Install the MP modem hardware.
- Connect the radio and GPS antennas.
- Connect a notebook computer and other input/output (I/O) devices.
- Install the software.
- Configure the software to use a CDMA account.
- Interpret the LEDs on the MP modem and the indicators in the 3G Watcher software.
- Configure the MP modem to report GPS and/or I/O data (from sensors, gauges, or panic buttons).
- Use the MP modem to connect to a network.
- Collect and use GPS and I/O data from a fleet of vehicles in which MP modems are installed.

This *User Guide* is provided as a PDF (Portable Document Format) file on the installation CD.

Online help is provided with 3G Watcher. It describes all the icons and indicators in 3G Watcher and provides detailed instructions on using 3G Watcher to make data connections. When using 3G Watcher, you can access help through the menu system or by pressing the <F1> key.

The *MP 3G Modems AT Command Reference* (document #2130810) describes the available AT command set.

The *MP Modem Manager User Guide* (document #2130554) provides information on how to install, configure, and use the MP Modem Manager software to manage a fleet of modems.

The *Monitoring and Tracking Protocol Guide* describes the protocols used in data transmissions between the MP modem and the network server. It provides the information necessary to develop host applications that process GPS and digital input from a fleet of MP modems. For more information contact [support@sierrawireless.com](mailto:support@sierrawireless.com).

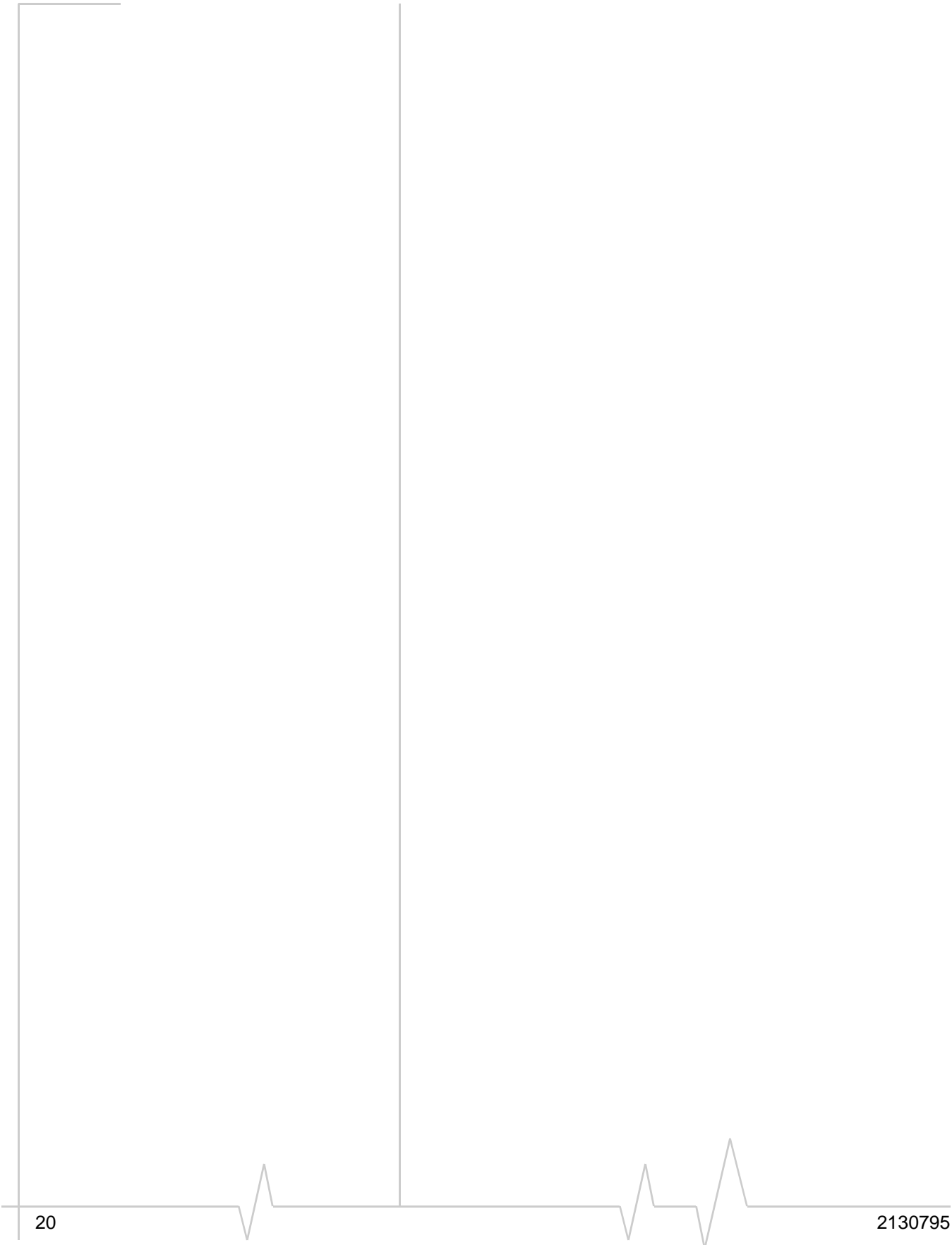

## 2: Hardware and Software Installation

- Installation overview
- Install the MP modem

This chapter shows you how to install the MP modem in a vehicle, how to install the 3G Watcher software, and how to activate your account. Before you begin the installation, ensure that you have all the necessary components and equipment listed in the following sections, and have read the “[Installation overview](#)” on page 23.

### Package contents

Each MP modem box contains:

- The MP modem
- A mounting template
- Mounting screws and washers
- An installation and documentation CD
- A power harness

If any of these are missing, please contact your account manager.

### Required equipment

To install the MP 595 modem, you need the power harness (or existing MP 555 Series power harness), mounting template, and the screws and washers that come with the device.

You also require:

- **A USB, Ethernet, or 9-pin serial cable.** This must be long enough to run from the mounting location of the MP modem to the computer.
  - The maximum length for the serial or USB cable is 5.5-m (18 feet). The USB cable must have a Type A male connector at the computer end and a Type B male connector at the MP modem end.
  - The Ethernet cable should have RJ-45 connectors. The MP modem’s performance is affected by the type of Ethernet card in the computer and the type of cable used. The minimum requirement for the Ethernet cable is an unshielded twisted pair (UTP) cable, category 3 or 4. For better performance, use a shielded, category 5 cable. The maximum length is 100-m (328 feet).

---

*Note: If GPS is being implemented, you require either two antennas or a combination RF and GPS antenna.*

---

---

*Note: Do not connect the MP modem to a USB port on a computer before installing the software.*

---

- **Radio frequency (RF) antenna and cable.** The antenna must have the appropriate regulatory approval, 50 ohm impedance, and a male TNC connector. It may be a hard or magnetic-mounted antenna.
- **Additional Diversity RF antenna (optional).** This is required if you use the receive diversity feature. The additional antenna must have a male SMA connector.
- **GPS antenna and cable (optional).** This is necessary if you use the built-in GPS module.
- **Power supply.** This is usually the vehicle's battery.
- **Appropriate electrical grounding.** If a ground wire is necessary, use a 16-gauge wire and connect it to a ground screw.
- **I/O cable (optional).** This is required if a panic button, sensor, gauge, or other I/O device is installed.

## System requirements

Before you begin the installation, ensure your computer has the following system requirements necessary for the installation and running of 3G Watcher software:

- Operating systems:
  - Windows® Vista™
  - Windows 2000 Professional (with Service Pack 4 or later)
  - Windows XP (Home or Professional)
- Available USB, Ethernet, or DB9 serial port
- CD-ROM drive (installation only)
- 32 MB RAM memory

## MP Modem accessories

For information about accessories for your MP modem — including cables and antennas — contact your account manager or visit [www.sierrawireless.com](http://www.sierrawireless.com).

## Installation overview

The following diagram illustrates the overall installation.

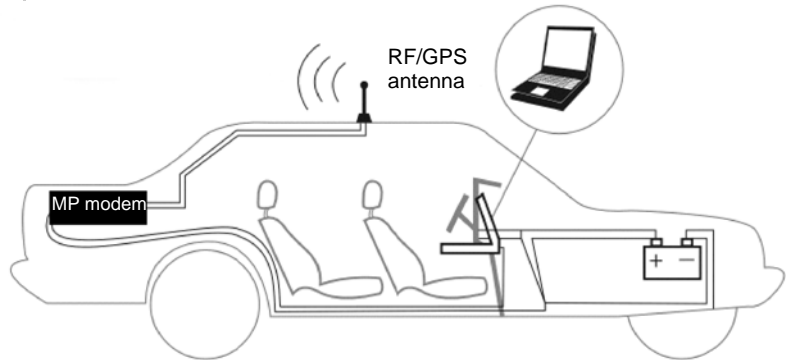

*Note: The MP modem is designed for negative-ground vehicles only. It will not function in a positive-ground vehicle.*

Figure 2-1: Installation of the MP modem in a vehicle equipped with a notebook computer and a combination antenna, using the car battery for power and ignition-sense wiring for power on/off.

### MP Modem housing

The MP modem has a rectangular metal housing. There is a connector panel on the rear of the housing, an indicator panel on the front of the housing, a reset button on top, and mounting holes along the bottom edges on either side.

### Connector panel

The MP 595 modem has the following connectors at the rear of the MP modem:

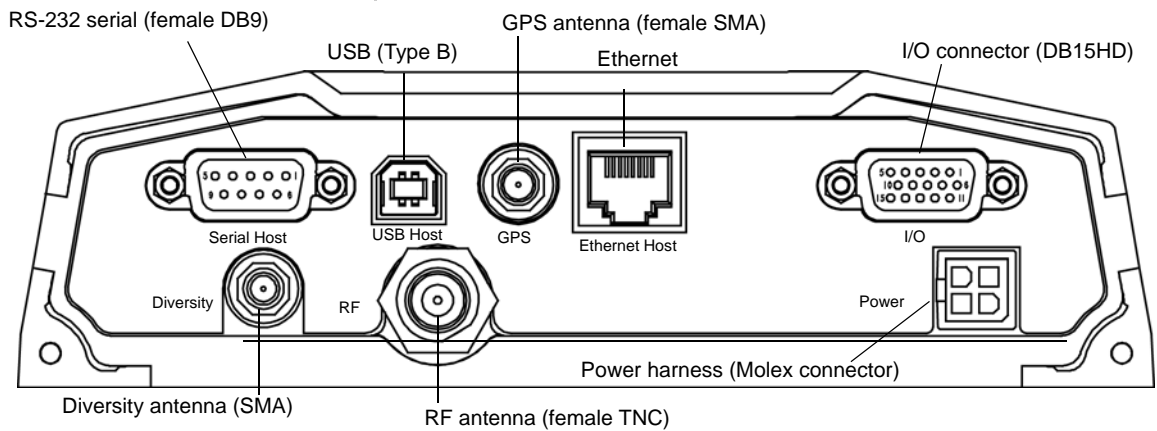

Figure 2-2: MP 595 modem rear connectors

---

*Note: Electrical installations are potentially dangerous and should be performed by personnel thoroughly trained in safe electrical wiring procedures for vehicles.*

---

## GPS and I/O options

The MP modem provides support for GPS (Global Positioning System) and for attaching input/output devices.

**GPS.** If you plan to use the MP modem's built-in GPS module, you must connect a GPS antenna using an antenna cable, or use a combination antenna that can connect to both the GPS and RF connectors on the MP modem housing.

**Other I/O devices.** Other devices, such as panic buttons, sensors, or gauges may also be installed with the MP modem and connected with an I/O cable to the I/O port. (See "[I/O port connections](#)" on page 34.)

## Overview of installation steps

The installation process for the MP modem varies depending on how you plan to use it, where it best fits in your vehicle, and which of its features you plan to use. The main steps are:

1. Mount the MP modem.
2. Mount the antennas and connect the cables.
  - RF antenna and cable.
  - Additional RF antenna and cable, if you plan to use receive diversity.
  - GPS antenna and cable, if you plan to use GPS.
3. Connect the power harness.
4. Connect the cable that will run between the MP modem and your computer to the MP modem.
 

**Do not connect the cable to the computer until you have installed the software.**
5. Install the software.
6. Start 3G Watcher and activate your account.
7. Test the system.

## Install the MP modem

### Step 1—Mount the MP modem

The MP modem is usually mounted in the trunk of the vehicle, but other possibilities are under the dashboard or a seat.

#### Select a location for the MP modem

When selecting a mounting location, remember the following:

---

*Note: Power off the MP modem, your computer, and any other devices while you are connecting cables.*

---



- Do not expose the MP modem to weather and environmental conditions beyond the ranges listed in the environmental specifications on [page 60](#). Avoid excessive heat from the engine compartment, heaters, or the exhaust system, and extreme cold from direct contact with air conditioners or other cooling systems. Never immerse it in any liquid.
- If you are replacing a MP modem, you can mount the new MP modem in the same location using the existing mounting holes.
- Every device connected to the MP modem, as well as the MP modem itself, should be grounded. (See “[Ground the MP modem](#)” on page 26 and “[Ground the power harness](#)” on page 31.)
- Route cables to their destinations without using excess wiring.
- Make sure all connectors and the reset button are easy to reach and the indicator lights are visible.

### Mounting procedure

To mount the MP modem:

1. Use the provided mounting template to mark the location of the mounting holes.
2. Drill 5/32" pilot holes (unless you are reusing holes from a previous MP modem mounting).
3. Use the supplied mounting screws and washers to secure the MP modem through the holes along the edge of the case bottom.



Figure 2-3: Mounting the MP modem. Arrows indicate the mounting holes.

## Ground the MP modem

*Note: Electrical installations are potentially dangerous and should be performed by personnel thoroughly trained in safe electrical wiring procedures for vehicles.*

Automotive installations usually provide a good quality ground for each piece of electrical equipment. In most cases, ground the MP modem by connecting the black ground wire of the power harness to either the vehicle chassis or to the negative terminal of the battery.

If a device connected to the MP modem, such as a notebook computer, is not properly grounded, it may ground itself through the cable connecting it to the MP modem. This creates a hazard and could cause equipment damage. If you cannot properly ground a device, a potential solution is to install a fuse in the ground return wire.

The power harness has 5 A fuses on the red power wire and the white ignition sense wire, but *not* on the black ground return wire. (See “[Step 3 – Install the Power Harness](#)” on page 28.)

You can also use a ground screw on the connector panel of the MP modem. Use a 16-gauge wire if you choose to use a ground screw. A ground screw is not required as long as the power harness is properly grounded.

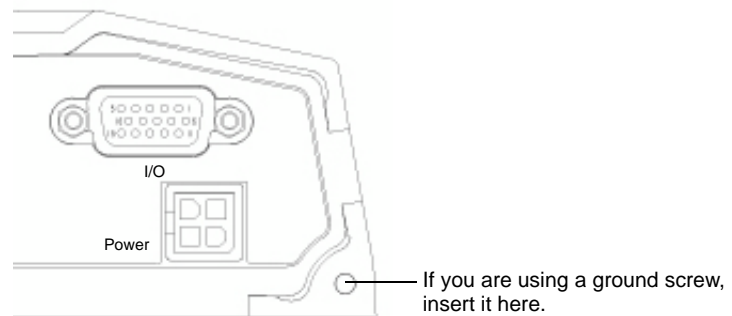

Figure 2-4: The ground screw connector on the connector panel.

*Note: Tighten cables connected to the MP modem by hand. Do not use tools.*

## Step 2—Mount the antennas and install the cables

The MP 595 modem has two RF antenna connectors and one GPS antenna connector. The MP modem requires an RF antenna to connect to the wireless network. The second RF connector is optional and allows for receive diversity.

The built-in GPS module requires a dedicated GPS antenna or a combination antenna with cables to both the RF and GPS antenna connectors on the MP modem.

If you already have an MP Modem Combo GPS antenna, you can re-use it with your new MP modem. This antenna has two leads — one for RF (TNC connector) and one for GPS (SMA connector).

### RF antennas

Use an approved RF antenna to connect to the wireless network. The antenna must have 50 ohms impedance and a cable with a TNC connector (or SMA connector if the antenna is being used for receive diversity), as well as the following characteristics:

- The total maximum gain, including cable loss, must not exceed 4.15 dBi (if the antenna operates on the PCS band) or 5.1 dBi (if the antenna operates only on the Cellular band).
- The antenna must transmit and receive on the necessary frequency bands in your coverage area. The MP 595 modem supports these RF bands:
  - 1900 MHz (PCS)
  - 800 MHz (Cellular)

You can use a dual-band antenna that supports both frequencies. If your MP modem will only be connected to networks that use one of the bands, an appropriate single-band antenna is sufficient. Contact your service provider for information about radio bands used in your area.

For more information about antennas for your installation contact your account manager.

### GPS antennas

The GPS antenna connects to the MP modem using a male SMA connector. Contact your account manager for more information about compatible GPS antennas.

### Antenna locations

When selecting locations for the RF and GPS antennas:

- Refer to the documentation provided with each antenna to determine whether it requires a ground plane.
- Ensure that the RF antenna is mounted at least 20 cm (8 inches) from vehicle occupants and bystanders.
- Ensure that all radio antennas (RF, GPS, CB radio, car radio) are mounted at least 30 cm (12 inches) or more apart.

*Note: To avoid RF interference problems and possible damage to the MP modem, **do not** power on the MP modem before connecting the RF antenna.*

- If you are using receive diversity, connect an additional RF antenna to the diversity antenna connector (SMA) on the back of the MP 595 modem. Ensure that the two RF antennas are 30 to 60 cm (12 to 24 inches) apart.

### Install the antennas and cables

*Note: When connecting the cables, hand-tighten the connectors; do not use tools.*

To install the RF and GPS antennas:

1. Mount each antenna according to the instructions provided with it.
2. Thread the antenna cables through the car to reach the MP modem. Secure the cables as necessary.
3. Connect the RF antenna cable to the TNC connector on the rear of the MP modem.
4. If you are using receive diversity, connect the diversity RF antenna cable to the diversity connector at the rear of the MP modem.
5. If you are using GPS, connect the GPS antenna cable to the SMA connector on the rear of the MP modem.

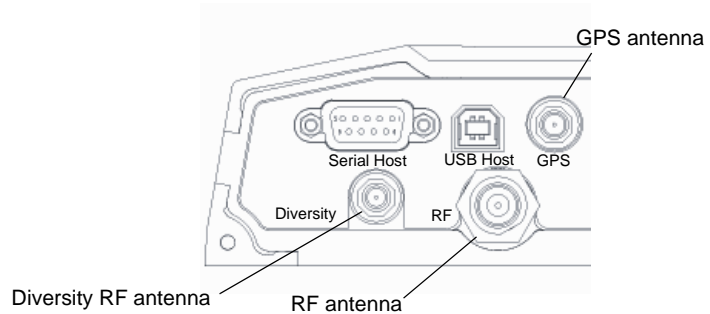

Figure 2-5: The MP 595 modem's SMA connector for the GPS antenna (top), and the TNC connector for the RF antenna (bottom right).

### Step 3—Install the Power Harness

In a typical installation, the MP modem is connected to the vehicle's battery with the power harness. The MP modem supports a voltage range between 9 volts, direct current (VDC) and 36 VDC, and is designed for both 12 VDC and 24 VDC vehicle electrical systems.

---

*Note: Connector part numbers: 39-01-2040 or 39-01-2045. Pins part number: 39-00-0039.*

---

---

*Note: Electrical installations are potentially dangerous and should be performed by personnel thoroughly trained in safe electrical wiring procedures for vehicles.*

---

### Power connector

The power harness connects to the MP modem with a Molex connector.

### Power connector (Molex) pinouts

The pinouts for the Molex connector on the power harness are:

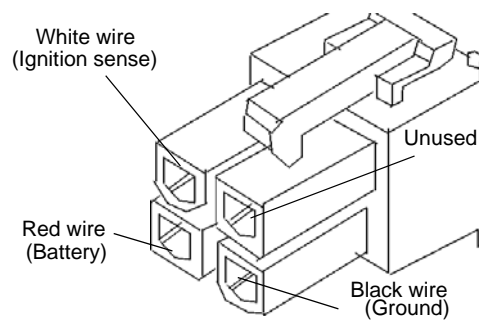

Figure 2-6: Pinouts for the power harness.

The battery (red) and ignition sense (white) wires in the power harness include 5 A fuses. The black ground wire is not fused. (See [“Ground the power harness”](#) on page 31.) Replacement power harnesses are available from Sierra Wireless.

*Note: Do not install an on/off switch on the main (red) battery line, or connect the white ignition sense wire to the red battery wire. Both configurations bypass the MP modem's controlled shutdown sequence, and may cause data loss and subsequent power-on problems. Incorrect wiring may also drain the vehicle battery.*

### Ignition sense on/off wiring

The MP modem's power on/off is controlled by the ignition sense line (white wire) using internal software, rather than a hard on/off switch on the red power line. The red, black, and white wires connect to the battery and ignition switch as shown in the power harness wiring diagram.

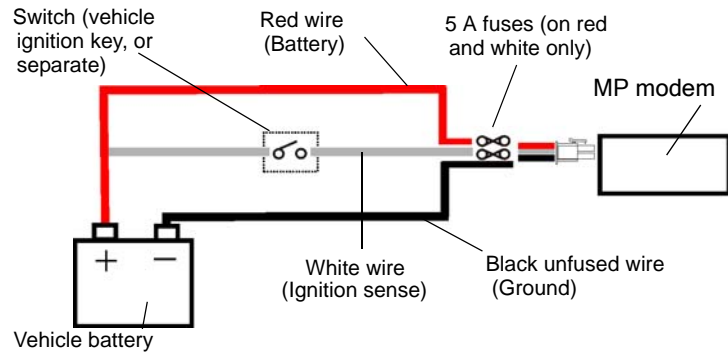

Figure 2-7: Wiring for the power harness. The white wire is the ignition sense.

- When the white ignition sense line is pulled high (5 to 36 V), the MP modem powers on.
- When the ignition sense line is pulled low (less than 2 V), the MP modem performs a controlled shutdown sequence (under software control), de-registering and saving any relevant operational data before powering off.

### Ignition sense options

There are three ways to connect the ignition sense wiring:

- **Engine on only.** Connect the white ignition sense wire to the vehicle's ignition switch so that the MP modem is powered on only when the ignition key is switched to the full "On" position, that is, when the engine has been started. In this configuration, *the engine must be running* for the MP modem to be on.

— or —

- **Accessory on.** Connect the white ignition sense wire to the vehicle's ignition switch so that the MP modem is powered on when the ignition is switched to "Accessory" mode. In this configuration, the MP modem is on *whenever other vehicle electrical devices can be switched on* — such as when the radio and windshield fan can run.

— or —

---

*Note: If you choose to install a separate switch, it must be connected to the white ignition sense wire, not the red battery wire, so that the MP modem can perform a controlled shutdown, as described on [page 30](#).*

---

- **Separately switched.** Connect the white ignition sense wire to a separate switch mounted in a convenient location, which allows the MP modem to be turned on or off regardless of the position of the ignition key. In this configuration, the MP modem can be powered on or off even if the key is not in the ignition.

The MP modem also has a “Power Off Timer”. When power is removed from the ignition sense wire, the MP modem remains on for the period defined by the Power Off Timer, up to a maximum of 240 minutes. The Power Off Timer is configured in 3G Watcher. See the online help in 3G Watcher for details.

### Ground the power harness

You must connect the black ground wire from the power harness to the grounded negative terminal of the vehicle battery, or another appropriate electrical ground. Failing to ground the power harness properly may damage the MP modem, may cause radio interference, and can be dangerous. (See “[Ground the MP modem](#)” on page 26.)

The ground wire in the MP modem power harness is not fused.

### Power connections

Connecting the MP modem’s power wires properly is important—poor connections can damage the wiring, the MP modem, or the vehicle’s electrical system, and can be dangerous.

### Correct wire splicing

You can splice the wires of the power harness to the car wiring. Proper splicing is essential to reliable operation of the MP modem. Do **NOT** use “quick taps”; they reduce the integrity of the wire that is cut and let moisture into the cable.

An appropriate method of splicing is to strip a small portion of the insulation, solder the wires together, then heat-shrink the connection to re-insulate it.

### Crimp terminals

If suitable terminal connection points are available on the vehicle for power and ignition sense, then using automotive crimp terminals is recommended. When using crimp

---

*Note: Ensure that all wires are correctly spliced or crimped. Improper grounding and wire connections may lead to equipment damage or safety hazards.*

---

terminals, do not leave bare wire exposed. Do not use a crimp terminal for more than one wire unless it is designed for that purpose.

## Step 4—Connect MP modem to computer cable to the MP modem

The MP modem connects to:

- A computer through a USB, Ethernet, or serial port.
- Other optional devices through the DB15HD I/O connector.

---

*Note: Do not connect the MP modem to the computer until you have installed the software.*

---

The MP modem connects to a computer using:

- A USB cable (with a Type A connector on the computer end and a Type B connector on the MP modem end). The maximum of the USB cable is 5.5-m (18 feet). These cables are readily available from many suppliers.
- An Ethernet cable with RJ-45 connectors. The type of cable you use affects the performance of the MP modem. The minimum requirement for the Ethernet cable is an unshielded twisted pair (UTP) cable, category 3 or 4. For better performance, use a shielded, category 5 cable. The theoretical maximum length is 100-m (328 feet).

You can connect the MP modem Ethernet port directly to a computer or other Ethernet device with either a cross-over or a straight-through cable.

- A serial cable (with a DB9 connector on the MP modem end). The maximum length of the serial cable is 5.5-m (18 feet). Sierra Wireless sells suitable serial cables in 5-m (16-feet) lengths.

---

*Note: 5-m part number:  
6000083.*

---



**Serial connector (DB9) pinouts**

The MP modem is configured as DCE (Data Communications Equipment) and uses the standard RS232 pin designations:

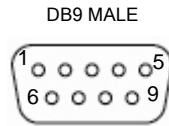

- 1. Data Carrier Detect (DCD)
- 2. Transmitted Data (TxD)\*
- 3. Received Data (RxD)\*
- 4. Data Terminal Ready (DTR)
- 5. Signal Ground (GND)
- 6. Data Set Ready (DSR)
- 7. Clear To Send (CTS)
- 8. Request To Send (RTS)
- 9. Ring Indicator (RI)

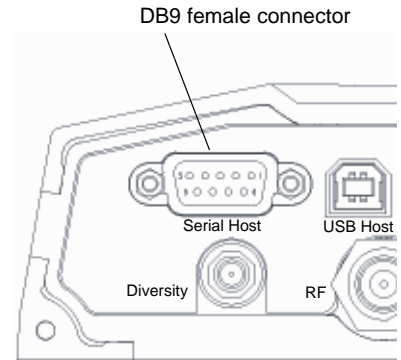

\* RxD and TxD are named with respect to the MP modem (that is, RxD is the Receive Data input to the MP modem, and TxD is the transmit data out of the MP modem)

Figure 2-8: Pinouts for an RS232 male DB9 serial cable (left) that connects to the MP 595 modem's female DB9 serial connector (right). Note that the two figures' pinouts are mirror images of each other, since they plug together.

The serial connector uses these voltage specifications:

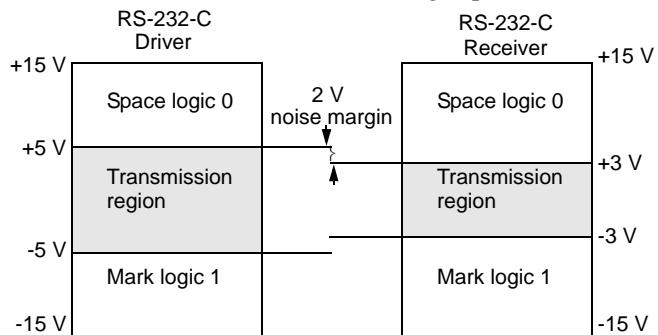

Figure 2-9: Voltage specifications for the MP modem's serial connector.

**Install the USB, Ethernet or serial cable**

To install the USB, Ethernet, or serial cable, thread the cable through the vehicle and attach it to the USB, Ethernet, or serial connector on the MP modem.

*Note: Do not connect the cables to the computer until you have installed the software.*

*Note: Ensure that the MP modem and your computer are powered off while installing cables.*

---

*Note: You must be logged in with administrative privileges to install the software.*

---

### I/O port connections

The MP modem's I/O port is a standard female DB15HD connector for remote monitoring of gauges, sensors, and alarms. If you are planning to use these devices, you need to create a custom I/O cable. See "[Configuring the MP Modem to Report GPS and I/O Data](#)" on page 41.

## Step 5—Install the software

Follow these steps to install 3G Watcher and the MP modem driver:

1. Ensure that the computer has the necessary system requirements. (See "[System requirements](#)" on page 22.)
2. Close any Windows applications that are open on your computer.
3. Insert the MP modem CD in your CD-ROM drive.  
The CD should automatically launch and display a menu. If not, select **Start > Run** from the Windows taskbar and type **d:\setup.exe** (where **d** is the drive letter of your CD-ROM drive).
4. From the CD start-up menu, select **installation and documentation** and then **MP 3G Watcher installation** to launch the Installation Wizard.
5. Use the **Next** and **Back** buttons to navigate through the wizard.
6. Click **Finish** in the final window. To close the CD start-up menu, select the taskbar button to re-display the window, then select **exit** in the lower right corner of the window.
7. Power on the MP modem and connect it to your computer. Windows then completes driver installation.

## Step 6—Activate your account

After you install the 3G Watcher software, you must set up (activate) your account. If you purchased the MP 595 modem directly from a service provider you may already have an account; your MP modem may be pre-activated.

The MP 595 modem allows you to configure two accounts.

### The Activation Wizard

The Activation Wizard guides you through the process of setting up your account.

There are two methods of activation:

---

*Note: If the version of firmware on your MP modem is not current with your version of 3G Watcher, you will be prompted to update your firmware when you launch the program. This update is important to ensure proper operation of your MP modem. The update may take as long as fifteen minutes.*

---

- **Manual activation** involves you phoning your service provider, exchanging information, and entering your account information into the appropriate fields in the wizard.
- **Automated activation** involves the MP 595 modem placing a call to a special number at the service provider. Much of the process is automated.

The wizard varies based on your service provider, and it may be that only one option is available to you.

To start the activation wizard:

1. Start 3G Watcher by choosing **Start > Programs > Sierra Wireless > 3G Watcher > 3G Watcher**, or double click the desktop shortcut.
2. If the wizard does not launch automatically, select **Tools > Activation Wizard...**
3. On the first window, select the manual or automated activation option (if available) and select **Next**.

#### **Manual activation**

The wizard advises you of the information you need to complete the activation, and the phone number you should dial. Follow the instructions in the wizard to complete the process.

#### **Automated activation**

The wizard advises you of the information you need to complete the activation and dials the number. Follow the instructions in the wizard to complete the process.

### **Step 7—Test the system**

Finally, test the system to:

- Confirm that the MP modem can connect to and transmit data over the network.
- Confirm that the MP modem can determine its location (if you have connected a GPS antenna).

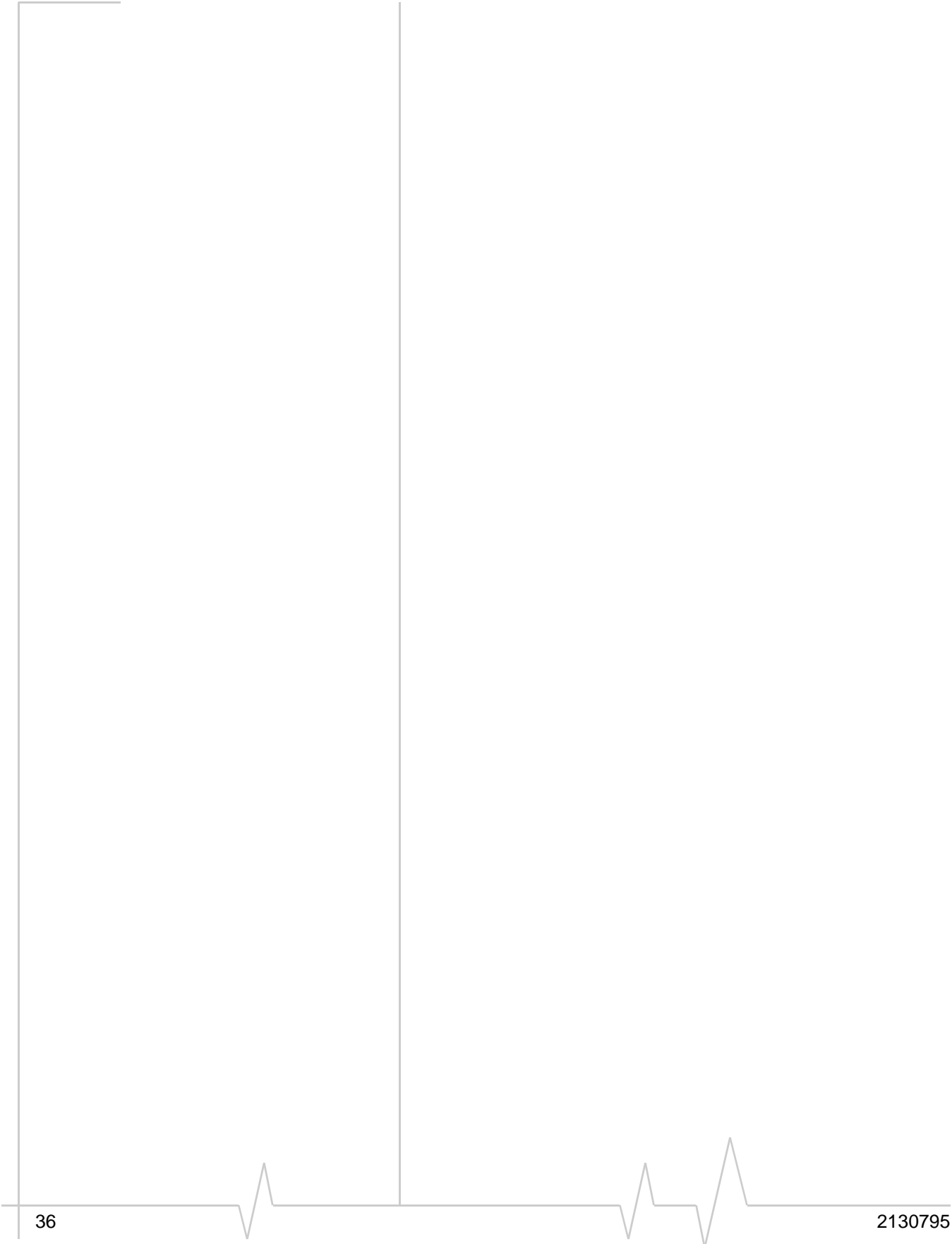

## 3: Operating the MP Modem

- Reading the status indicators
- 3G Watcher software
- Establishing connections

Operating the MP modem requires some knowledge of both the MP modem hardware and the 3G Watcher software. This chapter describes the basics of each.

### Turning the MP modem on and off

The way in which the MP modem is wired determines how it is powered on and off. In most cases the power supply for the MP modem is the vehicle's electrical system and the MP modem is powered on and off in one of these ways:

- **Engine on.** The MP modem is powered only when the ignition is on. (The MP modem is only on when the engine is on.)

— or —

- **Accessory on.** The MP modem is powered when the ignition is switched to "Accessories". (This allows the MP modem to be powered when the engine is off.)

— or —

- **Separately switched.** The MP modem is connected to a separate on/off switch so that it can be turned on and off independently of the engine and vehicle accessories.

Rather than cutting power to the MP modem, the ignition key or power switch allows the MP modem to perform a controlled shutdown sequence that avoids data loss. (You can also set the MP modem to wait up to 240 minutes after the power switch has been turned off before it shuts down.)

## Reading the status indicators

The MP modem's indicator panel includes four indicator lights:

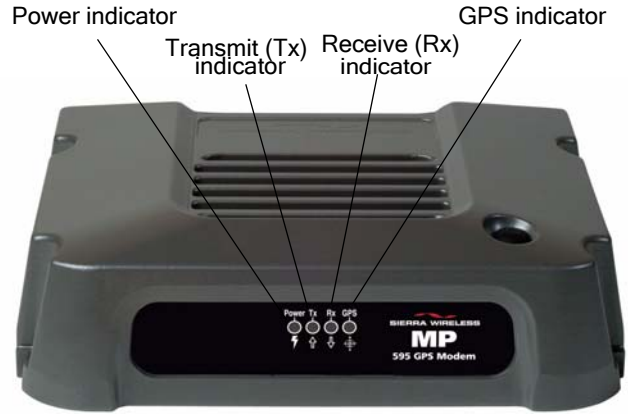

Figure 3-1: The indicator panel of the MP 595 modem.

The following table shows the behavior of the LEDs during normal MP modem operation:

Table 3-1: LED operation

LED	Behavior	Indicates
<b>Power</b>	Off	MP modem is not powered.
	Rapid flashing	MP modem is powered and has not acquired network service.
	Slow flashing (about 1.5 seconds between flashes)	MP modem has acquired IS-95 service.
	On solid	MP modem has acquired 1x, 1xEV-DO Rev. 0, or 1xEV-DO Rev. A service.
<b>Tx</b>	Flashing	MP modem is transmitting data.
<b>Rx</b>	Flashing	MP modem is receiving data.
<b>GPS</b>	Off	GPS module is not active.
	Flashing	GPS module is active but not receiving valid fixes.
	Solid	GPS module is active and providing valid fixes.

## Resetting the MP modem

The reset button for the MP modem is on the top of the housing.



To reset the MP modem, press the button until all four indicator lights illuminate. (Do not use sharp implements that might puncture the rubber.)

Resetting the MP modem is equivalent to turning the MP modem off and on. This terminates any data connection and causes the MP modem to perform a self-test. (Stored settings are not lost.)

Figure 3-2: The MP modem reset button.

## 3G Watcher software

3G Watcher is the program used to manage and monitor the MP modem. For information about installing 3G Watcher, see [“Step 5 – Install the software”](#) on page 34.

3G Watcher allows you to:

- Determine signal strength, roaming status, and other network connection parameters.
- Monitor the status of the MP modem and network services.
- Initiate data connections.
- Set 3G Watcher notification options.
- Configure the I/O ports.
- View GPS information.

## 3G Watcher Help

3G Watcher has a well-indexed and detailed online help system.

To access help in 3G Watcher, select **Help > Help Topics** or press the **<F1>** key.

---

*Note: Depending on the operating mode, it may not be necessary to run 3G Watcher to use the MP modem, but it does provide useful status information.*

---

## Launching 3G Watcher

To launch 3G Watcher:

1. Start 3G Watcher by choosing **Start > Programs > Sierra Wireless Inc > 3G Watcher > 3G Watcher**, or double click the desktop shortcut.



## 3G Watcher window

The main 3G Watcher window includes a number of elements that let you control and monitor your MP modem and your connection to the network.

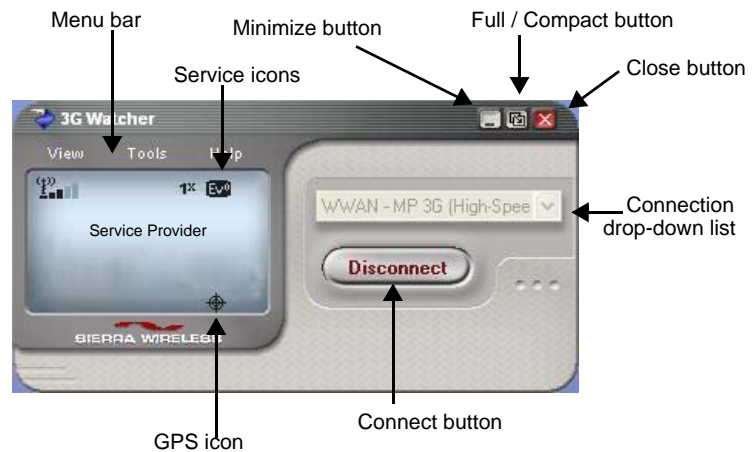

## Establishing connections

The connection drop-down list on the main 3G Watcher window provides a connection option(s) depending on your profile(s):

- **WWAN - Name of your service provider**

Depending on the operating mode and settings in 3G Watcher, a connection may be automatically established when 3G Watcher is launched. Otherwise, you can establish a connection by selecting the connection type and clicking the **Connect** button.



## 4: Configuring the MP Modem to Report GPS and I/O Data

- GPS configuration and reporting
- I/O device installation and configuration

The MP modem is capable of reporting position and heading information using the embedded GPS module, as well as the status of sensors, gauges, and alarms connected to the I/O (Input/Output) port. The MP modem is typically installed in a fleet of vehicles with the GPS and/or I/O data being sent to a central office or dispatch for processing.

This chapter describes how to implement local reporting of GPS and I/O data. [Chapter 5](#) describes how to configure your MP modem to exchange data with your private network.

### GPS configuration and reporting

GPS receivers use an array of orbiting satellites operated by the United States Department of Defense to triangulate their coordinates on the earth's surface. In order to use the GPS module in the MP modem, a GPS antenna must be connected to the MP modem. (The installation requires either two antennas—one RF and one GPS—or a single combination RF/GPS antenna.)

For more information about GPS, see the *Primer on GPS Operations* (document #2130313) on the Sierra Wireless web site, [www.sierrawireless.com](http://www.sierrawireless.com).

---

*Note: The “MP 3G Modems TAIP Reference” (document #2130312) provides a description of the TAIP commands that can be used with the MP modem. This is available at [www.sierrawireless.com](http://www.sierrawireless.com). Information about Trimble GPS modules, including more documentation on TAIP commands, is available at [www.trimble.com](http://www.trimble.com). More information on NMEA message standards is available at [www.nmea.org](http://www.nmea.org).*

---

## GPS protocols and commands

The GPS module supports two methods of reporting navigational information, using either the TAIP (Trimble ASCII Interface Protocol) or NMEA (National Marine Electronics Association) protocols. The GPS module is pre-configured for TAIP. If you are using a GPS application that requires data to be reported according to the NMEA protocol, the MP modem must be reconfigured using an AT command. (See the *MP 3G Modems AT Command Reference*, document #2130810.)

NMEA is a reporting protocol only, while TAIP provides the ability to send commands to the module to query for information and configure reports. When the MP modem is set for TAIP, commands can be sent to the MP modem in these ways:

- Using 3G Watcher.
- Using AT commands.

TAIP commands can be used to:

- Query the MP modem for its current position, heading, and speed.
- Enable and disable automatic reporting of GPS data, and set the interval at which automatic reports are sent.
- Configure the format of reports.

## GPS display in 3G Watcher

To view 3G Watcher’s GPS Display window, which reports latitude, longitude, speed, direction, altitude, and local and UTC time<sup>1</sup>, select **Tools > Display GPS** or double-click the GPS icon on the main 3G Watcher window.

From a cold start (where the MP modem is powered on with no stored navigational data), it may take up to 39 seconds for the GPS module to obtain satellite fixes and begin reporting.

- 
1. UTC replaces Greenwich Mean Time as the basis for standard time throughout the world. UTC, which uses atomic measurements rather than the earth’s rotation, is the equivalent of mean solar time at the prime meridian (0° longitude).

## GPS TAIP quick reference

The following table is a quick summary of the TAIP message identifiers. For detailed information and message syntax, see the *MP 3G Modems TAIP Reference* (document #2130312) and the GPS documentation on TAIP commands available at [www.trimble.com](http://www.trimble.com).

TAIP Message Identifiers	
<b>AL</b>	Altitude/Vertical Velocity
<b>CP</b>	Compact Position Solution
<b>ID</b>	Identification Number
<b>IP</b>	Initial Position
<b>LN</b>	Long Navigation Message
<b>PV</b>	Position/Velocity Solution
<b>RM</b>	Reporting Mode
<b>RT</b>	Reset
<b>ST</b>	Status
<b>TM</b>	Time / Date
<b>VR</b>	Version Number

## I/O device installation and configuration

The I/O port on the MP modem allows for remote monitoring of gauges, sensors, and alarms. You can use this feature to display readings on instruments or gauges and to remotely monitor panic buttons or alarms.

This section describes how to connect and configure these I/O devices to work with the MP modem.

Connecting these devices requires that you make a customized I/O cable. The cable must have, at one end, whatever connector is required by the I/O device, and at the other end, the High Density DB15 connector. The cable wires must pin to the appropriate pin numbers on the I/O connector. The pinouts are described in the next section.

The maximum length of the I/O cable is 15 feet.

Before using the digital input/output lines, you must configure them as inputs or outputs.

## Connector pinouts

The MP modem's I/O port is a female DB15HD connector with eight active I/O pins:

- Two (2) **digital I/O** pins.
- Two (2) **digital input** pins.
- Four (4) **analog input** pins.

There are also six reserved pins and one ground pin.

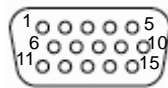

DB15HD male cable

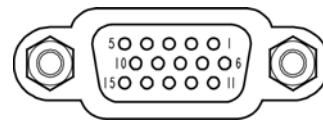

DB15HD female connector  
on rear of MP modem

1. *Reserved—do not connect*
2. *Reserved—do not connect*
3. Digital Input/Output 1
4. Digital input 3
5. *Reserved—do not connect*
6. *Reserved—do not connect*
7. Analog input 2
8. Analog input 4
9. *Reserved—do not connect*
10. Ground (GND)
11. Digital Input/Output 2
12. Digital input 4
13. *Reserved—do not connect*
14. Analog input 1
15. Analog input 3

Figure 4-1: Pinouts for a male DB15HD I/O cable (left) that connects to the MP modem's female DB15HD I/O connector (right). Note that the two figures' pinouts are mirror images of each other, since they plug into one another.

## Port specifications

See "I/O port characteristics" on page 62 for the technical specifications of the I/O ports, including input voltages.

## Digital input devices

Digital input devices are those that have only two states and send a signal to the MP modem in one of those states. An example of a digital input device might be a gun rack alarm that sends a signal to the MP modem any time the gun rack is open. Another example would be a panic button that sends a signal to the MP modem when it is pushed.

---

*Note: No more than 36 VDC should be applied to any I/O pins.*

---

A digital input can be connected to four of the pins on the DB15HD connector: Pins 3, 4, 11, and 12. (Pins 3 and 11 could alternatively be used for digital output.)

---

*Note: Before using the input/output lines, you must configure them as inputs or outputs.*

---

Typically a digital input device should be connected between Ground (Pin 10) and the input port (Pin 3, 4, 11, or 12).

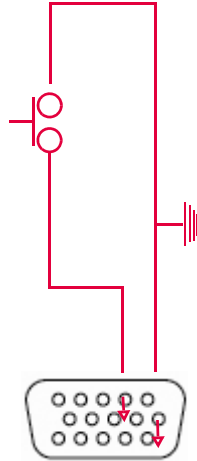

Figure 4-2: A button wired to Pin 4 (digital input) and Pin 10 (Ground).

The pins report a logic high on an input of 3.45 VDC. An internal pull-up resistor provides a high condition when the switch is open.

The digital input pins report a logic low on an input between 0 VDC and 0.8 VDC. Sinking the input pin to ground yields a logic low (0x00) when the port is polled.

If you configure the MP modem to send data to a network server, digital input data can be remotely monitored.

### **Example: panic button connections**

An I/O cable for a panic button requires a wire to one of the digital input or I/O pins (such as #3) and one wire to the Ground pin (#10).

### **Digital output devices**

Digital output devices are those that have only two states and the state is controlled by a signal from the MP modem. Any device that is to be switched on and off from 3G Watcher would be installed as a digital output device.

A digital output can be connected to two of the pins on the DB15HD connector: Pins 3 and 11. (These can be used for either input or output.)

---

*Note: Before using the input/output lines, you must configure them as inputs or outputs.*

---

Typically a digital output device should be connected between Ground (pin 10) and the output port (Pin 3 or 11).

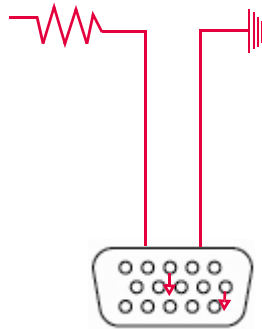

*Figure 4-3: Wiring for using Pin 3 (digital output) as an electronic switch. Pin 10 is Ground.*

The digital I/O ports provide open-collector output to a maximum of 500 mA.

### Analog input devices

Analog input devices are those that generate a signal of varying voltage, based on the state of an instrument or gauge. An example of an analog input device might be a sensor that detects the vehicle's speed.

An analog input can be connected to four of the pins on the DB15HD connector: Pins 7, 8, 14, and 15.

Typically an analog input device should be connected between Ground (pin 10) and the input port (Pin 7, 8, 14, or 15).

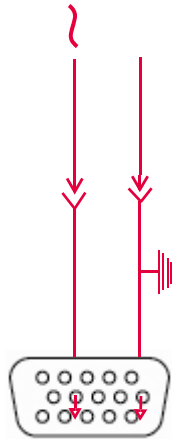

Figure 4-4: A sensor wired to Pin 7 (analog input) and Pin 10 (Ground).

The analog input ports use a 10-bit (1024-step) analog-to-digital converter over a range from 0 to 3.45 VDC, yielding a digital step resolution of 0.0032 V.

#### **Example: analog sensor connections**

An I/O cable for an analog sensor requires a wire to one of the analog input pins (such as #7) and one wire to the Ground pin (#10).

### **I/O configuration using AT or 3G Watcher commands**

Once a sensor, gauge, button, or switch is physically connected to the MP modem, the MP modem must be configured to manage the input from, or output to, the device. This configuration can be done using either AT commands or using 3G Watcher.

For a list of AT commands, please see the *MP 3G Modems AT Command Reference* (document #2130810).

There are separate windows in 3G Watcher for configuring the analog and digital ports.

### Analog input setup

The Analog Input window (**Tools > Options > MP > Input/Output**) is used to configure devices on the four analog inputs. Each tab corresponds to a pin:

Analog Tab	Connector Pin
Input 1	14
Input 2	7
Input 3	15
Input 4	8

To configure an analog sensor or gauge, select the tab that corresponds to the pin you are using and complete the fields as follows:

- **Label:** Enter a description of the sensor or gauge (Measured Voltage, Vehicle Speed, etc.), up to 20 characters long.
- **Raw value:** Shows the analog value from the input (read-only). The analog input has a 10-bit (1024-step) resolution, so the raw value range is between 0 and 1023.
- **Zero scale:** Enter the minimum value for the units you are reporting (used to convert the raw analog value of zero).
- **Full scale:** Enter the maximum value for the units you are reporting (used to convert the raw value of 1023).
- **Current value:** Shows the resulting converted value using the zero and full scales entered.
- **Unit:** Specify the units of the input (volts, km/h, etc.), up to 20 characters long.

#### Example

If you are measuring temperature, and the thermometer you have connected to the I/O connector measures between -30 (raw value 0) and +50 (raw value 1023) degrees Celsius, then your zero scale is -30.0 and your full scale is 50.0. Your label could be "Temperature", and units, "degrees C".

The measurements are calculated for the 80-degree range (between -30 and +50), which is divided into 1024 steps (0.0781 degrees per unit step). A reading of 25 degrees (55 degrees above the minimum) would therefore show a raw value of 704 (55 degrees/0.0781 degrees per unit).



### Digital I/O setup

The Digital Input/Output window (**Tools > Options > MP > Input/Output > Digital I/O**) is used to configure devices on the two digital I/O and two digital input ports. Each tab corresponds to a pin:

Digital Tab	Connector Pin
I/O 1	Input or output on pin 3
I/O 2	Input or output on pin 11
Input 3	Input on pin 4
Input 4	Input on pin 12

To configure a digital sensor or gauge, select the tab that corresponds to the pin you are using and complete the fields as follows:

- **Label:** Provide a description of the sensor or gauge, up to 20 characters in length.
- **Type:** Select Input, Output, or Not used. (Output is not available on tabs 3 and 4.)
- **Logic low name:** Describe the state of the device at logic level low, up to 20 characters in length. (For example, if a switch in the off position leads to a logic low, you could choose to label it Switched Off.)
- **Logic high name:** Describe the state of the device at logic level high, up to 20 characters in length (such as Switched On).
- **Alarm logic level:** Assign an action associated with the I/O port:
  - **high:** A notification is sent, and the event is logged, if the state changes from a logic low to a logic high.
  - **low:** A notification is sent, and the event is logged, if the state changes from a logic high to a logic low.
  - **log only:** No notification is sent, but any change in logic level is logged.

The name and location of the log file is specified in the Input/Output window (**Tools > Options > MP > Input/Output**). By default, the log file is located in the program folder or user folder and is called *MpIoLog.txt*.

- **Current value:** Shows the current value of the port.

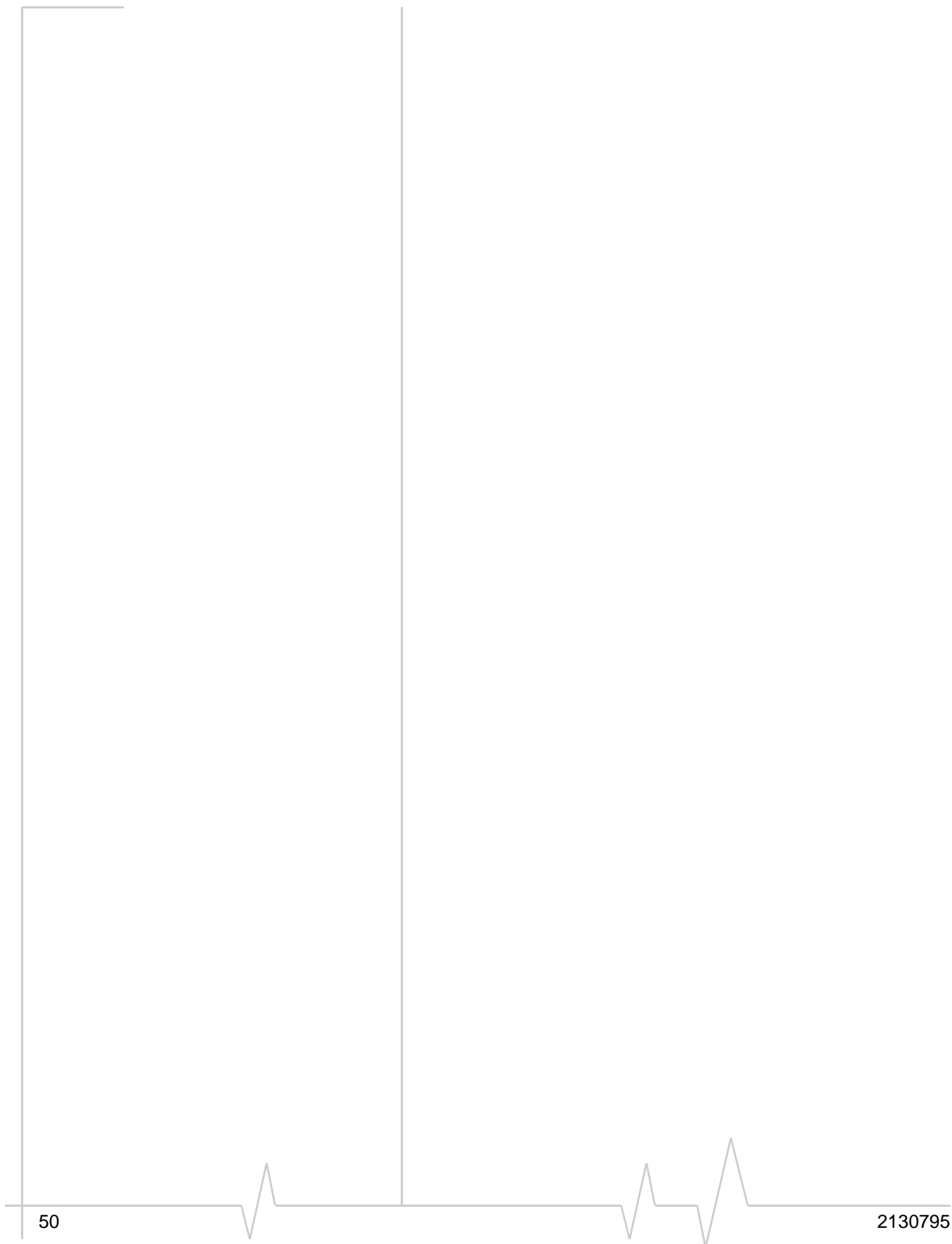

## 5: Sending Data to Your Network Application

- Configuring the MP modem to route data to a server
- Retrieving the Unique Mobile Device ID

---

*Note: For a full list of AT commands and their parameters, see the MP 3G Modems AT Command Reference, document #2130810*

---

---

*Note: You must configure alarm triggers locally on the MP modem using either 3G Watcher or an AT command.*

---

This chapter discusses how to configure the MP modem to send GPS and I/O data to a network server. This is a simple process, but if there are any firewalls on your or your service provider's network, the data must be routed through or around the firewall. A general discussion of some methods of dealing with firewalls is provided.

This chapter also explains how to retrieve the Unique Mobile Device ID from the MP modem. This is the number that uniquely identifies each MP modem. Any application that uses the GPS and I/O data from the MP modem requires this number.

### Configuring the MP modem to route data to a server

The protocol that defines how MP modem data is packaged is called MTP (Monitoring and Tracking Protocol). You can configure MTP in 3G Watcher by selecting **Tools > Options > MP > Monitor and Tracking**, or by using the AT command **ATIMPMTCONF** and the appropriate parameters.

The MP modem provides four independent reporting engines, allowing data to be sent to four different destinations. You can specify the destination IP address and port number for each engine. This allows, for example, GPS data to be sent to one host application, and I/O data to be sent to another.

You can also specify the values for the timers that determine the frequency with which the data is to be sent.

### Report frequency timers

The low rate timer, alert rate timer, and GPS timer control the interval between reports from the MP modem.

The low rate timer sets the interval at which reports are sent in the absence of any other trigger or timer. It is in minutes with a default of five minutes.

The fast rate timer only becomes active when an alarm condition is triggered by a rise or drop in the level of one of the digital I/O channels. The default for the fast rate timer is three seconds.

---

*Note: When the fast rate timer is set to 0, a single report is sent when an I/O alarm is triggered.*

---

If the GPS timer is set to a value other than 0, it controls the frequency of reports in the absence of any alarm or event triggers. (However, if the GPS timer is set to a longer interval than the low rate timer, the value for the low rate timer will determine report frequency.)

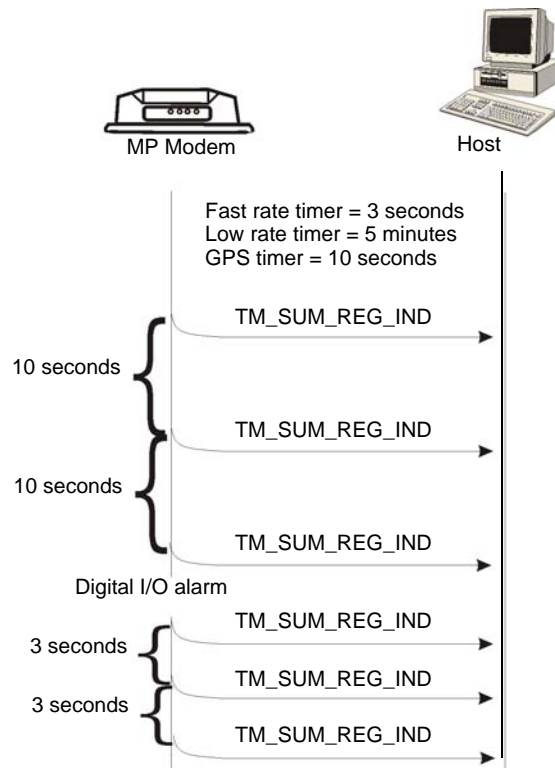

Note: The "MP 3G Modems TAIP Reference" (document #2130312) provides a description of the TAIP commands you can use. This is available at [www.sierrawireless.com](http://www.sierrawireless.com). Information about GPS modules, including more documentation on TAIP commands, is available at [www.trimble.com](http://www.trimble.com).

If the GPS timer is set to 0, the reporting interval is determined by the configuration of the GPS module. If the module is configured for TAIP, you can issue TAIP commands to change the interval. An advantage of configuring the report frequency with TAIP commands is that the interval between reports can be based on elapsed time and/or distance travelled.

You can issue TAIP commands to the module locally through 3G Watcher using the AT command **AT!MPGPSCMD**. They can also be sent remotely using MP Modem Manager. (See "MP Modem Manager" on page 18.)

Reporting configurations set by sending TAIP commands will be erased if the MP modem is powered off unless the commands are included in the initialization strings for the MP modem. These are executed each time the MP modem is powered on. You can configure them locally by using 3G Watcher (**Tools > Options > GPS**) or the AT command **AT!MPGPSINIT**, or remotely with MP Modem Manager.

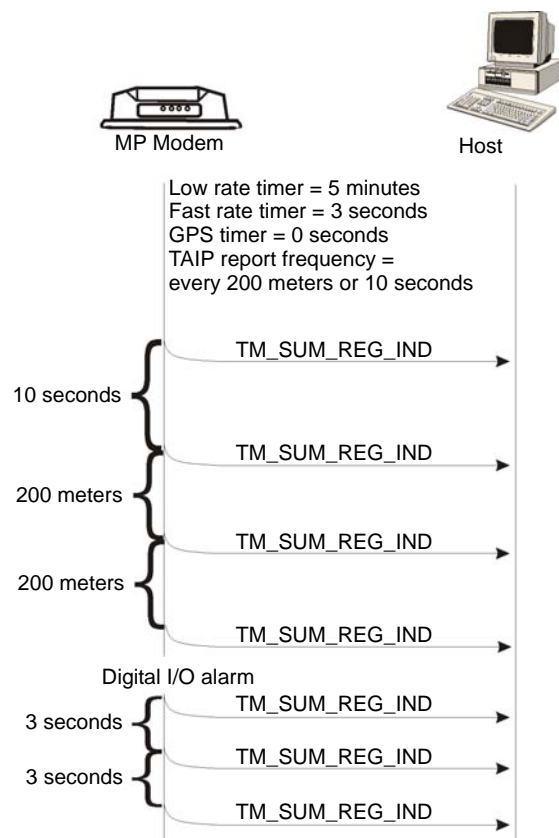

*Note: More information on NMEA message standards is available at [www.nmea.org](http://www.nmea.org).*

If the module is configured for NMEA, data is sent at five-second intervals. (The interval cannot be changed when the module is configured for NMEA because NMEA is strictly a reporting protocol.)

## Monitoring and Tracking configuration

You can use 3G Watcher to configure the MP modem to send MTP data to a network server:

1. Select **Tools > Options > MP > Monitor and Tracking** and complete the appropriate fields.  
— or —
1. Issue the AT command **ATIMPMTCONF** along with the required parameters.

## IP Addressing

To send data to the MP modem, a host application on a network server requires the IP address of the MP modem. Service providers usually do not provide a static IP address to each device on the network. The IP address is dynamically assigned each time the MP modem registers on the network. This means that the host application must identify each MP modem by its Unique Mobile Device ID (discussed on [page 56](#)) and capture its IP address as it registers.

If the MP modem has a public IP address, the host application can simply check the IP address on the incoming data packets to determine the IP address of the MP modem. However, if NAT (Network Address Translation) is in use, the IP address assigned to the MP modem is likely to be a private IP address. This may present problems, as discussed in the next section.

## The problem created by Network Address Translation

*Note: A similar problem may occur if NAT is in use on your network. The host application may reside on a server that has a private IP address. You must configure the MP modem to send data to a server on your network with a public IP address, and configure the server to recognize the MTP data and route it appropriately.*

Many service providers use NAT (Network Address Translation) which effectively creates a firewall in front of the network. Inside the network, the service providers assign private IP addresses to registered devices, since public IP addresses are not needed to route data within the network. (This saves the service provider the expense of having a large pool of public IP addresses.) A public IP address is substituted for the private IP address when data packets pass through the gateway between the network and the Internet. This public IP address might be used on data transmissions from many different devices. Therefore, the network server is only aware of the substituted public IP address. If the server replies to this address, the network cannot identify the device for which the data was intended.

Assume, for example, an MP modem is registered on a network. The MP modem is assigned a private IP address of 10.95.236.1. When the MP modem sends MTP data to the network server, a public IP address of 24.7.6.30 is substituted at the gateway to the Internet. When the network server receives the data, the host application is only aware of the public IP address, 24.7.6.30. However, if the network server sends data back to the IP address 24.7.6.30, the network has no way of identifying the MP modem for which it is intended and is unable to route the data appropriately.

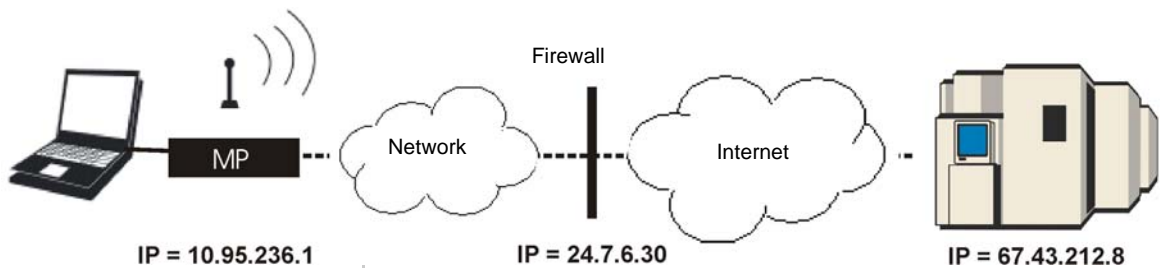

*Figure 5-1: An MP modem connected to a network server. In this scenario, the IP address is "NAT'd" from 10.95.236.1 to 24.7.6.30. The network server is only aware of the address 24.7.6.30, but if it sends data to that address the network cannot route the data to the MP modem.*

*Note: NetMotion Wireless, Inc. develops client-server applications that attempt to overcome the issues caused by NAT addressing by assigning its own consistent private IP addresses. This software offers a potential solution to NAT issues, but it is untested by Sierra Wireless, and Sierra Wireless does not provide support for it.*

### Solutions to the NAT problem

If your service provider is using NAT, it is best to work with the provider in devising a solution. Some service providers offer, on request, accounts with public IP addresses. (There may be additional charges for this.)

Another solution is to implement a frame relay connection between your network and your service provider's network. The frame relay connection bypasses the address translation, and is a method of overcoming NAT issues encouraged by some service providers.

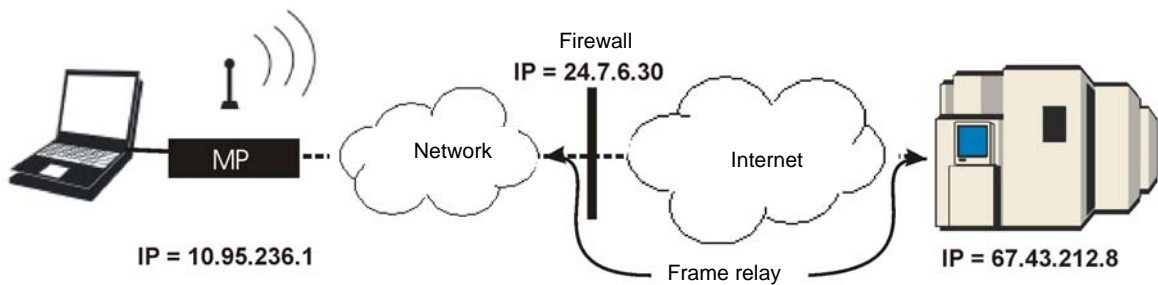

### Retrieving the Unique Mobile Device ID

In order to associate GPS and I/O data with a particular vehicle, you must create a database on your server that links each MP modem's Unique Mobile Device ID to the vehicle in which it is installed. The Unique Mobile Device ID is a number derived from the ESN (Electronic Serial Number).

Use the AT command **ATI4** to obtain the Unique Mobile Device ID from each MP modem you deploy.

You may also want to assign a device name to the MP modem that identifies the vehicle in which it is installed. You can assign this name locally using 3G Watcher or remotely using MP Modem Manager. The device name is included in the MTP data sent to the network server.

*Note: See "MP Modem Manager" on page 18.*



## »» | 6: Support and Warranty

- Technical support
- Warranty

### Technical support

To obtain technical support for your MP modem, and firmware and software upgrades, please contact your account manager.

Online technical support resources are also available at [www.sierrawireless.com](http://www.sierrawireless.com).

### Warranty

Sierra Wireless, Inc. warrants the MP modem against all defects in materials and workmanship for a period of three (3) years from the date of purchase.

The sole responsibility of Sierra Wireless, Inc. under this warranty is limited to either repair or, at the option of Sierra Wireless, Inc., replacement of the MP modem. There are no expressed or implied warranties, including those of fitness for a particular purpose or merchantability, which extend beyond the face hereof.

Sierra Wireless, Inc. is not liable for any incidental or consequential damages arising from the use, misuse, or installation of the MP modem.

This warranty does not apply if the serial number label has been removed, or if the MP modem has been subjected to physical abuse, improper installation, or unauthorized modification.



# 7: Technical Specifications

This chapter provides technical data for the MP 595 modem.

*Note: The technical specifications are subject to change without notice.*

## Regulatory, radio frequency and electrical specifications

Approvals	FCC Industry Canada EU RoHS
Network compliance	CDMA 1xEV-DO Revision A (IS-856-A) CDMA 1xEV-DO Revision 0 (IS-856) CDMA 1X (IS-2000) CDMA IS-95A
Voltage range	9–36 VDC
Reverse polarity protection	Compliant
Current draw	Max transmit (23 dBm output) <sup>a</sup> Cellular: 375 mA PCS: 395 mA Typical transmit: 250 mA average Receive: 215 mA Idle (Ignition Sense off): 2 mA
Maximum output power	23 dBm (200 mW)
Transmit	PCS: 1850 to 1910 MHz Cellular: 824 to 849 MHz
Receive	PCS: 1930 to 1990 MHz Cellular: 869 to 894 MHz

a. This applies to a typical installation with a well-matched antenna. All current values are measured with an input voltage of 12 V.

## Environmental specifications

Operating temperature	-30°C to +70°C (-22°F to +158°F)
Storage temperature	-40°C to +85°C (-40°F to +185°F)
Humidity	95% RH non-condensing MIL 202G, Sections 103B and 106G
Rain / splash	MIL 810F, Section 506.4, Procedure III SAE J1455, Section 4.4
Drop	MIL 810F, Section 516.5 SAE J1455, Section 4.10.3.1
Shock	MIL 202G, Section 213B MIL 810F, Section 516.5 SAE J1455, Sections 4.10.3.2 and 4.10.3.4
Vibration	MIL 202G, Section 214 MIL 810F, Section 514.5 SAE J1455, Section 4.9
Sand / dust bombardment	MIL 810F, Section 510.4, Procedures I-III
Salt fog	MIL 810F, Section 509.4
ESD	Operational $\pm$ 6 kV contact, as per IEC 61000-4-2
EU RoHS	Compliant

## Weight and dimensions

Weight	0.9 kg (2 lbs)
Height	49 mm (1.93 in)
Width	138 mm (5.43 in)
Length	176 mm (6.93 in)
Case material	Metal
Case surface	Scratch-resistant powder coat paint

## Host interfaces

Serial	One — DB9 female
USB	One — USB Type B, USB 1.1/2.0 compliant
Ethernet	One — RJ45 female

## Other interfaces

Input / output	One — High-density DB15 female
Network antenna	One — TNC female
Receive diversity antenna	One — SMA female
GPS antenna	One — SMA female
Reset	One — Manual reset button
Power	One — Molex 39-01-0029 female

## GPS specifications

Satellite channels	12 channel, continuous tracking
Protocols	TSIP, TAIP, NMEA 0183 V3.0
Acquisition times	Re-acquisition: 2 sec. Hot start: 9 sec. Warm start: 35 sec. Cold start: 39 sec.
Accuracy	Horizontal: < 3-m (50%), < 8-m (90%) Altitude: < 10-m (50%), < 16-m (90%) Velocity: 0.06 m/sec
Sensitivity	Tracking: -152 dBm Acquisition: -142 dBm
Operational limits	Velocity: 515 m/sec.

## I/O port characteristics

Absolute maximum voltage	-0.3 VDC to 36 VDC
Digital I/O count	Total: 4; two dedicated inputs, two configurable input/outputs
Digital inputs	Open collector, max current 500 mA Vih, min 2 VDC Vil, max 0.8 VDC Vih, max 36 VDC
Digital outputs	Open collector
Analog input count	Total: 4
Analog input	Zero-scale: 0 VDC Full-scale: 3.3 VDC Leakage current: 66 $\mu$ A

## 3G Watcher software

Operating systems: laptops	Microsoft® Windows® Vista™, 2000, and XP
Language	English, French

## 8: Regulatory Information

- Canada
- U.S.A.

---

*Note: Unauthorized modifications or changes not expressly approved by Sierra Wireless, Inc. could void compliance with regulatory rules, and thereby your authority to use this equipment.*

---

### Canada

To ensure that the MP modem meets Health Canada's Safety Code 6 requirements, a separation distance of at least 20 cm (8 inches) must be maintained between the modem's CDMA antenna and the body of the user and any nearby persons at all times and in all applications and uses. Additionally, the maximum antenna gain in the PCS band, including cable loss, must not exceed 4.15 dBi, and in the Cellular band, must not exceed 5.1 dBi, to comply with Industry Canada and Health Canada regulations limiting both maximum RF output power and human exposure to RF radiation.

### U.S.A.

To comply with FCC regulations limiting both maximum RF output power and human exposure to RF radiation, the maximum antenna gain, including cable loss, in the PCS band, must not exceed 4.15 dBi, and in the Cellular band, must not exceed 5.1 dBi.

The CDMA antenna must be mounted such that there is a separation distance of at least 20 cm (8 inches) between the CDMA antenna and the body of the user or any nearby persons.

---

*Note: This equipment has been tested and found to comply with the limits for a Class A digital device, pursuant to Part 15 of the FCC Rules. These limits are designed to provide reasonable protection against harmful interference when the equipment is operated in a commercial environment. This equipment generates, uses, and can radiate radio frequency energy and, if not installed and used in accordance with the instruction manual, may cause harmful interference to radio communications. Operation of this equipment in a residential area is likely to cause harmful interference in which case the user will be required to correct the interference at his own expense.*

---





# >> Index

## Numerics

1X, 15  
1x-EVDO Rev. 0, 15  
1x-EVDO Rev. A, 14  
3G Watcher, 39–40

## A

account, 34  
    activation, 34  
activation, 34  
alert rate timer, 51  
analog input  
    configuration, 48  
    wiring, 46  
analog sensor, 47  
antenna, 26  
antenna connector, 23  
approvals, 59  
AT commands  
    I/O configuration, 47  
    MTP configuration, 51  
    unique mobile device ID, 56  
audio connector, 23

## C

CDMA, 14  
connectors, 23  
current, 59

## D

DB15HD  
    connector, 23  
DB9  
    connector, 23  
    pinouts, 33  
DB9. *See* serial  
device name, 56  
dial-up connections, 15  
digital input  
    configuration, 49  
    wiring, 44  
digital output  
    configuration, 49  
    wiring, 45  
dimensions, 60  
documentation, 18

## E

electrostatic discharge (ESD), 60

## F

firewall, 55  
frequencies  
    receive, 59  
    transmit, 59  
frequency bands, 16, 59

## G

gauges. *See* I/O devices  
GPS  
    antenna, 27  
    configuration and reporting, 41–43  
    connector, 23  
    performance, 61  
GPS timer, 51  
grounding, 26, 31

## H

headset  
    connector, 23  
height, 60  
Host interfaces, 61  
humidity, 60

## I

I/O  
    cable, 34  
    connector, 23  
I/O devices, 43–49  
    alarm, 52  
    analog, 46  
    digital, 44  
I/O port characteristics, 62  
ignition options, 37  
ignition wiring, 29, 30  
inputs. *See* I/O devices  
interfaces, 61  
IS-95, 15

## L

LEDs, 38  
low rate timer, 51

## M

manuals, 18  
mounting, 24–26  
mounting (the modem), 24  
MTP  
    configuring, 51  
    report frequency, 51

## N

NAT, 55  
NMEA, 42

## O

on/off switch, 30  
output power, 59  
outputs. *See* I/O devices

## P

panic button, 45  
pinouts (on I/O connector), 44  
power connector, 23, 29  
power harness, 29, 31  
power on options, 37  
power supply, 22  
power wiring, 28  
private IP address, 55  
public IP address, 55

## R

receive diversity, 16  
receive frequencies, 59  
regulatory information, 63  
report frequency, 51  
reporting engines, 51  
reset button, 38, 39  
roaming, 16

## S

sensors. *See* I/O devices  
serial  
    versus USB, 16

serial cable  
    maximum length, 21  
serial connector, 23  
shock, 60  
SIM  
    insertion, 35  
SMA connector, 23  
specifications, 59–62  
status indicators, 38

## T

TAIP  
    reporting protocol, 42  
technical specifications, 59–62  
temperature  
    operating, 60  
    storage, 60  
timers  
    report frequency, 51  
TNC connector, 23  
transmit frequencies, 59

## U

unique mobile device ID, 56  
USB  
    versus serial connection, 16  
USB cable  
    maximum length, 21  
USB connector, 23

## V

vibration, 60  
virtual serial port, 16  
voltage, 44  
voltage range, 59  
voltage specifications (serial cable), 33  
VPN support, 17

## W

warranty, 57  
Watcher, 39–40  
weight, 60  
width, 60  
wire splicing, 31





## Free Manuals Download Website

<http://myh66.com>

<http://usermanuals.us>

<http://www.somanuals.com>

<http://www.4manuals.cc>

<http://www.manual-lib.com>

<http://www.404manual.com>

<http://www.luxmanual.com>

<http://aubethermostatmanual.com>

Golf course search by state

<http://golfingnear.com>

Email search by domain

<http://emailbydomain.com>

Auto manuals search

<http://auto.somanuals.com>

TV manuals search

<http://tv.somanuals.com>