

# **SINGER**

## **11W8**

Registered in U. S. A.

394 RIVER STREET  
TROY, N. Y.  
594 RIVER STREET  
TROY, N. Y.

# SINGER

## 11w8



**THE SINGER MANUFACTURING COMPANY**

394 RIVER STREET  
TROY, N. Y.

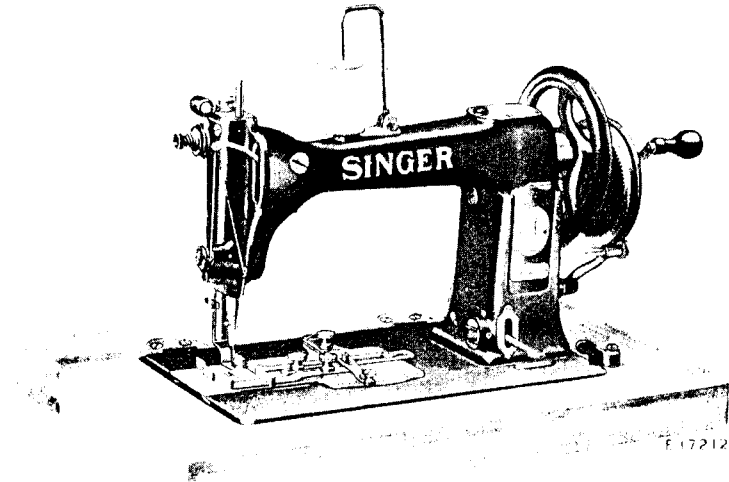

Copyright, U. S. A., 1945

by The Singer Manufacturing Co.

All Rights Reserved for all Countries

14084 - 1/3

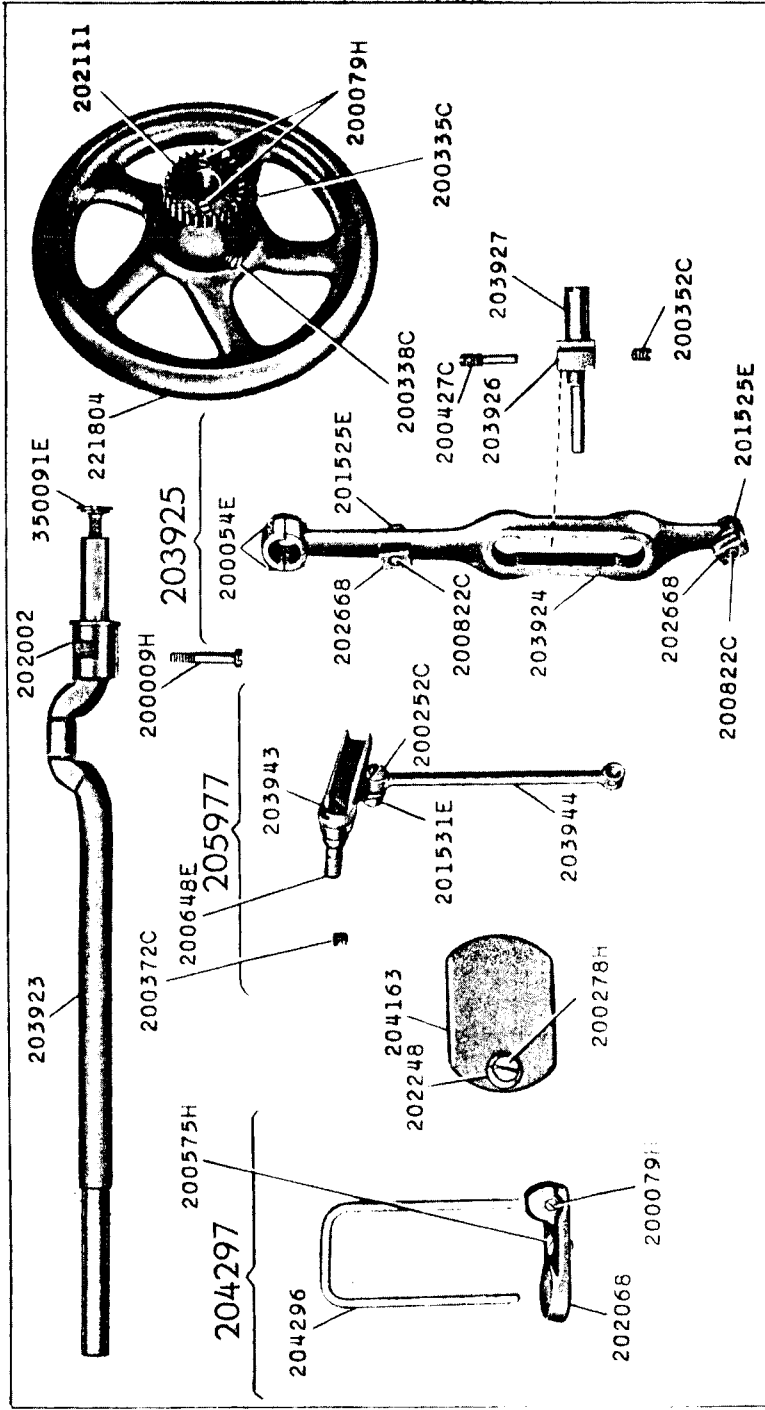

14085 - 1/2

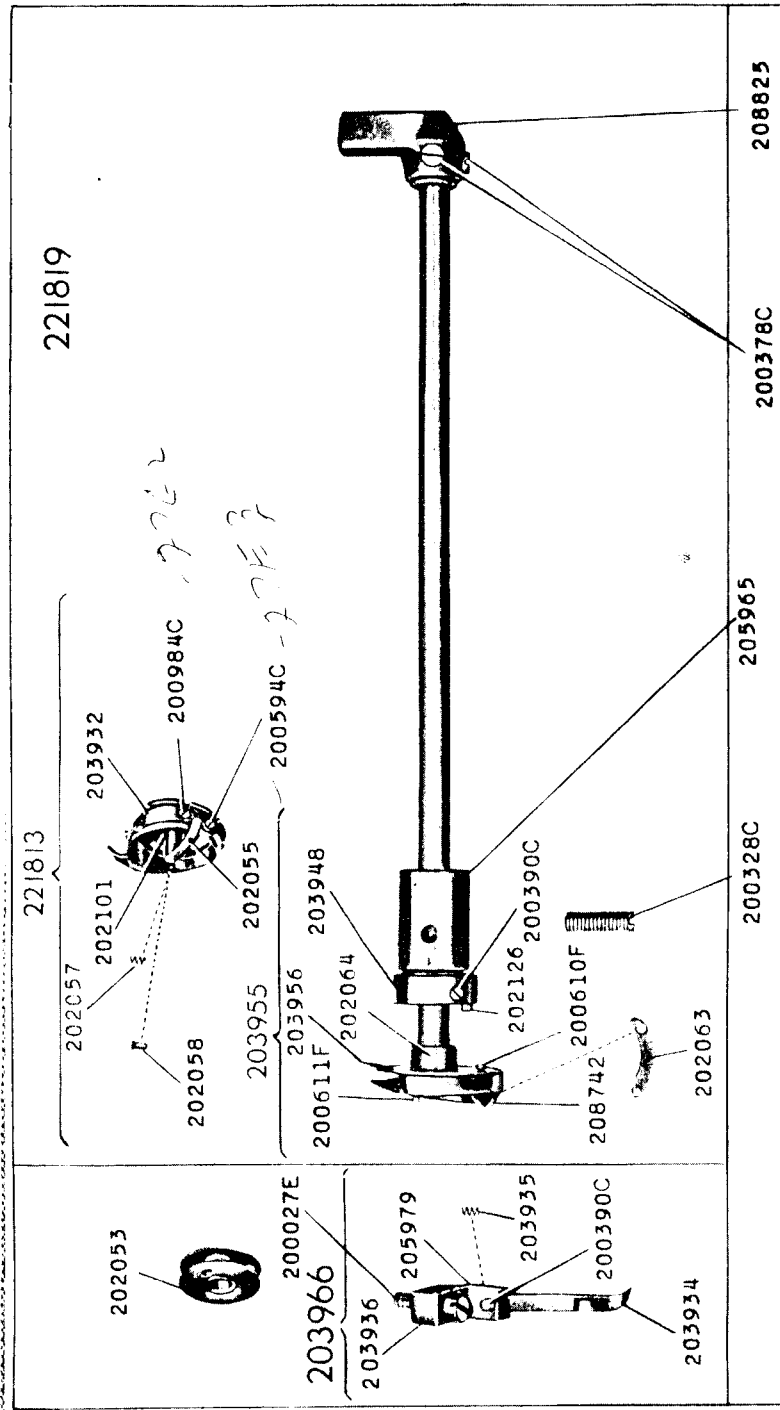



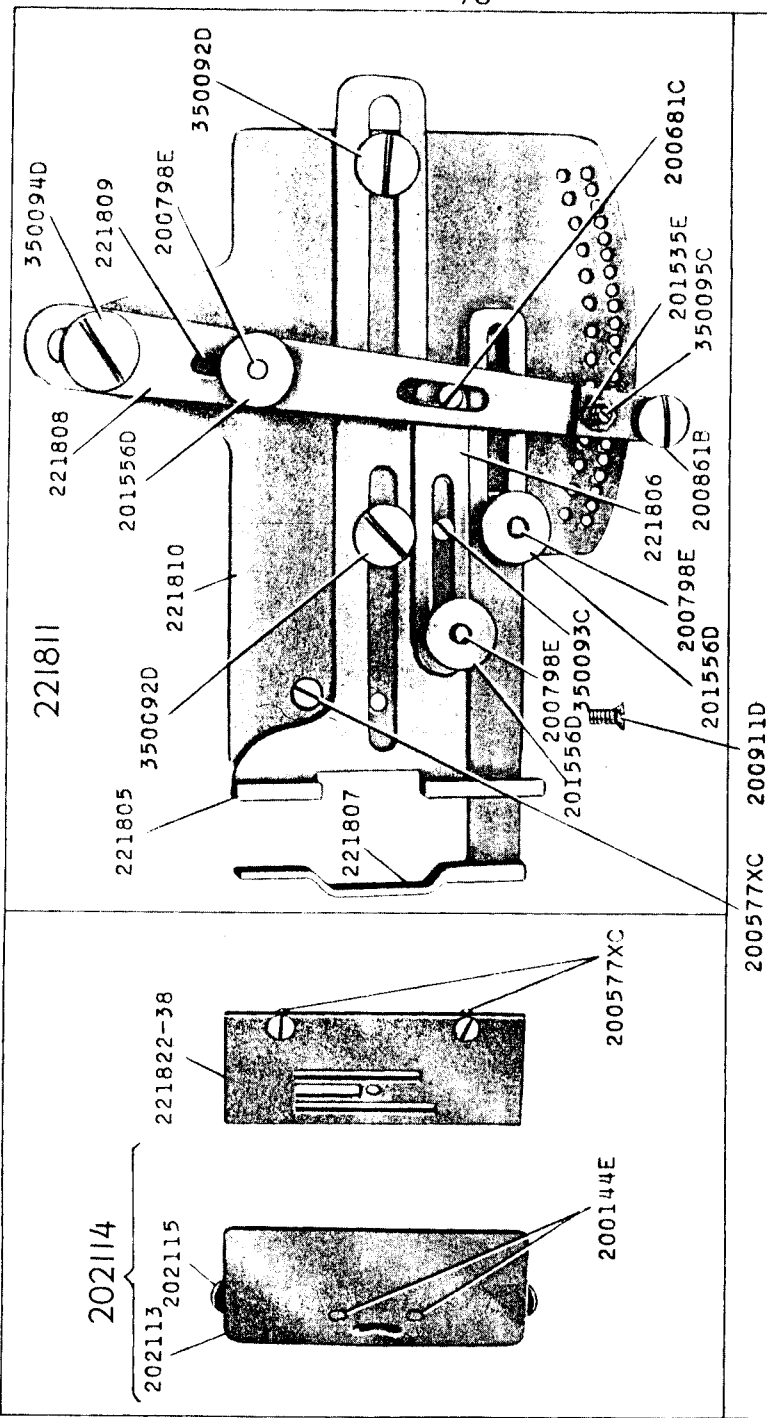
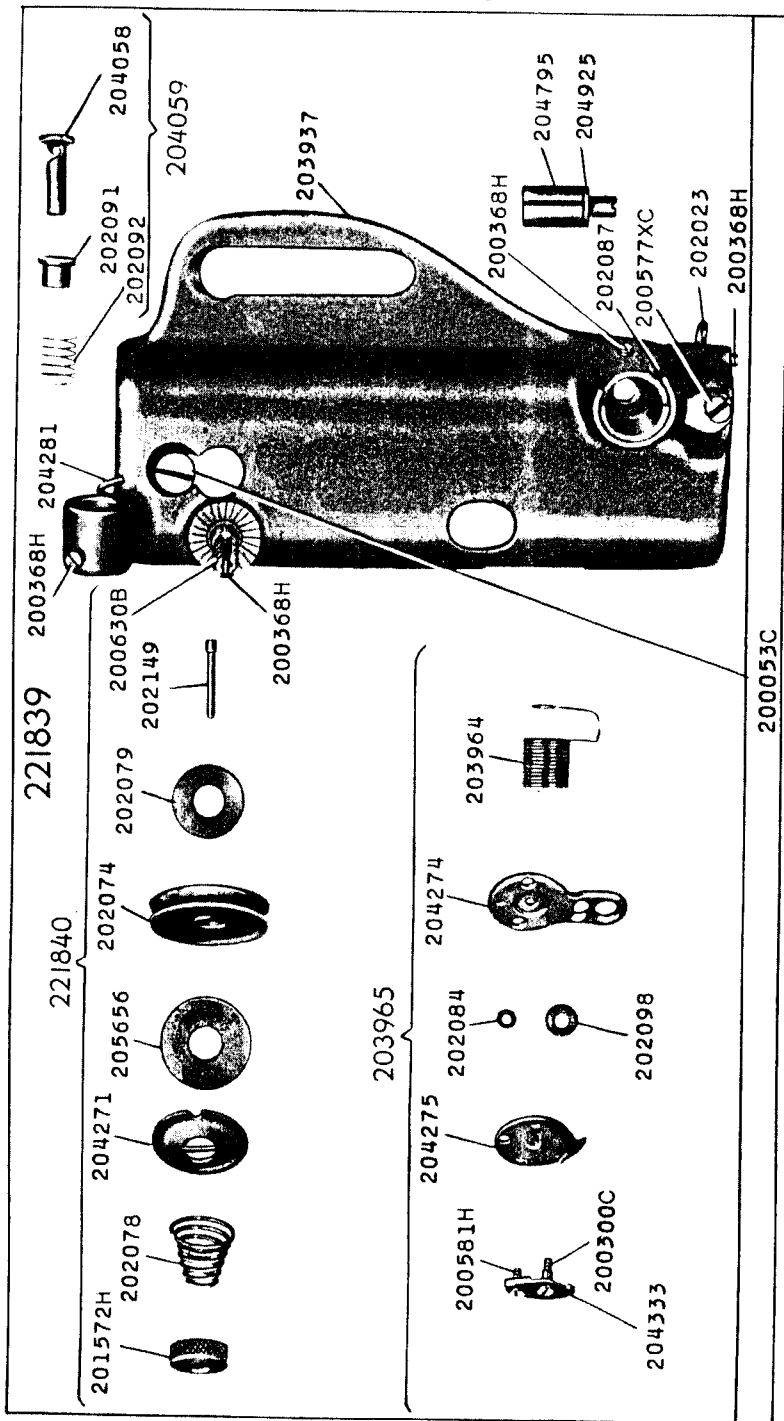

14090 - 1/2

205949

202130

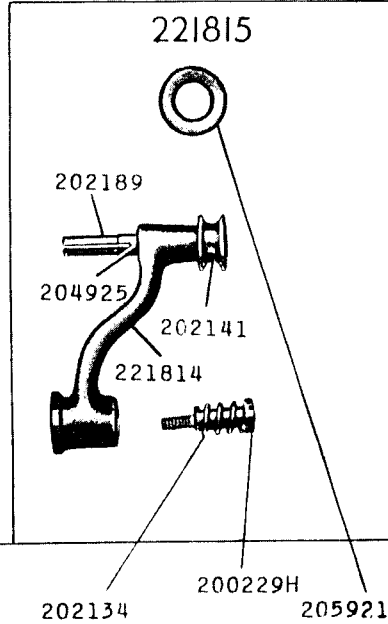
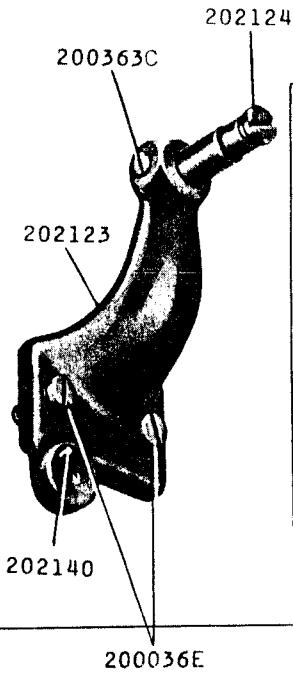
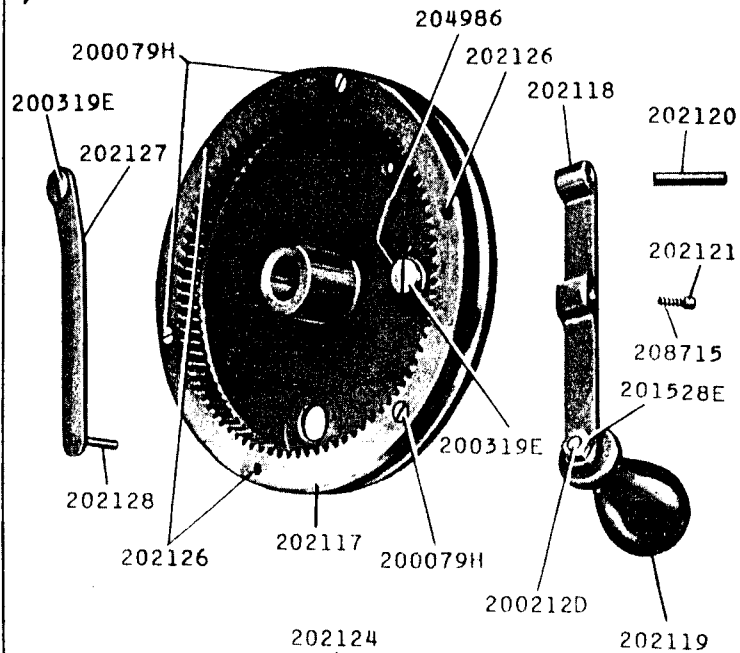

14091 - 1/2

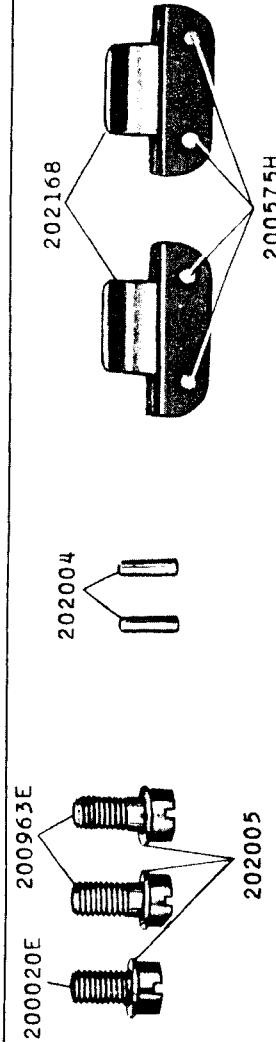
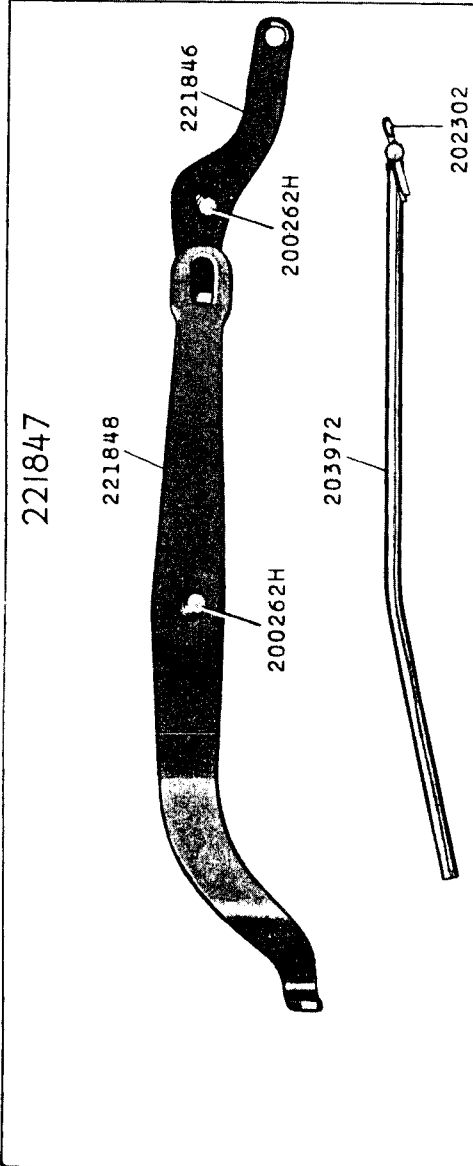
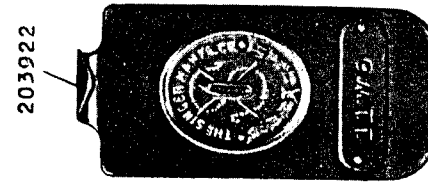

14092 - 3/8

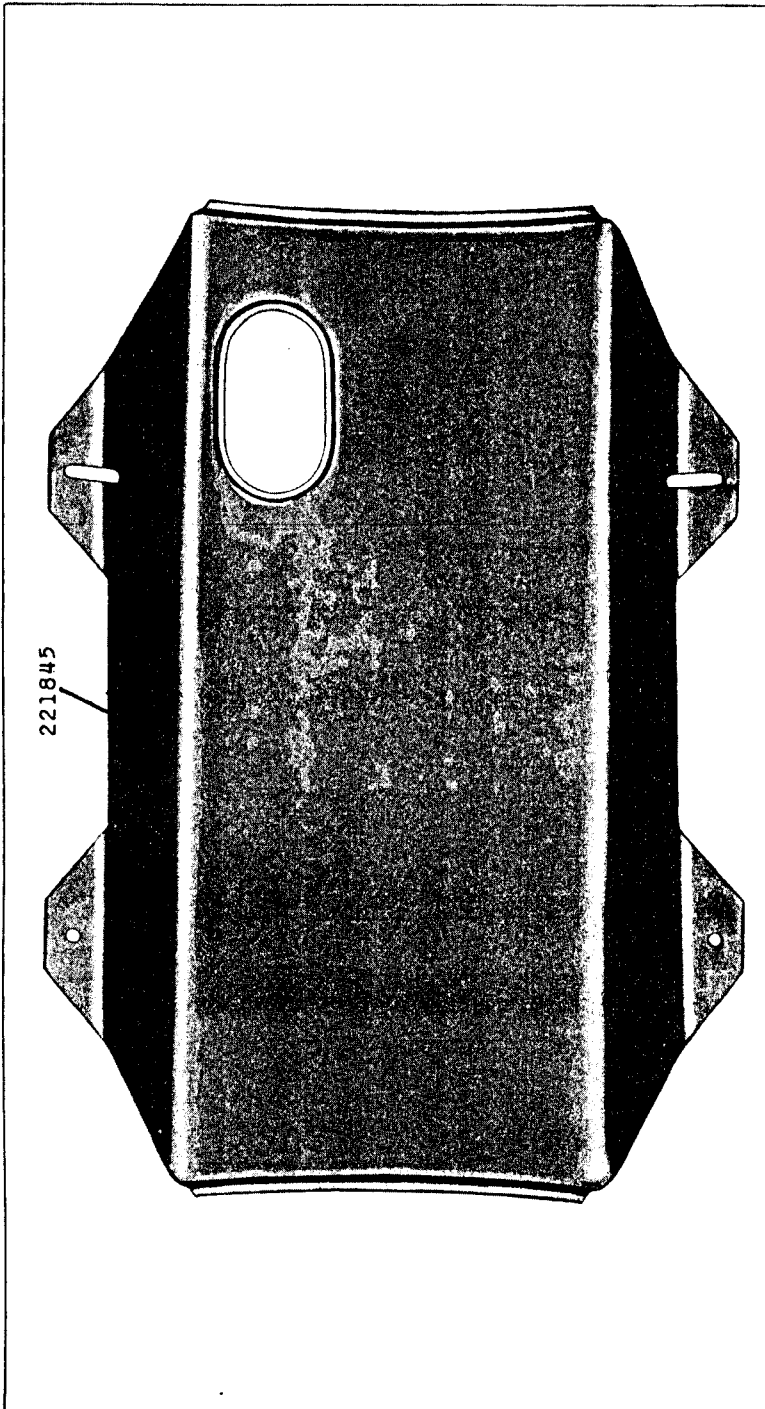

14095 - 3/8

221899

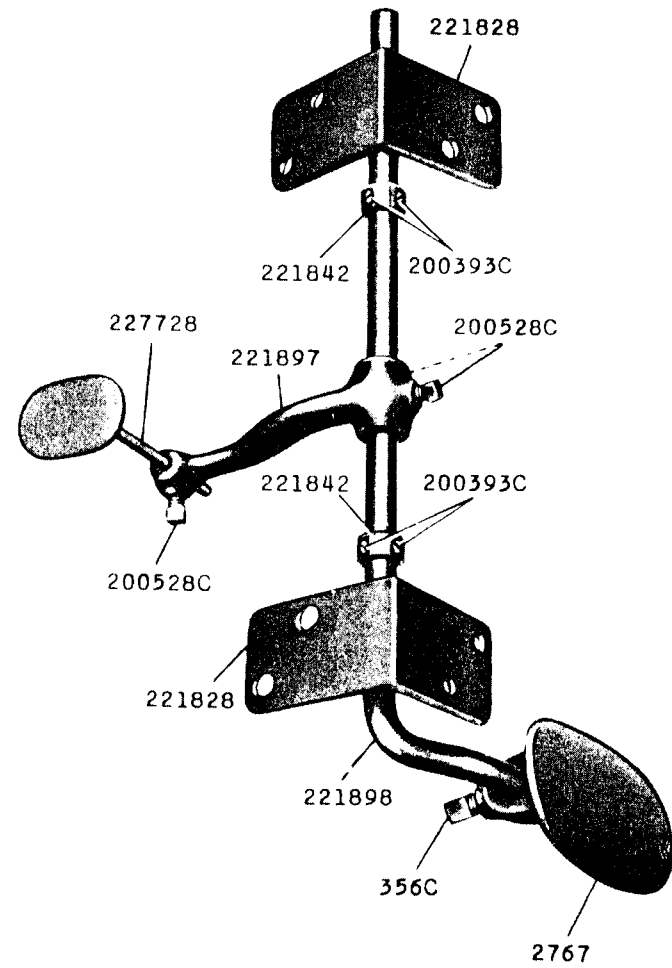

14096 - 1/5

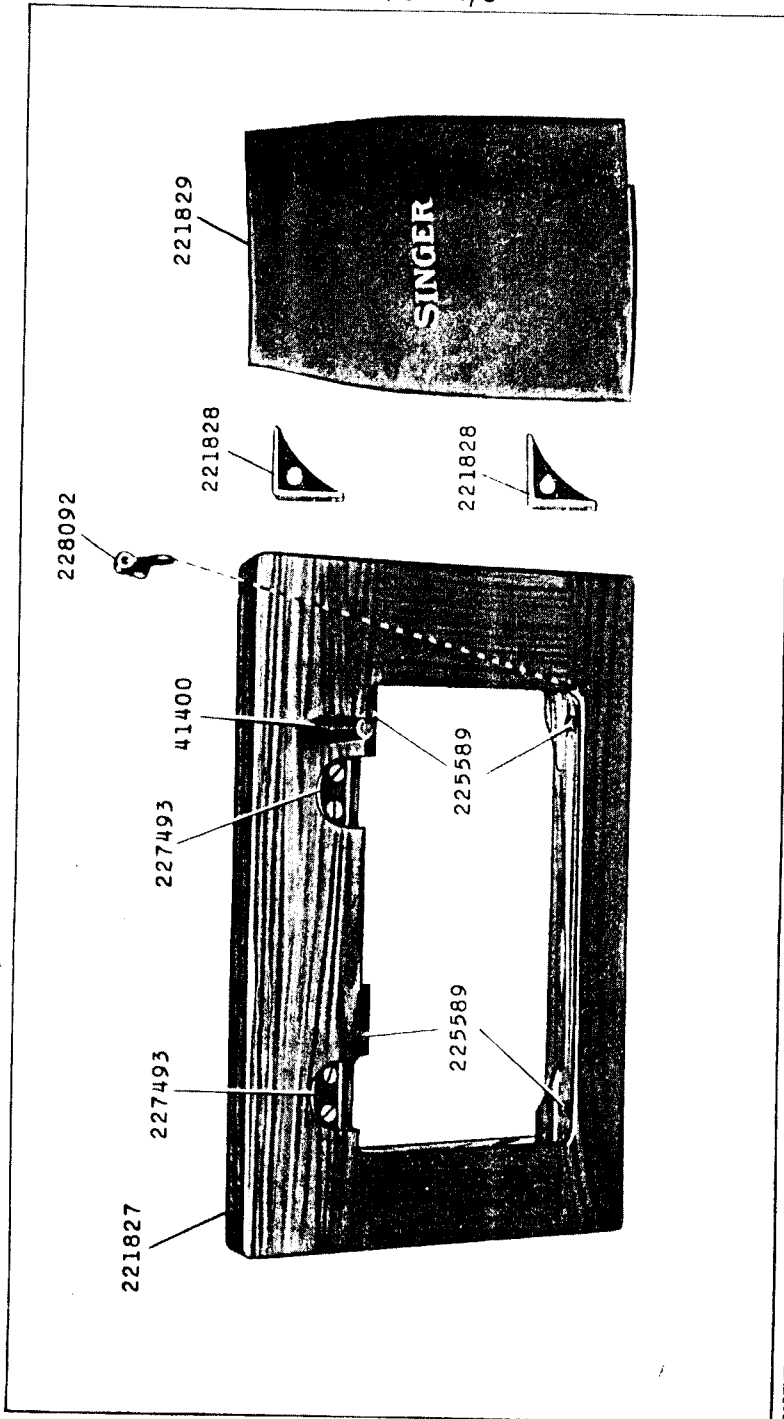

14097 - 1/2

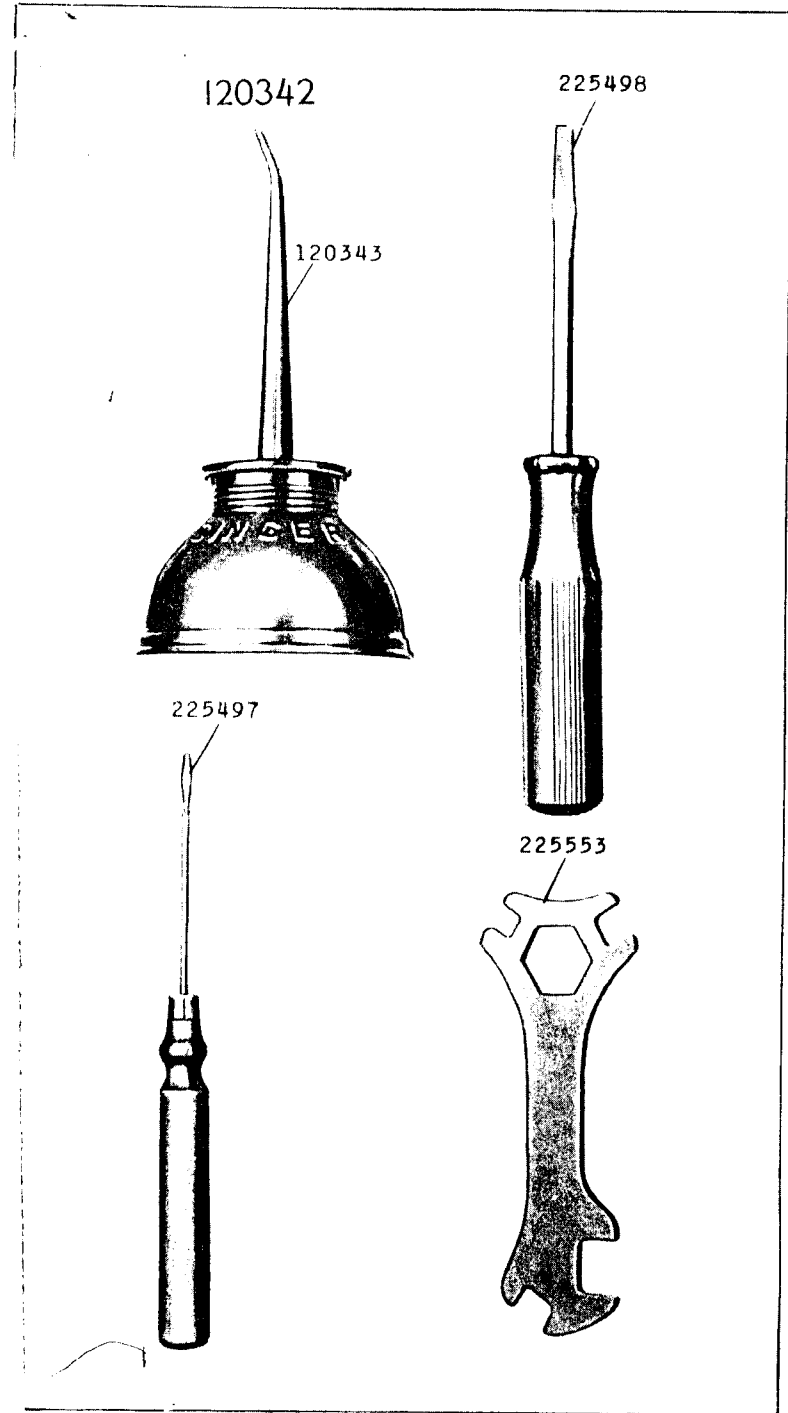



## Free Manuals Download Website

<http://myh66.com>

<http://usermanuals.us>

<http://www.somanuals.com>

<http://www.4manuals.cc>

<http://www.manual-lib.com>

<http://www.404manual.com>

<http://www.luxmanual.com>

<http://aubethermostatmanual.com>

Golf course search by state

<http://golfingnear.com>

Email search by domain

<http://emailbydomain.com>

Auto manuals search

<http://auto.somanuals.com>

TV manuals search

<http://tv.somanuals.com>