

SONY®

3-286-590-12(1)

Digital HD Video Camera Recorder

HANDYCAM®

Handycam Handbook

HDR-SR11E/SR12E

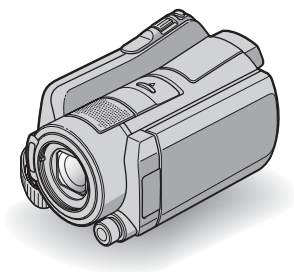

Enjoying your
camcorder 9

Getting Started 15

Recording/Playback 25

Editing 48

Utilizing recording media 62

Customizing your
camcorder 66

Troubleshooting 89

Additional
Information 102

Quick
Reference 112

AVCHD

MEMORY STICK™

InfoLITHIUM™ SERIES

HDMI

Read this before operating your camcorder

Before operating the unit, please read this Handbook thoroughly, and retain it for future reference.

Notes on use

In “Handycam Handbook” (this Handbook)

The operations and handling of your camcorder are explained. Refer also to “Operating Guide” (the separate volume).

Handling the images recorded on your camcorder on the computer

Refer to “PMB Guide” stored on the supplied CD-ROM.

Types of “Memory Stick” you can use in your camcorder

- For recording movies, it is recommended that you use a “Memory Stick PRO Duo” of 1 GB or larger marked with:

- MEMORY STICK PRO DUO (“Memory Stick PRO Duo”)*
- MEMORY STICK PRO-HG DUO (“Memory Stick PRO-HG Duo”)

* Marked with Mark2 or not, either can be used.

- See page 24 for the recordable time of a “Memory Stick PRO Duo.”

“Memory Stick PRO Duo”/“Memory Stick PRO-HG Duo”

(This size can be used with your camcorder.)



“Memory Stick”
(You cannot use it in your camcorder.)



- “Memory Stick PRO Duo” and “Memory Stick PRO-HG Duo” are both referred to as “Memory Stick PRO Duo” in this manual.
- You cannot use any type of memory card other than those mentioned above.
- “Memory Stick PRO Duo” can be used only with “Memory Stick PRO” compatible equipment.
- Do not attach a label or the like on a “Memory Stick PRO Duo” or a Memory Stick Duo adaptor.
- Insert the “Memory Stick PRO Duo” into the Memory Stick Duo adaptor when using a “Memory Stick PRO Duo” with “Memory Stick” compatible equipment.

Using the camcorder

- Do not hold the camcorder by the following parts, and also do not hold the camcorder by the jack covers.

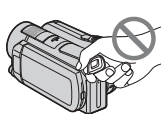

Viewfinder

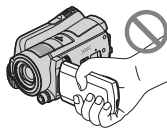

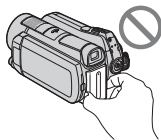

LCD screen

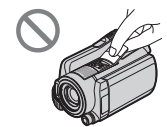

Battery pack



Shoe cover

- The camcorder is not dustproofed, dripproofed or waterproofed. See “About handling of your camcorder” (p. 108).
- Do not do any of the following when the  (Movie)/ (Still) mode lamps (p. 20) or the ACCESS lamps (p. 29) are lit or flashing.
Otherwise, the media may be damaged, recorded images may be lost or other malfunctions could occur.

- Eject the "Memory Stick PRO Duo" from the camcorder
- Remove the battery pack or AC Adaptor from the camcorder
- Apply mechanical shock or vibration to the camcorder

- When connecting your camcorder to another device with a cable, be sure to insert the connector plug in the correct way. Pushing the plug forcibly into the terminal will damage the terminal and may result in a malfunction of your camcorder.
- Connect cables to the connectors of the Handycam Station when using your camcorder attached to the Handycam Station. Do not connect the cables to both the Handycam Station and your camcorder.
- Disconnect the AC Adaptor from the Handycam Station holding both the Handycam Station and the DC plug.
- Be sure to turn the POWER switch to OFF (CHG) when you insert the camcorder into the Handycam Station or remove the camcorder from it.

About menu items, LCD panel, viewfinder, and lens

- A menu item that is grayed out is not available under the current recording or playback conditions.
- The viewfinder and the LCD screen are manufactured using extremely high-precision technology, so over 99.99% of the pixels are operational for effective use. However, there may be some tiny black points and/or bright points (white, red, blue, or green in color) that appear constantly in the viewfinder and on the LCD screen. These points are normal results of the manufacturing process and do not affect the recording in any way.

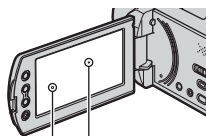

Black point
White, red, blue or green point

- Exposing the LCD screen, the viewfinder, or the lens to direct sunlight for long periods of time may cause malfunctions.
- Do not aim at the sun. Doing so might cause your camcorder to malfunction. Take images of the sun only in low light conditions, such as at dusk.

About changing the language setting

- The on-screen displays in each local language are used for illustrating the operating procedures. Change the screen language before using your camcorder if necessary (p. 21).

On recording

- Before starting to record, test the recording function to make sure the image and sound are recorded without any problems.
- Compensation for the contents of recordings cannot be provided, even if recording or playback is not possible due to a malfunction of the camcorder, storage media, etc.
- TV color systems differ depending on the country/region. To view your recordings on a TV, you need a PAL system-based TV.
- Television programs, films, video tapes, and other materials may be copyrighted. Unauthorized recording of such materials may be contrary to the copyright laws.

On playing back recorded images on other devices

- Your camcorder is compatible with MPEG-4 AVC/H.264 High Profile for HD (high definition) image quality recording. Therefore, you cannot play back images recorded with HD (high definition) image quality on your camcorder with the following devices;
 - Other AVCHD format compatible devices which are not compatible with High Profile
 - Devices which are not compatible with the AVCHD format

About this Handbook

- The images of the viewfinder and the LCD screen used in this Handbook for illustration purposes are captured using a digital still camera, and therefore may appear different.
- In this Handbook, the hard disk of your camcorder and “Memory Stick PRO Duo” are called “media.”
- Design and specifications of your camcorder and accessories are subject to change without notice.

About the Carl Zeiss lens

Your camcorder is equipped with a Carl Zeiss lens, which was developed jointly by Carl Zeiss, in Germany, and Sony Corporation, and produces superior images. It adopts the MTF measurement system for video cameras and offers a quality typical of a Carl Zeiss lens. Also, the lens for your camcorder is T*^{*}-coated to suppress unwanted reflections and faithfully reproduce colors.

MTF= Modulation Transfer Function. The number value indicates the amount of light from a subject coming into the lens.

Notes on using the Hard Disk Drive Handycam

Save all your recorded image data

- To prevent your image data from being lost, save all your recorded images on external media periodically. It is recommended that you save the image data on a disc such as a DVD-R using your computer (p. 47). Also, you can save your image data using a VCR, or a DVD/HDD recorder (p. 58).

Do not apply shock or vibration to your camcorder

- The hard disk of the camcorder may not be recognized, or recording or playback may not be possible.
- Especially, during recording/playback, do not apply shock. After recording, do not apply vibration or shock to the camcorder, while the ACCESS lamp is lit.
- When using a shoulder belt (optional), do not crash the camcorder against an object.
- Do not use your camcorder in very loud areas.

On the drop sensor

- To protect the internal hard disk from shock by dropping, the camcorder has a drop sensor function (p. 81). When a drop occurs, or under a non-gravity condition, the block noise made when this function is activated by the camcorder may also be recorded. If the drop sensor catches a drop repeatedly, recording/playback may be stopped.

Notes on battery pack/AC Adaptor

- Be sure to remove the battery pack or the AC Adaptor after turning off the POWER switch.

Note on operating temperatures

- When the temperature of the camcorder becomes extremely high or extremely low, you may not be able to record or play back on the camcorder, due to the protection features of the camcorder being activated in such situations. In this case, a message appears in the viewfinder or on the LCD screen (p. 98).

When the camcorder is connected to a computer

- Do not try to format the hard disk of the camcorder using a computer. If you do so, your camcorder may not operate correctly.

Note on using the camcorder at high altitudes

- Do not turn on the camcorder in a low-pressure area, where the altitude is more than 3,000 meters (9,800 feet). Doing so may damage the hard disk drive of your camcorder.

Note on disposal/transfer

- Even if you perform [MEDIA FORMAT] (p. 63) or formatting the hard disk of the camcorder, you may not delete data from the hard disk completely. When you transfer the camcorder, it is recommended that you perform [⊖ EMPTY] (p. 64) to prevent the recovery of your data.

Also, when you dispose of the camcorder, it is recommended that you destroy the actual body of the camcorder.

If you cannot record/play back images, perform [MEDIA FORMAT]

- If you repeat recording/deleting images for a long time, fragmentation of data occurs on the media. Images cannot be saved or recorded. In such a case, save your images on some type of external media first, and then perform [MEDIA FORMAT] (p. 63).
Fragmentation ⓘ Glossary (p. 120)

Table of Contents

Read this before operating your camcorder	2
Notes on using the Hard Disk Drive Handycam	5
Subject examples and solutions	8

Enjoying your camcorder

Operation flow	9
“HOME” and “OPTION” - Taking advantage of two types of menus	12

Getting Started

Step 1: Checking supplied items	15
Step 2: Charging the battery pack	16
Step 3: Turning the power on and setting the date and time	20
Changing the language setting ...	21
Step 4: Making setting adjustments before recording	21
Step 5: Selecting the media	22

Recording/Playback

Recording and playback with ease (Easy Handycam operation)	25
Recording	29
Zooming	31
Recording sound with more presence (5.1ch surround recording)	31
Starting shooting quickly (QUICK ON)	32
Recording high quality still images during movie recording (Dual Rec)	32
Recording in dark places (NightShot)	32

Adjusting the exposure for backlit subjects	33
Recording in mirror mode	33
Recording fast action in slow-motion (SMTH SLW REC)	33
Controlling the image settings manually with the CAM CTRL dial	34

Playback	35
Searching for desired scene by pinpoint (Film Roll Index)	37
Searching for desired scene by face (Face Index)	37
Searching for desired images by date (Date Index)	38
Using PB zoom	39
Playing back a series of still images (Slide show)	39
Playing the image on a TV	40
Saving images	47

Editing







(Others) category	48
Deleting images	49
Capturing a still image from a movie	51
Dubbing/copying images to a “Memory Stick PRO Duo” with your camcorder	52
Dividing a movie	54
Creating the Playlist	55
Dubbing to other devices	58
Printing recorded still images (PictBridge compliant printer)	60

Utilizing recording media

(MANAGE MEDIA) category	62
Checking the media information	62

Deleting all images (Formatting) ...	63
Preventing data on the hard disk of the camcorder from being recovered	64
Repairing the image database file	65

Customizing your camcorder

What you can do with the  (SETTINGS) category of the  HOME MENU	66
Using the HOME MENU	66
List of the  (SETTINGS) category items	67
MOVIE SETTINGS	68
(Items for recording movies)	
PHOTO SETTINGS	73
(Items for recording still images)	
VIEW IMAGES SET	75
(Items to customize the display)	
SOUND/DISP SET	77
(Items to adjust the sound and the screen)	
OUTPUT SETTINGS	78
(Items for when connecting other devices)	
CLOCK/ LANG	79
(Items to set clock and language)	
GENERAL SET	80
(Other setup items)	
Activating functions using the  OPTION MENU	82
Using the OPTION MENU	82
Recording items on the OPTION MENU	83
Viewing items on the OPTION MENU	83
Functions set in the  OPTION MENU	84

Troubleshooting

Troubleshooting	89
Self-diagnosis display/Warning indicators	98

Additional Information

Using your camcorder abroad	102
File/folder structure on the camcorder hard disk and “Memory Stick PRO Duo”	104
Maintenance and precautions	105
About the AVCHD format	105
About the “Memory Stick”	105
About the “InfoLITHIUM” battery pack	106
About x.v.Color	107
About handling of your camcorder	108

Quick Reference

Identifying parts and controls	112
Indicators displayed during recording/ playback	117
Glossary	120
Index	121

Subject examples and solutions

Checking your golf swing



▶ SMTH SLW REC 33

Getting a good shot of a ski slope or beach



▶ Backlight33
▶ BEACH86
▶ SNOW86

Capturing still images during movie recording

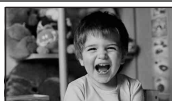

▶ Dual Rec 32

A child on the stage under a spot light



▶ SPOTLIGHT86

Flowers in close-up



▶ PORTRAIT 86
▶ FOCUS 84
▶ TELE MACRO 84

Fireworks with all its splendor



▶ FIREWORKS85
▶ FOCUS84

Focusing on the dog on the left side of the screen



▶ FOCUS 84
▶ SPOT FOCUS 84

A sleeping child under dim light



▶ NightShot32
▶ COLOR SLOW SHTR87

Operation flow

You can select the media (hard disk or “Memory Stick PRO Duo”) separately for movie recording and still image recording (p. 22).

🔊 Notes

- When you select the media for movies, select the image quality (HD (high definition) or SD (standard definition)) as well.
- The default setting is as follows:
 - Movies are recorded on the hard disk with HD (high definition) image quality.
 - Still images are recorded on the hard disk.
- The media and the image quality you select are effective for recording/playback/editing operations.

▶ Get ready (p. 15).

■ Selecting the media (p. 22)

▶ Record with HD (high definition) image quality (p. 29).

Your camcorder is compatible with AVCHD format “1920 × 1080/50i” (p. 105), which provides highly-detailed, beautiful images.



🔊 Notes

- The default setting is [HD SP] which is AVCHD format “1440 × 1080/50i” (p. 68).
- “AVCHD 1080i format” is abbreviated as “AVCHD” in this manual, except when it must be described in more detail.

▶ Play back the images.

■ Viewing on the LCD screen of your camcorder (p. 35)

■ Viewing on a high definition TV (p. 42)

You can enjoy highly-detailed, brilliant quality HD (high definition) movies.



💡 Tips

- You can consult the [TV CONNECT Guide] (p. 40) displayed on the screen on connecting your TV and camcorder.
- You can play back the images on a SD (standard definition) image quality TV.

► **Save recorded images.**

- **Dubbing images from the internal hard disk to a “Memory Stick PRO Duo” (p. 52)**

- **Dubbing to other devices (p. 58)**

The dubbing image quality (HD (high definition)/SD (standard definition)) varies depending on the connected device. For details, see page 58.

- **Editing on a computer (p. 47)**

You can import images with HD (high definition) image quality to a computer, or save images on a disc. Refer to “PMB Guide.”



► **Delete images.**

If the media is full, you cannot record new images. Delete the image data that has been saved on your computer or a disc. If you delete the images, you can record new images on the free media space again.

- **Deleting the selected images (p. 49)**

- **Deleting all the images ([MEDIA FORMAT], p. 63)**



Recording time of movies (internal hard disk)

HD (high definition) image quality AVCHD format		
Recording mode	Approximate recordable time (hour minute)	
	HDR-SR11E	HDR-SR12E
AVC HD 16M (FH) (highest quality)*	7 h 10 m	14 h 40 m
AVC HD 9M (HQ) (high quality)**	14 h 40 m	29 h 40 m
AVC HD 7M (SP) (standard quality)**	17 h 50 m	36 h
AVC HD 5M (LP) (long play)**	22 h 50 m	48 h

* Movies are recorded with AVCHD 1920 × 1080/50i format.

** Movies are recorded with AVCHD 1440 × 1080/50i format.

SD (standard definition) image quality MPEG2 format		
Recording mode	Approximate recordable time (hour minute)	
	HDR-SR11E	HDR-SR12E
SD 9M (HQ) (high quality)	14 h 40 m	29 h 40 m
SD 6M (SP) (standard quality)	21 h 50 m	44 h
SD 3M (LP) (long play)	41 h 50 m	84 h 20 m

Tips

- Figures such as 16M in the table show the average bit rate. M stands for Mbps.
- For the recordable time of the “Memory Stick PRO Duo,” see page 24.
- You can record movies of a maximum of 3,999 scenes with HD (high definition) image quality, and 9,999 scenes with SD (standard definition) image quality.
- You can record the maximum 9,999 still images on the hard disk. For the “Memory Stick PRO Duo,” see page 74.
- The maximum continuous recordable time is approximately 13 hours.

Your camcorder uses the VBR (Variable Bit Rate) format to automatically adjust image quality to suit the recording scene. This technology causes fluctuations in the recording time of the media. Movies containing quickly moving and complex images are recorded at a higher bit rate, and this reduces the overall recording time.

“HOME” and “OPTION”

- Taking advantage of two types of menus

“HOME MENU” - the starting point for operations with your camcorder

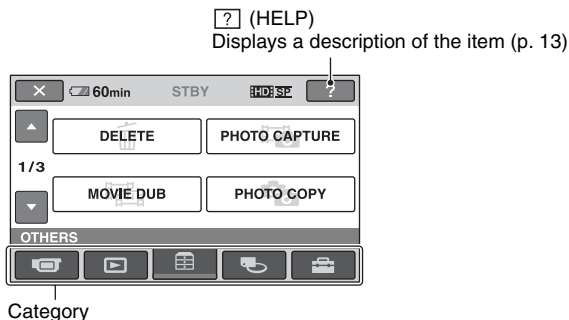

► Categories and items of the HOME MENU

(CAMERA) category

Item	Page
MOVIE*	30
PHOTO*	30
SMTH SLW REC	33

(VIEW IMAGES) category

Item	Page
VISUAL INDEX*	35
INDEX*	37
INDEX*	37
PLAYLIST	55

(OTHERS) category

Item	Page
DELETE*	49
PHOTO CAPTURE	51
MOVIE DUB	52
PHOTO COPY	53
EDIT	54
PLAYLIST EDIT	55

Item	Page
PRINT	60
USB CONNECT	48
TV CONNECT Guide*	41

(MANAGE MEDIA) category

Item	Page
MOVIE MEDIA SET*	22
PHOTO MEDIA SET*	23
MEDIA INFO	62
MEDIA FORMAT*	63
REPAIR IMG.DB F.	65

(SETTINGS) category

To customize your camcorder (p. 66)*.

* You can also set these items during Easy Handycam operation (p. 25). For the items available in the (SETTINGS) category, see page 67.

Using the HOME MENU

- 1 While pressing the green button, turn the POWER switch in the direction of the arrow to turn on the power.

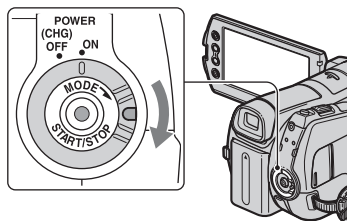

- 2 Press  (HOME)  (or ).

 (HOME) 

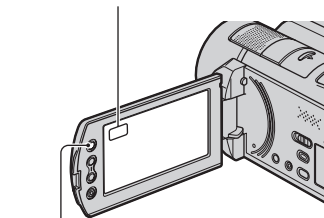

 (HOME) 

- 3 Touch the desired category.

Example:  (OTHERS) category

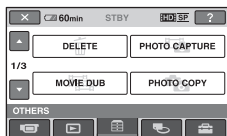

- 4 Touch the desired item.

Example: [EDIT]

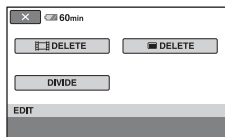

- 5 Follow the guide on the screen for further operation.

To hide the HOME MENU screen

Touch .

- ▶ When you want to know something about the function of each item on the HOME MENU - HELP

- 1 Press .

The HOME MENU appears.



- 2 Touch  (HELP).

The bottom of the  (HELP) turns orange.



3 Touch the item you want to learn more about.



When you touch an item, its explanation appears on the screen.

To apply the option, touch [YES], otherwise, touch [NO].

To deactivate the HELP

Touch [?] (HELP) again in step 2.

Using the OPTION MENU

Just a touch on the screen during shooting or playback displays the functions available at that moment. You will find it easy to make various settings. See page 82 for further details.

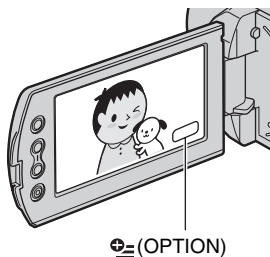

Step 1: Checking supplied items

Make sure that you have the following items supplied with your camcorder. The number in the parentheses indicates the number of that item supplied.

AC Adaptor (1) (p. 16)

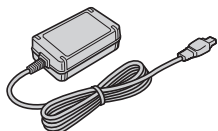

Power cord (Mains lead) (1) (p. 16)

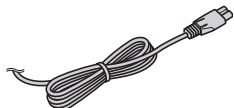

Handycam Station (1) (p. 16, 115)

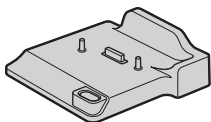

Component A/V cable (1) (p. 42)

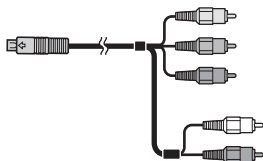

A/V connecting cable (1) (p. 44, 58)



USB cable (1) (p. 59, 60)

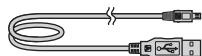

Wireless Remote Commander (1) (p. 116)



A button-type lithium battery is already installed.

Rechargeable battery pack NP-FH60 (1) (p. 16, 106)

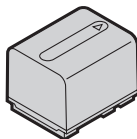

21-pin adaptor (p. 45)

For the model with the  mark printed on their bottom surfaces only.

CD-ROM "Handycam Application Software" (1)

- Picture Motion Browser (Software)
- PMB Guide
- Handycam Handbook (This Handbook)

"Operating Guide" (1)

Step 2: Charging the battery pack

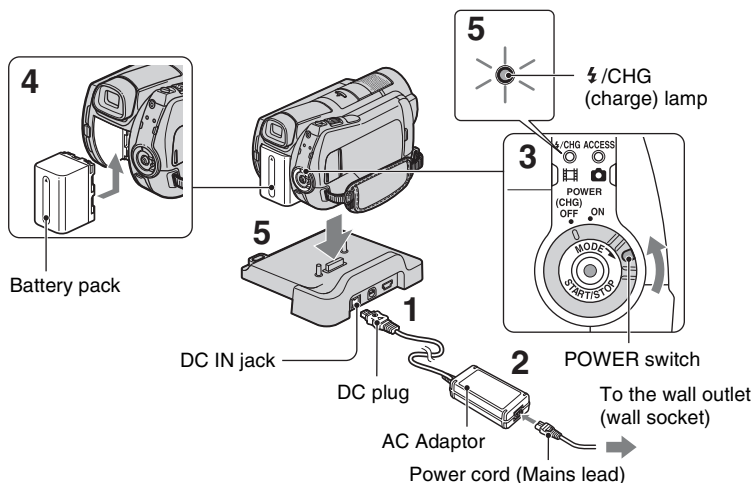

You can charge the “InfoLITHIUM” battery pack (H series) (p. 106) after attaching it to your camcorder.

⚡ Notes

- You cannot attach any “InfoLITHIUM” battery pack other than the H series to your camcorder.

1 Connect the AC Adaptor to the DC IN jack on the Handycam Station.

Be sure that the ▲ mark on the DC plug is facing up.

2 Connect the power cord (mains lead) to the AC Adaptor and the wall outlet (wall socket).

3 Turn the POWER switch in the direction of the arrow to OFF (CHG) (the default setting).

4 Attach the battery pack by sliding it in the direction of the arrow until it clicks.

5 Insert the camcorder into the Handycam Station securely, all the way to the bottom.

The ⚡/CHG (charge) lamp lights up and charging starts. When the ⚡/CHG (charge) lamp turns off, the battery is fully charged.

⚡ Notes

- When inserting the camcorder into the Handycam Station, close the DC IN jack cover.

To remove your camcorder from the Handycam Station

Turn off the power, then remove the camcorder from the Handycam Station holding both your camcorder and the Handycam Station.

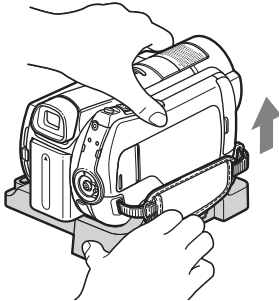

To charge the battery pack using only the AC Adaptor

Turn off the power, then connect the AC Adaptor to the DC IN jack on your camcorder.

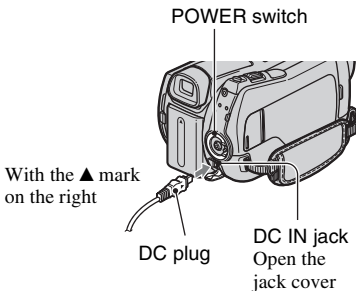

Notes



- Disconnect the AC Adaptor from the DC IN jack holding both the camcorder and the DC plug.

To remove the battery pack

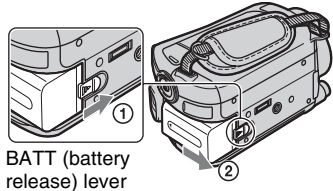
Turn the POWER switch to OFF (CHG). Slide the BATT (battery release) lever and remove the battery pack.



Notes

- When you remove the battery pack or disconnect the AC Adaptor, make sure that the  (Movie) lamp/ (Still) lamp (p. 20)/ACCESS lamps (p. 29) are turned off.
- When you store the battery pack, fully discharge the battery before storing it for an extended period (see page 107 for the details of storage).

To use a wall outlet (wall socket) as a power source

Make the same connections as you do when charging the battery pack. The battery pack will not lose its charge in this case.

To check the remaining battery (Battery Info)

Set the POWER switch to OFF (CHG), then press DISP/BATT INFO.

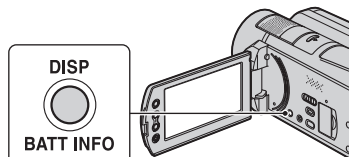

After a while, the approximate recordable time and battery information appear for about 7 seconds. You can view the battery information for up to 20 seconds by pressing DISP/BATT INFO again while the information is displayed.

Remaining battery (approx.)

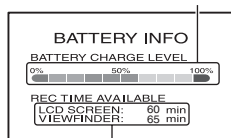

Recording capacity (approx.)

Charging time

Approximate time (min.) required when you fully charge a fully discharged battery pack.

Battery pack	Charging time
NP-FH50	135
NP-FH60 (supplied)	135
NP-FH70	170
NP-FH100	390

Recording time

Approximate time (min.) available when you use a fully charged battery pack. "HD" stands for high definition image quality, and "SD" stands for standard image quality.

When the hard disk is selected as the media:

Battery pack	Continuous recording time		Typical recording time*	
Image quality	HD	SD	HD	SD
NP-FH50	70	80	30	40
	75	85	30	40
NP-FH60 (supplied)	90	110	40	50
	100	115	50	50

Battery pack	Continuous recording time		Typical recording time*	
Image quality	HD	SD	HD	SD
NP-FH70	150	180	70	90
	160	190	80	90
NP-FH100	340	405	170	200
	370	430	180	210

When the "Memory Stick PRO Duo" is selected as the media:

Battery pack	Continuous recording time		Typical recording time*	
Image quality	HD	SD	HD	SD
NP-FH50	70	80	30	40
	75	90	30	40
NP-FH60 (supplied)	90	110	40	50
	100	120	50	60
NP-FH70	150	180	70	90
	160	195	80	90
NP-FH100	340	405	170	200
	370	440	180	220

* Typical recording time shows the time when you repeat recording start/stop, turning the power on/off and zooming.

Notes

- All times measured under the following conditions:
 - [REC MODE]: SP
 - Top: When the LCD backlight turns on
 - Bottom: When recording with the viewfinder while the LCD panel is closed

Playing time



Approximate time (min.) available when you use a fully charged battery pack. "HD" stands for high definition image quality, and "SD" stands for standard image quality.

Battery pack	LCD panel opened*		LCD panel closed		
	HD	SD	HD	SD	
Image quality	HD	SD	HD	SD	
	NP-FH50	95	95	100	100
		105	105	115	115
NP-FH60 (supplied)	130	130	135	135	
	140	140	150	150	
NP-FH70	200	200	205	205	
	230	230	245	245	
NP-FH100	470	470	500	500	
	515	515	555	555	

- Top: When the media is set to the hard disk
Bottom: When the media is set to the "Memory Stick PRO Duo"

* When the LCD backlight is on.

On the battery pack

- When you remove the battery pack or the AC Adaptor, turn the POWER switch to OFF (CHG) and turn off the  (Movie) lamp/ (Still) lamp (p. 20)/ACCESS lamp (p. 29).
- The /CHG (charge) lamp flashes during charging, or Battery Info (p. 17) will not be correctly displayed under the following conditions:
 - The battery pack is not attached correctly.
 - The battery pack is damaged.
 - The battery pack is worn-out (For Battery Info only).
- The power will not be supplied from the battery as long as the AC Adaptor is connected to the DC IN jack of your camcorder or the Handycam Station, even when the power cord (mains lead) is disconnected from the wall outlet (wall socket).
- When attaching an optional video light, it is recommended that you use an NP-FH70 or NP-FH100 battery pack.
- We do not recommend using an NP-FH30, which only allows short recording and playback times, with your camcorder.

On the charging/recording/playback time

- Times measured when using the camcorder at 25 °C (77 °F) (10 °C to 30 °C (50 °F to 86 °F) is recommended).

- The recording and playback time will be shorter when you use your camcorder in low temperatures.
- The recording and playback time will be shorter depending on the conditions under which you use your camcorder.

On the AC Adaptor

- Use the nearby wall outlet (wall socket) when using the AC Adaptor. Disconnect the AC Adaptor from the wall outlet (wall socket) immediately if any malfunction occurs while using your camcorder.
- Do not use the AC Adaptor placed in a narrow space, such as between a wall and furniture.
- Do not short-circuit the DC plug of the AC Adaptor or battery terminal with any metallic objects. This may cause a malfunction.
- Even if your camcorder is turned off, AC power source (mains) is still supplied to it while connected to the wall outlet (wall socket) via the AC Adaptor.

Step 3: Turning the power on and setting the date and time

Set the date and time when using this camcorder for the first time. If you do not set the date and time, the [CLOCK SET] screen appears every time you turn on your camcorder or change the POWER switch position.

↑ (HOME)

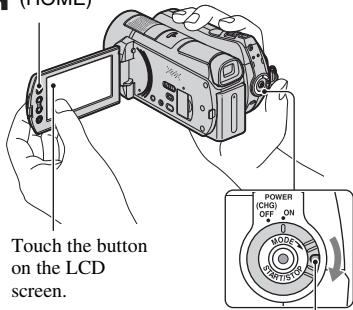

Touch the button on the LCD screen.

POWER switch

1 While pressing the green button, turn the POWER switch repeatedly in the direction of the arrow until the respective lamp lights up.

(Movie): To record movies

(Still): To record still images

Go to step 3 when you turn on your camcorder for the first time.

2 Touch ↑ (HOME) → (SETTINGS) → [CLOCK/AREA LANG] → [CLOCK SET]

The [CLOCK SET] screen appears.

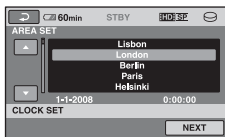

3 Select the desired geographical area with ▲/▼, then touch [NEXT].

4 Set [SUMMERTIME], then touch [NEXT].

5 Set [Y] (year) with ▲/▼.



6 Select [M] with ◀/▶, then set the month with ▲/▼.

7 Set [D] (day), hour and minute in the same way, then touch [NEXT].

8 Make sure that the clock is correctly set, then touch [OK].

The clock starts.

You can set any year up to the year 2037.

To turn off the power

Turn the POWER switch to OFF (CHG).

Notes

- If you do not use your camcorder for **about 3 months**, the built-in rechargeable battery gets discharged and the date and time settings may be cleared from the memory. In that case, charge the built-in rechargeable battery and then set the date and time again (p. 110).

- It takes a few seconds for your camcorder to be ready to shoot after the power is turned on. You cannot operate your camcorder during this time.
- The lens cover opens automatically when the power is turned on. It closes when the playback screen is selected, or the power is turned off.
- In the setting at the time of purchase, the power turns off automatically if you leave your camcorder without any operation attempted for approximately 5 minutes, to save battery power [A.SHUT OFF], p. 80).

Tips

- The date and time does not appear during recording, but they are automatically recorded on the media, and can be displayed during playback (see page 75 for [DATA CODE]).
- Refer to page 103 for information concerning "World time difference."
- If the buttons on the touch panel do not work correctly, adjust the touch panel (CALIBRATION) (p. 109).

Changing the language setting

You can change the on-screen displays to show messages in a specified language. To select the screen language, touch

(HOME) → (SETTINGS) → [CLOCK/]
[A] LANG → [A] LANGUAGE SET] (p. 79).

Step 4: Making setting adjustments before recording

Adjusting the LCD panel

Open the LCD panel 90 degrees to the camcorder (①), then rotate it to the best angle to record or play (②).

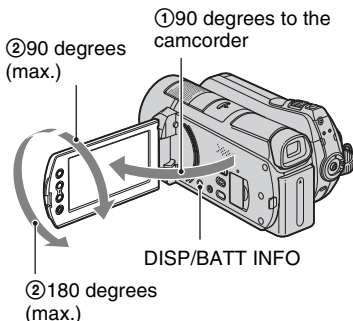

To turn off the LCD backlight to make the battery last longer

Press and hold DISP/BATT INFO for a few seconds until appears.

This setting is practical when you use your camcorder in bright conditions or you want to save battery power. The recorded image will not be affected by the setting. To turn on the LCD backlight, press and hold DISP/BATT INFO for a few seconds until disappears.

Notes

- Do not press the buttons on the LCD frame accidentally when you open or adjust the LCD panel.

Tips

- If you rotate the LCD panel 180 degrees, you can close the LCD panel with the LCD screen facing out. This is convenient during playback operations.
- Touch (HOME) → (SETTINGS) → [SOUND/DISP SET] → [LCD BRIGHT] (p. 77), and adjust the brightness of the LCD screen.

- The information is displayed or hidden (display ← no display) each time you press DISP/ BATT INFO.

Adjusting the Viewfinder

You can view images using the viewfinder with the LCD panel closed to avoid wearing down the battery, or when the image seen on the LCD screen is poor.

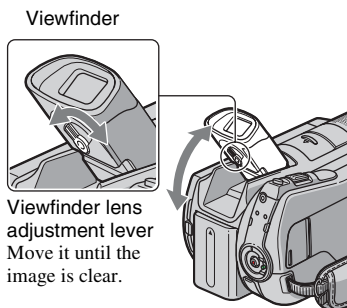

💡 Tips

- You can adjust the brightness of the viewfinder backlight by touching **HOME** → **SETTINGS** → [SOUND/DISP SET] → [VF B.LIGHT] (p. 77).

Fastening the grip belt

Fasten the grip belt and hold your camcorder correctly.

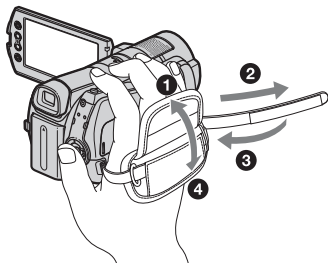

Step 5: Selecting the media

You can select the hard disk or “Memory Stick PRO Duo” as the recording/playback/editing media on your camcorder. Select the media for movies and still images separately.

The default setting is hard disk for movies and still images.

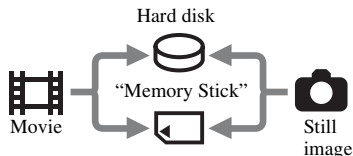

🔧 Notes

- You can do recording/playback/editing operations for the selected media. When you want to change media, reselect the media.

💡 Tips

- See pages 11 and 24 for the recordable time.
- See page 52 on dubbing/copying between two media.

Selecting the media for movies

- Touch **HOME** → **MANAGE MEDIA** → [MOVIE MEDIA SET] on the LCD screen of your camcorder.

The media setting screen for movies appears.

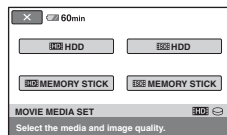

- Touch the desired media and image quality.

HD indicates HD (high definition) image quality, and **SD** indicates SD (standard definition) image quality.

3 Touch [YES] → [OK].

The media for movies is changed.

Selecting the media for still images

1 Touch (HOME) → (MANAGE MEDIA) → [PHOTO MEDIA SET] on the LCD screen of your camcorder.

The media setting screen for still images appears.

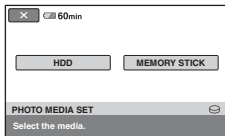



2 Touch the desired media.

3 Touch [YES] → [OK].

The media for still images is changed.

To check the media setting

- Turn the POWER switch repeatedly to light up the  (Movie) or  (Still) lamp depending on which media you want to check.
- Check the media icon on the screen.



: Hard disk

: "Memory Stick PRO Duo"

Inserting a "Memory Stick PRO Duo"

Prepare a "Memory Stick PRO Duo" if "Memory Stick PRO Duo" has been selected as the media.

For types of "Memory Stick" you can use in your camcorder, see page 2.

1 Insert the "Memory Stick PRO Duo."

- Open the Memory Stick Duo cover in the direction of the arrow.
- Insert the "Memory Stick PRO Duo" into the Memory Stick Duo slot in the right direction until it clicks.
- Close the Memory Stick Duo cover.

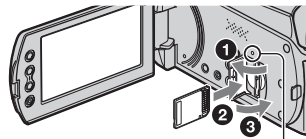

ACCESS lamp ("Memory Stick PRO Duo")

2 If you have selected "Memory Stick PRO Duo" as the movie media, turn the POWER switch until the (Movie) lamp lights up.

If the POWER switch is set to OFF (CHG), turn it on while pressing the green button.

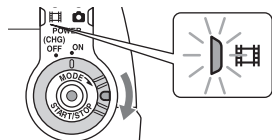

The [Create a new Image Database File.] screen appears on the LCD screen when you insert a new “Memory Stick PRO Duo.”



3 Touch [YES].

To record only still images on a “Memory Stick PRO Duo,” touch [NO].

To eject the “Memory Stick PRO Duo”

Open the Memory Stick Duo cover and lightly push the “Memory Stick PRO Duo” in once.

Notes

- Do not open the Memory Stick Duo cover during recording.
- If you force the “Memory Stick PRO Duo” into the slot in the wrong direction, the “Memory Stick PRO Duo,” the Memory Stick Duo slot, or image data may be damaged.
- If [Failed to create a new Image Database File. It may be possible that there is not enough free space.] is displayed in step 3, format the “Memory Stick PRO Duo” (p. 63). Note that formatting will delete all data recorded on the “Memory Stick PRO Duo.”
- When inserting or ejecting the “Memory Stick PRO Duo,” be careful so that the “Memory Stick PRO Duo” does not pop out and drop.

The capacity and approximate recordable time of the “Memory Stick PRO Duo” (Unit: min.)

The number in () is the minimum recordable time.

HD (high definition) image quality

	AVC HD 16M (FH)	AVC HD 9M (HQ)	AVC HD 7M (SP)	AVC HD 5M (LP)
1GB	6 (6)	10 (9)	15 (10)	20 (15)
2GB	10 (10)	25 (20)	30 (20)	40 (35)
4GB	25 (25)	55 (40)	65 (45)	85 (70)
8GB	55 (55)	115 (80)	140 (100)	180 (145)

SD (standard definition) image quality

	SD 9M (HQ)	SD 6M (SP)	SD 3M (LP)
1GB	10 (10)	20 (10)	35 (25)
2GB	25 (25)	40 (25)	80 (50)
4GB	55 (50)	80 (50)	160 (105)
8GB	115 (100)	170 (100)	325 (215)

Notes

- Numbers in the table are based on using a “Memory Stick PRO Duo” made by Sony Corporation. The recordable time may vary depending on the recording and subject conditions, [REC MODE] (p. 68), and the type of “Memory Stick.”

Tips

- For the number of recordable still images, see page 74.



Recording and playback with ease (Easy Handycam operation)

Easy Handycam operation makes nearly all settings automatic so that you can perform recording or playback operation without detailed settings. It also makes the screen font size larger for easy viewing. The images are recorded on the selected media (p. 22).

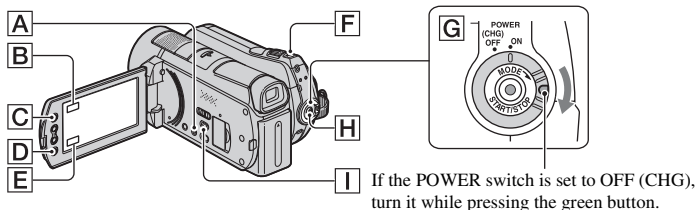

Recording movies



- 1 Turn the POWER switch **G** in the direction of the arrow until the (Movie) lamp lights up.



- 2 Press EASY **A**.

EASY



EASY appears on the LCD screen.

- 3 Press START/STOP **H** (or **D**) to start recording.*

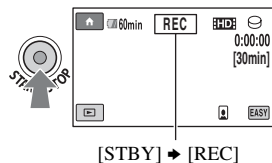

To stop recording, press START/STOP again.

Recording still images



- 1 Turn the POWER switch **G** in the direction of the arrow until the (Still) lamp lights up.



- 2 Press EASY **A**.

EASY



EASY appears on the LCD screen.

- 3 Press PHOTO **F** lightly to adjust the focus **A** (a beep sounds), then press it fully **B** (a shutter click sounds).

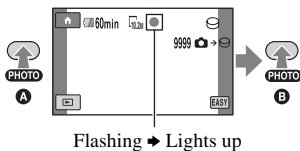

* The [REC MODE] is fixed to [HD SP] or [SD SP] (p. 68).

Tips

- During Easy Handycam operation, faces are detected with frames ([FACE DETECTION], p. 72).

Playing back recorded movies/still images

1 Turn the **POWER** switch **G** to turn on your camcorder.

2 Press **VIEW IMAGES** **I** (or **E**).

The **VISUAL INDEX** screen appears on the LCD screen (It may take some seconds).

Appears with the image on each of the tab that was lastly played back/
recorded (▶ for the still image recorded on a “Memory Stick PRO Duo”)

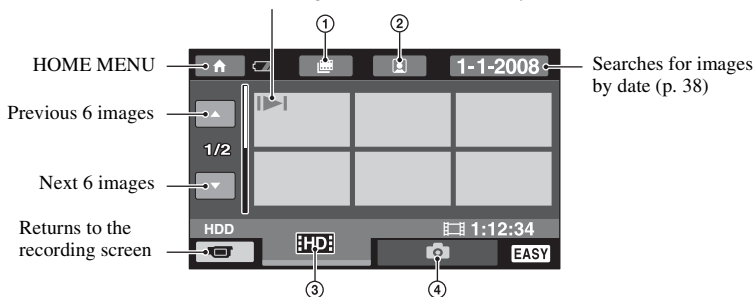

① :Goes to the Film Roll Index screen.

② :Goes to the Face Index screen.

③ :Displays movies with HD (high definition) image quality.*

④ :Displays still images.

* appears when you select the movie with SD (standard definition) image quality in [MOVIE MEDIA SET] (p. 22).

3 Start playback.

Movies:

Touch the **HDD** or **HSD** tab, then select the desired movie to play back.

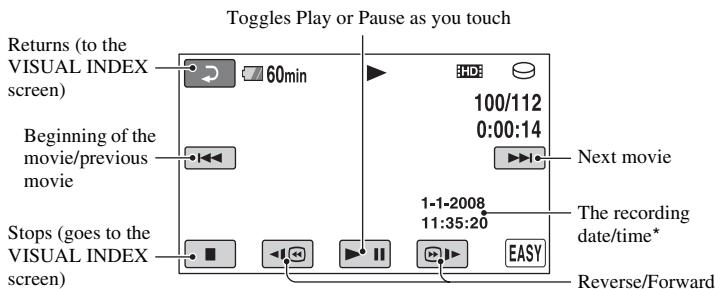

* The setting of [DATA CODE] is fixed to [DATE/TIME] (p. 75).

Tips

- When playback from the selected movie reaches the last movie, the screen returns to the VISUAL INDEX screen.
- You can slow down the playback speed by touching during pause.
- You can adjust the volume by touching (HOME) → (SETTINGS) → [SOUND SETTINGS] → [VOLUME], then touch / .

Still images:

Touch the tab, then select the desired still image to play back.

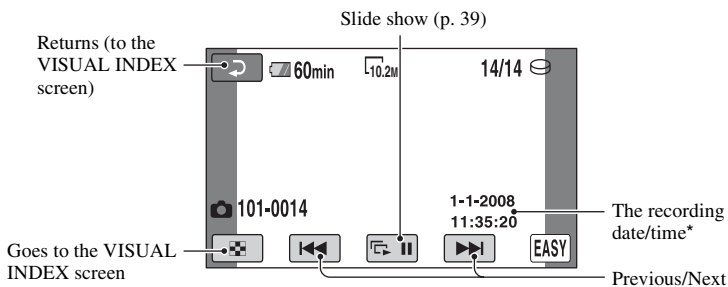

* The setting of [DATA CODE] is fixed to [DATE/TIME] (p. 75).

Tips

- To change the media, select the media on [MOVIE MEDIA SET]/[PHOTO MEDIA SET] (p. 22).

To cancel Easy Handycam operation

Press EASY [A] again. EASY disappears from the LCD screen.

Menu settings during Easy Handycam operation

Press  (HOME) [C] (or [B]) to display the menu items available for setup changes (p. 12, 66).

Notes

- Most of the menu items automatically return to the default settings. The settings of some menu items are fixed. For details, see page 90.
- You cannot use the  (OPTION) MENU.
- Cancel Easy Handycam operation if you want to add effects to images or change settings.

Invalid buttons during Easy Handycam operation

You cannot use some buttons/functions during Easy Handycam operation since they are automatically set (p. 90). If you set an invalid operation, [Invalid during Easy Handycam operation] may appear.

Recording

The images are recorded on the media selected in the media setting (p. 22).
In the default setting, both movies and still images are recorded on the hard disk.

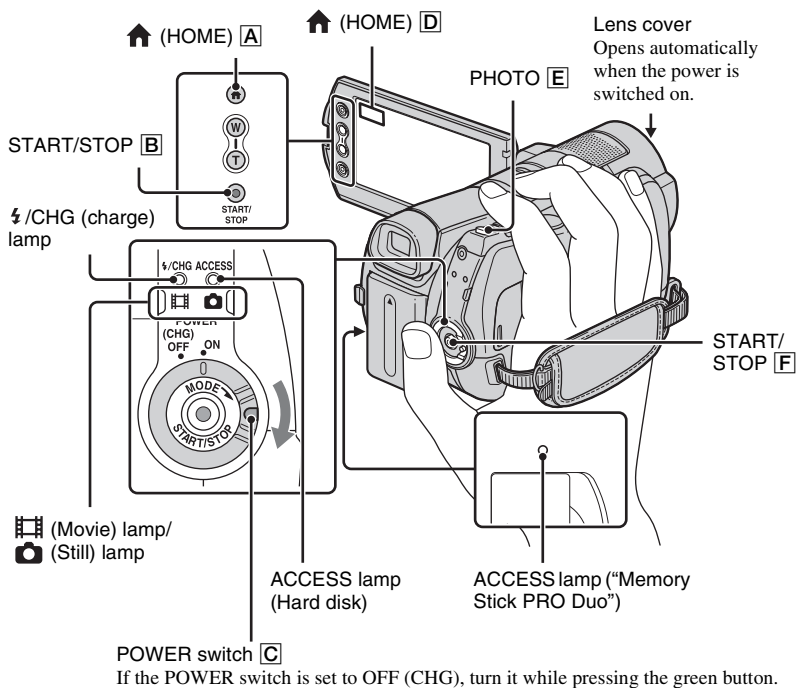

Notes

- If the ACCESS lamp is lit or flashing after recording is finished, it means data is still being written onto the media. Do not apply shock or vibration to your camcorder, and do not remove the battery or AC Adaptor.
- When a movie file exceeds 2 GB, the next movie file is created automatically.

Tips

- For types of "Memory Stick" you can use in your camcorder, see page 2.
- You can check the recordable time and the remaining capacity, etc., by touching ↑ (HOME) A (or D) → (MANAGE MEDIA) → [MEDIA INFO] (p. 62).

Recording movies



- 1 Turn the POWER switch **C** in the direction of the arrow until the  (Movie) lamp lights up.

- 2 Press START/STOP **F** (or **B**).

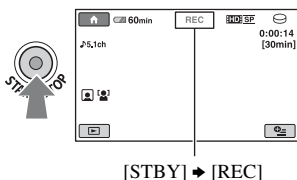

To stop recording, press START/STOP **F** (or **B**) again.





Recording still images



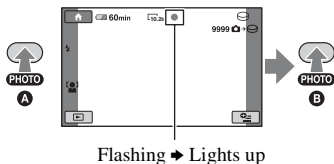

- 1 Turn the POWER switch **C** in the direction of the arrow until the  (Still) lamp lights up.

- 2 Press PHOTO **E** lightly to adjust the focus **A** (a beep sounds), then press it fully **B** (a shutter click sounds).



 appears beside  or . When  disappears, the image has been recorded.

Tips

- For the recordable time and the number of recordable images, see pages 11, 24 and 74.
- You can record still images during movie recording by pressing PHOTO **E** ([Dual Rec], p. 32).
- A frame is shown on the detected face, and the detected face image is optimized automatically ([FACE DETECTION], p. 72).
- When a face is detected during movie recording,  flashes and the detected face is stored in the index. You can search for a desired scene by a face image when playing back ([Face Index], p. 37).
- You can capture still images from recorded movies (p. 51).
- You can switch the shooting mode by touching  (HOME) **A** (or **D**) →  (CAMERA) → [MOVIE] or [PHOTO].

- The LCD screen of your camcorder can display recording images across the entire screen (full pixel display). However, this may cause slight trimming of the top, bottom, right, and left edges of images when played back on a TV which is not compatible with full pixel display. In this case, set [GUIDEFAME] to [ON] (p. 70), and record images using the outer frame displayed on the screen as a guide.

Zooming

You can magnify images up to 12 times the original size with the power zoom lever or the zoom buttons on the LCD frame.

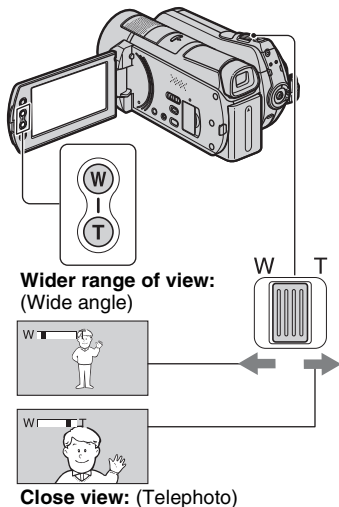

Move the power zoom lever slightly for a slower zoom. Move it further for a faster zoom.

Notes

- Be sure to keep your finger on the power zoom lever. If you move your finger off the power zoom lever, the operation sound of the power zoom lever may also be recorded.
- You cannot change the zoom speed with the zoom buttons on the LCD frame.
- The minimum possible distance between camcorder and subject while maintaining sharp focus is about 1 cm (about 13/32 in.) for wide angle and about 80 cm (about 2 5/8 feet) for telephoto.

Tips

- You can set [DIGITAL ZOOM] (p. 70) if you want to zoom to a level greater than 12 × when recording movies.

Recording sound with more presence (5.1ch surround recording)

Dolby Digital 5.1ch surround sound can be recorded with the Built-in microphone. You can enjoy realistic sound when playing the movie on devices that support 5.1ch surround sound.

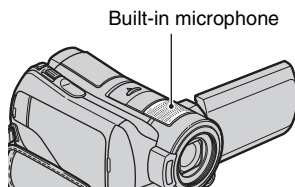

Dolby Digital 5.1 Creator, 5.1ch surround sound
📖 Glossary (p. 120)

Notes

- If you play back 5.1ch sound on your camcorder, 5.1ch sound is automatically converted and output in 2ch.
- To enjoy the 5.1ch surround sound recorded with HD (high definition) image quality, you need an AVCHD format device compatible with 5.1ch surround.
- When you connect your camcorder with an HDMI cable (optional), the sound of movies with HD (high definition) image quality is automatically output in 5.1ch surround. The sound of the movies with SD (standard definition) image quality is converted to 2ch.
- You can create a disc, which contains the movies recorded on your camcorder, on a computer using the supplied software. If you play the disc on a 5.1ch surround system, you can enjoy realistic sound.

Tips

- You can select the recording sound from [5.1ch SURROUND] (🔊5.1ch) or [2ch STEREO] (🔊2ch) ([AUDIO MODE], p. 69).

Starting shooting quickly (QUICK ON)

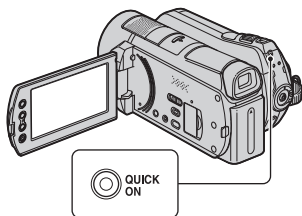

When you press QUICK ON, the camcorder goes to sleep mode (power saving mode) instead of turning off. The QUICK ON lamp keeps flashing during sleep mode. Press QUICK ON again to start recording next time. Your camcorder returns to recording standby in approximately 1 second.

💡 Tips

- During sleep mode, the battery is consumed at about half that of usual recording, enabling you to save battery power.
- The power turns off automatically if you do not operate your camcorder for a certain period during sleep mode. You can set the time that you want the camcorder to remain on before automatically turning off in sleep mode ([QUICK ON STBY], p. 80).

Recording high quality still images during movie recording (Dual Rec)

You can record high quality still images during movie recording by pressing PHOTO.

📌 Notes

- You cannot use the flash during movie recording.
- 📷 may appear when the capacity of the recording media is not enough or when you record still images continuously. You cannot record still images while 📷 is displayed.

💡 Tips

- When the POWER switch is set to 🎬 (Movie), the size of still images becomes [📷 7.6M] (16:9 wide) or [5.7M] (4:3).
- You can record still images during recording standby in the same way as when the 📷 (Still) lamp is turned on. You can also record with the flash.

Recording in dark places (NightShot)

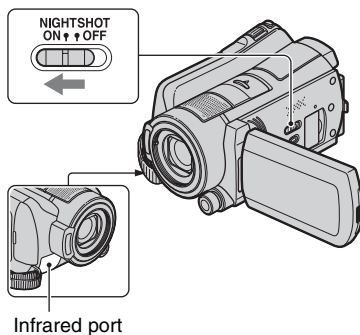

When you set the NIGHTSHOT switch to ON, 📷 appears. You can record images in dark places.

📌 Notes

- The NightShot and Super NightShot functions use infrared light. Therefore, do not cover the infrared port with your fingers or other objects.
- Remove the conversion lens (optional).
- Adjust the focus manually ([FOCUS], p. 84) when it is hard to focus automatically.
- Do not use the NightShot and Super NightShot functions in bright places. This may cause a malfunction.

💡 Tips

- To record an image brighter, use the Super NightShot function (p. 87). To record an image more faithfully to the original colors, use the Color Slow Shutter function (p. 87).

Adjusting the exposure for backlit subjects

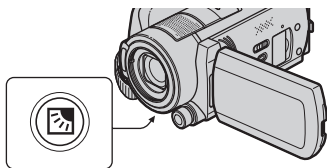

To adjust the exposure for backlit subjects, press (back light) to display on the screen. To cancel the back light function, press (back light) again.

Recording in mirror mode

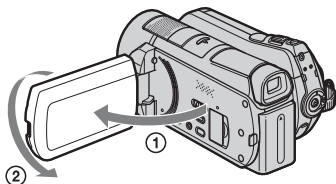

Open the LCD panel 90 degrees to the camcorder (①), then rotate it 180 degrees to the lens side (②).

💡 Tips

- A mirror-image of the subject appears on the LCD screen, but the image will be normal when recorded.

Recording fast action in slow-motion (SMTH SLW REC)

Fast moving subjects and actions, which cannot be captured under the ordinary shooting conditions, can be shot in smooth moving slow-motion for about 3 seconds. This is useful to shoot fast actions such as a golf or tennis swing.

- ① Touch (HOME) → (CAMERA) → [SMTH SLW REC].



- ② Press START/STOP.

A 3-second movie (approx.) is recorded as a 12-second-slow-motion movie. [Recording...] disappears, when recording is finished.

Touch to cancel the smooth slow recording.

To change the setting

Touch (OPTION) → tab, then select the setting you want to change.

• [TIMING]

Select the recording start point after START/STOP is pressed. The default setting is [3sec AFTER].

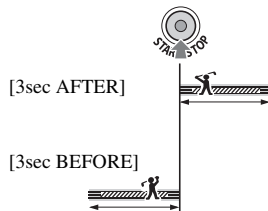

• [RECORD SOUND]

Select [ON] () to superimpose sounds such as conversation on the slow motion pictures (The default setting is [OFF]). Your camcorder records sounds for about 12 seconds while [Recording...] is displayed in step ②.

🔔 Notes

- Sounds cannot be recorded while shooting a 3-second movie (approx.).
- Image quality of [SMTH SLW REC] is not as good as that of normal recording.

- During Easy Handycam operation, the [SMTH SLW REC] function cannot be used. Cancel Easy Handycam operation.

Controlling the image settings manually with the CAM CTRL dial

You can assign one menu item you use often to the CAM CTRL dial. Since the focus adjustment is assigned to the CAM CTRL dial in the default settings, the operation below is described as adjusting the focus using the dial.

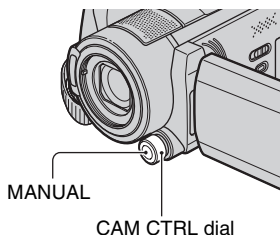

- ① Press MANUAL to activate the manual adjustment mode.
Pressing MANUAL switches the setting mode between automatic and manual.
- ② Rotate the CAM CTRL dial to adjust the focus.

Items you can assign to the CAM CTRL dial

- [FOCUS] (p. 84)
- [EXPOSURE] (p. 85)
- [AE SHIFT] (p. 69)
- [WB SHIFT] (p. 69)

To assign the menu items to the CAM CTRL dial

- ① Press and hold MANUAL for a few seconds.
The [DIAL SETTING] screen appears.

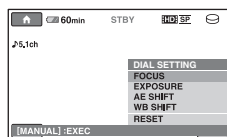

- ② Rotate the CAM CTRL dial and select the item to be assigned.
- ③ Press MANUAL.

Notes

- Manual settings will be retained even if you change the assigned item of the CAM CTRL dial. However, if you set [EXPOSURE] after setting [AE SHIFT] manually, [EXPOSURE] will override [AE SHIFT].
- If you select [RESET] in step ②, all the items adjusted manually are reset to the default settings.

Tips

- The functions of the items that can be assigned to the CAM CTRL dial are the same as those of menu operation.
- You can also assign menu items to the CAM CTRL dial by touching (HOME) → (SETTINGS) → [MOVIE SETTINGS]/[PHOTO SETTINGS] → [DIAL SETTING] (p. 72).

Playback

You can play back the images on the media selected in the media setting (p. 22). In the default setting, the images on the hard disk are played back.

Lens cover

Closes when an INDEX screen appears.

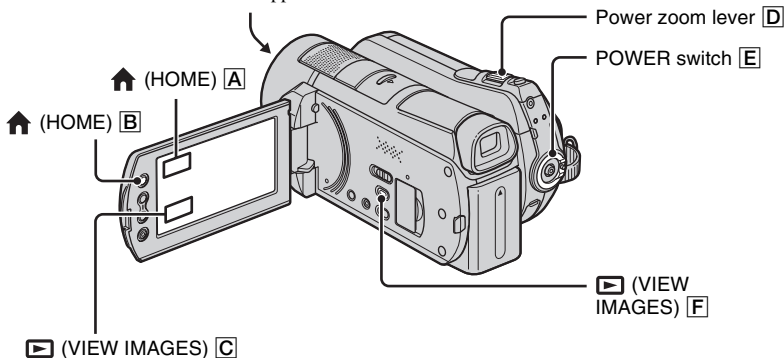

1 Turn the POWER switch **E** to turn on your camcorder.

2 Press **VIEW IMAGES** **F** (or **C**).

The VISUAL INDEX screen appears on the LCD screen (It may take some seconds).

Appears with the image on the tab that was lastly played back/recorded
(▶ for the still image recorded on a “Memory Stick PRO Duo”)

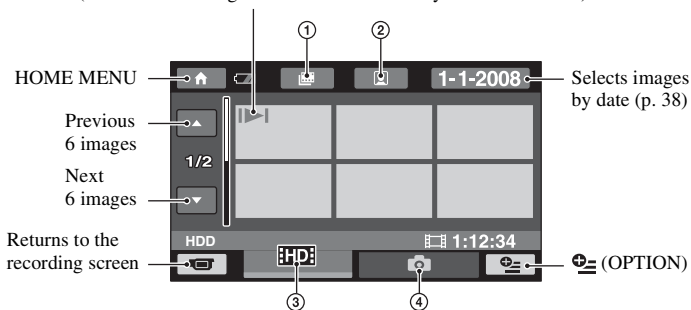

- ① : Goes to the Film Roll Index screen (p. 37).
- ② : Goes to the Face Index screen (p. 37).
- ③ : Displays movies with HD (high definition) image quality.*
- ④ : Displays still images.

* **SD** appears when you select the movie with SD (standard definition) image quality in [MOVIE MEDIA SET] (p. 22).

💡 Tips

- The number of the images on the VISUAL INDEX screen can be changed 6 ↔ 12 by moving the power zoom lever [D]. To fix this number, press **HOME** [B] (or [A]) → **(SETTINGS)** → [VIEW IMAGES SET] → [DISPLAY] (p. 76).

3 Start playing back.

Playing movies



Touch the **HD** or **SD** tab, then select the desired movie to play back.

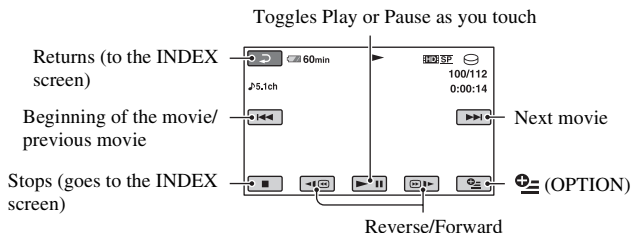

💡 Tips

- When playback from the selected movie reaches the last movie, the screen returns to the INDEX screen.
- Touch **◀|⏸|▶** during pause to play back movie slowly.
- A touch of **◀|⏸|▶** makes the reverse/fast forward approximately 5 times faster, 2 touches makes it approximately 10 times faster, 3 touches makes it approximately 30 times faster, and 4 touches makes it approximately 60 times faster.

Viewing still images



Touch the **📷** tab, then select the desired still image to play back.

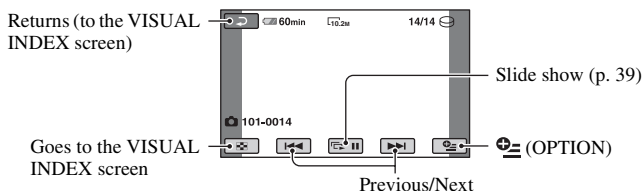

To adjust the sound volume

Touch (OPTION) → tab → [VOLUME], then adjust the volume with / .

💡 Tips

- You can switch the playback mode by touching (HOME) (or [A]) → (VIEW IMAGES) → [VISUAL INDEX].

Searching for desired scene by pinpoint (Film Roll Index)

Movies can be divided by a set time and the first scene of each division is displayed on the INDEX screen. You can start playing back a movie from the selected thumbnail. Select the media which contains the movie you want to play back before the operation (p. 22).

1 Turn the POWER switch to turn on the camcorder, and press (VIEW IMAGES).

The VISUAL INDEX screen appears.

2 Touch (Film Roll Index).

Returns to the VISUAL INDEX screen

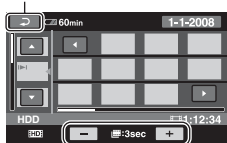

Sets the interval at which to create thumbnails of scenes in a movie.

3 Touch to select the desired movie.

4 Touch to search for the desired scene, then touch the scene you want to play back.

Playback starts from the selected scene.

💡 Tips

- You can display the [Film Roll Index] screen by touching (HOME) → (VIEW IMAGES) → [INDEX].

Searching for desired scene by face (Face Index)

The face images detected during movie recording are displayed on the index screen. You can play back the movie from the selected face image.

Select the media which contains the movie you want to play back before the operation (p. 22).

1 Turn the POWER switch to turn on the camcorder, and press (VIEW IMAGES).

The VISUAL INDEX screen appears.

2 Touch (Face Index).

Returns to the VISUAL INDEX screen

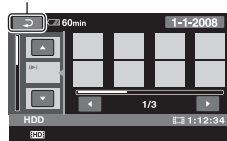

3 Touch to select the desired movie.

4 Touch ◀/▶, then touch the desired face image to view the scene.

Playback starts from the beginning of the scene with the selected face image.

⚡ Notes

- Faces may not be detected depending on recording conditions.
Example: People wearing glasses or hats, or who do not face towards the camera.
- Set [INDEX SET] to [ON] (the default setting) before recording to play back from [INDEX] (p. 72). Make sure that [] flashes during recording, and detected face images are stored in [Face Index].

💡 Tips

- You can display the [Face Index] screen by touching [HOME] → [VIEW IMAGES] → [INDEX].

Searching for desired images by date (Date Index)

You can search for desired images by date efficiently.

Select the media which contains the image you want to play back before the operation (p. 22).

⚡ Notes

- You cannot use the Date Index function for still images on the “Memory Stick PRO Duo.”
-

1 Turn the POWER switch to turn on the camcorder, and press [VIEW IMAGES].

The VISUAL INDEX screen appears.

2 To search for movies, touch the [M] or [S] tab. To search for still images, touch the [I] tab.

3 Touch date on the screen.

The recording dates of images are displayed on the screen.

Return to the VISUAL INDEX screen

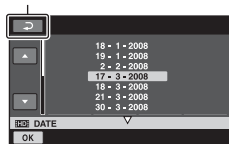

4 Touch ▲/▼ to select the date of the desired image, then touch [OK].

The images of the selected date are displayed on the VISUAL INDEX screen.

💡 Tips

- On the [Film Roll Index]/[Face Index] screen, you can use the Date Index function by following the steps 3 to 4.
-

Using PB zoom

You can magnify still images from about 1.1 to 5 times the original size. Magnification can be adjusted with the power zoom lever or the zoom buttons on the LCD frame.

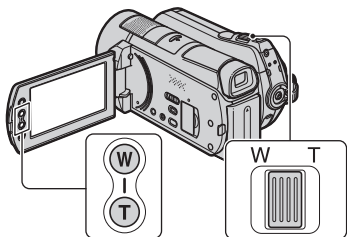

- ① Play back the still image you want to magnify.
- ② Magnify the still image with T (Telephoto).
The screen is framed.
- ③ Touch the screen at the point you want to display in the center of the displayed frame.
- ④ Adjust the magnification with W (Wide angle)/T (Telephoto).

To cancel, touch .

Playing back a series of still images (Slide show)

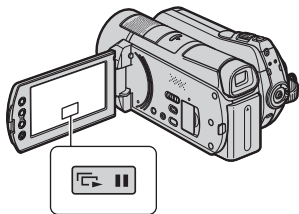

Touch  on the still image playback screen.

The slide show begins from the selected still image.





Touch  to stop the slide show.

To restart, touch  again.

Notes

- You cannot operate playback zoom during slide show.

Tips

- You can also play back the slide show by touching  (OPTION) →  tab → [SLIDE SHOW] on the VISUAL INDEX screen.
- You can set continuous slide show playback by selecting  (OPTION) →  tab → [SLIDE SHOW SET]. The default setting is [ON] (continuous playback).

Playing the image on a TV

Connection methods and quality of the image (HD (high definition)/SD (standard definition)) viewed on the TV screen differ depending on what type of TV is connected, and the connectors used.

Use the supplied AC Adaptor as the power source (p. 16).

Refer also to the instruction manuals supplied with the device to be connected.

⚙ Notes

- When recording, set [X.V.COLOR] to [ON] to play back on an x.v.Color-compliant TV (p. 70). Some settings may need to be adjusted on the TV when playing back. Refer to the instruction manual of your TV for details.

Operation flow

You can connect your camcorder to the TV easily following the instructions displayed on the LCD screen, [TV CONNECT Guide].

Switch the input on the TV to the connected jack.

Refer to the instruction manuals of the TV.



Connect your camcorder and TV referring to [TV CONNECT Guide].



Make the required output settings on your camcorder (p. 42).

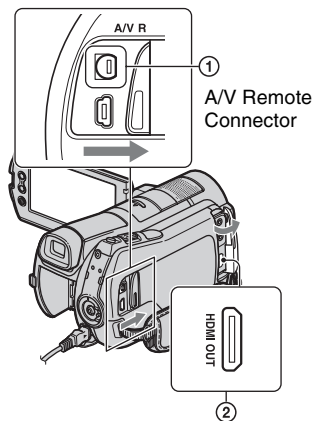
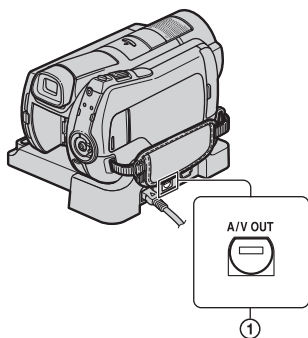





⚙ Notes

- Your camcorder and the Handycam Station are equipped with A/V Remote Connector or A/V OUT jack (p. 112, 115). Connect the A/V connecting cable or component A/V cable either to the Handycam Station or to your camcorder. If you connect A/V connecting cables or component A/V cable to both the Handycam Station and your camcorder at the same time, image disturbance may occur.

Selecting the most advantageous connection - TV CONNECT Guide

Your camcorder will advise you of the most advantageous way of connecting your TV.

- 1 Turn on your camcorder, and touch  (HOME) →  (OTHERS) → [TV CONNECT Guide].**

If the item is not on the screen, touch  /  to change the page.

- 2 Touch the answer to the question displayed on the screen.**

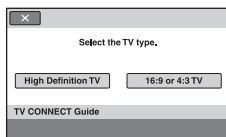

Meanwhile, you can make the relevant connection between your camcorder and the TV.

Connecting to a high definition TV

Images recorded with HD (high definition) image quality are played back with HD (high definition) image quality. Images recorded with SD (standard definition) image quality are played back with SD (standard definition) image quality.

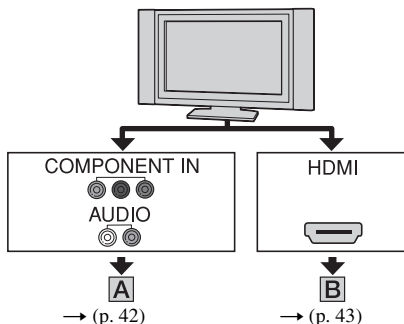

: Signal flow

Type	Camcorder	Cable	TV	HOME MENU setting
------	-----------	-------	----	-------------------

A



Component A/V cable (supplied)

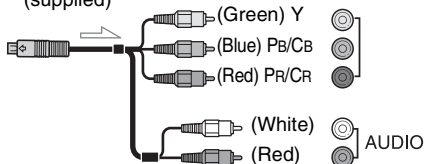

(SETTINGS) →
 [OUTPUT SETTINGS]
 → [COMPONENT] →
 [1080i/576i] (p. 79)

Notes

- If you connect only component video, audio signals are not output. Connect the white and red plugs to output audio signals.

Type	Camcorder	Cable	TV	HOME MENU setting
------	-----------	-------	----	-------------------

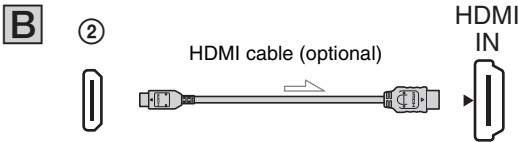

Notes

- Use an HDMI cable with the HDMI logo.
- Use an HDMI mini Connector on one end (for the camcorder), and a plug suitable for connection to your TV on the other end.
- Images are not output from the HDMI OUT jack of your camcorder, if copyright protection signals are recorded in the images.
- Some TVs may not function correctly (e.g., no sound or image) with this connection.
- Do not connect the HDMI OUT jack of your camcorder and HDMI OUT jack of the external device with the HDMI cable. This may cause a malfunction.
- When the connected device is compatible with 5.1ch surround sound, movies recorded with the HD (high definition) image quality are output on 5.1ch surround sound automatically. Movies recorded with the SD (standard definition) image quality are converted to 2ch sound.

Connecting to a non-high-definition 16:9 (wide) or 4:3 TV

Images recorded with HD (high definition) quality are converted to SD (standard definition) and played back. Images recorded with SD (standard definition) image quality are played back with SD (standard definition) image quality.

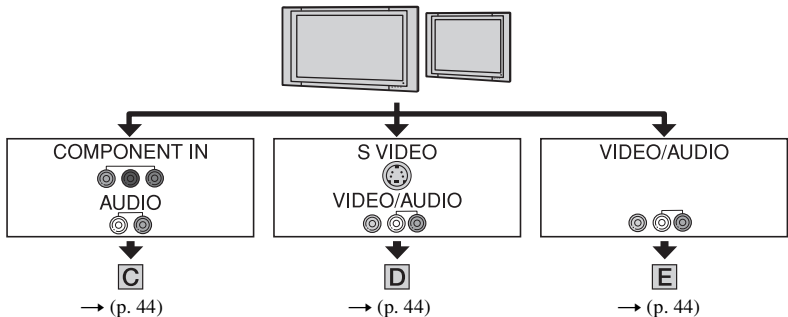

To set the horizontal to vertical ratio according to the connected TV (16:9/4:3)

Set [TV TYPE] to [16:9] or [4:3] according to your TV (p. 78).

Notes

- When you play back a movie recorded with SD (standard definition) image quality on a 4:3 TV that is not compatible with the 16:9 signal, touch **HOME** → **SETTINGS** → [MOVIE SETTINGS] → [WIDE SELECT] → [4:3] on your camcorder when recording an image (p. 69).

 : Signal flow

Type	Camcorder	Cable	TV	HOME MENU setting
------	-----------	-------	----	-------------------

C

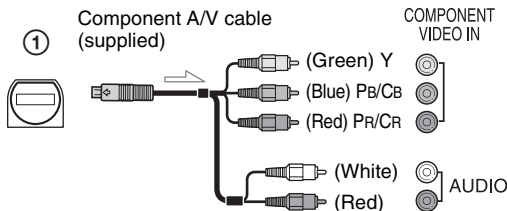

SETTINGS → [OUTPUT SETTINGS] → [COMPONENT] → [576i] (p. 79)

SETTINGS → [OUTPUT SETTINGS] → [TV TYPE] → [16:9]/[4:3]* (p. 78)

Notes

- If you connect only component video, audio signals are not output. Connect the white and red plugs to output audio signals.

D

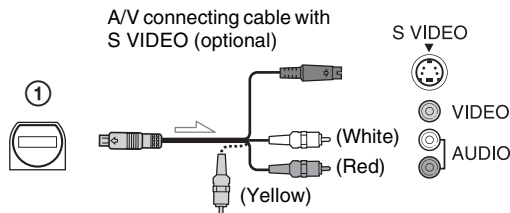

SETTINGS → [OUTPUT SETTINGS] → [TV TYPE] → [16:9]/[4:3]* (p. 78)

Notes

- When the S VIDEO plug (S VIDEO channel) is connected, audio signals are not output. To output audio signals, connect the white and red plugs to the audio input jack of your TV.
- This connection produces higher resolution images compared with the A/V connecting cable (Type **E**).

E

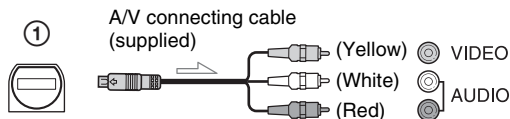

SETTINGS → [OUTPUT SETTINGS] → [TV TYPE] → [16:9]/[4:3]* (p. 78)

* Set [TV TYPE] according to your TV.

When connecting to your TV via a VCR

Connect your camcorder to the LINE IN input on the VCR using the A/V connecting cable. Set the input selector on the VCR to LINE (VIDEO 1, VIDEO 2, etc.).

When your TV is monaural (When your TV has only one audio input jack)

Connect the yellow plug of the A/V connecting cable to the video input jack and connect the white (left channel) or red (right channel) plug to the audio input jack of your TV or VCR.

If your TV/VCR has a 21-pin adaptor (EUROCONNECTOR)

Use the 21-pin adaptor supplied with your camcorder (For models with the **CE** mark printed on their bottom surfaces only). This adaptor is designed for output use only.

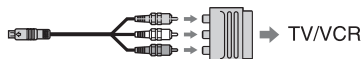

Notes

- When the A/V connecting cable is used to output images, images are output with SD (standard definition) image quality.

Tips

- If you connect your camcorder to the TV using more than one type of cable to output images, the order of priority of the TV input jacks is as follows:
HDMI → component → S VIDEO → video.
- HDMI (High Definition Multimedia Interface) is an interface to send both video/audio signals. The HDMI OUT jack outputs high quality images and digital audio.

On "PhotoTV HD"

Your camcorder is compatible with "PhotoTV HD." "PhotoTV HD" allows for highly-detailed, photo-like depiction of subtle textures and colors. By connecting Sony's PhotoTV HD-compatible devices using an HDMI cable* or a component A/V cable**, a whole new world of photos can be enjoyed in breathtaking full HD quality.

* The TV will automatically switch to the appropriate mode when displaying photos.

** Setup of the TV will be necessary. Please refer to the instruction manual of your PhotoTV HD-compatible TV for details.

Using "BRAVIA" Sync

You can do the playback operation with the remote commander of your TV by connecting your camcorder to a "BRAVIA" Sync compatible TV launched in 2008 or later with the HDMI cable.

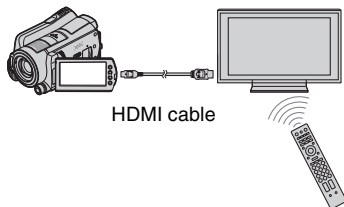



- 1 Connect your camcorder and a "BRAVIA" Sync compatible TV* with the HDMI cable (optional).

2 Turn on your camcorder.



The TV input is switched automatically, and the image of your camcorder is displayed on the TV.

3 Operate the remote commander of the TV.

You can do the following operations.

- Display  (VIEW IMAGES) of  (HOME) by pressing the SYNC MENU button
 - Display an INDEX screen, such as the VISUAL INDEX screen, by pressing up/down/left/right/enter buttons on the remote commander of your TV, and play back the desired movies or still images
-

Notes

- To set your camcorder, touch  (HOME) →  (SETTINGS) → [GENERAL SET] → [CTRL FOR HDMI] → [ON] (the default setting).
- Also set your TV. Refer to the instruction manual of the TV for details.

Tips

- If you turn off the TV, your camcorder is turned off simultaneously.

Saving images

The images are recorded on the media selected in the media setting (p. 22). Due to the limited capacity of the media, make sure that you save the image data to some type of external media such as a DVD-R or a computer.

💡 Tips

- You can dub/copy the images recorded on the hard disk to the “Memory Stick PRO Duo” with your camcorder (p. 52).

Saving images using a computer

By using “Picture Motion Browser” on the supplied CD-ROM, you can save the images recorded on your camcorder with HD (high definition) image quality or SD (standard definition) image quality.

You can rewrite movies with HD (high definition) image quality from the computer to your camcorder, if necessary. For details, see “PMB Guide.”

Creating a disc with One Touch (One Touch Disc Burn)

You can save images recorded on the hard disk of the camcorder directly to a DVD with ease by pressing the  (DISC BURN) button.

Saving images on a computer (Easy PC Back-up)

You can save images recorded on the camcorder on the hard disk of a computer.



Creating a disc with selected images

You can save images copied to your computer on a disc. You can also edit those images.

 Refer to the supplied “Operating Guide.”

Saving images by connecting your camcorder to other devices

Connecting with the A/V connecting cable

You can dub movies with SD (standard definition) image quality.

Connecting with the USB cable

You can dub movies with HD (high definition) image quality or SD (standard definition) image quality.



 See page 58.



(OTHERS) category

This category enables you to edit the images on the media. Also, you can enjoy your camcorder by connecting to other devices.

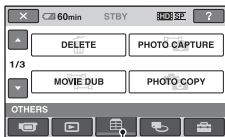

 (OTHERS) category

Item list

DELETE

You can delete images on the media (p. 49).

PHOTO CAPTURE

You can save a selected frame from a recorded movie as a still image (p. 51).

MOVIE DUB

You can dub movies recorded on the hard disk to a “Memory Stick PRO Duo” (p. 52).

PHOTO COPY

You can copy still images recorded on the hard disk to a “Memory Stick PRO Duo” (p. 53).

EDIT

You can edit the images (p. 54).

PLAYLIST EDIT

You can create and edit a Playlist (p. 55).

PRINT

You can print still images on a connected PictBridge printer (p. 60).

USB CONNECT

You can connect the camcorder to a computer etc., via the USB cable. See “Operating Guide” for connecting to the computer.

TV CONNECT Guide

Your camcorder helps you select the appropriate connection for your device (p. 40).

Deleting images

You can delete images recorded on the media using your camcorder.

Notes

- You cannot restore images once they are deleted.
- Do not remove the battery pack or the AC Adaptor from your camcorder while deleting the images. It may damage the media.
- Do not eject “Memory Stick PRO Duo” while deleting images from the “Memory Stick PRO Duo.”
- When write-protection is set to the images in the “Memory Stick PRO Duo” by another device, you cannot delete the images from the “Memory Stick PRO Duo.”

Tips

- You can select up to 100 images at one time.
- You can delete an image on the playback screen from **[OPTION]** MENU.
- To delete all images recorded in the media, and recover all the recordable space of the media, format the media (p. 63).

Deleting movies

You can free media space by deleting image data from the camcorder.

You can check the free media space using **[MEDIA INFO]** (p. 62).

Select the media which contains the movie you want to delete before the operation (p. 22).

Notes

- Important data should be saved on external media (p. 47).

1 Touch **[HOME]** → **[OTHERS]** → **[DELETE]**.

2 Touch **[DELETE]**.

3 Touch **[HDD] DELETE** or **[HSD] DELETE**.

4 Touch the movie to be deleted.



The selected movie is marked with ✓. Press and hold the movie on the LCD screen to confirm the movie. Touch **[RETURN]** to return to the previous screen.

5 Touch **[OK]** → **[YES]** → **[OK]**.

To delete all movies at one time

In step **3**, touch **[HDD] DELETE ALL**/ **[HSD] DELETE ALL** → **[YES]** → **[YES]** → **[OK]**.

To delete all the movies recorded on the same day at one time

① In step **3**, touch **[HDD] DELETE** by date/ **[HSD] DELETE** by date].

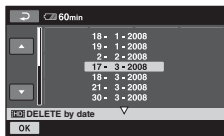

② Touch **[UP]** / **[DOWN]** to select the recording date of the desired movie, then touch **[OK]**.

The movies recorded on the selected date are displayed on the screen. Touch the movie on the LCD screen to confirm the movie. Touch **[RETURN]** to return to the previous screen.

③ Touch **[OK]** → **[YES]** → **[OK]**.

Notes

- If the deleted movie is included in the Playlist (p. 55), the movie added to the Playlist is deleted also from the Playlist.

Deleting still images

Select the media which contains the still image you want to delete before the operation (p. 22).

1 Touch **↑** (HOME) → **☰** (OTHERS) → [DELETE].

2 Touch [**🗑️** DELETE].

3 Touch [**🗑️** DELETE].

4 Touch the still image to be deleted.

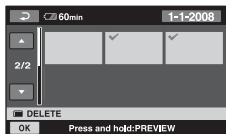

The selected still image is marked with



✓. Press and hold the still image on the LCD screen to confirm the still image.

Touch **↶** to return to the previous screen.

5 Touch **OK** → [YES] → **OK**.

To delete all still images at one time

In step 3, touch [**🗑️** DELETE ALL] → [YES] → [YES] → **OK**.

To delete all the still images recorded on the same day at one time

This function is available only when the internal hard disk is selected as the media.

① In step 3, touch [**🗑️** DELETE by date].

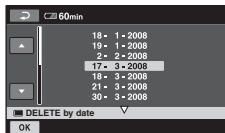

② Touch **▲** / **▼** to select the recording date of the desired still image, then touch **OK**.

The still images recorded on the selected date are displayed on the screen.

Touch the still image on the LCD screen to confirm the still image. Touch **↶** to return to the previous screen.

③ Touch **OK** → [YES] → **OK**.

Capturing a still image from a movie

You can save a selected frame from a recorded movie as a still image. Select the media which contains movies, and the media where you want to save still images before the operation (p. 22).

1 Touch (HOME) → (OTHERS) → [PHOTO CAPTURE].

The [PHOTO CAPTURE] screen appears.

2 Touch the movie to be captured.

The selected movie starts playback.

3 Touch at the point where you want to capture.

The movie pauses.

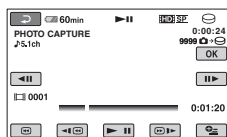



4 Touch .

The captured still image is saved on the media selected in [PHOTO MEDIA SET] (p. 22).

When capturing is finished, the screen returns to pause.



To continue capturing

Touch , then follow the steps 3 to 4. To capture a still image from another movie, touch  then follow the steps 2 to 4.

To finish capturing

Touch  → .

Notes

- The image size is fixed depending on the image quality of the movie:
 - [ 2.1M] with HD (high definition) image quality
 - [ 0.2M] in 16:9 (wide) with SD (standard definition) image quality
 - [VGA (0.3M)] in 4:3 with SD (standard definition) image quality
- The media where you want to save still images should have enough free space.
- The recording date and time of captured still images is the same as the recording date and time of the movies.
- If the movie you are capturing from has no data code, the recording date and time of the still image will be the date and time you captured from the movie.

Dubbing/copying images to a “Memory Stick PRO Duo” with your camcorder

Dubbing movies

You can dub movies recorded on the internal hard disk of your camcorder to a “Memory Stick PRO Duo.”

Insert a “Memory Stick PRO Duo” into your camcorder before the operation.

Notes

- When you record a movie on a “Memory Stick PRO Duo” for the first time, create the image database file by touching **HOME** → **MANAGE MEDIA** → **[REPAIR IMG.DB F.]** (p. 65).
- Connect your camcorder to the wall outlet (wall socket) using the supplied AC Adaptor to prevent your camcorder from running out of power during dubbing.

Tips

- The original movie will not be deleted after dubbing.
- All included images in a Playlist will be dubbed.
- The images recorded by this camcorder and stored onto the media are called “original.”

- 1 Touch **HOME** → **OTHERS** → **[MOVIE DUB]**.

The **[MOVIE DUB]** screen appears.

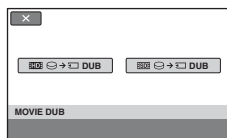

- 2 Touch the image quality of the movie to be dubbed.

[HD] DUB: To dub the movies with HD (high definition) image quality

[SD] DUB: To dub the movies with SD (standard definition) image quality

- 3 Touch the type of dubbing.

[DUB by select]: To select movies and dub

[DUB by date]: To dub all movies of a specified date

[HD DUB ALL]: To dub the Playlists with HD (high definition) image quality

[SD DUB ALL]: To dub the Playlists with SD (standard definition) image quality

When you select Playlist as the source of dubbing, follow the on-screen instructions to dub.

- 4 Select the movie to be dubbed.

[DUB by select]: Touch the movie to be dubbed. The selected movie is marked with ✓. You can select multiple movies.

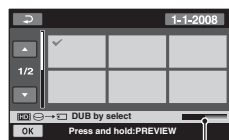

Remaining capacity of “Memory Stick PRO Duo”

Tips

- Press and hold the image on the LCD screen to confirm the image. Touch **[RETURN]** to return to the previous screen.

[DUB by date]: Select the recording date of the movie to be dubbed, then touch **[OK]**. You cannot select multiple dates.

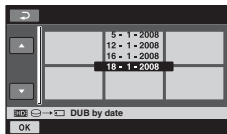

5 Touch **[OK]** → **[YES]**.

Dubbing starts.

💡 Tips

- To check the dubbed movies after dubbing is finished, select **[HDD] MEMORY STICK** / **[HSD] MEMORY STICK** on **[MOVIE MEDIA SET]** and play them back (p. 22).

Copying still images

You can copy still images from the internal hard disk of the camcorder to a "Memory Stick PRO Duo."

Insert a "Memory Stick PRO Duo" into your camcorder before the operation.

🔔 Notes

- Connect your camcorder to the wall outlet (wall socket) using the supplied AC Adaptor to prevent your camcorder from running out of power during copying.

1 Touch **↑** (**HOME**) → **[OTHERS]** → **[PHOTO COPY]**.

The **[PHOTO COPY]** screen appears.

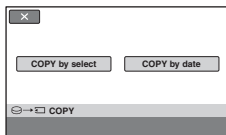

2 Touch the type of copying.

[COPY by select]: To select still images and copy

[COPY by date]: To copy all still images of a specified date

3 Select the still image to be copied.

[COPY by select]: Touch the still image to be copied. The selected still image is marked with **✓**. You can select multiple still images.

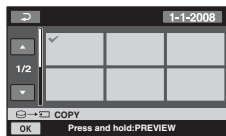

💡 Tips

- Press and hold the image on the screen to confirm the image. Touch **[↶]** to return to the previous screen.

[COPY by date]: Select the recording date of the still image to be copied, then touch **[OK]**. You cannot select multiple dates.

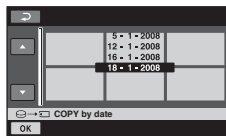

4 Touch **[OK]** → **[YES]**.



Copying starts.

Dividing a movie

Tips

- To check the copied still images after copying is finished, select [MEMORY STICK] on [PHOTO MEDIA SET] and play them back (p. 23).

Select the media which contains the movie you want to divide before the operation (p. 22).

1 Touch  (HOME) → 
(OTHERS) → [EDIT].

2 Touch [DIVIDE].

3 Touch the movie to be divided.

The selected movie starts playback.

4 Touch  at the point where you want to divide the movie into scenes.

The movie pauses.

Adjusts the dividing point with more precision after the dividing point has been selected with 

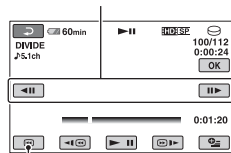

Returns to the beginning of the selected movie

Play and pause toggles as you press

.

5 Touch [OK] → [YES] → [OK].

Creating the Playlist

Notes

- You cannot restore movies once they are divided.
- Do not remove the battery pack or the AC Adaptor from your camcorder while dividing the movie. It may damage the media. Also, do not eject the “Memory Stick PRO Duo” while dividing movies on the “Memory Stick PRO Duo.”
- A slight difference may occur from the point where you touch  and the actual dividing point, as your camcorder selects the dividing point based on about half-second increments.
- If you divide the original movie, the movie added to the Playlist will also be divided.



The Playlist is a list showing thumbnails of the movies that you have selected.

The original movies are not changed even if you edit or delete the movies added to the Playlist.

Select the media you want to create, play, or edit a Playlist before the operation (p. 22).

Notes

- Images with HD (high definition) image quality and SD (standard definition) image quality are added to an individual Playlist.

1 Touch  (HOME) → 
(OTHERS) → [PLAYLIST EDIT].

2 Touch [] ADD] or [] ADD].

3 Touch the movie to be added to the Playlist.

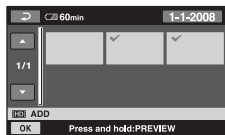

The selected movie is marked with ✓.

Press and hold the movie on the LCD screen to confirm the movie.

Touch  to return to the previous screen.

4 Touch [OK] → [YES] → [OK].

To add all the movies recorded on the same day at one time

- 1 In step 2, touch **[HDD] ADD by date**/ **[ESD] ADD by date**.
The recording dates of movies are displayed on the screen.

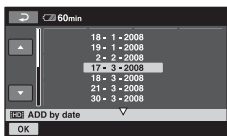

- 2 Touch **▲**/**▼** to select the recording date of the desired movie.
- 3 Touch **[OK]** while the selected recording date is highlighted.
The movies recorded on the selected date are displayed on the screen. Touch the movie on the LCD screen to confirm the movie. Touch **[◀]** to return to the previous screen.
- 4 Touch **[OK]** → **[YES]** → **[OK]**.

⚡ Notes

- Do not remove the battery pack or the AC Adaptor from your camcorder while adding to the Playlist. It may damage the media. Also, do not eject the "Memory Stick PRO Duo" while editing movies on the "Memory Stick PRO Duo."
- You cannot add still images to the Playlist.
- You cannot create a Playlist which contains both HD (high definition) image quality and SD (standard definition) image quality.

💡 Tips

- You can add a maximum of 999 movies with HD (high definition) image quality, or 99 movies with SD (standard definition) image quality to the Playlist.
- You can add a movie on the playback screen or the INDEX screen by touching **[OPTION]**.
- You can copy the Playlist to a disc as it is, by using the supplied software.

Playing the Playlist

Select the media you want to create, play, or edit a Playlist before the operation (p. 22).

- 1 Touch **▲** (HOME) → **[VIEW IMAGES]** → **[PLAYLIST]**.

The Playlist screen appears.



- 2 Touch the movie you want to play back.

The Playlist is played back from the selected movie to the end, then the screen returns to the Playlist screen.

To erase unnecessary movies from the Playlist

- 1 Touch **▲** (HOME) → **[OTHERS]** → **[PLAYLIST EDIT]**.
- 2 Touch **[HDD] ERASE**/ **[ESD] ERASE**.
To erase all the movies from the Playlist, touch **[HDD] ERASE ALL**/ **[ESD] ERASE ALL** → **[YES]** → **[YES]** → **[OK]**.
- 3 Select the movie to be erased from the list.





The selected movie is marked with ✓.

Press and hold the movie on the LCD screen to confirm the movie.

Touch  to return to the previous screen.

- ④ Touch  → [YES] → .

To change the order within the Playlist

- ① Touch  (HOME) →  (OTHERS) → [PLAYLIST EDIT].

- ② Touch [ MOVE]/[ MOVE].

- ③ Select the movie to be moved.

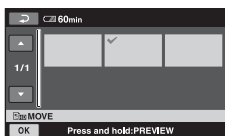



The selected movie is marked with ✓.

Press and hold the movie on the LCD screen to confirm the movie.

Touch  to return to the previous screen.

- ④ Touch .

- ⑤ Select the destination with  / .

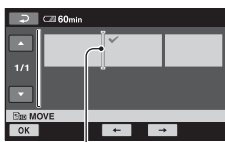

Destination bar

- ⑥ Touch  → [YES] → .

💡 Tips

- When you select multiple movies, the movies are moved following the order appearing in the Playlist.

Dubbing to other devices

Connecting with the A/V connecting cable

You can dub images played back on your camcorder to other recording devices, such as VCRs or DVD/HDD recorders. Connect the device in either of the following ways.

Connect your camcorder to the wall outlet (wall socket) using the supplied AC Adaptor for this operation (p. 16). Refer also to the instruction manuals supplied with the devices to be connected.

Select the media which contains the images you want to dub before the operation (p. 22).

Notes

- **Movies recorded with HD (high definition) image quality will be dubbed with SD (standard definition) image quality.**
- To copy a movie recorded with HD (high definition) image quality, install the application software (supplied) on your computer, and copy the images to a disc in the computer.
- Since dubbing is performed via analog data transfer, the image quality may deteriorate.

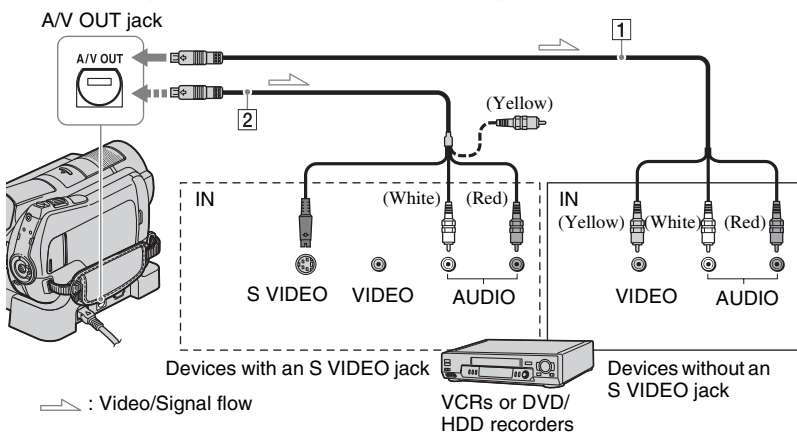

1 A/V connecting cable (supplied)

Your camcorder and the Handycam Station are equipped with A/V Remote Connector or A/V Remote Connector or A/V OUT jack (p. 112, 115). Connect the A/V connecting cable either to the Handycam Station or to your camcorder, depending on your setup.



2 A/V connecting cable with S VIDEO (optional)

When connecting to another device via the S VIDEO jack, by using an A/V connecting cable with an S VIDEO cable (optional), higher quality images

can be produced than with an A/V connecting cable. Connect the white and red plug (left/right audio) and the S VIDEO plug (S VIDEO channel) of the A/V connecting cable with an S VIDEO cable (optional). The yellow plug connection is not necessary. S VIDEO connection only will not output audio.

Notes

- You cannot dub to recorders connected with an HDMI cable.

- To hide the screen indicators (such as a counter, etc.) on the screen of the monitor device connected, touch  (HOME) →  (SETTINGS) → [OUTPUT SETTINGS] → [DISP OUTPUT] → [LCD PANEL] (the default setting) on the HOME MENU (p. 79). To record the date/time and camera settings data, display them on the screen (p. 75).
- When you are connecting your camcorder to a monaural device, connect the yellow plug of the A/V connecting cable to the video input jack, and the red (right channel) or the white (left channel) plug to the audio input jack on the device.

1 Turn on your camcorder, and press (VIEW IMAGES).

Set [TV TYPE] according to the display device (p. 78).

2 Insert the recording media in the recording device.

If your recording device has an input selector, set it to the input mode.

3 Connect your camcorder to the recording device (VCR or DVD/HDD recorder) with the A/V connecting cable (supplied) or an A/V connecting cable with S VIDEO (optional) .

Connect your camcorder to the input jacks of the recording device.

4 Start playback on your camcorder, and record it on the recording device.

Refer to the instruction manuals supplied with your recording device for details.

5 When dubbing is finished, stop the recording device, and then your camcorder.

Connecting with the USB cable

Connect your camcorder to a DVD writer, etc., compatible with movie dubbing via USB connection, to dub without image degradation.

Connect your camcorder to the wall outlet (wall socket) using the supplied AC Adaptor (p. 16). Refer also to the instruction manuals supplied with the device to be connected.

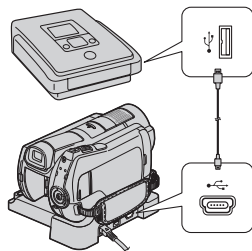

1 Turn on your camcorder.

2 Connect the (USB) jack of your camcorder and a DVD writer, etc., with the supplied USB cable (p. 112).

The [USB SELECT] screen appears automatically.

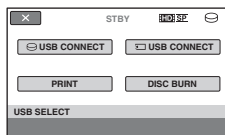

3 Touch [📶 USB CONNECT] or [📶 USB CONNECT] according to the media on which the movie you want to dub is recorded.

4 Operate the device to be connected, and start recording.

For details, refer to the instruction manuals supplied with the device to be connected.

5 After dubbing is complete, touch [END] → [YES], then disconnect the USB cable.

Attention

This camcorder captures high definition footage in the AVCHD format. High definition footage can be copied onto DVD media. However, DVD media containing AVCHD footage should not be used with DVD based players or recorders, as the DVD player/recorder may fail to eject the media and may erase its contents without warning. DVD media containing AVCHD footage may be played on a compatible Blu-ray Disc™ player/recorder or other compatible device.

💡 Tips

- If the [USB SELECT] screen does not appear, touch 🏠 (HOME) → 📁 (OTHERS) → [USB CONNECT].

Printing recorded still images (PictBridge compliant printer)

You can print out still images using a PictBridge compliant printer, without connecting the camcorder to a computer.

🔗 PictBridge

Connect your camcorder to the AC Adaptor to obtain power from the wall outlet (wall socket) (p. 16). Turn on the printer.

Select the media which contains the still image you want to print before the operation (p. 23).

To print still images on a “Memory Stick PRO Duo,” insert the “Memory Stick PRO Duo” containing them into your camcorder.

1 Connect the Handycam Station to the wall outlet (wall socket) using the supplied AC Adaptor.

2 Set the camcorder onto the Handycam Station securely, then turn on your camcorder.

3 Connect the ⚡ (USB) jack of the Handycam Station to the printer using the USB cable (p. 115).

[USB SELECT] appears on the screen automatically.

4 Touch [PRINT].

When connection is complete, 🔗 (PictBridge connecting) appears on the screen.

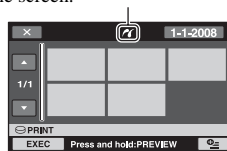

You can select a still image on the screen.

5 Touch the still image to be printed.

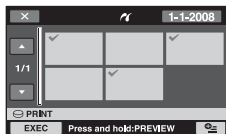

The selected still image is marked with ✓.

Press and hold the still image on the LCD screen to confirm the still image.

Touch  to return to the previous screen.

6 Touch , set the following options, then touch .

[COPIES]: Set the number of copies of a still image to be printed. You can set up to 20 copies.

[DATE/TIME]: Select [DATE], [DAY&TIME], or [OFF] (no date/time printed).

[SIZE]: Select the paper size.

If you do not change the setting, go to step 7.



7 Touch [EXEC] → [YES] → .

The still image selection screen appears again.

To finish printing

In step 4, touch  on the image selection screen.

Notes

- We can guarantee the operation of only models that are PictBridge compatible.
- Refer also to the instruction manual of the printer to be used.
- Do not attempt the following operations when  is on the screen. The operations may not be performed properly.
 - Operate the POWER switch
 - Press  (VIEW IMAGES)
 - Remove your camcorder from the Handycam Station
 - Disconnect the USB cable from your camcorder, the Handycam Station or the printer
 - Eject the “Memory Stick PRO Duo” from your camcorder while printing still images saved on the “Memory Stick PRO Duo”
- If the printer stops working, disconnect the USB cable, turn the printer off and on again, and restart the operation from the beginning.
- You can select only the paper sizes that the printer can print.
- On some printer models, the top, bottom, right, and left edges of images may be trimmed. If you print a still image recorded in a 16:9 (wide) ratio, the left and right ends of the still image may be trimmed widely.
- Some printer models may not support the date printing function. Refer to your printer’s instruction manual for details.
- The still images described below may not be printed out:
 - The still image edited by a computer
 - The still image recorded by other devices
 - The still image file exceeding 4 MB
 - The still image file larger than 3,680 × 2,760 pixels

Tips

- PictBridge is an industry standard established by the Camera & Imaging Products Association (CIPA). You can print still images without using a computer by connecting a printer directly to a digital video camera or digital still camera, regardless of model or manufacturer.
- You can print a still image on the still image playback screen from  (OPTION) MENU.

(MANAGE MEDIA) category

This category enables you to use the hard disk or a “Memory Stick PRO Duo” for various purposes.



 (MANAGE MEDIA) category

Item list

MOVIE MEDIA SET

You can select the media for movies (p. 22).

PHOTO MEDIA SET

You can select the media for still images (p. 23).

MEDIA INFO

You can display the media information such as the recordable time, etc. (p. 62).

MEDIA FORMAT

You can format the media and recover the recordable free space (p. 63).

REPAIR IMG.DB F.

You can repair the management information of the media (p. 65).

Checking the media information

You can check the remaining recordable time for each recording mode of the media selected on [MOVIE MEDIA SET] (p. 22), and the approximate free and used media space.

Notes

- During Easy Handycam operation, you cannot check the media information. Cancel Easy Handycam operation (p. 28).

Touch  (HOME) →  (MANAGE MEDIA) → [MEDIA INFO].

The remaining recordable time for each recording mode is displayed.

Tips

- You can check the recordable free space, etc. by touching  at the lower right on the screen.

To turn off the display

Touch .

Notes

- The calculation for media space is 1 MB = 1,048,576 bytes. The fractions less than MB are discarded when the media space is displayed. The displayed size of the whole hard disk space will be slightly smaller than the size shown below despite displaying both free and used hard disk space.
 - HDR-SR11E: 60,000 MB
 - HDR-SR12E: 120,000 MB
- Since there is a management file area, the used space is not displayed as 0 MB even if you perform [MEDIA FORMAT] (p. 63).

Tips

- Only the information of the media selected on [MOVIE MEDIA SET] is displayed. Change the media setting if necessary (p. 22).

Deleting all images (Formatting)

Formatting deletes all the images to recover recordable free space.

Connect your camcorder to the wall outlet (wall socket) using the supplied AC Adaptor for this operation (p. 16).

Notes

- To avoid the loss of important images, you should save them (p. 47) before performing [MEDIA FORMAT].
- While [MEDIA FORMAT] is activated, do not disconnect the AC Adaptor.

Formatting the hard disk

- 1 Touch **HOME** → **MANAGE MEDIA** → **[MEDIA FORMAT]** → **[HDD]**.

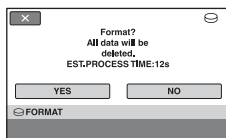

- 2 Touch **[YES]** → **[YES]**.

- 3 When **[Completed.]** appears, touch **[OK]**.

Formatting the “Memory Stick PRO Duo”

- 1 Insert the “Memory Stick PRO Duo” to be formatted into your camcorder.

- 2 Touch **HOME** → **(MANAGE MEDIA)** → **[MEDIA FORMAT]** → **[MEMORY STICK]**.

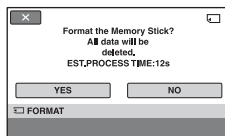



- 3 Touch **[YES]** → **[YES]**.

- 4 When **[Completed.]** appears, touch **[OK]**.





Notes

- While the ACCESS lamp is lit, do not eject the “Memory Stick PRO Duo” from your camcorder.
- Even the still images protected with another device against accidental deletion are also deleted.
- Do not attempt the following operations when [Executing...] is on the screen:
 - Operate the POWER switch or buttons
 - Remove the “Memory Stick PRO Duo”

Preventing data on the hard disk of the camcorder from being recovered

[ EMPTY] allows you to write unintelligible data onto the hard disk of the camcorder. In this way, it may become more difficult to recover any original data. When you dispose of or transfer the camcorder to others, it is recommended that you perform [ EMPTY].

Notes

- If you perform [ EMPTY], all the images are deleted. To avoid the loss of important images, they should be saved (p. 47) before performing [ EMPTY].
- You cannot perform [ EMPTY] unless you connect the AC Adaptor to the wall outlet (wall socket).
- Disconnect all cables except the AC Adaptor. Do not disconnect the AC Adaptor during the operation.
- While performing [ EMPTY], do not apply any vibrations or shocks to your camcorder.

1 Connect the AC Adaptor to the DC IN jack on the camcorder and the wall outlet (wall socket).

2 Turn on your camcorder.

3 Touch  (HOME) →  (MANAGE MEDIA) → [MEDIA FORMAT] → [HDD].

The [ EMPTY] screen appears.

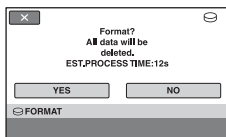

4 Press and hold  (back light) for a few seconds (p. 113).

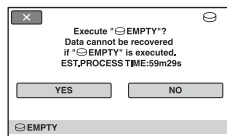

The [ EMPTY] screen appears.



5 Touch [YES] → [YES].

6 When [Completed.] appears, touch .

Notes

- The actual performing time for [ EMPTY] is as follows:
 - HDR-SR11E:
approx. 60 minutes
 - HDR-SR12E:
approx. 120 minutes
- If you stop performing [ EMPTY] while [Executing...] appears, be sure to complete the operation by performing [MEDIA FORMAT] or [ EMPTY] when you use the camcorder next time.

Repairing the image database file

This function checks the management information and the consistency of movies and still images in the media, and repairs any inconsistencies found.

- The image database files of the hard disk and the “Memory Stick PRO Duo” are repaired separately.

-
- 1 Touch **HOME** → **MANAGE MEDIA** → **[REPAIR IMG.DB F.]** → **[HDD]** or **[MEMORY STICK]**.

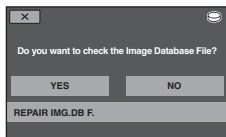

-
- 2 Touch **[YES]**.

The management file check starts.
Touch **[OK]** and quit the management file check if no inconsistency is found.

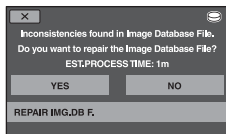

-
- 3 Touch **[YES]**.

-
- 4 After **[Completed.]** appears, touch **[OK]**.
-

Notes

- Do not apply mechanical shock or vibration to your camcorder, and do not remove the AC Adaptor or the battery pack during the operation.
- While repairing the image database file of the “Memory Stick PRO Duo,” do not eject the “Memory Stick PRO Duo.”

What you can do with the (SETTINGS) category of the HOME MENU

You can change the recording functions and the operating settings for your convenience.

Using the HOME MENU

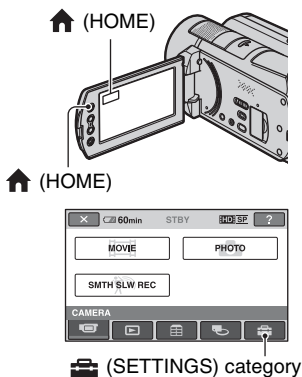

- 1 Turn on your camcorder, then press  (HOME).



- 2 Touch  (SETTINGS).



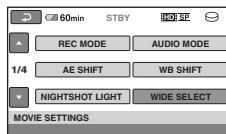

- 3 Touch the desired setup item.

If the item is not on the screen, touch  /  to change the page.



- 4 Touch the desired item.

If the item is not on the screen, touch  /  to change the page.

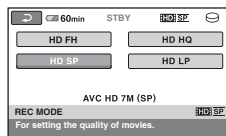

- 5 Change the setting, then touch .

List of the (SETTINGS) category items

MOVIE SETTINGS (p. 68)





Items	Page
REC MODE	68
AUDIO MODE	69
AE SHIFT	69
WB SHIFT	69
NIGHTSHOT LIGHT	69
WIDE SELECT	69
DIGITAL ZOOM	70
STEADYSHOT	70
AUTO SLW SHUTTR	70
X.V.COLOR	70
GUIDEFAME	70
ZEBRA	71
 REMAINING SET	71
SUB-T DATE	71
FLASH MODE*	71
FLASH LEVEL	72
REDEYE REDUC	72
DIAL SETTING	72
FACE DETECTION	72
 INDEX SET*	72
CONVERSION LENS	75

PHOTO SETTINGS (p. 73)

Items	Page
 IMAGE SIZE*	73
FILE NO.	74
AE SHIFT	69
WB SHIFT	69
NIGHTSHOT LIGHT	69
STEADYSHOT	70
GUIDEFAME	70

Items	Page
ZEBRA	71
FLASH MODE*	71
FLASH LEVEL	72
REDEYE REDUC	72
DIAL SETTING	72
FACE DETECTION	72
CONVERSION LENS	73

VIEW IMAGES SET (p. 75)

Items	Page
DATA CODE	75
 DISPLAY	76

SOUND/DISP SET** (p. 77)

Items	Page
VOLUME*	77
BEEP*	77
LCD BRIGHT	77
LCD BL LEVEL	77
LCD COLOR	77
VF B.LIGHT	77

OUTPUT SETTINGS (p. 78)

Items	Page
TV TYPE	78
DISP OUTPUT	79
COMPONENT	79

CLOCK/ LANG (p. 79)

Items	Page
CLOCK SET*	20
AREA SET	79
SUMMERTIME	79
 LANGUAGE SET*	79

MOVIE SETTINGS

(Items for recording movies)

GENERAL SET (p. 80)

Items	Page
DEMO MODE	80
REC LAMP	80
CALIBRATION	109
A.SHUT OFF	80
QUICK ON STBY	80
REMOTE CTRL	80
DROP SENSOR	81
CTRL FOR HDMI	81

* You can set these items also during Easy Handycam operation (p. 25).

**The menu name is changed to [SOUND SETTINGS] during Easy Handycam operation.



Touch ①, then ②.

If the item is not on the screen, touch ▲/▼ to change the page.

How to set

🏠 (HOME MENU) → page 66

☰ (OPTION MENU) → page 82

The default settings are marked with ►.

REC MODE (Recording mode)



You can select a recording mode to record a movie with HD (high definition) image quality from 4 levels.

HD FH (HD FH)

Records in the highest quality mode (AVC HD 16M (FH)).

HD HQ (HD HQ)

Records in high quality mode (AVC HD 9M (HQ)).

► HD SP (HD SP)

Records in standard quality mode (AVC HD 7M (SP)).

HD LP (HD LP)

Increases the recording time (Long Play) (AVC HD 5M (LP)).

You can select a recording mode to record a movie with SD (standard definition) image quality from 3 levels.

SD HQ (SD HQ)

Records in high quality mode (SD 9M (HQ)).

► SD SP ()

Records in standard quality mode
(SD 6M (SP)).

SD LP ()

Increases the recording time (Long Play)
(SD 3M (LP)).

Notes

- If you record in the LP mode, the quality of movies may be degraded, or scenes with quick movements may appear with block noise when you play back the image.

Tips

- See pages 11 and 24 for the expected recording time of each recording mode.
- You can select the [REC MODE] for each media separately.

AUDIO MODE

You can change the recording sound format.

► 5.1ch SURROUND ()

Records sound in 5.1ch surround.



2ch STEREO ()

Records sound in 2ch stereo.



Notes

- 2ch appears temporarily regardless of the setting when you play back movies recorded on the setting; [RECORD SOUND] to [OFF] of [SMTH SLW REC].

AE SHIFT



Select [ON] to adjust the exposure using  (dark)/ (bright).  and the setting value appear on the screen (The default setting is [OFF]).

Tips

- Touch  if the subject is white or the backlight is bright, or touch  if the subject is black or the light is dim.
- You can adjust the automatic exposure level to brighter or darker when [EXPOSURE] is set to [AUTO].

- You can also adjust the setting manually using the CAM CTRL dial (p. 34).

WB SHIFT (White Balance Shift)

Select [ON] to adjust the white balance to the desired setting using /.  and the setting value appear on the screen (The default setting is [OFF]).

Tips

- When the white balance is set to a lower value, images appear bluish, and when set to a higher value, images appear reddish.
- You can also adjust the setting manually using the CAM CTRL dial (p. 34).

NIGHTSHOT LIGHT

When using either the NightShot (p. 32) or [SUPER NIGHTSHOT] (p. 87) function to record, you can record clearer images by setting [NIGHTSHOT LIGHT], which emits infrared light (invisible), to [ON] (the default setting).

Notes

- Do not cover the infrared port with your fingers or other objects (p. 32).
- Remove the conversion lens (optional).
- The maximum shooting distance using [NIGHTSHOT LIGHT] is about 3 m (10 feet).

WIDE SELECT

When recording with SD (standard definition) image quality, you can select the horizontal to vertical ratio according to the TV connected. Refer also to the instruction manuals supplied with your TV.

► 16:9 WIDE

Records images to the full screen on a 16:9 (wide) TV screen.

4:3 ()

Records images to the full screen on a 4:3 TV screen.

Notes

- Set [TV TYPE] correctly according to the TV connected for playback (p. 78).

DIGITAL ZOOM

You can select the maximum zoom level in case you want to zoom to a level greater than 12 × during recording. Note that the image quality decreases when you use the digital zoom.

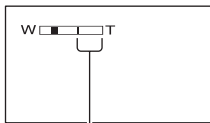

The right side of the bar shows the digital zooming factor. The zooming zone appears when you select the zooming level.

▶ OFF

Up to 12 × zoom is performed optically.

24 ×

Up to 12 × zoom is performed optically, and after that, up to 24 × zoom is performed digitally.

150 ×

Up to 12 × zoom is performed optically, and after that, up to 150 × zoom is performed digitally.

STEADYSHOT

You can compensate for camera shake (the default setting is [ON]). Set [STEADYSHOT] to [OFF] (🚫) when using a tripod (optional), then the image becomes natural.

AUTO SLW SHUTTR (Auto Slow Shutter)

When recording in dark places, the shutter speed is automatically reduced to 1/25 second (The default setting is [ON]).

X.V.COLOR

When recording, set to [ON] to capture wider range of colors. Various colors such as the brilliant color of flowers and turquoise blue of the sea can be more faithfully reproduced.

Notes

- Set [X.V.COLOR] to [ON] when the recorded content will be played back on an x.v.Color-compliant TV.
- If the movie recorded with this function [ON] is played back on a non-x.v.Color-compliant TV, the color may not be reproduced correctly.
- [X.V.COLOR] cannot be set to [ON]:
 - While recording with SD (standard definition) image quality
 - While recording a movie

Tips

- The LCD screen is compatible with x.v.Color.

GUIDEFAME

You can display the frame and check that the subject is horizontal or vertical by setting [GUIDEFAME] to [ON]. The frame is not recorded. Press DISP/BATT INFO to make the frame disappear (The default setting is [OFF]).

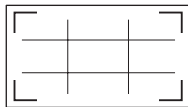

Tips

- Positioning the subject at the cross point of the guide frame makes a balanced composition.
- The outer frame of [GUIDEFAME] shows the display area of a TV which is not compatible with full pixel display.

ZEBRA



Diagonal stripes appear in portions of the screen where brightness is at a preset level. This is useful as a guide when adjusting the brightness. When you change the default setting,  is displayed. The zebra pattern is not recorded.

► OFF

The zebra pattern is not displayed.

70

The zebra pattern appears at a screen brightness level of about 70 IRE.

100

The zebra pattern appears at a screen brightness level of about 100 IRE or higher.

Notes

- Portions of the screen where brightness is about 100 IRE or above may appear overexposed.

Tips

- IRE represents the screen brightness.

REMAINING SET





► ON

Always displays the remaining media indicator.

AUTO

Displays the remaining recording time of movies for about 8 seconds in situations such as those described below.

- When your camcorder recognizes the remaining media capacity while the  (Movie) lamp lights up
- When you press DISP/BATT INFO to switch the indicator from off to on while the  (Movie) lamp lights up
- When you select the movie recording mode on the HOME MENU

Notes

- When the remaining recordable time for movies is less than 5 minutes, the indicator stays on the screen.

SUB-T DATE (Subtitle date)



When you set to [ON] (the default setting), you can display the recording date and time while playing back the image recorded on your camcorder, on devices compatible with the subtitle display function. Refer also to the instruction manual of the display device.

Notes

- The images recorded with HD (high definition) image quality can be played back only on AVCHD format compatible devices.
- [SUB-T DATE] cannot be set for SD (standard definition) image quality.

FLASH MODE



You can select the flash setting when you record still images with the built-in flash or an external flash (optional) that is compatible with your camcorder.

► AUTO

Automatically flashes when there is insufficient ambient light.

ON ()

Always uses the flash regardless of the surrounding brightness.

OFF ()

Records without flash.

Notes

- The recommended distance to the subject when using the built-in flash is approximately 0.3 to 2.5 m (1 to 8 feet).
- Remove any dust from the surface of the flash before using it. Flash effect may be impaired if heat discoloration or dust obscures the lamp.
- The  /CHG (charge) lamp flickers while charging the flash, and remains lit when the battery charge is complete.

- If you use the flash in bright places such as when shooting a backlit subject, the flash may not be effective.

FLASH LEVEL

You can set this function when you use the built-in flash, or an external flash (optional) that is compatible with your camcorder.

HIGH(++)

Makes the flash level higher.

▶ NORMAL(±)

LOW(+-)

Makes the flash level lower.

REDEYE REDUC

You can set this function when you record still images using the built-in flash or an external flash (optional) that is compatible with your camcorder.

When you set [REDEYE REDUC] to [ON], then set [FLASH MODE] to [AUTO] or [ON],  appears. You can prevent redeye by activating the pre-flash before the flash flashes.

Notes

- The redeye reduction may not produce the desired effect due to individual differences and other conditions.

DIAL SETTING

You can select an item you want to set to the CAM CTRL dial. For details, see page 34.

FACE DETECTION

Detects faces and adjusts the focus, color and exposure automatically. Also, optimizes the face image.

▶ ON ()

Detects a face and shows a frame on it. The detected face image is optimized automatically.

Face detection frame

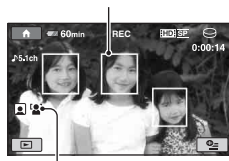

Face detection mark

ON[NO FRAMES] ()

Detects a face without showing a frame. The detected face image is optimized automatically.

OFF

Does not use [FACE DETECTION] function.



Notes

- Faces may not be detected depending on recording conditions.
- [FACE DETECTION] may not function properly depending on recording conditions. Set [FACE DETECTION] to [OFF] in this case.

INDEX SET

The default setting is [ON], allowing you to search for faces automatically and to display the [Face Index] screen (p. 37).

Face icons and their meanings

- : When the setting is [ON]
- : This icon flashes when your camcorder detects a face. The icon stops flashing when the face is recorded in [Face Index].
- : This icon appears when faces cannot be recorded in [Face Index].*

* The number of faces that can be detected is limited.

CONVERSION LENS



When using a conversion lens (optional), use this function to record using the optimum compensation for camera shake for each lens.

You can select [WIDE CONVERSION] (W) or [TELE CONVERSION] (T). The default setting is [OFF].

PHOTO SETTINGS

(Items for recording still images)



Touch ①, then ②.

If the item is not on the screen, touch ▲/▼ to change the page.

How to set

🏠 (HOME MENU) → page 66

⊕ (OPTION MENU) → page 82

The default settings are marked with ►.

IMAGE SIZE



► 10.2M (L10.2M)

Records still images in the highest quality (3,680 × 2,760).

7.6M (L7.6M)

Records still images in the highest quality in the 16:9 (wide) ratio (3,680 × 2,070).

6.1M (L6.1M)

Records still images clearly (2,848 × 2,136).

1.9M (L1.9M)

Allows you to record more still images in relatively clear quality (1,600 × 1,200).

VGA (0.3M) (LVGA)

Allows the maximum number of still images to be recorded (640 × 480).

🔗 Notes

- The selected image size is effective while the 📷 (still) lamp is lit.

Capacity of the “Memory Stick PRO Duo” and the number of recordable still images (Unit: number of images)*

When the POWER switch is 
(Still)

	10.2M 3680 × 2760 
1GB	230
2GB	475
4GB	930
8GB	1900

* The number of recordable still images shown is for the maximum image size of your camcorder. The actual number of recordable still images is displayed on the LCD screen during recording (p. 117).

Notes

- When using a “Memory Stick PRO Duo” made by Sony Corporation. The number of recordable still images varies depending on the recording conditions or type of “Memory Stick.”
- You can record up to 9,999 still images on the hard disk.
- The unique pixel array of Sony’s ClearVid CMOS sensor and image processing system (BIONZ) allows for still image resolution equivalent to the sizes described.

Tips

- You can also use a “Memory Stick Duo” with a capacity of under 1 GB for recording still images.

FILE NO. (File number) 

► SERIES

Assigns file numbers of still images in sequence even if the “Memory Stick PRO Duo” is replaced with another one. The file number is reset when a new folder is created or the recording folder is replaced with another.

RESET

Assigns file numbers in sequence, following the largest file number existing on the current recording medium.

AE SHIFT  

See page 69.

WB SHIFT (White Balance Shift)  

See page 69.

NIGHTSHOT LIGHT 

See page 69.

STEADYSHOT 

See page 70.

GUIDEFAME 

See page 70.

ZEBRA 

See page 71.

FLASH MODE  

See page 71.

FLASH LEVEL 

See page 72.

REDEYE REDUC

See page 72.

DIAL SETTING

See page 72.

FACE DETECTION

See page 72.

CONVERSION LENS

See page 73.

VIEW IMAGES SET

(Items to customize the display)



Touch ①, then ②.

If the item is not on the screen, touch ▲/▼ to change the page.

How to set

🏠 (HOME MENU) → page 66

⊕ (OPTION MENU) → page 82

The default settings are marked with ►.

DATA CODE



During playback, displays the information (data code) recorded automatically at the time of recording.

► OFF

Data code is not displayed.

DATE/TIME

Displays the date and time.

CAMERA DATA

Displays camera setting data.

DATE/TIME

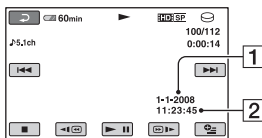

① Date

② Time

CAMERA DATA

Movie

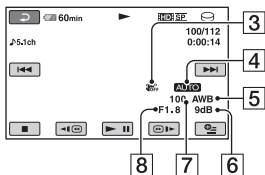

Still image

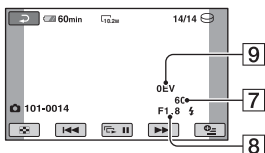

- 3 SteadyShot off
- 4 Brightness
- 5 White balance
- 6 Gain
- 7 Shutter speed
- 8 Aperture value
- 9 Exposure

💡 Tips

-  appears for an image recorded using a flash.
- The data code is displayed on the TV screen if you connect your camcorder to a TV.
- The indicator toggles through the following sequences as you press DATA CODE on the Remote Commander: [DATE/TIME] → [CAMERA DATA] → [OFF] (no indication).
- Depending on the media condition, bars [--:--:--] appear.

DISPLAY

You can select the number of thumbnails that appear on the VISUAL INDEX screen.

Thumbnail  Glossary (p. 120)

▶ ZOOM LINK

Change the number of thumbnails (6 or 12) with the power zoom lever on your camcorder.*

6IMAGES

Displays thumbnails of 6 images.

12IMAGES

Displays thumbnails of 12 images.

* You can also operate with the zoom buttons on the LCD frame or on the Remote Commander.

SOUND/DISP SET

(Items to adjust the sound and the screen)



Touch ①, then ②.

If the item is not on the screen, touch ▲/▼ to change the page.

How to set

🏠 (HOME MENU) → page 66

☰ (OPTION MENU) → page 82

The default settings are marked with ►.

VOLUME



Touch \square / \square to adjust the volume (p. 37).

BEEP



► ON

A melody sounds when you start/stop recording, or operate the touch panel.

OFF

Cancels the melody.

LCD BRIGHT



You can adjust the brightness of the LCD screen with \square / \square .

① Adjust the brightness with \square / \square .

② Touch \square .

💡 Tips

- This adjustment does not affect the recorded images in any way.

LCD BL LEVEL (LCD back light level)



You can adjust the brightness of the LCD screen's backlight.

► NORMAL

Standard brightness.

BRIGHT

Brightens the LCD screen.

💡 Notes

- When you connect your camcorder to the wall outlet (wall socket) using the supplied AC Adaptor, [BRIGHT] is automatically selected for the setting.
- When you select [BRIGHT], battery life is slightly reduced during recording.
- If you open the LCD panel 180 degrees to face the screen outside and close the LCD panel to the camcorder body, the setting becomes [NORMAL] automatically.

💡 Tips

- This adjustment does not affect the recorded images in any way.

LCD COLOR



You can adjust the color of the LCD screen with \square / \square .



Low intensity ← High intensity

💡 Tips

- This adjustment does not affect the recorded images in any way.

VF B. LIGHT



You can adjust the brightness of the viewfinder.

► NORMAL

Standard brightness.

BRIGHT

Brightens the viewfinder screen.

OUTPUT SETTINGS

(Items for when connecting other devices)

Notes

- When you connect your camcorder to outside power sources, [BRIGHT] is automatically selected for the setting.
- When you select [BRIGHT], battery life is slightly reduced during recording.

Tips

- This adjustment does not affect the recorded images in any way.

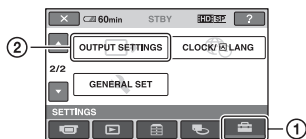

Touch ①, then ②.

If the item is not on the screen, touch ▲/▼ to change the page.

How to set

🏠 (HOME MENU) → page 66

⊕= (OPTION MENU) → page 82

The default settings are marked with ►.

TV TYPE



You need to convert the signal depending on the TV connected when playing back the image. The recorded images are played back as following illustrations.

► 16:9

Select this to view your images on a 16:9 (wide) TV.

16:9 (wide) images

4:3 images



4:3

Select this to view your images on a 4:3 standard TV.

16:9 (wide) images

4:3 images



Notes

- Horizontal to vertical ratio of the image recorded with HD (high definition) image quality is 16:9.

CLOCK/ LANG

(Items to set clock and language)

DISP OUTPUT

► LCD PANEL

Shows displays such as the time code in the viewfinder and on the LCD screen.

V-OUT/PANEL

Shows displays such as the time code in the viewfinder, on the TV screen and LCD screen.

COMPONENT

Select [COMPONENT] when connecting your camcorder to a TV with the component input jack.

576i



Select when connecting your camcorder to a TV with the component input jack.

► 1080i/576i

Select when connecting your camcorder to a TV that has the component input jack and is capable of displaying the 1080i signal.



Touch ①, then ②.

If the item is not on the screen, touch /
 to change the page.

How to set

 (HOME MENU) → page 66



 (OPTION MENU) → page 82

CLOCK SET

See page 20.

AREA SET

You can adjust a time difference without stopping the clock.

Set your local area using / when using your camcorder in other time zones. Refer to the world time difference on page 103.

SUMMERTIME

You can change this setting without stopping the clock.

Set to [ON] to move the time forward 1 hour.

LANGUAGE SET

You can select the language to be used on the LCD screen.

Tips

- Your camcorder offers [ENG[SIMP]] (simplified English) for when you cannot find your native tongue among the options.

GENERAL SET

(Other setup items)

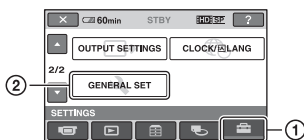

Touch ①, then ②.

If the item is not on the screen, touch / to change the page.

How to set

(HOME MENU) → page 66

(OPTION MENU) → page 82

The default settings are marked with .

DEMO MODE

The default setting is [ON], allowing you to view the demonstration in about 10 minutes, after you turn the POWER switch to (Movie).

Tips

- The demonstration will be suspended in situations such as those described below.
 - When you press START/STOP or PHOTO
 - When you touch the screen during the demonstration (The demonstration starts again after about 10 minutes)
 - When you set the POWER switch to (Still)
 - When you press (HOME) or (VIEW IMAGES)

REC LAMP (Recording lamp)

The camera recording lamp on the front of your camcorder lights up, as the default setting is [ON].

CALIBRATION

See page 109.

A.SHUT OFF (Auto shut off)

5 min

The camcorder is automatically turned off when you do not operate your camcorder for more than approximately 5 minutes.

NEVER

The camcorder is not automatically turned off.

Notes

- When you connect your camcorder to a wall outlet (wall socket), [A.SHUT OFF] is automatically set to [NEVER].

QUICK ON STBY (Quick on standby)

You can set the time that you want the camcorder to remain on before turning off in sleep mode (p. 32). The default setting is [10min].

Notes

- [A.SHUT OFF] does not work during sleep mode.

REMOTE CTRL (Remote control)

The default setting is [ON], allowing you to use the supplied Remote Commander (p. 116).

Tips

- Set to [OFF] to prevent your camcorder from responding to a command sent by another VCR remote control unit.

DROP SENSOR



When the drop sensor has detected that the camcorder has been dropped, your camcorder may not allow you to record and play back correctly to protect the internal hard disk, as the default setting is [ON]. When dropping is detected,  appears.

Notes

- Set the drop sensor to [ON] when you use the camcorder. Otherwise, if you drop the camcorder, you may damage the internal hard disk.
- In a non-gravity situation, the drop sensor activates. When you record images during an activity such as roller-coasting or skydiving, you can set [DROP SENSOR] to [OFF] () so as not to activate the drop sensor.

CTRL FOR HDMI (Control for HDMI)



The default setting is [ON], allowing you to do the playback operation with the remote commander of your TV by connecting your camcorder to a “BRAVIA” Sync compatible TV with the HDMI cable (p. 45).

Activating functions using the OPTION MENU

The  (OPTION) MENU appears just like the pop-up window that appears when you right-click the mouse on a computer. Various available functions are displayed.

Using the OPTION MENU

- 1 While using your camcorder, touch  on the screen.

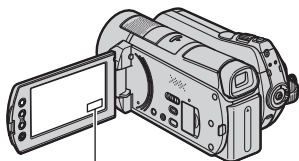

 (OPTION)



Tab

- 2 Touch the desired item.

If you cannot find the desired item, touch another tab to change the page.

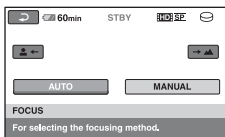





If you cannot find the item anywhere, the function does not work under the current situation.

- 3 Change the setting, then touch .

Notes











- The tabs and items that appear on the screen depend on the recording/playback status of your camcorder at the time.
- Some items appear without a tab.
- The  (OPTION) MENU cannot be used during Easy Handycam operation.

Recording items on the OPTION MENU

Items	 *	Page
 tab		
FOCUS	–	84
SPOT FOCUS	–	84
TELE MACRO	–	84
EXPOSURE	–	85
SPOT METER	–	85
AE SHIFT	○	69
SCENE SELECTION	–	85
WHITE BAL.	–	86
WB SHIFT	○	69
COLOR SLOW SHTR	–	87
SUPER NIGHTSHOT	–	87
 tab		
FADER	–	87
D.EFFECT	–	88
PICT.EFFECT	–	88
 tab		
REC MODE	○	68
BLT-IN ZOOM MIC	–	88
MICREF LEVEL	–	88
 IMAGE SIZE	○	73
SELF-TIMER	–	88
FLASH MODE	○	71
TIMING	–	33
RECORD SOUND	–	33

* Items that are included also in the HOME MENU.

Viewing items on the OPTION MENU

Items	 *	Page
 tab		
DELETE	○	49
DELETE by date	○	49
DELETE ALL	○	49
 tab		
DIVIDE	○	54
ERASE ALL	○	56
MOVE	○	57
-- (The tab depends on the situation/No tab)		
 ADD**	○	56
 ADD**	○	56
 ADD by date**	○	56
 ADD by date**	○	56
PRINT	○	60
SLIDE SHOW	–	39
VOLUME	○	77
DATA CODE	○	75
SLIDE SHOW SET	–	39
 ADD	○	55
 ADD	○	55
 ADD by date	○	56
 ADD by date	○	56
COPIES	–	60
DATE/TIME	–	60
SIZE	–	60
ERASE	○	56

* Items that are included also in the HOME MENU.

** Items that are included also in the HOME MENU, but the item names are different.

Functions set in the OPTION MENU

Items you can set only on the  (OPTION) MENU will be described below.

The default settings are marked with .



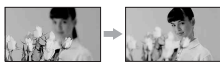

FOCUS

You can adjust the focus manually. You can select this function also when you want to focus on a certain subject intentionally.



① Touch [MANUAL].

 appears.

② Touch  (focusing on close subjects)/  (focusing on distant subjects) to sharpen the focus.  appears when the focus cannot be adjusted any closer, and  appears when the focus cannot be adjusted farther away.

③ Touch [OK].

To adjust the focus automatically, touch [AUTO] → [OK] in step ①.

Notes

- The minimum possible distance between camcorder and subject while maintaining sharp focus is about 1 cm (about 13/32 in.) for wide angle and about 80 cm (about 2 5/8 feet) for telephoto.

Tips

- It is easier to focus on the subject by moving the power zoom lever towards T (telephoto) to adjust the focus, then towards W (wide angle) to adjust the zoom for recording. When you want to record a subject at close range, move the power zoom lever to W (wide angle), then adjust the focus.
- The focal distance information (distance at which the subject is focused on, if it is dark and focus adjustment is difficult) appears for a few seconds in the following cases (This information will not display correctly if an optional conversion lens is being used).
 - When the focus mode is switched from automatic to manual
 - When you set focus manually

- You can also adjust the focus manually using the CAM CTRL dial (p. 34).

SPOT FOCUS

You can select and adjust the focal point to aim it at a subject not located at the center of the screen.

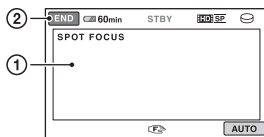

① Touch the subject on the screen.

 appears.

② Touch [END].

To adjust the focus automatically, touch [AUTO] → [END] in step ①.

Notes

- If you set [SPOT FOCUS], [FOCUS] is automatically set to [MANUAL].

TELE MACRO

This is useful to shoot small subjects, such as flowers or insects. You can blur out backgrounds and the subject stands out clearer.

When you set [TELE MACRO] to [ON] () , the zoom (p. 31) moves to the top of the T (telephoto) side automatically and allows recording subjects at a close distance down to about 47 cm (18 5/8 in.).



To cancel, touch [OFF], or zoom to wide-angle (W side).

Notes

- When recording a distant subject, focusing may be difficult and can take some time.
- Adjust the focus manually ([FOCUS], p. 84) when it is hard to focus automatically.

EXPOSURE



You can fix the brightness of a picture manually. Adjust the brightness when the subject is too bright or too dark.

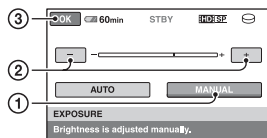

- ① Touch [MANUAL].
————— appears.
- ② Adjust the exposure by touching [—]/[+].
- ③ Touch [OK].

To return the setting to automatic exposure, touch [AUTO] → [OK] in step ①.

💡 Tips

- You can also adjust the setting manually using the CAM CTRL dial (p. 34).

SPOT METER (Flexible spot meter)



You can adjust and fix the exposure to the subject, so that it is recorded in suitable brightness even when there is strong contrast between the subject and the background, such as subjects in the spotlight on stage.

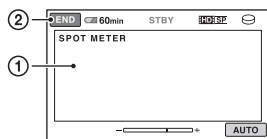

- ① Touch the point where you want to fix and adjust the exposure on the screen.
————— appears.
- ② Touch [END].

To return the setting to automatic exposure, touch [AUTO] → [END] in step ①.

📌 Notes

- If you set [SPOT METER], [EXPOSURE] is automatically set to [MANUAL].

SCENE SELECTION



You can record images effectively in various situations.

▶ AUTO

Select to automatically record images effectively without the [SCENE SELECTION] function.

TWILIGHT* (🌙)

Select to maintain the darkening atmosphere of the distant surroundings in twilight scenes.



TWILIGHT PORT. (👤)

Select to take a subject in the foreground against a night view.



CANDLE (🕯)

Select to maintain the dim atmosphere of a candlelit scene.



SUNRISE&SUNSET* (🌅)

Select to reproduce the atmosphere of scenes such as sunsets or sunrises.



FIREWORKS* (💣)

Select to take spectacular shots of fireworks.



LANDSCAPE* (🌄)

Select to shoot distant subjects clearly. This setting also prevents your camcorder from focusing on glass or metal mesh in windows between the camcorder and the subject.



PORTRAIT (Soft portrait) (👤)

Select to bring out the subject such as people or flowers while creating a soft background.



SPOTLIGHT** (👤)

Select to prevent people's faces from appearing excessively white when subjects are lit by strong light.



BEACH** (🏖️)

Select to take the vivid blue of the ocean or a lake.



SNOW** (❄️)

Select to take bright pictures of a white landscape.



* Adjusted to focus on subjects farther away only.

** Adjusted not to focus on subjects a short distance away.

🔊 Notes

- If you set [SCENE SELECTION], [WHITE BAL.] setting is canceled.

- Even if you set [TWILIGHT PORT.] while the 📷 (Still) lamp is lit, the setting changes to [AUTO] once the 🎬 (Movie) lamp lights up.

WHITE BAL. (White balance)



You can adjust the color balance to the brightness of the recording environment.

▶ AUTO

The white balance is adjusted automatically.

OUTDOOR (☀️)

The white balance is appropriately adjusted for the following recording conditions:

- Outdoors
- Night views, neon signs and fireworks
- Sunrise or sunset
- Under daylight fluorescent lamps

INDOOR (🏠)

The white balance is appropriately adjusted for the following recording conditions:



- Indoors
- At party scenes or studios where the lighting conditions change quickly
- Under video lamps in a studio, or under sodium lamps or incandescent-like color lamps

ONE PUSH (📷)

The white balance will be adjusted according to the ambient light.

- ① Touch [ONE PUSH].
- ② Frame a white object such as a piece of paper, to fill the screen under the same lighting conditions as you will shoot the subject.
- ③ Touch [📷].
📷 flashes quickly. When the white balance has been adjusted and stored in the memory, the indicator stops flashing.

Notes

- Set [WHITE BAL.] to [AUTO] or adjust the color in [ONE PUSH] under white or cool white fluorescent lamps.
- When you select [ONE PUSH], keep framing white objects while  is flashing quickly.
-  flashes slowly if [ONE PUSH] could not be set.
- When [ONE PUSH] was selected, if  keeps flashing after touching [OK], set [WHITE BAL.] to [AUTO].
- If you set [WHITE BAL.], [SCENE SELECTION] is set to [AUTO].

Tips

- If you have changed the battery pack while [AUTO] was selected, or taken your camcorder outdoors after inside use (or vice versa), select [AUTO] and aim your camcorder at a nearby white object for about 10 seconds for better color balance adjustment.
- When the white balance has been set with [ONE PUSH], if you change the [SCENE SELECTION] settings, or bring your camcorder outdoors from inside the house, or vice versa, you need to redo the [ONE PUSH] procedure to readjust the white balance.

COLOR SLOW SHTR (Color Slow Shutter)



When you set [COLOR SLOW SHTR] to [ON],  appears, and you can record an image brighter in color even in dark places.

To cancel, touch [OFF].

Notes

- Adjust the focus manually ([FOCUS], p. 84) when it is hard to focus automatically.
- The shutter speed of your camcorder changes depending on the brightness, which may result in a slowdown of the motion of the image.

SUPER NIGHTSHOT



The image will be recorded at a maximum of 16 times the sensitivity of NightShot recording if you set [SUPER NIGHTSHOT] to [ON] while the

NIGHTSHOT switch (p. 32) is also set to ON.

 appears on the screen.

To cancel, touch [OFF].

Notes

- Do not use [SUPER NIGHTSHOT] in bright places. This may cause a malfunction.
- Do not cover the infrared port with your fingers or other objects (p. 32).
- Remove any conversion lens (optional).
- Adjust the focus manually ([FOCUS], p. 84) when it is hard to focus automatically.
- The shutter speed of your camcorder changes depending on the brightness, which may result in a slowdown of the motion of the image.

FADER



You can record a transition with the following effects adding to the interval between scenes.

- ① Select the desired effect in [STBY] (to fading in) or [REC] (to fading out) mode, then touch [OK].
- ② Press START/STOP.

The fader indicator stops flashing and disappears when the fade is complete.

To cancel the fader before starting the operation, touch [OFF] in step ①. If you press START/STOP, the setting is canceled.



WHITE FADER



BLACK FADER



D.EFFECT (Digital effect)



When you select [OLD MOVIE],  appears and you can add an old movie effect to images.

To cancel [D.EFFECT], touch [OFF].

PICT.EFFECT (Picture effect)



You can add special effects to an image during recording.  appears.

▶ OFF

Does not use [PICT.EFFECT] setting.

SEPIA

Images appear in sepia.

B&W (Black and white)

Images appear in black and white.

PASTEL



Images appear as a pale pastel drawing.

BLT-IN ZOOM MIC (Built-in zoom microphone)



When you set [BLT-IN ZOOM MIC] to [ON] () you can record a movie with directional sound as you move the power zoom lever or press the zoom buttons on the LCD frame (The default setting is [OFF]).

MICREF LEVEL (Microphone reference level)



You can select the microphone level for recording sound.

Select [LOW] when you want to record an exciting and powerful sound in a concert hall, etc.

▶ NORMAL

Records various surround sounds, converting them into the appropriate level.

LOW (↑↓)

Records surround sound faithfully. This setting is not suitable for recording conversations.

SELF-TIMER



 appears when [SELF-TIMER] is set to [ON].

Press PHOTO to start the count down. A still image is recorded after about 10 seconds.

To cancel the recording, touch [RESET].

To cancel the self-timer, select [OFF].

Tips

- You can also operate by pressing PHOTO on the Remote Commander (p. 116).

Troubleshooting

If you run into any problems using your camcorder, use the following table to troubleshoot the problem. If the problem persists, disconnect the power source and contact your Sony dealer.

- Overall operations/Easy Handycam operation/Remote Commander 89
- Batteries/Power sources 90
- Viewfinder/LCD screen 91
- “Memory Stick PRO Duo” 91
- Recording 92
- Playing back images 94
- Playing back images stored on a “Memory Stick PRO Duo” on other devices 95
- Editing images on your camcorder 95
- Viewing on the TV 95
- Dubbing/Connecting to other devices 96
- Functions that cannot be used simultaneously 96

Notes before sending your camcorder for repair

- Your camcorder may be required to initialize or change the current hard disk of the camcorder, depending on the problem. In the event of this, the data stored on the hard disk will be deleted. Be sure to save the data on the internal hard disk (p. 47) onto other media (backup) before sending your camcorder for repair. We will not compensate you for any loss of hard disk data.
- During repair, we may check a minimum amount of data stored on the hard disk in order to investigate the problem. However, your Sony dealer will neither copy nor retain your data.

Overall operations/Easy Handycam operation/Remote Commander

The power does not turn on.

- Attach a charged battery pack to the camcorder (p. 16).
- The plug of the AC Adaptor has been disconnected from the wall outlet (wall socket). Connect it to the wall outlet (wall socket) (p. 16).
- Set the camcorder onto the Handycam Station securely (p. 16).

The camcorder does not operate even when the power is set to on.

- It takes a few seconds for your camcorder to be ready to shoot after the power is turned on. This is not a malfunction.
- Disconnect the AC Adaptor from the wall outlet (wall socket) or remove the battery pack, then reconnect it after about 1 minute. If the functions still do not work, press the RESET button (p. 114) using a pointed object (If you press the RESET button, all settings, including the clock setting, are reset).
- The temperature of your camcorder is extremely high. Turn off your camcorder and leave it for a while in a cool place.
- The temperature of your camcorder is extremely low. Leave your camcorder with the power of your camcorder on. Turn off your camcorder and take it to a warm place. Leave the camcorder there for a while, then turn on your camcorder.

Buttons do not work.

- During Easy Handycam operation, the following buttons/functions are not available.
 -  (back light) button (p. 33)
 - CAM CTRL dial (p. 34)
 - Playback zoom (p. 39)
 - To turn on and off the LCD backlight (Pressing and holding the DISP/BATT INFO button for a few seconds) (p. 21)



The (OPTION) button is not displayed.



- The OPTION MENU cannot be used during Easy Handycam operation.

The menu settings have changed automatically.

- During Easy Handycam operation, nearly all the menu items will be automatically set to the default settings.
- During Easy Handycam operation, some menu items are fixed as follows.
 - [REC MODE]: [HD SP] or [SD SP]
 - [DATA CODE]: [DATE/TIME]
- The following menu items return to the default settings when you set the POWER switch to OFF (CHG) for more than 12 hours.
 - [FOCUS]
 - [SPOT FOCUS]
 - [EXPOSURE]
 - [SPOT METER]
 - [SCENE SELECTION]
 - [WHITE BAL.]
 - [COLOR SLOW SHTR]
 - [SUPER NIGHTSHOT]
 - [BLT-IN ZOOM MIC]
 - [MICREF LEVEL]
 - [DROP SENSOR]

Even if you press EASY, menu settings do not switch to their defaults automatically.

- During Easy Handycam operation, settings for the following menu items are maintained the ones before Easy Handycam operation.
 - [MOVIE MEDIA SET]
 - [PHOTO MEDIA SET]
 - [AUDIO MODE]
 - [WIDE SELECT]
 - [X.V.COLOR]
 - [SUB-T DATE]
 - [FLASH MODE]
 - [DIAL SETTING]
 - [ INDEX SET]
 - [CONVERSION LENS]
 - [ IMAGE SIZE]

- [FILE NO.]
- [ DISPLAY]
- [VOLUME]
- [BEEP]
- [TV TYPE]
- [COMPONENT]
- [CLOCK SET]
- [AREA SET]
- [SUMMERTIME]
- [ LANGUAGE SET]
- [DEMO MODE]
- [CTRL FOR HDMI]

Your camcorder gets warm.

- This is because the power has been turned on for a long time. This is not a malfunction.

The supplied Remote Commander does not function.

- Set [REMOTE CTRL] to [ON] (p. 80).
- Insert a battery into the battery holder with the +/- polarities correctly matching the +/- marks (p. 116).
- Remove any obstructions between the Remote Commander and the remote sensor.
- Point the remote sensor away from strong light sources such as direct sunlight or overhead lighting. Otherwise, the Remote Commander may not function properly.

Another DVD device malfunctions when you use the supplied Remote Commander.

- Select a commander mode other than DVD 2 for your DVD device, or cover the sensor of your DVD device with black paper.

Batteries/Power sources

The power abruptly turns off.

- Use the AC Adaptor.
- In the default setting, when approximately 5 minutes have elapsed while you do not operate your camcorder, the camcorder is automatically turned off (A.SHUT OFF).

Change the setting of [A.SHUT OFF] (p. 80), or turn on the power again.

- When the time selected in [QUICK ON STBY] has elapsed during sleep mode, the camcorder is automatically turned off (p. 80). Turn on the power again.
- Charge the battery pack (p. 16).

The $\frac{1}{2}$ /CHG (charge) lamp does not light while the battery pack is being charged.

- Turn the POWER switch to OFF (CHG) (p. 16).
- Attach the battery pack to the camcorder correctly (p. 16).
- Connect the power cord (mains lead) to the wall outlet (wall socket) properly.
- The battery charge is completed (p. 16).
- Set the camcorder onto the Handycam Station securely (p. 16).

The $\frac{1}{2}$ /CHG (charge) lamp flashes while the battery pack is being charged.

- Attach the battery pack to the camcorder correctly (p. 16). If the problem persists, disconnect the AC Adaptor from the wall outlet (wall socket) and contact your Sony dealer. The battery pack may be damaged.

The remaining battery time indicator does not indicate the correct time.

- The temperature of the environment is too high or too low. This is not a malfunction.
- The battery pack has not been charged enough. Fully charge the battery again. If the problem persists, replace the battery pack with a new one (p. 16).
- The indicated time may not be correct depending on the environment of use.

The battery pack is quickly discharged.

- The temperature of the environment is too high or low. This is not a malfunction.

- The battery pack has not been charged enough. Fully charge the battery again. If the problem persists, replace the battery pack with a new one (p. 16).

Viewfinder/LCD screen

Menu items are grayed out.

- You cannot select grayed items in the current recording/playback situation.
- There are some functions you cannot activate simultaneously (p. 96).

The buttons do not appear on the touch panel.

- Touch the LCD screen lightly.
- Press DISP/BATT INFO on your camcorder (or DISPLAY on the Remote Commander) (p. 21, 116).

The buttons on the touch panel do not work correctly or do not work at all.

- Adjust the touch panel ([CALIBRATION]) (p. 109).

The image in the viewfinder is not clear

- Move the viewfinder lens adjustment lever until the image appears clearly (p. 22).

The image in the viewfinder has disappeared.

- Close the LCD panel. No image is displayed in the viewfinder when the LCD panel is open (p. 22).

“Memory Stick PRO Duo”

You cannot operate functions using the “Memory Stick PRO Duo.”

- If you use a “Memory Stick PRO Duo” formatted on a computer, format it again on your camcorder (p. 63).

You cannot delete images stored on or format the “Memory Stick PRO Duo.”

- The maximum number of still images that you can delete on the index screen at one time is 100.
- You cannot delete the still images protected on another device.



The data file name is not indicated correctly or flashes.

- The file is damaged.
- The file format is not supported by your camcorder (p. 105).

Recording

Refer also to “Memory Stick PRO Duo” (p. 91).

Pressing START/STOP or PHOTO does not record images.

- The playback screen is displayed. Set the POWER switch to  (Movie) or  (Still) (p. 30).
- You cannot record images in sleep mode. Press QUICK ON (p. 32).
- Your camcorder is recording the image you have just shot on the media. You cannot make new recording during this period.
- The media is full. Delete unnecessary images (p. 49).
- Total number of movie scenes or still images exceeds the recordable capacity of the media (p. 11). Delete unnecessary images (p. 49).
- While [DROP SENSOR] is activated (p. 81), you may not record movies/still images.
- The temperature of your camcorder is extremely high. Turn off your camcorder and leave it for a while in a cool place.

- The temperature of your camcorder is extremely low. Turn off your camcorder and take it to a warm place. Leave the camcorder there for a while, then turn on the camcorder.

You cannot record a still image.

- You cannot record a still image together with:
 - [SMTH SLW REC]
 - [FADER]
 - [D.EFFECT]
 - [PICT.EFFECT]

The ACCESS lamp remains lit or flashing even when you stop recording.

- Your camcorder is recording the scene you have just shot on the media.

The recording angle looks different.

- The recording angle may look different depending on the condition of your camcorder. This is not a malfunction.

The flash does not work.

- You cannot record with the flash while:
 - Capturing still images while shooting a movie
 - If a conversion lens (optional) is attached
- Even if auto flash or  (Auto redeye reduction) is selected, you cannot use the internal flash with:
 - NightShot
 - [SUPER NIGHTSHOT]
 - [TWILIGHT], [CANDLE], [SUNRISE&SUNSET], [FIREWORKS], [LANDSCAPE], [SPOTLIGHT], [BEACH] or [SNOW] in [SCENE SELECTION]
 - [MANUAL] in [EXPOSURE]
 - [SPOT METER]

The actual recording time for movies is less than the expected approximate recording time of the media.

- Depending on the recording conditions, the time available for recording may be shorter, for example when recording a fast moving object, etc. (p. 11, 24).

The recording stops.

- The temperature of your camcorder is extremely high. Turn off your camcorder and leave it for a while in a cool place.
- The temperature of your camcorder is extremely low. Turn off your camcorder and take it to a warm place. Leave the camcorder there for a while, then turn on the camcorder.
- If you keep applying vibration on the camcorder, recording may stop.

There is a time difference between the point where you press START/STOP and the point that the recorded movie starts/stops.

- On your camcorder, there may be a slight time difference between the point where you press START/STOP and the actual point that recording movie starts/stops. This is not a malfunction.

The horizontal to vertical ratio of the movie (16:9 (wide)/4:3) cannot be changed.

- The horizontal to vertical ratio of the movie recorded with HD (high definition) image quality is 16:9 (wide).

The auto focus does not function.

- Set [FOCUS] to [AUTO] (p. 84).
- The recording conditions are not suitable for auto focus. Adjust the focus manually (p. 84).

[STEADYSHOT] does not function.

- Set [STEADYSHOT] to [ON] (p. 70).
- [STEADYSHOT] may not be able to compensate for excessive vibrations.

The subjects passing by the screen very fast appear crooked.

- This is called the focal plane phenomenon. This is not a malfunction. Because of the way the image device (CMOS sensor) reads out image signals, the subjects passing by the lens rapidly might appear crooked depending on the recording conditions.

Tiny spots in white, red, blue, or green appear on the screen.

- The spots appear when you are recording with [SUPER NIGHTSHOT] or [COLOR SLOW SHTR]. This is not a malfunction.

The color of the image is not correctly displayed.

- Set the NIGHTSHOT switch to OFF (p. 32).

The screen image is bright, and the subject does not appear on the screen.

- Set the NIGHTSHOT switch to OFF (p. 32).

The screen image is dark, and the subject does not appear on the screen.

- Press and hold DISP/BATT INFO for a few seconds to turn on the backlight (p. 21).

Horizontal stripes appear on the images.

- This occurs when recording images under a fluorescent lamp, sodium lamp, or mercury lamp. This is not a malfunction.

[SUPER NIGHTSHOT] cannot be operated.

- Set the NIGHTSHOT switch to ON.

[COLOR SLOW SHTR] does not operate correctly.



- [COLOR SLOW SHTR] may not operate correctly in total darkness. Use NightShot or [SUPER NIGHTSHOT].

You cannot adjust [LCD BL LEVEL].

- You cannot adjust [LCD BL LEVEL] when:
 - The LCD panel is closed on your camcorder with the LCD screen facing out.
 - The power is supplied from the AC Adaptor.

Playing back images

Images cannot be played back.

- Select the media and the image quality of a movie you want to play back by touching  (HOME) →  (MANAGE MEDIA) → [MOVIE MEDIA SET]/[PHOTO MEDIA SET] (p. 22).

Still images cannot be played back.

- Still images cannot be played back if you have modified files or folders, or have edited the data on a computer. (The file name flashes in that case.) This is not a malfunction (p. 106).
- Still images recorded on other devices may not be played back. This is not a malfunction (p. 106).

“?” is indicated on an image in the VISUAL INDEX screen.

- This may appear on still images recorded on other devices, edited on a computer, etc.
- You removed the AC Adaptor or the battery pack before the ACCESS lamp is turned off after recording. This may damage your image data and [?] is displayed.

“” is indicated on an image in the VISUAL INDEX screen.

- Execute [REPAIR IMG.DB F.] (p. 65). If it still appears, delete the image with  (p. 49).

No sound or only a quiet sound is heard during playback.

- Turn up the volume (p. 37).
- Sound is not output when the LCD screen is closed. Open the LCD screen.
- When you record sound with [MICREF LEVEL] (p. 88) set to [LOW], the recorded sound may be difficult to hear.
- Sounds cannot be recorded while shooting a 3-second movie (approx.) using [SMTH SLW REC].

Left and right sound will be heard unbalanced when playing back on computers or other devices.

- This happens when sound recorded in 5.1ch surround is converted to 2ch (normal stereo sound) by a computer or other device (p. 31). This is not a malfunction.
- Change the sound conversion type (downmix type) when playing back on 2ch stereo devices. Refer to the instruction manual supplied with your playback device for details.
- Change the sound to 2ch when creating a disc using the supplied software “Picture Motion Browser.”
- Record sound with [AUDIO MODE] set to [2ch STEREO] (p. 69).

Playing back images stored on a "Memory Stick PRO Duo" on other devices

Images cannot be played back or the "Memory Stick PRO Duo" is not recognized.

- You cannot play back a movie recorded with HD (high definition) image quality on a "Memory Stick PRO Duo" on a device that is not compatible with AVCHD format.

Editing images on your camcorder

Unable to edit.

- Unable to edit because of the condition of the image.

Images cannot be added in the Playlist.

- There is no free space in the media.
- You can add no more than 999 movies with HD (high definition) image quality, or 99 movies with SD (standard definition) image quality, to a Playlist. Erase unnecessary movies from the Playlist (p. 56).
- You cannot add still images in the Playlist.

A movie cannot be divided.

- A movie that is too short cannot be divided.
- A movie protected on another device cannot be divided.

A still image cannot be captured from a movie.

- The media where you want to save still images is full.

Viewing on the TV

You cannot view the image or hear the sound on the TV.

- When you are using the component A/V cable, set [COMPONENT] according to the requirements of the connected device (p. 79).
- When you are using the component video plug, make sure the red and white plugs of the A/V connecting cable are connected (p. 42, 43).
- Images are not output from the HDMI OUT jack, if copyright protection signals are recorded in the images.
- When you are using the S VIDEO plug, make sure the red and white plugs of the A/V connecting cable are connected (p. 43).

The top, bottom, right, and left edges of images may be trimmed slightly when you play back on a connected TV.

- The LCD screen of your camcorder can display recording images across the entire screen (full pixel display). However, this may cause slight trimming of the top, bottom, right, and left edges of images when played back on a TV which is not compatible with full pixel display.
- It is recommended you record images using the outer frame of [GUIDEFAME] (p. 70) as a guide.

The image appears distorted on the 4:3 TV.

- This happens when viewing an image recorded in the 16:9 (wide) mode on a 4:3 TV. Set [TV TYPE] correctly (p. 78) and play back the image.

Black bands appear at the top and bottom of the screen of the 4:3 TV.

- This happens when viewing an image recorded in the 16:9 (wide) mode on a 4:3 TV. This is not a malfunction.

Dubbing/Connecting to other devices

You cannot dub correctly.

- You cannot dub images using the HDMI cable.
- The A/V connecting cable is not connected properly. Make sure to connect to the input jack of another device (p. 40).

Functions that cannot be used simultaneously

The following list shows examples of unworkable combinations of functions and menu items.

Cannot use	Because of following settings
Backlight	[SPOT METER], [FIREWORKS], [MANUAL] in [EXPOSURE]
[SCENE SELECTION]	NightShot, [COLOR SLOW SHTR], [SUPER NIGHTSHOT], [FADER], [OLD MOVIE], [TELE MACRO]
[SPOT METER]	NightShot, [SUPER NIGHTSHOT]
[EXPOSURE]	NightShot, [SUPER NIGHTSHOT]
[WHITE BAL.]	NightShot, [SUPER NIGHTSHOT]
[ONE PUSH] in [WHITE BAL.]	[SMTH SLW REC]
[SPOT FOCUS]	[SCENE SELECTION]
[SUPER NIGHTSHOT]	[FADER], [D.EFFECT]
[COLOR SLOW SHTR]	[FADER], [D.EFFECT], [SCENE SELECTION]

Cannot use	Because of following settings
[FADER]	[COLOR SLOW SHTR], [SUPER NIGHTSHOT], [D.EFFECT], [CANDLE], [FIREWORKS]
[D.EFFECT]	[COLOR SLOW SHTR], [SUPER NIGHTSHOT], [FADER], [SCENE SELECTION], [PICT.EFFECT]
[OLD MOVIE]	[SCENE SELECTION], [PICT.EFFECT]
[PICT.EFFECT]	[OLD MOVIE]
[TELE MACRO]	[SCENE SELECTION]
[AUTO SLW SHUTTR]	[SMTH SLW REC], [SCENE SELECTION], [COLOR SLOW SHTR], [SUPER NIGHTSHOT], [FADER], [D.EFFECT]
[AE SHIFT]	[FIREWORKS], [MANUAL] in [EXPOSURE]
[WIDE SELECT]	[OLD MOVIE]

Cannot use	Because of following settings
[FACE DETECTION]	NightShot, [SMTH SLW REC], [DIGITAL ZOOM], [FOCUS], [SPOT FOCUS], [EXPOSURE], [SPOT METER], [TWILIGHT], [TWILIGHT PORT.], [CANDLE], [SUNRISE&SUNSET], [FIREWORKS], [LANDSCAPE], [SPOTLIGHT], [BEACH], [SNOW], [WHITE BAL.], [COLOR SLOW SHTR], [SUPER NIGHTSHOT], [D.EFFECT], [PICT.EFFECT]
[DISP OUTPUT]	[CTRL FOR HDMI]
[MICREF LEVEL]	[BLT-IN ZOOM MIC]

Self-diagnosis display/Warning indicators

If indicators appear in the viewfinder or on the LCD screen, check the following.

If the problem persists even after you have tried to fix a couple of times, contact your Sony dealer or local authorized Sony service facility.

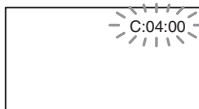

C:(or E:) □□:□□ (Self-diagnosis display)

C:04:□□

- The battery pack is not an “InfoLITHIUM” battery pack (H series). Use an “InfoLITHIUM” battery pack (H series) (p.106).
- Connect the DC plug of the AC Adaptor to the DC IN jack of the Handycam Station or your camcorder securely (p.16).

C:13:□□ / C:32:□□

- Remove the power source. Reconnect it and operate your camcorder again.

E:20:□□ / E:31:□□ / E:61:□□ / E:62:□□ / E:91:□□ / E:94:□□

- A malfunction that you cannot service has occurred. Contact your Sony dealer or local authorized Sony service facility. Inform them of the 5-digit code, which starts from “E”.

101-0001 (Warning indicator pertaining to files)

Slow flashing

- The file is damaged.
- The file is unreadable.

(Warning on the hard disk of the camcorder)*

Fast flashing

- An error may have occurred with the hard disk drive in your camcorder.

(Warning on the hard disk of the camcorder)*

Fast flashing

- The hard disk of the camcorder is full.
- An error may have occurred with the hard disk drive in your camcorder.

(Battery level warning)

Slow flashing

- The battery pack is nearly used up.
- Depending on the operating environment or battery conditions,  may flash, even if there are approximately 20 minutes remaining.

(High temperature warning)

Slow flashing

- The temperature of your camcorder is getting higher. Turn off your camcorder and leave it for a while in a cool place.

Fast flashing*

- The temperature of your camcorder is extremely high. Turn off your camcorder and leave it for a while in a cool place.

(Low temperature warning)*

Fast flashing

- The temperature of your camcorder is extremely low. Make the camcorder warm.

 **(Warning indicator pertaining to “Memory Stick PRO Duo”)**

Slow flashing

- Free space for recording images are running out. For the type of “Memory Stick” you can use with your camcorder, see page 2.
- No “Memory Stick PRO Duo” is inserted (p. 23).

Fast flashing

- There are not enough free space for recording images. Delete unnecessary images, or format the “Memory Stick PRO Duo” after storing the images on other media (p. 47, 49, 63).
- The Image Database File is damaged (p. 65).

 **(Warning indicators pertaining to “Memory Stick PRO Duo” formatting)***

- The “Memory Stick PRO Duo” is damaged.
- The “Memory Stick PRO Duo” is not formatted correctly (p. 63, 105).

 **(Warning indicator pertaining to incompatible “Memory Stick Duo”)***

- An incompatible “Memory Stick Duo” is inserted (p. 105).

 **(Warning indicator pertaining to the write-protect of the “Memory Stick PRO Duo”)***

- Access to the “Memory Stick PRO Duo” was restricted on another device.

 **(Warning indicator pertaining to the flash)**

Fast flashing*

- There is something wrong with the flash.

 **(Warning indicator pertaining to camera-shake warning)**

- The amount of lights is not sufficient, so camera-shake easily occurs. Use the flash.
- The camcorder is unsteady, so camera-shake easily occurs. Hold the camcorder steady with both hands and record the image. However, note that the camera-shake warning indicator does not disappear.

 **(Warning indicator pertaining to drop sensor)**

- The drop sensor function (p. 81) is activated, and has detected that the camcorder has been dropped. Therefore, the camcorder is taking steps to protect the hard disk. Recording/playback may be disabled as a result.
- The drop sensor function does not guarantee the protection of the hard disk under all possible situations. Use the camcorder under stable conditions.

 **(Warning indicator pertaining to still image recording)**

- The media is full.
- Still images cannot be recorded during processing. Wait for a while, then record.

* You hear a melody when the warning indicators appear on the screen (p. 77).

Description of warning messages

If messages appear on the screen, follow the instructions.

■ Media

HDD format error.

- The hard disk of the camcorder is set differently from the default format. Performing [ FORMAT] (p. 63) may enable you to use your camcorder. This will delete all data in the hard disk.

Data error.

- An error occurred during reading or writing the hard disk of the camcorder. This may occur when you keep applying shock on the camcorder.

The Image Database File is damaged. Do you want to create a new file?

HD movie management information is damaged. Create new information?

- The image management file is damaged. When you touch [YES], a new image management file is created. The old recorded images on the media cannot be played back (Image files are not damaged). If you execute [REPAIR IMG.DB F.] after creating new information, playing back the old recorded images may become possible. If it does not work, copy the image using the supplied software.

Inconsistencies found in Image Database File. Do you want to repair the Image Database File?

The Image Database File is damaged. Do you want to repair the Image Database File?

Inconsistencies found in Image Database File. Cannot record or play HD movies. Do you want to repair the Image Database File?

- The Image Database File is damaged, and you cannot record movies or still images. Touch [YES] to repair.
- You can record still images on a “Memory Stick PRO Duo.”

Buffer overflow

- You cannot record because the drop sensor senses a drop of the camcorder repeatedly. If you are at risk of dropping the camcorder constantly, set [DROP SENSOR] to [OFF], and you may be able to record the image again (p. 81).

Recovering data

- Your camcorder tries to recover data automatically if the data writing was not performed properly.

Cannot recover data.

- Writing data onto the hard disk of the camcorder has failed. Attempts were made to recover the data, but they were unsuccessful.

Reinsert the Memory Stick.

- Reinsert the “Memory Stick PRO Duo” a few times. If even then the indicator flashes, the “Memory Stick PRO Duo” could be damaged. Try with another “Memory Stick PRO Duo.”

 **This Memory Stick is not formatted correctly.**

- Check the format, then format the “Memory Stick PRO Duo” with your camcorder if necessary (p. 63, 105).

Memory Stick folders are full.

- You cannot create folders exceeding 999MSDCF. You cannot create or delete created folders using your camcorder.
- Format the “Memory Stick PRO Duo” (p. 63), or delete them using your computer.

Cannot save still picture.

- When using the Dual Rec function, do not remove the “Memory Stick PRO Duo” from the camcorder until movie recording is finished and the still images are stored on it (p. 32).

This Memory Stick may not be able to record or play movies.

- Use a “Memory Stick” recommended for your camcorder (p. 2).

This Memory Stick may not be able to record or play images correctly.

- The function of the “Memory Stick PRO Duo” has some trouble. Reinsert the “Memory Stick PRO Duo.”

Do not eject the Memory Stick during writing.

- Reinsert the “Memory Stick PRO Duo,” and follow the instructions on the LCD screen.

■ **PictBridge compliant printer**

Not connected to PictBridge compatible printer.

- Turn off the printer and on again, then remove the USB cable (supplied) and reconnect it.

Cannot print. Check the printer.

- Turn off the printer and on again, then remove the USB cable (supplied) and reconnect it.

■ **Other**

No further selection is possible.

- You can select only 100 images at one time for:
 - Deleting images
 - Dubbing movies
 - Copying still images
 - Editing the playlist of HD (high definition) movies
 - Printing still images

Data protected.

- You tried to delete data protected on another device. Release the protection of the data on the device used to protect the data.

Using your camcorder abroad

Power supply

You can use your camcorder in any countries/regions using the AC Adaptor supplied with your camcorder within the AC 100 V to 240 V, 50/60 Hz range.

Viewing images recorded with HD (high definition) image quality

In countries/regions where 1080/50i is supported, you can view the images with the same HD (high definition) image quality as that of the recorded images. You need a PAL-system-based and 1080/50i compatible TV (or monitor) with component and AUDIO/VIDEO input jacks. A component A/V cable or an HDMI cable (optional) must be connected.

Viewing images recorded with SD (standard definition) image quality

To view images recorded with SD (standard definition) image quality, you need a PAL-system-based TV with AUDIO/VIDEO input jacks. An A/V connecting cable must be connected.

On TV color systems

Your camcorder is a PAL-system-based camcorder. If you want to view the playback image on a TV, it must be a PAL-system-based TV with an AUDIO/VIDEO input jack.

System	Used in
PAL	Australia, Austria, Belgium, China, Czech Republic, Denmark, Finland, Germany, Holland, Hong Kong, Hungary, Italy, Kuwait, Malaysia, New Zealand, Norway, Poland, Portugal, Singapore, Slovak Republic, Spain, Sweden, Switzerland, Thailand, United Kingdom, etc.
PAL - M	Brazil
PAL - N	Argentina, Paraguay, Uruguay.
NTSC	Bahama Islands, Bolivia, Canada, Central America, Chile, Colombia, Ecuador, Guyana, Jamaica, Japan, Korea, Mexico, Peru, Surinam, Taiwan, the Philippines, the USA, Venezuela, etc.
SECAM	Bulgaria, France, Guiana, Iran, Iraq, Monaco, Russia, Ukraine, etc.

Setting to the local time

You can easily set the clock to the local time by setting a time difference when using your camcorder abroad. Touch **HOME** → **SETTINGS** → **[CLOCK/LANG]** → **[AREA SET]** and **[SUMMERTIME]** (p. 79).

World time difference

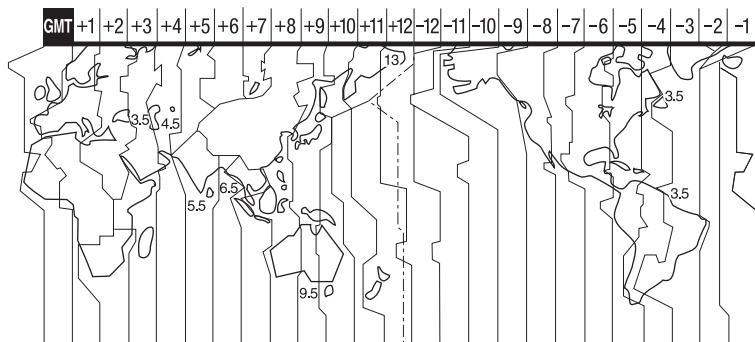

Time-zone differences	Area setting
GMT	Lisbon, London
+01:00	Berlin, Paris
+02:00	Helsinki, Cairo, Istanbul
+03:00	Moscow, Nairobi
+03:30	Tehran
+04:00	Abu Dhabi, Baku
+04:30	Kabul
+05:00	Karachi, Islamabad
+05:30	Calcutta, New Delhi
+06:00	Almaty, Dhaka
+06:30	Rangoon
+07:00	Bangkok, Jakarta
+08:00	HongKong, Singapore, Beijing
+09:00	Seoul, Tokyo
+09:30	Adelaide, Darwin
+10:00	Melbourne, Sydney

Time-zone differences	Area setting
+11:00	Solomon Is
+12:00	Fiji, Wellington
-12:00	Eniwetok, Kwajalein
-11:00	Samoa
-10:00	Hawaii
-09:00	Alaska
-08:00	LosAngeles, Tijuana
-07:00	Denver, Arizona
-06:00	Chicago, Mexico City
-05:00	New York, Bogota
-04:00	Santiago
-03:30	St. John's
-03:00	Brasilia, Montevideo
-02:00	Fernando de Noronha
-01:00	Azores, Cape Verde Is.

File/folder structure on the camcorder hard disk and “Memory Stick PRO Duo”

The file/folder structure is shown below. You do not usually need to acknowledge the file/folder structure, when recording/playing back images on the camcorder. To enjoy still images or movies by connecting to a computer, see “PMB Guide,” then use the supplied application.

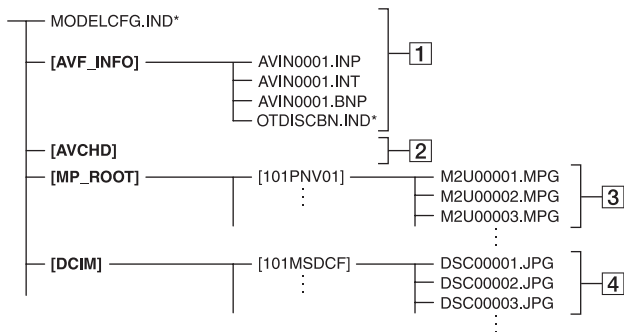

* Only for the internal hard disk

1 Image management files

When you delete the files, you cannot record/play back the images correctly. The files are defaulted as hidden files and not usually displayed.

2 HD movie management information folder

This folder contains recording data of movies with HD (high definition) image quality. Do not try to open this folder or access the contents of this folder from a computer. Doing so might damage image files, or prevent image files from being played back.

3 SD movie files (MPEG2 files)

The extension of the files is “.MPG”. The maximum size is 2 GB. When the capacity of a file exceeds 2 GB, the file becomes divided.

The file numbers go up automatically. When the capacity of a file number exceeds 9999, another folder is created to record new movie files.

The folder name goes up: [101PNV01] → [102PNV01]

4 Still image files (JPEG files)

The extension of the files is “.JPG”. The file numbers go up automatically. When the capacity of a file number exceeds 9999, another folder is created to store new image files.

The folder name goes up: [101MSDCF] → [102MSDCF]

- By setting (HOME) → (OTHERS) → [USB CONNECT] → (USB CONNECT) / (USB CONNECT), you can access the media from the computer through USB connection.
- Do not modify the files or folders on the camcorder through the computer. The image files may be destroyed or may not be played back.
- Operation is not guaranteed, if you perform the above operation.
- When you delete image files, follow the steps on page 49. Do not delete the image files on the camcorder directly from the computer.
- Do not format the media using the computer. The camcorder may not operate correctly.
- Do not copy the files on the media from the computer. Operation is not guaranteed.

Maintenance and precautions

About the AVCHD format

What is the AVCHD format?

The AVCHD format is a high definition digital video camera format used to record an HD (high definition) signal of either the 1080i specification*¹ or the 720p specification*² on internal hard disk drive, using efficient data compression coding technology. The MPEG-4 AVC/H.264 format is adopted to compress video data, and the Dolby Digital or Linear PCM system is used to compress audio data.

The MPEG-4 AVC/H.264 format is capable of compressing images at higher efficiency than that of the conventional image compressing format. The MPEG-4 AVC/H.264 format enables a high definition video signal shot on a digital video camera recorder to be recorded on 8 cm DVD discs, internal hard disk drive, flash memory, "Memory Stick PRO Duo," etc.

Recording and playback on your camcorder

Based on the AVCHD format, your camcorder records with the HD (high definition) image quality mentioned below. In addition to HD (high definition) image quality, your camcorder is capable of recording an SD (standard definition) signal in the conventional MPEG2 format.

Video signal*³:

MPEG-4 AVC/H.264 1920 × 1080/50i,
1440 × 1080/50i

Audio signal:

Dolby Digital 5.1/2ch

Recording media:

Internal hard disk drive, "Memory Stick PRO Duo"

*1: 1080i specification

A high definition specification which utilizes 1,080 effective scanning lines and the interlace system.

*2: 720p specification

A high definition specification which utilizes 720 effective scanning lines and the progressive system.

*3: Data recorded in AVCHD format other than the above mentioned cannot be played on your camcorder.

About the "Memory Stick"

A "Memory Stick" is a compact, portable IC recording medium with a large data capacity.

You can use only a "Memory Stick Duo," which is about the half size of a standard "Memory Stick," with your camcorder. However, we do not guarantee the operation of all types of "Memory Stick Duo" on your camcorder.

Types of "Memory Stick"	Recording/ Playback
"Memory Stick Duo" (with MagicGate)	—
"Memory Stick PRO Duo"	○
"Memory Stick PRO-HG Duo"	○*

* This product does not support 8-bit parallel data transfer but it supports 4-bit parallel data transfer the same as with "Memory Stick PRO Duo."

- This product cannot record or play data that uses "MagicGate" technology. "MagicGate" is a copyright protection technology that records and transfers the contents in an encrypted format.
- A "Memory Stick PRO Duo" formatted by a computer (Windows OS/Mac OS) does not have guaranteed compatibility with your camcorder.
- Data read/write speed may vary depending on the combination of the "Memory Stick PRO Duo" and "Memory Stick PRO Duo" compliant product you use.
- Damaged or lost data may occur in the following cases (the data will not be compensated for):
 - If you eject the "Memory Stick PRO Duo," or turn off your camcorder while your camcorder is reading or writing image files on the "Memory Stick PRO Duo" (while the ACCESS lamp is lit or flashing)

- If you use the “Memory Stick PRO Duo” near magnets or magnetic fields
- It is recommended you make a back-up of important data on the hard disk of a computer.
- Be careful not to apply excessive force when writing on a memo area on a “Memory Stick PRO Duo.”
- Do not attach a label or the like on a “Memory Stick PRO Duo” or a Memory Stick Duo adaptor.
- When you carry or store a “Memory Stick PRO Duo,” put it in its case.
- Do not touch, or allow metallic objects to come into contact with the terminals.
- Do not bend, drop or apply strong force to the “Memory Stick PRO Duo.”
- Do not disassemble or modify the “Memory Stick PRO Duo.”
- Do not let the “Memory Stick PRO Duo” get wet.
- Keep “Memory Stick PRO Duo” media out of the reach of small children. There is danger that a child might swallow it.
- Do not insert anything other than a “Memory Stick PRO Duo” into the Memory Stick Duo slot. Doing so may cause a malfunction.
- Do not use or keep the “Memory Stick PRO Duo” in the following locations:
 - Places subject to extremely high temperature, such as a car parked outside in the summer
 - Places under direct sunlight
 - Places with extremely high humidity or subject to corrosive gases

■ On the Memory Stick Duo adaptor

- When using a “Memory Stick PRO Duo” with a “Memory Stick” compliant device, be sure to insert the “Memory Stick PRO Duo” into a Memory Stick Duo adaptor.
- When inserting a “Memory Stick PRO Duo” into a Memory Stick Duo adaptor, make sure the “Memory Stick PRO Duo” is inserted facing in the correct direction, then insert it all the way in. Note that improper use may cause a malfunction. Also, if you force the “Memory Stick PRO Duo” into the Memory Stick Duo adaptor in the wrong direction, it may be damaged.
- Do not insert a Memory Stick Duo adaptor without a “Memory Stick PRO Duo” attached into a “Memory Stick” compliant device. Doing so may result in malfunctions of the unit.

■ On a “Memory Stick PRO Duo”

- The maximum memory capacity of a “Memory Stick PRO Duo” that can be used with your camcorder is 8 GB.

On image data compatibility

- Image data files recorded on a “Memory Stick PRO Duo” by your camcorder conform to the “Design rule for Camera File system” universal standard established by the JEITA (Japan Electronics and Information Technology Industries Association).
- On your camcorder, you cannot play back still images recorded on other devices (DCR-TRV900E or DSC-D700/D770) that do not conform to the universal standard. (These models are not sold in some regions.)
- If you cannot use a “Memory Stick PRO Duo” that has been used with another device, format it with your camcorder (p. 63). Note that formatting erases all information on the “Memory Stick PRO Duo.”
- You may not be able to play back images with your camcorder:
 - When playing back image data modified on your computer
 - When playing back image data recorded with other devices

About the “InfoLITHIUM” battery pack

Your camcorder operates only with an “InfoLITHIUM” battery pack (H series). “InfoLITHIUM” H series battery packs have the  mark.

What is an “InfoLITHIUM” battery pack?

An “InfoLITHIUM” battery pack is a lithium-ion battery pack that has functions for communicating information related to operating conditions between your camcorder and an optional AC Adaptor/charger.

The “InfoLITHIUM” battery pack calculates the power consumption according to the operating conditions of

your camcorder, and displays the remaining battery time in minutes.

To charge the battery pack

- Be sure to charge the battery pack before you start using your camcorder.
- We recommend charging the battery pack in an ambient temperature of between 10 °C to 30 °C (50 °F to 86 °F) until the /CHG (charge) lamp turns off. If you charge the battery pack outside of this temperature range, you may not be able to charge it efficiently.



To use the battery pack effectively

- Battery pack performance decreases when the surrounding temperature is 10 °C (50 °F) or below, and the length of time you can use the battery pack becomes shorter. In that case, do one of the following to use the battery pack for a longer time.
 - Put the battery pack in a pocket to warm it up, and insert it in your camcorder right before you start taking shots.
 - Use a large capacity battery pack: NP-FH70/FH100 (optional).
- Frequent use of the LCD screen or a frequent playback, fast forward or rewind operation wears out the battery pack faster. We recommend using a large capacity battery pack: NP-FH70/FH100 (optional).
- Be sure to set the POWER switch to OFF (CHG) when not recording or playing back on your camcorder. The battery pack is also consumed when your camcorder is in recording standby or playback pause.
- Have spare battery packs ready for two or three times the expected recording time, and make trial recordings before making the actual recording.
- Do not expose the battery pack to water. The battery pack is not water resistant.

About the remaining battery time indicator

- When the power goes off even though the remaining battery time indicator indicates that the battery pack has enough power to operate, charge the battery pack fully again. Remaining battery time will be indicated correctly. Note, however, that the battery indication will not be restored if it is used in high temperatures for a long time, or if left in a fully charged state, or when the battery pack is frequently used. Use the remaining battery time indication as a rough guide only.
- The  mark that indicates low battery flashes even if there are still 20 minutes of battery time remaining, depending on the operating conditions or ambient temperature.

About storage of the battery pack

- If the battery pack is not used for a long time, fully charge the battery pack and use it up on your camcorder once a year to maintain proper function. To store the battery pack, remove it from your camcorder and put it in a dry, cool place.
- To discharge the battery pack on your camcorder completely, touch  (HOME) →  (SETTINGS) → [GENERAL SET] → [A.SHUT OFF] → [NEVER] on the HOME MENU and leave your camcorder in recording standby until the power goes off (p. 80).

About battery life

- Battery capacity decreases over time and through repeated use. If decreased usage time between charges becomes significant, it is probably time to replace it with a new one.
- Each battery's life is governed by storage, operating and environmental conditions.

About x.v.Color

- x.v.Color is a more familiar term for the xvYCC standard proposed by Sony, and is a trademark of Sony.
- xvYCC is an international standard for color space in video. This standard can express a wider color range than the currently used broadcast standard.

About handling of your camcorder

On use and care

- Do not use or store the camcorder and accessories in the following locations:
 - Anywhere extremely hot, cold or humid. Never leave them exposed to temperatures above 60 °C (140 °F), such as under direct sunlight, near heaters or in a car parked in the sun. They may malfunction or become deformed.
 - Near strong magnetic fields or mechanical vibration. The camcorder may malfunction.
 - Near strong radio waves or radiation. The camcorder may not be able to record properly.
 - Near AM receivers and video equipment. Noise may occur.
 - On a sandy beach or anywhere dusty. If sand or dust gets in your camcorder, it may malfunction. Sometimes this malfunction cannot be repaired.
 - Near windows or outdoors, where the LCD screen, the viewfinder, or the lens may be exposed to direct sunlight. This damages the inside of the viewfinder or the LCD screen.
- Operate your camcorder on DC 6.8 V/7.2 V (battery pack) or DC 8.4 V (AC Adaptor).
- For DC or AC operation, use the accessories recommended in these operating instructions.
- Do not let your camcorder get wet, for example, from rain or sea water. If your camcorder gets wet, it may malfunction. Sometimes this malfunction cannot be repaired.
- If any solid object or liquid gets inside the casing, unplug your camcorder and have it checked by a Sony dealer before operating it any further.
- Avoid rough handling, disassembling, modifying, physical shock, or impact such as hammering, dropping or stepping on the product. Be particularly careful of the lens.
- Keep the POWER switch setting to OFF (CHG) when you are not using your camcorder.
- Do not wrap your camcorder with a towel, for example, and operate it. Doing so might cause heat to build up inside.
- When disconnecting the power cord (mains lead), pull it by the plug and not the cord (lead).

- Do not damage the power cord (mains lead) such as by placing anything heavy on it.
- Keep metal contacts clean.
- Keep the Remote Commander and button-type battery out of children's reach. If the battery is accidentally swallowed, consult a doctor immediately.
- If the battery electrolytic liquid has leaked:
 - Consult your local authorized Sony service facility.
 - Wash off any liquid that may have contacted your skin.
 - If any liquid gets in your eyes, wash with plenty of water and consult a doctor.

■ When not using your camcorder for a long time

- Periodically turn it on and let it run such as by playing back or recording images for about 3 minutes.
- Use up the battery pack completely before storing it.

Moisture condensation

If your camcorder is brought directly from a cold place to a warm place, moisture may condense inside your camcorder. This may cause a malfunction to your camcorder.

■ **If moisture condensation has occurred**
Leave your camcorder for about 1 hour without turning it on.

■ Note on moisture condensation

Moisture may condense when you bring your camcorder from a cold place into a warm place (or vice versa) or when you use your camcorder in a humid place as follows:

- You bring your camcorder from a ski slope into a place warmed up by a heating device.
- You bring your camcorder from an air conditioned car or room into a hot place outside.
- You use your camcorder after a squall or a shower.
- You use your camcorder in a hot and humid place.

■ How to prevent moisture condensation

When you bring your camcorder from a cold place into a warm place, put your camcorder in a plastic bag and seal it tightly. Remove the bag when the air temperature inside the plastic bag has reached the surrounding temperature (after about 1 hour).

LCD screen



- Do not exert excessive pressure on the LCD screen, as it may cause damage.
- If your camcorder is used in a cold place, a residual image may appear on the LCD screen. This is not a malfunction.
- While using your camcorder, the back of the LCD screen may heat up. This is not a malfunction.

■ To clean the LCD screen

If fingerprints or dust make the LCD screen dirty, it is recommended you use a soft cloth to clean it. When you use the LCD Cleaning Kit (optional), do not apply the cleaning liquid directly to the LCD screen. Use cleaning paper moistened with the liquid.

■ On adjustment of the touch panel (CALIBRATION)

The buttons on the touch panel may not work correctly. If this happens, follow the procedure below. It is recommended that you connect your camcorder to the wall outlet (wall socket) using the supplied AC Adaptor during the operation.

- ① Turn on your camcorder.
- ② Touch  (HOME) →  (SETTINGS) → [GENERAL SET] → [CALIBRATION].

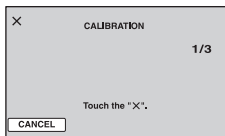

- ③ Touch "X" displayed on the screen with the corner of the "Memory Stick PRO Duo" or the like 3 times.

Touch [CANCEL] to cancel.

If you did not press the right spot, try the calibration again.

🔔 Notes

- Do not use a sharp-pointed object for calibration. Doing so may damage the LCD screen.
- You cannot calibrate the LCD screen if it is rotated, or closed with the screen facing out.

On handling the casing

- If the casing is soiled, clean the camcorder body with a soft cloth lightly moistened with water, and then wipe the casing with a dry soft cloth.
- Avoid the following to avoid damage to the finish:
 - Using chemicals such as thinner, benzene, alcohol, chemical cloths, repellent, insecticide and sunscreen
 - Handling the camcorder with above substances on your hands
 - Leaving the casing in contact with rubber or vinyl objects for a long period of time

About care and storage of the lens

- Wipe the surface of the lens clean with a soft cloth in the following instances:
 - When there are fingerprints on the lens surface
 - In hot or humid locations
 - When the lens is exposed to salty air such as at the seaside
- Store in a well-ventilated location subject to little dirt or dust.
- To prevent mold, periodically clean the lens as described above. It is recommended that you operate your camcorder about once a month to keep it in optimum state for a long time.

On charging the pre-installed rechargeable battery

Your camcorder has a pre-installed rechargeable battery to retain the date, time, and other settings even when the POWER switch is set to OFF (CHG). The pre-installed rechargeable battery is always charged while your camcorder is connected to the wall outlet (wall socket) via the AC Adaptor or while the battery pack is attached. The rechargeable battery will be fully discharged in about **3 months** if you do not use your camcorder at all. Use your camcorder after charging the pre-installed rechargeable battery.

However, even if the pre-installed rechargeable battery is not charged, the camcorder operation will not be affected as long as you are not recording the date.

■ Procedures

Connect your camcorder to a wall outlet (wall socket) using the supplied AC Adaptor, and leave it with the POWER switch set to OFF (CHG) for more than 24 hours.

On trademarks

- “Handycam” and **HANDYCAM** are registered trademarks of Sony Corporation.
- “AVCHD” and “AVCHD” logotype are trademarks of Matsushita Electric Industrial Co., Ltd. and Sony Corporation.
- “Memory Stick,” “ MEMORY STICK,” “Memory Stick Duo,” “**MEMORY STICK DUO**,” “Memory Stick PRO Duo,” “**MEMORY STICK PRO DUO**,” “Memory Stick PRO-HG Duo,” “**MEMORY STICK PRO-HG DUO**,” “MagicGate,” “**MAGICGATE**,” “MagicGate Memory Stick” and “MagicGate Memory Stick Duo” are trademarks or registered trademarks of Sony Corporation.
- “InfoLITHIUM” is a trademark of Sony Corporation.
- “x.v.Colour” is a trademark of Sony Corporation.
- “BIONZ” is a trademark of Sony Corporation.
- “BRAVIA” is a trademark of Sony Corporation.
- Dolby and the double-D symbol are trademarks of Dolby Laboratories.
- HDMI, the HDMI logo and High-Definition Multimedia Interface are trademarks or registered trademarks of HDMI Licensing LLC.
- Microsoft, Windows, Windows Media, Windows Vista, and DirectX are either registered trademarks or trademarks of Microsoft Corporation in the United States and/or other countries.
- Macintosh and Mac OS are registered trademarks of Apple Inc. in the U.S. and other countries.
- Intel, Intel Core, and Pentium are trademarks or registered trademarks of Intel Corporation or its subsidiaries in the United States and other countries.
- Adobe, the Adobe logo, and Adobe Acrobat are either registered trademarks or trademarks of Adobe Systems Incorporated in the United States and/or other countries.

All other product names mentioned herein may be the trademarks or registered trademarks of their respective companies. Furthermore, ™ and “®” are not mentioned in each case in this Handbook.

Notes on the License

ANY USE OF THIS PRODUCT OTHER THAN CONSUMER PERSONAL USE IN ANY MANNER THAT COMPLIES WITH THE MPEG-2 STANDARD FOR ENCODING VIDEO INFORMATION FOR PACKAGED MEDIA IS EXPRESSLY PROHIBITED WITHOUT A LICENSE UNDER APPLICABLE PATENTS IN THE MPEG-2 PATENT PORTFOLIO, WHICH LICENSE IS AVAILABLE FROM MPEG LA, L.L.C., 250 STEELE STREET, SUITE 300, DENVER, COLORADO 80206.

THIS PRODUCT IS LICENSED UNDER THE AVC PATENT PORTFOLIO LICENSE FOR THE PERSONAL AND NON-COMMERCIAL USE OF A CONSUMER TO

(i) ENCODE VIDEO IN COMPLIANCE WITH THE AVC STANDARD ("AVC VIDEO") AND / OR

(ii) DECODE AVC VIDEO THAT WAS ENCODED BY A CONSUMER ENGAGED IN A PERSONAL AND NON-COMMERCIAL ACTIVITY AND/OR WAS OBTAINED FROM A VIDEO PROVIDER LICENSED TO PROVIDE AVC VIDEO. NO LICENSE IS GRANTED OR SHALL BE IMPLIED FOR ANY OTHER USE. ADDITIONAL INFORMATION MAY BE OBTAINED FROM MPEG LA, L.L.C. SEE <[HTTP://MPEGLA.COM](http://MPEGLA.COM)>

"C Library," "Expat," "zlib," and "libjpeg" software are provided in your camcorder. We provide this software based on license agreements with their owners of copyright. Based on requests by the owners of copyright of these software applications, we have an obligation to inform you of the following. Please read the following sections.

Read "license1.pdf" in the "License" folder on the CD-ROM. You will find licenses (in English) of "C Library," "Expat," "zlib," and "libjpeg" software.

On GNU GPL/LGPL applied software

The software that is eligible for the following GNU General Public License (hereinafter referred to as "GPL") or GNU Lesser General Public License (hereinafter referred to as "LGPL") are included in the camcorder.

This informs you that you have a right to have access to, modify, and redistribute source code for these software programs under the conditions of the supplied GPL/LGPL.

Source code is provided on the web. Use the following URL to download it. When downloading the source code, select DCR-DVD810 as the model for your camcorder. <http://www.sony.net/Products/Linux/>

We would prefer you do not contact us about the contents of source code.

Read "license2.pdf" in the "License" folder on the CD-ROM. You will find licenses (in English) of "GPL," and "LGPL" software.

To view the PDF, Adobe Reader is needed. If it is not installed on your computer, you can download it from the Adobe Systems web page: <http://www.adobe.com/>

Identifying parts and controls

The numbers in () are reference pages.

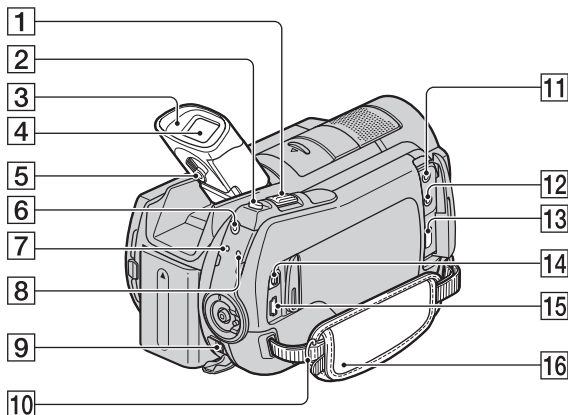

- 1** Power zoom lever (31, 39)
- 2** PHOTO button (30)
- 3** Eyecup
- 4** Viewfinder (22)
- 5** Viewfinder lens adjustment lever (22)
- 6** QUICK ON button (32)
- 7** ⚡/CHG (charge) lamp
- 8** ACCESS lamp (Hard disk) (29)
- 9** DC IN jack (16)
- 10** Hook for a shoulder belt
Attach a shoulder belt (optional).
- 11** MIC (PLUG IN POWER) jack
- 12** 🎧 (headphones) jack
- 13** HDMI OUT (mini) jack (42)
- 14** A/V Remote Connector (42)
- 15** 📶 (USB) jack (59, 60)
- 16** Grip belt (22)

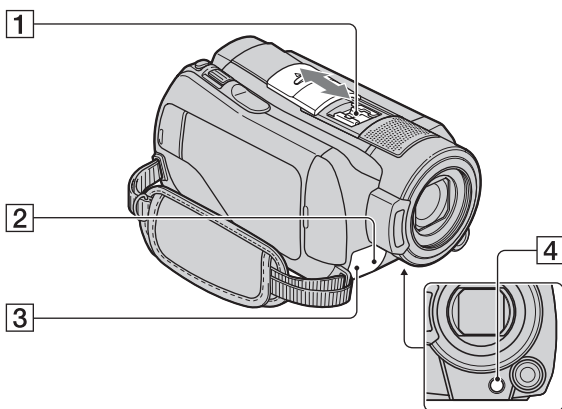

1 Active Interface Shoe Active Interface Shoe

The Active Interface Shoe supplies power to optional accessories such as a video light, a flash, or a microphone. The accessory can be turned on or off as you operate the POWER switch on your camcorder. Refer to the operating instructions supplied with your accessory for details.





The Active Interface Shoe has a safety device for fixing the installed accessory securely. To connect an accessory, press down and push it to the end, and then tighten the screw. To remove an accessory, loosen the screw, and then press down and pull out the accessory.

- When you open or close the shoe cover, slide it as indicated by the arrow.
- When you are recording movies with an external flash (optional) connected to the accessory shoe, turn off the power of the external flash to prevent charging noise being recorded.
- You cannot use an external flash (optional) and the built-in flash at the same time.

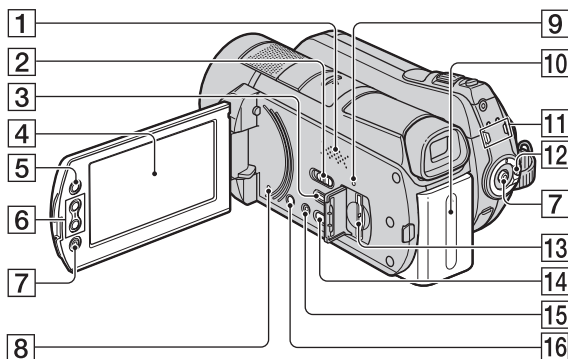
- When an external microphone (optional) is connected, it takes precedence over the Built-in microphone (p. 115).

- 2** Remote sensor/Infrared port
Point the Remote Commander (p. 116) towards the remote sensor to operate your camcorder.
- 3** Camera recording lamp (80)
Lights up in red during recording. Flashes when remaining hard disk space or battery power is low.
- 4**  (back light) button (33)



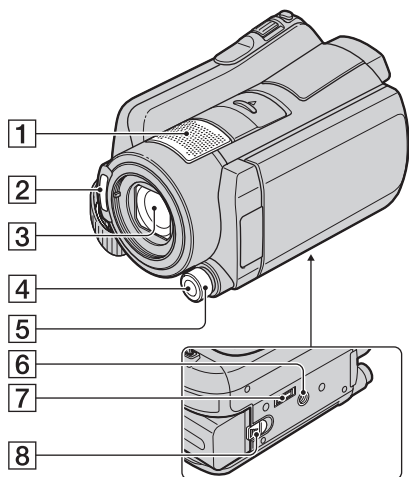

- 1** Speaker
Playback sounds come out from the speaker. For how to adjust the volume, see page 37.
- 2** NIGHTSHOT switch (32)
- 3**  (VIEW IMAGES) button (35)
- 4** LCD screen/touch panel (21)
- 5**  (HOME) button (13, 66)
- 6** Zoom buttons (31, 39)
- 7** START/STOP button (30)
- 8** RESET button
Initializes all the settings, including the setting of the date and time.
- 9** ACCESS lamp (“Memory Stick PRO Duo”) (23)
- 10** Battery pack (16)
- 11**  (Movie)/ (Still) mode lamps (20)
- 12** POWER switch (20)
- 13** Memory Stick Duo slot (23)
- 14**  (DISC BURN) button (47)
- 15** EASY button (25)
- 16** DISP/BATT INFO button (17, 21)

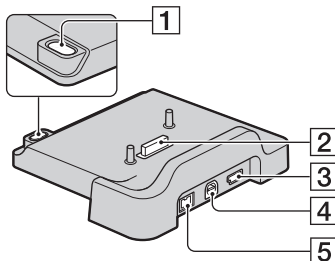

- 1** Built-in microphone (31)
An Active Interface Shoe compatible microphone (optional) will take precedence when connected.
- 2** Flash (71)
- 3** Lens (Carl Zeiss Lens) (4)
- 4** MANUAL button (34)
- 5** CAM CTRL dial (34)
- 6** Tripod receptacle
Attach the tripod (optional) to the tripod receptacle using a tripod screw (optional: the length of the screw must be less than 5.5 mm (7/32 in.)).
- 7** Interface connector
Connects your camcorder to the Handycam Station.
- 8** BATT (battery release) lever (17)

Handycam Station



- 1**  (DISC BURN) button (47)
- 2** Interface connector
Connects your camcorder to the Handycam Station.
- 3**  (USB) jack (60)
- 4** A/V OUT jack (42)
- 5** DC IN jack (16)

Remote Commander

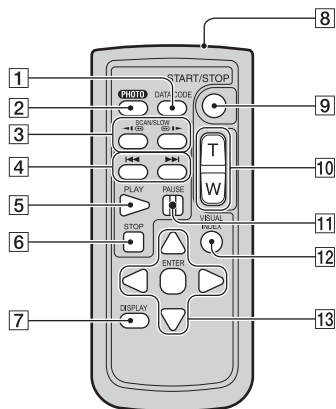

- 1** DATA CODE button (75)
Displays the date and time or camera setting data of the recorded images when you press this during playback.
- 2** PHOTO button (30)
The on-screen image when you press this button will be recorded as a still image.
- 3** SCAN/SLOW buttons (36)
- 4** ◀◀ ▶▶ (Previous/Next) buttons (36)
- 5** PLAY button (36)
- 6** STOP button (36)
- 7** DISPLAY button (17)
- 8** Transmitter
- 9** START/STOP button (30)
- 10** Power zoom buttons (31, 39)
- 11** PAUSE buttons (36)
- 12** VISUAL INDEX button (35)
Displays a VISUAL INDEX screen during playback.
- 13** ◀ / ▶ / ▲ / ▼ / ENTER buttons
When you press any button on the [VISUAL INDEX]/[Film Roll Index]/[Face Index]/Playlist screen, the orange frame appears on the LCD screen. Select a desired button or an item with ◀ / ▶ / ▲ / ▼, then press ENTER to enter.

Notes

- Remove the insulation sheet before using the Remote Commander.

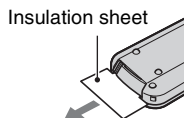

- Point the Remote Commander towards the remote sensor to operate your camcorder (p. 113).
- When no commands have been sent from the Remote Commander within a certain period, the orange frame disappears. When you press any of ◀ / ▶ / ▲ / ▼, or ENTER again, the frame appears at the position where it was displayed last.
- You cannot select some buttons on the LCD screen using ◀ / ▶ / ▲ / ▼.

To change the battery of the Remote Commander

- ① While pressing on the tab, insert your fingernail into the slit to pull out the battery case.
- ② Place a new battery with the + side facing up.
- ③ Insert the battery case back into the Remote Commander until it clicks.

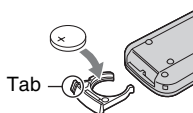

WARNING

Battery may explode if mistreated. Do not recharge, disassemble or dispose of in fire.

- When the lithium battery becomes weak, the operating distance of the Remote Commander may shorten, or the Remote Commander may not function properly. In this case, replace the battery with a Sony CR2025 lithium battery. Use of another battery may present a risk of fire or explosion.

Indicators displayed during recording/playback

Recording movies

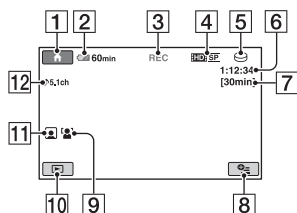

Recording still images

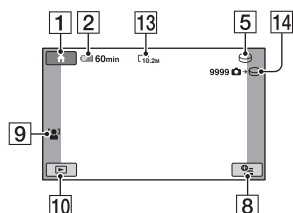

Viewing movies

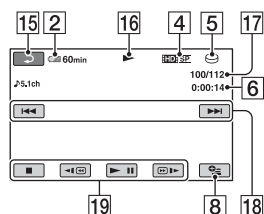

Viewing still images

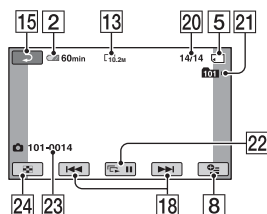

- HOME button (13)
- Remaining battery (approx.) (17)
- Recording status ([STBY] (standby) or [REC] (recording))
- Recording quality (HD/SD) and recording mode (FH/HQ/SP/LP) (68)
- Recording/playback media
- Counter (hour/minute/second)
- Approximate recording time remaining
- OPTION button (14)
- FACE DETECTION (72)
- VIEW IMAGES button
- Face Index set (72)
- 5.1ch surround recording (31)
- Image size (73)
- Approximate number of recordable still images and media/During still image recording
- Return button
- Playback mode
- Current playing movie number/Number of total recorded movies
- Previous/Next button (36)
- Video operation buttons (36)
- Current playing still image number/ Number of total recorded still images
- Playback folder
Displays only when the playback media of still images is a "Memory Stick PRO Duo."
- Slide show button (39)
- Data file name
- VISUAL INDEX button (35)

Indicators when you made changes

Following indicators appear during recording/playback to indicate the settings of your camcorder.

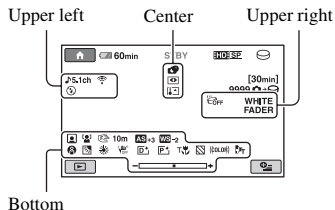

Upper left

Indicator	Meaning
	AUDIO MODE (69)
	Self-timer recording (88)
	Flash light (71), REDEYE REDUC (72)
	BLT-IN ZOOM MIC (88)
	MICREF LEVEL low (88)
	WIDE SELECT (69)

Center

Indicator	Meaning
	IMAGE SIZE (73)
	Slide show set (39)
	NightShot (32)
	Super NightShot (87)
	Color Slow Shutter (87)
	PictBridge connecting (60)
	Warning (98)

Upper right

Indicator	Meaning
	Fader (87)
	LCD backlight off (21)
	Drop sensor off (81)
	Drop sensor activated (81)
	Media for still images (23)

Bottom

Indicator	Meaning
	Face Index (72)
	FACE DETECTION (72)
	Picture effect (88)
	Digital effect (88)
	Manual focus (84)
	SCENE SELECTION (85)
	Backlight (33)
	White balance (86)
	SteadyShot off (70)
	SPOT METER (85)/ EXPOSURE (85)
	AE SHIFT (69)
	WB SHIFT (69)
	Tele macro (84)
	Zebra (71)
	X.V.COLOR (70)
	CONVERSION LENS (73)

Tips

- Indicators and their positions are approximate and differ from what you actually see.

Data code during recording

The recording date and time is recorded automatically on the media. They are not displayed while recording. However, you can check them as [DATA CODE] during playback (p. 75).

Glossary

■ 5.1ch surround sound

A system that plays back sound on 6 speakers, 3 at the front (left, right and center) and 2 at the rear (right and left) with an additional low-pass subwoofer counted as a 0.1 channel for frequencies of 120 Hz or lower.

■ AVCHD format

A high definition digital video camera format used to record an HD (high definition) signal using the MPEG-4 AVC/H.264 format.

■ Dolby Digital

An audio encoding (compression) system developed by Dolby Laboratories Inc.

■ Dolby Digital 5.1 Creator

Sound compression technology developed by Dolby Laboratories Inc. which compresses audio efficiently while preserving high sound quality. Sounds are compressed effectively with high quality sound, and it enables producing 5.1ch surround sound.

■ Fragmentation

The condition of a media in which files are divided into pieces scattered around the media. You may not save your images correctly. You can solve the condition by performing [MEDIA FORMAT] (p. 63).

■ JPEG

JPEG stands for Joint Photographic Experts Group, a still image data compression (data capacity reduction) standard. Your camcorder records still images in JPEG format.



■ MPEG

MPEG stands for Moving Picture Experts Group, the group of standards for the coding (image compression) of video (movie) and audio. There are MPEG1 and MPEG2 formats. Your camcorder records movies with SD (standard definition) image quality in MPEG2 format.

■ MPEG-4 AVC/H.264

The latest image coding format standardized jointly by two international standardization organizations, the ISO-IEC and the ITU-T, in 2003. Compared with the conventional MPEG2 format, MPEG-4 AVC/H.264 has more than twice the efficiency. Your camcorder employs MPEG-4 AVC/H.264 to encode high definition movies.

■ Thumbnail

Reduced-size images which enable you to view many images at the same time. [VISUAL INDEX]/[ INDEX]/[ INDEX] are thumbnail display system.

■ VBR

VBR stands for Variable Bit Rate, the recording format for automatically controlling the bit rate (the volume of recording data in a given time segment) according to the scene being recorded. For fast-moving video, a lot of media space is used to produce a clear image, so the recording time to the media shortens.

Index

Numeric

1080i/576i	79
16:9	78
16:9 WIDE.....	69
21-pin adaptor.....	45
4:3	69, 78
4:3 TV.....	43
576i	79
5.1ch surround recording.....	31

A

AC Adaptor.....	16
Adjusting exposure for back light.....	33
AE SHIFT.....	69, 96
AREA SET	79
AUDIO MODE.....	69
AUTO SLW SHUTTR (Auto Slow Shutter).....	70, 96
AVCHD format	11, 105, 120
A.SHUT OFF (Auto shut off).....	80
A/V connecting cable	15, 44, 58
A/V OUT jack.....	42, 58
A/V Remote Connector	40, 58

B

Backup.....	See Saving images
Battery pack	16
BEACH.....	86
BEEP	77
BLACK FADER.....	87
BLT-IN ZOOM MIC (Built-in zoom microphone).....	88
“BRAVIA” Sync	45
Button-type lithium battery	116
B&W (Black and white).....	88

C

CALIBRATION.....	109
CAM CTRL dial	34
CAMERA DATA	75
CANDLE	85
Charging the battery.....	16
Battery pack	16
Pre-installed rechargeable battery	110
Charging time.....	18
CLOCK SET	20
CLOCK/LANG	79
COLOR SLOW SHTR (Color Slow Shutter).....	87, 96
COMPONENT.....	79
Component A/V cable	15, 42, 44
Computer.....	47
Connection	
4:3 TV	43
DVD/HDD recorders....	58
High definition TV.....	42
Printer.....	60
VCR	58
Wide TV	43
CONVERSION LENS	73
CTRL FOR HDMI (Control for HDMI)	81

D

DATA CODE.....	75, 119
Date Index	38
DATE/TIME	75, 119
DC IN jack	16
DC plug	16
DELETE	
By date	49, 50
Movies	49
Still images	50
DEMO MODE	80
DIAL SETTING	72

DIGITAL ZOOM.....	70
DISP OUTPUT.....	79
DISPLAY	76
Display indicators.....	117
DIVIDE	54
Dolby Digital 5.1 Creator.....	31
DROP SENSOR	81
Dual Rec	32
D.EFFECT (Digital effect)	88, 96

E

Easy Handycam operation....	25
Editing	48
EMPTY.....	64
EXPOSURE	85, 96

F

FACE DETECTION	72
Face Index	37
Face Index set.....	72
FADER	87, 96
FH.....	68
File.....	104
FILE NO. (File number).....	74
Film Roll Index.....	37
FIREWORKS	85
Flash	92
FLASH LEVEL.....	72
FLASH MODE.....	71
FOCUS	84, 93
Folder.....	104
FORMAT	
Hard disk	63
“Memory Stick PRO Duo”	63
Fragmentation.....	120
Full charge	16

G

GENERAL SET	80
-------------------	----

Grip belt.....22
GUIDEFRAAME.....70

H

Handycam Station 16
Hard disk5, 104
HD movie management file
..... 104
HD (high definition) image
quality.....9
HDD INFO.....62
HDMI cable.....43
HDMI OUT jack42
Help13
High altitudes5
High Definition TV42
Holding the camcorder29
HOME MENU12, 66
 CLOCK/LANG79
 GENERAL SET80
 MOVIE SETTINGS.....68
 OUTPUT SETTINGS...78
 PHOTO SETTINGS.....73
 SETTINGS category66
 SOUND/DISP SET77
 VIEW IMAGES SET...75
HQ68

I

Icon.....See Display indicators
Image management files..... 104
IMAGE SIZE73
Index screen display button
..... 117
Indicators118
INDOOR86
“InfoLITHIUM” battery pack
.....106

J

JPEG.....104, 120

L

LANDSCAPE..... 86
LANGUAGE SET 79
LCD BL LEVEL
(LCD back light level)..... 77
LCD BRIGHT..... 77
LCD COLOR..... 77
LCD panel..... 21
 LCD BL LEVEL 77
 LCD BRIGHT 77
 LCD COLOR..... 77
LCD screen 21
LP..... 68, 69

M

Maintenance..... 105
MANAGE MEDIA category
..... 62
Media 22
Media setting..... 22
“Memory Stick”..... 2, 105
Memory Stick Duo adaptor
..... 106
“Memory Stick PRO Duo”
..... 2, 106
“Memory Stick PRO-HG Duo”
..... 2, 105
MICREF LEVEL (Microphone
reference level) 88
Mirror mode 33
Moisture condensation 108
Movie
 Dubbing movies..... 52
 Recording mode..... 68
 Shooting..... 30
MOVIE SETTINGS 68
MPEG 120
MPEG2 104
MPEG-4 AVC/H.264..... 120

N

NightShot..... 32

NIGHTSHOT LIGHT 69
Number of recordable pictures
..... 74

O

OLD MOVIE..... 96
ONE PUSH 86, 96
Operation confirmation beep
..... See BEEP
OPTION MENU 82
Original..... 52
OTHERS category..... 48
OUTDOOR 86
OUTPUT SETTINGS 78

P

PAL 102
PASTEL 88
PB zoom 39
PHOTO CAPTURE 51
PHOTO SETTINGS..... 73
PictBridge..... 60
PICT.EFFECT (Picture effect)
..... 88, 96
Playback 26, 35
Playing time..... 18
Playlist 55
PORTRAIT (Soft portrait) ... 86
Power cord (Mains lead)..... 16
Pre-installed rechargeable
battery 110
Print 60

Q

QUICK ON 32
QUICK ON STBY
(Quick on standby) 80

R

REC LAMP (Recording lamp)
..... 80
REC MODE (Recording mode)
..... 68

Recording.....	25, 29
Recording time	11, 18
REDEYE REDUC	72
Remaining	
Battery	17
Hard disk	62
“Memory Stick PRO Duo”	62
Remaining battery.....	17
REMAINING SET (movie)	71
Remote Commander	90, 116
REMOTE CTRL (Remote control).....	80
REPAIR IMG.DB F.	65
RESET	114
S	
S VIDEO cable	44
S VIDEO jack	58
SCENE SELECTION.....	85, 96
SD movie files	104
SD (standard definition) image quality	9
Self-diagnosis display.....	98
SELF-TIMER	88
SEPIA	88
SETTINGS	66
SETTINGS category.....	66
Slide show.....	39
SLIDE SHOW SET	39
SMTH SLW REC	33
SNOW	86
SOUND/DISP SET.....	77
SP.....	68, 69
SPOT FOCUS.....	84, 96
SPOT METER (Flexible spot meter).....	85, 96
SPOTLIGHT	86
STEADYSHOT	70, 93

Still image	
Copying still images	53
IMAGE SIZE.....	73
Shooting	30
Still image files	104
SUB-T DATE (Subtitle date)	71
SUNRISE&SUNSET	85
SUPER NIGHTSHOT ...	87, 96

T

TELE MACRO	84, 96
Telephoto	31
Thumbnail	120
Trademark	110
Tripod.....	115
TV color system	102
TV CONNECT Guide.....	41
TV TYPE	78
TWILIGHT	85
TWILIGHT PORT	85

U

USB cable	15
USB CONNECT	104
USB jack	115
USB SELECT	59, 60
Using abroad	102

V

VBR	11, 120
VF B.LIGHT (Viewfinder brightness)	77
VIEW IMAGES SET	75
Viewing pictures on a TV	40
VISUAL INDEX.....	35
VOLUME.....	77
Volume adjustment	37

W

Wall outlet (Wall socket)	16
---------------------------------	----

Warning indicators	98
Warning messages	100
WB SHIFT (White Balance Shift)	69
WHITE BAL. (White balance)	86, 96
WHITE FADER	87
Wide angle.....	31
WIDE SELECT	69, 96
Wide TV	43
World time difference.....	103

X

X.V.COLOR.....	70, 107
----------------	---------

Z

ZEBRA	71
Zoom.....	31
ZOOM LINK	76

Additional information on this product and answers to frequently asked questions can be found at our Customer Support Website.

<http://www.sony.net/>

Free Manuals Download Website

<http://myh66.com>

<http://usermanuals.us>

<http://www.somanuals.com>

<http://www.4manuals.cc>

<http://www.manual-lib.com>

<http://www.404manual.com>

<http://www.luxmanual.com>

<http://aubethermostatmanual.com>

Golf course search by state

<http://golfingnear.com>

Email search by domain

<http://emailbydomain.com>

Auto manuals search

<http://auto.somanuals.com>

TV manuals search

<http://tv.somanuals.com>