

Digital HD Video Camera Recorder

Operating Guide

Before operating the unit, please read this manual thoroughly,
and retain it for future reference

AVCHD**HDMI**

HXR-MC1P

© 2009 Sony Corporation

Read this before operating your camcorder

Before operating the unit, please read this manual thoroughly, and retain it for future reference.

Notes on use

Handling the images recorded on your camcorder on a computer

Refer to “PMB (Picture Motion Browser) Guide” stored on the supplied CD-ROM.

Types of “Memory Stick” media you can use with your camcorder

- For recording movies, it is recommended that you use “Memory Stick PRO Duo” media of 1 GB or larger marked with:
 - MEMORY STICK PRO DUO (“Memory Stick PRO Duo” media)*
 - MEMORY STICK PRO-HG DUO (“Memory Stick PRO-HG Duo” media)
- * Only “Memory Stick PRO Duo” media marked with Mark2 can be used.
- See page 15 for the recordable time of “Memory Stick PRO Duo” media.

“Memory Stick PRO Duo”/“Memory Stick PRO-HG Duo”
(This size can be used with your camcorder.)



“Memory Stick”
(You cannot use it in your camcorder.)



- “Memory Stick PRO Duo” media and “Memory Stick PRO-HG Duo” media are both referred to as “Memory Stick PRO Duo” media in this manual.
- You cannot use any type of memory card other than those mentioned above.

- “Memory Stick PRO Duo” media can be used only with “Memory Stick PRO” media compatible equipment.
- Do not attach a label or the like on “Memory Stick PRO Duo” media or “Memory Stick Duo” media adaptor.
- Insert the “Memory Stick PRO Duo” media into the “Memory Stick Duo” media adaptor when using “Memory Stick PRO Duo” media with “Memory Stick PRO” media compatible equipment.

Using the camcorder

- Do not hold the camcorder by the following parts.

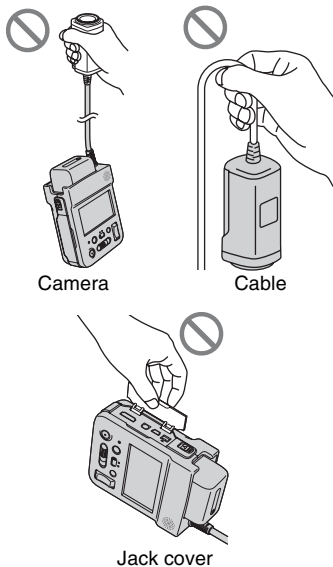



Camera

Cable

Jack cover

- The camera of the camcorder is splash-proof but the main body is not, therefore never wet the main body of the camcorder. See “About handling of your camcorder” (p. 80).

- Do not apply shock or vibration to this camcorder. This may cause a malfunction. If you must use this camcorder where shock or vibration is likely, use a commercially available shock absorber, etc.
- Do not do any of the following when the  (Movie)/ (Still) mode lamps (p. 12) or the access lamp (p. 14) is lit or flashing.

Otherwise, the media may be damaged, recorded images may be lost or other malfunctions could occur.

- Eject the “Memory Stick PRO Duo” media from the camcorder
 - Remove the battery pack or AC Adaptor from the camcorder.
 - Apply mechanical shock or vibration to the camcorder.
- When connecting your camcorder to another device with a cable, be sure to insert the connector plug in the correct way. Pushing the plug forcibly into the terminal will damage the terminal and may result in a malfunction of your camcorder.

About menu items, LCD panel and lens

- A menu item that is grayed out is not available under the current recording or playback conditions.
- The LCD screen is manufactured using extremely high-precision technology, so over 99.99% of the pixels are operational for effective use. However, there may be some tiny black points and/or bright points (white, red, blue, or green in color) that appear constantly on the LCD screen. These points are normal results of the manufacturing process and do not affect the recording in any way.

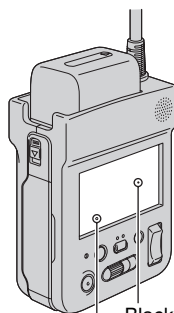

Black point

White, red, blue or green point

- Exposing the LCD screen or the lens to direct sunlight for long periods of time may cause malfunctions.
- Do not aim at the sun. Doing so might cause your camcorder to malfunction. Take images of the sun only in low light conditions, such as at dusk.

About changing the language setting

- The on-screen displays in each local language are used for illustrating the screen language before using your camcorder if necessary (p. 13).

On recording

- When you use a memory card with your camcorder for the first time, formatting the memory card with your camcorder (p. 45) is recommended for stable operation. All data recorded on the memory card will be deleted when it is formatted, and cannot be recovered. Save important data to your computer, etc., beforehand.
- Before starting to record, test the recording function to make sure the image and sound are recorded without any problems.

- Compensation for the contents of recordings cannot be provided, even if recording or playback is not possible due to a malfunction of the camcorder, storage media, etc.
- TV color systems differ depending on the country/region. To view your recordings on a TV, you need a PAL system-based TV.
- Television programs, films, video tapes, and other materials may be copyrighted. Unauthorized recording of such materials may be contrary to the copyright laws.

If you cannot record/play back images, perform [MEDIA FORMAT]

- If you repeat recording/deleting images for a long time, fragmentation of data may occur on the “Memory Stick PRO Duo” media. Images cannot be saved or recorded. In such a case, save your images on some type of external media first, and then perform [MEDIA FORMAT] (p. 45).

On playing back recorded images on other devices

- Your camcorder is compatible with MPEG-4 AVC/H.264 High Profile for HD (high definition) image quality recording. Therefore, you cannot play back images recorded with HD (high definition) image quality on your camcorder with the following devices;
 - Other AVCHD format compatible devices which are not compatible with High Profile
 - Devices which are not compatible with the AVCHD format

Save all your recorded image data

- To prevent your image data from being lost, save all your recorded images on external media. It is recommended that you save the image data on a disc such as DVD-R using your computer, etc. (p. 33). Also, you can save your image data using a VCR, or a DVD/HDD recorder (p. 40).
- It is recommended that you save your image data periodically, after recording.

About this manual

- The images of the LCD screen used in this manual for illustration purposes are captured using a digital still camera, and therefore may appear different.
- Design and specifications of your camcorder and accessories are subject to change without notice.

About the Carl Zeiss lens

Your camcorder is equipped with a Carl Zeiss lens, which was developed jointly by Carl Zeiss, in Germany, and Sony Corporation, and produces superior images. It adopts the MTF measurement system for video cameras and offers a quality typical of a Carl Zeiss lens.

MTF = Modulation Transfer Function. The number value indicates the amount of light from a subject coming into the lens.

Table of Contents

Read this before operating your camcorder	2
---	---

Getting Started

Step 1: Checking supplied items	8
Step 2: Charging the battery pack	9
Step 3: Turning the power on, and setting the date and time	12
Changing the language setting	13
Step 4: Inserting "Memory Stick PRO Duo" media	14

Recording/Playback

Using the HOME MENU	16
Recording	18
Preventing operation errors	20
Zooming	20
Recording high quality still images during movie recording (Dual Rec)	21
Recording the fast action in slow-motion (SMTH SLW REC)	21
Controlling the image settings manually with the CAM CTRL dial	22
Playback	23
Searching for desired scene by pinpoint (Film Roll Index)	26
Searching for desired scene by face (Face Index)	26
Searching for desired images by date (Date Index)	27
Using PB zoom	27
Playing back a series of still images (Slide show)	28
Playing the image on a TV	28
Saving images	33







Editing

 (OTHERS) category	34
Deleting images	34
Capturing a still image from a movie	36
Dividing a movie	37
Creating the Playlist	38
Dubbing to other devices	40
Printing recorded images (PictBridge compliant printer)	42

Utilizing Media

 (MANAGE MEDIA) category	44
Setting the image quality	44
Checking the “Memory Stick PRO Duo” media information	45
Deleting all images (Formatting)	45
Repairing the image database file	46

Customizing Your Camcorder

What you can do with the  (SETTINGS) category of the  HOME MENU	47
Using the HOME MENU	47
List of the  (SETTINGS) category items	48
MOVIE SETTINGS	49
(Items for recording movies)	
PHOTO SETTINGS	52
(Items for recording still images)	
VIEW IMAGES SET	53
(Items to customize the display)	
SOUND/DISP SET	55
(Items to adjust the sound and the screen)	
OUTPUT SETTINGS	56
(Items for when connecting other devices)	
CLOCK/ LANG	57
(Items to set clock and language)	
GENERAL SET	57
(Other setup items)	
Activating functions using the  OPTION MENU	59
Using the OPTION MENU	59
Recording items on the OPTION MENU	60
Viewing items on the OPTION MENU	60
Functions set in the  OPTION MENU	61

Enjoying with a computer

Performing with a computer	66
----------------------------------	----

Troubleshooting

Troubleshooting	69
-----------------------	----

Warning indicators and messages	74
---------------------------------------	----

Additional Information

Files/folder structure on the “Memory Stick PRO Duo” media	77
Maintenance and precautions	78
About the AVCHD format	78
About the “Memory Stick” media	78
About the “InfoLITHIUM” battery pack	79
About handling of your camcorder	80
Specifications	83

Quick Reference

Identifying parts and controls	87
Indicators displayed during recording/playback	91
Index	93

Step 1: Checking supplied items

Make sure that you have the following items supplied with your camcorder. The number in the parentheses indicates the number of that item supplied.

AC Adaptor (1) (p. 9)

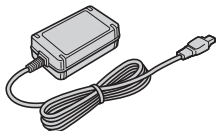

Power cord (Mains lead) (1) (p. 9)

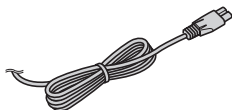

Component A/V cable (1) (p. 29)

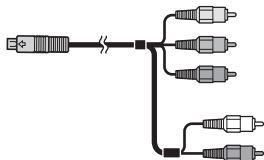

A/V connecting cable (1) (p. 31, 40)



USB cable (1) (p. 41, 42)

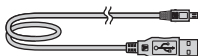

Rechargeable battery pack NP-FH60 (1) (p. 9)

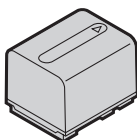

Controller hook (1) (p. 89)

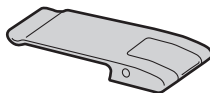

Cable clammer (1) (p. 90)

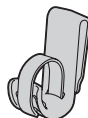

CD-ROM "Video Camera Application Software" (1)

– PMB (Picture Motion Browser) including PMB Guide (p. 68)

CD-ROM "Manuals for Digital HD Video Camera Recorder" (1)

"Operating Guide" (2)

Step 2: Charging the battery pack

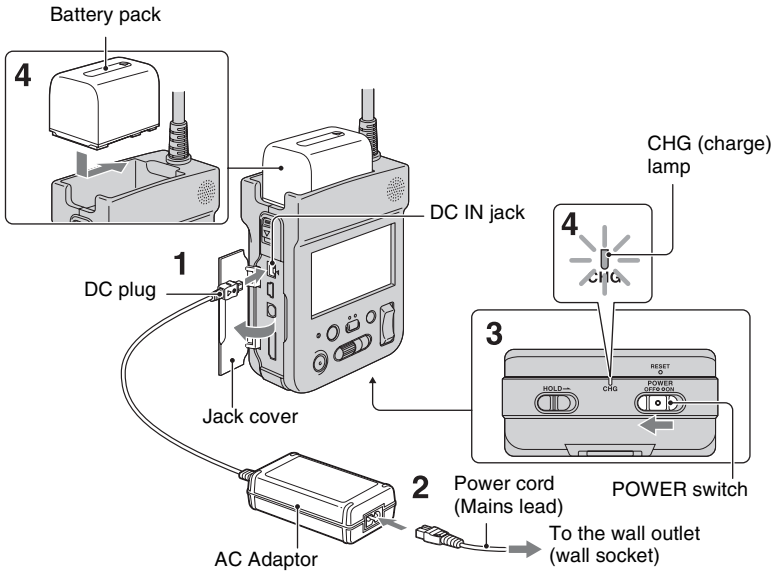

You can charge the “InfoLITHIUM” battery pack H series (p. 79) after attaching it to your camcorder.

⚡ Notes

- You cannot attach any “InfoLITHIUM” battery pack other than H series to your camcorder.

1 Open the jack cover, then align the ▲ mark of the DC plug with the ▼ of the DC IN jack on the camcorder, then connect the DC plug to the DC IN jack on the camcorder.

2 Connect the power cord (mains lead) to the AC Adaptor and the wall outlet (wall socket).

3 Slide the POWER switch to OFF (the default setting).

4 Attach the battery pack by sliding it in the direction of the arrow until it clicks.

The CHG (charge) lamp lights up and charging starts. When the CHG (charge) lamp turns off, the battery pack is fully charged.

⚡ Notes

- Disconnect the AC Adaptor from the DC IN jack holding both the camcorder and the DC plug.

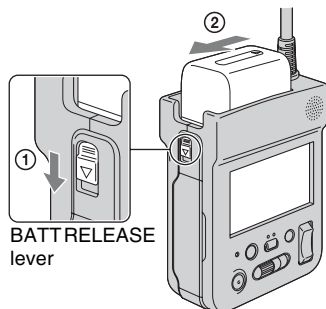

To remove the battery pack

Slide the POWER switch to OFF.
Slide the BATT RELEASE lever and remove the battery pack.



BATT RELEASE lever

Notes

- When you remove the battery pack or disconnect the AC Adaptor, make sure that the  (Movie) lamp/ (Still) lamp (p. 12)/access lamp (p. 14) are turned off. If you remove the battery pack or disconnect the AC Adaptor while the power is turned on, the setting cannot be saved.
- When you store the battery pack, fully discharge the battery before storing it for an extended period (see page 80 for the details of storage).

To use a power source from a wall outlet (wall socket)

Make the same connections as you do when charging the battery pack. The battery pack will not lose its charge in this case.

To check the remaining battery (Battery Info)

Slide the POWER switch to OFF, then press DISPLAY/BATT INFO.

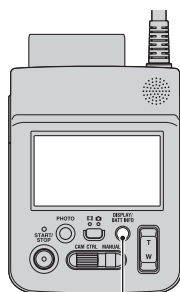

DISPLAY/BATT INFO

After a while, the approximate recordable time and battery information appear for about 7 seconds. You can view the battery information for up to 20 seconds by pressing DISPLAY/BATT INFO again while the information is displayed.

Remaining battery (approx.)

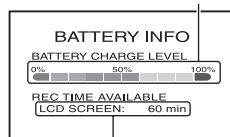

Recording capacity (approx.)

Charging time

Approximate time (min.) required when you fully charge a fully discharged battery pack.

Battery pack	Charging time
NP-FH50	135
NP-FH60 (supplied)	135
NP-FH70	170
NP-FH100	390

Approximate available recording time

Approximate time (min.) available when you use a fully charged battery pack. "HD" stands for high definition image quality, and "SD" stands for standard image quality.

Battery pack	Continuous recording time		Typical recording time*	
	HD	SD	HD	SD
Image quality				
NP-FH50	80	100	40	50
NP-FH60 (supplied)	110	130	55	65
NP-FH70	180	215	90	105
NP-FH100	405	485	200	240

* Typical recording time shows the time when you repeat recording start/stop, turning the power on/off and zooming.

Notes

- All times measured under the following conditions:
 - [REC MODE]: [HD FH] or [SD HQ]
 - When the LCD backlight turns on



Approximate playback time

Approximate time (min.) available when you use a fully charged battery pack. "HD" stands for high definition image quality, and "SD" stands for standard image quality.

Battery pack	Playing back on the LCD screen*	
	HD	SD
Image quality		
NP-FH50	125	140
NP-FH60 (supplied)	165	190
NP-FH70	270	300
NP-FH100	600	680

* When the LCD backlight is on.

On the battery pack

- When you remove the battery pack, turn off your camcorder, and turn off the  (Movie lamp)  (Still lamp (p. 12)/access lamp (p. 14)).
- The CHG (charge) lamp flashes during charging, or Battery Info (p. 10) will not be correctly displayed under the following conditions:
 - The battery pack is not attached correctly.
 - The battery pack is damaged.
 - The battery pack is worn-out (for Battery Info only).
- The power will not be supplied from the battery as long as the AC Adaptor is connected to the DC IN jack of your camcorder, even when the power cord (mains lead) is disconnected from the wall outlet (wall socket).
- We do not recommend using an NP-FH30, which only allows short recording and playback times, with your camcorder.



On the charging/recording/playback time

- Times measured with the camcorder at 25°C (77°F). 10°C to 30°C (50°F to 86°F) is recommended.
- The recording and playback time will be shorter when you use your camcorder in low temperatures.
- The recording and playback time will be shorter depending on the conditions under which you use your camcorder.

On the AC Adaptor

- Use the nearby wall outlet (wall socket) when using the AC Adaptor. Disconnect the AC Adaptor from the wall outlet (wall socket) immediately if any malfunction occurs while using your camcorder.
- Do not use the AC Adaptor placed in a narrow space, such as between a wall and furniture.
- Do not short-circuit the DC plug of the AC Adaptor or battery terminal with any metallic objects. This may cause a malfunction.
- Even if your camcorder is turned off, AC power source (mains) is still supplied to it while connected to the wall outlet (wall socket) via the AC Adaptor.

Step 3: Turning the power on, and setting the date and time

Set the date and time when using this camcorder for the first time.
If you do not set the date and time, the [CLOCK SET] screen appears every time you turn on your camcorder or press the  (Movie)/ (Still) select button.

Touch the button on the LCD screen.

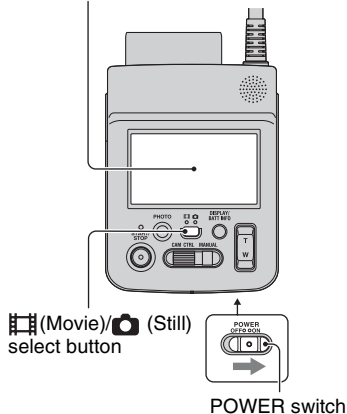

1 Turn on your camcorder.

While pressing the green button, slide the POWER switch to ON.

2 Press the (Movie)/ (Still) select button and turn on the desired mode lamp.

 (Movie): To record movies

 (Still): To record still images

Go to step 4 when you turn on your camcorder for the first time.

3 Touch (HOME) → (SETTINGS) → [CLOCK/ LANG] → [CLOCK SET].

The [CLOCK SET] screen appears.

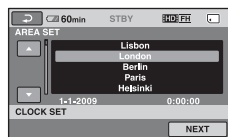

4 Select the desired geographical area with /, then touch [NEXT].

5 Set [SUMMERTIME], then touch [NEXT].

6 Set [Y] (year) with /.



7 Select [M] with /, then set the month with /.

8 Set [D] (day), hour and minute in the same way, then touch [NEXT].





9 Make sure that the clock is correctly set, then touch .

The clock starts.

You can set any year up to the year 2037.

Changing the language setting

You can change the on-screen displays to show messages in a specified language. To select the screen language, touch

 (HOME) →  (SETTINGS) → [CLOCK/
 LANG] → [ LANGUAGE SET] (p. 57).

To turn off the LCD backlight to make the battery last longer



Press and hold DISPLAY/BATT INFO for a few seconds until  appears.

This setting is practical when you use your camcorder in bright conditions or you want to save battery power. The recorded image will not be affected by the setting. To turn on the LCD backlight, press and hold DISPLAY/BATT INFO for a few seconds until  disappears.

Notes

- If you do not use your camcorder for **about 3 months**, the built-in rechargeable battery gets discharged and the date and time settings may be cleared from the memory. In that case, charge the built-in rechargeable battery and then set the date and time again (p. 83).
- It takes a few seconds for your camcorder to be ready to shoot after the power is turned on. You cannot operate your camcorder during this time.

Tips

- Touch  (HOME) →  (SETTINGS) → [SOUND/DISP SET] → [LCD BRIGHT] (p. 55), and adjust the brightness of the LCD screen.
- The information is displayed or hidden (display ↔ no display) each time you press DISPLAY/BATT INFO.
- The date and time does not appear during recording, but they are automatically recorded on the “Memory Stick PRO Duo” media, and can be displayed during playback ([DATA CODE], p. 53).
- If the buttons on the touch panel do not work correctly, adjust the touch panel (CALIBRATION, p. 82).

Step 4: Inserting “Memory Stick PRO Duo” media

See page 2 on the “Memory Stick” media you can use with your camcorder.

💡 Tips

- See following pages on the recordable time of movies and recordable number of still images.
 - Movies (p. 15)
 - Still images (p. 52)

1 Insert the “Memory Stick PRO Duo” media.

- 1 Open the “Memory Stick Duo” media cover.
- 2 Insert the “Memory Stick PRO Duo” media all the way in until it clicks.
- 3 Close the “Memory Stick Duo” media cover.

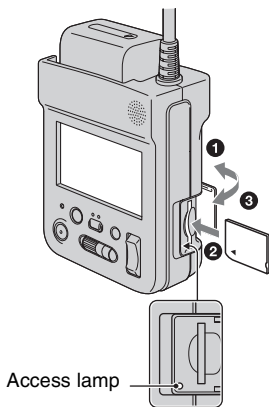

2 While pressing the green button, slide the POWER switch to ON to turn on the (Movie) lamp.

When you insert new “Memory Stick PRO Duo” media, the [Create a new Image Database File.] screen appears.





3 Touch [YES].

To eject “Memory Stick PRO Duo” media

Open the “Memory Stick Duo” media cover, lightly push the “Memory Stick PRO Duo” media in once.

⚙️ Notes

- Do not do any of the following when the  (Movie)/ (Still) mode lamps (p. 12) or the access lamp (p. 14) is lit or flashing. Otherwise, the media may be damaged, recorded images may be lost or other malfunctions could occur.
 - Eject the “Memory Stick PRO Duo” media from the camcorder
 - Remove the battery pack or AC Adaptor
 - Shake or knock your camcorder
- Do not open the “Memory Stick Duo” media cover during recording.
- If you force the “Memory Stick PRO Duo” media into the slot in the wrong direction, the “Memory Stick PRO Duo” media, the “Memory Stick Duo” media slot, or image data may be damaged.
- If [Failed to create a new Image Database File. It may be possible that there is not enough free space.] is displayed on step 3, format the “Memory Stick PRO Duo” media (p. 45). Note that formatting will delete all data recorded on the “Memory Stick PRO Duo” media.
- When inserting or ejecting the “Memory Stick PRO Duo” media, be careful so that the “Memory Stick PRO Duo” media does not pop out and drop.

💡 Tips

- You can shoot still images without creating a management file.

Expected recording time of movies

The recording time depends on the capacity of “Memory Stick PRO Duo” media and [REC MODE] (p. 49). Numbers in () indicates the minimum recording time.

HD (high definition) image quality

(min.)

	AVC HD 16M (FH)*	AVC HD 9M (HQ)**	AVC HD 7M (SP)**	AVC HD 5M (LP)**
1GB	6 (6)	10 (9)	15 (10)	20 (15)
2GB	10 (10)	25 (20)	30 (20)	40 (35)
4GB	25 (25)	55 (40)	65 (45)	85 (70)
8GB	55 (55)	115 (80)	140 (100)	180 (145)
16GB	110 (110)	230 (160)	280 (200)	355 (290)

* Movies are recorded with AVCHD 1920 × 1080/50i format.

** Movies are recorded with AVCHD 1440 × 1080/50i format.

SD (standard definition) image quality

(min.)

	SD 9M (HQ)	SD 6M (SP)	SD 3M (LP)
1GB	10 (10)	20 (10)	35 (25)
2GB	25 (25)	40 (25)	80 (50)
4GB	55 (50)	80 (50)	160 (105)
8GB	115 (100)	170 (100)	325 (215)
16GB	230 (205)	340 (205)	655 (435)

Notes

- When using “Memory Stick PRO Duo” media made by Sony Corporation. The recordable time for movies varies depending on the recording conditions, subject conditions, and the type of “Memory Stick” media.

Tips

- Figures such as 16M in the table show the average bit rate. M stands for Mbps.
- For the number of recordable still images, see page 52.
- You can record movies of a maximum of 3,999 scenes with HD (high definition) image quality, and 9,999 scenes with SD (standard definition) image quality.
- This technology causes fluctuations in the recording time of the “Memory Stick PRO Duo” media. Movies containing quickly moving and complex images are recorded at a higher bit rate, and this reduces the overall recording time.

Using the HOME MENU

You can change the recording functions and the operating settings for your convenience.

- 1** While pressing the green button, slide the **POWER** switch to **ON**.

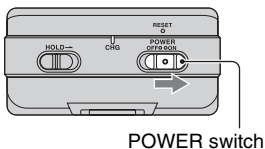

POWER switch

- 2** Touch  (**HOME**).

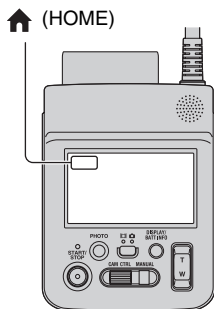

- 3** Touch the desired category.

Example:  (**OTHERS**) category



- 4** Touch the desired item.

Example: [EDIT]

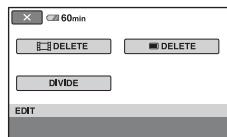

- 5** Follow the guide on the screen for further operation.

To hide the HOME MENU screen

Touch .

To see the explanation of the HOME MENU (HELP)

- ① Touch  (**HOME**).

The HOME MENU appears.



- ② Touch  (**HELP**).

The bottom of the  (**HELP**) turns orange.



- ③ Touch the item you want to learn more about.



When you touch an item, its explanation appears on the screen. To apply the option, touch [YES], otherwise, touch [NO].

💡 Tips

- To deactivate the HELP, touch [?] (HELP) again in step ②.

Recording

In the default setting, the image quality is set to HD (high definition). To change the image quality, refer to “Setting the image quality” (p. 44).

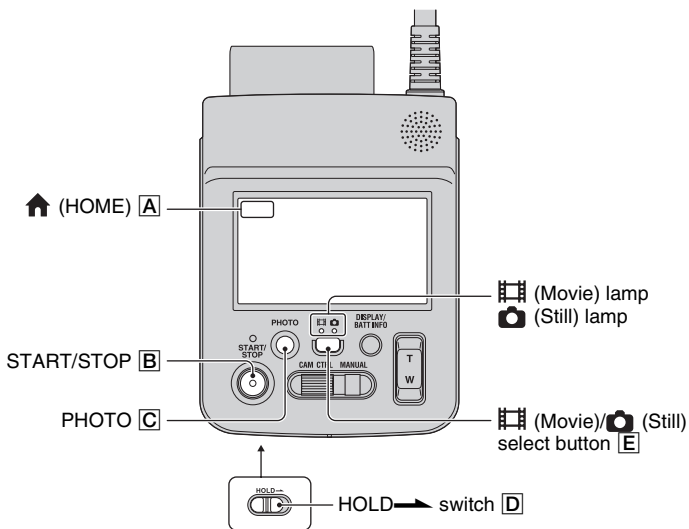

Notes

- If you aim the lens towards a strong light source, such as car headlights or the sun, a “ghost” caused by the lens may appear in the picture.
- If the access lamp is lit or flashing after recording is finished, it means data is still being written onto the “Memory Stick PRO Duo” media. Do not apply shock or vibration to your camcorder, and do not remove the battery or AC Adaptor.
- When a movie file exceeds 2 GB, the next movie file is created automatically.
- When the HOLD switch **D** is set to the right, the buttons and touch panel cannot be operated (p. 20).

Tips

- For types of “Memory Stick” media you can use in your camcorder, see page 2.
- You can check the recordable time and the remaining capacity, etc., by touching **A** (HOME) → **MANAGE MEDIA** → [MEDIA INFO] (p. 45).
- The image is displayed in a smaller recording angle on the LCD screen of the main body (approx. 92%) than when the image signal is output from A/V Remote Connector or HDMI OUT jack and viewing the image on a monitor device.
To set the recording angle in detail, it is recommended to check the image displayed on the monitor device before setting the recording angle.

Recording movies



1 While pressing the green button, slide the POWER switch to ON to turn on the (Movie) lamp.

2 Press START/STOP **B**.

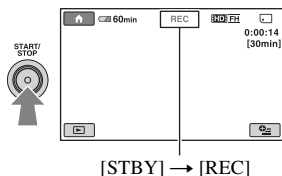

To stop recording, press START/STOP **B** again.

Recording still images



1 While pressing the green button, slide the POWER switch to ON.

2 Press the (Movie)/ (Still) select button **E** until the (Still) lamp lights up.

3 Press PHOTO **C** lightly to adjust the focus **A** (a beep sounds), then press it fully **B** (a shutter click sounds).

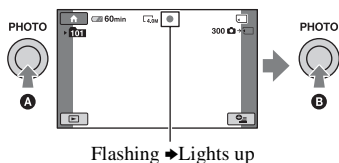

appears beside . When disappears, the image has been recorded.

Tips



- For the recordable time and the number of recordable images, see page 15 and 52.
- You can record still images during movie recording by pressing PHOTO **C** ([Dual Rec], p. 21).
- You can capture still images from recorded movies (p. 36).
- You can switch the shooting mode by touching (HOME) **A** → (CAMERA) → [MOVIE] or [PHOTO].

Preventing operation errors

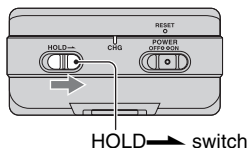
If you slide the HOLD  switch to the right, the buttons cannot function. Use this function to prevent pressing incorrect buttons.



The following operations become invalid.

- Touch panel
- START/STOP button (p. 18)
- PHOTO button (p. 18)
-  (Movie)/ (Still) select button (p. 18)
- DISPLAY/BATT INFO button (p. 10)
- CAM CTRL dial (p. 22)
- Power zoom lever
- MANUAL button (p. 22)

Tips

- The following functions are still available, when the HOLD  switch is set to the right.
 - POWER switch
 - DISPLAY/BATT INFO button (p. 10)
(displays the Battery Info when the POWER switch is set to OFF)
 - [A.SHUT OFF] (p. 57)

Zooming

You can magnify images up to 10 times the original size with the power zoom lever.

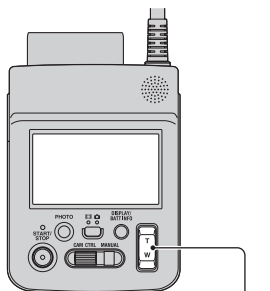

Close view: (Telephoto)

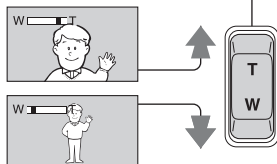

Wider range of view: (Wide angle)

Move the power zoom lever slightly for a slower zoom. Move it further for a faster zoom.

Notes

- The minimum possible distance between camcorder and subject while maintaining sharp focus is about 1 cm (about 13/32 in.) for wide angle and about 80 cm (about 2 5/8 feet) for telephoto.

Tips

- You can set [DIGITAL ZOOM] (p. 50) if you want to zoom to a level greater than 10 × when recording movies.

Recording high quality still images during movie recording (Dual Rec)

You can record high quality still images during movie recording by pressing PHOTO.

Notes

- Do not eject the “Memory Stick PRO Duo” media before movie recording is finished and the still images are completely stored on the “Memory Stick PRO Duo” media.
- may appear when the capacity of the “Memory Stick PRO Duo” media is not enough or when you record still images continuously. You cannot record still images while is displayed.

Tips

- When the (Movie) lamp is lit, the size of still images becomes [2.3M] (16:9 wide) or [1.7M] (4:3).
- You can record still images during recording standby in the same way as when the (Still) lamp is turned on.

Recording the fast action in slow-motion (SMTH SLW REC)

Fast moving subjects and actions, which cannot be captured under the ordinary shooting conditions, can be shot in smooth moving slow-motion for about 3 seconds. This is useful to shoot fast actions such as a golf or tennis swing.

- Touch (HOME) → (CAMERA) → [SMTH SLW REC].

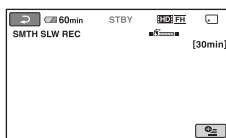

- Press START/STOP.

A 3-second movie (approx.) is recorded as a 12 second-slow-motion-movie.

[Recording...] disappears, when recording is finished.

Touch () to cancel the smooth slow recording.

To change the setting

Touch (OPTION) → () tab, then select the setting you want to change.

- [TIMING]
 - Select the recording start point after START/STOP is pressed. The default setting is [3sec AFTER].

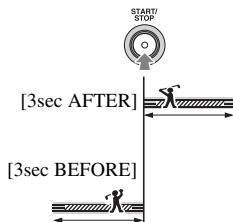

- [RECORD SOUND]
 - Select [ON] () to superimpose sounds such as conversation on the slow motion pictures (The default setting is [OFF]). Your camcorder records sounds for about 12 seconds while [Recording...] is displayed in step ②.

Notes

- Sounds cannot be recorded while shooting a 3-second movie (approx.).
- Image quality of [SMTH SLW REC] is not as good as that of normal recording.

Controlling the image settings manually with the CAM CTRL dial

You can assign one menu item you use often to the CAM CTRL dial. Since the focus adjustment is assigned to the CAM CTRL dial in the default settings, the operation below is described as adjusting the focus using the dial.

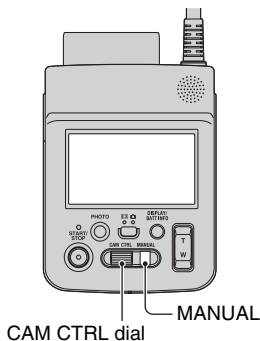

- ① Press MANUAL to activate the manual adjustment mode.
Pressing MANUAL switches the setting mode between automatic and manual.
- ② Rotate the CAM CTRL dial to adjust the focus.

Items you can assign to the CAM CTRL dial

- [FOCUS] (p. 61)
- [EXPOSURE] (p. 62)
- [AE SHIFT] (p. 49)
- [WB SHIFT] (p. 49)

To assign the menu items to the CAM CTRL dial

- ① Press and hold MANUAL for a few seconds.
The [DIAL SETTING] screen appears.

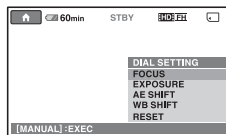



- ② Rotate the CAM CTRL dial and select the item to be assigned.
- ③ Press MANUAL.

Notes

- Manual settings will be retained even if you change the assigned item of the CAM CTRL dial. However, if you set [EXPOSURE] after setting [AE SHIFT] manually, [EXPOSURE] will override [AE SHIFT].
- If you select [RESET] in step ②, all the items adjusted manually are reset to the default settings.

Tips

- The functions of the items that can be assigned to the CAM CTRL dial are the same as those of menu operation.
- You can also assign menu items to the CAM CTRL dial by touching  (HOME) →  (SETTINGS) → [MOVIE SETTINGS]/[PHOTO SETTINGS] → [DIAL SETTING] (p. 51).

- ① :Goes to the Film Roll Index screen (p. 26).
- ② :Goes to the Face Index screen (p. 26).
- ③ **HD** :Displays movies with HD (high definition) image quality.*
- ④ :Displays still images.

* **SD** appears when you select the movie with SD (standard definition) image quality in **[HD/SD] SET** (p. 44).

Tips

- The number of the images on the VISUAL INDEX screen can be changed 6 ↔ 12 by moving the power zoom lever **[C]**. To fix this number, touch **HOME** **[A]** → **(SETTINGS)** → **[VIEW IMAGES SET]** → **[DISPLAY]** (p. 54).

3 Start playing back.

Playing movies

Touch the **HD** or **SD** tab, then select the desired movie to play back.

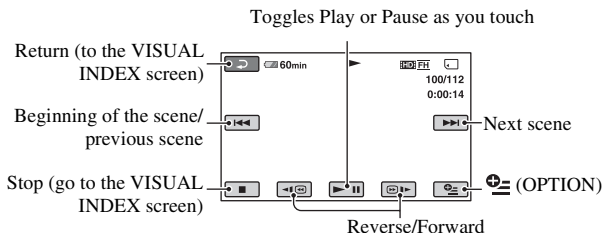

Tips

- When playback from the selected movie reaches the last movie, the screen returns to the VISUAL INDEX screen.
- Touch **[<|>]** / **[<|>]** during pause to play back movie slowly.
- A touch of **[<|>]** / **[<|>]** makes the reverse/fast forward approximately 5 times faster, 2 touches makes it approximately 10 times faster, 3 touches makes it approximately 30 times faster, and 4 touches makes it approximately 60 times faster.

To adjust the sound volume

Touch **(OPTION)** → **[VOLUME]** tab → **[VOLUME]**, then adjust the volume with **[-]** / **[+]**.

Viewing still images



Touch the tab, then select the desired still image to play back.

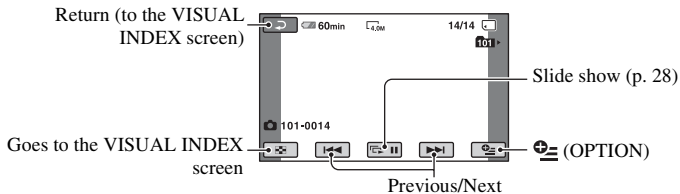

Tips

- You can switch the playback mode by touching (HOME) → (VIEW IMAGES) → [VISUAL INDEX].

Searching for desired scene by pinpoint (Film Roll Index)

Movies can be divided by a set time and the first scene of each division is displayed on the index screen. You can start playing back a movie from the selected thumbnail.

1 Turn on the camcorder, and touch (VIEW IMAGES).

The VISUAL INDEX screen appears.

2 Touch (Film Roll Index).

Returns to the VISUAL INDEX screen

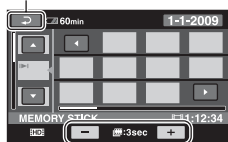



Sets the interval at which to create thumbnails of scenes in a movie.

3 Touch to select the desired movie.

4 Touch , to search for the desired scene, then touch the scene you want to play back.



Playback starts from the selected scene.

Tips

- You can display the [Film Roll Index] screen by touching  (HOME) →  (VIEW IMAGES) →  [INDEX].

Searching for desired scene by face (Face Index)

The face images detected during movie recording are displayed on the index screen. You can play back the movie from the selected face image.

Set [ INDEX SET] to [ON] before recording to play back from [ INDEX] (p. 51). Make sure that  flashes during recording, and detected face images are stored in [Face Index].

1 Turn on the camcorder, and touch (VIEW IMAGES).

The VISUAL INDEX screen appears.

2 Touch (Face Index).

Returns to the VISUAL INDEX screen

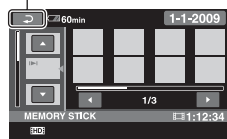

3 Touch to select the desired movie.

4 Touch , then touch the desired face image to view the scene.

Playback starts from the beginning of the scene with the selected face image.

Notes

- Faces may not be detected depending on recording conditions.
Example: People wearing glasses or hats, or who do not face towards the camera.

Tips

- You can display the [Face Index] screen by touching **HOME** → **VIEW IMAGES** → **INDEX**.

Searching for desired images by date (Date Index)

You can search for desired movies by date efficiently.

Notes

- You cannot use the Date Index function for still images.

1 Turn on the camcorder, and touch **VIEW IMAGES**.

The VISUAL INDEX screen appears.

2 Touch the **HD** or **SD** tab.

3 Touch date on the screen.

The recording dates of movies are displayed on the screen.

Returns to the VISUAL INDEX screen

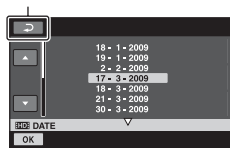

4 Touch **▲/▼** to select the date of the desired movie, then touch **OK**.

The movies of the selected date are displayed on the VISUAL INDEX screen.

Tips

- On the [Film Roll Index]/[Face Index] screen, you can use the Date Index function by following the steps **3** to **4**.

Using PB zoom

You can magnify still images from about 1.1 to 5 times the original size. Magnification can be adjusted with the power zoom lever.

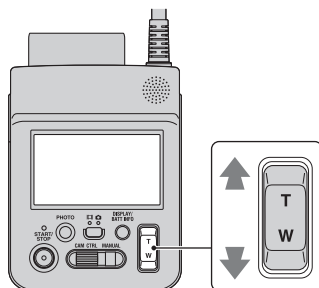



- 1 Play back the still images you want to magnify.
- 2 Magnify the still image with T (Telephoto). The screen is framed.
- 3 Touch the screen at the point you want to display in the center of the displayed frame.
- 4 Adjust the magnification with T (Telephoto)/W (Wide angle).

To cancel, touch **◀▶**.

Playing the image on a TV

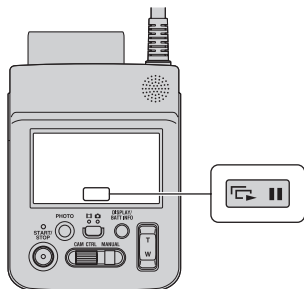
Playing back a series of still images (Slide show)



Touch  on the still image playback screen.

The slide show begins from the selected still image.





Touch  to stop the slide show.

To restart, touch  again.

Notes

- You cannot operate playback zoom during slide show.

Tips

- You can also play back the slide show by touching  (OPTION) →  tab → [SLIDE SHOW] on the VISUAL INDEX screen.
- You can set continuous slide show playback by touching  (OPTION) →  tab → [SLIDE SHOW SET]. The default setting is [ON] (continuous playback).

Connection methods and quality of the image viewed on the TV screen differ depending on what type of TV is connected, and the connectors used.

Use the supplied AC Adaptor as the power source (p. 9).

Refer also to the instruction manuals supplied with the device to be connected.

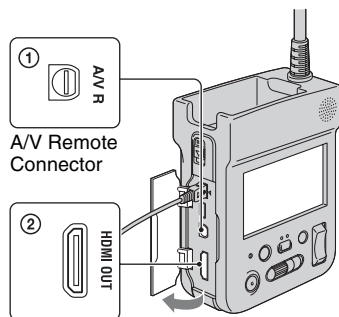

Open the jack cover.

Connecting to a high definition TV

Images recorded with HD (high definition) image quality are played back with HD (high definition) image quality. Images recorded with SD (standard definition) image quality are played back with SD (standard definition) image quality.

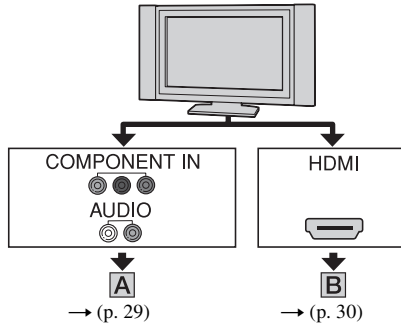

 : Signal flow

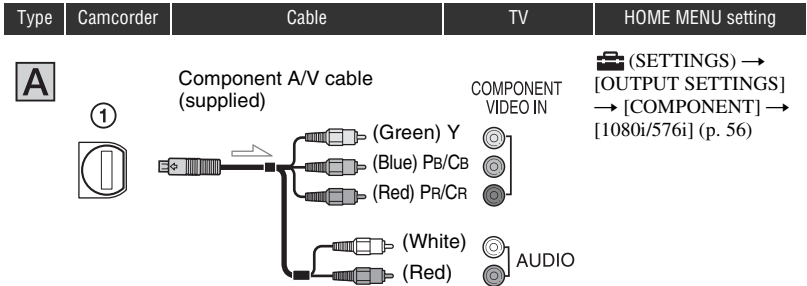

- If you connect only component video, audio signals are not output. Connect the white and red plugs to output audio signals.

Type	Camcorder	Cable	TV	HOME MENU setting
------	-----------	-------	----	-------------------

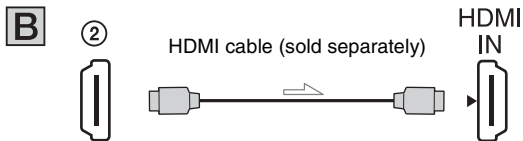

- Use an HDMI cable with the HDMI logo.
- Images are not output from the HDMI OUT jack of your camcorder, if copyright protection signals are recorded in the images.
- Some TVs may not function correctly (e.g., no sound or image) with this connection.
- Do not connect the HDMI OUT jack of your camcorder and HDMI OUT jack of the external device with the HDMI cable. This may cause a malfunction.
- HDMI (High Definition Multimedia Interface) is an interface to send both video/audio signals. The HDMI OUT jack outputs high quality images and digital audio.

Connecting to a non-high-definition 16:9 (wide) TV or 4:3 TV

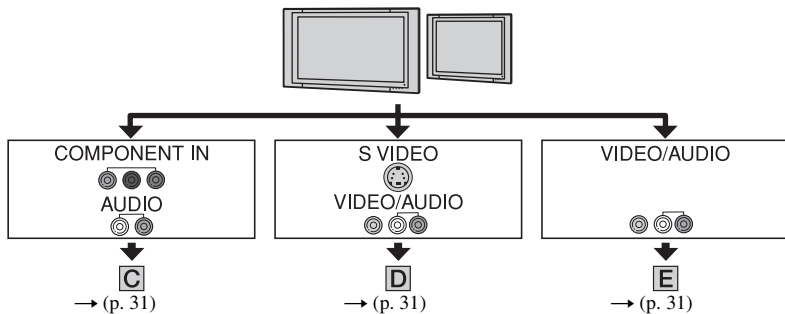

Images recorded with HD (high definition) quality are converted to SD (standard definition) and played back. Images recorded with SD (standard definition) image quality are played back with SD (standard definition) image quality.



To set the horizontal to vertical ratio according to the connected TV (16:9/4:3)

Set [TV TYPE] to [16:9] or [4:3] according to your TV (p. 56).

🔊 Notes

- When you play back a movie recorded with SD (standard definition) image quality on a 4:3 TV that is not compatible with the 16:9 signal, touch  (HOME) →  (SETTINGS) → [MOVIE SETTINGS] → [WIDE SELECT] → [4:3] on your camcorder when recording an image (p. 50).

↗: Signal flow

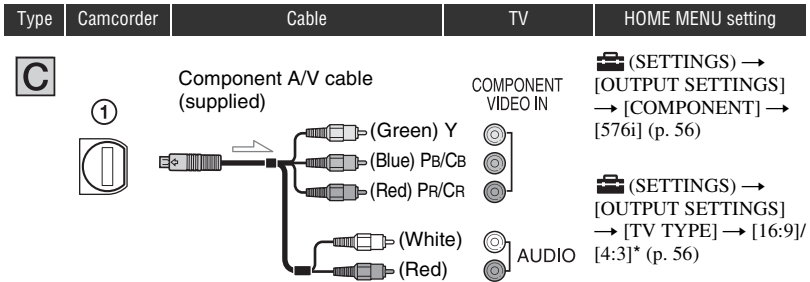

- If you connect only component video, audio signals are not output. Connect the white and red plugs to output audio signals.

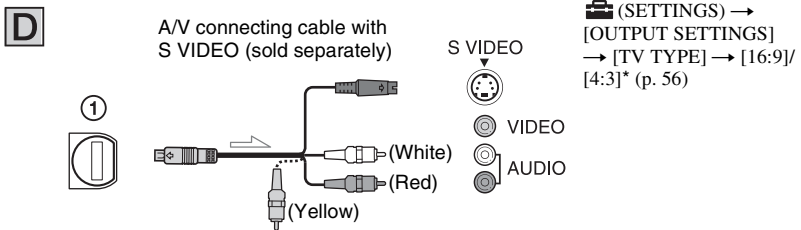

- When the S VIDEO plug (S VIDEO channel) is connected, audio signals are not output. To output audio signals, connect the white and red plugs to the audio input jack of your TV.
- This connection produces higher resolution images compared with the A/V connecting cable (Type **E**).



- * Set [TV TYPE] according to your TV.

If your TV/VCR has a 21-pin adaptor (EUROCONNECTOR)

You need the 21-pin adaptor (sold separately) to connect your camcorder to a TV for viewing recorded images (for models with the **CE** mark printed on the bottom surface only). This adaptor is designed for output use only.

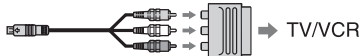

⚡ Notes

- When the A/V connecting cable is used to output images, images are output with SD (standard definition) image quality.

💡 Tips

- If you connect your camcorder to the TV using more than one type of cable to output images, the order of priority of the TV input jacks is as follows:
HDMI → component → S VIDEO → video.

Saving images

Recorded images are stored on the “Memory Stick PRO Duo” media. Due to the limited capacity of the “Memory Stick PRO Duo” media, make sure that you save the image data to some type of external media such as a DVD-R or a computer.

You can save the images recorded on the camcorder as described below.

Saving images using a computer

By using “PMB” on the supplied CD-ROM, you can save the images recorded on the “Memory Stick PRO Duo” media.

You can rewrite movies with HD (high definition) image quality from the computer to your camcorder, if necessary. For details, see “PMB Guide.”

Creating a disc with One Touch (One Touch Disc Burn)

You can save images recorded on the camcorder directly to a disc with ease.

Saving images on a computer

You can save images recorded on the camcorder on the hard disk of a computer.



Creating a disc with selected images

You can save images copied to your computer on a disc. You can also edit those images.



See page 66.

Saving images by connecting your camcorder to other devices

Connecting with the A/V connecting cable

You can dub movies with SD (standard definition) image quality.

Connecting with the USB cable

You can dub movies with HD (high definition) image quality or SD (standard definition) image quality.



See page 40.



(OTHERS) category

This category enables you to edit the images on the “Memory Stick PRO Duo” media. Also, you can enjoy your camcorder by connecting to other devices.

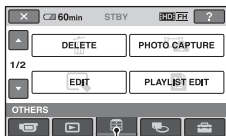

 (OTHERS) category

Item list

DELETE

You can delete images on the “Memory Stick PRO Duo” media (p. 34).

PHOTO CAPTURE

You can save a selected frame from a recorded movie as a still image (p. 36).

EDIT

You can edit the images (p. 37).

PLAYLIST EDIT

You can create and edit a Playlist (p. 38).

PRINT

You can print still images on a connected PictBridge printer (p. 42).

USB CONNECT

You can connect the camcorder to a computer etc., via the USB cable.

Deleting images

You can delete images recorded on the “Memory Stick PRO Duo” media using your camcorder.

Notes

- You cannot restore images once they are deleted.
- Do not remove the battery pack or the AC Adaptor, or eject “Memory Stick PRO Duo” media from your camcorder while deleting the images. It may damage the media.
- When write-protection is set to the images in the “Memory Stick PRO Duo” media by another device, you cannot delete the images.
- Important data should be saved on external media (p. 33).
- Do not try to delete the files on the “Memory Stick PRO Duo” media in your camcorder using a computer.

Tips



- You can select up to 100 images at one time.
- You can delete an image on the playback screen from  (OPTION) MENU.
- To delete all images recorded in the “Memory Stick PRO Duo” media, and recover all the recordable space, format the media (p. 45).

Deleting movies

You can increase the free space on the “Memory Stick PRO Duo” media by deleting image data.

You can check the free space on the “Memory Stick PRO Duo” media using [MEDIA INFO] (p. 45).

Select the image quality of the movie you want to delete before the operation (p. 44).

1 Touch  (HOME) →  (OTHERS) → [DELETE].

2 Touch  [DELETE].

3 Touch  [HSDI] [DELETE] or  [HSDI] [DELETE].

4 Touch the movie to be deleted.



The selected movie is marked with ✓. Press and hold the movie on the LCD screen to confirm the movie. Touch to return to the previous screen.

5 Touch → [YES] → .

To delete all movies at one time

In step 3, touch [] DELETE ALL/ [] DELETE ALL → [YES] → [YES] → .

To delete all the movies recorded on the same day at one time

① In step 3, touch [] DELETE by date]/ [] DELETE by date].

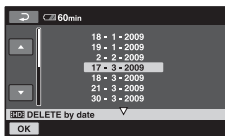

② Touch / to select the recording date of the desired movie, then touch .

The movies recorded on the selected date are displayed on the screen. Touch the movie on the LCD screen to confirm the movie. Touch to return to the previous screen.

③ Touch → [YES] → .

Notes

- If the deleted movie is included in the Playlist (p. 38), the movie added to the Playlist is deleted also from the Playlist.

Deleting still images

1 Touch (HOME) → (OTHERS) → [DELETE].

2 Touch [] DELETE].

3 Touch [] DELETE].

4 Touch the still image to be deleted.

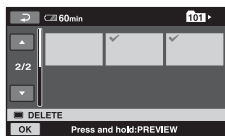

The selected still image is marked with ✓.

Press and hold the still image on the LCD screen to confirm the still image. Touch to return to the previous screen.

5 Touch → [YES] → .

To delete all still images at one time

In step 3, touch [] DELETE ALL] → [YES] → [YES] → .

Capturing a still image from a movie

You can save a selected frame from a recorded movie as a still image. Select the image quality of the movies to be captured before the operation (p. 44).

1 Touch (HOME) → (OTHERS) → [PHOTO CAPTURE].

The [PHOTO CAPTURE] screen appears.

2 Touch the movie to be captured.

The selected movie starts playback.

3 Touch at the point where you want to capture.

The movie pauses.

Adjusts the capturing point with more precision after the capturing point has been selected with .

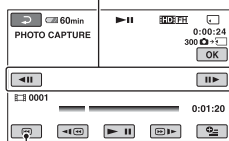

Returns to the beginning of the selected movie.



Play and pause toggles as you touch



4 Touch .

When capturing is finished, the screen returns to pause.



To continue capturing

Touch , then follow the steps **3** to **4**. To capture a still image from another movie, touch  then follow the steps **2** to **4**.

To finish capturing

Touch  → .

Notes

- The image size is fixed depending on the image quality of the movie:
 -  2.1M] with HD (high definition) image quality
 -  0.2M] in 16:9 (wide) with SD (standard definition) image quality
 - [VGA (0.3M)] in 4:3 with SD (standard definition) image quality
- The “Memory Stick PRO Duo” media should have enough free space.
- The recording date and time of captured still images is the same as the recording date and time of the movies.
- If the movie you are capturing from has no data code, the recording date and time of the still image will be the date and time you captured from the movie.

Dividing a movie

Select the image quality of the movie you want to divide before the operation (p. 44).

💡 Tips

- The images recorded on your camcorder are called “original.”

1 Touch **🏠 (HOME)** → **📁**
(OTHERS) → **[EDIT]**.

2 Touch **[DIVIDE]**.

3 Touch the movie to be divided.

The selected movie starts playback.

4 Touch **▶ ||** at the point where you want to divide the movie into scenes.

The movie pauses.

Adjusts the dividing point with more precision after the dividing point has been selected with **▶ ||**.



Returns to the beginning of the selected movie.

Play and pause toggles as you touch **▶ ||**.

5 Touch **OK** → **[YES]** → **OK**.

🔔 Notes

- You cannot restore movies once they are divided.

- Do not remove the battery pack or the AC Adaptor, or eject the “Memory Stick PRO Duo” media from your camcorder while dividing the movie. It may damage the “Memory Stick PRO Duo” media.
- If you divide the original movie, the movie added to the Playlist will also be divided.
- A slight difference may occur from the point where you touch **▶ ||** and the actual dividing point based on about half-second increments.

Creating the Playlist

The Playlist is a list showing thumbnails of the movies that you have selected.

The original movies are not changed even if you edit or delete the movies added to the Playlist.

Select the image quality of the movie you want to create, play, or edit a Playlist before the operation (p. 44).

⚡ Notes

- Images with HD (high definition) image quality and SD (standard definition) image quality are added to an individual Playlist.

1 Touch **⬆** (HOME) → **📁**
(OTHERS) → [PLAYLIST EDIT].

2 Touch [HD] ADD] or [SD] ADD].

3 Touch the movie to be added to the Playlist.



The selected movie is marked with **✓**. Press and hold the movie on the LCD screen to confirm the movie. Touch **⬅** to return to the previous screen.

4 Touch **OK** → [YES] → **OK**.

To add all the movies recorded on the same day at one time

- ① In step **2**, touch [HD] ADD by date]/ [SD] ADD by date].
The recording dates of movies are displayed on the screen.

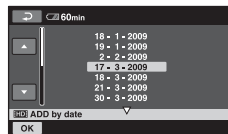

- ② Touch **▲**/**▼** to select the recording date of the desired movie.
- ③ Touch **OK** while the selected recording date is highlighted.
The movies recorded on the selected date are displayed on the screen. Touch the image on the LCD screen to confirm the movie. Touch **⬅** to return to the previous screen.
- ④ Touch **OK** → [YES] → **OK**.

⚡ Notes

- Do not remove the battery pack or the AC Adaptor, or eject the “Memory Stick PRO Duo” media from your camcorder while editing the Playlist. It may damage the “Memory Stick PRO Duo” media.
- You cannot add still images to a Playlist.
- You cannot create a Playlist which contains both HD (high definition) image quality and SD (standard definition) image quality.

💡 Tips

- You can add a movie on the playback screen or the INDEX screen by touching **OPTION**.
- You can copy the Playlist to a disc as it is, by using the supplied software.
- You can add a maximum of 999 movies with HD (high definition) image quality, or 99 movies with SD (standard definition) image quality to the Playlist.

Playing the Playlist

Select the image quality of the movie you want to create, play, or edit a Playlist before the operation (p. 44).

1 Touch **HOME** → **VIEW IMAGES** → **[PLAYLIST]**.

The Playlist screen appears.

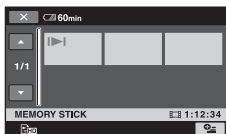

2 Touch the movie you want to play back.

The Playlist is played back from the selected movie to the end, then the screen returns to the Playlist screen.

To erase unnecessary movies from the Playlist

- 1 Touch **HOME** → **[OTHERS]** → **[PLAYLIST EDIT]**.
- 2 Touch **[ERASE]**/**[ERASE]**. To erase all the images from the Playlist, touch **[ERASE ALL]**/**[ERASE ALL]** → **[YES]** → **[OK]**.
- 3 Select the movie to be erased from the Playlist.



The selected movie is marked with ✓.

Press and hold the movie on the LCD screen to confirm the movie.

Touch **[RETURN]** to return to the previous screen.

- 4 Touch **[OK]** → **[YES]** → **[OK]**.

💡 Tips

- The original movies are not changed even if you erase the movies from the Playlist.

To change the order within the Playlist

- 1 Touch **HOME** → **[OTHERS]** → **[PLAYLIST EDIT]**.
- 2 Touch **[MOVE]**/**[MOVE]**.
- 3 Select the movie to be moved.

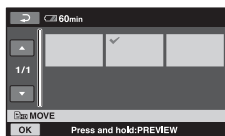

The selected movie is marked with ✓.

Press and hold the movie on the LCD screen to confirm the movie.

Touch **[RETURN]** to return to the previous screen.

- 4 Touch **[OK]**.
- 5 Select the destination with **[LEFT]**/**[RIGHT]**.

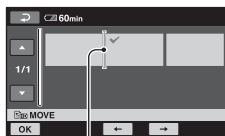

Destination bar

- 6 Touch **[OK]** → **[YES]** → **[OK]**.

💡 Tips

- When you select multiple movies, the movies are moved following the order appearing in the Playlist.

Dubbing to other devices

Connecting with the A/V connecting cable

You can dub images played back on your camcorder to other recording devices, such as VCRs or DVD/HDD recorders. Connect the device in either of the following ways.

Connect your camcorder to the wall outlet (wall socket) using the supplied AC Adaptor for this operation (p. 9). Refer also to the instruction manuals supplied with the devices to be connected.

Notes

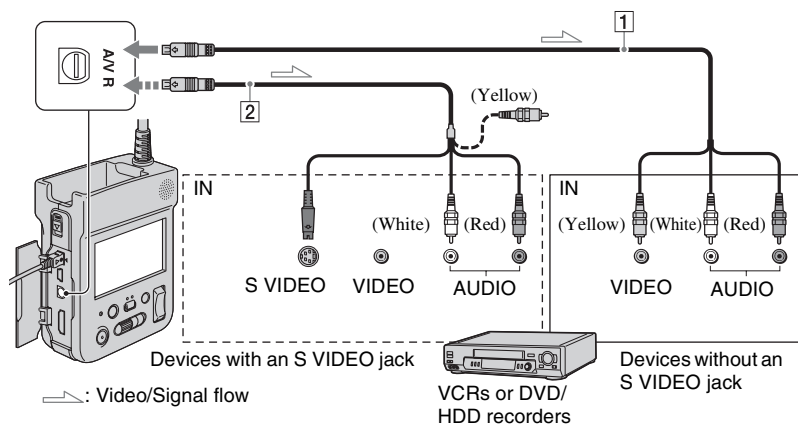

- **Movies recorded with HD (high definition) image quality will be dubbed with SD (standard definition) image quality.**
- To copy a movie recorded with HD (high definition) image quality, install the application software (supplied) on your computer, and copy the images to a disc in the computer.
- Since dubbing is performed via analog data transfer, the image quality may deteriorate.



- 1 A/V connecting cable (supplied)**
Connect to input jacks of other devices.

- 2 A/V connecting cable with S VIDEO (sold separately)**
When connecting to another device via the S VIDEO jack, by using an A/V connecting cable with an S VIDEO cable (sold separately), higher quality images can be produced than with an A/V connecting cable. Connect the white and red plug (left/right audio) and the S VIDEO plug (S VIDEO channel) of the A/V connecting cable with an S VIDEO cable (sold separately). The yellow plug connection is not necessary. S VIDEO connection only will not output audio.

Notes

- You cannot dub to recorders connected with an HDMI cable.
- To hide the screen indicators (such as a counter, etc.) on the screen of the monitor device connected, touch  (HOME) →  (SETTINGS) → [OUTPUT SETTINGS] → [DISP OUTPUT] → [LCD PANEL] (the default setting) on the HOME MENU (p. 56). To record the date/time and camera settings data, display them on the screen (p. 53).
- When you are connecting your camcorder to a monaural device, connect the yellow plug of the A/V connecting cable to the video input jack, and the red (right channel) or the white (left channel) plug to the audio input jack on the device.

1 Turn on your camcorder, and touch (VIEW IMAGES).

Set [TV TYPE] according to the display device (p. 56).

2 Insert the recording media in the recording device.

If your recording device has an input selector, set it to the input mode.

3 Connect your camcorder to the recording device (VCR or DVD/ HDD recorder) with the A/V connecting cable (supplied) or an A/V connecting cable with S VIDEO (sold separately) .

Connect your camcorder to the input jacks of the recording device.

4 Start the playback on your camcorder, and record it on the recording device.

Refer to the instruction manuals supplied with your recording device for details.

5 When dubbing is finished, stop the recording device, and then your camcorder.

Connecting with the USB cable

Connect your camcorder to a DVD writer, etc., compatible with movie dubbing via USB connection, to dub without image degradation.

Connect your camcorder to the wall outlet (wall socket) using the supplied AC Adaptor (p. 9). Refer also to the instruction manuals supplied with the device to be connected.

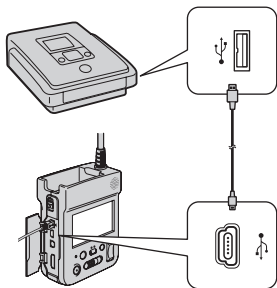

1 Turn on your camcorder.

2 Connect the (USB) jack and a DVD writer, etc., with the supplied USB cable (p. 87).

[USB SELECT] appears on the screen.

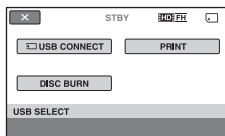

3 Touch [USB CONNECT].

4 Operate the device to be connected, and start recording.

For details, refer to the instruction manuals supplied with the device to be connected.

5 After dubbing is complete, touch [END] → [YES], then disconnect the USB cable.

Attention

This camcorder captures high definition footage in the AVCHD format. Using the enclosed PC software, high definition footage can be copied onto DVD media. However, DVD media containing AVCHD footage should not be used with DVD based players or recorders, as the DVD player/recorder may fail to eject the media and may erase its contents without warning. DVD media containing AVCHD footage may be played on a compatible Blu-ray Disc™ player/recorder or other compatible device.

Tips

- If the [USB SELECT] screen does not appear, touch (HOME) → (OTHERS) → [USB CONNECT].

Printing recorded images (PictBridge compliant printer)

You can print out still images using a PictBridge compliant printer, without connecting the camcorder to a computer.

PictBridge

Connect your camcorder to the AC Adaptor to obtain power from the wall outlet (wall socket) (p. 9). Turn on the printer. Insert the “Memory Stick PRO Duo” media containing the still images you want to print into your camcorder.

1 Turn on your camcorder.

2 Connect the (USB) jack to the printer using the USB cable (p. 87).

[USB SELECT] appears on the screen automatically.

3 Touch [PRINT].

When connection is complete, (PictBridge connecting) appears on the screen.

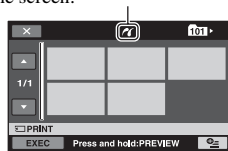

You can select a still image on the screen.

4 Touch the still image to be printed.

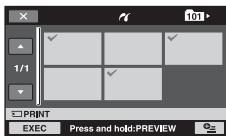

The selected still image is marked with ✓.

Press and hold the still image on the LCD screen to confirm the still image.

Touch to return to the previous screen.

5 Touch (OPTION), set the following options, then touch .

[COPIES]: Set the number of copies of a still image to be printed. You can set up to 20 copies.

[DATE/TIME]: Select [DATE], [DAY&TIME], or [OFF] (no date/time printed).

[SIZE]: Select the paper size.

If you do not change the setting, go to step 6.

6 Touch [EXEC] → [YES] → .

The image selection screen appears again.

- Refer also to the instruction manual of the printer to be used.
- Do not attempt the following operations when is on the screen. The operations may not be performed properly.
 - Slide the POWER switch to OFF
 - Press the (Movie)/ (Still) select button
 - Disconnect the USB cable from your camcorder or the printer
- If the printer stops working, disconnect the USB cable, turn the printer off and on again, and restart the operation from the beginning.
- You can select only the paper sizes that the printer can print.
- On some printer models, the top, bottom, right, and left edges of images may be trimmed. If you print a still image recorded in a 16:9 (wide) ratio, the left and right ends of the image may be trimmed widely.
- Some printer models may not support the date printing function. Refer to your printer's instruction manual for details.
- The still images described below may not be printed out:
 - The still image edited by a computer
 - The still image recorded by other devices
 - The still image file exceeding 4 MB
 - The still image file larger than 3,680 × 2,760 pixels

Tips

- PictBridge is an industry standard established by the Camera & Imaging Products Association (CIPA). You can print still images without using a computer by connecting a printer directly to a digital video camera or digital still camera, regardless of model or manufacturer.
- You can print a still image on the still image playback screen from (OPTION) MENU.

To finish printing

In step 3, touch on the image selection screen.

Notes

- We can guarantee the operation of only models that are PictBridge compatible.

(MANAGE MEDIA) category

This category enables you to use the “Memory Stick PRO Duo” media for various purposes.



 (MANAGE MEDIA) category

Item list

SET

You can select the image quality for movies (p. 44).

MEDIA INFO

You can display the “Memory Stick PRO Duo” media information such as the recordable time, etc. (p. 45).

MEDIA FORMAT

You can format the “Memory Stick PRO Duo” media and recover the recordable free space (p. 45).

REPAIR IMG.DB F.

You can repair the management information on the “Memory Stick PRO Duo” media (p. 46).

Setting the image quality

You can select the image quality for recording/playback/editing on your camcorder.

In the default setting, the image quality is set to HD (high definition).



Tips

- You can perform recording/playback/editing operations for the selected image quality. When you want to change the image quality, select the image quality again.

1 Touch  (HOME) →  (MANAGE MEDIA) →  SET].

The image quality setting screen appears.

2 Touch the desired image quality.

 indicates HD (high definition) image quality, and  indicates SD (standard definition) image quality.

3 Touch [YES] → .

The image quality is changed.

Checking the “Memory Stick PRO Duo” media information

You can check the remaining recordable time for each [REC MODE] (p. 49), and the approximate free and used space of the “Memory Stick PRO Duo” media.

1 Turn the  (Movie) lamp on.

2 Touch  (HOME) →  (MANAGE MEDIA) → [MEDIA INFO].

The remaining recordable time for each recording mode is displayed.

Tips

- You can check the recordable free space, etc. by touching  at the lower right on the screen.

To turn off the display

Touch .

Notes

- The calculation for space available on “Memory Stick PRO Duo” media is 1MB = 1,048,576 bytes. The fractions less than 1 MB are discarded when the “Memory Stick PRO Duo” media space is displayed. Therefore, the displayed size of the total space available on “Memory Stick PRO Duo” media, both free and used, will be slightly smaller than the advertised size of the “Memory Stick PRO Duo” media.
- Since there is a management file area, the used space is not displayed as 0 MB even if you perform [MEDIA FORMAT] (p. 45).

Deleting all images (Formatting)

Formatting deletes all the images to recover recordable free space.

To avoid the loss of important images, you should save them before formatting. Connect your camcorder to the wall outlet (wall socket) using the supplied AC Adaptor for this operation (p. 9).

1 Insert the “Memory Stick PRO Duo” media to be formatted into your camcorder.

2 Slide the POWER switch to ON to turn on the camcorder.

3 Touch  (HOME) →  (MANAGE MEDIA) → [MEDIA FORMAT].

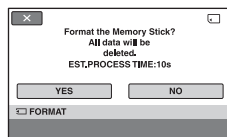

4 Touch [YES] → [YES].

5 When [Completed.] appears, touch .

Notes

- While the access lamp is lit, do not eject the “Memory Stick PRO Duo” media from your camcorder.
- Even the still images protected with another device against accidental deletion are also deleted.

Repairing the image database file

- Do not attempt the following operations when [Executing...] is on the screen:
 - Operate the POWER switch or buttons
 - Eject the “Memory Stick PRO Duo” media
- While [MEDIA FORMAT] is activated, do not disconnect the AC Adaptor.

This function checks the management information and the consistency of movies/still images in the “Memory Stick PRO Duo” media, and repairs any inconsistencies found.

- 1** Touch  (HOME) → 
(MANAGE MEDIA) → [REPAIR IMG.DB F.]

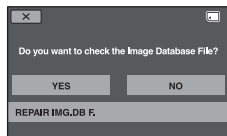

- 2** Touch [YES].

Your camcorder will check the management file.

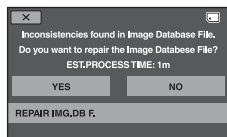

If no inconsistency was found, touch  to finish the operation.

- 3** Touch [YES].

- 4** After [Completed.] appears, touch .

Notes

- Do not apply mechanical shock or vibration to your camcorder, and do not remove the AC Adaptor or the battery pack, or eject “Memory Stick PRO Duo” media from your camcorder during the operation.

What you can do with the (SETTINGS) category of the HOME MENU

Using the HOME MENU

- 1 Turn on your camcorder, then touch  (HOME).

 (HOME)

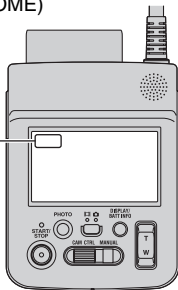



 (SETTINGS) category

- 2 Touch  (SETTINGS).



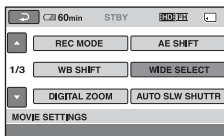

- 3 Touch the desired setup item.

If the item is not on the screen, touch / to change the page.



- 4 Touch the desired item.

If the item is not on the screen, touch / to change the page.

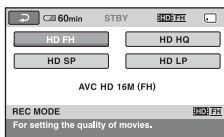

- 5 Change the setting, then touch .

List of the (SETTINGS) category items

MOVIE SETTINGS (p. 49)





Items	Page
REC MODE	49
AE SHIFT	49
WB SHIFT	49
WIDE SELECT	50
DIGITAL ZOOM	50
AUTO SLW SHUTTR	50
X.V.COLOR	50
GUIDEFRA	50
ZEBRA	50
 REMAINING SET	51
SUB-T DATE	51
DIAL SETTING	51
 INDEX SET	51

PHOTO SETTINGS (p. 52)

Items	Page
 IMAGE SIZE	52
FILE NO.	52
AE SHIFT	49
WB SHIFT	49
GUIDEFRA	50
ZEBRA	50
DIAL SETTING	51

VIEW IMAGES SET (p. 53)

Items	Page
DATA CODE	53
 DISPLAY	54

SOUND/DISP SET (p. 55)

Items	Page
VOLUME	55
BEEP	55
LCD BRIGHT	55
LCD BL LEVEL	55
LCD COLOR	55

OUTPUT SETTINGS (p. 56)

Items	Page
TV TYPE	56
DISP OUTPUT	56
COMPONENT	56

CLOCK/ LANG (p. 57)

Items	Page
CLOCK SET	12
AREA SET	57
SUMMERTIME	57
 LANGUAGE SET	57

GENERAL SET (p. 57)

Items	Page
REC LAMP	57
CALIBRATION	82
A.SHUT OFF	57
CTRL FOR HDMI	58

MOVIE SETTINGS

(Items for recording movies)



Touch ①, then ②.

If the item is not on the screen, touch to change the page.

How to set

(HOME MENU) → page 47

(OPTION MENU) → page 59

The default settings are marked with .

REC MODE (Recording mode)



You can select a recording quality to record a movie.

■ For HD (high definition) image quality:

► HD FH ()

Records in the highest quality mode.
(AVC HD 16M (FH))

HD HQ ()

Records in high quality mode.
(AVC HD 9M (HQ))

HD SP ()

Records in standard quality mode.
(AVC HD 7M (SP))

HD LP ()

Increases the recording time (Long Play).
(AVC HD 5M (LP))

■ For SD (standard definition) image quality:

► SD HQ ()

Records in high quality mode.
(SD 9M (HQ)).

SD SP ()

Records in standard quality mode.
(SD 6M (SP)).

SD LP ()

Increases the recording time (Long Play).
(SD 3M (LP))

Notes

- If you record in the LP mode, the quality of movies may be degraded, or scenes with quick movements may appear with block noise when you play back the image.

Tips

- See page 15 on the expected recording time of each recording mode.

AE SHIFT



Select [ON] to adjust the exposure using (dark)/ (bright).

and the setting value appear on the screen (The default setting is [OFF]).

Tips

- Touch if the subject is white or the backlight is bright, or touch if the subject is black or the light is dim.
- You can adjust the automatic exposure level to brighter or darker when [EXPOSURE] is set to [AUTO].
- You can also adjust the setting manually using the CAM CTRL dial (p. 22).

WB SHIFT (White Balance Shift)



Select [ON] to adjust the white balance to the desired setting using /.

and the setting value appear on the screen (The default setting is [OFF]).

Tips

- When the white balance is set to a lower value, images appear bluish, and when set to a higher value, images appear reddish.
- You can also adjust the setting manually using the CAM CTRL dial (p. 22).

WIDE SELECT



When recording with SD (standard definition) image quality, you can select the horizontal to vertical ratio according to the TV connected. Refer also to the instruction manuals supplied with your TV.

▶ 16:9 WIDE

Records images to the full screen on a 16:9 (wide) TV screen.

4:3 (4:3)

Records images to the full screen on a 4:3 TV screen.

🔊 Notes

- You cannot set this item when no “Memory Stick PRO Duo” media is inserted.
- Set [TV TYPE] correctly according to the TV connected for playback (p. 56).

DIGITAL ZOOM



You can select the maximum zoom level in case you want to zoom to a level greater than 10 × during recording. Note that the image quality decreases when you use the digital zoom.

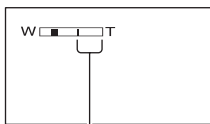

The right side of the bar shows the digital zooming factor. The zooming zone appears when you select the zooming level.

▶ OFF

Up to 10 × zoom is performed optically.

20 ×

Up to 10 × zoom is performed optically, and after that, up to 20 × zoom is performed digitally.

120 ×

Up to 10 × zoom is performed optically, and after that, up to 120 × zoom is performed digitally.

AUTO SLW SHUTTR (Auto Slow Shutter)



When recording in dark places, the shutter speed is automatically reduced to 1/25 second by setting [AUTO SLW SHUTTR] to [ON] (The default setting is [OFF]).

X.V.COLOR



When recording, set to [ON] to capture wider range of colors. Various colors such as the brilliant color of flowers and turquoise blue of the sea can be more faithfully reproduced (The default setting is [OFF]).

🔊 Notes

- Set [X.V.COLOR] to [ON] when the recorded content will be played back on an x.v.Color-compliant TV.
- If the movie recorded with this function [ON] is played back on a non-x.v.Color-compliant TV, the color may not be reproduced correctly.
- [X.V.COLOR] cannot be set to [ON]:
 - While recording with SD (standard definition) image quality
 - While recording a movie

GUIDEFAME



You can display the frame and check that the subject is horizontal or vertical by setting [GUIDEFAME] to [ON]. The frame is not recorded. Press DISPLAY/BATT INFO to make the frame disappear (The default setting is [OFF]).

💡 Tips

- Positioning the subject at the cross point of the guide frame makes a balanced composition.

ZEBRA



Diagonal stripes appear in portions of the screen where brightness is at a preset level. This is useful as a guide when adjusting the brightness. When you change the default

setting,  is displayed. The zebra pattern is not recorded.

► OFF

The zebra pattern is not displayed.

70

The zebra pattern appears at a screen brightness level of about 70 IRE.

100

The zebra pattern appears at a screen brightness level of about 100 IRE or higher.

Notes

- Portions of the screen where brightness is about 100 IRE or above may appear overexposed.

Tips

- IRE represents the unit of images brightness amplitude.



REMAINING SET

► ON

Always displays the remaining “Memory Stick PRO Duo” media indicator.

AUTO

Displays the remaining recording time of movies for about 8 seconds in situations such as those described below.

- When your camcorder recognizes the remaining “Memory Stick PRO Duo” media capacity while the  (Movie) lamp lights up
- When you press DISPLAY/BATT INFO to switch the indicator from off to on while the  (Movie) lamp lights up
- When you select the movie recording mode on the HOME MENU.

Notes

- When the remaining recordable time for movies is less than 5 minutes, the indicator stays on the screen.

SUB-T DATE (Subtitle date)

When you set to [ON] (the default setting), you can display the recording date and time while playing back the images recorded on your camcorder, on devices compatible with the subtitle display function. Refer also to the instruction manual of the display device.

Notes

- The images recorded with HD (high definition) image quality can be played back only on AVCHD format compatible devices.
- [SUB-T DATE] cannot be set for SD (standard definition) image quality.



DIAL SETTING

You can select an item you want to set to the CAM CTRL dial. For details, see page 22.

INDEX SET

This setting allows you to search for faces automatically and to display the [Face Index] screen (p. 26) (The default setting is [OFF]).

Face icons and their meanings

- : This icon appears when the setting is [ON].
- : This icon flashes when your camcorder detects a face. The icon stops flashing when the face is recorded in the [Face Index].
- : This icon appears when faces cannot be recorded in the [Face Index].*

* The number of faces that can be detected is limited.

PHOTO SETTINGS

(Items for recording still images)



Touch ①, then ②.

If the item is not on the screen, touch to change the page.

How to set

(HOME MENU) → page 47

(OPTION MENU) → page 59

The default settings are marked with .

IMAGE SIZE

▶ 4.0M ()

Records still images clearly (2,304 × 1,728).

3.0M ()

Records still images clearly in the 16:9 (wide) ratio (2,304 × 1,296).

1.9M ()

Allows you to record more still images in relatively clear quality (1,600 × 1,200).

VGA (0.3M) ()

Allows the maximum number of still images to be recorded (640 × 480).

Notes

- The set image size is effective during the (Still) lamp turning on.

Capacity of the “Memory Stick PRO Duo” media and the number of recordable images (Unit: number of images)*

When the (Still) lamp lights up:

	4.0M 2304 × 1728
1GB	475
2GB	970
4GB	1900
8GB	3850
16GB	7700

* The number of recordable still images shown is for the maximum image size of your camcorder. The actual number of recordable still images is displayed on the LCD screen during recording (p. 91).

Notes

- When using “Memory Stick PRO Duo” media made by Sony Corporation. The number of recordable still images varies depending on the recording conditions or type of “Memory Stick” media.
- The unique pixel array of Sony’s ClearVid and the image processing system allow still image resolution equivalent to the sizes described.

Tips

- You can also use “Memory Stick Duo” media with a capacity of under 1 GB for recording still images.

FILE NO. (File number)

▶ SERIES

Assigns file numbers in sequence even if the “Memory Stick PRO Duo” media is replaced with another one. The file number is reset when a new folder is created or the recording folder is replaced with another.

VIEW IMAGES SET

(Items to customize the display)

RESET

Assigns file numbers in sequence, following the largest file number existing on the current recording "Memory Stick PRO Duo" media.

AE SHIFT



See page 49.

WB SHIFT (White Balance Shift)



See page 49.

GUIDEFAME



See page 50.

ZEBRA



See page 50.

DIAL SETTING



See page 51.



Touch ①, then ②.

If the item is not on the screen, touch /
 to change the page.

How to set

(HOME MENU) → page 47

(OPTION MENU) → page 59

The default settings are marked with ►.

DATA CODE



During playback, displays the information (data code) recorded automatically at the time of recording.

► OFF

Data code is not displayed.

DATE/TIME

Displays the date and time.

CAMERA DATA (below)

Displays camera setting data.

DATE/TIME

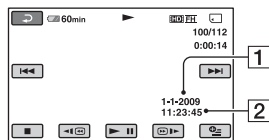

1 Date

2 Time

CAMERA DATA

Movie

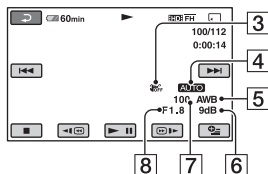

Still image

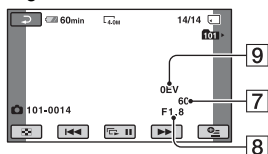

- 3 SteadyShot off
- 4 Brightness
- 5 White balance
- 6 Gain
- 7 Shutter speed
- 8 Aperture value
- 9 Exposure

💡 Tips

- The data code is displayed on the TV screen if you connect your camcorder to a TV.
- Depending on the “Memory Stick PRO Duo” media condition, bars [---:---] appear.
- 📵 appears on all images recorded with the camcorder.
- ⚡ appears on all images recorded using a flash with other device.

🔊 Notes

- This camcorder is not equipped with the camera-shake reduction (SteadyShot) function.

📺 DISPLAY

You can select the number of thumbnails that appear on the VISUAL INDEX screen.

▶ ZOOM LINK

Change the number of thumbnails (6 or 12) with the power zoom lever on your camcorder.

6IMAGES

Displays thumbnails of 6 images.

12IMAGES

Displays thumbnails of 12 images.

SOUND/DISP SET

(Items to adjust the sound and the screen)



Touch ①, then ②.

If the item is not on the screen, touch /
 to change the page.

How to set

(HOME MENU) → page 47

(OPTION MENU) → page 59

The default settings are marked with .

VOLUME



Touch / to adjust the volume
(p. 24).

BEEP



► ON

A melody sounds when you start/stop recording, or operate the touch panel.

OFF

Cancels the melody.

LCD BRIGHT



You can adjust the brightness of the LCD screen with /.

① Adjust the brightness with /.

② Touch .

Tips

- This adjustment does not affect the recorded images in any way.

LCD BL LEVEL (LCD backlight level)



You can adjust the brightness of the LCD screen's backlight.

► NORMAL

Standard brightness.

BRIGHT

Brightens the LCD screen.

Notes

- When you connect your camcorder to outside power sources, [BRIGHT] is automatically selected for the setting.
- When you select [BRIGHT], battery life is slightly reduced during recording.

Tips

- This adjustment does not affect the recorded images in any way.

LCD COLOR



You can adjust the color of the LCD screen with /.



Low intensity High intensity

Tips

- This adjustment does not affect the recorded images in any way.

OUTPUT SETTINGS

(Items for when connecting other devices)

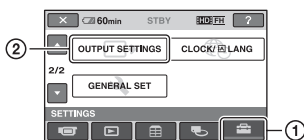

Touch ①, then ②.

If the item is not on the screen, touch / to change the page.

How to set

(HOME MENU) → page 47

(OPTION MENU) → page 59

The default settings are marked with ►.

TV TYPE

You need to convert the signal depending on the TV connected when playing back the image. The recorded images are played back as following illustrations.

► 16:9

Select this to view your images on a 16:9 (wide) TV.

16:9 (wide) images 4:3 images



4:3

Select this to view your images on a 4:3 standard TV.

16:9 (wide) images 4:3 images



Notes

- Horizontal to vertical ratio of the image recorded with HD (high definition) image quality is 16:9.

DISP OUTPUT

► LCD PANEL

Shows displays such as the time code on the LCD screen.

V-OUT/PANEL

Shows displays such as the time code on the TV screen and the LCD screen.

Notes

- The setting of [DISP OUTPUT] may be changed according to the setting of [CTRL FOR HDMI] (p. 58).

COMPONENT

Select [COMPONENT] when connecting your camcorder to a TV with the component input jack.

576i

Select when connecting your camcorder to a TV with the component input jack.

► 1080i/576i

Select when connecting your camcorder to a TV that has the component input jack and is capable of displaying the 1080i signal.

CLOCK/LANG

(Items to set clock and language)



Touch ①, then ②.

If the item is not on the screen, touch /
 to change the page.

How to set

(HOME MENU) → page 47

(OPTION MENU) → page 59

CLOCK SET

See page 12.

AREA SET

You can adjust a time difference without stopping the clock.

Set your local area using /
 when using your camcorder in other time zones.

SUMMERTIME

You can change this setting without stopping the clock.

Set to [ON] to move the time forward 1 hour.

LANGUAGE SET

You can select the language to be used on the LCD screen.

Tips

- Your camcorder offers [ENG[SIMP]] (simplified English) for when you cannot find your native tongue among the options.

GENERAL SET

(Other setup items)

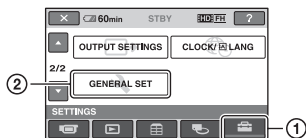

Touch ①, then ②.

If the item is not on the screen, touch /
 to change the page.

How to set

(HOME MENU) → page 47

(OPTION MENU) → page 59

The default settings are marked with .

REC LAMP (Recording lamp)

The camera recording lamp on the front of your camcorder lights up, as the default setting is [ON].

CALIBRATION

See page 82.

A.SHUT OFF (Auto shut off)

5 min

The camcorder is automatically turned off when you do not operate your camcorder for more than approximately 5 minutes.

NEVER

The camcorder is not automatically turned off.

Notes

- If you change this setting, turn off your camcorder and turn it on again.
- When you connect your camcorder to a wall outlet (wall socket), [A.SHUT OFF] is automatically set to [NEVER].

CTRL FOR HDMI (Control for HDMI)



The default setting is [ON], allowing you to do the playback operation with the remote commander of your TV by connecting your camcorder to a “BRAVIA” Sync compatible TV with the HDMI cable.

Tips

- If you turn off the TV, your camcorder is turned off simultaneously.

Activating functions using the OPTION MENU

The  OPTION MENU appears just like the pop-up window that appears when you right-click the mouse on a computer. Various available functions are displayed.

Using the OPTION MENU

- 1 While using your camcorder, touch  (OPTION) on the screen.

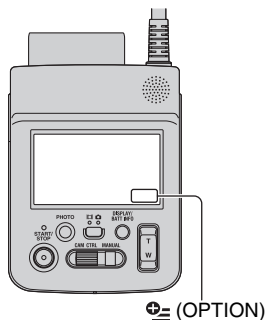

Tab

- 2 Touch the desired item.

If you cannot find the desired item, touch another tab to change the page.

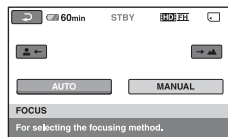





If you cannot find the item anywhere, the function does not work under the current situation.

- 3 Change the setting, then touch .

Notes











- The tabs and items that appear on the screen depend on the recording/playback status of your camcorder at the time.
- Some items appear without a tab.

Recording items on the OPTION MENU

Items	 *	Page
 tab		
FOCUS	–	61
SPOT FOCUS	–	61
TELE MACRO	–	61
EXPOSURE	–	62
SPOT METER	–	62
AE SHIFT	○	49
SCENE SELECTION	–	62
WHITE BAL.	–	63
WB SHIFT	○	49
COLOR SLOW SHTR	–	64
<hr/>		
 tab		
FADER	–	64
D.EFFECT	–	64
PICT.EFFECT	–	64
<hr/>		
 tab		
REC MODE	○	49
BLT-IN ZOOM MIC	–	65
MICREF LEVEL	–	65
 IMAGE SIZE	○	52
SELF-TIMER	–	65
TIMING	–	21
RECORD SOUND	–	21

* Items that are included also in the HOME MENU.

Viewing items on the OPTION MENU

Items	 *	Page
 tab		
DELETE	○	34
DELETE by date	○	35
DELETE ALL	○	35
<hr/>		
 tab		
DIVIDE	○	37
ERASE ALL	○	39
MOVE	○	39
<hr/>		
-- (The tab depends on the situation/No tab)		
 ADD**	○	38
 ADD**	○	38
 ADD by date**	○	38
 ADD by date**	○	38
PRINT	○	42
SLIDE SHOW	–	28
VOLUME	○	55
DATA CODE	○	53
SLIDE SHOW SET	–	28
 ADD	○	38
 ADD	○	38
 ADD by date	○	38
 ADD by date	○	38
COPIES	–	43
DATE/TIME	–	43
SIZE	–	43
ERASE	○	39

* Items that are included also in the HOME MENU.

** Items that are included in the HOME MENU by a different name.

Functions set in the OPTION MENU





Items you can set only on the  OPTION MENU will be described below.

The default settings are marked with .

FOCUS

You can adjust the focus manually. You can select this function also when you want to focus on a certain subject intentionally.



- 1 Touch [MANUAL].
 appears.
- 2 Touch  (focusing on close subjects)/ (focusing on distant subjects) to sharpen the focus.  appears when the focus cannot be adjusted any closer, and  appears when the focus cannot be adjusted farther away.
- 3 Touch [OK].

To adjust the focus automatically, touch [AUTO] → [OK] in step 1.

Notes

- The minimum possible distance between camcorder and subject while maintaining sharp focus is about 1 cm (about 13/32 in.) for wide angle and about 80 cm (about 2 5/8 feet) for telephoto.

Tips

- It is easier to focus on the subject by moving the power zoom lever towards T (telephoto) to adjust the focus, then towards W (wide angle) to adjust the zoom for recording. When you want to record a subject at close range, move the power zoom lever to W (wide angle), then adjust the focus.
- The focal distance information (distance at which the subject is focused on, if it is dark and focus adjustment is difficult) appears for a few seconds in the following cases (This information will not display correctly if an optional conversion lens is being used).
 - when the focus mode is switched from automatic to manual
 - when you set focus manually

- You can also adjust the focus manually using the CAM CTRL dial (p. 22).

SPOT FOCUS

You can select and adjust the focal point to aim it at a subject not located at the center of the screen.

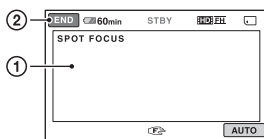

- 1 Touch the subject on the screen.
 appears.
- 2 Touch [END].

To adjust the focus automatically, touch [AUTO] → [END] in step 1.

Notes

- If you set [SPOT FOCUS], [FOCUS] is automatically set to [MANUAL].

TELE MACRO

This is useful to shoot small subjects, such as flowers or insects. You can blur out backgrounds and the subject stands out clearer.

When you set [TELE MACRO] to [ON] (T ) , the zoom (p. 20) moves to the top of the T (telephoto) side automatically and allows recording subjects at a close distance as down to about 36 cm (14 1/4 in.).



To cancel, touch [OFF], or zoom to wide-angle (W side).

Notes

- When recording a distant subject, focusing may be difficult and can take some time.
- Adjust the focus manually ([FOCUS], p. 61) when it is hard to focus automatically.

EXPOSURE



You can fix the brightness of a picture manually. Adjust the brightness when the subject is too bright or too dark.

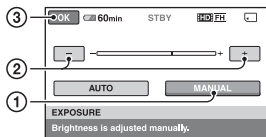

- ① Touch [MANUAL].
————— appears.
- ② Adjust the exposure by touching [—] / [+] .
- ③ Touch [OK].

To return the setting to automatic exposure, touch [AUTO] → [OK] in step ①.

💡 Tips

- You can also adjust the setting manually using the CAM CTRL dial (p. 22).

SPOT METER (Flexible spot meter)



You can adjust and fix the exposure to the subject, so that it is recorded in suitable brightness even when there is strong contrast between the subject and the background, such as subjects in the spotlight on stage.

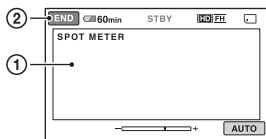

- ① Touch the point where you want to fix and adjust the exposure on the screen.
————— appears.
- ② Touch [END].

To return the setting to automatic exposure, touch [AUTO] → [END] in step ①.

📌 Notes

- If you set [SPOT METER], [EXPOSURE] is automatically set to [MANUAL].

SCENE SELECTION



You can record images effectively in various situations.

▶ AUTO

Select to automatically record images effectively without the [SCENE SELECTION] function.

TWILIGHT* (☾)

Select to maintain the darkening atmosphere of the distant surroundings in twilight scenes.



CANDLE (🕯)

Select to maintain the dim atmosphere of a candlelit scene.



SUNRISE&SUNSET* (☀)

Select to reproduce the atmosphere of scenes such as sunsets or sunrises.



FIREWORKS* (💣)

Select to take spectacular shots of fireworks.



LANDSCAPE* (🌄)

Select to shoot distant subjects clearly. This setting also prevents your camcorder from focusing on glass or metal mesh in windows that comes in between the camcorder and the subject.

**PORTRAIT (Soft portrait)** (👤)

Select to bring out the subject such as people or flowers while creating a soft background.

**SPOTLIGHT**** (☞)

Select to prevent people's faces from appearing excessively white when subjects are lit by strong light.

**BEACH**** (🏖️)

Select to take the vivid blue of the ocean or a lake.

**SNOW**** (❄️)

Select to take bright pictures of a white landscape.



* Adjusted to focus on subjects farther away only.

** Adjusted not to focus on subjects a short distance away.

🔊 Notes

- If you set [SCENE SELECTION], [WHITE BAL.] setting is canceled.

WHITE BAL. (White balance)

You can adjust the color balance to the recording environment.

▶ AUTO

The white balance is adjusted automatically.

OUTDOOR (☀️)

The white balance is adjusted to be appropriate for the following recording conditions:

- Outdoors
- Night views, neon signs and fireworks
- Sunrise or sunset
- Under daylight fluorescent lamps

INDOOR (🏠)

The white balance is adjusted to be appropriate for the following recording conditions:

- Indoors
- At party scenes or studios where the lighting conditions change quickly
- Under video lamps in a studio, or under sodium lamps or incandescent-like color lamps

ONE PUSH (👉)

The white balance will be adjusted according to the ambient light.

- ① Touch [ONE PUSH].
- ② Frame a white object such as a piece of paper, to fill the screen under the same lighting conditions as you will shoot the subject.
- ③ Touch [👉].
👉 flashes quickly. When the white balance has been adjusted and stored in the memory, the indicator stops flashing.

🔊 Notes

- Set [WHITE BAL.] to [AUTO] or adjust the color in [ONE PUSH] under white or cool white fluorescent lamps.
- When you select [ONE PUSH], keep framing white objects while 👉 is flashing quickly.

- flashes slowly if [ONE PUSH] could not be set.
- When [ONE PUSH] was selected, if keeps flashing after touching , set [WHITE BAL.] to [AUTO].
- If you set [WHITE BAL.], [SCENE SELECTION] is set to [AUTO].

Tips

- If you have changed the battery pack while [AUTO] was selected, or bring your camcorder outdoors from inside the house, or vice versa, select [AUTO] and aim your camcorder at a nearby white object for about 10 seconds for better color balance adjustment.
- When the white balance has been set with [ONE PUSH], if you change the [SCENE SELECTION] settings, or bring your camcorder outdoors from inside the house, or vice versa, you need to redo the [ONE PUSH] procedure to readjust the white balance.

COLOR SLOW SHTR (Color Slow Shutter)



When you set [COLOR SLOW SHTR] to [ON], appears, and you can record an image brighter in color even in dark places. To cancel, touch [OFF].

Notes

- Adjust the focus manually ([FOCUS], p. 61) when it is hard to focus automatically.
- The shutter speed of your camcorder changes depending on the brightness, which may result in a slowdown of the motion of the image.

FADER



You can record a transition with the following effects added to the interval between scenes.

- 1 Select the desired effect in [STBY] (to fading in) or [REC] (to fading out) mode, then touch .
- 2 Press START/STOP.
The fader indicator stops flashing and disappears when the fade is complete.

To cancel the fader before starting the operation, touch [OFF] in step ①. If you press START/STOP, the setting is canceled.



WHITE FADER



BLACK FADER



D.EFFECT (Digital effect)



When you select [OLD MOVIE], appears and you can add an old movie effect to images.

To cancel [D.EFFECT], touch [OFF].

PICT.EFFECT (Picture effect)



You can add special effects to an image during recording. appears.

► OFF

Does not use [PICT.EFFECT] setting.

SEPIA

Images appear in sepia.

B&W (Black and white)

Images appear in black and white.

PASTEL



Images appear as a pale pastel drawing.

BLT-IN ZOOM MIC (Built-in zoom microphone)



When you set [BLT-IN ZOOM MIC] to [ON] (), you can record a movie with directional sound as you move the power zoom lever (The default setting is [OFF]).

MICREF LEVEL (Microphone reference level)



You can select the microphone level for recording sound.
Select [LOW] when you want to record exciting and powerful sound in a concert hall, etc.

► NORMAL

Records surrounding sounds, converting them into the appropriate level.

LOW (↑↓)

Records surrounding sounds faithfully.
This setting is not suitable for recording conversations.

SELF-TIMER



 appears when [SELF-TIMER] is set to [ON].

Press PHOTO to start the count down. A still image is recorded after about 10 seconds.

To cancel the recording, touch [RESET].

To cancel the self-timer, select [OFF].

Performing with a computer

Software to be installed

■ “PMB” (only for Windows users)

“PMB” is the supplied software. You can enjoy the following operations.

- Creating a disc with one touch operation
- Importing images to a computer
- Editing imported images
- Creating a disc

🔗 Notes

- The supplied software “PMB” is not supported by Macintosh computers. To use a Macintosh computer connected to your camcorder, see the following website for details.

<http://guide.d-imaging.sony.co.jp/mac/ms/us/>

Installing “PMB”

■ System requirements

OS: Microsoft Windows XP SP3¹/
Windows Vista SP1²

¹64-bit editions and Starter (Edition) are not supported.

²Starter (Edition) is not supported.

Standard installation is required.

Operation is not assured if the above OS has been upgraded or in a multi-boot environment.

CPU: Intel Pentium 4 2.8 GHz or faster (Intel Pentium 4 3.6 GHz or faster, Intel Pentium D 2.8 GHz or faster, Intel Core Duo 1.66 GHz or faster, or Intel Core 2 Duo 1.66 GHz or faster is recommended.)

- Intel Pentium III 1 GHz or faster enables the following operations:
 - Importing the contents to the computer
 - One Touch Disc Burn
 - Creating a Blu-ray disc/AVCHD format disc/DVD-video (Intel Pentium 4, 2.8 GHz or faster, is required when creating a DVD video by converting high definition image quality (HD) to standard definition image quality (SD).)
 - Copying a disc

Application: DirectX 9.0c or later (This product is based on DirectX technology. It is necessary to have DirectX installed.)

Memory: For Windows XP: 512 MB or more (1 GB or more is recommended.) For processing SD (standard definition) image quality content only, 256 MB of memory or more is necessary. For Windows Vista: 1 GB or more

Hard disk: Disk volume required for installation: Approximately 500 MB (10 GB or more may be necessary when creating AVCHD format discs. 50 GB maximum may be necessary when creating Blu-ray discs.)

Display: Minimum 1,024 × 768 dots

Others: ⚡ USB port (this must be provided as standard, Hi-Speed USB (USB 2.0 compatible) is recommended), Blu-ray disc/DVD burner (CD-ROM drive is necessary for installation) Either NTFS or exFAT file system is recommended as the hard disk file system.

Attention

This camcorder captures high definition footage in the AVCHD format. Using the enclosed PC software, high definition footage can be copied onto DVD media. However, DVD media containing AVCHD footage should not be used with DVD based players or recorders, as the DVD player/recorder may fail to eject the media and may erase its contents without warning. DVD media containing AVCHD footage may be played on a compatible Blu-ray Disc™ player/recorder or other compatible device.

🔗 Notes

- Operation is not assured on all types of computer environment.

- You can read images recorded on “Memory Stick PRO Duo” media in “Memory Stick” media slot of a computer. However, in the following cases, do not use the “Memory Stick” media slot of the computer, but connect your camcorder to the computer with the USB cable:
 - The computer is not compatible with “Memory Stick PRO Duo” media.
 - “Memory Stick Duo” media adaptor is required.
 - “Memory Stick PRO Duo” media cannot be read in the “Memory Stick” media slot.
 - Reading data from the “Memory Stick” media slot is slow.

■ Installation procedure

You need to install the software to your Windows computer **before connecting your camcorder to the computer**. The installation is required only for the first time.

Contents to be installed and procedures may differ depending on your OS.

- ① Confirm that your camcorder is not connected to the computer.
- ② Turn on the computer.

🔍 Notes

- Log on as an Administrator for installation.
 - Close all applications running on the computer before installing the software.
- ③ Place the supplied CD-ROM in the disc drive of your computer.
The installation screen appears.



If the screen does not appear

- ① Click [Start], then click [My Computer].
- ② Double-click [SONYPICUTUTIL (E:)] (CD-ROM) (disc drive).
* Drive names (such as (E:)) may vary depending on the computer.
- ④ Click [Install].

- ⑤ Select the language for the application to be installed, then click [Next].
- ⑥ As the screen to confirm the connection appears, connect your camcorder to the computer following the steps below.

- ① Connect the AC Adaptor to your camcorder and a wall outlet (wall socket).

- ② Turn on your camcorder.

- ③ Connect the  (USB) jack of your camcorder to the computer using the supplied USB cable.
The [USB SELECT] screen appears on your camcorder automatically.

If the [USB SELECT] screen does not appear, touch  (HOME) →  (OTHERS) → [USB CONNECT].

- ④ Touch [ USB CONNECT] on the [USB SELECT] screen of your camcorder.



- ⑦ Click [Continue].
- ⑧ Read [License Agreement], and if you agree, change to then click [Next].
- ⑨ Confirm the installation settings, then click [Install].
- ⑩ Follow the on-screen instructions to install the software.
Depending on the computer, you may need to install third party software. If the installation screen appears, follow the instructions to install the required software.
- ⑪ Restart the computer if required to complete the installation.
- ⑫ Remove the CD-ROM from the disc drive of your computer.

For customers with writable Blu-ray Disc Drive

You can create a Blu-ray disc. Click [BD Add-on Software] on the installation screen and follow the on-screen instructions to install the update.



Notes

- You need to install “PMB” beforehand using the supplied CD-ROM.

To disconnect the USB cable

- ① Click the  icon → [Safely remove USB Mass Storage Device] on the task tray on the bottom right of the desktop of your computer.
- ② Touch [END] → [YES] on the screen of your camcorder.
- ③ Disconnect the USB cable.

To operate “PMB”

To start “PMB,” click [Start] → [All Programs] → [Sony Picture Utility] → [PMB].

To see “PMB Guide”

To find out how to use “PMB,” see “PMB Guide.”

To display “PMB Guide,” click [Start] → [All Programs] → [Sony Picture Utility] → [Help] → [PMB Guide].

Troubleshooting

If you run into any problems using your camcorder, use the following table to troubleshoot the problem. If the problem persists, disconnect the power source and contact your Sony dealer.

• Overall operations	69
• Batteries/Power sources	69
• LCD screen.....	70
• “Memory Stick PRO Duo” media.....	70
• Recording	70
• Playing back images	72
• Editing images on your camcorder	72
• Viewing on the TV	72
• Playing the “Memory Stick PRO Duo” media on other devices.....	73
• Dubbing/Connecting to other devices...	73
• PMB	73
• Functions that cannot be used simultaneously.....	73

Overall operations



The power does not turn on.

- Attach a charged battery pack to the camcorder (p. 9).
- The plug of the AC Adaptor has been disconnected from the wall outlet (wall socket). Connect it to the wall outlet (wall socket) (p. 9).

The camcorder does not operate even when the power is set to on.

- It takes a few seconds for your camcorder to be ready to shoot after the power is turned on. This is not a malfunction.
- Disconnect the AC Adaptor from the wall outlet (wall socket) or remove the battery pack, then reconnect it after about 1 minute. If the functions still do not work, press the RESET button (p. 89) using a pointed object (If you press the RESET button, all settings, including the clock setting, are reset).

Buttons do not work.

- When the HOLD  switch is set to the right, be sure to slide the HOLD  switch to the left (p. 20).

The menu settings have changed automatically.

- If you remove the battery pack or disconnect the AC Adaptor while the power is turned on, the setting cannot be saved.

Your camcorder gets warm.

- Your camcorder may become warm during operation. This is not a malfunction.

Batteries/Power sources

The power abruptly turns off.

- Charge the battery pack (p. 9).

The CHG (charge) lamp does not light while the battery pack is being charged.

- Turn off your camcorder (p. 9).
- Attach the battery pack to the camcorder correctly (p. 9).
- Connect the power cord (mains lead) to the wall outlet (wall socket) properly.
- The battery charge is completed (p. 9).

The CHG (charge) lamp flashes while the battery pack is being charged.

- Attach the battery pack to the camcorder correctly (p. 9). If the problem persists, disconnect the power source and contact your Sony dealer. The battery pack may be damaged.

The remaining battery time indicator does not indicate the correct time.

- The ambient temperature is too high or too low. This is not a malfunction.

- The battery pack has not been charged enough. Fully charge the battery again. If the problem persists, replace the battery pack with a new one (p. 9).
- The indicated time may not be correct depending on the environment of use.

The battery pack is quickly discharged.

- The ambient temperature is too high or low. This is not a malfunction.
- Fully charge the battery again. If the problem persists, replace the battery pack with a new one (p. 9).

LCD screen



Menu items are grayed out.

- You cannot select grayed items in the current recording/playback situation.
- There are some functions you cannot activate simultaneously (p. 73).

The buttons do not appear on the touch panel.

- Touch the LCD screen lightly.
- Press DISPLAY/BATT INFO (p. 13).

The buttons on the touch panel do not work correctly or do not work at all.

- Adjust the touch panel ([CALIBRATION], p. 82).
- When the HOLD  switch is set to the right, be sure to slide the HOLD  switch to the left (p. 20).

“Memory Stick PRO Duo” media

You cannot operate functions using the “Memory Stick PRO Duo” media.

- If you use “Memory Stick PRO Duo” media formatted on a computer, format it again on your camcorder (p. 45).

You cannot delete images stored on or format the “Memory Stick PRO Duo” media.

- The maximum number of images that you can delete at one time is 100.
- You cannot delete the images protected on another device.







The data file name is not indicated correctly or flashes.

- The file is damaged.
- The file format is not supported by your camcorder (p. 78).

Recording

Refer also to “Memory Stick PRO Duo” media (p. 70).

Pressing START/STOP or PHOTO does not record images.

- The playback screen is displayed. Press the  (Movie)/ (Still) select button to turn on the  (Movie) lamp or  (Still) lamp (p. 19).
- Your camcorder is recording the image you have just shot on the “Memory Stick PRO Duo” media. You cannot make new recording during this period.
- The “Memory Stick PRO Duo” media is full. Use new “Memory Stick PRO Duo” media or format the “Memory Stick PRO Duo” media (p. 45). Or delete the unnecessary images (p. 34).
- Total number of movie scenes or still images exceeds the recordable capacity of your camcorder (p. 15). Delete unnecessary images (p. 34).
- Moisture condensation has occurred. Turn off your camcorder and leave it for about 1 hour in a cool place (p. 81).
- When the HOLD  switch is set to the right, be sure to slide the HOLD  switch to the left (p. 20).

You cannot record a still image.

- You cannot record a still image together with:
 - [SMTH SLW REC]
 - [FADER]
 - [D.EFFECT]
 - [PICT.EFFECT]

The access lamp remains lit or flashing even when you stop recording.

- Your camcorder is recording the scene you have just shot on the “Memory Stick PRO Duo” media.

The recording angle looks different.

- The recording angle may look different depending on the condition of your camcorder. This is not a malfunction.

The actual recording time for movie is less than the expected approximate recording time of the “Memory Stick PRO Duo” media.

- Depending on the recording conditions, the time available for recording may be shorter, for example when recording a fast moving object, etc. (p. 15, 51).

There is a time difference between the point where you press START/STOP and the point that the recorded movie starts/stops.

- On your camcorder, there may be a slight time difference between the point where you press START/STOP and the actual point that recording movie starts/stops. This is not a malfunction.

The horizontal to vertical ratio (16:9 (wide)/4:3) cannot be changed.

- The horizontal to vertical ratio of the movie recorded with HD (high definition) image quality is 16:9 (wide).

The auto focus does not function.

- Set [FOCUS] to [AUTO] (p. 61).
- The recording conditions are not suitable for auto focus. Adjust the focus manually (p. 61).

The subjects passing by the lens very fast appear crooked.

- This is called the focal plane phenomenon. This is not a malfunction. Because of the way the image device (CMOS sensor) reads out image signals, the subjects passing by the lens rapidly might appear crooked depending on the recording conditions.

Tiny spots in white, red, blue, or green appear on the screen.

- The spots appear when you are recording with [COLOR SLOW SHTR]. This is not a malfunction.

The screen image is dark, and the subject does not appear on the screen.

- Press and hold DISPLAY/BATT INFO for a few seconds to turn on the backlight (p. 13).

Horizontal stripes appear on the images.

- This occurs when recording images under a fluorescent lamp, sodium lamp, or mercury lamp. This is not a malfunction.

[COLOR SLOW SHTR] does not operate correctly.



- [COLOR SLOW SHTR] may not operate correctly in total darkness.

You cannot adjust [LCD BL LEVEL].

- You cannot adjust [LCD BL LEVEL] when the power is supplied from the AC Adaptor.

Playing back images

An image cannot be found for playback.

- Select the image quality of a movie you want to play back by touching  (HOME) →  (MANAGE MEDIA) → [HD/SD] SET] (p. 44).

Images cannot be played back.

- Images cannot be played back if you have modified files or folders, or have edited the data on a computer. (The file name flashes in the case of still images.) This is not a malfunction (p. 79).
- Images recorded on other devices may not be played back. This is not a malfunction (p. 79).

“?” is indicated on an image in the VISUAL INDEX screen.

- This may appear on still images recorded on other devices, edited on a computer, etc.
- You removed the AC Adaptor or the battery pack before the access lamp is turned off after recording. This may damage your image data and “?” is displayed.

“✖” is indicated on an image in the VISUAL INDEX screen.

- Perform [REPAIR IMG.DB F.] (p. 46). If it still appears, delete the image marked with  (p. 34).

No sound or only a quiet sound is heard during playback.

- Turn up the volume (p. 24).
- When you record sound with [MICREF LEVEL] (p. 65) set to [LOW], the recorded sound may be difficult to hear.
- When using [SMTH SLW REC], set [RECORD SOUND] to [ON] (p. 21).

Editing images on your camcorder

Unable to edit.

- Unable to edit because of the condition of the image.

Images cannot be added in the Playlist.

- There is no free space in the “Memory Stick PRO Duo” media.
- You can add no more than 999 images with HD (high definition) image quality, or 99 images with SD (standard definition) image quality, to a Playlist. Erase unnecessary images from the Playlist (p. 39).
- You cannot add still images in the Playlist.

A movie cannot be divided.

- A movie that is too short cannot be divided.
- A movie protected on another device cannot be divided.

Still images cannot be captured from a movie.

- There is no space on the “Memory Stick PRO Duo” media to record a still image.

Viewing on the TV

You cannot view the image or hear the sound on the TV.

- When you are using the component A/V cable, set [COMPONENT] according to the requirements of the connected device (p. 56).
- When you are using the component video plug, make sure the red and white plugs of the A/V connecting cable are connected (p. 29, 31).
- Images are not output from the HDMI OUT jack, if copyright protection signals are recorded in the images.

- When you are using the S VIDEO plug, make sure the red and white plugs of the A/V connecting cable are connected (p. 31).

The image appears distorted on the 4:3 TV.

- This happens when viewing an image recorded in the 16:9 (wide) mode on a 4:3 TV. Set [TV TYPE] correctly (p. 56) and play back the image.

Black bands appear at the top and bottom of the screen of the 4:3 TV.

- This happens when viewing an image recorded in the 16:9 (wide) mode on a 4:3 TV. This is not a malfunction.

Playing the “Memory Stick PRO Duo” media on other devices

The device does not play or read the “Memory Stick PRO Duo” media.

- You can play back the images with HD (high definition) image quality only on devices that comply with AVCHD-format.

Dubbing/Connecting to other devices

You cannot dub correctly.

- You cannot dub images using an HDMI cable.
- The A/V connecting cable is not connected properly. Make sure to connect to the input jack of another device (p. 40).

PMB

You cannot install “PMB.”

- Check the computer environment required to install “PMB.”
- Install “PMB” in the proper order (p. 66).

“PMB” does not work correctly.

- Quit “PMB” and restart your computer.

Functions that cannot be used simultaneously

The following list shows examples of unworkable combinations of functions and menu items.

Cannot use	Because of following settings
[SCENE SELECTION]	[COLOR SLOW SHTR], [FADER], [OLD MOVIE], [TELE MACRO]
[ONE PUSH] in [WHITE BAL.]	[SMTH SLW REC]
[SPOT FOCUS]	[SCENE SELECTION]
[COLOR SLOW SHTR]	[FADER], [D.EFFECT], [SCENE SELECTION]
[FADER]	[COLOR SLOW SHTR], [D.EFFECT], [CANDLE], [FIREWORKS]
[D.EFFECT]	[COLOR SLOW SHTR], [FADER], [SCENE SELECTION], [PICT.EFFECT]
[PICT.EFFECT]	[OLD MOVIE]
[TELE MACRO]	[SCENE SELECTION]
[AUTO SLW SHUTTR]	[SMTH SLW REC], [D.EFFECT], [SCENE SELECTION], [COLOR SLOW SHTR], [FADER]
[WIDE SELECT]	[OLD MOVIE]
[MICREF LEVEL]	[BLT-IN ZOOM MIC]
[DISP OUTPUT]	[CTRL FOR HDMI]

Warning indicators and messages

Self-diagnosis display/Warning indicators

If indicators appear on the LCD screen, check the following.

You can fix some symptoms by yourself. If the problem persists even after you have tried to fix a couple of times, contact your Sony dealer or local authorized Sony service facility.

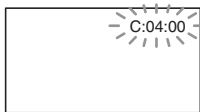

C:(or E:) □□:□□ (Self-diagnosis display)

C:04:□□

- The battery pack is not an “InfoLITHIUM” battery pack (H series). Use an “InfoLITHIUM” battery pack (H series) (p. 79).
- Connect the DC plug of the AC Adaptor to the DC IN jack of your camcorder securely (p. 9).

C:13:□□ / C:32:□□

- Remove the power source. Reconnect it and operate your camcorder again.

E:20:□□ / E:31:□□ / E:61:□□ / E:62:□□ / E:91:□□ / E:94:□□

- A malfunction that you cannot service has occurred. Contact your Sony dealer or local authorized Sony service facility. Inform them of the 5-digit code, which starts from “E”.

101-0001 (Warning indicator pertaining to files)

Slow flashing

- The file is damaged.
- The file is unreadable.

⚠ (Battery level warning)

Slow flashing

- The battery pack is nearly used up.
- Depending on the operating environment or battery conditions, ⚠ may flash, even if there are approximately 20 minutes remaining.

⚠ (High temperature warning)

Slow flashing

- The temperature of your camcorder is getting higher. Turn off your camcorder and leave it for a while in a cool place.

Fast flashing*

- The temperature of your camcorder is extremely high. Turn off your camcorder and leave it for a while in a cool place.
- Rec stop.
Do not use the main body of your camcorder under direct sunlight, such as on the dashboard of a car, etc. Use your camcorder where the temperature does not get high.

⚠ (Warning indicator pertaining to “Memory Stick PRO Duo” media)

Slow flashing

- Free space for recording images are running out. For the type of “Memory Stick” media you can use with your camcorder, see page 2.
- No “Memory Stick PRO Duo” media is inserted (p. 14).

Fast flashing

- There are not enough free space for recording images. Delete unnecessary images, or format the “Memory Stick PRO Duo” media after storing the images on other media (p. 33, 34, 45).
- The Image Database File is damaged (p. 46).

 **(Warning indicators pertaining to “Memory Stick PRO Duo” media formatting)***

- The “Memory Stick PRO Duo” media is damaged.
- The “Memory Stick PRO Duo” media is not formatted correctly (p. 45, 78).

 **(Warning indicator pertaining to incompatible “Memory Stick PRO Duo” media)***

- An incompatible “Memory Stick PRO Duo” media is inserted (p. 78).

 **(Warning indicator pertaining to the write-protect of the “Memory Stick PRO Duo” media)***

- Access to the “Memory Stick PRO Duo” media was restricted on another device.

 **(Warning indicator pertaining to camera-shake warning)**

- The camcorder is unsteady, so camera-shake easily occurs. Hold the camcorder steady and record the image. However, note that the camera-shake warning indicator does not disappear.

 **(Warning indicator pertaining to still image recording)**

- The “Memory Stick PRO Duo” media is full.
- Still images cannot be recorded during processing. Wait for a while, then record.

* You hear a melody when the warning indicators appear on the screen (p. 55).

Description of warning messages

If messages appear on the screen, follow the instructions.

■ “Memory Stick PRO Duo” media

 **Reinsert the Memory Stick.**

- Reinsert the “Memory Stick PRO Duo” media a few times. If even then the indicator flashes, the “Memory Stick PRO Duo” media could be damaged. Try with another “Memory Stick PRO Duo” media.

 **This Memory Stick is not formatted correctly.**

- Check the format, then format the “Memory Stick PRO Duo” media with your camcorder if necessary (p. 45, 78).

Memory Stick folders are full.

- You cannot create folders exceeding 999MSDCF. You cannot create or delete folders using your camcorder.
- Format the “Memory Stick PRO Duo” media (p. 45), or delete unnecessary folders using your computer.

This Memory Stick may not be able to record or play movies.

- Use the recommended “Memory Stick” media (p. 2).

This Memory Stick may not be able to record or play images correctly.

- Use the recommended “Memory Stick” media (p. 2).
- Contact your Sony dealer or local authorized Sony service facility.

Do not eject the Memory Stick during writing. Data may be damaged.

- Insert the “Memory Stick PRO Duo” media again, and follow the instructions on the screen.

The Image Database File is damaged. Do you want to create a new file?

HD movie management information is damaged. Create new information?

- The image management file is damaged. When you touch [YES], a new image management file is created. The old recorded images on the “Memory Stick PRO Duo” media cannot be played back (Image files are not damaged). If you perform [REPAIR IMG.DB F.] (p. 46) after creating new information, playing back the old recorded images may become possible. If it does not work, copy the image to a computer using the supplied software.

Inconsistencies found in Image Database File. Do you want to repair the Image Database File?

The Image Database File is damaged. Do you want to repair the Image Database File?

Inconsistencies found in Image Database File. Cannot record or play HD movies. Do you want to repair the Image Database File?

- The Image Database File is damaged, and you cannot record movies. Touch [YES] to repair.
- You can record still images on “Memory Stick PRO Duo” media.

Recovering data

- Your camcorder tries to recover data automatically if the data writing was not performed properly.

Cannot recover data.

- Because data writing onto the “Memory Stick PRO Duo” media failed, your camcorder tried to recover the data, but could not recover data. You may not be able to record or edit data on the “Memory Stick PRO Duo” media.

■ **PictBridge compliant printer**

Not connected to PictBridge compatible printer.

- Turn off the printer and on again, then remove the USB cable (supplied) and reconnect it.

Cannot print. Check the printer.

- Turn off the printer and on again, then remove the USB cable (supplied) and reconnect it.

■ **Other**

No further selection is possible.

- You can select only 100 images at one time for:
 - deleting images
 - editing the playlist of HD (high definition) movies
 - printing still images

Data protected.

- You tried to delete data protected on another device. Release the protection of the data on the device used to protect the data.

Files/folder structure on the “Memory Stick PRO Duo” media

The file/folder structure is shown below. You do not usually need to acknowledge the file/folder structure, when recording/playing back images on the camcorder. To enjoy still images or movies by connecting to a computer, see “PMB Guide” on the supplied CD-ROM, then use the supplied application.

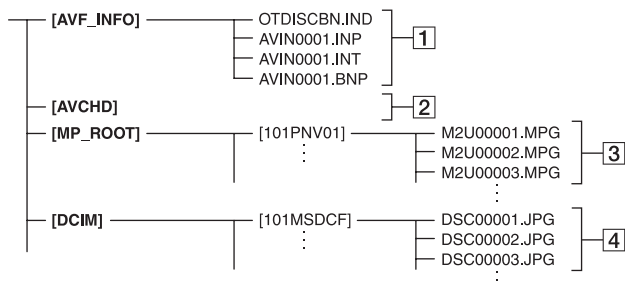

1 Image management files

When you delete the files, you cannot record/play back the images correctly. The files are defaulted as hidden files and not usually displayed.

2 HD movie management information folder

This folder contains recording data of movies with HD (high definition) image quality. Do not try to open this folder or access the contents of this folder from a computer. Doing so might damage image files, or prevent image files from being played back.

3 SD movie files (MPEG2 files)

The extension of the files is “.MPG”. The maximum size is 2 GB. When the capacity of a file exceeds 2 GB, the file becomes divided.

The file numbers go up automatically. When the capacity of a file number exceeds 9999, another folder is created to record new movie files.

The folder name goes up: [101PNV01] → [102PNV01]

4 Still image files (JPEG files)

The extension of the files is “.JPG”. The file numbers go up automatically. When

the capacity of a file number exceeds 9999, another folder is created to store new image files.

The folder name goes up: [101MSDCF] → [102MSDCF]

- By selecting (HOME) → (OTHERS) → [USB CONNECT] → [USB CONNECT], you can access “Memory Stick PRO Duo” media in the camcorder from a computer through USB connection.
- Do not modify the files or folders on “Memory Stick PRO Duo” media in the camcorder from a computer. The image files may be destroyed or may not be played back.
- We (Sony) will not be responsible for the results of operating the data on “Memory Stick PRO Duo” media in the camcorder from a computer.
- When you delete image files, follow the steps on page 34. Do not delete the image files on “Memory Stick PRO Duo” media in the camcorder directly from a computer.
- Do not format “Memory Stick PRO Duo” media in the camcorder using a computer. The camcorder may not operate correctly.
- Do not copy the files on “Memory Stick PRO Duo” media in the camcorder from a computer. We (Sony) will not be responsible for the results of this kind of operation.

Maintenance and precautions

About the AVCHD format

What is the AVCHD format?

The AVCHD format is a high definition digital video camera format used to record an HD (high definition) signal of either the 1080i specification*¹ or the 720p specification*², using efficient data compression coding technology. The MPEG-4 AVC/H.264 format is adopted to compress video data, and the Dolby Digital or Linear PCM system is used to compress audio data.

The MPEG-4 AVC/H.264 format is capable of compressing images at higher efficiency than that of the conventional image compressing format. The MPEG-4 AVC/H.264 format enables a high definition video signal shot on a digital video camera recorder to be recorded on 8 cm DVD discs, internal hard disk drive, flash memory, "Memory Stick PRO Duo" media, etc.

Recording and playback on your camcorder

Based on the AVCHD format, your camcorder records with the HD (high definition) image quality mentioned below. In addition to HD (high definition) image quality, your camcorder is capable of recording an SD (standard definition) signal in the conventional MPEG2 format.

Video signal*³:

MPEG-4 AVC/H.264 1920 × 1080/50i,
1440 × 1080/50i

Audio signal:

Dolby Digital 2 ch

Recording media:

"Memory Stick PRO Duo" media

*1: 1080i specification

A high definition specification which utilizes 1,080 effective scanning lines and the interlace system.

*2: 720p specification

A high definition specification which utilizes 720 effective scanning lines and the progressive system.

*3: Data recorded in AVCHD format other than the above mentioned cannot be played on your camcorder.

About the "Memory Stick" media

"Memory Stick" media is a compact, portable IC recording medium with a large data capacity.

You can use only "Memory Stick Duo" media, which is about the half size of standard "Memory Stick" media, with your camcorder.

However, we do not guarantee the operation of all types of "Memory Stick Duo" media on your camcorder.

Types of "Memory Stick" media	Recording/ Playback
"Memory Stick Duo" media (with "MagicGate")	—
"Memory Stick PRO Duo" (Mark2) media	○
"Memory Stick PRO-HG Duo" media	○*

* This product does not support 8-bit parallel data transfer but it supports 4-bit parallel data transfer the same as with "Memory Stick PRO Duo" media.

- This product cannot record or play data that uses "MagicGate" technology. "MagicGate" is a copyright protection technology that records and transfers the contents in an encrypted format.
- "Memory Stick PRO Duo" media formatted by a computer (Windows OS/Mac OS) does not have guaranteed compatibility with your camcorder.
- Data read/write speed may vary depending on the combination of the "Memory Stick PRO Duo" media and the "Memory Stick PRO Duo" media compliant product you use.

- Damaged or lost data may occur in the following cases (the data will not be compensated for):
 - If you eject the “Memory Stick PRO Duo” media, or turn off your camcorder while your camcorder is reading or writing image files on the “Memory Stick PRO Duo” media (while the access lamp is lit or flashing).
 - If you use the “Memory Stick PRO Duo” media near magnets or magnetic fields.
- It is recommended you make a back-up of important data on the hard disk of a computer.
- Be careful not to apply excessive force when writing on a memo area on “Memory Stick PRO Duo” media.
- Do not attach a label or the like on “Memory Stick PRO Duo” media or “Memory Stick Duo” media adaptor.
- When you carry or store “Memory Stick PRO Duo” media, put it in its case.
- Do not touch, or allow metallic objects to come into contact with the terminals.
- Do not bend, drop or apply strong force to the “Memory Stick PRO Duo” media.
- Do not disassemble or modify the “Memory Stick PRO Duo” media.
- Do not let the “Memory Stick PRO Duo” media get wet.
- Keep “Memory Stick PRO Duo” media out of the reach of small children. There is danger that a child might swallow it.
- Do not insert anything other than “Memory Stick PRO Duo” media into the “Memory Stick Duo” media slot. Doing so may cause a malfunction.
- Do not use or keep the “Memory Stick PRO Duo” media in the following locations:
 - Places subject to extremely high temperature, such as a car parked outside in the summer
 - Places under direct sunlight
 - Places with extremely high humidity or subject to corrosive gases

■ On the “Memory Stick Duo” media adaptor

- When using “Memory Stick PRO Duo” media with “Memory Stick” media compliant device, be sure to insert the “Memory Stick PRO Duo” media into “Memory Stick Duo” media adaptor.
- When inserting “Memory Stick PRO Duo” media into “Memory Stick Duo” media adaptor, make sure the “Memory Stick PRO Duo” media

is inserted facing in the correct direction, then insert it all the way in. Note that improper use may cause a malfunction. Also, if you force the “Memory Stick PRO Duo” media into the “Memory Stick Duo” media adaptor in the wrong direction, it may be damaged.

- Do not insert “Memory Stick Duo” media adaptor without “Memory Stick PRO Duo” media attached into “Memory Stick” media compliant device. Doing so may result in malfunctions of the device.

■ On “Memory Stick PRO Duo” media

- The maximum memory capacity of “Memory Stick PRO Duo” media that can be used with your camcorder is 16 GB.

On image data compatibility

- Image data files recorded on “Memory Stick PRO Duo” media by your camcorder conform to the “Design rule for Camera File system” universal standard established by the JEITA (Japan Electronics and Information Technology Industries Association).
- On your camcorder, you cannot play back still images recorded on other devices (DCR-TRV900E or DSC-D700/D770) that do not conform to the universal standard. (These models are not sold in some regions.)
- If you cannot use “Memory Stick PRO Duo” media that has been used with another device, format it with your camcorder (p. 45). Note that formatting erases all information on the “Memory Stick PRO Duo” media.
- You may not be able to play back images with your camcorder:
 - When playing back image data modified on your computer.
 - When playing back image data recorded with other devices.

About the “InfoLITHIUM” battery pack

Your camcorder operates only with an “InfoLITHIUM” battery pack (H series). “InfoLITHIUM” H series battery packs have the  mark.

What is an “InfoLITHIUM” battery pack?

An “InfoLITHIUM” battery pack is a lithium-ion battery pack that has functions for communicating information related to operating conditions between your camcorder and an optional AC Adaptor/charger.

The “InfoLITHIUM” battery pack calculates the power consumption according to the operating conditions of your camcorder, and displays the remaining battery time in minutes.

To charge the battery pack

- Be sure to charge the battery pack before you start using your camcorder.
- We recommend charging the battery pack in an ambient temperature of between 10 °C to 30 °C (50 °F to 86 °F) until the CHG (charge) lamp turns off. If you charge the battery pack outside of this temperature range, you may not be able to charge it efficiently.

To use the battery pack effectively



- Battery pack performance decreases when the ambient temperature is 10 °C (50 °F) or below, and the length of time you can use the battery pack becomes shorter. In that case, do one of the following to use the battery pack for a longer time.
 - Put the battery pack in a pocket to warm it up, and insert it in your camcorder right before you start taking shots.
 - Use a large capacity battery pack: NP-FH70/FH100 (sold separately).
- Frequent use of the LCD screen or a frequent playback, fast forward or rewind operation wears out the battery pack faster. We recommend using a large capacity battery pack: NP-FH70/FH100 (sold separately).
- Be sure to turn off your camcorder when not recording or playing back on your camcorder. The battery pack is also consumed when your camcorder is in recording standby or playback pause.
- Have spare battery packs ready for 2 or 3 times the expected recording time, and make trial recordings before making the actual recording.

- Do not expose the battery pack to water. The battery pack is not water resistant.

About the remaining battery time indicator

- When the power goes off even though the remaining battery time indicator indicates that the battery pack has enough power to operate, charge the battery pack fully again. Remaining battery time will be indicated correctly. Note, however, that the battery indication will not be restored if it is used in high temperatures for a long time, or if left in a fully charged state, or when the battery pack is frequently used. Use the remaining battery time indication as a rough guide only.
- The  mark that indicates low battery flashes even if there are still approximately 20 minutes of battery time remaining, depending on the operating conditions or ambient temperature.

About storage of the battery pack

- If the battery pack is not used for a long time, fully charge the battery pack and use it up on your camcorder once a year to maintain proper function. To store the battery pack, remove it from your camcorder and put it in a dry, cool place.
- To discharge the battery pack on your camcorder completely, touch  (HOME) →  (SETTINGS) → [GENERAL SET] → [A.SHUT OFF] → [NEVER] (the default setting) and leave your camcorder in recording standby until the power goes off (p. 57).

About battery life

- Battery capacity decreases over time and through repeated use. If decreased usage time between charges becomes significant, it is probably time to replace it with a new one.
- Each battery's life is governed by storage, operating and environmental conditions.

About handling of your camcorder

On use and care

- Do not use or store the camcorder and accessories in the following locations:

- Anywhere extremely hot, cold or humid. Never leave them exposed to temperatures above 60 °C (140 °F), such as under direct sunlight, near heaters or in a car parked in the sun. They may malfunction or become deformed.
- Near strong magnetic fields or mechanical vibration. The camcorder may malfunction.
- Near strong radio waves or radiation. The camcorder may not be able to record properly.
- Near AM receivers and video equipment. Noise may occur.
- On a sandy beach or anywhere dusty. If sand or dust gets in your camcorder, it may malfunction. Sometimes this malfunction cannot be repaired.
- Near windows or outdoors, where the LCD screen or the lens may be exposed to direct sunlight. This damages inside the LCD screen.
- Operate your camcorder on DC 6.8 V/7.2 V (battery pack) or DC 8.4 V (AC Adaptor).
- For DC or AC operation, use the accessories recommended in these operating instructions.
- Do not let your camcorder get wet, for example, from rain or sea water. If your camcorder gets wet, it may malfunction. Sometimes this malfunction cannot be repaired.
- If any solid object or liquid gets inside the casing, unplug your camcorder and have it checked by a Sony dealer before operating it any further.
- Avoid rough handling, disassembling, modifying, physical shock, or impact such as hammering, dropping or stepping on the product. Be particularly careful of the lens.
- Keep your camcorder turned off when you are not using your camcorder.
- Do not wrap your camcorder with a towel, for example, and operate it. Doing so might cause heat to build up inside.
- When disconnecting the power cord (mains lead), pull it by the plug and not the cord (lead).
- Do not damage the power cord (mains lead) such as by placing anything heavy on it.
- Do not use a deformed or damaged battery pack.
- Keep metal contacts clean.
- If the battery electrolytic liquid has leaked:
 - consult your local authorized Sony service facility.

- wash off any liquid that may have contacted your skin.
- if any liquid gets in your eyes, wash with plenty of water and consult a doctor.

■ When not using your camcorder for a long time

- Periodically turn it on and let it run such as by playing back or recording images for about 3 minutes.
- Use up the battery pack completely before storing it.

Notes on splash-proof performance

Only this camera conforms to IEC60529 IPX2. Never use the camcorder in the water. The camcorder main body is not designed for splash-proof performance, and do not wet the camcorder main body.

■ Care of this unit

- If this unit is splashed by water or other liquid, wipe it completely with a dry soft cloth. Although the camera is splash-proof, leaving the unit wet may cause it to malfunction. Clean the unit body with a cloth lightly moistened with water, and then wipe the moisture with a dry soft cloth. Do not wash the unit in running water. Water may seep inside of the unit due to the water pressure, and it may damage the unit.

■ Usage life of the rubber casings

- Rubber casings are used on the camera of this unit for splash-proof protection. The usage life of these rubber casings vary depending on usage. We recommend replacing these rubber casings once a year to maintain the splash-proof protection.

Moisture condensation

If your camcorder is brought directly from a cold place to a warm place, moisture may condense inside your camcorder. This may cause a malfunction to your camcorder.

■ If moisture condensation has occurred

Leave your camcorder for about 1 hour without turning it on.

■ Note on moisture condensation

Moisture may condense when you bring your camcorder from a cold place into a warm place (or vice versa) or when you use your camcorder in a humid place as follows:

- You bring your camcorder from a ski slope into a place warmed up by a heating device.
- You bring your camcorder from an air conditioned car or room into a hot place outside.
- You use your camcorder after a squall or a shower.
- You use your camcorder in a hot and humid place.

■ How to prevent moisture condensation

When you bring your camcorder from a cold place into a warm place, put your camcorder in a plastic bag and seal it tightly. Remove the bag when the air temperature inside the plastic bag has reached the ambient temperature (after about 1 hour).

LCD screen



- Do not exert excessive pressure on the LCD screen, as it may cause damage.
- If your camcorder is used in a cold place, a residual image may appear on the LCD screen. This is not a malfunction.
- While using your camcorder, the LCD screen and the parts nearby may heat up. This is not a malfunction.

To clean the LCD screen

- The surface of the LCD screen is coated. If you scratch the surface, the coating may be come off. Mind the following points when cleaning and handling it.
 - Use a soft cloth (a cloth for glasses, etc.) gently to clean the dirt.
 - Remove the dust or sand with a blower, etc. before wiping the dirt.
 - The coating may be scratched if you wipe the screen with a tissue paper, etc.
 - If hand grease or hand cream remains on the screen, the coating comes off more easily. Wipe it early.

■ On adjustment of the touch panel (CALIBRATION)

The buttons on the touch panel may not work correctly. If this happens, follow the procedure below. It is recommended that you connect your camcorder to the wall outlet (wall socket) using the supplied AC Adaptor during the operation.

- ① Turn on your camcorder.
- ② Touch  (HOME) →  (SETTINGS) → [GENERAL SET] → [CALIBRATION].

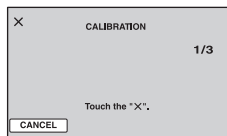

- ③ Touch "x" displayed on the screen with the corner of the "Memory Stick PRO Duo" media or the like 3 times.
Touch [CANCEL] to cancel.

If you did not press the right spot, try the calibration again.

⚡ Notes

- Do not use a sharp-pointed object for calibration. Doing so may damage the LCD screen.

On handling the casing

- If the casing is soiled, clean the camcorder body with a soft cloth lightly moistened with water, and then wipe the casing with a dry soft cloth.
- Avoid the following to avoid damage to the finish:
 - Using chemicals such as thinner, benzene, alcohol, chemical cloths, repellent, insecticide and sunscreen.
 - Handling the camcorder with above substances on your hands.
 - Leaving the casing in contact with rubber or vinyl objects for a long period of time.

Specifications

About care and storage of the lens

- Wipe the surface of the lens clean with a soft cloth in the following instances:
 - When there are fingerprints on the lens surface.
 - In hot or humid locations
 - When the lens is exposed to salty air such as at the seaside.
- Store in a well-ventilated location subject to little dirt or dust.
- To prevent mold, periodically clean the lens as described above. It is recommended that you operate your camcorder about once a month to keep it in optimum state for a long time.

On charging the pre-installed rechargeable battery

Your camcorder has a pre-installed rechargeable battery to retain the date, time, and other settings even when your camcorder turned off. The pre-installed rechargeable battery is always charged while your camcorder is connected to the wall outlet (wall socket) via the AC Adaptor or while the battery pack is attached. The rechargeable battery will be fully discharged in about **3 months** if you do not use your camcorder at all. Use your camcorder after charging the pre-installed rechargeable battery.

However, even if the pre-installed rechargeable battery is not charged, the camcorder operation will not be affected as long as you are not recording the date.

■ Procedures

Connect your camcorder to a wall outlet (wall socket) using the supplied AC Adaptor, and leave it with the POWER switch set to OFF for more than 24 hours.

System

Video compression format: AVCHD (HD)/MPEG2 (SD)/JPEG (Still images)
Audio compression format: Dolby Digital 2ch
Dolby Digital Stereo Creator
Video signal: PAL color, CCIR standards
1080/50i specification
Recording format: HD: AVCHD 1080/50i
SD: MPEG2-PS
Still image: Exif Ver.2.2*1
Image device: 3.6 mm (1/5 type) CMOS sensor
Recording pixels (still image, 4:3):
Max. 4.0 mega (2 304 × 1 728) pixels*2
Gross: Approx. 2 360 000 pixels
Effective (movie, 16:9): Approx.
1 430 000 pixels
Effective (still image, 16:9): Approx.
1 490 000 pixels
Effective (still image, 4:3): Approx.
1 990 000 pixels
Lens: Carl Zeiss Vario-Tessar
10 × (Optical), 20 ×, 120 × (Digital)
Filter diameter: 30 mm (1 3/16 in.)
Focal length: F1.8 ~ 2.3
f=3.2 ~ 32.0 mm (5/32 ~ 1 5/16 in.)
When converted to a 35 mm still camera
For movies*3: 43 ~ 507 mm (1 3/4 ~ 20 in.)
(16:9)
For still images: 38 ~ 380 mm (1 1/2 ~ 15 in.)
(4:3)
Color temperature: [AUTO], [ONE PUSH],
[INDOOR] (3 200 K),
[OUTDOOR] (5 800 K)
Minimum illumination: 5 lx (lux) ([AUTO SLW
SHUTTR] [ON], Shutter speed 1/25 sec)

*1 "Exif" is a file format for still images, established by the JEITA (Japan Electronics and Information Technology Industries Association). Files in this format can have additional information such as your camcorder's setting information at the time of recording.

*2 The unique pixel array of Sony's ClearVid and the image processing system allow still image resolution equivalent to the sizes described.

*3 The focal length figures are actual figures resulting from wide angle pixel readout.

Input/Output connectors

A/V Remote Connector: Component/video and audio output jack
HDMI OUT jack: HDMI Connector
USB jack: mini-B

LCD screen

Image: 6.7 cm (2.7 type, aspect ratio 16:9)
Total dot number: 211 200 (960 × 220)

General

Power requirements: DC 6.8 V/7.2 V (battery pack)

DC 8.4 V (AC Adaptor)

Average power consumption: During camera recording using the LCD with normal brightness:

HD: 3.8 W

SD: 3.2 W

Operating temperature: 1 °C to 40 °C (33.8 °F to 104 °F)

Storage temperature: -20 °C to + 60 °C (-4 °F to + 140 °F)

Dimensions (approx.): Main body:

81 × 107 × 42 mm

(3 1/4 × 4 1/4 × 1 11/16 in.) (w/h/d) including the projecting parts, excluding the cable bush

81 × 122 × 47 mm

(3 1/4 × 4 7/8 × 1 7/8 in.) (w/h/d) including the projecting parts, excluding the cable bush, and the supplied rechargeable battery pack and controller hook attached

Camera: 37 × 42.5 × 86.5 mm

(1 1/2 × 1 11/16 × 3 1/2 in.) (w/h/d) including the projecting parts

Cable length: 2.8 m (9.18 feet)

Mass (approx.): 500 g (1 lb 1 oz) main unit only

580 g (1 lb 4 oz) including the supplied rechargeable battery pack, controller hook, and “Memory Stick PRO Duo” media

AC Adaptor

Power requirements: AC 100 V - 240 V,
50 Hz/60 Hz

Current consumption: 0.35 A - 0.18 A

Power consumption: 18 W

Output voltage: DC 8.4 V*

Operating temperature: 0 °C to 40 °C (32 °F to 104 °F)

Storage temperature: -20 °C to + 60 °C (-4 °F to + 140 °F)

Dimensions (approx.): 48 × 29 × 81 mm

(1 15/16 × 1 3/16 × 3 1/4 in.) (w/h/d) excluding the projecting parts

Mass (approx.): 170 g (6.0 oz) excluding the power cord (mains lead)

* See the label on the AC Adaptor for other specifications.

Rechargeable battery pack NP-FH60

Maximum output voltage: DC 8.4 V

Output voltage: DC 7.2 V

Maximum charge voltage: DC 8.4 V

Maximum charge current: 2.12 A

Capacity: 7.2 Wh (1 000 mAh)

Type: Li-ion

Design and specifications are subject to change without notice.

- Manufactured under license from Dolby Laboratories.

On trademarks

- “AVCHD” and “AVCHD” logotype are trademarks of Panasonic Corporation and Sony Corporation.
- “Memory Stick,”  “Memory Stick Duo,” “**MEMORY STICK DUO**,” “Memory Stick PRO Duo,” “**MEMORY STICK PRO DUO**,” “Memory Stick PRO-HG Duo,” “**MAGICGATE**,” “MagicGate Memory Stick” and “MagicGate Memory Stick Duo” are trademarks or registered trademarks of Sony Corporation.
- “InfoLITHIUM” is a trademark of Sony Corporation.
- “x.v.Colour” is a trademark of Sony Corporation.
- “BRAVIA” is a trademark of Sony Corporation.
- “Blu-ray Disc” and the logo are trademarks.
- Dolby and the double-D symbol are trademarks of Dolby Laboratories.
- HDMI, the HDMI logo and High-Definition Multimedia Interface are trademarks or registered trademarks of HDMI Licensing LLC.
- Microsoft, Windows, Windows Media, Windows Vista, and DirectX are either registered trademarks or trademarks of Microsoft Corporation in the United States and/or other countries.
- Macintosh and Mac OS are registered trademarks of Apple Inc. in the U.S. and other countries.
- Intel, Intel Core, and Pentium are trademarks or registered trademarks of Intel Corporation or its subsidiaries in the United States and other countries.
- Adobe, the Adobe logo, and Adobe Acrobat are either registered trademarks or trademarks of Adobe Systems Incorporated in the United States and/or other countries.

All other product names mentioned herein may be the trademarks or registered trademarks of their respective companies. Furthermore, ™ and “®” are not mentioned in each case in this manual.

Notes on the License

ANY USE OF THIS PRODUCT OTHER THAN CONSUMER PERSONAL USE IN ANY MANNER THAT COMPLIES WITH THE MPEG-2 STANDARD FOR ENCODING VIDEO INFORMATION FOR PACKAGED MEDIA IS EXPRESSLY PROHIBITED WITHOUT A LICENSE UNDER APPLICABLE PATENTS IN THE MPEG-2 PATENT PORTFOLIO, WHICH LICENSE IS AVAILABLE FROM MPEG LA, L.L.C., 250 STEELE STREET, SUITE 300, DENVER, COLORADO 80206.

THIS PRODUCT IS LICENSED UNDER THE AVC PATENT PORTFOLIO LICENSE FOR THE PERSONAL AND NON-COMMERCIAL USE OF A CONSUMER TO

(i) ENCODE VIDEO IN COMPLIANCE WITH THE AVC STANDARD (“AVC VIDEO”) AND / OR

(ii) DECODE AVC VIDEO THAT WAS ENCODED BY A CONSUMER ENGAGED IN A PERSONAL AND NON-COMMERCIAL ACTIVITY AND/OR WAS OBTAINED FROM A VIDEO PROVIDER LICENSED TO PROVIDE AVC VIDEO. NO LICENSE IS GRANTED OR SHALL BE IMPLIED FOR ANY OTHER USE. ADDITIONAL INFORMATION MAY BE OBTAINED FROM MPEG LA, L.L.C. SEE <[HTTP://MPEGLA.COM](http://MPEGLA.COM)>

“C Library,” “Expat,” “zlib,” and “libjpeg” software are provided in your camcorder. We provide this software based on license agreements with their owners of copyright. Based on requests by the owners of copyright of these software applications, we have an obligation to inform you of the following. Please read the following sections.

Read “license1.pdf” in the “License” folder on the CD-ROM. You will find licenses (in English) of “C Library,” “Expat,” “zlib,” and “libjpeg” software.

On GNU GPL/LGPL applied software

The software that is eligible for the following GNU General Public License (hereinafter referred to as "GPL") or GNU Lesser General Public License (hereinafter referred to as "LGPL") are included in the camcorder.

This informs you that you have a right to have access to, modify, and redistribute source code for these software programs under the conditions of the supplied GPL/LGPL.

Source code is provided on the web. Use the following URL to download it. When downloading the source code, select DCR-DVD810 as the model for your camcorder.

<http://www.sony.net/Products/Linux/>

We would prefer you do not contact us about the contents of source code.

Read "license2.pdf" in the "License" folder on the CD-ROM. You will find licenses (in English) of "GPL," and "LGPL" software.

To view the PDF, Adobe Reader is needed. If it is not installed on your computer, you can download it from the Adobe Systems web page:

<http://www.adobe.com/>

Identifying parts and controls

The numbers in () are reference pages.

Main body

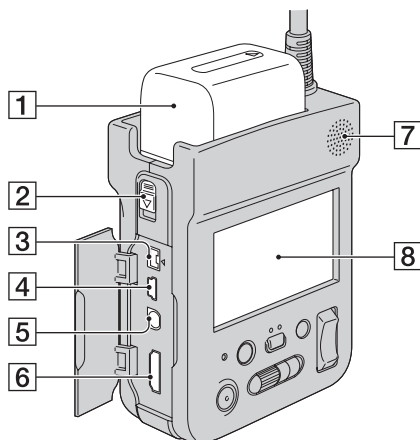

- 1** Battery pack (9)
- 2** BATT RELEASE lever (10)
- 3** DC IN jack (9)
- 4** ψ (USB) jack (41, 42)
- 5** A/V Remote Connector (28)
- 6** HDMI OUT jack (28)
- 7** Speaker
Playback sounds come out from the speaker. For how to adjust the volume, see page 24.
- 8** LCD screen (12)

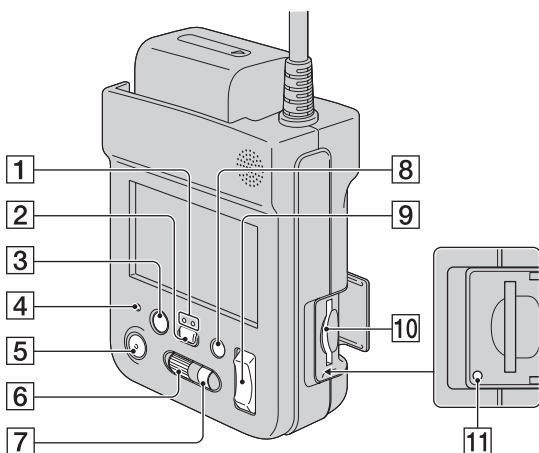

- 1** (Movie)/ (Still) mode lamps (12)
- 2** (Movie)/ (Still) select button (12)
- 3** PHOTO button (19)
- 4** Camera recording lamp (57)
Lights up in red during recording.
Flashes when remaining “Memory Stick PRO Duo” media space or battery power is low.
- 5** START/STOP button (19)
- 6** CAM CTRL dial (22)
- 7** MANUAL button (22)
- 8** DISPLAY/BATT INFO button (10, 13)
- 9** Power zoom lever (20, 27)
- 10** “Memory Stick Duo” media slot (14)
- 11** Access lamp (14)

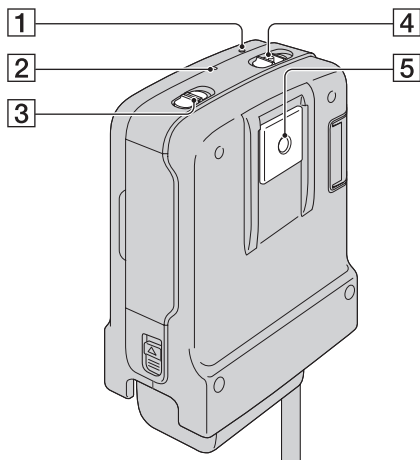

- 1** RESET button
Initializes all the settings, including the setting of the date and time.
- 2** CHG (charge) lamp (9)
- 3** HOLD switch (20)
- 4** POWER switch (12)
- 5** Controller hook attachment/Tripod receptacle
You cannot use a tripod when you attach the controller hook.

To attach the controller hook

Slide the controller hook in the direction of the arrow until it clicks.

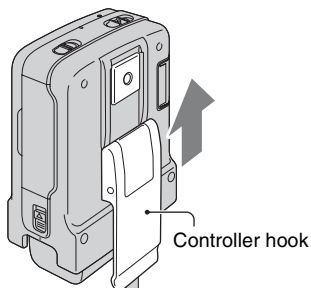

To remove the controller hook

Raise the edge of the controller hook, then slide it in the direction of the arrow to remove the controller hook.

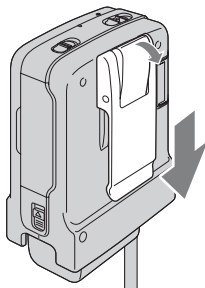

Camera

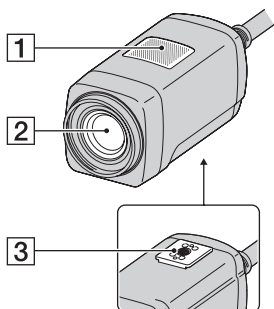

1 Built-in microphone

2 Lens (Carl Zeiss Lens) (4)

3 Tripod receptacle

Attach the tripod (sold separately) to the tripod receptacle using a tripod screw (sold separately: the length of the screw must be less than 5.5 mm (7/32 in.)).

To adhere the cable clamber

Raise the one-touch tape, then wind the cable around the hook to adhere the one-touch tape.

One-touch tape

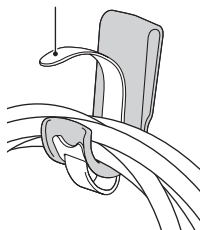

Indicators displayed during recording/playback

Recording movies

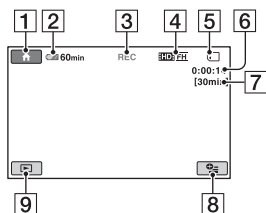

Recording still images

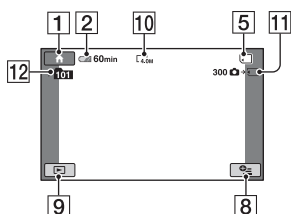

Viewing movies

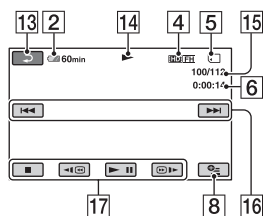

Viewing still images

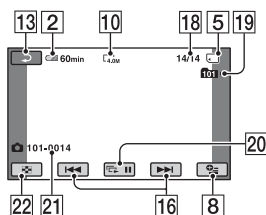

- 1 HOME button (47)
- 2 Remaining battery (approx.) (10)
- 3 Recording status ([STBY] (standby) or [REC] (recording))
- 4 Recording quality (HD/SD) (44) and recording mode (FH/HQ/SP/LP) (49)
- 5 Media
- 6 Counter (hour/minute/second)
- 7 Recording remaining time
- 8 OPTION button (59)
- 9 VIEW IMAGES button (23)
- 10 Image size (52)
- 11 Approximate number of recordable still images and media/During still image recording
- 12 Recording folder
- 13 Return button
- 14 Playback mode
- 15 Currently playing movie number/ Number of total recorded movies
- 16 Previous/Next button (24)
- 17 Video operation buttons (24)
- 18 Currently playing still image number/ Number of total recorded still images
- 19 Playback folder
- 20 Slide show button (28)
- 21 Data file name
- 22 VISUAL INDEX button (23)

Indicators when you made changes

Following indicators appear during recording/playback to indicate the settings of your camcorder.

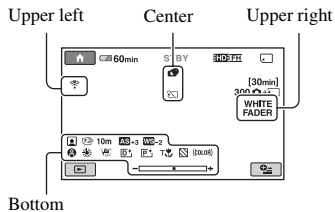

Upper left

Indicator	Meaning
	Self-timer recording (65)
	MICREF LEVEL low (65)
	WIDE SELECT (50)
	BLT-IN ZOOM MIC (65)

Center

Indicator	Meaning
	IMAGE SIZE (52)
	Continuous slide show (28)
	Color Slow Shutter (64)
	PictBridge connecting (42)
	Warning (74)

Upper right

Indicator	Meaning
	Fader (64)
	LCD backlight off (13)

Bottom

Indicator	Meaning
	Picture effect (64)
	Digital effect (64)
	Manual focus (61)
	SCENE SELECTION (62)
	White balance (63)
	SPOT METER (62)/EXPOSURE (62)
	Tele macro (61)
	AE SHIFT (49)
	WB SHIFT (49)
	Zebra (50)
	X.V.COLOR (50)
	Face Index (51)

💡 Tips

- Indicators and their positions are approximate and differ from what you actually see.
- If you play back the image recorded with other device supporting 5.1ch surround sound, appears on the upper-left corner of the screen.

Data code during recording

The recording date and time is recorded automatically on the “Memory Stick PRO Duo” media. They are not displayed while recording. However, you can check them as [DATA CODE] during playback (p. 53).

Index

Numeric

1080i/576i	56
16:9	56
21-pin adaptor	32
4:3	56
4:3 TV	30
576i	56

A

AC Adaptor	8
ADD by date	38
AE SHIFT	49
AREA SET	57
AUTO SLW SHUTTR (Auto Slow Shutter)	50, 73
AVCHD format	78
A.SHUT OFF (Auto shut off)	57
A/V connecting cable	8, 31, 40
A/V Remote Connector	28

B

Backup	33
Battery pack	9
BEACH	63
BEEP	55
BLACK FADER	64
BLT-IN ZOOM MIC (Built-in zoom microphone)	65
B&W (Black and white)	64

C

CALIBRATION	82
Camera control dial	22
CAMERA DATA	53
CANDLE	62
CD-ROM	8
Charging the battery	9
Charging time	10
CLOCK SET	12

CLOCK/LANG	57
COLOR SLOW SHTR (Color Slow Shutter)	64, 73
COMPONENT	56
Component A/V cable	8, 29, 31
Computer	33
CTRL FOR HDMI (Control for HDMI)	58

D

DATA CODE	53, 92
Date Index	27
DATE/TIME	13, 53, 92
DC IN jack	9
DELETE	34
DIAL SETTING	51
DIGITAL ZOOM	50
DISP OUTPUT	56, 73
DISPLAY	54
Display indicators	91
DIVIDE	37
Dual Rec	21
Dubbing	40
D.EFFECT (Digital effect)	64, 73

E

EDIT	37
Editing	34
ERASE	39
EXPOSURE	62

F

Face Index	26
FADER	64, 73
FH	49
File	77
FILE NO. (File number)	52
Film Roll Index	26
FIREWORKS	62
FOCUS	61, 71

Folder	77
Format	45
Full charge	10

G

GENERAL SET	57
GUIDEFRAAME	50

H

HD (high definition) image quality	49
HDMI cable	30
HD/SD SET	44
HELP	16
High Definition TV	29
HOLD	20
HOME MENU	16, 47
HQ	49

I

Icon	91
Image management files	77
Image quality	44
Image quality setting	44
IMAGE SIZE	52
Index screen display button	91
INDEX SET (Face Index set)	51
Indicators	92
INDOOR	63
“InfoLITHIUM” battery pack	79
Install	66

J

JPEG	77
------------	----

L

LANDSCAPE	63
LANGUAGE SET	57

LCD BL LEVEL (LCD backlight level).....	55
LCD BRIGHT	55
LCD COLOR	55
LCD PANEL.....	56
LCD panel	12
LP	49

M

Maintenance	78
MANAGE MEDIA category	44
MEDIA FORMAT	45
MEDIA INFO.....	45
“Memory Stick”	2, 78
“Memory Stick Duo”.....	2, 78
“Memory Stick Duo” media adaptor.....	2, 79
“Memory Stick PRO Duo”	2, 78
“Memory Stick PRO-HG Duo”	2, 78
MICREF LEVEL (Microphone reference level)	65, 73
Moisture condensation	81
MOVE	39
Movie.....	19
MOVIE SETTINGS	49
MPEG2.....	77
MPEG-4 AVC/H.264	78

N

Number of recordable pictures	52
--	----

O

OLD MOVIE.....	64
ONE PUSH.....	63
One Touch Disc Burn.....	33
Operation confirmation beep	55
OPTION MENU.....	59
Original.....	38

OTHERS category	34
OUTDOOR.....	63
OUTPUT SETTINGS.....	56

P

PAL.....	3
PASTEL.....	64
PB zoom.....	27
PHOTO CAPTURE.....	36
PHOTO SETTINGS	52
PictBridge	42
PICT.EFFECT (Picture effect)	64, 73
Playback.....	23
Playback time.....	11
Playlist	38
PLAYLIST EDIT	39
PMB Guide	66, 68
PMB (Picture Motion Browser)	66
PORTRAIT (Soft portrait)....	63
Power cord (Mains lead).....	8
Pre-installed rechargeable battery	83
Preventing operation errors	20
Print.....	42
Printer.....	42

R

REC LAMP (Recording lamp)	57
REC MODE (Recording mode)	49
RECORD SOUND	21
Recording.....	18
Recording format	78
Recording quality.....	15
Recording time.....	11
Remaining battery.....	10
REMAINING SET (movie)	51

REPAIR IMG.DB F.	46
RESET	89

S

S VIDEO cable.....	31, 40
Saving images	33
SCENE SELECTION	62, 73
SD (standard definition) image quality.....	49
Self-diagnosis display	74
SELF-TIMER.....	65
SEPIA.....	64
SETTINGS category	47
Slide show	28
SLIDE SHOW SET.....	28
SMTH SLW REC.....	21
SNOW	63
Software	66
SOUND/DISP SET	55
SP	49
Specifications	83
Splash-proof performance ...	81
SPOT FOCUS	61, 73
SPOT METER (Flexible spot meter)	62
SPOTLIGHT	63
Still image	19
SUB-T DATE (Subtitle date)	51
SUMMERTIME.....	57
SUNRISE&SUNSET	62

T

TELE MACRO	61, 73
Telephoto.....	20
TIMING	21
Tripod.....	89, 90
TV color system	3
TV TYPE.....	56
TWILIGHT	62

U

USB 2.0	66
USB cable	8
USB CONNECT	77
USB SELECT	41, 42

V

VCR or DVD/HDD recorders	40
VIEW IMAGES SET	53
Viewing pictures on a TV	28
VISUAL INDEX	23
VOLUME	55
Volume adjustment	24
V-OUT/PANEL	56

W

Wall outlet (Wall socket)	9
Warning indicators	74
Warning messages	75
WB SHIFT (White Balance Shift)	49
WHITE BAL. (White balance)	63, 73
WHITE FADER	64
Wide angle	20
WIDE SELECT	50, 73
Wide TV	30
Windows	66

X

X.V.COLOR	50
-----------------	----

Z

ZEBRA	50
Zoom	20
ZOOM LINK	54

<http://www.sony.net/>

Printed in Japan

GB



Download from [Www.Somanuals.com](http://www.Somanuals.com). All Manuals Search And Download.

Free Manuals Download Website

<http://myh66.com>

<http://usermanuals.us>

<http://www.somanuals.com>

<http://www.4manuals.cc>

<http://www.manual-lib.com>

<http://www.404manual.com>

<http://www.luxmanual.com>

<http://aubethermostatmanual.com>

Golf course search by state

<http://golfingnear.com>

Email search by domain

<http://emailbydomain.com>

Auto manuals search

<http://auto.somanuals.com>

TV manuals search

<http://tv.somanuals.com>