

# OWNER'S/ OPERATOR'S MANUAL

**MODEL NO's**  
**SDM40-48**  
**SDM40-60**  
**SDM40-72**

## **⚠ CAUTION**

For Safe Operation  
Read Rules And  
Instructions Carefully

SINO LEEINGLES, PIDA AYUDA  
A AIGUIEN QUE SI LO LEA  
PARA QUE LE TRADUZCA LAS  
MEDIDAS DE SEGURIDAD.

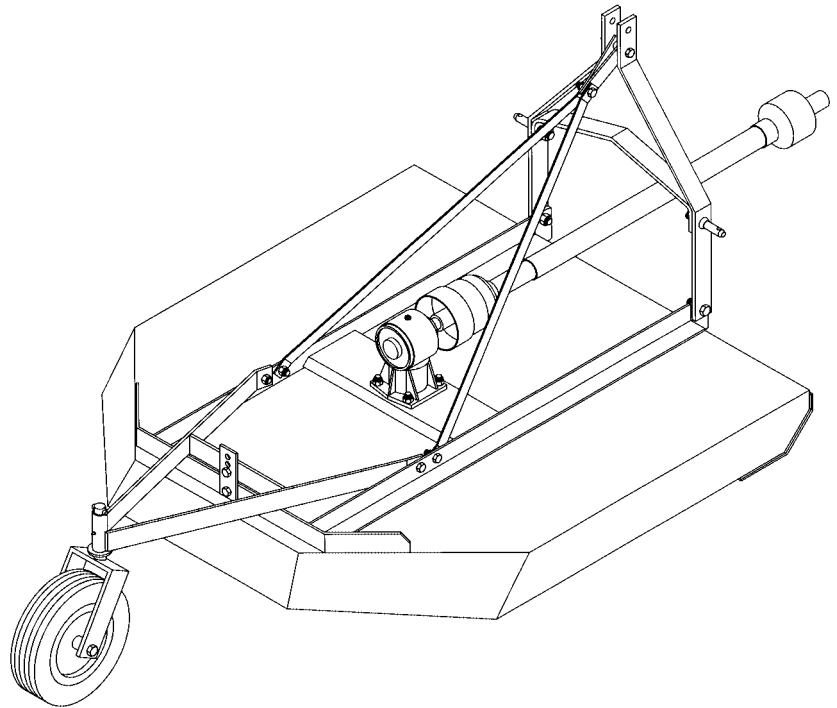

# STANDARD DUTY 3-PT. MOUNTED ROTARY CUTTER

**Safety Instructions**  
**Tractor Preparation**

**Operating Instructions**  
**Assembly & Mounting**

**Maintenance**  
**Repair Parts**

## **⚠ CAUTION**

**THE FOLLOWING SAFETY PRECAUTIONS SHOULD BE THOROUGHLY UNDERSTOOD  
BEFORE ATTEMPTING TO BEGIN ASSEMBLING THIS MACHINE**

1. Select an area for assembly that is clean and free of any debris which might cause persons working on the assembly to trip.
2. Do not lift heavy parts or assemblies. Use crane, jack, tackle, fork trucks or other mechanical devices.
3. Preview the assembly instructions in your operator's manual before proceeding further.
4. If the assembly instructions call for parts or assemblies to be blocked up, use only blocking material that is in good condition and is capable of handling the weight of the assembly to be blocked. Also insure that the blocking material is on a clean, dry surface.
5. Never put hands, or any part of body, under blocked up assemblies if at all possible.
6. After completing assembly, thoroughly inspect the machine to be sure that all nuts, bolts, hydraulic fittings or any other fastened assemblies have been thoroughly tightened.
7. Before operating the machine, thoroughly read the operation section of your operator's manual.
8. Before operating, read the maintenance section of your operator's manual to be sure that any parts requiring lubrication, such as gearboxes, are full, to avoid any possible damage.
9. **Before operating equipment – If you have any questions regarding the proper assembly or operation, contact your Worksaver dealer or representative.**

# TABLE OF CONTENTS

SPECIFICATIONS .....	2
CHECKLISTS .....	3
SAFETY INFORMATION .....	4
SAFETY SIGNS .....	15
PREPARATION INSTRUCTIONS .....	17
OPERATING INSTRUCTIONS .....	20
OWNER MAINTENANCE & LUBRICATION .....	23
TORQUE CHART .....	26
TROUBLESHOOTING .....	27
WARRANTY .....	31
PARTS LISTS .....	32

SINO LEEINGLES, PIDA AYUDA A AIGUIEN QUE SI LO LEA PARA QUE LE TRADUZCA LAS MEDIDAS DE SEGURIDAD.

## STATEMENT OF POLICY

It is the policy of **Worksaver, Inc.** to improve its products where it is possible and practical to do so. **Worksaver, Inc.** reserves the right to make changes or improvements in design and construction at any time, without incurring the obligation to make these changes on previously manufactured units.

## TO THE OWNER :

Read this manual before using your Standard Duty Rotary Cutter. This manual is provided to give you the necessary operating and maintenance instructions for keeping your rotary cutter in top operating condition. Please read this manual thoroughly. Understand what each control is for and how to use it. Observe all safety signs on the machine and noted throughout the manual for safe operation of implement. Keep this manual handy for ready reference.

Like all mechanical products, it will require cleaning and upkeep. Lubricate the Cutter as specified.

Use only genuine Worksaver, Inc. service parts. Substitute parts will void the warranty and may not meet standards required for safe and satisfactory operation. Record the model and serial number of your Cutter here:

Model: \_\_\_\_\_ Serial Number: \_\_\_\_\_

---

---

## RETAIL CUSTOMER'S RESPONSIBILITY

**It is the Retail Customer and/or Operator's responsibility to read the Operator's Manual, to operate, lubricate, maintain, and store the product in accordance with all instructions and safety procedures. Failure of the operator to read the Operator's Manual is a misuse of this equipment.**

**It is the Retail Customer and/or Operator's responsibility to inspect the product and to have any part(s) repaired or replaced when continued operation would cause damage or excessive wear to other parts or cause a safety hazard.**

**It is the Retail Customer's responsibility to deliver the product to the authorized Worksaver Dealer, from whom he purchased it, for service or replacement of defective parts which are covered by warranty. Repairs to be submitted for warranty consideration must be made within forty-five (45) days of failure.**

**It is the Retail Customer's responsibility for any cost incurred by the Dealer for traveling to or hauling of the product for the purpose of performing a warranty obligation or inspection.**

# R O T A R Y   C U T T E R   S P E C I F I C A T I O N S

<b><u>SUBJECT</u></b>	<b><u>MODEL SDM40-48</u></b>	<b><u>MODEL SDM40-60</u></b>	<b><u>MODEL SDM40-72</u></b>
Cutting Width .....	47"	60½"	71½"
Overall Length .....	86"	98"	109"
Overall Width .....	50½"	62½"	74½"
Cutting Height .....	1-5"	1-5"	1-5"
Deck (Welded Construction) ..	11 Gauge (.119" thick)		
Front Side Skids .....	¼" Thick x 2½"		
3 pt. Hitch .....	Category I Standard		
Tailwheel .....	16" Diameter – Solid Rubber Tire		
Gearbox .....	30 HP Maximum	40 HP Maximum Rating	
Ratio .....	1:1.92	1:1.47	
Input RPM .....	540 RPM	540 RPM	
Output RPM .....	1036.8 RPM	793.8 RPM	
Gearbox Warranty .....	Limited 1 Year		
Gearbox Lubrication .....	90 wt Gear Oil		
PTO Driveline Type .....	Metric Series 4		
Total Driveline Length (Closed)	32"	37"	43"
Shearbolt .....	½" Diameter x 3.0" Bolt Grade 2		
Blades (Number & Type) .....	(2) Suction Type		
Width & Thickness .....	½" x 3"		
Length (Total) .....	18"	25"	30"
Tip Speed .....	12,757 Ft./Min.	12,255 Ft./Min.	15,170 Ft./Min.
Blade Carrier .....	Stump Jumper Type		
Thickness .....	⅜"		
Construction .....	Welded		
Shipping Weight .....	395 lb.	480 lb.	575 lb.

# CHECKLISTS

## DELIVERY CHECKLIST

---

Inspect the cutter thoroughly after assembly to be certain it is set up properly. The following checklist is a reminder of points to inspect. Check off each item as it is found satisfactory or after proper adjustment is made.

- h Check operator's manual and familiarize the operator with all sections of it.
- h Check that all safety shielding is in place.
- h Check all bolts to be sure they are tight or adjusted properly at hinged locations.
- h Check that all cotter pins are properly installed.
- h Check PTO driveline. Make sure it is the correct length to operate cutter with intended tractor.
- h Check that all lubrication points with grease fittings have been lubricated.
- h Check that blades have been properly installed. Check all blade beam bolts.
- h Check cutter attitude, after mounting on tractor.
- h Check that gearbox is properly serviced and seals are not leaking.
- h Check shear bolt for proper grade and installation.
- h Check front of input gearbox shaft and make sure that snap ring is properly installed.
- h All safety signs (decals) in place and readable.
- h When the cutter is transported on a road or highway at night or during the day, safety devices should be used for adequate warning to operators of other vehicles.

## DAILY CHECKLIST

---

- h Check that cutter is properly and securely attached to tractor.
- h During inspection, check that all nuts and bolts are secure and that all safety shields are in place.
- h It is very important that the blade carrier nut and blade bolts are checked and tightened frequently.
- h Check condition of blades and security of attachment.
- h Check that PTO driveline shields are securely locked and clears the front of the cutter frame.
- h Adjust the tractor top link so the front of the cutter is slightly above the rear. Then raise the tractor lift very slowly, making sure that the front drive shaft shield does not hit the front of the cutter. If it does, damage will be done to the drive shaft shield and, if it hits hard enough, it will also damage the drive shaft itself. (See page 20.)

**NOTE: This type of damage is not covered under warranty, as it is totally under the control and the responsibility of the operator.**

### IMPORTANT !

**Gearbox was not filled at factory. It must be serviced before operating. Fill to proper level with SAE 90 oil. Failure to service will result in damage to gearbox.**

# To the Owner/Operator/Dealer

All implements with moving parts are potentially hazardous. There is no substitute for a cautious, safe-minded operator who recognizes the potential hazards and follows reasonable safety practices. The manufacturer has designed this implement to be used with all its safety equipment properly attached to minimize the chance of accidents.

## BEFORE YOU START!!

**Read the safety messages on the implement and shown in your manual.  
Observe the rules of safety and common sense!**



### THIS SYMBOL MEANS

- ATTENTION!
- BECOME ALERT!
- YOUR SAFETY IS INVOLVED!

THIS SAFETY ALERT SYMBOL IDENTIFIES IMPORTANT SAFETY WARNING MESSAGES. CAREFULLY READ EACH WARNING MESSAGE THAT FOLLOWS. FAILURE TO UNDERSTAND AND OBEY A SAFETY WARNING, OR RECOGNIZE A SAFETY HAZARD, COULD RESULT IN AN INJURY OR DEATH TO YOU OR OTHERS AROUND YOU. THE OPERATOR IS ULTIMATELY RESPONSIBLE FOR THE SAFETY OF HIMSELF, AS WELL AS OTHERS, IN THE OPERATING AREA OF THE TRACTOR AND ATTACHED EQUIPMENT.

---

## UNDERSTAND SIGNAL WORDS

Note the use of the signal words **DANGER**, **WARNING** and **CAUTION** with the safety messages. The appropriate signal word for each has been selected using the following guidelines:

**DANGER:** Indicates an imminently hazardous situation that, if not avoided, will result in death or serious injury. This signal word is to be limited to the most extreme situations typically for machine components which, for functional purposes, cannot be guarded.

**WARNING:** Indicates a potentially hazardous situation that, if not avoided, could result in death or serious injury, and includes hazards that are exposed when guards are removed. It may also be used to alert against unsafe practices.

**CAUTION:** Indicates a potentially hazardous situation that, if not avoided, may result in minor or moderate injury. It may also be used to alert against unsafe practices.

If you have questions not answered in this manual or require additional copies or the manual is damaged, please contact your dealer or the manufacturer directly.

---

## IMPORTANT SAFETY INFORMATION!

Working with unfamiliar equipment can lead to careless injuries. Read this manual, and the manual for your tractor, before assembly or operating, to acquaint yourself with the machines. It is the implement owner's responsibility, if this machine is used by any person other than yourself, is loaned or rented, to make certain that the operator, prior to operating:

1. Reads and understands the operator's manuals.
2. Is instructed in safe and proper use.













The use of this equipment is subject to certain hazards which cannot be protected against by mechanical means or product design. All operators of this equipment must read and understand this entire manual, paying particular attention to safety and operating instructions, prior to using. If there is something in this manual you do not understand, ask your supervisor, or your dealer, to explain it to you.

## SAFETY INSTRUCTIONS (continued)







### EQUIPMENT SAFETY GUIDELINES

-  Safety of the operator is one of the main concerns in designing and developing a new piece of equipment. Designers and manufacturers build in as many safety features as possible. However, every year many accidents occur which could have been avoided by a few seconds of thought and a more careful approach to handling equipment. You, the operator, can avoid many accidents by observing the following precautions in this section. To avoid personal injury, study the following precautions and insist those working with you, or for you, follow them.
  
-  In order to provide a better view, certain photographs or illustrations in this manual may show an assembly with a safety shield removed. However, equipment should never be operated in this condition. Keep all shields in place. If shield removal becomes necessary for repairs, replace the shield prior to use.
  
-  Replace any CAUTION, WARNING, DANGER or instruction safety sign that is not readable or is missing. Location of such safety signs is indicated in this booklet.
  
-  Never use alcoholic beverages or drugs which can hinder alertness or coordination while operating this equipment. Consult your doctor about operating this machine while taking prescription medications.
  
-  Review the safety instructions with all users annually.
  
-  This equipment is dangerous to children and persons unfamiliar with its operation. The operator should be a responsible adult familiar with farm machinery and trained in this equipment's operations. **Do not allow persons to operate or assemble this unit until they have read this manual and have developed a thorough understanding of the safety precautions and of how it works.**
  
-  To prevent injury or death, use a tractor equipped with a Roll-Over Protective System (ROPS). Do not paint over, remove or deface any safety signs or warning signs on your equipment. Observe all safety signs and practice the instruction on them.
  
-  Never exceed the limits of a piece of machinery. If its ability to do a job, or to do so safely, is in question – **DON'T TRY IT.**
  
-  Do not modify the equipment in any way. Unauthorized modification may impair the function and/or safety and could affect the life of the equipment.
  
-  In addition to the design and configuration of this implement, including Safety Signs and Safety Equipment, hazard control and accident prevention are dependent upon the awareness, concern, prudence, and proper training of personnel involved in the operation, transport, maintenance, and storage of the machine. Refer also to Safety Messages and Operation Instructions in each of the appropriate sections of the Tractor and Cutter Manuals. Pay close attention to the Safety Signs affixed to the Tractor and the Cutter.







## SAFETY INSTRUCTIONS (continued)



### **SAFETY SIGNS**





-  Keep safety signs clean and legible at all times.
-  Replace safety signs that are missing or have become illegible.
-  Replaced parts that displayed a safety sign should also display the current sign.
-  Safety signs are available from your Distributor or Dealer Parts Department or the factory.

### **How to Install Safety Signs:**

-  Be sure that the installation area is clean and dry.
-  Be sure temperature is above 50°F (10°C).
-  Decide on the exact position before you remove the backing paper.
-  Remove the smallest portion of the split backing paper.
-  Align the sign over the specified area and carefully press the small portion with the exposed sticky backing in place.
-  Slowly peel back the remaining paper and carefully smooth the remaining portion of the sign in place.
-  Small air pockets can be pierced with a pin and smoothed out using the piece of sign backing paper.



### **TIRE SAFETY**

-  Failure to follow proper procedures when mounting a tire on a wheel or rim can produce an explosion which may result in serious injury or death.
-  Do not attempt to mount a tire unless you have the proper equipment and experience to do the job.
-  Inflating or servicing tires can be dangerous. Whenever possible, trained personnel should be called to service and/or mount tires.
-  Always order and install tires and wheels with appropriate capacity to meet or exceed the anticipated weight to be placed on the equipment.

# SAFETY INSTRUCTIONS (continued)



## SAFETY TRAINING

 Safety is a primary concern in the design and manufacture of our products. Unfortunately, our efforts to provide safe equipment can be wiped out by a single careless act of an operator.

 In addition to the design and configuration of equipment, hazard control and accident prevention are dependent upon the awareness, concern, prudence and proper training of personnel involved in the operation, transport, maintenance and storage of equipment.

 It has been said, "The best safety device is an informed, careful operator." We ask you to be that kind of an operator. It is the operator's responsibility to read and understand ALL Safety and Operating instructions in the manual and to follow these. Accidents can be avoided.

 Working with unfamiliar equipment can lead to careless injuries. Read this manual, and the manual for your tractor, before assembly or operating, to acquaint yourself with the machines. It is the rotary cutter owner's responsibility, if this machine is used by any person other than yourself, is loaned or rented, to make certain that the operator, prior to operating:

1. Reads and understands the operator's manuals.
2. Is instructed in safe and proper use.

 Know your controls and how to stop tractor, engine, and cutter quickly in an emergency. Read this manual and the one provided with your tractor.

 Train all new personnel and review instructions frequently with existing workers. A person who has not read and understood all operating and safety instructions is not qualified to operate the machine. An untrained operator exposes himself and bystanders to possible serious injury or death.

 Do not allow children to operate this machine.



## SAFETY INSTRUCTIONS (continued)



### PREPARATION



Never operate the tractor and cutter until you have read and completely understand this manual, the Tractor Operator's Manual, and each of the Safety Messages found on the safety signs on the tractor and cutter.



Personal protection equipment including hard hat, safety glasses, safety shoes, and gloves are recommended during assembly, installation, operation, adjustment, maintaining, repairing, removal, or moving the implement. Do not allow long hair, loose fitting clothing or jewelry to be around moving parts.



#### **PROLONGED EXPOSURE TO LOUD NOISE MAY CAUSE PERMANENT HEARING LOSS!**

Tractors with or without Cutters attached can often be noisy enough to cause permanent, partial hearing loss. We recommend that you wear hearing protection on a full-time basis if the noise in the Operator's position exceeds 80db. Noise over 85db on a long-term basis can cause severe hearing loss. Noise over 90db adjacent to the Operator over a long-term basis may cause permanent, total hearing loss. **NOTE:** Hearing loss from loud noise (from tractors, chain saws, radios, and other such sources close to the ear) is cumulative over a lifetime without hope of natural recovery.



Operate the cutter only with a tractor equipped with an approved Roll-Over Protective System (ROPS). Always wear your seat belt on tractors equipped with a ROPS. Serious injury or even death could result from falling off the tractor --particularly during a turnover when the operator could be pinned under the ROPS or the tractor.



Clear area to be cut of stones, branches or other debris that might be thrown, causing injury or damage.



Operate only in daylight or good artificial light.



Ensure cutter is properly mounted, adjusted and in good operating condition.



Make sure driveline spring-activated locking pin or balls operate freely and are seated firmly in tractor PTO stub shaft groove.







Ensure that all safety shielding and safety signs are properly installed and in good condition.

## SAFETY INSTRUCTIONS (continued)



### STARTING AND STOPPING SAFETY





-  Cutter operating power is supplied from tractor PTO. Refer to your tractor manual for PTO engagement and disengagement instructions. Always operate PTO at 540 RPM. Know how to stop tractor and cutter quickly in case of an emergency.
-  When engaging PTO, the engine RPM should always be low. Once engaged and ready to start cutting, raise PTO speed to 540 RPM and maintain throughout cutting operation.
-  Check the tractor master shield over the PTO stub shaft. Make sure it is in good condition and fastened securely to the tractor. Purchase a new shield if old shield is damaged or missing. (You may have to use a tractor salvage yard for replacement parts on older tractors.)
-  All tractors that are not equipped with a “live” takeoff (PTO) need to be equipped with an over-running PTO clutch type driveline. These are available as optional equipment. See page 22.

NOTE: The addition of a separate over-running PTO clutch attachment will change the length of the PTO driveline. Pay extra attention to the instructions on PTO driveline installation.

Separate over-running clutch attachments will increase the length of the driveline and may cause the front knuckle joint to operate beyond the cover of the tractor master shield. This is NOT recommended and will present a dangerous operating condition.

















### OPERATIONAL SAFETY

-  The use of this equipment is subject to certain hazards which cannot be protected against by mechanical means or product design. All operators of this equipment must read and understand this entire manual, paying particular attention to safety and operating instructions, prior to using. If there is something in this manual you do not understand, ask your supervisor, or your dealer, to explain it to you.
-  Most accidents occur because of neglect or carelessness. Keep all helpers and bystanders at least several hundred feet from an operating rotary cutter. Only properly trained people should operate this machine.
-  When this machine is operated in populated areas or in other areas where thrown objects could injure persons or property, standard equipment safety chain shielding (which is designed to reduce the possibility of thrown objects) must be installed. If this machine is not equipped with full chain shielding, **operation must be stopped when anyone comes within several hundred feet.**
-  The majority of accidents involve entanglement on the driveline, injury of bystanders by objects thrown by the rotating blades, and operators being knocked off the tractor by low hanging limbs and then being run over by the cutter. Accidents are most likely to occur with machines that are loaned or rented to someone who has not read the owner's manual and is not familiar with a rotary cutter.

## SAFETY INSTRUCTIONS (continued)















### OPERATIONAL SAFETY (continued)

-  Always stop the tractor, set brake, shut off the tractor engine, remove the ignition key, lower implement to the ground and allow cutter blades to come to a complete stop before dismounting tractor. Never leave equipment unattended with the tractor running.
-  Never place hands or feet under cutter with tractor engine running or before you are sure all motion has stopped. Stay clear of all moving parts.
-  Do not reach or place yourself under equipment until it is blocked securely.
-  Take all possible precautions when leaving unit unattended: Disengage PTO, set parking brake, stop engine and remove key from ignition. Park in level area.
-  Do not allow riders on the rotary cutter or tractor at any time. There is no safe place for any riders.
-  Disengage power takeoff (PTO) and place transmission into neutral before attempting to start engine.
-  Do not operate unless all personnel, livestock, and pets are several hundred feet away to prevent injury by thrown objects. Never direct discharge toward anyone.
-  Install and secure all guards and shields before starting or operating.
-  Keep hands, feet, hair, and clothing away from moving parts.
-  This rotary cutter is designed for use only on tractors with 540 RPM power takeoff.
-  Never operate tractor and cutter under trees with low hanging limbs. Operators can be knocked off the tractor and then run over by the rotating blades.
-  The rotating parts of this machine have been designed and tested for rugged use. However, they could fail upon impact with heavy, solid objects such as steel guard rails, posts, and concrete abutments. Such impact could cause the broken objects to be thrown outward at very high velocities. To reduce the possibility of property damage, serious injury, or even death, never allow the cutting blades to contact such obstacles.
-  Frequently check cutter blades. They should be sharp, free of nicks and cracks and securely fastened.
-  Many varied objects, such as wire, cable, rope, or chains, can become entangled in the operating parts of the cutter head. These items could then swing outside the housing at greater velocities than the blades. Such a situation is extremely hazardous. Inspect the cutting area for such objects before mowing. Removing any like object from the site. Never allow the cutting blades to contact such items.
-  Pick up all rocks and other debris before mowing. Enter new areas carefully. Cut material higher at first, allowing cutter to clear hidden objects. Never assume an area is clear. **Always Check!**

## SAFETY INSTRUCTIONS (continued)



















### **OPERATIONAL SAFETY (continued)**

-  Stop cutter and tractor immediately upon striking an obstruction. Turn engine off, remove key, inspect and repair any damage before resuming operation.
-  The chain guards, bands, flaps, driveline shields, and gearbox shields should be used and maintained in good working condition. They should be inspected carefully, at least daily, for missing or broken cable, chain links, shields, or guards. Missing broken, or worn items must be replaced at once to reduce the possibility of injury from thrown objects or entanglement.
-  Stay alert for holes, rocks and roots in the terrain and other hidden hazards. Keep away from drop-offs.
-  Use extreme care and maintain minimum ground speed when transporting on hillside, over rough ground and when operating close to ditches or fences. Be careful when turning sharp corners.
-  Reduce speed on slopes and sharp turns to minimize tipping or loss of control. Be careful when changing directions on slopes. Do not start or stop suddenly on slopes. Avoid operation on steep slopes.
-  When using a unit, a minimum 20% of tractor and equipment weight must be on tractor front wheels. Without this weight, tractor could tip over, causing personal injury or death. The weight may be attained with a front end loader, front wheel weights, ballast in tires of front tractor weights. When attaining a minimum 20% of tractor and equipment weight on the front wheels, you must not exceed the ROPS weight certification. Weigh the tractor and equipment. Do not guess or estimate!
-  Inspect the entire machine periodically as indicated in the Maintenance Section of this manual. Look for loose fasteners, worn or broken parts, pinched hydraulic hoses, and leaky or loose fittings. Make sure all pins have cotter pins and washers. Serious injury may occur from not maintaining this machine in good working order.
-  Be careful when operating tractor and cutter on uneven ground to avoid upsetting.
-  In extremely uneven terrain, rear wheel weights, front tractor weight, and/or tire ballast should be used to improve stability.
-  Pass diagonally through sharp dips and avoid sharp drops to prevent “hanging up” tractor and cutter. Practice will improve your skills in maneuvering rough terrain.
-  Avoid sudden starts and stops while traveling up or downhill.
-  Always cut down slopes; never across the face. Avoid operation on steep slopes. Slow down on sharp turns and slopes to prevent tipping and/or loss of control.

## SAFETY INSTRUCTIONS (continued)

















### TRANSPORT SAFETY

-  Comply with state and local laws governing highway safety and movement of farm machinery on public roads.
-  The use of flashing amber lights is acceptable in most localities. However, some localities prohibit their use. Local laws should be checked for all highway lighting and marking requirements.
-  When driving the tractor and equipment on the road or highway under 20 mph (32 kph) at night or during the day, use flashing amber warning lights and a slow moving vehicle (SMV) identification emblem.
-  Always be sure the implement is in the proper raised position for transport.
-  Reduce speed when transporting mounted implements to avoid bouncing and momentary loss of steering control.
-  Plan your route to avoid heavy traffic.
-  Always install transport locks, pins or brackets before transporting.
-  Do not drink and drive!
-  Watch for traffic when operating near or crossing roadways.
-  Turn curves or go up or down hills only at a low speed and at a gradual steering angle. Make certain that at least 20% of the tractor's weight is on the front wheels to maintain safe steerage. Slow down on rough or uneven surfaces, and loose gravel.
-  Use extreme care and maintain minimum ground speed when transporting on hillside, over rough ground and when operating close to ditches or fences. Be careful when turning sharp corners.
-  Never allow riders on either tractor or cutter. Falling off can kill.
-  Be a safe and courteous driver. Always yield to oncoming traffic in all situations, including narrow bridges, intersections, etc.
-  Do not exceed 20 mph (32 kph). Reduce speed on rough roads and surfaces.
-  Use hardened hitch pins with retainers when attaching to pull-type machines.
-  Use a safety chain to prevent unexpected separation with pull-type models.

## SAFETY INSTRUCTIONS (continued)



### MAINTENANCE SAFETY

-  Good maintenance is your responsibility. Poor maintenance is an invitation to trouble.
  
-  Follow good shop practices.
  - Keep service area clean and dry.
  - Be sure electrical outlets and tools are properly grounded.
  - Use adequate light for the job at hand.
  
-  Make sure there is plenty of ventilation. Never operate the engine of the towing vehicle in a closed building. The exhaust fumes may cause asphyxiation.
  
-  Before working on this machine, drive to a level area, disengage the PTO, lower implement (or if working underneath, raise and block securely), shut off the engine, set the brakes, and remove the ignition keys.
  
-  Be certain all moving parts on attachments have come to a complete stop before attempting to perform maintenance.
  
-  Never work under equipment unless it is blocked securely. Never depend on hydraulic system to keep implement in raised position.
  
-  Keep all persons away from operator control area while performing adjustments, service, or maintenance.
  
-  Always use personal protection devices such as eye, hand and hearing protectors, when performing any service or maintenance.
  
-  Frequently check cutter blades. They should be sharp, free of nicks and cracks and securely fastened.
  
-  Periodically tighten all bolts, nuts and screws and check that all cotter pins are properly installed to ensure unit is in a safe condition.
  
-  When completing a maintenance or service function, make sure all safety shields and devices are installed before placing unit in service.
  
-  Remove hydraulic pressure prior to doing any maintenance. Place the cutter wings on the ground or securely blocked up, disengage the PTO, and turn off the engine. Push and pull the remote cylinder lever in and out several times to relieve hydraulic pressure.
  
-  Never use your hands to locate a hydraulic leak on attachments. Use a small piece of cardboard or wood. Hydraulic fluid escaping under pressure can penetrate the skin.
  
-  Openings in the skin and minor cuts are susceptible to infection from hydraulic fluid. If injured by escaping hydraulic fluid, see a doctor at once. Gangrene and death can result. Without immediate medical treatment, serious infection and reactions can occur.

## SAFETY INSTRUCTIONS (continued)



### **MAINTENANCE SAFETY (continued)**



After servicing, be sure all tools, parts and service equipment are removed.



Check to ensure all safety signs are installed and in good condition. (See safety sign section for location drawing.)



Do not allow grease or oil to build up on any deck or platform.



Never replace hex bolts with less than grade five bolts unless otherwise specified, i.e. shear bolts. Refer to bolt torque chart for head identification marking.



Where replacement parts are necessary for periodic maintenance and servicing, genuine factory replacement parts must be used to restore your equipment to original specifications. The manufacturer will not claim responsibility for use of unapproved parts and/or accessories and other damages as a result of their use.



If equipment has been altered in any way from original design, the manufacturer does not accept any liability for injury or warranty.



A fire extinguisher and first aid kit should be kept readily accessible while performing maintenance on this equipment.



### **STORAGE SAFETY**



Following operation, or when unhooking, stop the tractor, set the brakes, disengage the PTO, shut off the engine and remove the ignition keys.



Never unhitch without using the tongue jack. The tongue is very heavy. Attempting to lift the tongue without using the tongue jack could cause strains. Allowing the tongue to fall suddenly and unexpectedly could result in crushing injury. Use the tongue jack for lifting the cutter only. Overloading the jack can cause failure with possible serious bodily injury or even death.



Store the unit in an area away from human activity.



Do not park equipment where it will be exposed to livestock for long periods of time. Damage and livestock injury could result.



Do not permit children to play on or around the stored unit.



Make sure all parked machines are on a hard, level surface and engage all safety devices.



If blocking is used, make sure it is solid and secure before leaving area.



## SAFETY SIGN LOCATIONS

The types of Safety Sign and locations on the equipment are shown in the illustration below. Good safety requires that you familiarize yourself with the various Safety Signs, the type of warning and the area, or particular function related to that area, that requires your SAFETY AWARENESS.

### SAFETY SIGN LOCATIONS

NO.	PART NO.	DESCRIPTION
1	101101	Warning (540 RPM)
2	101103	Danger (Keep Away)
3	M100 (101157)	Warning (Prevent Injury)
4	101100	Danger (Rotating Blades)

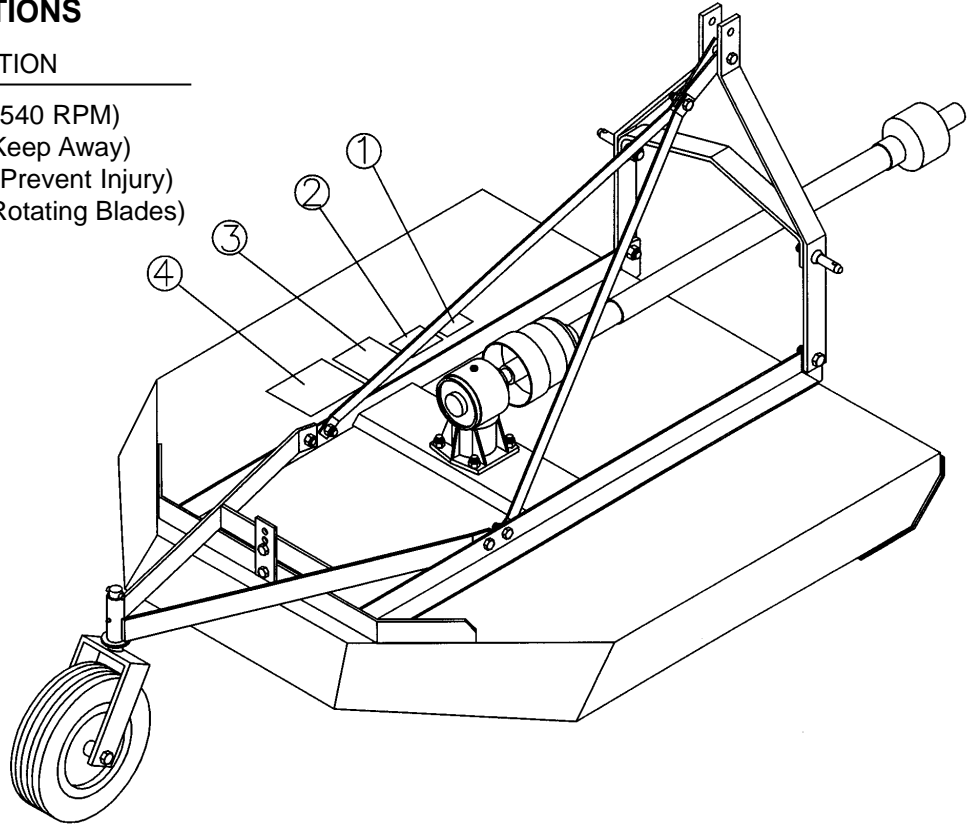

REMEMBER: If Safety Signs have been damaged, removed, become illegible or parts replaced without Signs, new Safety Signs must be applied. New Safety Signs are available from your authorized distributor or factory.





## SAFETY SIGN LOCATIONS (continued)

The types of Safety Sign and locations on the equipment are shown in the illustration below. Good safety requires that you familiarize yourself with the various Safety Signs, the type of warning and the area, or particular function related to that area, that requires your SAFETY AWARENESS.



# WARNING

**To prevent serious injury or death:**  
*Si no lee ingles, pida ayuda a alguien que si lo lea para que le traduzca las medidas de seguridad.*

- Read and understand Operator's Manual before using. Review annually.
- Do not permit riders on the tractor or cutter. Never carry children on tractor seat.
- Do not allow children to operate cutter.
- Operate only with guards installed and in good condition.
- Keep away from moving parts.
- Operate only with tractor equipped with ROPS and seatbelts.
- Before mowing, clear debris from mowing area.
- Do not operate in the raised position.
- Stop engine, set brake and wait for all moving parts to stop before dismounting.
- Support cutter securely before working beneath unit.
- Transport with clean reflectors, SMV and working lights as required by federal, state, and local laws.

M100



# WARNING

**540 RPM SPEED RANGE ONLY**

**HIGHER PTO SPEEDS CAN CAUSE PERSONAL INJURY AND EQUIPMENT FAILURE**

101101



# DANGER



**KEEP AWAY!**

- ENTANGLEMENT WITH ROTATING DRIVE PARTS OR FALLING OFF CAN CAUSE INJURY OR DEATH.
- KEEP ALL DRIVE SHIELDS AND GUARDS IN PLACE AND IN GOOD CONDITION.
- ALLOW NO RIDERS.

101103

REMEMBER: If Safety Signs have been damaged, removed, become illegible or parts replaced without Signs, new Safety Signs must be applied. New Safety Signs are available from your authorized distributor or factory.

# INSTRUCTIONS

## TRACTOR REQUIREMENTS AND PREPARATION

The models SDM40-48, SDM40-60 and SDM40-72 Standard Duty Cutters require a Category I 3-pt. hitch tractor of at least 20 horsepower or up to 50 horsepower and equipped with a 540 rpm PTO (power takeoff) in good working condition.

It is recommended that only tractors with wide front axles be used with this cutter. Tricycle front wheel arrangements are inherently unstable and tractor roll-over accidents are more likely to occur.

The tractor also needs lift arm stabilizer bars or sway blocks to control side movement of the cutter.

Check the tractor's 3-pt. hydraulic lift system. Refer to your tractor operator's manual or dealer for any adjustments necessary to put the hydraulic system in good working order. (I&T shop manuals will list most specifications and adjustment instructions - available from most farm equipment dealers.)

Be sure tires and rims are in good condition. Inflate tires to the proper recommended air pressure.

All tractors that are not equipped with a "live" power takeoff (PTO) need to be equipped with an over-running PTO clutch attachment. A special driveline assembly with an over-running clutch incorporated is available as an option (see optional equipment list).

Check the tractor master shield over the PTO stub shaft. Make sure it is in good condition and fastened securely to the tractor. Purchase a new shield if old shield is damaged or missing. (You may have to use a tractor salvage yard for replacement parts on older tractors.)

It is recommended that a ROPS (Roll-Over Protection Structure) and a seat belt be installed on all tractors. Contact your local dealer for a ROPS for your tractor.

### CAUTION!

Be sure your tractor is in good condition. Read all the safety precautions and make sure all tractor operators are familiar with the safety rules of operation.

The operator is responsible for the safe operation of this cutter. The operator must be properly trained. Operators should be familiar with the cutter and tractor and all safety practices before starting operation. Read the safety rules and safety signs on pages 4-16.

This standard duty cutter is designed for grass and weed mowing and shredding.

Recommended mowing speed for most conditions is from two to five mph.

### WARNING!

When using the unit, a minimum 20% of tractor and equipment weight must be on tractor front wheels. Without this weight, tractor could tip up, causing possible loss of control and possible personal injury or death. The weight may be attained with a front end loader, front wheel weights, ballast in tires or front tractor weights. When attaining a minimum 20% of tractor and equipment weight on the front wheels, you must not exceed the ROPS weight certification. Weigh the tractor and equipment. **DO NOT GUESS OR ESTIMATE!**

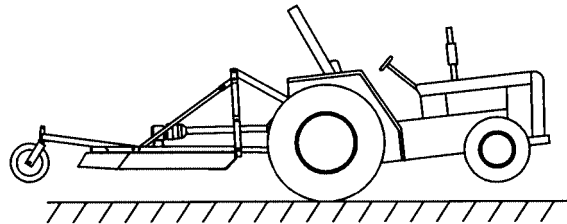

Figure 1. Tractor Stability

### WARNING!

A heavy load can cause instability in driving a tractor. Make sure the front of the tractor is properly counterbalanced with weights. Always drive slowly – especially around turns. An unstable tractor could steer badly and possibly tip over, causing injury or death.

### DANGER!

#### FOR AGRICULTURAL USE ONLY!

When this equipment is operated in populated areas or other areas where thrown objects could injure persons or property, full chain or rubber shielding (which is designed to reduce the possibility of thrown objects) must be installed. If this machine is not equipped with full chain or rubber shielding, operation must be stopped when anyone comes within several hundred feet.



**SAFETY . . .  
YOU CAN LIVE WITH IT!**

## INSTRUCTIONS (continued)

In some cases it will be necessary to shorten the PTO assembly to match your particular tractor. The following procedure should be used:

1. Raise the tractor 3-pt. hitch so the input shaft of the cutter gearbox is in line with the PTO shaft on the tractor. Shut down tractor, leaving cutter in position of shortest distance between shafts. **SECURELY BLOCK CUTTER IN POSITION.**
2. Pull driveline apart. Attach outer (female) section to tractor PTO shaft. Pull on driveline section to be sure that yoke locks into place.
3. Hold driveline sections parallel to each other to determine if too long. Each section should end approximately 3" (76mm) short of reaching universal joint shield on opposite section. If too long, measure 3" (76mm) back from universal joint shield and mark on opposite section (Figure 3). Do this for both sections. **DO NOT CUT UNTIL STEPS 4 AND 5 ARE CHECKED.**

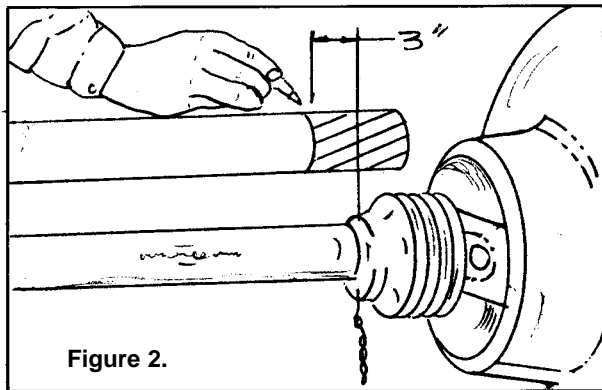

**NOTE:** The use of a PTO over-running clutch or extension could require that the PTO driveline be shortened a considerable amount. If this is done, the driveline halves may separate when the cutter is lowered to the ground or when operated on rough ground.

An optional special driveline that is equipped with an over-running clutch is recommended (see optional equipment).

1. Raise and lower the cutter to determine position with greatest distance between the PTO shaft and gearbox input shaft. Shut tractor off, leaving cutter in position of greatest distance between shafts. **SECURELY BLOCK CUTTER IN POSITION.**
2. Hold driveline sections parallel to each other and check for **minimum 6" (15cm) overlap**. If driveline has been marked for cutting, overlap will be the distance between the two marks. If driveline has less than minimum overlap, do not use. Contact authorized dealer.

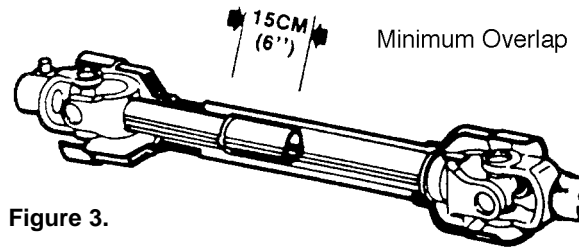

3. If driveline must be cut to a shorter length, clamp driveline in a well padded vise to prevent damage to the shield. Cut off shield where marked. Using cut-off section of shield as a guide, cut shaft the same amount. (Figure 4.)
4. Repeat the procedure to the other driveline half. Remove all burrs and cuttings.
5. Apply multi-purpose grease to inside of outer (female) driveline section. Assemble driveline and install on tractor and cutter. Pull on each driveline section to be sure yokes lock into place. Make certain driveline shielding is in place and in good condition.

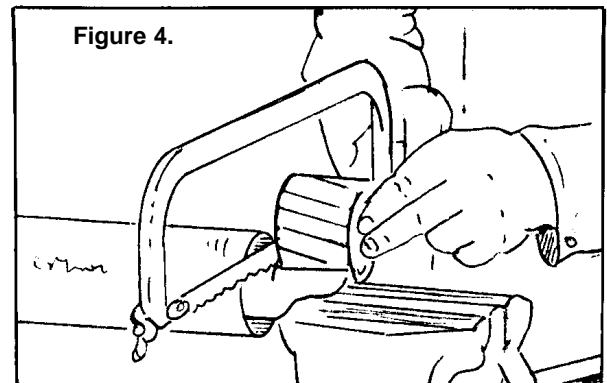

**When attaching PTO yoke to tractor PTO shaft, it is important that spring-activated locking pin or balls operate freely and are seated in groove on PTO shaft. A loose shaft could slip off and result in personal injury or damage to equipment.**

6. Carefully raise and lower the cutter and check to be sure the PTO assembly does not jam. If it does, cut equal amounts from each half of the PTO assembly.

## INSTRUCTIONS (continued)

Adjust the tailwheel and lift arms so the cutter is level. Then raise the tractor lift very slowly, making sure that the front drive shaft shield does not hit the front of the cutter. If it does, damage will be done to the drive shaft shield and, if interference is bad enough, it WILL also damage the drive shaft itself.

**NOTE:** This type of damage is **NOT** covered under warranty, as it is totally under the control and the responsibility of the operator.

Use the lift control limiting stop on the tractor control lever to limit the upward travel of the lever so the lift cannot be raised high enough to cause contact between the drive shaft shield and front shielding.

7. Check the swinging drawbar of the tractor and make sure the PTO driveline assembly will not contact. The swinging drawbar can be moved forward on some tractors or it can be removed.

If the PTO driveline assembly contacts the swinging drawbar, damage will occur to the driveshaft shield and possibly the driveshaft itself. (**NOT** covered under warranty.)

## ATTACHMENT

The cutter is shipped partially assembled. Assembly will be easier if components are aligned and loosely assembled before tightening hardware. Recommended torque values for hardware are located on page 26.

Select a suitable working area. Refer to illustrations, accompanying text, parts lists and exploded view drawings.

Complete check lists on page 20 when assembly is complete.

Position cutter flat and cut the nylon straps that are holding all loose parts to the cutter.

Rotate the "A" frame hitch forward and connect lift arms and toplink.

Attach the two linkage lift straps to the cutter deck (behind the gearbox) and to the end of the slack link on the "A" frame. These bolted connections are moveable joints – so tighten nylock nuts only until excess looseness is gone.

**Most swinging drawbars will have to be moved to a forward position or removed.** Check the tractor swinging drawbar for interference with the front of the cutter before attempting to lift the cutter with the 3-pt. hitch.

Tractor lift arm stabilizer bars or sway blocks must be used to control side movement of the cutter. **DO NOT CONNECT THE PTO DRIVELINE AT THIS TIME.**

Check your lift arm hydraulic controls. Be sure the hydraulic 3-pt. hitch control is in the float position and the draft control is turned off.

Adjust lower lift arm(s) to level cutter right to left. Refer to tractor operator's manual for instructions.

Cutting height is controlled with tractor 3-point arms, and rear tailwheel adjustment.

## PTO DRIVELINE INSTALLATION

Spray WD-40 into the yoke and wipe. This should remove some of the paint and make it easier to slide the yoke onto the input shaft of the gearbox.

Remove shearbolt and retaining ring (4) from gearbox input shaft (3).

**Grease the input shaft** of the gearbox before installing the PTO shaft. This reduces the chance of the PTO shaft yoke from galling to the input shaft if the shear pin should break.

Remove rear drive shield (1) from driveline. To remove, turn each plastic clip  $\frac{1}{4}$  turn and then lift out. Then slide rear shield so entire joint assembly is exposed. (Refer to figure 5.)

To prevent seal damage, carefully push driveline onto gearbox input shaft until it contacts gearbox housing.

Install retaining ring (4) and then pull driveline ahead.

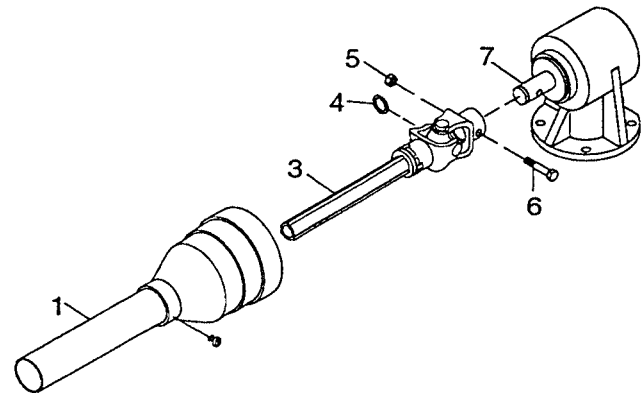

1. Drive shield
3. Input driveline shaft half
4. Retaining ring
5. Nut
6. Shearbolt grade 2  $\frac{1}{2}$  – 13 NC x 3" long
7. Gearbox

Figure 5. Shear Bolt Driveline Installation

**NOTE: A grade 2 bolt must be used for the shear bolt to provide gearbox protection.**

Align the holes in the driveline yoke and gearbox input shaft and install and tighten shear bolt (6) and nut (5).

Install rear drive shield to driveline.

Lubricate rear driveline half and install front driveline half.

# OPERATING INSTRUCTIONS

## GEARBOX OIL FILL

NOTE: The gearbox is shipped WITHOUT lubricant, so it will be necessary to fill it before use. With the gearbox in a level position, fill to the side inspection hole with a good 90 wt. gear lubricant. Check often and add lubricant if necessary.

## GENERAL SAFETY

Only qualified people familiar with this manual should operate this machine. Operator should wear hard hat, safety glasses, and safety shoes. It is recommended that tractor be equipped with Roll-Over Protective System (ROPS) and a seat belt be used. Before beginning operation, clear work area of objects that may be picked up and thrown. Check for ditches, stumps, holes, or other obstacles that could upset tractor or damage cutter. Always turn off tractor engine, set parking brake, lower cutter to ground and allow cutter blades to come to a complete stop before dismounting tractor.

Safety is a primary concern in the design and manufacture of our products. Unfortunately, our efforts to provide safe equipment can be wiped out by a single careless act of an operator.

It has been said, "The best safety device is an informed, careful operator". We ask you to be that kind of an operator.

The designed and tested safety of this machine depends on it being operated within the limitations as explained in this manual. Be familiar with and follow all safety rules in the manual, on the cutter and on the tractor.

The safe operation of this machine is the responsibility of the owner/operator. The operator should be familiar with the cutter and tractor and all safety practices before starting operation. Read the safety rules on pages 4 thru 14.



**Do not operate the PTO at other than the rated 540 RPM. Excessive speeds can cause breakage, thrown objects, and potential injury.**

## ADJUSTING FOR WORK

The cutter should be operated at the highest position which will give desired cutting results. This will help prevent the blades from striking the ground, reducing blade wear and undue strain on the machine. For best results

always tilt the cutter slightly lower in the front. This tilt decreases horsepower requirements. When fine shredding is desired, adjust cutter deck level or slightly lower. This will keep the foliage under cutter until thoroughly shredded. More power is required for shredding.

The cutting height is adjustable from 1 - 5 inches. To adjust, proceed as follows:

- A. Raise cutter off ground using tractor 3-point lift. Turn off tractor engine, disengage PTO, set parking brake, and remove key from ignition.
- B. SECURELY BLOCK CUTTER.
- C. Remove bolt securing tailwheel to adjusting strap.
- D. Adjust tailwheel to desired position. Secure with bolt, lockwasher and nut.
- E. Lower cutter to work position.
- F. Adjust tractor 3-point hitch top link so linkage lift straps have a small amount of slack to allow cutter deck to float during operation.

## PRE-OPERATION CHECKLIST

### (OWNER RESPONSIBILITY)

- \_\_\_\_\_ Review and follow safety rules and safety signs on pages 4 through 16.
- \_\_\_\_\_ Check that cutter is properly and securely attached to tractor.
- \_\_\_\_\_ Make sure driveline spring-activated locking pin or locking balls operate freely and are seated firmly in tractor PTO spline groove.
- \_\_\_\_\_ Lubricate all grease fitting locations. Make sure PTO shaft slip joint is lubricated.
- \_\_\_\_\_ Check to be sure gear lube runs out the small check plug on side of gearbox.
- \_\_\_\_\_ Check that all hardware is properly installed.
- \_\_\_\_\_ Check to ensure blades are sharp and secure and cutting edge is positioned to lead in a counter-clockwise rotation.
- \_\_\_\_\_ Check that all shields and guards are properly installed and in good condition.
- \_\_\_\_\_ Check cutting height, front to rear attitude and top link adjustment.
- \_\_\_\_\_ Place tractor PTO and transmission in neutral before starting engine.
- \_\_\_\_\_ Set tractor PTO gear select lever for 540 rpm operation.
- \_\_\_\_\_ Inspect area to be cut and remove stones, branches or other hard objects that might be thrown, causing injury or damage.

# OPERATION INSTRUCTIONS (continued)

## IMPORTANT

**Vibration tends to loosen bolts during operation. All hardware should be checked regularly to maintain proper torque. It is a good practice to check cutter before each operation to ensure all hardware is secure.**

## OPERATING TECHNIQUE

---

Power for operating cutter is supplied by tractor PTO. Operate PTO only at 540 rpm gear range. Know how to stop tractor and cutter quickly in case of an emergency.

Engage PTO at a low engine rpm to minimize stress on the drive system and gearbox. Place tractor in gear and proceed forward. Advance tractor throttle to 540 PTO RPM. Tractor forward speed should be controlled by gear selection, not engine speed. For maximum cutting efficiency, forward speed should allow cutter to maintain a constant, maximum blade speed. If cutter stalls or tractor engine bogs, disengage PTO. Before re-engaging PTO, position cutter in a cut area and reduce tractor throttle to idle. If cutter continuously stalls, select lower tractor gear and/or increase cutting height.

Blade rotation is counterclockwise causing cut material to discharge to the left side of cutter forming a windrow. To shred and dissipate this windrow, tractor should be driven in a counterclockwise direction throwing material to the uncut area. The windrowed material will be recut on each new pass. Tractor tire tracks are cut more efficiently when tractor is traveling in a clockwise direction especially when cutting height is high. Larger brush should be cut in the center of cutter. Always cut up and down the face of slopes, never across.

Gearbox protection is provided by a shearbolt. The shearbolt will shear when excessive torsional loads are encountered.

Proper ground speed will depend upon the terrain, the height, type and density of material to be cut.

Normally, ground speed will range from two to five mph. Tall dense material should be cut at a low speed; thin medium-height material can be cut at a faster ground speed.

When engaging the PTO, the engine speed should always be low. Once the PTO is engaged and ready to start cutting, raise the PTO speed to 540 RPM and maintain throughout mowing operation. **ALWAYS** operate the PTO at 540 RPM. This is necessary to maintain proper blade speed to obtain a clean cut.

Under certain conditions, tractor tires may roll some grass down and prevent it from being cut at the same height as the surrounding area. When this occurs, reduce your ground speed, but maintain PTO at 540 rpm. The lower ground speed will permit grass to at least partially rebound.

Under some conditions, grass will not rebound enough to be cut evenly. In general, lower cutting heights give a more even cut with less tendency to leave tire tracks. However, it is better to cut grass frequently rather than too short. Short grass deteriorates rapidly in hot weather and invites weed growth during growing seasons. Follow local recommendations for the suitable cutting height in your area.

## OPERATING TIPS

---

### SHREDDING

For shredding, it is better to set the cutter lower at the rear. How much lower depends on the material to be shredded. Determine the best setting for your situation by experimenting.



**Inspect area to be cut and remove stones, branches, or other hard objects that might be thrown, causing injury or damage.**

Extremely tall material should be cut twice. Set cutter at a higher cutting height for the first pass. Then cut at desired height at 90° to the first pass.

Remember, sharp blades produce cleaner cuts and require less power.

Analyze area to be cut to determine the best procedure. Consider height and type of grass and terrain type; hilly, level or rough.

Plan your mowing pattern to travel straight forward whenever possible. Mow clockwise around fields when necessary to minimize streaking on corners.

### UNEVEN TERRAIN



**Do not operate on steep slopes.**

**Do not stop, start or change directions suddenly on slopes.**

**Use extreme care and reduce ground speed on slopes and rough terrain.**

**Watch for hidden hazards on the terrain during operation.**

Pass diagonally through sharp dips and avoid sharp drops to prevent "hanging up" tractor and cutter.

Practice will improve your skills in maneuvering rough terrain.

# OPERATION INSTRUCTIONS (continued)

## BLADES

---

The blades will last a long time cutting grass, but will wear rapidly when contacting the ground. If they are clipping into the ground, they will have to be sharpened frequently.

The cutting action of the blade will be much cleaner, create less shock loads and require less power if the blades are kept quite sharp. That is with a flat or blunt edge that is not over 1/32" thick. Putting a knife-sharp edge (where both sides come to a sharp point) on the blades will not help, as a sharp edge will round off very quickly and doing so will only reduce the total life of the blades.

## TRANSPORTING

---

Pay particular close attention to the Safety Messages regarding cutter transport. Avoid unnecessary injuries and equipment damage by exercising cautious, conscientious travel procedures.

Attaching the cutter to the tractor increases the overall length of the working unit. Allow additional clearance for the cutter to swing when turning.

Raise the cutter as high as possible for transporting, while maintaining clearance between the driveline and deck of the 3-point lift cutter.

**DO NOT OPERATE PTO DURING TRANSPORT.**

## REMOVING CUTTER FROM TRACTOR

---

Disengage tractor PTO.

Disconnect driveline from tractor PTO.

Collapse driveline as far as possible and store it to prevent ground contact. Place blocks under cutter side skids. Lower cutter onto blocks, disconnect cutter from tractor 3-point hitch, and carefully drive tractor away from cutter.

**OBEY SAFETY  
RULES!!  
ALWAYS BE  
CAREFUL!!**

## OPTIONS

---



When this machine is operated in populated areas, along roads, or in other areas where thrown objects could injure persons or property, standard equipment safety chain shielding (which is designed to reduce the possibility of thrown objects) must be installed.

Chain guards are not mandatory for agricultural use only (i.e. - out in fields where people, livestock, or property that could be damaged are not present). If this machine is not equipped with chain shielding, operation must be stopped when anyone comes within several hundred feet.

For four (4) foot cutter – Model No. SDM40-48  
order No. 650575 front chain kit (4')

For five (5) foot cutter – Model No. SDM40-60  
order No. 650375 front chain kit (5')

For six (6) foot cutter – Model No. SDM40-72  
order No. 650620 front chain kit (6')



All tractors that are not equipped with a "live" power takeoff (PTO) need to be equipped with an over-running PTO clutch driveline.

Use of a standard PTO driveline that does not have an over-running clutch on these tractors, will allow the cutter blade assembly to act as a flywheel. This can cause damage to the tractor's internal PTO drive train and can make stopping the tractor's forward travel difficult.

For five (5) foot cutter – Model No. SDM40-60  
order No. 650380 driveline assembly for five (5)  
foot cutter with over-running clutch.

For six (6) foot cutter – Model No. SDM40-72  
order No. 650625 driveline assembly for six (6)  
foot cutter with over-running clutch.



There are PTO over-running clutch attachments available. However, they will increase the length of the driveline and may cause the front knuckle joint to operate beyond the cover of the tractor master PTO shield. This is NOT recommended and a dangerous operating condition will be present.

# OWNER SERVICE

The information in this section is written for operators who possess basic mechanical skills. Should you need help, your dealer has trained service technicians available. For your protection, read and follow all safety information in this manual.

## WARNING!

- ▲ Lower cutter to ground or block securely, turn tractor engine off, remove key and disconnect cutter driveline from tractor PTO before performing any service or maintenance.
- ▲ Before working underneath, raise 3-pt. hitch to highest position and block cutter securely. Hydraulic system leakdown and failure of mechanical or hydraulic system can cause equipment to drop.
- ▲ Keep all persons away from operator control area while performing adjustments, service or maintenance.

## ROUTINE MAINTENANCE

### DAILY CHECKS:

1. Check that all bolts, nuts, and screws are tight. Checking the bolts and nuts on the blade beam assembly is particularly important.
2. Check daily the level of the gearbox oil and top up to the correct level. Check for gearbox oil leaks. It should be noted that no warranty claim can be submitted on a gearbox that has run dry. It is essential that the gearbox is kept correctly filled with gearbox oil.
3. Grease the PTO shaft daily.
4. Check the wear on the blades. Sharpen them routinely with an angle grinder or replace when worn down too far. You should keep at least two sets of blades, bolts, and nuts as spares for your cutter.

### AT THE END OF YOUR CUTTING SEASON:

1. Drain and change the oil in your gearbox.
2. Check and replace, where necessary, blades, bolts, nuts, or bushings, on the machine.
3. Clean machine and touch up any rust spots that may have appeared.
4. Replace any safety signs if damaged.
5. Store cutter in clean, dry location.

## LUBRICATION INFORMATION

Figure 6 shows the lubrication points. The accompanying chart gives the frequency of lubrication in operating hours, based on normal conditions. Severe or unusual conditions may require more frequent lubrication.

Do not let excess grease collect on or around parts, particularly when operating in sandy areas.

Use an SAE 90W gear lube in gearbox.

Use a lithium grease of NO. 2 consistency with a MOLY (molybdenum disulfide) additive for all locations. Be sure to clean fittings thoroughly before attaching grease gun. When applied according to the lubrication chart, one good pump of most guns is sufficient. Do not over grease.

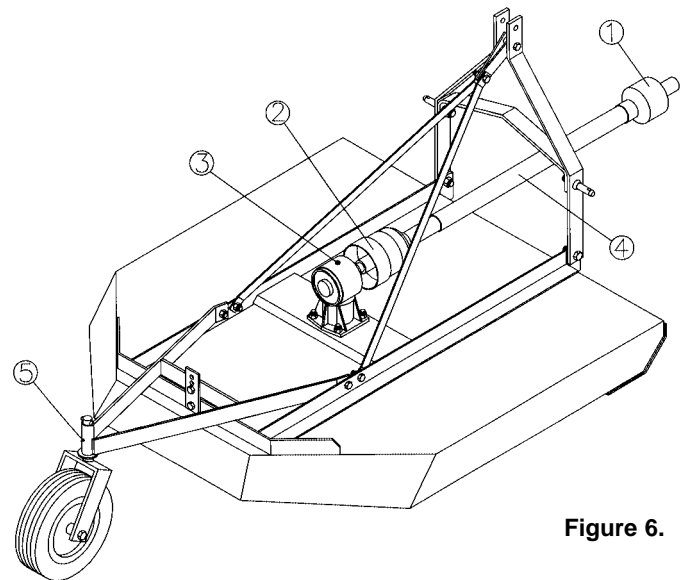

Figure 6.

### LUBRICATION CHART

REF NO.	DESCRIPTION	FREQUENCY
1	Front U-Joint	8 Hrs.
2	Rear U-Joint	8 Hrs.
3	Gearbox – Fill to proper level	Check Daily
4	Slip Joint	8 Hrs.
5	Tailwheel	8 Hrs.

Daily lubrication of the PTO slip joint is necessary. Failure to maintain proper lubrication can result in damage to U-joints, gearbox, tractor PTO and/or cutter driveline.

**ALWAYS OBEY ALL  
SAFETY WARNINGS!!**



BLADE SERVICING

**BLADE REMOVAL (Figure 7)**

- 1. Jam nut
- 2. Lockwasher
- 3. Blade beam
- 4. Blade
- 5. Blade bolt

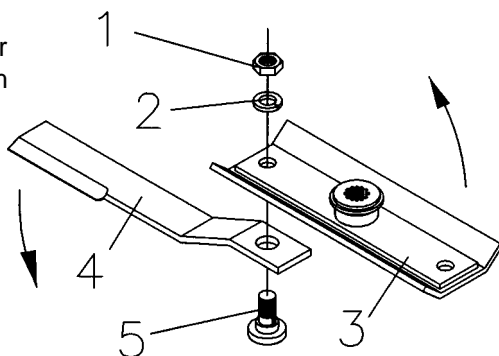

Figure 7. Blade Installation

Disconnect driveline from tractor PTO. It is necessary to gain access to bottom side of cutter for blade removal. Raise cutter and block securely. Align crossbar (3) with blade access hole in the cutter deck. Remove nut (1) and lockwasher (2) then carefully drive bolt (5) out of crossbar.

**IMPORTANT**

If blade bolt (5) is seized in blade beam and extreme force will be required to remove it, support blade beam from below to prevent gearbox damage.

Rotate blade beam (3) and repeat for opposite blade. Always replace or sharpen both blades at the same time. Inspect blade bolt (5) for nicks or gouges; replace if any are found. Insert bolt through blade. Blade should swivel on bolt. Determine cause if it does not and correct. Align blade beam (3) with blade access hole in the cutter frame. Apply a liberal coating of Never Seez® or equivalent to blade bolt and blade beam hole. Make sure blade is offset away from cutter.

**IMPORTANT**

Blade beam rotation is counter-clockwise when looking down on cutter. Be sure to install blade cutting edge to lead in counter-clockwise rotation.

Never Seez is a registered trademark of the Never Seez Corporation.

Insert blade bolt (5) through blade, align key on blade bolt with keyway in blade beam and push blade bolt through blade beam. Insert lockwasher (2) and nut (1) through blade access hole in the cutter deck, install on bolt (5) and tighten to 350 lbs.-ft. Repeat for opposite blade.

**BLADE SHARPENING**

**IMPORTANT**

When sharpening blades, grind each blade the same amount to maintain balance. Replace blades in pairs. Unbalanced blades will cause excessive vibration which can damage gearbox bearings. Vibration may also cause structural cracks to cutter.

Sharpen both blades at the same time to maintain balance. Follow original sharpening pattern. Do not sharpen blade to a razor edge, but leave at least a 1/16" blunt edge. Do not sharpen back side of blade.

**SHEAR BOLT REPLACEMENT**

**IMPORTANT**

Always use approved 1/2" NC x 3" grade 2 shear bolt as a replacement part. Using a hardened bolt or shear pin may result in damage to driveline or gearbox.

Remove driveline shield bell. (Refer to page 19 for instructions.) Make sure the input shaft of the gearbox is greased. This reduces the chance of the PTO shaft yoke from galling to the input gearbox shaft if the shear bolt should break. Rotate driveline to align holes in yoke and shaft. Install shear bolt and secure with locknut. Replace driveline shield bell.



**FAILURE TO USE CORRECT SIZE SHEAR BOLT MAY CAUSE PERSONAL INJURY OR DEATH.**



**FAILURE TO INSTALL RETAINING CLIP WILL ALLOW DRIVELINE TO SWING FREELY IF BOLT IS SHEARED CAUSING POSSIBLE INJURY OR DEATH.**

## OWNER SERVICE (continued)

### REPAIR OF OPTIONAL CHAIN SHIELDING

---

Inspect chain shielding each day of operation and replace any broken or missing chains as required.

### BLADE BEAM & GEARBOX REMOVAL

---

- A. Raise cutter using tractor 3-point lift. Turn off tractor engine.
- B. BLOCK CUTTER SECURELY INTO POSITION.



**DO NOT GET UNDER CUTTER UNLESS IT IS SECURELY BLOCKED IN POSITION. ACCIDENTAL FALL COULD CAUSE SERIOUS INJURY OR DEATH.**

- C. Remove cotter pin and blade holder retaining nut. Wear heavy work gloves to protect hands from sharp edges.
- D. Grasp blade holder and pull off shaft. If necessary, align blade bar with access hole in top of deck and drive off with hammer and pipe. Care should be taken not to damage threads on blade bolt.
- E. Press all three tabs and slide yoke shield back.
- F. Remove shear bolt and retaining clip. Slide yoke off gearbox input shaft.
- G. Remove nuts securing gearbox to deck. Remove gearbox.

### BLADE BEAM & GEARBOX INSTALLATION

---

- A. Raise cutter using tractor 3-point lift. Turn off tractor engine.
- B. BLOCK CUTTER SECURELY INTO POSITION.



**DO NOT GET UNDER CUTTER UNLESS IT IS SECURELY BLOCKED IN POSITION. ACCIDENTAL FALL COULD CAUSE SERIOUS INJURY OR DEATH.**

- C. Attach gearbox to cutter deck using bolts and nuts.
- D. Install blade holder onto gearbox securing with castellated nut and flat washer. Torque nut to 350 ft./lbs. Wear heavy work gloves to protect hands from sharp edges.
- E. Install cotter pin to retain nut. It may be necessary to slightly loosen nut to install cotter pin.
- F. Slide driveline yoke onto gearbox input shaft. Install retaining clip and shear bolt.



**FAILURE TO INSTALL RETAINING CLIP WILL ALLOW DRIVELINE TO SWING FREELY IF BOLT IS SHEARED CAUSING POSSIBLE INJURY OR DEATH.**







- G. Lock driveline yoke shield securely into place.
- H. Fill gearbox with oil to proper level.

- U Keep children away from danger all day, every day.
- U Equip tractors with roll-over protection (ROPS) and keep all machinery guards in place.
- U Please work, drive, play, and live each day with care and concern for your safety and that of your family and fellow citizens.

# PROPER TORQUE FOR FASTENERS

The charts below list the correct tightening torque for fasteners. When bolts are to be tightened or replaced, refer to the charts to determine the grade of bolt and the proper torque.

## BOLT CLASSIFICATION AND IDENTIFICATION CHART

INCH		METRIC	
SAE GRADE	BOLT HEAD MARKINGS	CLASS	BOLT HEAD MARKINGS
2		5.8	
5		8.8	
8		10.9	

Recommended torque for all Standard Unplated Nuts and Bolts, provided:

- A. Surface finish is oxide coated, oil quenched or bright.
- B. All thread surfaces are clean and lubricated with SAE-30 engine oil or equivalent.
- C. Joints are rigid. That is, no gaskets or compressible materials are used.
- D. When re-using nuts or bolts, use minimum torque values.

**NOTE:** Multiply the standard torque by:

- .65 when finished jam nuts are used.
- .70 when Molykote, white lead or similar mixtures are used as lubricants.
- .75 when phosphate coated and oiled bolts or nuts are used.
- .85 when cadmium or zinc dichromate bolts or nuts are used.
- .90 when hardened surfaces are used under the nut or bolt head (this applies to standard unplated hardware only).



## STANDARD TORQUE DATA FOR INCH NUTS AND BOLTS (Foot Pounds)

RECOMMENDED TORQUE IN FOOT POUNDS

Bolt Diameter	SAE Grade 2	SAE Grade 5	SAE Grade 8
1/4"	6	11	14
5/16"	13	21	25
3/8"	23	38	55
7/16"	37	55	80
1/2"	57	85	120
9/16"	82	125	180
5/8"	111	175	230
3/4"	200	300	440

## STANDARD TORQUE DATA FOR METRIC NUTS AND BOLTS (Foot Pounds)

RECOMMENDED TORQUE IN FOOT POUNDS

Bolt Diameter	 Class 5.8		 Class 8.8		 Class 10.9	
	Min.	Max.	Min.	Max.	Min.	Max.
6	5	6	8	9	11	13
7	9	10	14	15	19	21
8	13	14	20	23	28	31
10	25	28	40	45	54	61
12	43	49	70	78	95	106
14	70	78	111	125	151	170
16	108	121	172	194	233	263
18	149	168	238	268	324	364
20	210	237	336	378	458	515
22	287	323	458	616	624	702
24	363	409	581	654	791	890

# TROUBLESHOOTING GUIDE

PROBLEM	POSSIBLE CAUSE	POSSIBLE REMEDY
<b>Leaves a streak of uncut or partially cut grass.</b>	1. Cutter not level side to side.	Level 3 pt. hitch linkage on tractor.
	2. Blades dull or bent.	Sharpen or replace blades.
	3. Carrier RPM too low.	Use correct PTO speed.
	4. Field conditions are so wet that the tractor tire is pushing grass into mud.	Too wet to mow. Stop operation and wait until it is drier.
	5. Ground speed too fast.	Reduce ground speed by shifting to a lower gear.
	6. Blades locked back.	Free blades.
	7. Blades riding up due to blade bolt wear or loose bolts.	Replace blade bolts.
	8. Grass is down from previous weather conditions.	Mow in only one direction.
	9. Possible build up of material under cutter.	Clean cutter.
	10. Weed and grass stems are pushed down by tractor tires and do not rebound up so they can be cut (this can happen when weed/grass is high).	Mow again in opposite direction.  Mow back and forth with enough overlap to mow tire track of previous cut again.  Offset cutter to left 4-6" by adjusting stabilizer bars. Then mow in counter clockwise direction (rotation direction of blades will help cut stems pushed forward).
<b>Grass cut lower in center of swath than at edge.</b>	Height of cutter lower at rear or front.	Adjust cutter height and attitude so that cutter rear and front are within 1/2" of same height. See instructions.
<b>Material discharges from cutter unevenly; bunches of material along swath.</b>	1. Material too high and too much material.	Reduce ground speed but maintain 540 rpm at tractor PTO, or make two passes over material. Raise cutter for the first pass and lower to desired height for the second and cut a 90° to first pass. Raise rear to cutter high enough to permit material to discharge, but not so high that conditions listed above occur.

# TROUBLESHOOTING GUIDE

PROBLEM	POSSIBLE CAUSE	POSSIBLE REMEDY
<b>Material discharges from cutter unevenly; bunches of material along swath. (Continued)</b>	2. Grass wet.	Allow grass to dry before mowing. Slow ground speed of tractor but keep engine running at full PTO rpm. Cutting lower will help.
	3. Rear of cutter too low, trapping material under cutter.	Adjust cutter height and attitude. (See instructions.)
<b>Gearbox overheating.</b>	1. Low on lubricant.	Fill to proper level.
	2. Improper type lubricant.	Replace with proper lubricant.
	3. Excessive trash build-up around gearbox.	Remove trash.
<b>Blade is scalping ground.</b>	1. Cutter too low.	Raise cutter - reset tailwheel and 3-pt. control stop.
	2. Field is ridged.	Cut field at a different angle.
	3. Field is too wet.	Stop and wait until it is drier.
<b>Cutter will not cut. (Shear bolt drive only)</b>	1. Shear bolt sheared.	Install new shear bolt.
	2. Tractor PTO not engaged.	Engage PTO.
	3. Tractor PTO clutch slipping.	Rebuild/replace clutch.
<b>Cutter moves from side to side when cutting.</b>	Loose tractor sway chains or bars, or sway blocks improperly installed.	Adjust sway chains, bars, or sway blocks.
<b>PTO contacts cutter front frame when raised.</b>	Raising cutter too high or incorrect adjustment of tractor top link.	Adjust top link or tractor lift stops. (See attachment instructions.)
<b>Blade bolts come loose.</b>	1. Bolts not tightened.	Tighten bolts to 350 ft./lb.
	2. Bolt hole elongated or oversized.	Replace blade carrier.
	3. Blade bolt threads are worn or damaged.	Replace blade bolt, lockwasher, and nut.

# TROUBLESHOOTING GUIDE

PROBLEM	POSSIBLE CAUSE	POSSIBLE REMEDY
<b>Blade wears too fast.</b>	1. Cutting in sandy conditions.	Increase cutting height.
	2. Cutting in rocky conditions.	Increase cutting height.
	3. Blades hitting ground.	Increase cutting height.
<b>Cutter seems to require excessive power.</b>	1. Advancing into grass or brush too rapidly.	Reduce forward travel speed.
	2. Hitting ground.	Raise cutter and reset skids.
	3. Worn or dull blades.	Sharpen or replace blades.
	4. Tractor not large enough.	Use larger horsepower tractor.
	5. Grass too tall and heavy.	Make two passes. Raise cutter for first pass and lower for next pass.
<b>Excessive vibration.</b>	1. Check gearbox bolts.	Tighten if loose.
	2. Check for loose nuts on bladeholder and blades.	Tighten if loose.
	3. Check for bent output shaft. If shaft is bent, oil will normally leak from bottom seal.	Replace shaft if bent.
	4. Check to see if blades are free-swinging.	Free blades so they swing.
	5. Check for <b>even</b> wear on each blade tip. Were both blades changed at the same time?	Weigh blades. Weight should be within 1 oz. Always replace both blades
	6. Blade broken.	Replace blades, in sets.
	7. Blade beam bent.	Replace blade beam.
	8. New blade or bolts matched with worn blade or bolts.	Replace blades or bolts in sets.
	9. Drivelines not phased correctly. Implement and tractor yokes must be in line.	Replace driveline.
	10. Wire or rope wrapped around blade beam.	Remove wire or rope.
	11. Blades worn and are out of balance.	Replace blades, in sets.

# TROUBLESHOOTING GUIDE

PROBLEM	POSSIBLE CAUSE	POSSIBLE REMEDY
<b>Gearbox noisy.</b>	1. Rough gears.	Run in or change gears.
	2. Worn bearings.	Replace bearing.
	3. Low oil in gearbox.	Check level and add oil.
	4. Improper gearbox lubricant.	Replace with proper lubricant.
<b>Gearbox leaking.</b>	1. Damaged oil seal.	Replace seal.
	2. Bent shaft.	Replace oil seal and shaft.
	3. Shaft rough in oil seal area.	Replace or repair shaft.
	4. Oil seal installed wrong.	Replace seal.
	5. Oil seal not sealing in the housing.	Replace seal or use a sealant on outside diameter of seal.
	6. Oil level too high.	Drain oil to proper level.
	7. Hole in gearbox.	Replace gearbox.
	8. Gasket damaged.	Replace gasket.
	9. Bolts loose.	Tighten bolts.
<b>Excessive wear of tailwheel tire.</b>	1. Tire not turning properly.	Check wheel assembly for proper lubrication. Axle bolt could be too tight.
	2. Tailwheel not castering properly.	Check tailwheel yoke assembly for proper lubrication or for mechanical binding.
<b>Front hitch "A" frame bending sideways.</b>	1. Operator turning sharply hitting objects with tailwheel frame or cutter deck.	Drive carefully and plan turns to avoid hitting buildings, posts, trees, etc.
	2. Tailwheel not castering properly.	Check tailwheel yoke (see above under tire wear).
	3. Cutter is being operated to low and cutter deck is contacting ground during turns.	A. Raise cutter (especially on rough ground). B. Set stop on hitch controls lever so hitch lift arms do not drop cutter on ground.
	4. Tractor 3 pt. hitch is leaking down and cutter deck is contacting ground.	A. Repair tractor hitch hydraulic system. B. Use limit chains to keep lift arms from going lower than set limit.

# LIMITED WARRANTY



Worksaver warrants to the original purchaser of any new Rotary Cutter (Models SDM40-48, SDM40-60 and SDM40-72), that the equipment be free from defects in material and workmanship for a period of one (1) year for non-commercial, state, and municipalities' use ninety (90) days for commercial use from date of retail sale.

Replacement or repair parts installed in the equipment covered by this warranty are warranted for ninety (90) days from the date of purchase of such part or to the expiration of the applicable new equipment warranty period, whichever occurs later.

Such parts shall be provided at no cost to the user during regular working hours. Worksaver reserves the right to inspect any equipment or parts which are claimed to have been defective in material or workmanship.

## DISCLAIMER OF IMPLIED WARRANTIES & CONSEQUENTIAL DAMAGES

Worksaver's obligation under this warranty, to the extent allowed by law, is in lieu of all warranties, implied or expressed, including implied warranties of merchantability and fitness for a particular purpose and any liability for incidental and consequential damages with respect to the sale or use of the items warranted. Such incidental and consequential damages shall include but not be limited to: transportation charges other than normal freight charges; cost of installation other than cost approved by Worksaver; duty; taxes; charges for normal service or adjustments; loss of crops or any other loss of income; rental of substitute equipment, expenses due to loss, damage, detention or delay in the delivery of equipment or parts resulting from acts beyond the control of Worksaver.

## THIS WARRANTY SHALL NOT APPLY:

1. To vendor items which carry their own warranties, such as hydraulic cylinders, tires, and tubes.
2. If the unit has been subjected to misapplication, abuse, misuse, negligence, fire or other accident.
3. If parts not made or supplied by Worksaver have been used in connection with the unit, if, in sole judgement of Worksaver such use affects its performance, stability, or reliability.
4. If the unit has been altered or repaired outside of an authorized Worksaver dealership in a manner which, in the sole judgement of Worksaver affects its performance, stability or reliability.
5. To normal maintenance service and normal replacement items such as gearbox lubricant, hydraulic fluid, worn blades, or to normal deterioration of such things as belts and exterior finish, due to use or exposure.
6. To expendable or wear items such as teeth, chains, sprockets, belts, springs and other items that in the company's sole judgement is a wear item.

NO EMPLOYEE OR REPRESENTATIVE OF WORKSAVER IS AUTHORIZED TO CHANGE THIS WARRANTY IN ANY WAY OR GRANT ANY OTHER WARRANTY UNLESS SUCH CHANGE IS MADE IN WRITING AND SIGNED BY WORKSAVER'S SERVICE MANAGER, POST OFFICE BOX 100, LITCHFIELD, ILLINOIS 62056-0100.





PTO SHAFT (SHEAR BOLT PROTECTED)  
PARTS VIEW & PARTS LIST

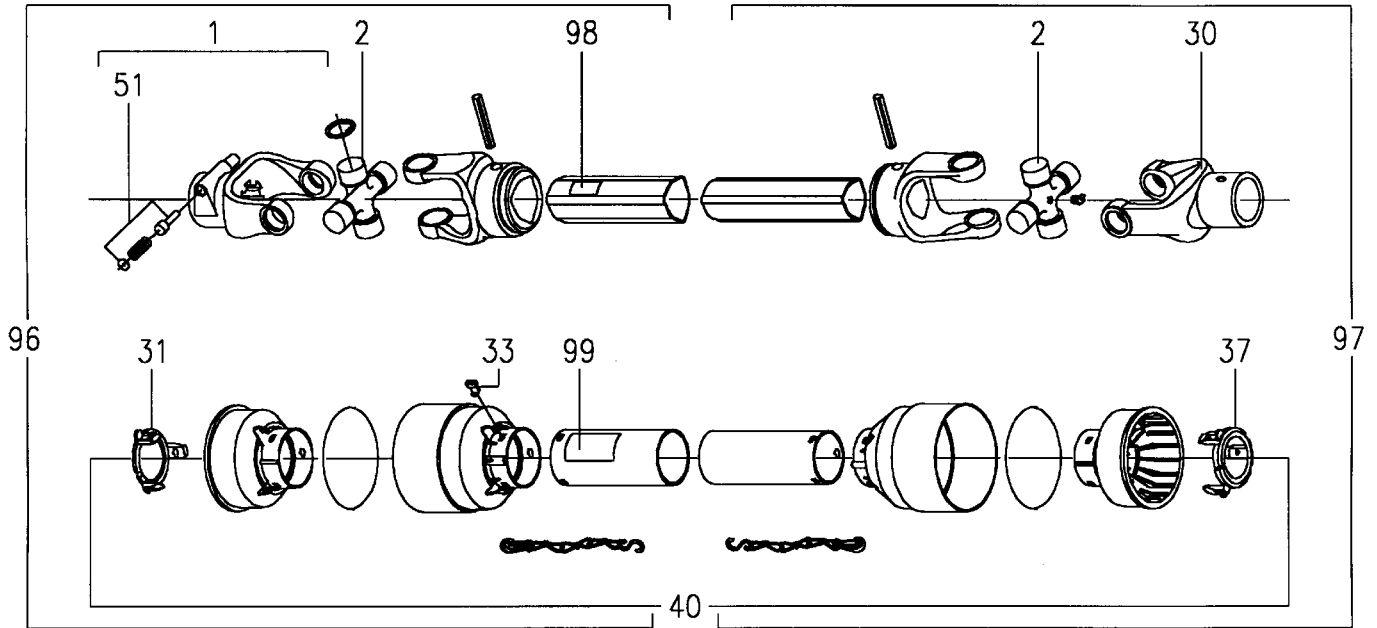

REF. NO.	WORKSAVER PART NO.	E & G PART NO.	DESCRIPTION	NO. REQ'D.
	650565	07.422.117.10	Complete Driveline Assembly (SDM40-48)	1
	650460	07.422.090.10	Complete Driveline Assembly (SDM40-60)	1
	650465	07.422.091.10	Complete Driveline Assembly (SDM40-72)	1
1	650768	141.024.001	Yoke w/ Push Pin (Tractor End)	1
2	650769	180.014.130	Cross Journal Set	2
30	650770	151.014.035	Yoke, Smooth Bore (Imp. End)	1
31	650771	180.013.012	Guard Retaining Collar for Outer Tube	1
33	650712	190.000.019	Bolt, Plastic	6
37	650772	180.013.011	Guard Retaining Collar for Inner Tube	1
40	650773	142.240.004.7420	Complete Guard w/ Instruction Manual (SDM40-48)	1
	650774	142.240.059.7420	Complete Guard w/ Instruction Manual (SDM40-60)	1
	650775	142.240.060.7420	Complete Guard w/ Instruction Manual (SDM40-72)	1
51	650719	166.026.004	Push Pin Set 1 <sup>3</sup> / <sub>8</sub> "	1
96	650776	123.240.685.10	Half Female Shaft w/ Guarding (SDM40-48) (Tractor End)	1
	650777	123.240.747.10	Half Female Shaft w/ Guarding (SDM40-60) (Tractor End)	1
	650778	123.240.748.10	Half Female Shaft w/ Guarding (SDM40-72) (Tractor End)	1
97	650779	123.240.309.10	Half Male Shaft w/ Guarding (SDM40-48) (Imp. End)	1
	650781	123.240.509.10	Half Male Shaft w/ Guarding (SDM40-60) (Imp. End)	1
	650782	123.240.465.10	Half Male Shaft w/ Guarding (SDM40-72) (Imp. End)	1
98	650726	190.000.098	"DANGER" Label for Outer Tube	1
99	650727	190.000.099	"DANGER" Label for Outer Guard Tube	1

# SDM40-60 PARTS VIEW

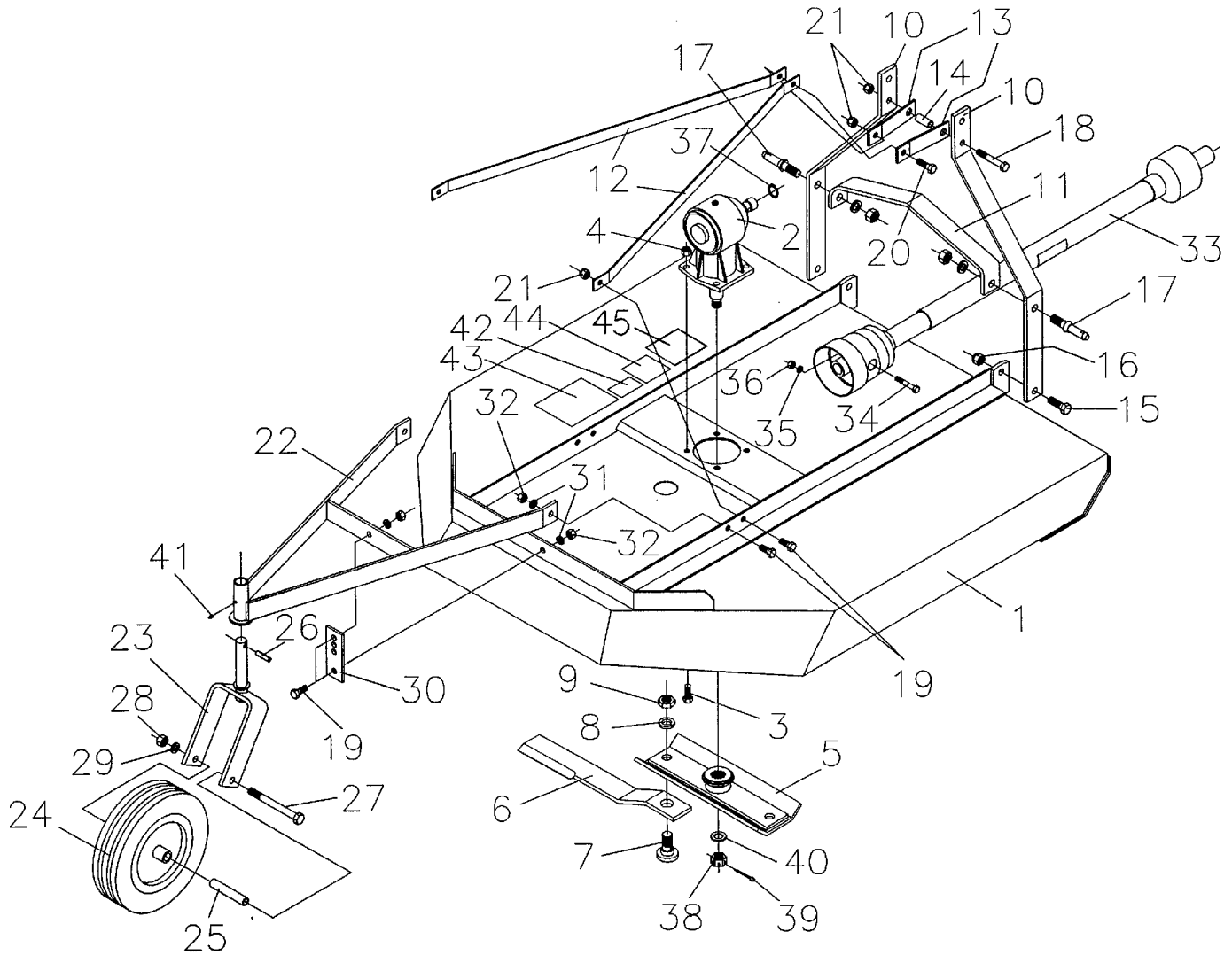

## SDM40-48 (4' CUTTER) PARTS LIST

REF. NO.	PART NO.	DESCRIPTION	NO. REQ'D.
1	650561	Deck Weldment, SDM40-48	1
2	650435	Gearbox - Comer 135.802 (SDM40-48)	1
6	650570	Blade, Cutter SDM40-48	2
12	650569	Linkage Lift Strap SDM40-48	2
33	650565	PTO Assembly, SDM40-48	1

**SDM40-60 ( 5 ' CUTTER ) PA R T S L I S T**  
and parts common to all models

REF. NO.	PART NO.	DESCRIPTION	NO. REQ'D.
1	650351	Deck Weldment, SDM40-60	1
2	650440	Gearbox - Comer 135.800	1
3	2503175	Bolt, Hex $\frac{5}{8}$ " - 11 NC x $1\frac{3}{4}$ "	4
4	2500083	Nut, Hex Vibration Proof $\frac{5}{8}$ " - 11 NC	4
5	650395	Blade Holder Weldment	1
6	650425	Blade, Cutter SDM40-60/MDM70-60	2
7	650426	Blade Bolt, $1\frac{1}{8}$ "	2
8	650427	Lock, Washer, $1\frac{1}{8}$ " HD	2
9	650428	Nut, Hex Jam, $1\frac{1}{8}$ " - 12 UNF Gr. 8	2
10	650378	Sidebar, Toplink "A"	2
11	650379	Crossbar, Toplink "A"	1
12	650382	Linkage Lift Strap	2
13	650383	Tie Link, Toplink "A"	2
14	650384	Spacer	1
15	2503258	Bolt, Hex $\frac{3}{4}$ " - 10 x 2.25 Gr. 5	2
16	2500037	Nut, Hex Nylock $\frac{3}{4}$ " - 10 NC	2
17	590108	AK-578 Draw Pin	2
18	2503066	Bolt, Hex Head $\frac{5}{8}$ " - 11 NC x 4"	1
19	2503154	Bolt, Hex $\frac{5}{8}$ " - 11 NC x $1\frac{1}{2}$ "	6
20	2503152	Bolt, Hex Head $\frac{5}{8}$ " - 11 NC x 2"	1
21	2500041	Nut, Hex Nylock $\frac{5}{8}$ " - 11 NC	4
22	650416	A-Frame Weldment Tail Wheel	1
23	650412	Yoke Weldment	1
24	650480	Wheel Assembly - SDM40-60/72 Cutters	1
25	650386	Spindle Tube	1
26	2504179	Roll Pin $\frac{1}{2}$ " x 2"	1
27	2503256	Bolt, $\frac{3}{4}$ " - 10 NC x $7\frac{1}{2}$ " HH Gr. 5	1
28	2500002	Nut, Hex $\frac{3}{4}$ " - 10 NC	1
29	2502001	Washer, Springlock $\frac{3}{4}$ "	1
30	650387	Bar, Tail Wheel Adj.	1
31	2502007	Washer, Springlock $\frac{5}{8}$ "	4
32	2500013	Nut, Hex $\frac{5}{8}$ " - 11 NC	4
33	650460	PTO Assembly, SDM40-60	1
34	2503012	Bolt, Hex $\frac{1}{2}$ " - 13 NC x 3" Grade 2	1
35	2502002	Washer, Springlock $\frac{1}{2}$ "	1
36	2500003	Nut, Hex $\frac{1}{2}$ " - 13 NC	1
37	2504201	Snap Ring $1\frac{3}{8}$ " Dia. SH-137	1
38	650451	Castle Nut M24 x 2	1
39	650468	Cotter Pin 5 x 50	1
40	650452	Bolt Washer 25 x 44 x 4	1
41	2504049	Drive Zerk $\frac{5}{16}$ "	1
42	101101	Safety Sign - Warning (540 RPM)	1
43	101100	Safety Sign - Danger (Rotating Blades)	1
44	101103	Safety Sign - Danger (Keep Away) SW101	1
45	101157	Safety Sign - Warning (Prevent Serious Injury) M100	1

**SDM40-72 ( 6 ' CUTTER ) PA R T S L I S T**

1	650601	Deck Weldment, SDM40-72	1
6	650430	Blade, Cutter SDM40-72/MDM70-72	2
12	650632	Linkage Lift Strap SDM40-72	2
33	650465	PTO Assembly, SDM40-72	1

COMER GEARBOX - LF-135.802  
PARTS VIEW  
(4' CUTTER)

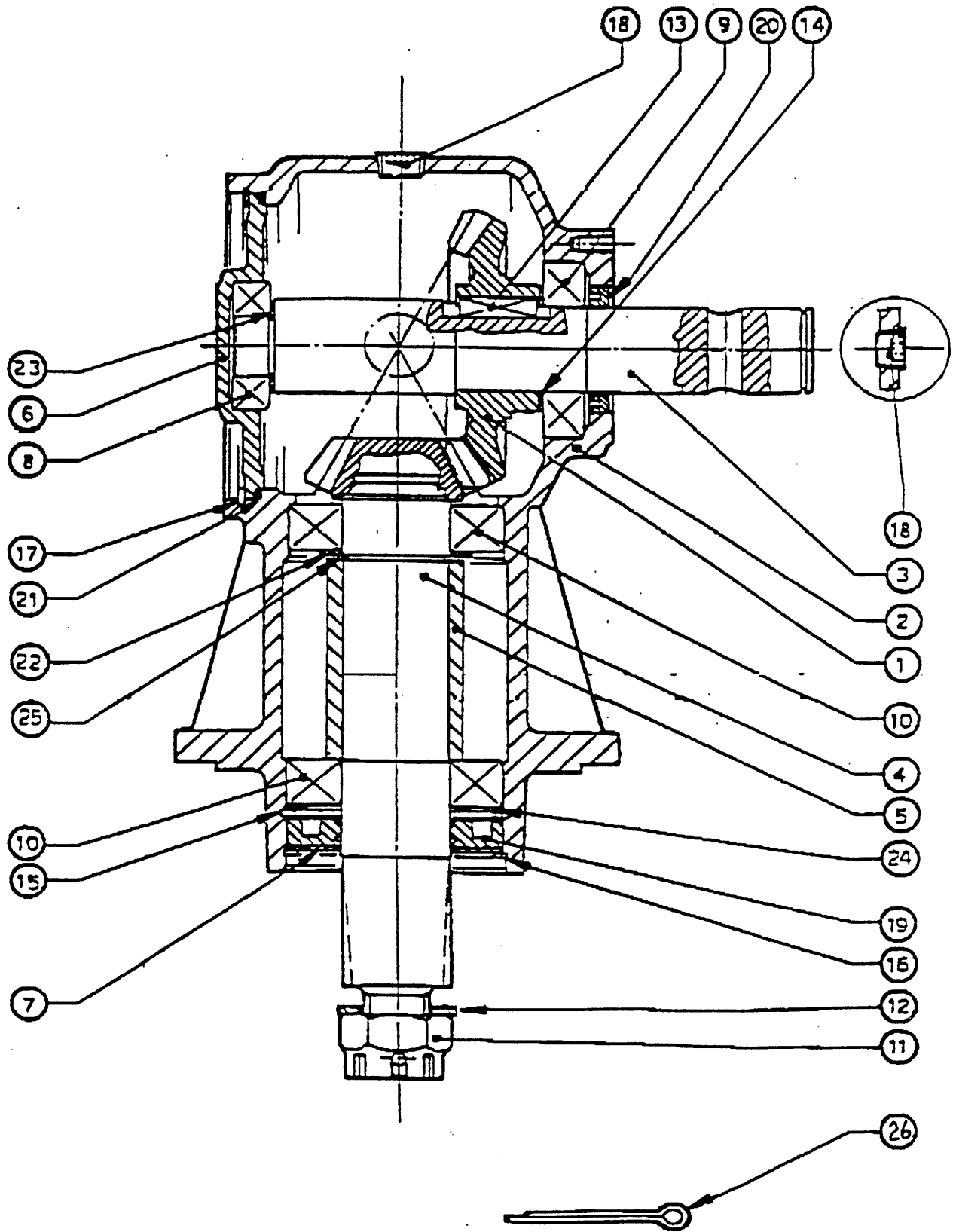

COMER GEARBOX - LF 135.802  
PARTS LIST  
( 4 ' CUTTER )

REF. NO.	WORKSAVER PART NO.	COMER PART NO.	DESCRIPTION	NO. REQ'D.
1	650553	0.135.5000.00	Gear Z23 M5	1
2	650442	0.135.0301.00	Casing	1
3	650554	0.135.2000.00	Shaft	1
4	650555	0.135.6001.00	Pinion Shaft Z12 M5	1
5	650556	0.135.7101.00	Spacer	1
6	650446	0.135.1301.00	Cover	1
7	650447	1.135.7100.00	Protective Washer	1
8	650448	8.0.1.00034	Bearing 6205	1
9	171017	8.0.1.00870	Bearing 6207	1
10	650449	8.0.1.00871	Bearing 6208	2
11	650451	8.2.2.00515	Castle Nut M24 x 2 PR80 B	1
12	650452	8.3.2.00409	Bolt Washer 25 x 44 x 4	1
13	650453	8.4.1.00993	Parallel Key B 10 x 8 x 30	1
14	650557	8.5.1.00029	Snap Ring 40 UNI 7435	1
15	650456	8.5.2.00030	Snap Ring 80 UNI 7437	1
16	650457	8.5.3.00955	Snap Ring SB 81	1
17	650458	8.5.3.01057	Snap Ring SB 125	1
18	650459	8.6.6.00201	Plug 3/8" Gas	2
19	650558	8.7.1.01171	Double Lip Seal 40 x 80 x 12	1
20	650559	8.7.3.01172	Double Lip Seal 35 x 52 x 7	1
21	650463	8.7.6.01058	O-Ring OR-4462	1
22	171007	0.244.7500.00	Shim 51.5	1
23	650454	0.100.7500.00	Shim 35.3	1
24	171014	0.259.7500.00	Shim 48.0	1
25	709059	8.5.1.00680	Snap Ring 40 UNI 7436	1
26	650468	8.4.7.00516	Cotter Pin B5 x 50	1

COMER GEARBOX PARTS VIEW  
(5' & 6' CUTTERS)

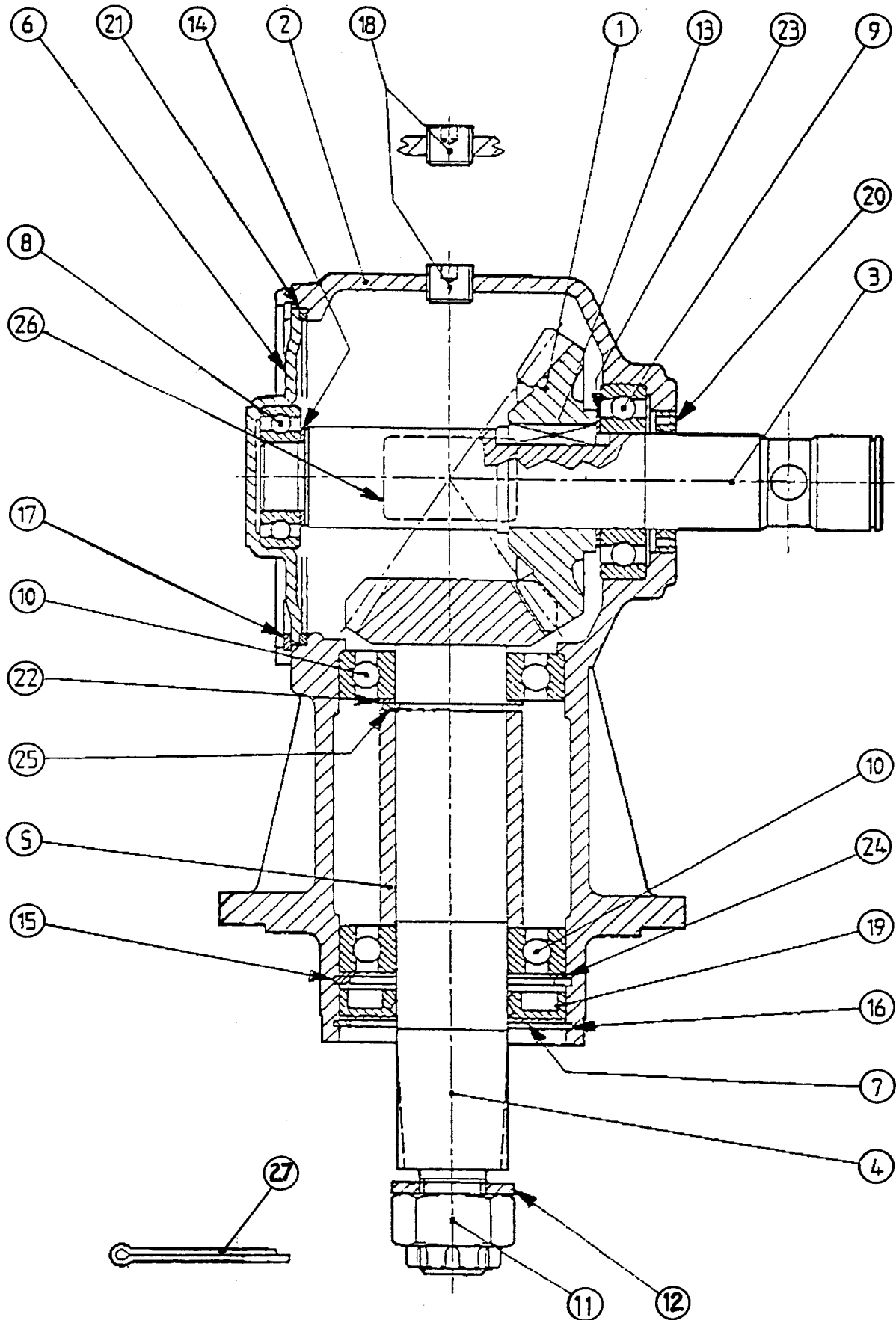

COMER GEARBOX - LF 135.800  
PARTS LIST  
( 5 ' & 6 ' CUTTERS )

REF. NO.	WORKSAVER PART NO.	COMER PART NO.	DESCRIPTION	NO. REQ'D.
1	650441	0.131.5000.00	Crown Wheel Z22 M5	1
2	650442	0.135.0301.00	Casing	1
3	650443	0.135.2004.00	Shaft	1
4	650444	0.135.6201.00	Pinion Z15 M5	1
5	650445	0.135.7105.00	Spacer	1
6	650446	0.135.1301.00	Cover	1
7	650447	1.135.7100.00	Protective Washer	1
8	650448	8.0.1.00034	Bearing 6205	1
9	171017	8.0.1.00870	Bearing 6207	1
10	650449	8.0.1.00871	Bearing 6208	2
11	650451	8.2.2.00515	Castle Nut M24 x 2 PR80 B	1
12	650452	8.3.2.00409	Bolt Washer 25 x 44 x 4	1
13	650453	8.4.1.00993	Parallel Key B 10 x 8 x 30	1
14	650454	0.100.7500.00	Shim 35.3	1
15	650456	8.5.2.00030	Snap Ring 80 UNI 7437	1
16	650457	8.5.3.00955	Snap Ring SB 81	1
17	650458	8.5.3.01057	Snap Ring SB 125	1
18	650459	8.6.6.00201	Plug $\frac{3}{8}$ " Gas	2
19	650461	8.7.1.00748	Double Lip Seal 40 x 80 x 12	1
20	650462	8.7.3.00028	Oil Seal 35 x 52 x 7	1
21	650463	8.7.6.01058	O-Ring OR-4462	1
22	171007	0.224.7500.00	Shim 51.5	1
23	171014	0.259.7500.00	Shim 48.0	1
24	650464	0.267.7500.00	Shim 79.9	1
25	709059	8.5.1.00680	Snap Ring 40 UNI 7436	1
26	650466	0.124.7135.00	Spacer (China)	1
27	650468	8.4.7.00516	Cotter Pin B5 x 50	1



## SAFETY PRECAUTIONS

**MOST ACCIDENTS OCCUR BECAUSE OF NEGLIGENCE OR CARELESSNESS.**

**AVOID NEEDLESS ACCIDENTS BY FOLLOWING ALL OF THE SAFETY PRECAUTIONS LISTED BELOW.**

- Machinery should be operated only by those who are responsible and are authorized to do so.
- Stop the engine, lower all equipment, lock the brakes, and remove the ignition key before dismounting from the tractor.
- Never stand between tractor and implement while tractor is being backed to hitch.
- Loose fitting clothing should not be worn, to avoid catching on various parts.
- Detach implement in area where children normally do not play.
- When performing adjustments or maintenance on an implement, first lower it to the ground or block it securely at a workable height.
- Only a qualified operator should be permitted on tractor when in operation; no riders allowed.
- Make certain everyone is in the clear before starting tractor or raising or lowering equipment.
- Operate the tractor and implement only while seated in the driver's seat.
- Reduce speed when transporting mounted implements to avoid bouncing and momentary loss of steering control.
- A heavy load can cause instability of the tractor. Use extreme care during road travel. Slow down on turns and watch out for bumps. Tractor may need front counter-weights to counter-balance the weight of the implement.
- Reduce speed on hillsides or curves so there is no danger of tipping.
- Avoid driving too close to the edge of ditches or creeks.
- Do not transport implement on public roads without reflectors and slow moving vehicle emblem in daylight and with approved warning lights at night and other periods of poor visibility.
- Due to the width of some implements, use extra caution on highways, farm roads, and when approaching gates.
- Always be sure the implement is in the proper position for transport.
- Keep alert and watch the front as well as the rear when working with the implement.

### OWNER'S/ OPERATOR'S MANUAL

### MODEL NO's

**SDM40-48**

**SDM40-60**

**SDM40-72**

**WHEN ORDERING  
REPAIR PARTS,  
ALWAYS GIVE  
THE FOLLOWING  
INFORMATION:**

1. PART NUMBER
2. PART DESCRIPTION
3. MODEL NUMBER
4. NAME OF ITEM

OCTOBER 2001

**Equip tractors with roll-over protection (ROPS) and keep all machinery guards in place.**

**Keep children away from danger all day, every day . . .**

**Please work, drive, play and live each day with care and concern for your safety and that of your family and fellow citizens.**

**MAKE EVERY DAY  
A HOLIDAY  
FROM ACCIDENTS**

**WORKSAVER, INC.**

**P.O. BOX 100 LITCHFIELD, IL 62056-0100 (217) 324-5973**

**WEB: <http://www.worksaver.com> E-MAIL: [sales@worksaver.com](mailto:sales@worksaver.com)**



## Free Manuals Download Website

<http://myh66.com>

<http://usermanuals.us>

<http://www.somanuals.com>

<http://www.4manuals.cc>

<http://www.manual-lib.com>

<http://www.404manual.com>

<http://www.luxmanual.com>

<http://aubethermostatmanual.com>

Golf course search by state

<http://golfingnear.com>

Email search by domain

<http://emailbydomain.com>

Auto manuals search

<http://auto.somanuals.com>

TV manuals search

<http://tv.somanuals.com>