

BRUSHCUTTERS

BC2311LE
BC2611LE/WE
BC3501LE/WE
BC4501WE

OWNER'S MANUAL

Thank you for purchasing a ZENOAH product.
 Before using our brushcutter, please read this manual carefully to understand the proper use of your unit.

1 Explanation of pictorials

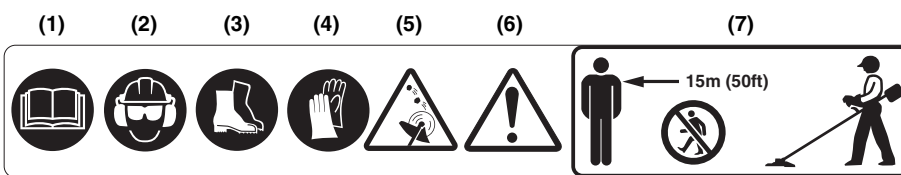

- (1) Read owner's manual before operating this machine.
- (2) Wear head, eye and ear protection.
- (3) Wear foot protection.
- (4) Wear gloves.
- (5) Beware of thrown objects.
- (6) Warning / Attention
- (7) Keep all children, bystanders and helpers 15 meters away from the machine.

IMPORTANT

If warning label peels off or becomes soiled and impossible to read, you should contact the dealer from which you purchased the product to order new labels and affix them in the required location(s).

WARNING

Never modify your machine.
 We won't warrant the machine, if you use the remodeled brushcutter or if you don't observe the proper usage written in the manual.

2 For safe operation

1. Read this manual carefully until you completely understand and can follow all safety notes, precautions, and operating instructions before using of the unit.
2. Do not operate this tool when you are tired, ill, or under the influence of alcohol, drugs, or medication.
3. Always wear eye or face protection and hearing protection.
4. Do not wear loose clothing, jewelry, short trousers, sandals, or go barefoot. Do not wear anything which might be caught by branches or moving part of the unit. Secure hair so it is above shoulder length.
5. Never start or run the engine inside a closed room or building. Exhaust gases contain dangerous carbon monoxide.
6. Before starting the engine, inspect the entire unit for loose fasteners and fuel leakage. Make sure that the cutting attachment is properly installed and securely fastened.
7. Be sure the blade guard is attached in place.
8. Fuel is highly flammable. Always keep open flames and sparks away from the unit and fuel depot. Do not smoke while refueling the unit or mixing fuel.
9. When refueling the unit, make sure to stop the engine and allow it to cool down. Wipe spilled fuel completely from the unit. Move at least 3 meters away from fueling site before starting the engine.
10. Check the condition of working area to avoid any accident by hitting hidden obstacles such as stumps, stones, cans, or broken grass.
11. Keep bystanders and animals at least 15 meters away from the operating point. If you are approached, immediately stop the engine.

12. Keep firm footholds and balance at all times. Do not use the unit where footing is unsteady or slippery.
13. Keep cutting attachment below waist level.
14. Keep all parts of your body away from the rotating cutting attachment and hot surfaces.
15. Warn the operator of the danger of blade thrust. (Kick back)
 Blade thrust may occur when the spinning blade contacts a solid object in the critical area. A dangerous reaction may occur causing the entire unit and operator to be thrust violently. This reaction is called Kick back. As a result, the operator can lose control of the unit which can cause serious or fatal injury. Kick back is more likely to occur in areas where it is difficult to see the material to be cut.
16. When inspecting or servicing the unit, make sure to stop the engine and disconnect the spark plug as necessary.
17. Cover the blade when the transporting or storing the unit. Secure the unit before for storage or transporting to prevent loss of fuel, damage or injury.
18. When replacing cutting attachment or other components, be sure to use the parts supplied or recommended by ZENOAH.
19. When the unit is turned off, make sure the cutting attachment has stopped before the unit is set down.
20. For units equipped with a clutch, be sure the cutting attachment stops turning when the engine idles.
21. Use only for tasks explained in the instruction handbook.
22. Discard blades that are bent, warped, cracked, broken or damaged in any way.
23. Instructions on stopping a coasting blade.
 A blade can injure while it continues to spin after the engine is stopped or throttle control is released.

24. Stop the engine and blade before removing material that is blocking or entangling the cutting attachment.
25. Use a sharp blade. A dull blade is more likely to snag and thrust. Replace the fastening nut according to the manufacturer's instruction.
26. Cut only material recommended by the manufacturer. Do not let the blade contact material it cannot cut, such as rocks, metal etc.
27. Always wear safety boots, additionally a helmet is required if there is a risk of contact with falling objects.

3 Setup

ENGINE

[BC2311LE/BC2611LE/WE]

1. Loosen the bolts temporarily attached to the clutch housing.
2. Push the drivershaft toward the gearcase and rotate it by hand to check that the driveshaft is engaged with the gears.
3. Insert the shaft tube into the clutch housing until it bottoms. When difficult to engage, twist the engine slightly.
4. Align the positioning holes on the clutch housing and the shaft tube and fit the bolt into the holes. And fasten the tightening bolts by turns securely.
 (Tightning torque: 4.9~7.8N.m. (0.5~0.8kgm))

- (1) Positioning hole
 (2) Bolt (M5x10)
 (3) Tightning bolt (M5x22)

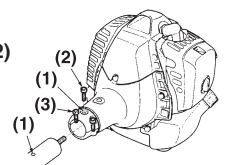

[BC3501LE/WE/BC4501WE]

- Using attached 4 socket screws, secure the connection firmly with equal force.

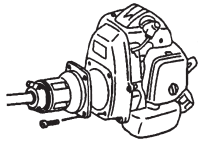

■ HANDLE

[BC2311LE/BC2611LE/BC3501LE]

- Put the handle onto the main pipe and fix it with 4 screws.

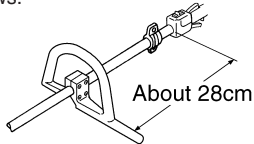

[BC2611WE/BC3501WE/BC4501WE]

- Loosen the 4 bolts on the upper cap and insert the handles equally. Retighten the bolts.
- Put the handle assembly into the bracket and put the upper cap over it. Tighten the cap securely.

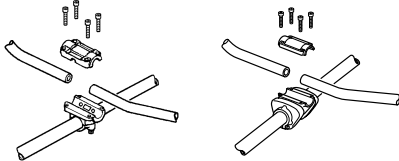

■ CONNECTING THROTTLE WIRE

- Remove the air cleaner cover.
- Connect the end of the throttle wire to the joint on the top of the carburetor.

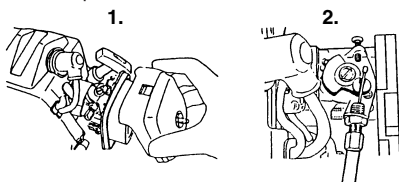

■ CONNECTING SWITCH WIRES

- Connect the switch wires between the engine and the main unit.

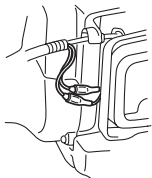

■ PROTECTOR

[BC2611WE/BC3501WE/BC4501WE]

- Wrap the protector around the outer pipe as shown in the figure, and fasten the magic fastener.



■ INSTALLING DEBRIS GUARD

- Fit the guard skirt on debris guard.

[BC2311LE/BC2611]

Attach the debris guard with the bolts provided while inserting the spacer between the guard and the pipe.

[BC3501/BC4501WE]

Attach the debris guard with the bolts provided to the pipe.

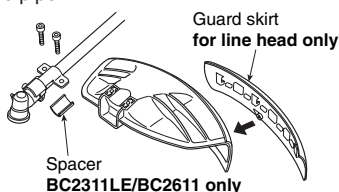

■ INSTALLING LINE HEAD

- While locking the gear shaft by inserting the angled bar(1) into the holder(A)(2) on the gear box, loosen and remove the nut(left-handed)
- Fit the line head assembly to the gear shaft. Tighten it securely by hand.

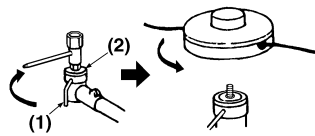

■ INSTALLING BLADE

Remove the guard skirt of debris guard, when using metal blade.

- Put the angled bar(1) into the side holes of the inner holder and the gearcase.
- Remove the nut(Left-handed) and the outer holder(3) from the gearshaft.
- Put the blade onto the inner holder(2). Make the marked side face the holder.
- Put the outer holder(3) onto the gearshaft making the recessed side face the blade.
- Fasten the blade by the nut and the cover(4).

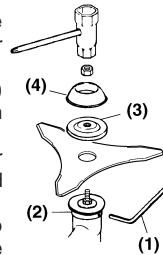

■ BALANCE UNIT

- Put on strap and attach unit to strap.
- Slide clamp up or down until unit balances with head aparting from the ground when using it.



4 Fuel

▲ WARNING

- Gasoline is very flammable. Avoid smoking or bringing any flame or sparks near fuel. Make sure to stop the engine and allow it cool before refueling the unit. Select outdoor bare ground for fueling and move at least 3m (10ft) away from the fueling point before starting the engine.



RECOMMENDED MIXING RATIO GASOLINE 50:OIL 1 (when using ZENOAH genuine oil)

- The Zenoah engines are lubricated by oil specially formulated for air-cooled 2-cycle gasoline engine use. If Zenoah oil is not available, use an anti-oxidant added quality oil expressly labeled for air-cooled 2-cycle engine use. (JASO FC GRADE OIL or ISO EGC GRADE)
- Do not use BIA or TCW (2-stroke water-cooling type) mixed oil.
- Exhaust emission are controlled by the fundamental engine parameters and components (eq., carburation, ignition timing and port timing) without addition of any major hardware or the introduction of an inert material during combustion.
- These engines are certified to operate on unleaded gasoline.
- Make sure to use gasoline with a minimum octane number of 89 RON (USA/Canada: 87AL)
- If you use a gasoline of a lower octane value than prescribed, there is a danger that the engine temperature may rise and an engine problem such as piston seizing may consequently occur.
- Unleaded gasoline is recommended to reduce the contamination of the air for the sake of your health and the environment.
- Poor quality gasolines or oils may damage sealing rings, fuel lines or fuel tank of the engine.

■ HOW TO MIX FUEL

IMPORTANT

Pay attention to agitation.

- Measure out the quantities of gasoline and oil to be mixed.
- Put some of the gasoline into a clean, approved fuel container.
- Pour in all of the oil and agitate well.
- Pour in the rest of gasoline and agitate again for at least one minute. As some oils may be difficult to agitate depending on oil ingredients, sufficient agitation is necessary for the engine to last long. Be careful that, if the agitation is insufficient, there is an increased danger of early piston seizing due to abnormally lean mixture.
- Put a clear indication on the outside of the container to avoid mixing up with gasoline or other containers.
- Indicate the contents on outside of container for easy identification.

■ FUELING THE UNIT

- Untwist and remove the fuel cap. Rest the cap on a dustless place.
- Put fuel into the fuel tank to 80% of the full capacity.
- Fasten the fuel cap securely and wipe up any fuel spillage around the unit.

▲ WARNING

- Select bare ground for fueling.
- Move at least 10feet (3meters) away from the fueling point before starting the engine.
- Stop the engine before refueling the unit. At that time, be sure to sufficiently agitate the mixed gasoline in the container.

FOR YOUR ENGINE LIFE, AVOID;

- FUEL WITH NO OIL(RAW GASOLINE) – It will cause severe damage to the internal engine parts very quickly.
- GASOHOL – It can cause deterioration of rubber and/or plastic parts and disruption of engine lubrication.
- OIL FOR 4-CYCLE ENGINE USE – It can cause spark plug fouling, exhaust port blocking, or piston ring sticking.
- Mixed fuels which have been left unused for a period of one month or more may clog the carburetor and result in the engine failing to operate properly.
- In the case of storing the product for a long period of time, clean the fuel tank after rendering it empty. Next, activate the engine and empty the carburetor of the composite fuel.
- In the case of scrapping the used mixed oil container, scrap it only at an authorized repository site.

NOTE

As lot details of quality assurance, read the description in the section Limited Warranty carefully. Moreover, normal wear and change in product with no functional influence are not covered by the warranty. Also, be careful that, if the usage in the instruction manual is not observed as to the mixed gasoline, etc. described therein, it may not be covered by the warranty.

5 Operation

■ STARTING ENGINE

▲ WARNING

The cutting head will start rotating upon the engine starts.

- Feed fuel into the fuel tank and tighten the cap securely.
- Rest the unit on a flat, firm place. Keep the cutting head off the ground and clear of surrounding objects, as it will start rotating upon starting of the engine.
- Push the primer pump several times until overflow fuel flows out in the clear tube.

- Choke lever
- Close
- Open
- Primer pump

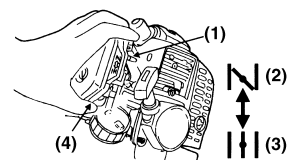

4. Move the choke lever to the closed position.
5. Set the stop switch to the "RUN" position.
Place the unit on a flat, firm place.
Keep the cutting head clear of everything around it.

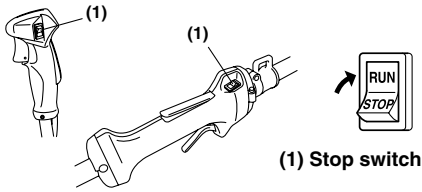

(1) Stop switch

6. While holding the unit firmly, pull out the starter rope quickly until engine fires.



WARNING

The product is equipped with a centrifugal clutch mechanism, so the cutting attachment begins to rotate as soon as the engine is started by putting the throttle into the start position. When starting the engine, place the product onto the ground in a flat clear area and hold it firmly in place so as to ensure that neither the cutting part nor the throttle come into contact with any obstacle when the engine starts.

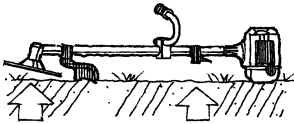

IMPORTANT

Avoid pulling the rope to its end or returning it by releasing the knob. Such actions can cause starter failures.

7. Move the choke lever downward to open the choke. And restart engine.
8. Allow the engine to warm up for a several minutes before starting operation.

NOTE

1. When restarting the engine immediately after stopping it, leave the choke open.
2. Overchoking can make the engine hard to start due to excess fuel. When the engine failed to start after several attempts, open the choke and repeat pulling the rope, or remove the spark plug and dry it.

STOPPING ENGINE

1. Release the throttle trigger and run the engine for half a minute.
2. Shift the stop switch to the STOP position.

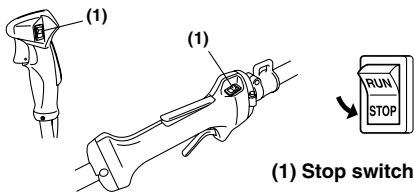

(1) Stop switch

IMPORTANT

Except for an emergency, avoid stopping the engine while pulling the throttle lever.

ADJUSTING THROTTLE CABLE

- The normal play is 1 or 2 mm when measured at the carburetor side end. Readjust with the cable adjuster as required.

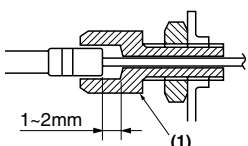

(1) Cable adjuster

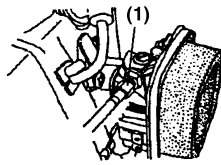

(1) Cable adjuster

ADJUSTING IDLING SPEED

1. When the engine tends to stop frequently at idling mode, turn the adjusting screw clockwise.
2. When the cutting head keeps rotating after releasing the trigger, turn the adjusting screw counter-clockwise.

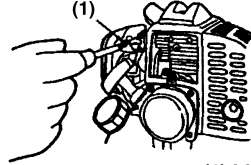

(1) Idle adjusting screw

NOTE

Warm up the engine before adjusting the idling speed.

CUTTING WORK

- By using the shoulder strap, hang the unit on your right side. Adjust the strap length so that the cutting head may become parallel to the ground.

Shoulder strap



- Choose a suitable recommended cutting attachment according to the object to be cut. Never use other cutting attachment not approved by ZENOAH.

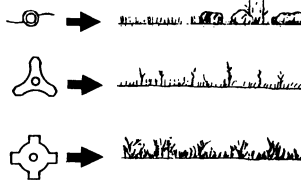

LINE HEAD USAGE

WARNING

1. Always wear eye protection such as safety goggles. Never lean over the rotating cutting head. Rocks or other debris could be thrown into eyes and face and cause serious personal injury.
2. Keep the debris guard attached in place at all times when the unit is operated.

TRIMMING GRASS AND WEEDS

- Always remember that the TIP of the line does cutting. You will achieve better results by not crowding the line into the cutting area. Allow the unit to trim at its own pace.

1. Hold the unit so the head is off the ground and is tilted about 20 degrees toward the sweep direction.
2. Use full throttle when cutting.
3. You can avoid thrown debris by sweeping from your left to the right.
4. Use a slow, deliberate action to cut heavy growth. The rate of cutting motion will depend on the material being cut. Heavy growth will require slower action than will light growth.
5. Never swing the unit so hard as you are in danger of losing your balance or control of the unit.
6. Try to control the cutting motion with the hip rather than placing the full workload on the arm and hands.
7. Take precautions to avoid wire, grass and dead, dry, long-stem weeds from wrapping around the head shaft. Such materials can stall

the head and cause the clutch to slip, resulting in damage to the clutch system if repeated frequently.

ADJUSTING THE LINE LENGTH

- Your brushcutters is equipped with a semi- auto type nylon line head that allows the operator to advance the line without stopping the engine. When the line becomes short, lightly tap the head on the ground while running the engine at full throttle.
- Each time the head is bumped, the line advance about 1 inch(25.4 mm). For better effect, tap the head on bear ground or hard soil. Avoid bumping in thick, tall grass as the engine may stall by overload.

6 Maintenance

WARNING

Make sure that the engine has stopped and is cool before performing any service to the machine. Contact with moving cutting head or hot muffler may result in a personal injury.

AIR FILTER

The air filter, if clogged, will reduce the engine performance. Check and clean the filter element in warm, soapy water as required. Dry completely before installing. If the element is broken or shrunk, replace with a new one.

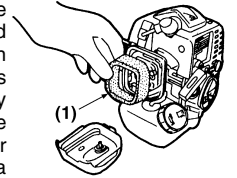

Air filter

FUEL FILTER

When the engine runs short of fuel supply, check the fuel cap and the fuel filter for blockage.

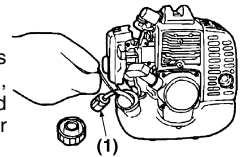

Fuel filter

SPARK PLUG

Starting failure and misfiring are often caused by a fouled spark plug. Clean the spark plug and check that the plug gap is in the correct range. For a replacement plug, use the correct type specified by ZENOAH.

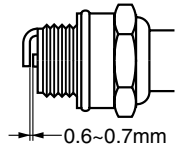

REPLACEMENT PLUG IS A NGK BPMR7A.

IMPORTANT

- Note that using any spark plug other than those designated may result in the engine failing to operate properly or in the engine becoming overheated and damaged.
- To install the spark plug, first turn the plug until it is finger tight, then tighten it a quarter turn more with a socket wrench.

Tightning torque: 9.8~11.8N.m. (1.0~1.2kgm))

REFILLING TRIMMING LINE

1. For replacement line, use a diameter of 2.4mm. The spool is capable for a line upto 6m on the 4" head. Avoid using a larger line as it may cut down the trimming performance.
2. Pinch the slotted area on the both sides of the spool housing to unhook the bottom cap.
3. Take out the spool and pull off the old line. Put one end of new line through the spool holes and pull it until the length is equal between each part of the line.
4. Wind up the line in the correct direction as indicated on the spool.
5. Hook each end of the line in the slot on the edge of the spool, and then put the ends

- through the eyelets on the housing. Make sure that the spring and the washers are in place.
- While holding the spool against the housing, pull the line ends to release them from the slot.
 - Line up the slot on the bottom cap with the hook on the housing, press the cap against the housing until it clicks.

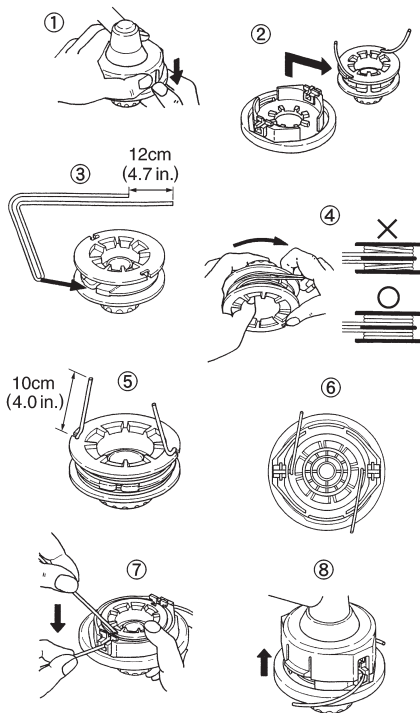

■ GEAR CASE

- The reduction gears are lubricated by multipurpose, lithium-based grease in the gear case. Supply new grease every 25 hours of use or more often depending on the job condition.
- Remove the bolt opposite to the grease nipple before installing new grease to arrange for old grease to exit.

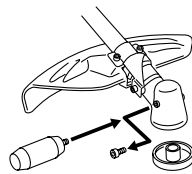

■ INTAKE AIR COOLING VENT

▲ WARNING

- Never touch the cylinder, muffler, or spark plugs with your bare hands immediately after stopping the engine. The engine can become very hot when in operation, and doing so could result in severe burns.
- When checking the machine to make sure that it is okay before using it, check the area around the muffler and remove any wood chips or leaves which have attached themselves to the brushcutter. Failing to do so could cause the muffler to become overheated and that in turn could cause the engine to catch on fire. Always make sure that the muffler is clean and free of wood chips, leaves, and other waste before use.
- Check the intake air cooling vent and the area around the cylinder cooling fins after every 25 hours of use for blockage, and remove any waste which has attached itself to the brushcutter. Note that it is necessary to remove the engine cover shown in in order to be able to view the upper part of the cylinder.

IMPORTANT

If waste gets stuck and causes blockage around the intake air cooling vent or between the cylinder fins, it may cause the engine to overheat, and that in turn may cause mechanical failure on the part of the brushcutter.

- Cylinder
- Intake air cooling vent

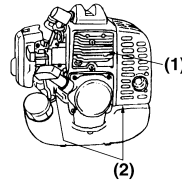

■ MUFFLER

▲ WARNING

- Inspect periodically, the muffler for loose fasteners, any damage or corrosion. If any sign of exhaust leakage is found, stop using the machine and have it repaired immediately.
- Note that failing to do so may result in the engine catching on fire.

■ PROCEDURES TO BE PERFORMED AFTER EVERY 100 HOURS OF USE

- Remove the muffler, insert a screwdriver into the vent, and wipe away any carbon buildup. Wipe away any carbon buildup on the muffler exhaust vent and cylinder exhaust port at the same time.
- Tighten all screws, bolts, and fittings.
- Check to see if any oil or grease has worked its way in between the clutch lining and drum, and if it has, wipe it away using oil-free, lead-free gasoline.



■ MAINTENANCE BEFORE STORAGE

- Old fuel left in the carburetor may cause starting failure. When a series of operation finished, make sure to empty the fuel tank and drain the carburetor.
- Check all parts and the functions. If the failed or damaged parts have been found, replace them with new ones.

7 Specifications

MODEL CODE	Unit	BC2311LE	BC2611LE	BC2611WE	BC3501LE	BC3501WE	BC4501WE
Overall size							
Length	mm	1815	←	←	1845	←	←
Width	mm	420	←	650	420	650	←
Height	mm	295	←	560	360	560	←
Dry weight	Kg	5.0	5.1	5.3	7.1	7.6	7.8
Engine model							
Displacement	cc	G23LS	G26LS	←	G35L-D	←	G45L-D
Carburetor	*	Diaphragm	←	←	←	←	←
Fuel (Mixture ratio)	*	50:1 (Gasoline and 2cycle oil)	←	←	←	←	←
Fuel tank capacity	litter	0.6	0.75	←	0.74	←	0.94
Service range	rpm	5000~8000	←	←	←	←	←
Spark plug	*	BPMR7A	←	←	←	←	←
Clutch system	*	Two-shoe Centrifugal-Type	←	←	←	←	←
Anti-vibration system							
Housing	*	Yes	←	←	←	←	←
Handle-bracket	*	No	←	←	←	Yes	←
Gearhead							
Neck angle	deg	60	←	←	←	←	←
Reduction ratio	*	1.462	←	←	1.40	←	←
Blade rotation	*	Counter-clockwise	←	←	←	←	←
Handle type	*	Loop	←	Both	Loop	Both	←
Throttle lever	*	Trigger Type (With Safety-lock)	←	←	←	←	←
Standard cutter	*	Nylon	←	←	←	←	←
Harness type	*	Single	←	←	Double	←	←
Quick release	*	Yes	←	←	←	←	←
Standard accessories							
Goggle	*	●	←	←	←	←	←
Tool-kit	*	●	←	←	←	←	←
Owner's manual	*	●	←	←	←	←	←

Specifications are subject to change without notice.

Free Manuals Download Website

<http://myh66.com>

<http://usermanuals.us>

<http://www.somanuals.com>

<http://www.4manuals.cc>

<http://www.manual-lib.com>

<http://www.404manual.com>

<http://www.luxmanual.com>

<http://aubethermostatmanual.com>

Golf course search by state

<http://golfingnear.com>

Email search by domain

<http://emailbydomain.com>

Auto manuals search

<http://auto.somanuals.com>

TV manuals search

<http://tv.somanuals.com>