

User Manual

# GETTING STARTED? EASY.



ZKCNA4K1  
ZKCNA4X1

EN User Manual  
Built-In Double Oven

# ZANUSSI

## VISIT OUR WEBSITE TO:

---



Get usage advice, brochures, trouble shooter, service and repair information:  
[www.zanussi.com/support](http://www.zanussi.com/support)

## SAFETY INFORMATION

---

Before the installation and use of the appliance, carefully read the supplied instructions. The manufacturer is not responsible for any injuries or damage that are the result of incorrect installation or usage. Always keep the instructions in a safe and accessible location for future reference.

## **CHILDREN AND VULNERABLE PEOPLE SAFETY**

- This appliance can be used by children aged from 8 years and above and persons with reduced physical, sensory or mental capabilities or lack of experience and knowledge if they have been given supervision or instruction concerning the use of the appliance in a safe way and understand the hazards involved. Children of less than 8 years of age and persons with very extensive and complex disabilities shall be kept away from the appliance unless continuously supervised.
- Children should be supervised to ensure that they do not play with the appliance.
- Keep all packaging away from children and dispose of it appropriately.
- **WARNING:** Keep children and pets away from the appliance when it operates or when it cools down. Accessible parts become hot during use.
- If the appliance has a child safety device, it should be activated.
- Children shall not carry out cleaning and user maintenance of the appliance without supervision.

## **GENERAL SAFETY**

- Only a qualified person must install this appliance and replace the cable.
- Do not use the appliance before installing it in the built-in structure.

- Disconnect the appliance from the power supply before carrying out any maintenance.
- If the mains power supply cable is damaged, it must be replaced by the manufacturer, its Authorised Service Centre or similarly qualified persons to avoid an electrical hazard.
- The means for disconnection must be incorporated in the fixed wiring in accordance with the wiring rules.
- **WARNING:** Ensure that the appliance is switched off before replacing the lamp to avoid the possibility of electric shock.
- **WARNING:** The appliance and its accessible parts become hot during use. Care should be taken to avoid touching heating elements.
- Always use oven gloves to remove or put in accessories or ovenware.
- To remove the shelf supports first pull the front of the shelf support and then the rear end away from the side walls. Install the shelf supports in the opposite sequence.
- Do not use a steam cleaner to clean the appliance.
- Do not use harsh abrasive cleaners or sharp metal scrapers to clean the glass door since they can scratch the surface, which may result in shattering of the glass.

## SAFETY INSTRUCTIONS

### INSTALLATION



**WARNING!** Only a qualified person must install this appliance.

- Remove all the packaging.
- Do not install or use a damaged appliance.
- Follow the installation instructions supplied with the appliance.
- Always take care when moving the appliance as it is heavy. Always use safety gloves and enclosed footwear.
- Do not pull the appliance by the handle.
- Install the appliance in a safe and suitable place that meets installation requirements.
- Keep the minimum distance from other appliances and units.
- Before mounting the appliance, check if the oven door opens without restraint.

- The appliance is equipped with an electric cooling system. It must be operated with the electric power supply.
- The built-in unit must meet the stability requirements of DIN 68930.

Cabinet minimum height (Cabinet under the worktop minimum height)	875 mm
Cabinet width	560-570 mm
Cabinet depth	550 mm
Height of the front of the appliance	888 mm
Height of the back of the appliance	872 mm

Width of the front of the appliance	594 mm
Width of the back of the appliance	538 mm
Depth of the appliance	568 mm
Built in depth of the appliance	547 mm
Depth with open door	858 mm
Ventilation opening minimum size. Opening placed on the bottom rear side	560x20 mm
Mounting screws	3.5x25 mm

## ELECTRICAL CONNECTION



**WARNING!** Risk of fire and electric shock.

- All electrical connections should be made by a qualified electrician.
- The appliance must be earthed.
- Make sure that the parameters on the rating plate are compatible with the electrical ratings of the mains power supply.
- Always use a correctly installed shockproof socket.
- Do not use multi-plug adapters and extension cables.
- Make sure not to cause damage to the mains plug and to the mains cable. Should the mains cable need to be replaced, this must be carried out by our Authorised Service Centre.
- Do not let mains cables touch or come near the appliance door or the niche below the appliance, especially when it operates or the door is hot.
- The shock protection of live and insulated parts must be fastened in such a way that it cannot be removed without tools.
- Connect the mains plug to the mains socket only at the end of the installation. Make sure that there is access to the mains plug after the installation.
- If the mains socket is loose, do not connect the mains plug.
- Do not pull the mains cable to disconnect the appliance. Always pull the mains plug.
- Use only correct isolation devices: line protecting cut-outs, fuses (screw type fuses removed from the holder), earth leakage trips and contactors.

- The electrical installation must have an isolation device which lets you disconnect the appliance from the mains at all poles. The isolation device must have a contact opening width of minimum 3 mm.
- This appliance is supplied without a main plug and a main cable.

## USE



**WARNING!** Risk of injury, burns and electric shock or explosion.

- This appliance is for household (indoors) use only.
- Do not change the specification of this appliance.
- Make sure that the ventilation openings are not blocked.
- Do not let the appliance stay unattended during operation.
- Deactivate the appliance after each use.
- Be careful when you open the appliance door while the appliance is in operation. Hot air can release.
- Do not operate the appliance with wet hands or when it has contact with water.
- Do not apply pressure on the open door.
- Do not use the appliance as a work surface or as a storage surface.
- Open the appliance door carefully. The use of ingredients with alcohol can cause a mixture of alcohol and air.
- Do not let sparks or open flames to come in contact with the appliance when you open the door.
- Do not put flammable products or items that are wet with flammable products in, near or on the appliance.



**WARNING!** Risk of damage to the appliance.

- To prevent damage or discoloration to the enamel:
  - do not put ovenware or other objects in the appliance directly on the bottom.
  - do not put aluminium foil directly on the bottom of cavity of the appliance.
  - do not put water directly into the hot appliance.
  - do not keep moist dishes and food in the appliance after you finish the cooking.
  - be careful when you remove or install the accessories.
- Discoloration of the enamel or stainless steel has no effect on the performance of the appliance.

- Use a deep pan for moist cakes. Fruit juices cause stains that can be permanent.
- This appliance is for cooking purposes only. It must not be used for other purposes, for example room heating.
- Always cook with the oven door closed.
- If the appliance is installed behind a furniture panel (e.g. a door) make sure the door is never closed when the appliance operates. Heat and moisture can build up behind a closed furniture panel and cause subsequent damage to the appliance, the housing unit or the floor. Do not close the furniture panel until the appliance has cooled down completely after use.

## CARE AND CLEANING



**WARNING!** Risk of injury, fire, or damage to the appliance.

- Before maintenance, deactivate the appliance and disconnect the mains plug from the mains socket.
- Make sure the appliance is cold. There is the risk that the glass panels can break.
- Replace immediately the door glass panels when they are damaged. Contact the Authorised Service Centre.
- Be careful when you remove the door from the appliance. The door is heavy!
- Clean regularly the appliance to prevent the deterioration of the surface material.
- Clean the appliance with a moist soft cloth. Use only neutral detergents. Do not use abrasive products, abrasive cleaning pads, solvents or metal objects.
- If you use an oven spray, follow the safety instructions on its packaging.

- Do not clean the catalytic enamel with detergents.

## INTERNAL LIGHTING



**WARNING!** Risk of electric shock.

- Concerning the lamp(s) inside this product and spare part lamps sold separately: These lamps are intended to withstand extreme physical conditions in household appliances, such as temperature, vibration, humidity, or are intended to signal information about the operational status of the appliance. They are not intended to be used in other applications and are not suitable for household room illumination.
- Use only lamps with the same specifications.

## SERVICE

- To repair the appliance contact the Authorised Service Centre.
- Use original spare parts only.

## DISPOSAL



**WARNING!** Risk of injury or suffocation.

- Disconnect the appliance from the mains supply.
- Cut off the mains electrical cable close to the appliance and dispose of it.
- Remove the door catch to prevent children or pets from becoming trapped in the appliance.

# PRODUCT DESCRIPTION

## GENERAL OVERVIEW

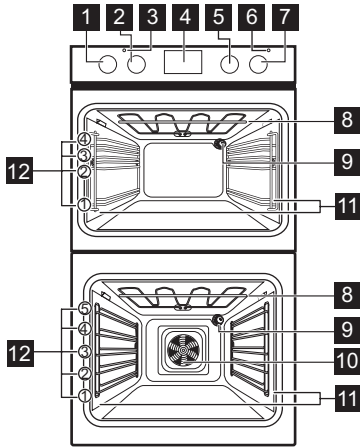

- 1** Knob for the top oven functions
- 2** Knob for the top oven temperature
- 3** Temperature indicator / symbol for the top oven
- 4** Display
- 5** Knob for the main oven functions
- 6** Temperature indicator / symbol for the main oven
- 7** Knob for the main oven temperature
- 8** Heating element
- 9** Lamp
- 10** Fan
- 11** Shelf support, removable
- 12** Shelf positions

## ACCESSORIES

- **Wire shelf**  
For cookware, cake tins, roasts.
- **Grill- / Roasting pan**  
To bake and roast or as pan to collect fat.
- **AirFry: Wire shelf**  
To fry food with less oil or without baking paper.

- Maximum load: 10 kg.
- **Trivet**  
For roasting and grilling.

**i** Use the trivet only with the Grill- / roasting pan.

## CONTROL PANEL

### RETRACTABLE KNOBS

To use the appliance press the knob. The knob comes out.

### SENSOR FIELDS / BUTTONS

—	To set the time.
⌚	To set a clock function.
+	To set the time.

### DISPLAY

**i** The display works only with the main oven.

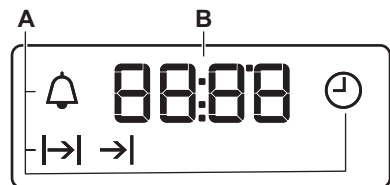





## BEFORE FIRST USE



**WARNING!** Refer to Safety chapters.

### BEFORE FIRST USE

The oven can emit an odour and smoke during preheating. Make sure that the room is ventilated. Preheat both ovens. Heat up one oven at a time.

 <b>Step 1</b>	 <b>Step 2</b>	 <b>Step 3</b>
<b>Set the clock</b>	<b>Clean the oven</b>	<b>Preheat the empty oven</b>
<ol style="list-style-type: none"> <li>1. <b>+</b>, <b>-</b> - press to set the time. After approximately 5 sec., the flashing stops and the display shows the time.</li> </ol>	<ol style="list-style-type: none"> <li>1. Remove all accessories and removable shelf supports from the oven.</li> <li>2. Clean the oven and the accessories with a soft cloth, warm water and a mild detergent.</li> </ol>	<ol style="list-style-type: none"> <li>1. Set the maximum temperature for the function: . Time: 1 h.</li> <li>2. Set the maximum temperature for the function: . Time: 15 min.</li> </ol>

Turn off the oven and wait until it is cold. Place the accessories and the removable shelf supports in the oven.

## DAILY USE



**WARNING!** Refer to Safety chapters.





### HOW TO SET: HEATING FUNCTION

<b>Step 1</b>	Turn the knob for the heating functions to select a heating function.
---------------	---





<b>Step 2</b>	Turn the control knob to select the temperature.
<b>Step 3</b>	When the cooking ends, turn the knobs to the off position to turn off the oven.

### TOP OVEN FUNCTIONS





<b>Heating function</b>	<b>Application</b>
 Light	To turn on the lamp.

Heating function	Application
 Conventional Cooking	To bake and roast food on one shelf position.
 Top Heat	To brown bread, cakes and pastries. To finish cooked dishes.
 Bottom Heat	To bake cakes with crispy bottom and to preserve food.
 Grill	To grill thin pieces of food and to toast bread.
 Fast Grilling	To grill thin pieces of food in large quantities and to toast bread.

## MAIN OVEN FUNCTIONS

Heating function	Application
 Light	To turn on the lamp.
 True Fan Cooking / AirFry	To bake on up to two shelf positions at the same time and to dry food. Set the temperature 20 - 40 °C lower than for Conventional Cooking. To fry food with less oil or without baking paper. For dishes like french fries or pizza.
 Pizza Function	To bake pizza. To make intensive browning and a crispy bottom.
 Conventional Cooking	To bake and roast food on one shelf position.
 Bottom Heat	To bake cakes with crispy bottom and to preserve food.



Heating function	Application
 Defrost	To defrost food (vegetables and fruit). The defrosting time depends on the amount and size of the frozen food.
 Moist Baking	This function is designed to save energy during cooking. When you use this function, the temperature in the cavity may differ from the set temperature. The heating power may be reduced. For more information refer to "Daily Use" chapter, Notes on: Moist Baking.
 Grill	To grill thin pieces of food and to toast bread.
 Turbo Grilling	To roast large meat joints or poultry with bones on one shelf position. To make gratins and to brown.

#### NOTES ON: MOIST BAKING

This function was used to comply with the energy efficiency class and ecodesign requirements according to EU 65/2014 and EU 66/2014. Tests according to EN 60350-1.





The oven door should be closed during cooking so that the function is not interrupted and the oven operates with the highest energy efficiency possible.

When you use this function the lamp automatically turns off.

For the cooking instructions refer to "Hints and tips" chapter, Moist Baking. For general energy saving recommendations refer to "Energy Efficiency" chapter, Energy Saving.

## CLOCK FUNCTIONS



### CLOCK FUNCTIONS

Clock function	Application
 Time of Day	To set, change or check the time of day. Only the top oven works without the set time.
 Duration	To set how long the oven works. The function works only for the main oven.
 End Time	To set when the oven turns off. The function works only for the main oven.
 Time Delay	To combine functions: Duration and End Time. The function works only for the main oven.
 Minute Minder	To set a countdown. This function has no effect on the operation of the oven. You can set this function at any time, also when the oven is off.





## HOW TO SET: CLOCK FUNCTIONS

### How to set: Time of Day







 - flashes when you connect the oven to the electrical supply, when there was a power cut or when the timer is not set.

 ,  - press to set the time.  
After approximately 5 sec., the flashing stops and the display shows the time.







### How to change: Time of Day

<b>Step 1</b>	 - press repeatedly to change the time of day.  - starts to flash.
<b>Step 2</b>	 ,  - press to set the time. After approximately 5 sec., the flashing stops and the display shows the time.

### How to set: Duration









<b>Step 1</b>	Set an oven function and the temperature.
<b>Step 2</b>	 - press repeatedly.  - starts to flash.
<b>Step 3</b>	 ,  - press to set the duration. The display shows:  .  - flashes when the set time ends. The signal sounds and the oven turns off.
<b>Step 4</b>	Press any button to stop the signal.
<b>Step 5</b>	Turn the knobs to the off position.

### How to set: End Time

<b>Step 1</b>	Set an oven function and the temperature.
<b>Step 2</b>	 - press repeatedly.  - starts to flash.
<b>Step 3</b>	 ,  - press to set the time. The display shows:  .  - flashes when the set time ends. The signal sounds and the oven turns off.
<b>Step 4</b>	Press any button to stop the signal.
<b>Step 5</b>	Turn the knobs to the off position.





---

### How to set: Time Delay

<b>Step 1</b>	Set an oven function and the temperature.
<b>Step 2</b>	 - press repeatedly.  - starts to flash.
<b>Step 3</b>	 ,  - press to set the time for: Duration.
<b>Step 4</b>	Press:  .
<b>Step 5</b>	 ,  - press to set the time for: End Time.
<b>Step 6</b>	Press:  At the set time the signal sounds and the oven turns off.
<b>Step 7</b>	Press any button to stop the signal.
<b>Step 8</b>	Turn the knobs to the off position.



---

### How to set: Minute Minder

<b>Step 1</b>	 - press repeatedly.  - starts to flash.
<b>Step 2</b>	 ,  - press to set the time. The function starts automatically after 5 sec. When the set time ends, the signal sounds.
<b>Step 3</b>	Press any button to stop the signal.
<b>Step 4</b>	Turn the knobs to the off position.

---

### How to cancel: Clock functions

<b>Step 1</b>	 - press repeatedly until the clock function symbol starts to flash.
<b>Step 2</b>	Press and hold:  The clock function turns off after few seconds.

---

## USING THE ACCESSORIES

---



**WARNING!** Refer to Safety chapters.

around the shelf prevents cookware from slipping of the shelf.

### INSERTING ACCESSORIES

A small indentation at the top increases safety. The indentations are also anti-tip devices. The high rim

**Wire shelf:**

Push the shelf between the guide bars of the shelf support.

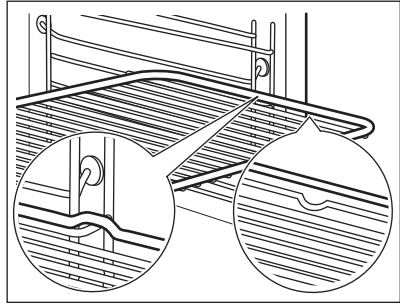
**Deep pan:**

Push the tray between the guide bars of the shelf support.

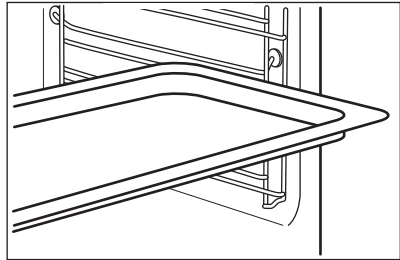
**Wire shelf, Deep pan:**

Push the tray between the guide bars of the shelf support and the wire shelf on the guide bars above.

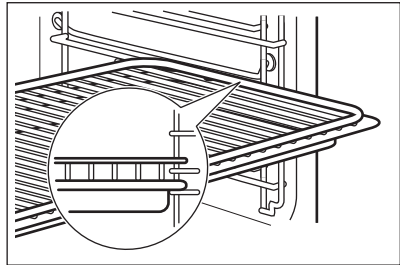
**AirFry -Wire shelf:**

Place the wire shelf on the third shelf position.

Place the baking tray on the second shelf position.

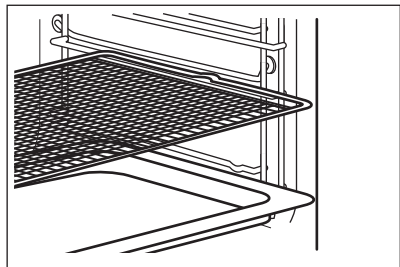
**TRIVET AND GRILL- / ROASTING PAN**

- |               |   |
|---------------|---|
| <b>Step 1</b> | Put the trivet into a deep pan.                     |
| <b>Step 2</b> | Put the deep pan on the recommended shelf position. |

**Roasting larger pieces of meat or poultry on one shelf position.**

Make sure the supports of the wire shelf point up.

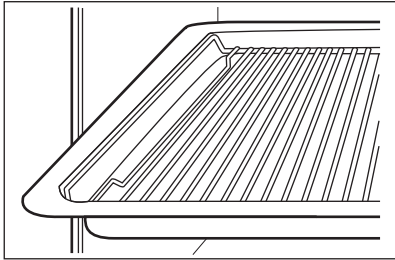

**Grilling and toasting thin pieces of food in large quantities.**

Make sure the supports of the wire shelf point down.

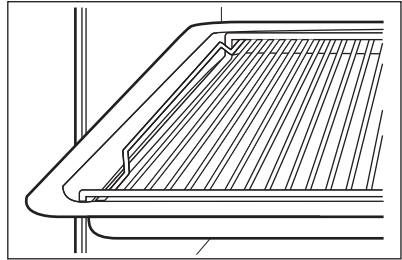

**ADDITIONAL FUNCTIONS**

**COOLING FAN**

When the oven operates, the cooling fan turns on automatically to keep the surfaces of the oven cool.

If you turn off the oven, the cooling fan can continue to operate until the oven cools down.

**HINTS AND TIPS**



Refer to Safety chapters.

**DOUBLE OVEN**

**Top oven**

The top oven is the smaller of the two ovens. It has 4 shelf positions. Use it to cook smaller quantities of food. It gives especially good results when used to cook fruitcakes, sweets and savoury flans or quiche.

**Main oven**

The main oven is the bigger of the two ovens. It is particularly suitable for cooking larger quantities of food.

**BAKING**

For the first baking, use the lower temperature. You can extend the baking time by 10 – 15 minutes if you bake cakes on more than one shelf position. Cakes and pastries at different heights do not always brown equally. There is no need to change the temperature setting if an unequal browning occurs. The differences equalize during baking. Trays in the oven can distort during baking. When the trays are cold again, the distortions disappear.

**TIPS ON BAKING**

Baking results	Possible cause	Remedy
The bottom of the cake is not baked sufficiently.	The shelf position is incorrect.	Put the cake on a lower shelf.

<b>Baking results</b>	<b>Possible cause</b>	<b>Remedy</b>
The cake sinks and becomes soggy or streaky.	The oven temperature is too high.	Next time set slightly lower oven temperature.
	The oven temperature is too high and the baking time is too short.	Next time set a longer baking time and lower oven temperature.
The cake is too dry.	The oven temperature is too low.	Next time set higher oven temperature.
	The baking time is too long.	Next time set shorter baking time.
The cake bakes unevenly.	The oven temperature is too high and the baking time is too short.	Next time set a longer baking time and lower oven temperature.
	The cake batter is not evenly distributed.	Next time spread the cake batter evenly on the baking tray.
The cake is not ready in the baking time specified in a recipe.	The oven temperature is too low.	Next time set a slightly higher oven temperature.

## **BAKING**





### **Top oven**





<b>Food</b>	<b>Temperature (°C)</b>	<b>Time (min)</b>	<b>Shelf position</b>
Biscuits	170 - 190	10 - 20	2
Bread	200 - 220	30 - 35	1
Bread rolls / buns	170-180	10 - 15	1
<b>Cakes:</b>			
- Small & Queen	160 - 170	18 - 25	2
- Sponges	160 - 175	20 - 30	2
- Victoria Sandwich	160 - 170	18 - 25	2
- Madeira	140 - 150	75 - 90	2
- Rich Fruit	140 - 150	120 - 150	2
- Gingerbread	140 - 150	75 - 90	2
- Meringues	90 - 100	150 - 180	2
- Flapjack	160 - 170	25 - 30	2
- Shortbread	130 - 150	45 - 65	2
<b>Casseroles:</b>			
- Beef / Lamb	160 - 170	150 - 180	1

Food	Temperature (°C)	Time (min)	Shelf position
- Chicken	160 - 180	75 - 90	1
Fish	170 - 190	20 - 30	2
Fish Pie (Potato Topped)	190 - 200	20 - 30	2
Fruit Pies, Crumbles	190 - 200	30 - 50	2
Milk Puddings	150 - 170	90 - 120	2
Pasta, Lasagne etc.	170 - 180	40 - 50	2
<b>Pastry:</b>			
- Choux	180 - 190	30 - 40	2
- Eclairs, Profiteroles	180 - 190	30 - 40	2
- Flaky / Puff Pies	210 - 220	30 - 40	2
<b>Shortcrust:</b>			
- Mince Pies	190 - 210	15 - 20	2
- Meat Pies	190 - 210	25 - 35	2
- Quiche, Tarts, Flans	180 - 200	25 - 50	2
Scones	220 - 230	8 - 12	2
Shepard's Pie	180 - 190	30 - 40	2
Souffles	190 - 200	20 - 30	2
<b>Vegetables:</b>			
- Baked Jacket Potatoes	180 - 190	60 - 90	2
- Roast Potatoes	180 - 190	60 - 90	2
<b>Yorkshire Pudding:</b>			
- Large	200 - 210	25 - 40	1
- Individual	210 - 220	15 - 25	1

## MOIST BAKING

For the best results follow suggestions listed in the table below.

		 (°C)		 (min)
Sweet rolls, 16 pieces	baking tray or dripping pan	180	2	40 - 50

		 (°C)		 (min)
Pizza, frozen, 0.35 kg	wire shelf	220	3	35 - 45
Swiss roll	baking tray or dripping pan	180	2	40 - 50
Brownie	baking tray or dripping pan	180	2	40 - 50
Soufflé, 6 pieces	ceramic ramekins on wire shelf	200	3	55 - 65
Sponge flan base	flan base tin on wire shelf	170	2	35 - 45
Victoria sandwich	baking dish on wire shelf	160	2	45 - 55
Poached fish, 0.3 kg	baking tray or dripping pan	180	3	30 - 40
Whole fish, 0.2 kg	baking tray or dripping pan	180	3	30 - 40
Fish fillet, 0.3 kg	pizza pan on wire shelf	180	3	40 - 50
Poached meat, 0.25 kg	baking tray or dripping pan	200	3	30 - 40
Shashlik, 0.5 kg	baking tray or dripping pan	180	2	30 - 40
Cookies, 16 pieces	baking tray or dripping pan	180	2	35 - 45
Macaroons, 24 pieces	baking tray or dripping pan	160	2	35 - 45
Muffins, 12 pieces	baking tray or dripping pan	180	2	40 - 50
Savory pastry, 20 pieces	baking tray or dripping pan	180	2	35 - 45
Short crust biscuits, 20 pieces	baking tray or dripping pan	150	2	35 - 45
Tartlets, 8 pieces	baking tray or dripping pan	180	2	35 - 45
Vegetables, poached, 0.4 kg	baking tray or dripping pan	180	3	40 - 50
Vegetarian omelette	pizza pan on wire shelf	200	3	40 - 50
Mediterranean vegetables, 0.7 kg	baking tray or dripping pan	180	4	45 - 55



## PIZZA SETTING

### Main oven

Food	Temperature (°C)	Time (min)	Shelf position
Apple Pie	160 - 180	50 - 60	3
Plate Tart	180 - 200	25 - 50	3
Quiches / Tarts	180 - 200	25 - 50	3

### TIPS ON ROASTING

Use heat-resistant ovenware.

Roast lean meat covered (you can use aluminium foil).

Roast large meat joints directly in the tray or on the wire shelf placed above the tray.

Put some water in the tray to prevent dripping fat from burning.

Turn the roast after 1/2 - 2/3 of the cooking time.

Roast meat and fish in large pieces (1 kg or more).

Baste meat joints with their own juice several times during roasting.

### ROASTING TABLES - MAIN OVEN

#### Beef

Food	Quantity	Temperature (°C)	Time (min)	Shelf position
Roast beef or fillet: rare, preheat the empty oven	per cm of thickness	190 - 200	5 - 6	2
Roast beef or fillet: medium, preheat the empty oven	per cm of thickness	180 - 190	6 - 8	2
Roast beef or fillet: well done, preheat the empty oven	per cm of thickness	170 - 180	8 - 10	2

#### Pork

Food	Quantity	Temperature (°C)	Time (min)	Shelf position
Shoulder, neck, ham	1 - 1.5	160 - 180	90 - 120	2
Pork chop	1 - 1.5	160 - 180	60 - 90	2
Meat loaf	0.75 - 1	160 - 170	45 - 60	2
Knuckle of pork (precooked)	0.75 - 1	150 - 170	90 - 120	2

## Veal

Food	Quantity	Temperature (°C)	Time (min)	Shelf position
Roast veal	1	160 - 180	90 - 120	2
Knuckle of veal	1.5 - 2	160 - 180	120 - 150	2

## Lamb

Food	Quantity	Temperature (°C)	Time (min)	Shelf position
Leg of lamb, roast lamb	1 - 1.5	150 - 170	75 - 120	2
Saddle of lamb	1 - 1.5	160 - 180	60 - 90	2

## Game

Food	Quantity	Temperature (°C)	Time (min)	Shelf position
Saddle of hare, leg of hare	Up to 1 kg	220 - 250	25 - 40	2
Loin of Game	1.5 - 2	210 - 220	75 - 105	1
Leg of Game	1.5 - 2	200 - 210	90 - 135	1

## Poultry

Food	Quantity	Temperature (°C)	Time (min)	Shelf position
Poultry pieces	0.2 - 0.25 each	200 - 220	35 - 50	3
Half chicken	0.4 - 0.5 each	190 - 210	35 - 50	3
Poultry	1 - 1.5	190 - 210	45 - 75	1
Duck	1.5 - 2	180 - 200	75 - 100	1
Goose	3.5 - 5	160 - 180	150 - 210	1
Turkey	2.5 - 3.5	160 - 180	105 - 150	1
Turkey	4 - 6	140 - 160	150 - 240	1

## Fish (steamed)

Food	Quantity	Temperature (°C)	Time (min)	Shelf position
Whole fish	1 - 1.5	210 - 220	40 - 60	1

## GRILLING

Always grill with the maximum temperature setting.

Set the shelf into the shelf position as recommended in the grilling table.

For grilling in the top oven adjust the shelf position to suit different thicknesses of food.

Always set the pan to collect the fat into the first shelf position.

Grill only flat pieces of meat or fish.

Always preheat the empty oven with the grill functions for 5 minutes.



**CAUTION!** Always grill with the oven door closed.

### Grilling and Fast Grilling - Top oven

Food	Time (min)
Bacon Rashers	5 - 6
Beefburgers	10 - 20
Chicken Joints	20 - 40
Lamb Chops	15 - 25
Pork Chops	20 - 25
Whole Fish, Trout / Makarel	10 - 12
Fillets, Plaice / Cod	4 - 6
Kebabs	12 - 18
Kidneys, Lamb / Pig	6 - 10
Sausages	20 - 30
Toasted Sandwiches	3 - 4
<b>Steaks:</b>	
- Rare	4 - 6
- Medium	6 - 8
- Well Done	12 - 15

### Grilling - Main oven

Food	Temperature (°C)	Time (min)		Shelf position
		1st side	2nd side	
Roast beef	210 - 230	30 - 40	30 - 40	2
Filet of beef	230	20 - 30	20 - 30	3
Back of pork	210 - 230	30 - 40	30 - 40	2
Back of veal	210 - 230	30 - 40	30 - 40	2
Back of lamb	210 - 230	25 - 35	20 - 25	3

Food	Temperature (°C)	Time (min)		Shelf position
		1st side	2nd side	
Whole Fish, 500 - 1000 g	210 - 230	15 - 30	15 - 30	3 / 4

### DEFROST - MAIN OVEN

Remove the food packaging and put the food on a plate.

Use the first shelf position from the bottom.

Do not cover the food with a bowl or a plate, as this can extend the defrost time.

Food	Quantity (kg)	Defrosting time (min)	Further defrosting time (min)	Comments
Chicken	1	100 - 140	20 - 30	Put the chicken on an upturned saucer in a big plate. Turn halfway through.
Meat	1	100 - 140	20 - 30	Turn halfway through.
Meat	0.5	90 - 120	20 - 30	Turn halfway through.
Trout	0.15	25 - 35	10 - 15	-
Strawberries	0.3	30 - 40	10 - 20	-
Butter	0.25	30 - 40	10 - 15	-
Cream	2 x 0.2	80 - 100	10 - 15	Whip the cream when still slightly frozen in places.
Gateau	1.4	60	60	-



### AIRFRY



Put the food directly on the tray.

Set the temperature to 180 - 220°C.

Use the function: AirFry.

The food does not have to be turned during cooking.

	
French fries, frozen	-
French fries, fresh	Apply 1 tablespoon of oil.
Potato wedges, frozen	-



	
Potato wedges, fresh	Apply 1 tablespoon of oil.
Potato patties	-
Croquettes	-
Spring rolls, frozen	-
Roasted vegetables, fresh	Apply 1 tablespoon of oil.

# CARE AND CLEANING



**WARNING!** Refer to Safety chapters.

## NOTES ON CLEANING

 <p><b>Cleaning Agents</b></p>	<p>Clean the front of the oven with a soft cloth with warm water and a mild detergent.</p> <p>Use a cleaning solution to clean metal surfaces.</p> <p>Clean stains with a mild detergent. Do not apply it on the catalytic surfaces.</p>
 <p><b>Everyday Use</b></p>	<p>Clean the cavity after each use. Fat accumulation or other residue may cause fire.</p> <p>Do not store the food in the oven for longer than 20 minutes. Dry the cavity with a soft cloth after each use.</p>
 <p><b>Accessories</b></p>	<p>Clean all accessories after each use and let them dry. Use a soft cloth with warm water and a mild detergent. Do not clean the accessories in a dishwasher.</p> <p>Do not clean the non-stick accessories using abrasive cleaner or sharp-edged objects.</p>

## HOW TO REMOVE: SHELF SUPPORTS

Remove the shelf supports to clean the oven.

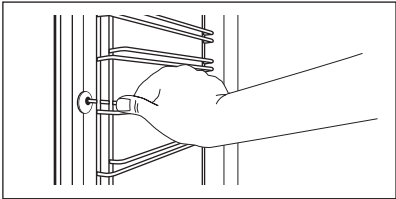
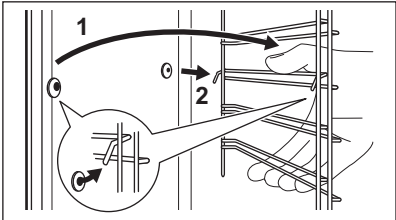
<p><b>Step 1</b></p>	<p>Turn off the oven and wait until it is cold.</p>	
<p><b>Step 2</b></p>	<p>Pull the front of the shelf support away from the side wall.</p>	
<p><b>Step 3</b></p>	<p>Pull the rear end of the shelf support away from the side wall and remove it.</p>	
<p><b>Step 4</b></p>	<p>Install the shelf supports in the opposite sequence.</p>	

## HOW TO USE: CATALYTIC CLEANING

Clean one oven at a time.



The cavity is coated with catalytic enamel. It absorbs fat during catalysis.

Spots or discolouration of the catalytic coating have no effect on the cleaning.

### Before the catalytic cleaning

Turn off the oven and wait until it is cold.	Remove all accessories and removable shelf supports.	Clean the oven floor and the inner door glass with warm water, soft cloth and mild detergent.
--	--	---

### Clean the oven with catalytic cleaning

Step 1	Step 2	Step 3	Step 4
To clean the top oven set the function:  To clean the main oven set the function: 	Set the maximum oven temperature. Duration: 1 h	After cleaning, turn the knob for the oven functions to the off position.	When the oven is cold, clean the cavity with a wet soft cloth.

## HOW TO REMOVE AND INSTALL: DOOR

You can remove the door and the internal glass panels to clean it. The number of glass panels is different for different models.



**CAUTION!** Carefully handle the glass, especially around the edges of the front panel. The glass can break.

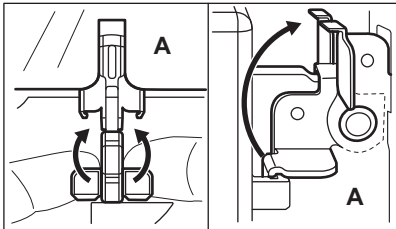

**WARNING!** The door is heavy.

<b>Step 1</b>	Fully open the door.	
<b>Step 2</b>	Lift and press the clamping levers (A) on the two door hinges.	

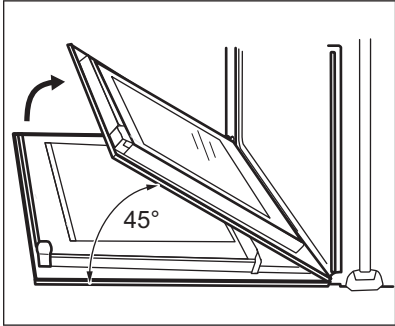
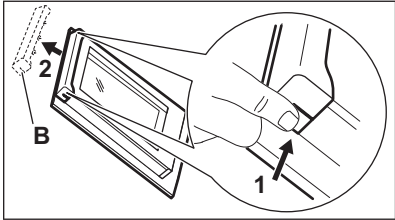
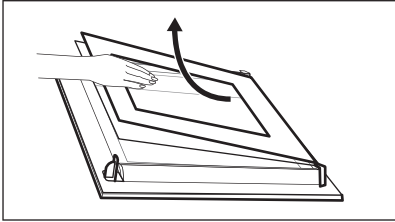
<p><b>Step 3</b></p>	<p>Close the oven door to the first opening position (approximately 45° angle). Hold the door with one hand on each side and pull it away from the oven at an upwards angle. Put the door with the outer side down on a soft cloth on a stable surface.</p>	
<p><b>Step 4</b></p>	<p>Hold the door trim (B) on the top edge of the door at the two sides and push inwards to release the clip seal.</p>	
<p><b>Step 5</b></p>	<p>Pull the door trim to the front to remove it.</p>	
<p><b>Step 6</b></p>	<p>Hold the door glass panels on their top edge one by one and pull them up out of the guide.</p>	
<p><b>Step 7</b></p>	<p>Clean the glass panel with water and soap. Dry the glass panel carefully. Do not clean the glass panels in the dishwasher.</p>	
<p><b>Step 8</b></p>	<p>After cleaning, do the above steps in the opposite sequence.</p>	
<p><b>Step 9</b></p>	<p>Install the smaller panel first, then the larger and the door. Make sure that the glasses are inserted in the correct position otherwise the surface of the door may overheat.</p>	

## HOW TO REPLACE: LAMP



**WARNING!** Risk of electric shock.  
The lamp can be hot.

### Before you replace the lamp:

Step 1	Step 2	Step 3
Turn off the oven. Wait until the oven is cold.	Disconnect the oven from the mains.	Put a cloth on the bottom of the cavity.

## Back lamp

<b>Step 1</b>	Turn the glass cover to remove it.
<b>Step 2</b>	Clean the glass cover.
<b>Step 3</b>	Replace the lamp with a suitable 300 °C heat-resistant lamp.
<b>Step 4</b>	Install the glass cover.

## TROUBLESHOOTING



**WARNING!** Refer to Safety chapters.

### WHAT TO DO IF...

In any cases not included in this table please contact with an Authorised Service Centre.

Problem	Check if...
The oven does not heat up.	The fuse is blown.

Problem	Check if...
The display shows "12.00".	There was a power cut. Set the time of day.
The lamp does not work.	The lamp is burnt out.

### SERVICE DATA

If you cannot find a solution to the problem yourself, contact your dealer or an Authorised Service Centre. The necessary data for the service centre is on the rating plate. The rating plate is on the front frame of the oven cavity. Do not remove the rating plate from the oven cavity.

**We recommend that you write the data here:**

Model (MOD.)	.....
Product number (PNC)	.....
Serial number (S.N.)	.....

## ENERGY EFFICIENCY

### PRODUCT INFORMATION AND PRODUCT INFORMATION SHEET\*

Supplier's name	Zanussi
Model identification	ZKCNA4K1 944171728 ZKCNA4X1 944171727
Energy Efficiency Index	Top oven: 106.8 Main oven: 95.1
Energy efficiency class	Top oven: A Main oven: A



Energy consumption with a standard load, conventional mode	Top oven: 0.78 kWh/cycle Main oven: 0.94 kWh/cycle	
Energy consumption with a standard load, fan-forced mode	Top oven: - Main oven: 0.77 kWh/cycle	
Number of cavities	2	
Heat source	Electricity	
Volume	Top oven: 42 l Main oven: 61 l	
Type of oven	Built-In Oven	
Mass	ZKCNA4K1	51.5 kg
	ZKCNA4X1	51.5 kg

\* For European Union according to EU Regulations 65/2014 and 66/2014.

For Republic of Belarus according to STB 2478-2017, Appendix G; STB 2477-2017, Annexes A and B.

For Ukraine according to 568/32020.

Energy efficiency class is not applicable for Russia.

EN 60350-1 - Household electric cooking appliances - Part 1: Ranges, ovens, steam ovens and grills - Methods for measuring performance.

## ENERGY SAVING



The oven has features which help you save energy during everyday cooking.

Make sure that the oven door is closed when the oven operates. Do not open the oven door too often during cooking. Keep the door gasket clean and make sure it is well fixed in its position.

Use metal cookware to improve energy saving.

When possible, do not preheat the oven before cooking.

Keep breaks between baking as short as possible when you prepare a few dishes at one time.

### Cooking with fan

When possible, use the cooking functions with fan to save energy.

## ENVIRONMENTAL CONCERNS

Recycle materials with the symbol . Put the packaging in relevant containers to recycle it. Help protect the environment and human health by recycling waste of electrical and electronic appliances. Do not dispose of appliances marked

## Residual heat

When the cooking duration is longer than 30 min, reduce the oven temperature to minimum 3 - 10 min before the end of cooking. The residual heat inside the oven will continue to cook.

Use the residual heat to warm up other dishes.

### Keep food warm

Choose the lowest possible temperature setting to use residual heat and keep a meal warm.

### Moist Baking

Function designed to save energy during cooking.

When you use this function the lamp is off.

with the symbol  with the household waste.

Return the product to your local recycling facility or contact your municipal office.





[WWW.ZANUSSI.COM/SHOP](http://WWW.ZANUSSI.COM/SHOP)



CE

867362720-A-092021

## Free Manuals Download Website

<http://myh66.com>

<http://usermanuals.us>

<http://www.somanuals.com>

<http://www.4manuals.cc>

<http://www.manual-lib.com>

<http://www.404manual.com>

<http://www.luxmanual.com>

<http://aubethermostatmanual.com>

Golf course search by state

<http://golfingnear.com>

Email search by domain

<http://emailbydomain.com>

Auto manuals search

<http://auto.somanuals.com>

TV manuals search

<http://tv.somanuals.com>