

**Installation / Servicing Instructions
& User Manual**



Sherborne GSL
Conventional Flue Gas Stove



Sherbone GSL Natural Gas With Logs Shown

PLEASE RETAIN THESE INSTRUCTIONS FOR FUTURE REFERENCE

THIS STOVE IS NOT SUITABLE FOR TIMBER FRAMED PROPERTIES.

Arada Ltd
North Mills Industrial Estate,
Bridport,
Dorset,
United Kingdom
DT6 3BE
Tel (+44) 01308 427234
Fax (+44) 01308 423441
www.arada.uk.com



FOR USE IN COUNTRIES
GB & IE

Gas Council ID Number

NG - 32-248-06

LPG - 32-248-07

Rev 3

Nov 2006

Part No. AFGS1095

CONTENTS

INSTALLATION

Safety Notices	3
General Information	3-4
Contents List & Part Identification	5
Important Notices	6
Statutory Requirements	6
Certification	6
Technical Data	7
Gas Fire Dimensions	7
Installing The Stove	7
Preparation of the stove	8
Stove Location	8
Shelf Clearances	9
Flue System	10
Fitting The Flue Spigot And Blanking Plate	11
Rear / Top Flue Options	11-12
Connecting The Gas Supply	13
Pressure Test Sequence	13
Fitting & Arranging The Coals	14-15
Fitting & Arranging The Logs NG	15-16
Fitting & Arranging The Logs LPG	16-17
Installation of Remote Control System	18-21
Commissioning The Stove	22
Fire Testing	22-23
Installation Check List	24

SERVICING

Replacement Of The Glass Frame	25-26
Burner & Valve Assembly Removal	26
Annual Service	27
Cleaning Outer Surfaces	27
Fault Diagnosis	28
Annual Service Record	29

USER INSTRUCTIONS

Lighting & Controlling The Fire	32-33
Cleaning Outer Surfaces	33
Operation of Remote Control	34-37
Important Notices	38
Statutory Requirements	38
Certification	38
Shelf Clearances	39

SPARE PARTS

General Components	40-42
Options & Accessories	43

GUARANTEE

Final Factory Checklist	46
-------------------------	----

References in this manual to British Standards and Statutory Regulations and Requirements apply only to the United Kingdom. For Ireland the rules in force must be used.

Before installation, check that the local distribution conditions, nature of the gas, pressure and the adjustment of the appliance are compatible.

The manual is an important part of the appliance and must by law be handed to the end user on completion of the installation.

SAFETY NOTICES

- Do not attempt to burn rubbish or any other material in this appliance.
- Do not use the appliance if the glass is cracked or broken.
- Do not make any unauthorised modifications to the appliance.
- It is recommended that the stove be guarded to protect the young and infirm using a fireguard complying with BS8423:2002.
- **Coal / Log set** -The coal/log set contains Refractory Ceramic Fibres (R.C.F), which are man made vitreous silicate fibres. Excessive exposure to these materials may cause temporary irritation to the eyes, skin and respiratory tract. Care must be taken when handling these items to ensure the release of dust particles is kept to a minimum. To ensure that the release of fibre from these items is kept to a minimum, during installation and servicing it is recommended that a vacuum cleaner fitted with H.E.P.A. filters is used to remove any dust, soot or any other debris accumulated in and around the appliance. This should be performed before and after the installation. It is recommended that any replacement item(s) are not broken up but sealed within a heavy duty polythene bag and clearly labelled "R.C.F. waste". This is not classified as "hazardous waste" and may be disposed of at a tipping site licensed for the disposal of industrial waste. Protective clothing is not required when handling these items but it is recommended that gloves are worn and normal hygiene rules are followed. Always wash your hands before eating or

drinking.

- In the event of a gas emergency, consult the telephone directory and ask for your local gas supplier.

Guide to manual handling

- Always obtain assistance when lifting the appliance.
- When lifting always keep your back straight. Bend your legs not your back.
- Avoid twisting at the waist. It is better to reposition your feet.
- Avoid upper body/top heavy bending. Do not lean forwards or sideways when handling the fire.
- Always grip with the palms of your hands. Do not use fingertips for support.
- Always keep the stove as close to the body as possible. This will minimise the cantilever action.
- Use gloves to provide additional grip.

GENERAL INFORMATION

1. General Note

All materials and equipment used in the installation of this stove should be fit for the purpose, be of suitable quality and workmanship and should comply with the applicable British Standards, building regulations and rules in force.

2. Ventilation

No purpose provided ventilation is normally required.

3. Flue Type

The stove is suitable for flue options with a minimum diameter of 127mm (5") and have a minimum effective height of 3 metres (10ft) see page 11 to 12.

4. Hazardous Materials

Asbestos, hazardous or any banned materials have **not** been and will **not** be included in this product.

INSTALLATION INSTRUCTIONS

5. Stove location

See installation instructions on page 7.

6. Packed details

For packed weight see packaging labels.

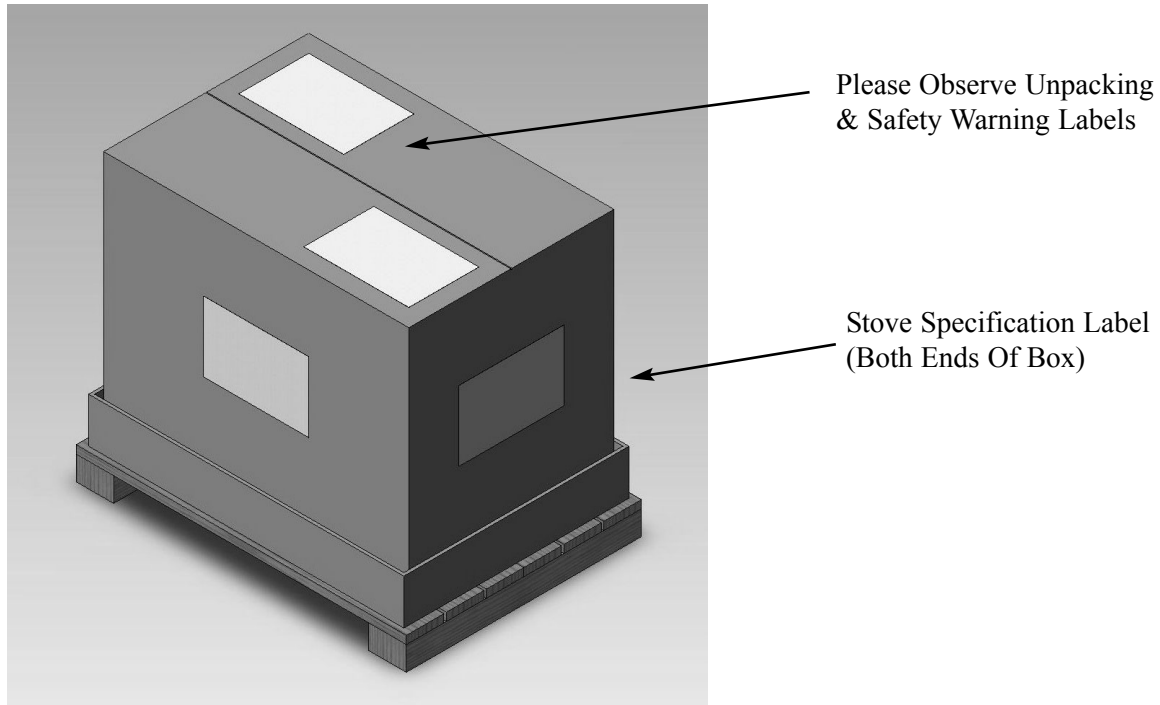

Fig 1

7. Unpacking note

When the stove is unpacked ensure no damage occurs if placed on the carpet as it can leave indentation marks.

For contents list see page 5.

8. Fit for purpose

All materials, appliances and equipment used should be fit for purpose, be of suitable quality and workmanship and should comply with the applicable British Standard.

9. Data Label Plate.

The data label plate is fixed to the underside of the valve bracket assembly, and can simply be swung in and out as required (see Fig 2a). Please observe the data, safety and warning labels attached to this plate. Do not remove this plate from the stove.



Fig 2a

INSTALLATION INSTRUCTIONS

CONTENTS LIST

Main Box	ALL TYPES	Packed Inside Stove	
STOVE ENGINE	•	Coal Set (NG & LPG) or	•
GLASS FRAME ASSEMBLY	•	Log Set (NG Only) or	•
DUMMY FUEL RETAINER	•	Log Set (LPG Only)	•
OPERATING INSTRUCTIONS	•		
CANOPY COVER PLATE	•		
CANOPY INFILL PIECE	•		
HOT PLATE (BLANKING)	•		
FLUE SPIGOT	•		
OUTER BODY & CANOPY	•		
FIRE DOORS	•		
VALVE COVER	•		
OPERATING TOOL	•		
GAS SERVICE TAP & GLASS SCREWS	•		



Flue Spigot



Hot Plate (Blanking)



Operating Tool

PART IDENTIFICATION

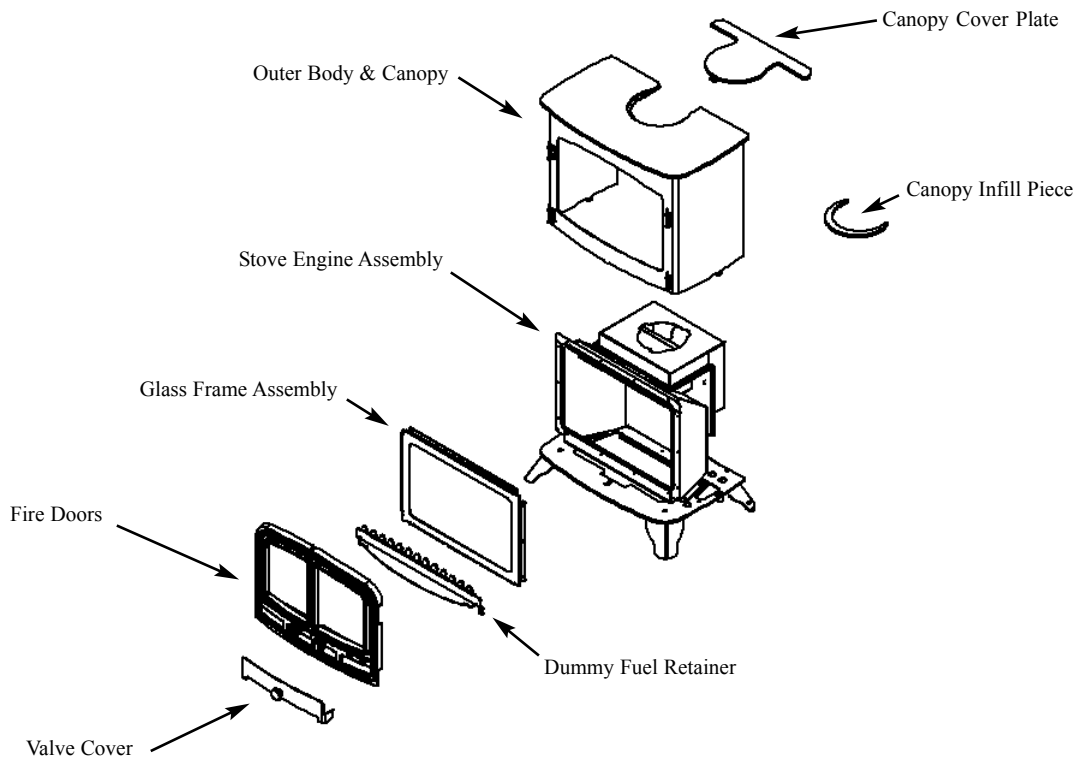

Fig 2b

INSTALLATION INSTRUCTIONS

IMPORTANT NOTICES

A qualified gas engineer must carry out the installation and servicing of this appliance in accordance with these instructions and in compliance with current Building Regulations. ***Such person must be a registered CORGI engineer.***

This appliance is designed to run on natural gas (NG) or liquid petroleum gas (LPG) depending on the model purchased. **Warning - Only use the appliance with the specified gas.**

The instructions must be read before use of the appliance.

Please note the following;

- Sealed components must not be interfered with.
- Servicing instructions and part identification numbers are given towards the back of the manual.
- Only use genuine **Arrow** parts for replacements.
- Ventilation, no purpose built ventilation is normally required, normal adventitious room ventilation being sufficient.
- Coal / log set, see safety notice on page 3 must be observed.

All surfaces except the control knobs are considered to be working surfaces.

Warning: Under no circumstances must the fire be operated if the glass is cracked or broken.

Warning: If it is known or suspected that an operational or ignition fault exists on the appliance, it must not be used until it has been investigated and corrected by a qualified gas engineer.

Warning: THIS GAS APPLIANCE MUST BE SERVICED EVERY TWELVE MONTHS BY A QUALIFIED GAS ENGINEER.

STATUTORY REQUIREMENTS

This product must be installed in accordance with the rules in force.

The current Gas Safety (Installation and Use) Regulations (as amended).

The Building Regulations for England and Wales 2000 ref Approved Document J 2002 edition (issued by the DTLR).

The Building Standards (Scotland) (Consolidation) Regulations.

Detailed recommendations are outlined in the current issue of the following British Standards:- BS5440 parts 1 and 2, BS5871 part 1 and BS6891.

Any Manufacturer's Instructions must not be taken as overriding statutory requirements.

CERTIFICATION

This appliance is CE certificated for performance and safety. Therefore, it is important that no alteration is made to the appliance.

Any alteration not approved by **Arada Ltd** will **invalidate the guarantee.**

INSTALLATION INSTRUCTIONS

TECHNICAL DATA		
Gas Type	Natural Gas	LPG
Gas Category	I _{2H}	I _{3P}
Supply Pressure	20mbar	37mbar
Injector	Bray 82/400	Bray 82/160
Max. Heat Setting		
Heat Input (gross)	6.1 kW	5.7kW
Gas Rate	0.55m ³ /hour	0.21m ³ /hour
Min. Heat Setting		
Heat Input (gross)	2.5 kW	2.5kW
Gas Rate	0.23m ³ /hour	0.09m ³ /hour
Efficiency Class	CLASS 2	CLASS 2
NOx Class	Unclassified	Unclassified
Country Of Use	AT,DK,ES,FI,GB,GR,IE,IT,NO,PT,SE	ES,FR,GB,GR,IE,IT,PT
Gas Council Id Number	32-248-06	32-248-07

Table 1

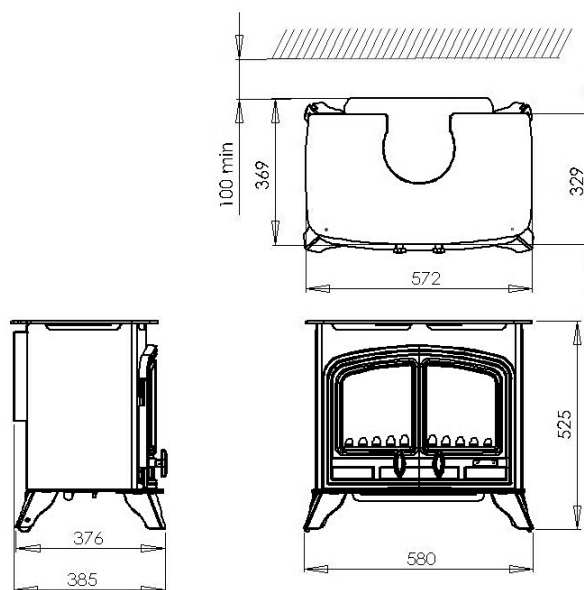

Fig. 3

INSTALLING THE STOVE

*A **CORGI** qualified gas engineer **MUST** install the stove in accordance with the following regulations and standards:-*

The Gas Safety (Installation and Use) Regulations current edition.

The Building Regulations for England and Wales 2000 ref; Approved Document J 2002 edition (issued by the DTLR).

The Building Standards (Scotland) (Consolidation) Regulations.

BS5440 parts 1 and 2 BS5871 And these Installation Instructions.

Warning: Failure to comply with the regulations, requirements, or these instructions will invalidate the guarantee and could have hazardous consequences.

IMPORTANT

Please note that in tight recesses the gas supply point may be inaccessible. Therefore it may be necessary to route the pipe for the gas supply before installing the stove into its recess.

INSTALLATION INSTRUCTIONS

PREPARATION OF THE STOVE

Prior to starting the installation and after removing the packaging, check that all the parts have been supplied to the contents list on page 5.

Carry out the following:-

Step 1 Remove outer casing (disengage locking levers see page 25, steps 1a /b, 2, 3, 4, and 5).

Step 2 Remove glass and retaining frame (see page 25 step 6).

Step 3 Remove the packaging from the coal / log set and cut the cable tie retaining 8mm olive and valve connection nut (located to the rear of valve assembly).

STOVE LOCATION

The appliance must not be installed in a room or space, which contains a bath or shower.

This stove is designed for use with either top or rear flue outlets and must be mounted on a hearth. The hearth must be strong enough to support the stove. For overall minimum hearth sizes see Fig.4a and Fig.4b.

To comply with current Building Regulations the stove must stand on a fireproof hearth which has a minimum upper fireproof layer of 12mm non-combustible material. The rear of the stove is to be 100mm from the wall which must be of a non-combustible material.

The hearth must not be capable of inadvertent covering by a carpet or rug. This should be achieved by either:

- The hearth being 50mm above the level of the room floor.
- or •a 50mm high fender or kerb being fixed around the edge of the hearth.

Ensure the hearth is level and flat.

Do not place any combustible material including clothing, furniture and furnishings (including curtains) within 1 metre of the stove.

For details of combustible and non-combustible shelf clearances see graphs 1 and 2 on page 9.

The rear edge of the canopy cover must be fitted flush against the wall.

It is acceptable to place the stove against plaster board on dry line property.

The stove must not be installed against a combustible wall.

The stove must never be positioned closer than 100mm to any rear wall see Fig. 4a

The stove is **NOT** suitable for houses with **timber frame construction.**

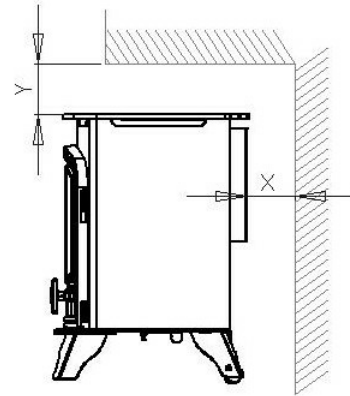

X=100mm Minimum Distance
Y=See Graph 1 & 2

Fig. 4a

Side Clearances

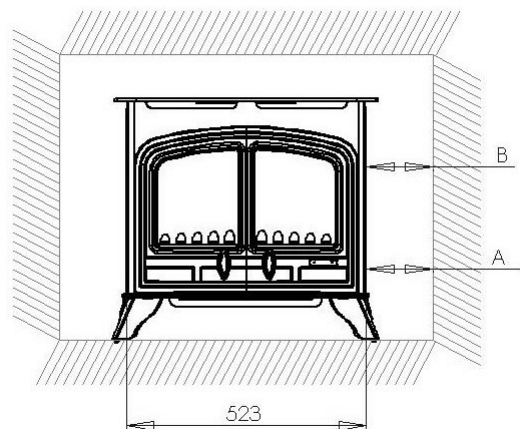

A=100mm Minimum Per Side To A Non Combustible Wall.
B=200mm Minimum Per Side To A Combustible Wall.

Fig. 4b

SHELF CLEARANCES

Combustible shelf clearances

The minimum height from the extreme top surface of the stove to the underside of a shelf or other projection made of wood or any other **combustible material** is shown on graph 1.

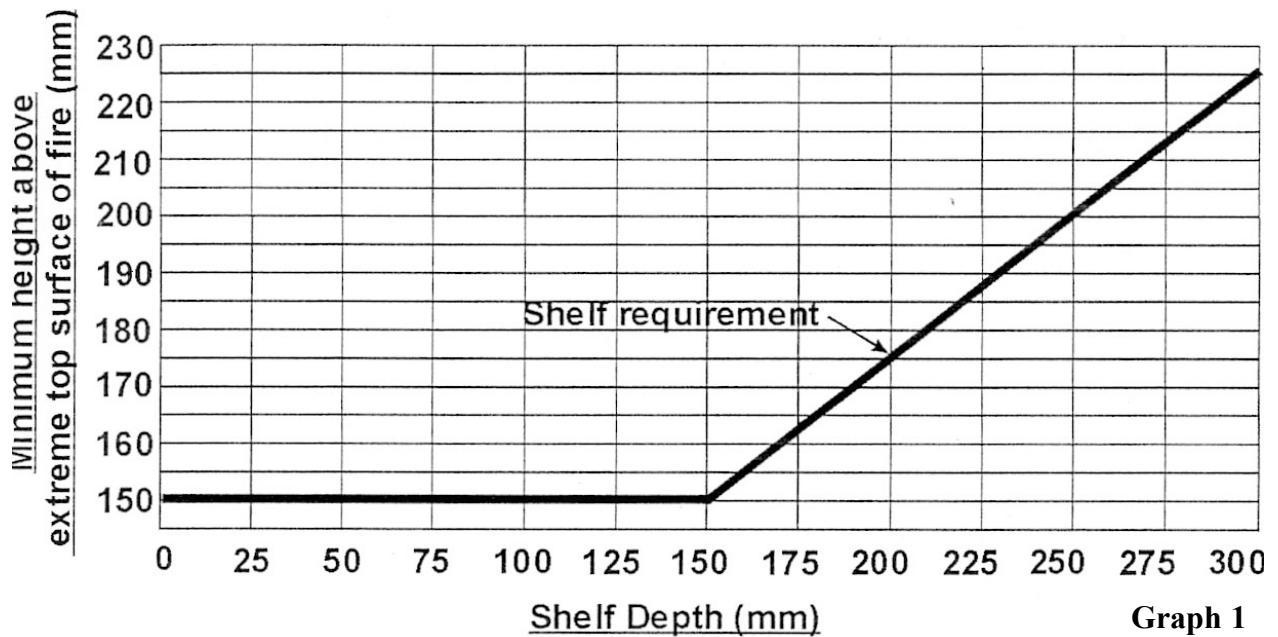

Non-Combustible shelf clearances

The minimum height from the extreme top surface of the stove to the underside of a shelf or other projection made of **non-combustible material** is shown on graph 2.

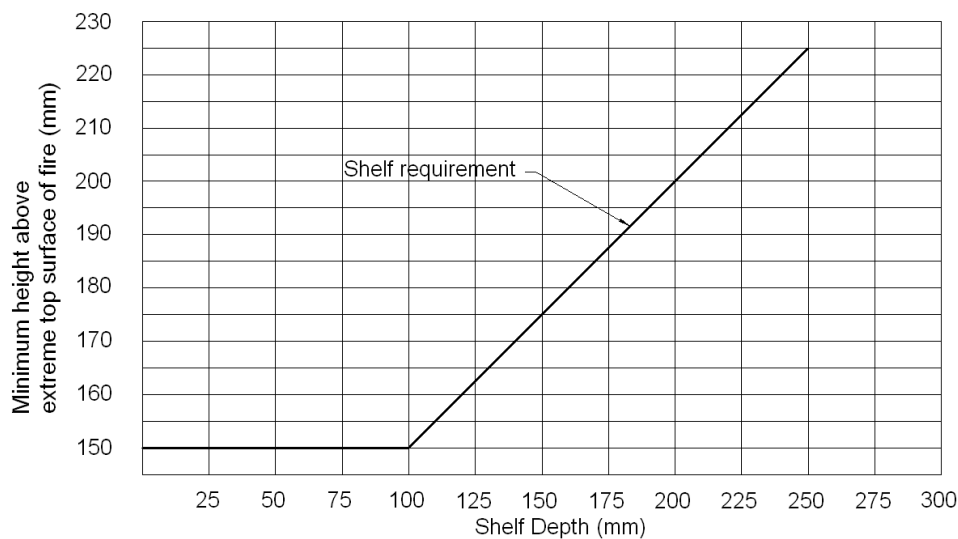

WARNING: No shelf is to be used with a top flued appliance, where it has to pass through a shelf.

INSTALLATION INSTRUCTIONS

FLUE SYSTEM

The stove must be connected to a suitable and efficient flue that provides a good updraught to safely take the products of combustion (fumes) from the stove outlet to the outside air. To ensure a good updraught it is important that the flue gases are kept warm and that the flue size suits the stove.

The termination of the outlet at the top of the flue also needs to comply with the Building Regulations. The minimum effective height of the chimney must be at least 3 metres and when warm the flue draught should be between 0.05 and 6mb (0.5mm to 6mm water gauge).

The stove requires a minimum flue size of 125mm (5 inches). The stove can be fitted to a sound conventional solid fuel burning chimney system (Class 1) provided it is swept.

If the chimney is not sound or the chimney has an internal flue size greater than 225mm (9 inches) diameter or 200 x 200mm square, a 125mm (5 inches) diameter stainless steel flexible flue liner complying with BS 715 should be installed in the flue.

If a new chimney is being provided it should fully comply with the relevant Building Regulation Requirements and BS 5440: Part 1. Suitable types of chimney include the following.

- Masonry chimney built with clay or concrete liners, or a chimney block system meeting Building Regulations.
- Precast concrete gas flue block complying with BS 1289: Part 1

Factory made metal chimney complying with BS 715 (often called "Twin wall Class 2 chimney") or Factory made metal insulated chimney complying with BS 4543: Part 2 (often called "Class 1 pre-fabricated metal chimney"). To ensure the flue gases are kept warm an insulated chimney system should be used if the chimney is positioned outside the building.

The flue must be terminated with a suitable chimney pot or cowl and the chimney or flue shall be swept prior to installation unless the chimney is clean and unobstructed.

The flue and chimney installation must be carefully checked by a competent person before fitting the stove to ensure it is suitable and will work safely. The flue must also pass a Flue flow test (smoke test) to BS 5440: Part 1.

**For advice on flues and chimneys contact;
NACE (National Association of Chimney Engineer): telephone 0800 0924019
www.nace.org.uk**

**or
NACS (National Association of Chimney Sweeps): telephone 01785 811732
www.chimneyworks.co.uk**

INSTALLATION INSTRUCTIONS

FITTING THE FLUE SPIGOT AND BLANKING PLATE

Note: Blanking plate fitted to top flue outlet for packing

The gas stove is designed so that the flue can be fitted to either the top or the rear of the appliance.

Fit the flue spigot and blanking plate for either top or rear flue outlet in accordance with figure 5a or 5b (below).



Fig. 5a



Fig. 5b

Lock the blanking hot plate in place by rotating anti-clockwise and tighten by tapping gently with a block of wood and mallet. Fit the spigot to the unused opening in the same way. The units are sealed by the attached gaskets.

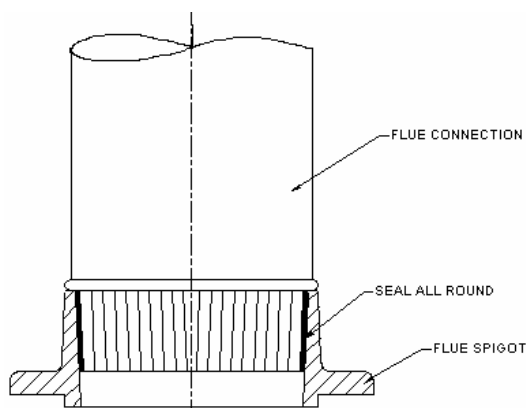

Fig 5c

CLOSURE PLATES

If a closure plate is used for sealing off the chimney or fireplace opening it can be made of metal (e.g. aluminium sheet) or fireplace board (see figure 6 a/b/c on page 12) however provision must be made

for checking for debris build up. Closure plates must be sealed to the chimney or fireplace opening with fire cement, fireproof rope or other suitable high temperature mastic.

REAR FLUE OPTIONS

Open Hearth (See Figure 6-a page 12)

Fit and seal a 'T' section (with debris /soot collector) directly into the flue spigot. Ensure it passes through the closure plate by at least 102mm (4").

The maximum horizontal section allowed is 350mm.

Provide a minimum vertical height of 600mm of flue from the height of the rear flue outlet.

Closure Plate (See Figure 6b page 12)

Connect the flue spigot to the rear outlet then connect a flue extension to the spigot up to a maximum length of 350mm.

Fit and seal the closure plate into the fireplace opening.

Position the stove so the flue extension passes through the hole in the closure plate by at least 50mm.

Ensure all joints are sealed with fire cement or a suitable high temperature sealant.

TOP FLUE OPTIONS

Top Flue (See Figure 6c page 12)

Provide a minimum vertical height of 600mm of flue measured from the top of the appliance. Position the stove, with flue spigot in place, into position under the flue and seal the spigot/flue connection with fire cement or a suitable high temperature sealant.

It is recommended that a smoke test is performed inside the stove to ensure that adequate flue draw is evident after making the flue connection

INSTALLATION INSTRUCTIONS

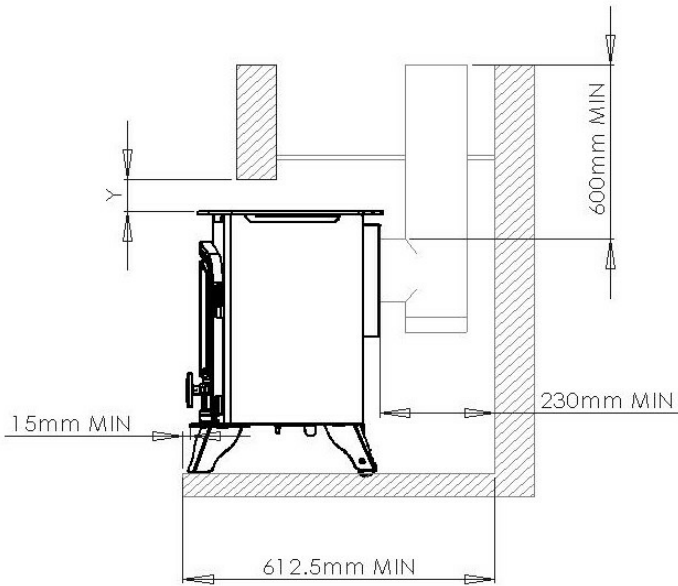

Y=See Graph 1

Fig. 6a

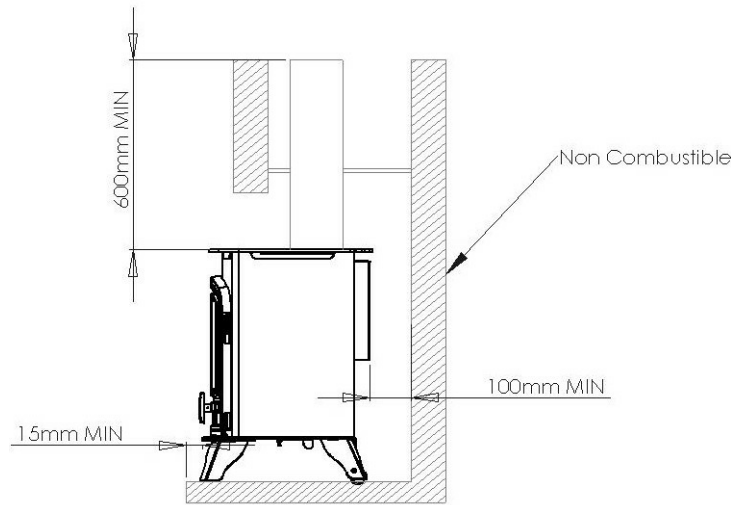

Fig. 6c.

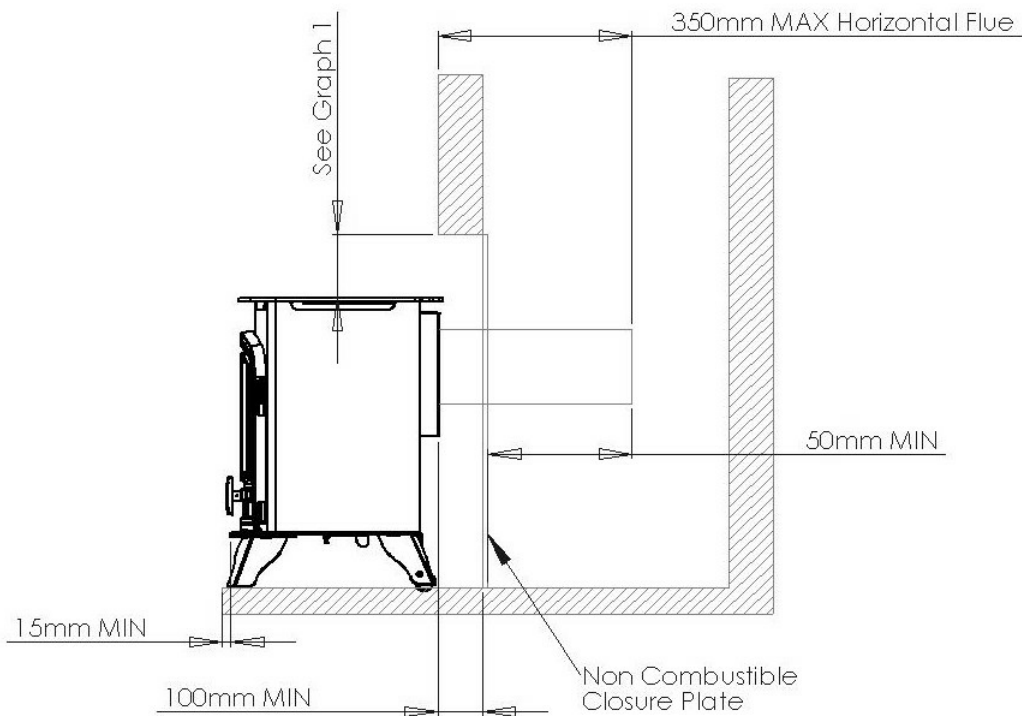

Fig. 6b

CONNECTING THE GAS SUPPLY

Once the stove is in place it is then possible to connect the gas supply. The gas supply point is located centrally at the rear (as show in fig.7) and should be connected in accordance with the following requirements.

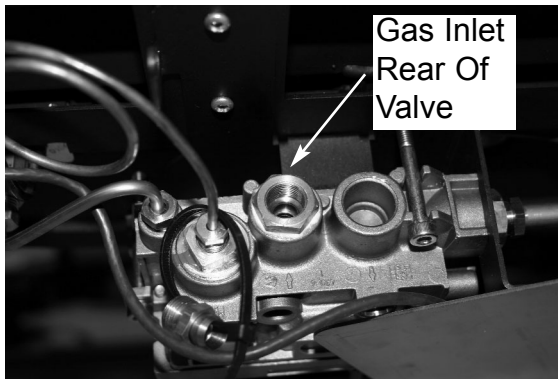

Fig. 7

Check that the appliance is suitable for the gas supply; refer to data labels on packaging and/or the stove data label for the gas type.

The gas installation must be in accordance with the current issue of BS6891. Gas supply pressure at the fire should be **20mbar for natural gas & 37mbar for LPG.**

The gas supply should be connected with the 12mm fitting and olive supplied with the stove.

A maximum pipe run of 1.5 meters (or 5 feet) should be adhered to. Copper tubing may be used **provided a distance of 25mm is maintained** between pipe-work and any surface of the stove.

The gas service tap (supplied) should be fitted adjacent to the fireplace to enable safe removal of the appliance for servicing. After fitting the supply, operate the gas tap (supplied) and check all joints up to the termination of the supply pipe for gas tightness using a soap/water solution and the pressure drop method.

To check the pressure to the burner. This must be carried out with all other gas appliances operating at maximum. To check the pressure to the burner it is necessary to ignite the appliance and set to 'high rate'. (See pressure test sequence).

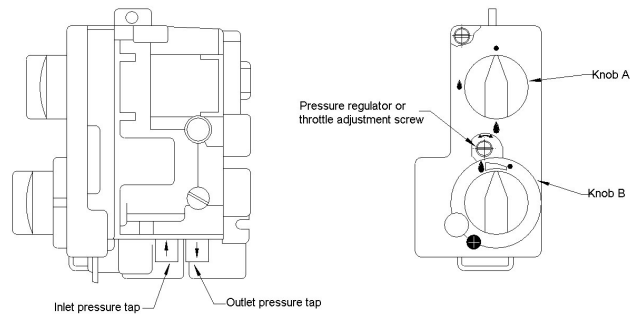

Fig. 8

PRESSURE TEST SEQUENCE

Controls are located at the base of the stove below the ash lip.

Ensure supply is isolated and the valve is in the off position

Step 1. Remove the valve control cover by unscrewing the pozi screw located by knob B and lever the retaining tab to the side of knob A.

Step 2. Locate the outlet pressure tap and unscrew approximately half a turn anti-clockwise with a small flat bladed screw driver. Connect a pressure gauge to the outlet pressure tap.

Step 3. Re-connect the supply and light stove. (see lighting and controlling the stove section in the users instructions section of this manual). Turn to high setting. Read pressure gauge, setting to be -
20 mbar for Natural Gas or
37 mbar for LPG

Step 4. If any adjustment is required, use the brass screw located between knob B and knob A on the front of the valve, and adjust accordingly to the indication symbol marked upon the valve body.

Step 5. Turn off stove and isolate the supply.

Step 6. Disconnect manometer and re-tighten the outlet pressure tap screw. **Do not over tighten.**

Step 7 Replace the valve control cover.

INSTALLATION INSTRUCTIONS

FITTING AND ARRANGING THE COALS (Both NG & LPG versions)

Ensure the appliance is cold

Safety Notice - Please see SAFETY NOTICES ref. Coal / Log sets page 3.

Warning: The coals and the coal matrix are fragile ensure they are handled carefully.

Ensure location is correct. Do not force the matrix into position. If the coals and/or the coal matrix are damaged they must be replaced with genuine Arrow parts.

Warning: An incorrect coal layout may cause soot to build up inside the stove and therefore invalidate the guarantee.

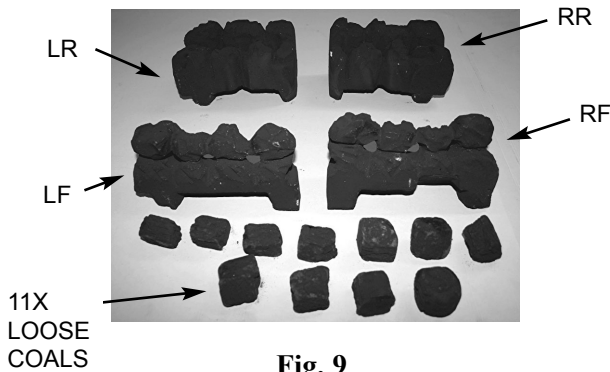

Fig. 9

How to arrange the coals

(see Fig 9 for part identification)

1) Place the 2x larger base matrices at the rear of the burner. These are labelled LR (left rear) & RR (right rear). These should be positioned so that the slots in the matrices sit over the rear upright fold of the burner top plate.

2) Next position the 2x smaller base matrices between the rear matrices and the front of the fire-box. These matrices are labelled, LF (left front) & RF (right front). The RF matrix has a notch in the front to avoid the pilot assembly. The arrangement should look like Fig 10a.

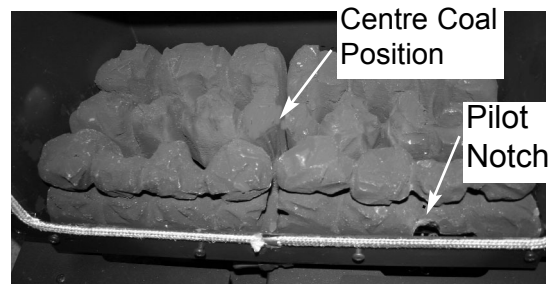

Fig. 10a

3) Now position one of the loose coals into the centre of the stove ensuring that it is placed into the centre cutout and when in position, this coal will be resting upon the four corners of the base matrices. See Fig. 10a & b.

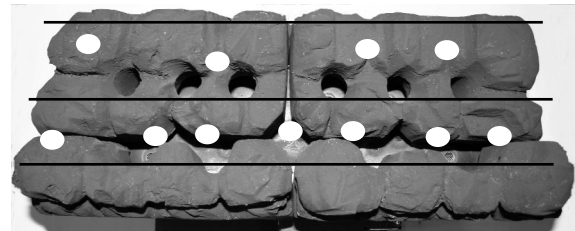

Fig. 10b

Plan View Of Base Matrices - White Dots Indicate Loose Coal Positions / Cut outs.

4) Next, take 6x coals and place along the front row of the base matrices, 3x to the left of the centre coal and 3x to the right of the centre coal. Observe the cutout positions within the matrices as shown in Fig. 10b & 10c.



Fig. 10c

5) Take the remaining 4x coals and place along the upper edge to the base matrices. Again, place the coals into the areas shown in Fig 10b. The coal set layout is now complete and should look like Fig 10d & 10e.

INSTALLATION INSTRUCTIONS



Fig. 10d



Fig. 10e

Plan View Of Coal Set Layout.

Note - Ensure that the pilot light is visible through the slot in the front right base matrix and that the pilot flame is not impinged.

FITTING AND ARRANGING THE LOGS (NG ONLY)

Ensure the appliance is cold

Safety Notice - Please see **SAFETY NOTICES** ref. Coal / Log set, page 3.

Warning: The logs and matrix are fragile, ensure they are handled carefully.

Ensure location is correct. Do not force the matrix into position. If any of the logs and/or rear matrix is damaged, they must be replaced with genuine Arrow parts.

Warning: An incorrect log layout may cause soot to build up inside the stove and therefore invalidate the guarantee.

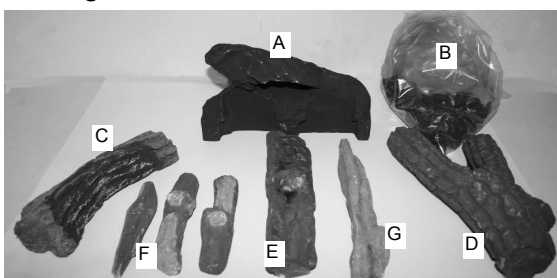

Fig. 11

Key For Contents To NG Log Set -

A = Rear log matrix (black in colour)

B = Loose Embers (bagged)

C = Curved Log

D = Y Shape Log

E = Central Log (Knotted Lump Protruding)

F = 3x Small Twigs

G = 1x Large Twig

How to arrange the logs

1) Position the rear log matrix in the centre at the rear of the burner. The base of the matrix should slot down behind the burner. See Fig. 12a.

2) Lay the Y shape log to the right hand side of the burner. Ensure that the Y open section is upper most and is resting onto the cutout flat area to the right of the rear log matrix. The base should be approximately 30mm from the front of the stove window opening. See Fig 12a.

3) Take the curved log and place this to the left hand side of the burner. Make sure that the base of this log is again approx. 30mm from the front of the stove and the upper end of the log is resting on the grooved notch within the rear log matrix. See Fig 12a. Note, there should be a gap between both side logs when resting correctly on the rear matrix.

4) Next scatter the loose embers onto the burner area. *Take care not to obstruct the pilot assembly.*

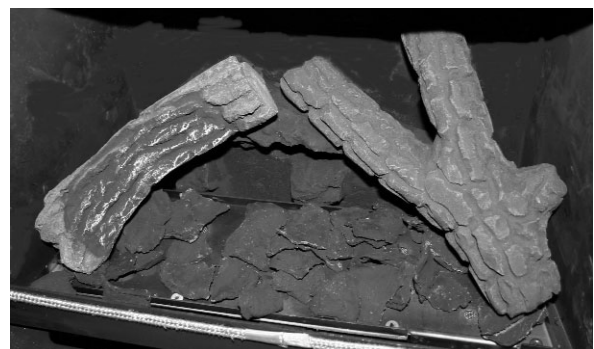

Fig. 12a

5) Lay the central log, from the centre front of the burner to the rear of the stove. Sitting the upper portion of the central log onto the edge of the

INSTALLATION INSTRUCTIONS

upper corner of the curved left hand log. See Fig. 12b. Note, the top resting position of the central log is angled to the left.



Fig. 12b

6) Place 2x smaller twigs as shown in Fig. 12b. Note, the bottom of the twigs rest between the stove body and burner. Take care with the right hand twig to avoid impinging upon the pilot assembly.

7) Take the remaining small twig and large twig and place as shown in Fig 12c. The log layout is now correct.



Fig. 12c

FITTING AND ARRANGING THE LOGS (LPG ONLY)

Ensure the appliance is cold

Safety Notice - Please see **SAFETY NOTICES** ref. Coal / Log set, page 3.

Warning: The logs and matrix are fragile, ensure they are handled carefully.

Ensure location is correct. Do not force the matrix into position. If any of the logs and/or rear matrix is damaged, they must be replaced with genuine Arrow parts.

Warning: An incorrect log layout may cause soot to build up inside the stove and therefore invalidate the guarantee.

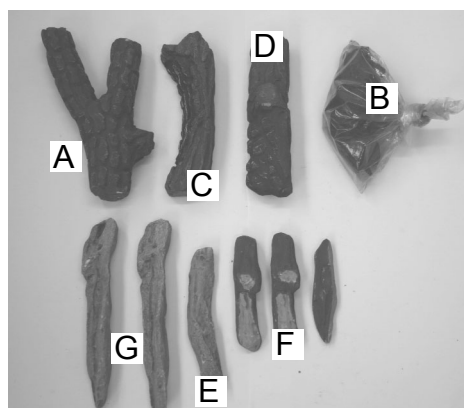

Fig 13

Key For Contents To LPG Log Set -

A = Y Shaped Rear Log

B = Loose Embers

C = Curved Log

D = Straight Log

E = 1x Medium Twig

F = 3x Small Twig

G = 2x Large Twigs

How to arrange the logs

1) Position the Y shaped log across the rear of the burner, standing up against the rear of the firebox and behind the burner. See Fig. 14a.

2) Scatter the loose embers over the burner, taking care not to cover the pilot assembly. See Fig. 14a.

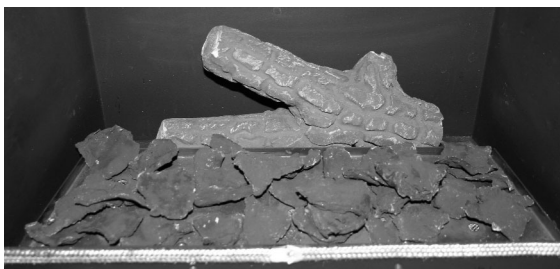

Fig. 14a

3) Place the curved log to the left hand side of the firebox, rest the top of this log onto the top of the Y shaped open end of the rear log. Take the straight log and position this to the right hand side of the firebox, again rest the rear of this log onto the rear Y shaped log, opposite end to the curved log. Note, rest both fronts of these end logs against the front corners of the burner. See Fig. 14b.



Fig. 14b

4) Next place the 2x large twigs into the layout with the base of each twig central about the stove opening and placed to the front of the stove. The tops of these twigs radiate out from the base to form a vee shape and rest upon the rear Y log (left hand) and straight log (right hand). The medium twig is placed between the large twigs as shown in Fig. 14c.



Fig. 14c

5) The remaining 3X small twigs are placed as shown in Fig. 14d. The LPG log layout is now complete.



Fig. 14d

INSTALLATION INSTRUCTIONS

NOTE: If the optional remote control system has been ordered with the stove and is not fitted please proceed.

FOR A MANUAL STOVE (WITHOUT REMOTE CONTROL) PROCEED TO PAGE 22.

INSTALLATION OF REMOTE CONTROL SYSTEM

Important

- A corgi registered gas engineer must carry out the installation of the remote control system

PARTS LIST

- 1 Motor
- 2 Ultrasonic Receiver
- 3 Remote control handset
- 4 Wiring Harness (Multiblock end to receiver, spade connections to motor/micro switch)
- 5 Micro-switch
- 6 AA/LR6 1.5v Batteries (4x) & 9V-6F22 9v Battery (1) Supplied (Not Shown)

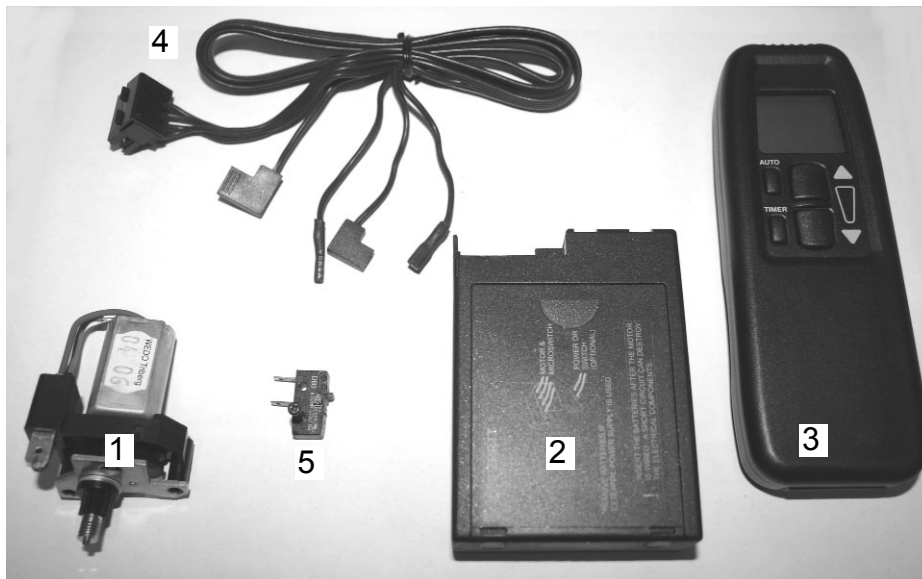

Fig. 15

Technical data

Ambient temperature range	Remote and receiver	max. 140deg F / 60deg C
	Connecting cable	max. 356deg F / 180deg C
Batteries	Quality Alkaline	Handset: 1x9V Block Receiver: 4x1.5V AA

INSTALLATION INSTRUCTIONS

ASSEMBLE MOTOR

1) Remove the front cover from the valve. This is done by unscrewing the small pozi screw, located by knob B. Unclip the right hand side of the cover located to the side of knob A. See Fig. 16a & b.

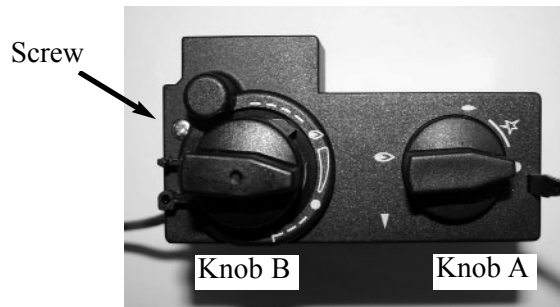

Fig. 16a

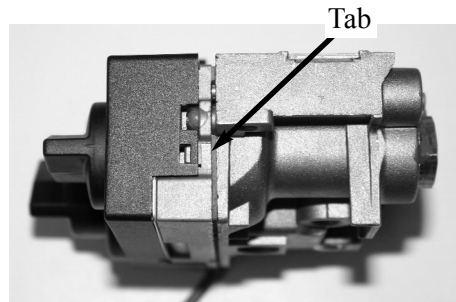

Fig. 16b

2) Remove the cover and dispose of the spacer tube fitted with the screw.

3) Position the motor onto the location lugs (arrow X) and engage the drive gear onto knob B (arrow Y).

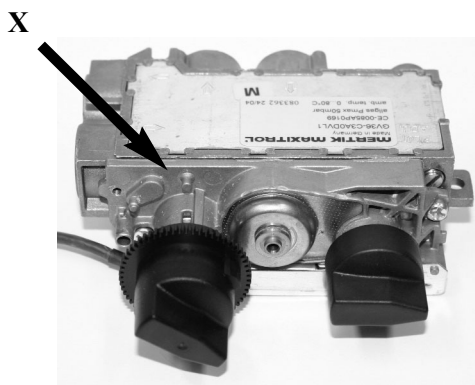

Fig. 16c



Fig. 16d

4) Replace valve cover, ensure clip is located before the pozi screw is tightened. Do not over-tighten the screw as this may effect the operation of the control.

5) Take the micro switch and fix to the front of the valve cover with the self tapping screw provided. Switch is located onto the lug moulded within the valve cover, next to knob B. See Fig. 16e.

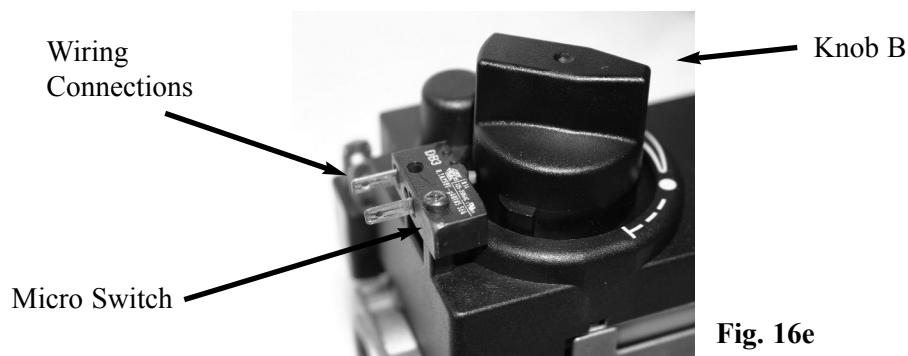

Fig. 16e

INSTALLATION INSTRUCTIONS

ASSEMBLE RECEIVER

Important

The remote system is intended for use with original Arrow parts only.

1) Carefully push the multi block connector on to the connection within the receiver unit as shown in Fig. 17a. This connector can only fit one way, so ensure the slot in the receiver's board lines up with the moulding within the multi block connection.

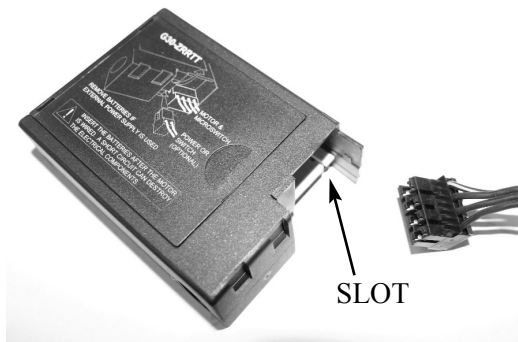

Fig. 17a

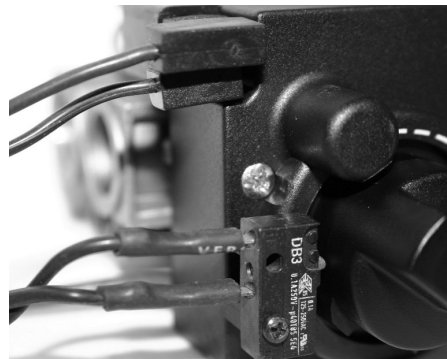

Fig. 17b

2) Next, connect the angled spade connectors to the motor, note there are two different sized connectors and these can only be fitted to the appropriate sized spade tab. The remaining narrow spade connectors fit to the spade tabs on the micro switch. These are not handed, see Fig. 17b.

3) Place the double sided adhesive tape to the underside of the receiver unit. Slide back the cover and insert the 4x AA/LR6 1.5v batteries into unit, observing the correct polarity as marked on the unit. Re-place cover. Fig. 17c.

CAUTION! Ensure the batteries are inserted AFTER the motor is wired. A short circuit can destroy the electrical components.

4) Position the receiver unit, as shown in Fig. 17d onto the space provided on the valve bracket. Affix the underside of the unit with the double sided tape. Take care to route the wiring harness away from any hot parts and do not obstruct the valve controls. The receiver unit works by ultrasonic so ensure that the receiver's round grill is facing to the front of the stove.



Fig. 17c



Fig. 17d

INSTALLATION INSTRUCTIONS

HANDSET

1) Insert the battery (9v) into Remote control. Slide back the battery compartment cover, insert and connect a suitable battery and replace the cover.

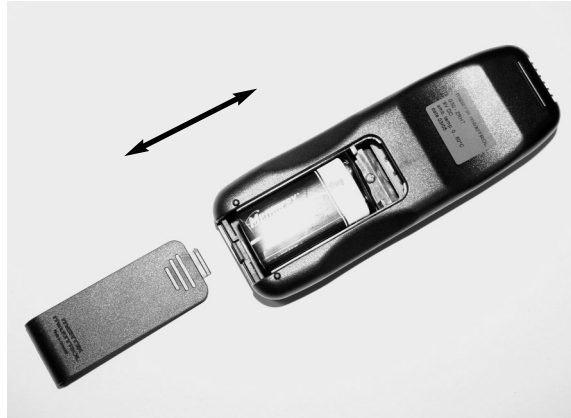

Fig. 18

2) The remote is now ready to use. In the event of battery failure the flame height can still be adjusted manually using the knob B on the valve.

NOTE

Please note, the placement of the Remote control (temperature sensor) is important to assure proper temperature regulation. Please refer to user instructions.

INSTALLATION INSTRUCTIONS

COMMISSIONING THE STOVE

Refit the glass/glass frame assembly.

Refit the outer body and secure with the locking levers.

If horizontal flue is used fit the canopy cover plate. (See page 25 step 1a.)

If top flue is used locate the infill plate (See page 25 step 1b).

Follow the lighting instructions (See pages 32 & 33), light the pilot and check:-

1. The operation of the control
2. The cross lighting of the burner
3. All gas settings can be achieved

FIRE TESTING

Flame failure device testing

Step 1 Ignite the appliance in accordance with page and run for 60 seconds.

Step 2 Turn the appliance off to extinguish the pilot, listen for a snap at the control valve. This should occur within 60 seconds of the pilot flame being extinguished. The snap sound will be the magnet disengaging, and thus shutting off the flow of gas to the pilot and burner.

Spillage Test

Step 1. Close all doors and windows.

Step 2 Light the appliance and set to the high rate.

Step 3. Allow fire to warm up for 10 minutes.

Step 4. Position the smoke match at the back of the fire centrally beneath the rear diverter as shown in **Fig 19a**.

All of the smoke should be drawn into the fire. If this does not occur the appliance must be disconnected and the flue checked.

Step 5. If there is an extractor fan in any room, this must be turned on and any doors between it and the fire left open, repeat the spillage test.

Repeated operation of the spillage monitoring system whereby the OSD (oxygen sensing device/spillage monitoring system). If there is a problem with the ODS pilot going out after the stove has operated satisfactorily, this indicates a possible flue draw problem. Seek expert advice from a qualified engineer.

Warning: The spillage monitoring system, consists of a special oxygen sensing device (OSD) pilot and is a safety feature required by law. It must not be adjusted or put out of action by the installer. If the spillage monitoring system or any of its parts are to be replaced, only original manufacturers parts must be used.

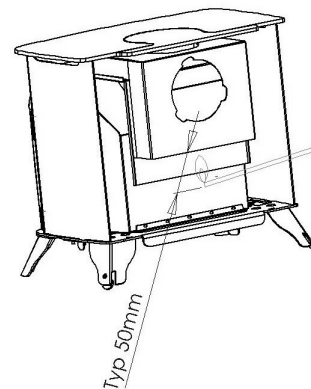

Fig. 19a

Note: The fire will give off non-toxic fumes when first used. This is perfectly normal it will disappear after the first few hours. Once the spillage test is complete open windows and doors to ventilate the area.

SELF LEVELING REAR FEET

Once the stove is in position on the hearth, working on the rear legs, simply loosen the pozi screw and rotate the inner 'pear' shaped adjuster to touch the hearth. Re-tighten the screw and repeat for the other side.

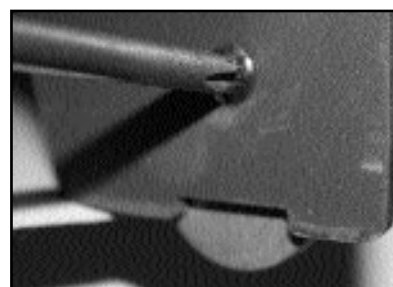

Fig. 19b

Advise the end user

1. That there will be an odour from the stove when the stove is first lit and is non-toxic. It is advised that the stove is initially run with the room well ventilated to disperse the fumes.
2. How the valve controls operate and how to light the pilot.
3. Advise about leaving pilot on.
4. That the stove is fitted with two safety devices, one cuts off the stove if for any reason the gas supply is turned off - A flame failure device. The second will cut the stove off if there is inadequate flue draw for example a blockage in the chimney. If this occurs the stove should not be re-lit until the stove and flue have been checked by a qualified gas engineer.
5. To read the users instructions before using the stove.
6. The stove must never be used if the glass is cracked or broken.
7. Explain that the working surfaces of the stove will get hot and that no combustible materials including clothing, furniture and furnishings (including curtains) must not be placed within one metre of the stove.

Leave the instruction manual with the end user

INSTALLATION INSTRUCTIONS

CHECKLIST

Hearths, Fireplaces, Flues and chimneys

This checklist is to ensure hearths, fireplaces, flues and chimneys are satisfactory, and to show what you have done to comply with the requirements of The Building Regulations 2000 Approved Document J 2002.

1. Building address, where work has been carried out.....	
2. Identification of hearth, fireplace chimney or flue	
3. Firing capability: solid fuel/gas/.	
4. Intended type of appliance. State model and output.	
5. Ventilation provisions for the appliance: State type and area of permanently open vents.	
6. Chimney or flue construction a) State the type or make and whether new or existing. b) internal flue size (and equivalent height, where calculated - natural draught gas appliances only). c) If clay or concrete flue liners used confirm that they are correctly jointed with socket end uppermost and state jointing materials used. d) If an existing chimney has been refurbished with a new liner, type or make of liner fitted. e) Details of flue outlet terminal and diagram reference. Outlet Details: Complies with: f) Number and angle of bends. g) Provision for cleaning and recommended frequency.	
7. Hearth. Form of construction. New or existing?	
8. Inspection and testing after completion Tests carried out by: Tests and results Flue inspection visual sweeping coring ball smoke Appliance (where included) spillage	
I/we the undersigned confirm that the above details are correct. In my opinion, these works comply with the relevant requirements in Part J of Schedule 1 to the Building regulations.	
Print name and title.....Profession.....	
Capacity.....Telephone.....	
Address.....Postcode.....	
Signed.....Date.....	
Registered membership of...(e.g. CORGI, OFTEC, HETAS, NACE, NACS).....	

REPLACEMENT OF THE GLASS

IMPORTANT

When refitting the glass frame ensure the original screws are used. Longer screws may foul the coal / log set placement.

Ensure the appliance is cold.

Step 1a For rear flue appliance remove canopy cover plate.

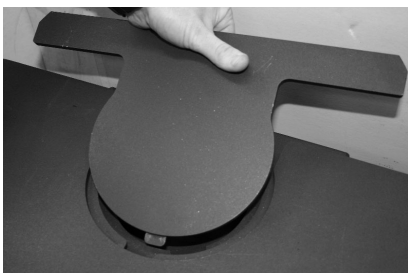

Step 1b For top flue appliance remove infill piece.



Step 2 Remove the fire doors
Open and lift off hinges (held shut by magnet).

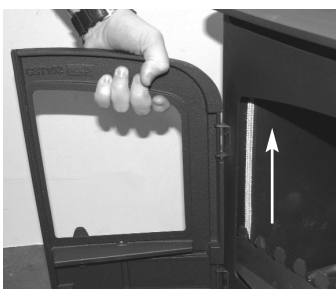

Step 3 Disengage locking levers, one per side.

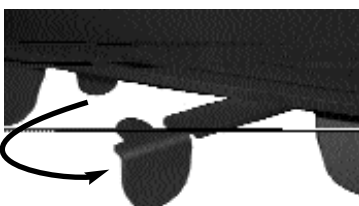

Step 4 Lift the body and canopy off the chassis.
Refer to “guide to manual handling” on page 3.

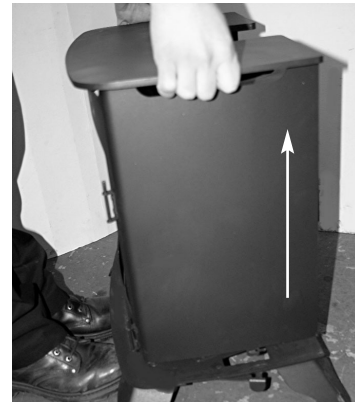

Step 5 Remove dummy fuel retainer (2 screws)
If glass is broken, suitable gloves must be worn for protection.



Step 6 Remove glass and glass frame.

- Remove any loose glass
- Be aware of any glass that will become loose when removing the frame.
- Loosen but do not remove the four screws at the base of the frame.
- Remove all but one of the top centre retaining screws.



- Remove the remaining top screw. The frame and glass will now be loose and can be removed.
- The frame has slots at the base to ease removal.
- Remove any remaining loose glass.

SERVICING

Step 7 Clear inside of stove of any debris.

Step 8 To re-assemble reverse this procedure. See initial note on page 25.

Note: When relocating the body and canopy assembly ensure the front location tab is engaged in the chassis.

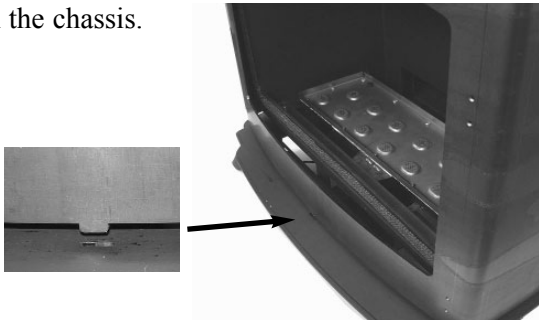

BURNER AND VALVE ASSEMBLY REMOVAL

Please note! When handling the burner assembly be aware of the sharp points of the self tapping screws on the underside

Ensure the appliance is cold.

Step 1 Isolate the gas supply from the stove

Step 2 Disconnect the supply inlet pipe by releasing the pipe nut at the rear of the valve, see page 13.

Step 3 Remove the outer body of the stove (Ref Page 25).

Step 4 Remove the dummy fuel retainer and then the glass frame assembly (Ref Page 25).

Step 5 Remove the coals or logs.

Step 6 Remove the base coal matrix (four pieces) Take care not to damage the matrix, (Page 14).

Step 7 Remove the two self tapping screws each side of the injector as shown below.

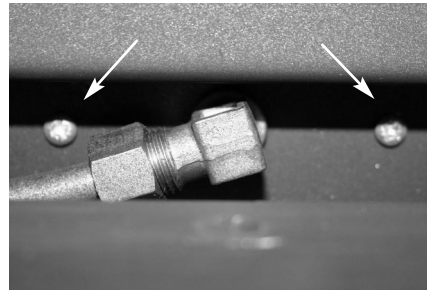

The burner assembly may now be removed. Slide back off the injector and lift the burner assembly upwards from the rear while at the same time pivoting it towards you. Take care not to damage the injector.

Step 8 To remove the valve assembly undo the 3x Pozi M5 screws, located within the fire box (2x to the front of the burner and 1x centrally to the rear of the burner), lift upwards from the rear while at the same time pivoting it towards you. Carefully guide the controls through aperture clear of the stove.

After replacement of burner assembly, ensure that a check on the gas tightness of any new joint is carried out.

ANNUAL SERVICE

THIS GAS APPLIANCE MUST BE SERVICED EVERY TWELVE MONTHS BY A QUALIFIED GAS ENGINEER.

See "SAFETY NOTICES" ref coal set page 3.

Ensure the appliance is cold.

Step 1 Isolate the gas supply from the stove.

Step 2 Remove the outer body of the stove.

Step 3 Remove the glass.

Important: If the glass is broken or cracked or the glass gasket is damaged they must be replaced before the stove is used.

Step 4 Carefully remove and clean the loose coal / logs set of any soot deposits using a soft brush.

Step 5 Clean the firebox of any soot deposits using a soft brush.

Step 6 Carefully lift out and clean the base coal matrix. **Important:** If any of the ceramic components are damaged they must be replaced with original Aarrow parts.

Step 7 Clean the burner top and surrounding areas with a vacuum cleaner.(See safety notices on page 3).

Step 8 Inspect the pilot assembly to ensure that it is clean, unobstructed and in good working order.

Step 9 Looking into the flue from inside the stove check that it is clear of any debris or obstructions.

Step 10 Check the system for gas soundness.

Step 11 Check the ignition of the pilot and with the pilot turned off check that the flame failure system is working.

Step 12 Relocate the base coal matrix (4x piece).

Step 13 Relocate and position the loose coals or re-assembly the log set.

Step 14 Light the pilot and check the operation of the stove and the flame picture.

Step 15 Relocate the glass frame assembly, ensuring all the screws are replaced and secure. (Use original screws only.)

Step 16 Refit the dummy fuel retainer.(2x screws)

Step 17 Relocate the outer body of the stove.

Step 18 If the stove is rear flued proceed to fit the top flue cover plate into the canopy cutout ensuring the front tab is located under the canopy (see page 25, step 1a). Place the valve cover in front of the control valve.

Step 19 If the stove is top flued, proceed to fit the top flue infill piece (see page 25, step 1b). Place the valve cover in front of the control valve.

CLEANING OUTER SURFACES

It is best cleaned using a soft brush. Do not allow moisture to remain on the top while cold or surface rust may occur.

SERVICING

FAULT DIAGNOSIS

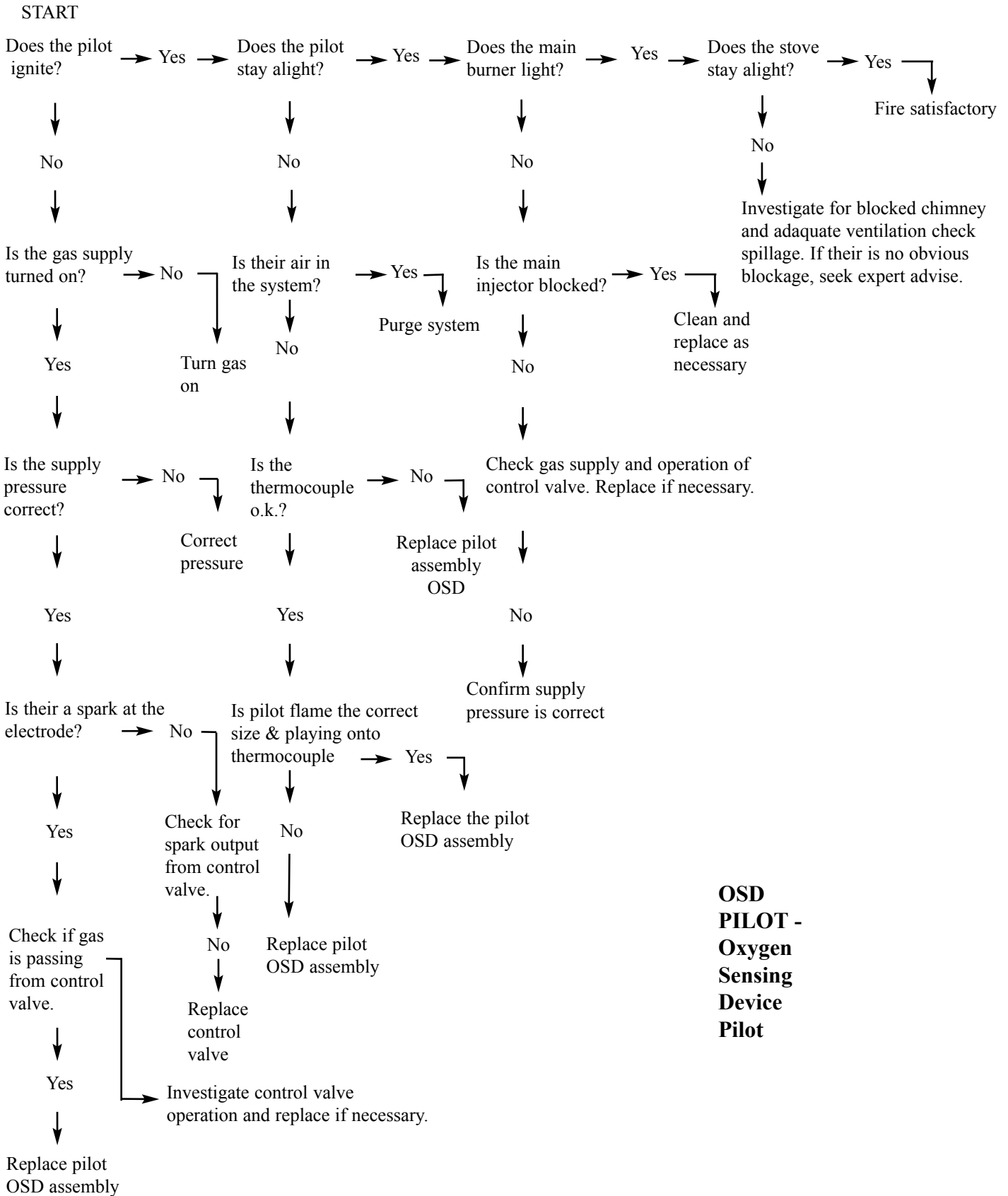

ANNUAL SERVICE RECORD

Date of Visit	Company	Work Carried Out	Signature

Should you have any questions about your Sherborne GSL Gas Stove that is not covered in this manual please contact your Aarrow stove retailer.

Please keep all repair receipts safely.

Please ensure you have this manual available when an engineer visits as they will complete the service record chart.

ADDITIONAL NOTES



USER INSTRUCTIONS

USER INSTRUCTIONS

LIGHTING & CONTROLLING THE FIRE

Under no circumstances must the stove be operated if the glass is cracked or broken.

It is recommended that if the property is occupied the pilot be left on permanently. This will keep the stove and its components, including the ceramic coal / log set in a warmer state and assist the lighting of the burner. This in turn will reduce the chance of condensation and any associated problems.

If the property is left unoccupied for a long period of time the pilot must be switched off.

The controls are located beneath the ash lip at the base of the appliance. (See Fig.20a)

Note: Ensure burner control knob “B” is set at maximum and pilot control knob “A” is set in the off position. (See Fig. 20e)



Fig. 20a

Step 1. To ignite the pilot. First locate the pilot, it can be viewed in the front right hand side of the coal / log bed. Open doors and look downward through the glass window 50mm from the right hand side. To ignite the pilot turn control knob “A” anti-clockwise towards the spark position (See Fig. 20b) until it stops, press down and hold in for 5 seconds. (only pilot gas flows) .



Fig. 20b

Continue pressing down while turning knob “A” anti-clockwise to the small flame position, this will activate the piezo and light the pilot. Continue to hold down for a further 10 seconds after pilot has been lit, if the pilot does not stay lit repeat the procedure. When the pilot stays lit release knob “A” at the small flame position. (See Fig. 20c).

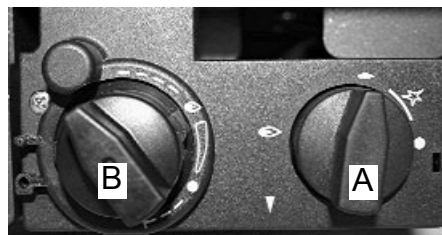

Fig. 20c

NOTE! This lighting procedure does not have to be carried out every time the stove is used provided the pilot is left alight.

Step 2. To ignite burner

With the pilot lit turn control knob “A” to the large flame position and release. This will ignite the burner. (See Fig. 20d) On initial lighting or after a period of non use, there may be a short delay of 5 or 6 seconds to allow the burner chamber to fill with gas, before ignition takes place, this is perfectly normal.

To achieve the desired setting turn knob “B” to suit. Turn anti-clockwise to increase input and clockwise to decrease input.

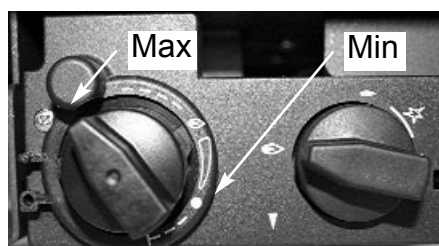

Fig. 20d

NOTE! Between the Max and Min burner settings an infinitely variable flame height is achievable.

NOTE! Condensation may form on the glass panel during initial ignition of the burner, this is normal and due to the moisture in the atmosphere. This will disappear within 10 minutes of firing.

Step 3. To turn the stove and the pilot off **completely**, turn control knob “A” to the small flame setting, (pilot flame) depress and turn to off position, then release (See Fig. 20e)

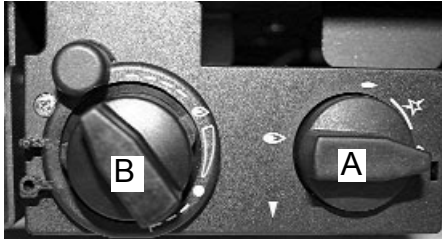

Fig. 20e

Important, when control knob “A” is turned to the off position a built-in safety lock is activated which will prevent you from turning the control knob for 60 seconds.

Do not try to force the control, wait the 60 seconds.

NOTE! If the pilot flame is extinguished either intentionally or unintentionally, no attempt to re-light the gas should be until at least 3 minutes has elapsed.

NOTE! During the initial firing, the stove will give off non-toxic fumes when first used. This is perfectly normal and will disappear after the first few hours. It is advised to ventilate the room by opening doors and windows to prevent irritation to user.

NOTE! The fire doors can be opened during operation, for a greater viewing area to the flame picture, this does not effect the operational performance of the stove.

NOTE! During operation, the metal surface of the stove will be **HOT**, a operating tool is supplied with the stove and can be used to open the doors if required. See fig. 20f.



Fig. 20f

CLEANING OUTER SURFACES

It is best cleaned using a soft brush.

Do not allow moisture to remain on the stove while cold or surface rust may occur.

USER INSTRUCTIONS

NOTE: ONLY FOR STOVES WITH REMOTE CONTROL SYSTEM

TEMPERATURE DISPLAY REMOTE CONTROL

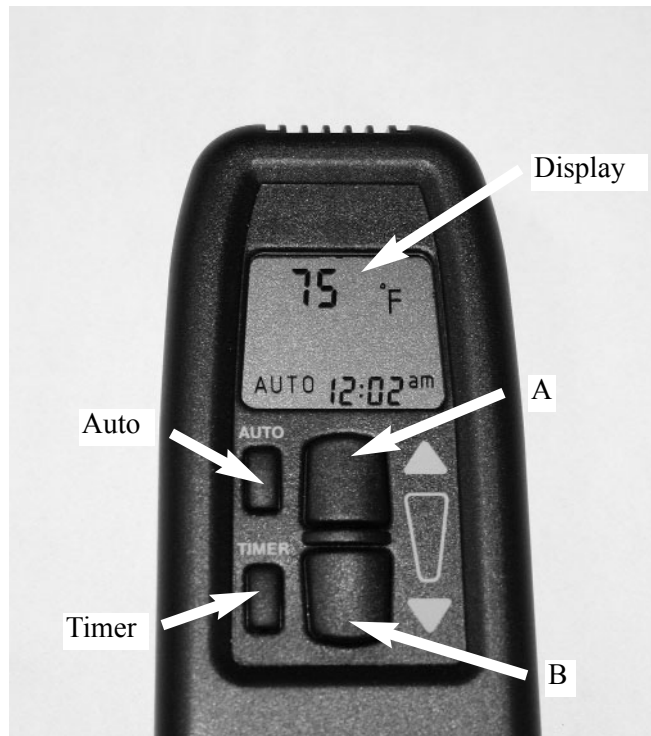

Fig. 21

When the pilot has been lit, the remote transmitter can be used to control the flame height or to turn the main burner on or off.

Aim the remote transmitter at the control valve and press the top button 'A' to increase the input or the bottom button 'B' to decrease the input. Short tapping of either button allows incremental change in flame height.

Note! In the event of battery failure the flame height can still be adjusted manually

Caution!

It is recommended to turn the combination control either to the off or pilot position if the appliance is left unattended for long periods (e.g vacation) so that it cannot receive commands from the remote transmitter. Exercise caution when leaving the appliance unattended, and in exceptional cases sound waves from sources other than the transmitter can cause changes in flame height adjustment.

THERMOSTAT AND TIMER REMOTE CONTROL TRANSMITTER FUNCTIONS

Set the display (from *C/24 h to *F/12 h and vice versa)

- After connecting the battery or by simultaneously pressing **AUTO** and **TIMER**, the display flashes you are in set mode.
- From set mode, press **AUTO** to switch from *F (and 12 hour clock) to *C (and 24 hour clock)
- The display will automatically return to manual mode after some time, but you may immediately return to manual mode by depressing the **TIMER** button.

Set the current time

- After connecting the battery or by simultaneously pressing **AUTO** and **TIMER**, the display flashes you are in set mode.
- From set mode, press (**A**) to set the hour and (**B**) to set the minute.
- Wait or press **TIMER** to return to “manual” mode.

Programming the Desired Set Temperature

- Press **AUTO** until the display flashes
- Press (**A**) or (**B**) to the desired temperature.
- Wait or press **AUTO** to switch to automatic mode.
- A sensor in the remote control measures the room temperature. The controller compares the room temperature with the set temperature and sends a signal to the receiver to turn the gas valve motor, which adjusts the flame height accordingly.

Programming the Timer

- Press **TIMER** until P1* (start) flashes (period 1. heating cycle on).
- Set the time for the beginning of the first heating period by pressing (**A**) for hour and (**B**) for minute.
- Press **TIMER** again P1* disappears and the symbol P1) (finish) appears.
- Set the time for the end of the first heating period.
- Press **TIMER** again to set the second heating period P2* (start) and P2) (finish).
- Store both heating periods by pressing **TIMER** again.

NOTE! If only one heating period is desired, programme the same time for P2* and P2) as for P1* and P1).

USER INSTRUCTIONS

Manual Mode (Man in Display) for Manual Flame Height Adjustment

- Press (**A**) to turn on the fire (main burner) or to increase flame height.
- Press (**B**) to decrease the flame or to turn down to pilot.
- To incrementally increase or decrease the flame height lightly tap either the (**A**) or (**B**) button.
- The “Send” symbol appears in the upper left corner of the display when either large button is depressed.
- The **LED** of the remote control receiver flashes when knob B of the valve reaches its end stops.

Automatic Mode (AUTO in display) for Temperature Control

- Briefly press **AUTO**. The set temperature will appear briefly before the display reverts to the room temperature.

Timer Mode (TIMER in display)

- During heating periods P1* and P2* the temperature is continued in the same manner as in automatic mode.
- When the timer programme turns to P1) or P2) (heating cycle off) the motor will turn the valve to pilot and there is no temperature control. This minimizes battery consumption.
- You may press **AUTO** to verify the set - temperature and then press **TIMER** to return to timer mode.
- You may press either the (**A**) or (**B**) button from any mode for manual override.
- To prolong battery life we recommend switching the remote control to manual mode and turning the fire to pilot with the (**B**) button before turning the appliance off. If the remote control is left in automatic or timer mode, the batteries will continue to be used when the appliance is off.

Changing the Battery

- If **BATT** appears in upper right hand corner of the display or if the **red light** of the receiver becomes faint please change the battery from remote control or receiver.

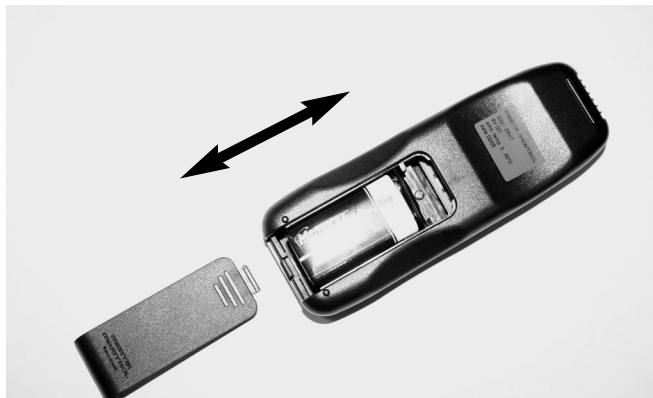

Fig. 22

Slide back the handset battery compartment cover, remove the used battery, insert and connect a suitable battery (9V-6F22) and replace the cover.

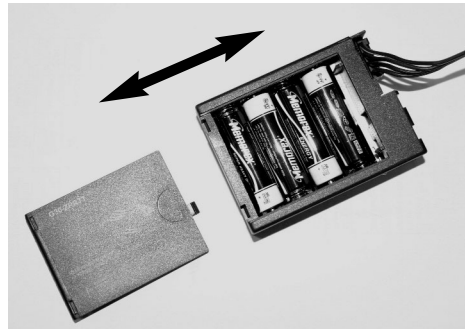

Fig. 23

Slide back the battery compartment cover, insert 4 suitable batteries and replace the cover

If the batteries lose power, the flame height can be adjusted by manually turning knob B (see page 32)

NOTE

Please note the placement of the remote control (temperature sensor) is important to assure proper temperature regulation. Generally a more constant temperature will be assured, if the remote control is not too far from the gas appliance. Before switching to AUTO or TIMER mode press either button (**A**) or (**B**) to verify the reception (when the send symbol appears in the remote control display, the receiver red light must illuminate). For the AUTO or TIMER mode to function correctly the remote control must remain within range of the receiver. The remote control should not be used in very close proximity to the receiver (less than 1m / 3ft) as this could in very rare cases, produce a electronic switch error. This error could block the motor when the knob reaches the end points of its turning radius. The knob must then be turned manually to free blockage.

The temperature is controlled by activating the motor for a specific length of time to adjust the appropriate flame height. This time is calculated by the remote control and depends on variables such as room size, heater capacity, battery power etc. Therefore a few cycles are necessary before an optimum is achieved. If a low flame is sufficient to provide enough warmth to the room, then the appliance will cycle between low fire and off. This allows longer periods with the flame on and provides a more uniform room temperature.

It is recommended to turn the combination control either to the off or pilot position if the appliance is left unattended for longer periods (e.g vacation) so that it cannot receive commands from the remote control. Exercise caution when leaving the appliance unattended, in exceptional cases sound waves from sources other than the remote control can cause changes in flame height adjustment.

USER INSTRUCTIONS

IMPORTANT NOTICES

A qualified gas engineer must carry out the installation and servicing of this appliance in accordance with these instructions and in compliance with current Building Regulations. **Such person must be a registered CORGI engineer.**

This appliance is designed to run on natural gas or LPG, however it is not possible to change between the two versions without a factory service.

Warning - Only use the appliance with the specified gas (see the appliance data plate).

This appliance is intended for use on a gas installation with a governed meter.

The instructions must be read before use of the appliance.

Please note the following;

- Sealed components must not be interfered with.
- Servicing instructions and part identification numbers are given towards the back of the manual.
- Only use genuine **Aarrow** parts for replacements.

All surfaces except the control knobs are considered to be working surfaces.

Please note, that the monitoring system (ODS) operates if evacuation of the combustion products is interrupted. If this does occur, turn the appliance to the fully OFF position, and re-light (see page 32). If this monitoring system continues to cut out the appliance, a qualified gas engineer should be called.

Warning: Under no circumstances must the stove be operated if the glass is cracked or broken.

Warning: If it is known or suspected that an operational or ignition fault exists on the appliance, it must not be used until it has been investigated and corrected by a qualified gas engineer.

Warning: The stove will become very hot. Always use a fire guard in the presence of children, the elderly, and the infirm. The fireguard must comply with BS8423:2002 (Fire guards suitable for use with solid fuel appliances).

Warning: No combustible materials including clothing, furniture and furnishings (including curtains) must not be placed within 1 metre of the stove.

Warning: THIS GAS APPLIANCE MUST BE SERVICED EVERY TWELVE MONTHS BY A QUALIFIED GAS ENGINEER.

STATUTORY REQUIREMENTS

This product must be installed in accordance with the rules in force.

The current Gas Safety (Installation and Use) Regulations (as amended).

The Building Regulations for England and Wales 2000 ref Approved Document J 2002 edition (issued by the DTLR).

The Building Standards (Scotland) (Consolidation) Regulations.

Detailed recommendations are outlined in the current issue of the following British Standards:- BS5440 parts 1 and 2, BS5871 part 1 and BS6891

Any Manufacturer Instructions must not be taken as overriding statutory requirements.

CERTIFICATION

This appliance is CE certificated for performance and safety. Therefore, it is important that no alteration is made to the appliance.

Any alteration not approved by **Arada Ltd** will invalidate the guarantee.

SHELF CLEARANCES

Combustible shelf clearances

The minimum height from the extreme top surface of the stove to the underside of a shelf or other projection made of wood or any other **combustible material** is shown on graph 1.

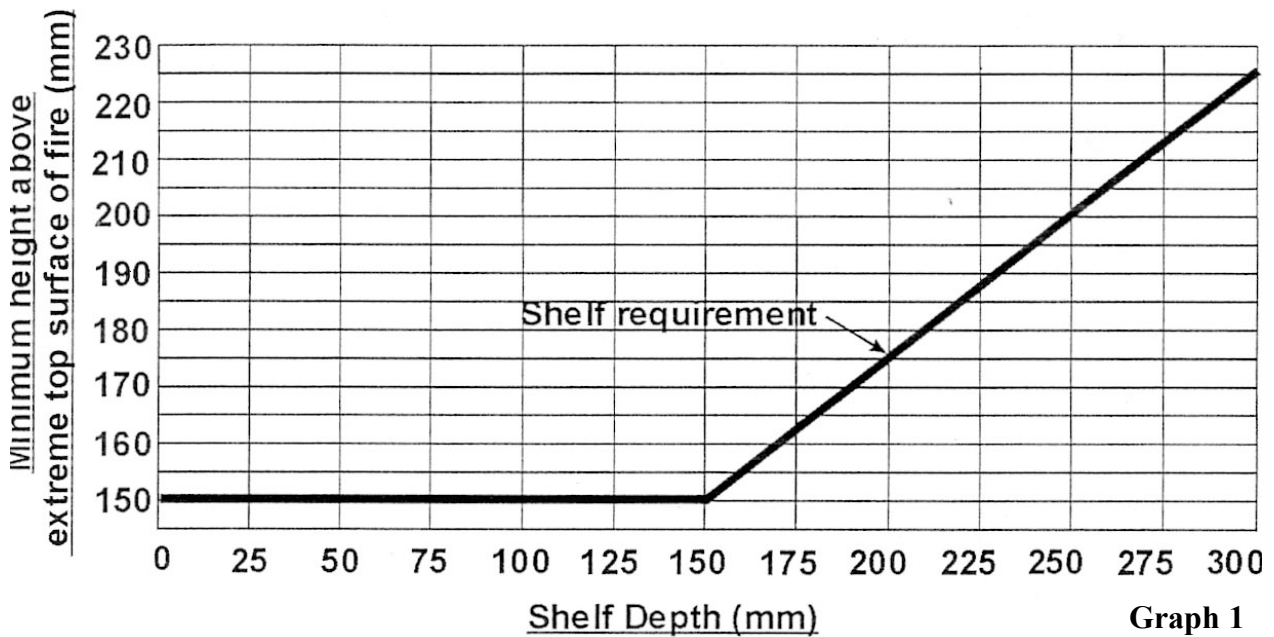





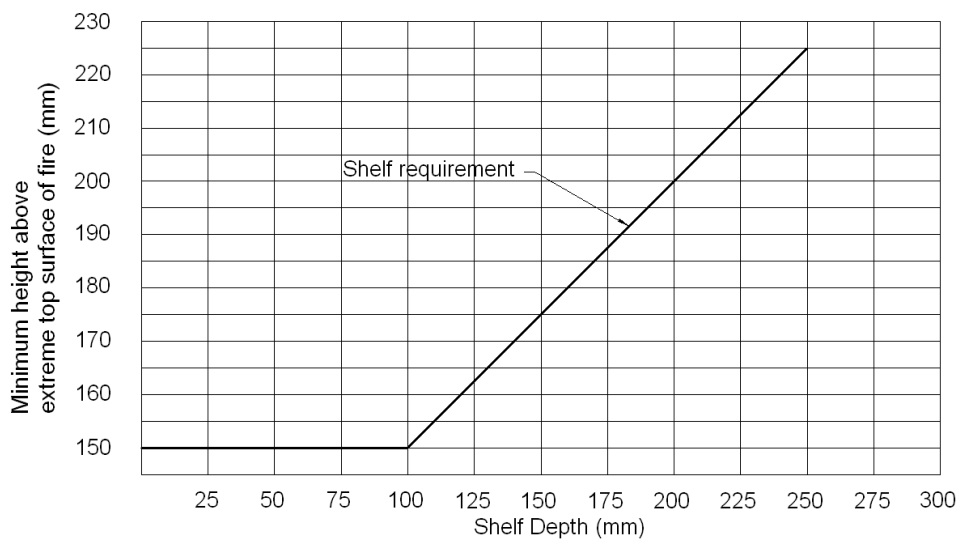

Non-Combustible shelf clearances







The minimum height from the extreme top surface of the stove to the underside of a shelf or other projection made of **non-combustible material** is shown on graph 2.

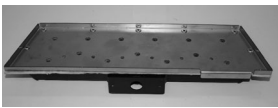
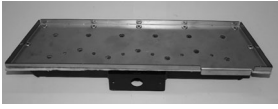





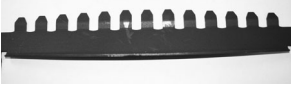

WARNING: No shelf is to be used with a top flue appliance, where it has to pass through a shelf.

SPARE PARTS

Part Description	Visual Aid (not to scale)	Part Number
1. Coal set (Complete)		AFGS1115
2. Log set - NG (Complete)		AFGS1117
3. Log set - LPG (Complete)		AFGS1121
4. Injector NG - BRAY 82/400		AFGS1123
5. Injector LPG - BRAY 82/160		AFGS1124
6. Pilot assembly - NG		AFGS1087
7. Pilot assembly - LPG		AFGS1125
8. Top Burner Assembly NG		AFGS1126
9. Top Burner Assembly LPG		AFGS1127

Part Description	Visual Aid (not to scale)	Part Number
10. Control Valve		AFGS1089
11. Fire door set (with handles)		AFGS1128
12. Glass Frame Assembly		AFGS1093
13. Hinge Kit & With Fixings-		AFS047
14. Dummy Fuel Retainer		AFGS1118
15. Instruction Manual		AFGS1095
16. Stove Glass Rope Gasket		AFGS1096

SPARE PARTS

Part Description	Visual Aid (not to scale)	Part Number
17. Top Flue Cover Plate		AFGS1098
18. Top Flue Infill Piece		AFGS1120
19. Valve Cover		AFGS1119
20. Flue Spigot Complete With Rope Gasket		AFGS1129
21. Hot Plate Complete With Rope Gasket		AFGS010
22. Aarrow Fires Gauntlet Gloves		AFS997
23. Operating Tool		AFS008
24.		

Remote Control -

A remote control system can be retro-fitted to your Sherborne GSL stove. This system allows convenient control of the stove, room temperature regulation and the advantage, to be programmable to enable switching on / off by a timer function*.

* Note - Pilot must be lit manually before function of remote control is operational.



Part Code -
REMOTESHB

Paint -

Matching aerosol paint to tone in any connecting flues, pipes or surrounding metalwork.

Tracery -

Gothic style door traceries are available to suit any room.



Part Code -
TRACESHB

Add On Canopy -

A traditional raised add on canopy is available for your Sherborne GSL stove to complete the authentic look. The canopy can simply be fitted once the stove has been installed.

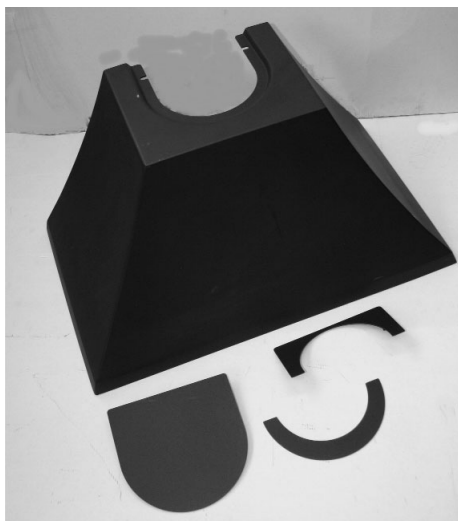

Part Code -
AOCSHB

GUARANTEE

Your Sherborne GSL stove carries a *Lifetime** guarantee against defects to the stove body. All other components carry a guarantee period of *One* year from the date of purchase . This does not apply to items which would be subject to fair wear or tear. However, should you have any problems with your appliance please contact your Arrow stove stockist who will have the knowledge and facilities to help you.

*Lifetime Guarantee, stove body being defined as the steel outer casing and items fixed immovably to the casing.

Arada Ltd will not be responsible for any consequential or incidental loss, damage, or injury however caused. If your appliance proves to be defective as a result of faulty materials or workmanship during guarantee, we will repair or replace it FREE OF CHARGE as long as the stove has been installed according to these instructions and by a CORGI Registered fitter, who has completed and signed the Installation Check List on page 24. The stove must also be serviced in accordance with these instructions and the record of Annual service on page 29 should be completed by your service engineer.

USE OF SPARE PARTS OTHER THAN THOSE SUPPLIED BY Arada Ltd WILL INVALIDATE THE APPLIANCE WARRANTY.

All Guarantee periods commence on the date of purchase and are non-transferable.

Our Guarantee is offered as an addition to your statutory rights.

Guarantee applicable to original purchaser only. Not transferable.

The Manufactures decision shall be final.

This installation and operating manual gives sufficient details to enable the appliance to be installed and maintained. If further information is required, please contact your local stockist who will be pleased to help.

When you contact them, they will need to know :

1. Your name, address, post code and telephone number.
2. Date of purchase and supplier details.
3. Name of installer.
4. Stove serial number, found on the data plate badge.
5. Clear and concise details of the fault.

Please complete the following for you own records

Date of Purchase.....Model..... Serial Number.....

Name and address of supplier.....
.....
.....

Name and address of Installer.....
.....
.....

ADDITIONAL NOTES

FINAL FACTORY ASSEMBLY CHECK LIST

Model.....
Serial No.....

	ALL TYPES
QUALITY	
FINISH	
REGISTRATION CARD	
INSTRUCTION MANUAL	
GAS SERVICE TAP & 8x GLASS FIXING SCREWS	
FLUE SPIGOT OUTLET	
HOT PLATE	
OUTER SLAB CANOPY COVER	
OUTER SLAB CANOPY INFILL	
OUTER BODY ASSEMBLY	
FIRE DOORS & HANDLES	
DUMMY FUEL RETAINER	
VALVE COVER	
GLASS FRAME ASSEMBLY	
SELF LEVELING FEET	
OPERATING TOOL	

OPTIONAL EXTRA	/
REMOTE CONTROL	
DOOR TRACERY	

FUEL BED SELECTION	/
NG / LPG COAL SET	
NG LOG SET	
LPG LOG SET	

*I've checked it
and it's O.K.*

Assembled by.....

Checked by



Free Manuals Download Website

<http://myh66.com>

<http://usermanuals.us>

<http://www.somanuals.com>

<http://www.4manuals.cc>

<http://www.manual-lib.com>

<http://www.404manual.com>

<http://www.luxmanual.com>

<http://aubethermostatmanual.com>

Golf course search by state

<http://golfingnear.com>

Email search by domain

<http://emailbydomain.com>

Auto manuals search

<http://auto.somanuals.com>

TV manuals search

<http://tv.somanuals.com>