

FPC 8084

**All-in-One
8.4" Super Slim
PANEL PC**

User's Manual

Disclaimers

The information in this manual has been carefully checked and is believed to be accurate. Acnodes Co., Ltd. assumes no responsibility for any infringements of patents or other rights of third parties, which may result from its use.

Acnodes assumes no responsibility for any inaccuracies that may be contained in this document. Acnodes makes no commitment to update or to keep current the information contained in this manual.

Acnodes reserves the right to make improvements to this document and/or product at any time and without notice.

No part of this document may be reproduced, stored in a retrieval system, or transmitted, in any form or by any means, electronic, mechanical, photocopying, recording, or otherwise, without the prior written permission of Acnodes Co., Ltd.

**©Copyright 2005 by Acnodes Co., Ltd. All
rights reserved.
May 2005, Version A1
Printed in Taiwan**

Safety Approvals

- < CE Marking
- < FCC Class A

FCC Compliance

This equipment has been tested and complies with the limits for a Class A digital device, pursuant to Part 15 of the FCC Rules. These limits are designed to provide reasonable protection against harmful interference in a residential installation. If not installed and used in accordance with proper instructions, this equipment might generate or radiate radio frequency energy and cause harmful interference to radio communications. However, there is no guarantee that interference will not occur in a particular installation. If this equipment does cause harmful interference to radio or television reception, which can be determined by turning the equipment off and on, the user is encouraged to try to correct the interference by one or more of the following measures:

1. Reorient or relocate the receiving antenna.
2. Increase the separation between the equipment and receiver.
3. Connect the equipment into an outlet on a circuit that is different from that to which the receiver is connected.
4. Consult the dealer or an experienced radio/TV technician for help.

Shielded interface cables must be used in order to comply with emission limits.

Safety Precautions

Before getting started, read the following important cautions.

1. The FPC 8084 does not come equipped with an operating system. An operating system must be loaded first before installing any software into the computer.
2. Be sure to ground yourself to prevent static charge when installing the internal components. Use a grounding wrist strap and place all electronic components in any static-shielded devices. Most electronic components are sensitive to static electrical charge.
3. Disconnect the power cord from the FPC 8084T before making any installation. Be sure both the system and the external devices are turned OFF. Sudden surge of power could ruin sensitive components. Make sure the FPC 8084 is properly grounded.
4. The brightness of the flat panel display decreases with usage. However, hours of use vary depending on the application environment.
5. Turn OFF the system power before cleaning. Clean the system using a cloth only. Do not spray any liquid cleaner directly onto the screen. The FPC 8084 may come with or w/o a touchscreen. Although the touchscreen is chemical resistant, it is recommended that you spray the liquid cleaner on a cloth first before wiping the screen. In case your system comes without the touchscreen, you must follow the same procedure and not spray any cleaner on the flat panel directly.
6. Avoid using sharp objects to operate the touchscreen. Scratches on the touchscreen may cause malfunction or internal failure to the touchscreen.
7. The flat panel display is not susceptible to shock or vibration. When assembling the FPC 8084, make sure it is securely installed.

8. Do not open the system's back cover. If opening the cover for maintenance is a must, only a trained technician is allowed to do so. Integrated circuits on computer boards are sensitive to static electricity. To avoid damaging chips from electrostatic discharge, observe the following precautions:
 - 9 Before handling a board or integrated circuit, touch an unpainted portion of the system unit chassis for a few seconds. This will help to discharge any static electricity on your body. When handling boards and components, wear a wrist-grounding strap, available from most electronic component stores.

Trademarks Acknowledgments

Acnodes is a trademark of Acnodes Co., Ltd.

IBM, PC/AT, PS/2, VGA are trademarks of International Business Machines Corporation.

Intel and Pentium are trademarks of Intel Corporation.

MS-DOS, Microsoft C and QuickBASIC are trademarks of Microsoft Corporation.

VIA is a trademark of VIA Technologies, Inc.

SST is a trademark of Silicon Storage Technology, Inc.

UMC is a trademark of United Microelectronics Corporation.

Other brand names and trademarks are the properties of their respective owners.

This page does not contain any information.

Table of Contents

Chapter 1 Introduction	1
1.1 General Description	1
1.2 Specifications	2
1.2.1 Main CPU Board	2
1.2.2 I/O System	2
1.2.3 System Specification	9
1.3 Dimensions	10
1.4 I/O Outlets	11
1.5 Package List	12
Chapter 2 Hardware Installation	13
2.1 HDD Installation	13
2.2 CF card Installation	15
2.3 Add-on Card Installation	16
2.4 3 x Serial Ports	18
2.5 VGA	20
2.6 Ethernet	20
2.7 Mountings: Panel / Wall / Desktop / VESA	21
2.7.1 VESA-ARM/Wall-Mount	21
2.7.2 Desktop Kit Assembly.....	22
2.7.3 Panel-mount Kit Assembly	23
Chapter 3 Driver Installation	24
3.1 System	24
3.2 Touch Screen	24
3.2.1 Specification.....	24
3.2.2 Driver Installation- Windows 98/2000/XP/CE.NET/XP-Embedded	25
3.2.3 Driver Installation- DOS.....	27
3.2.3.1 Using "INSTALL.EXE" utility to install PenMount software driver.	27
3.2.3.2 Identify the communication port and IRQ number	27

3.2.3.3 Do Calibration	28
3.2.3.4 Initializing the PenMount driver	29
3.2.4.5 Demonstration	29
3.2.4 Driver Installation- Linux	29
3.2.4.1 Advance Setup	29
3.2.4.2 Install PenMount driver	30
3.2.4.3 Do Calibration	31
Chapter 4 Embedded O.S. Installation	32
4.1 Windows XP Embedded	32
4.1.1 Penmount Touch Screen	32
4.2 Windows CE.NET 4.2.....	33
4.2.1 Calibration Touch Screen	33
Appendix A.....	34
Main Board BIOS Setup	34
A.1 BIOS Introduction.....	34
A.2 BIOS Setup	34
A.2.1 Standard CMOS Setup.....	36
A.2.2 Advanced BIOS Features	41
A.2.3 Advanced Chipset Features.....	46
A.2.4 Integrated Peripherals.....	49
A.2.5 Power Management Setup	53
A.2.6 PNP/PCI Configuration	56
A.2.7 PC Health Status	58
A.2.8 Frequency/Voltage Control	59
A.2.9 Load Fail-Safe Defaults.....	60
A.2.10 Load Optimized Defaults.....	61
A.2.11 Set Supervisor/User Password	62
A.2.12 Save & Exit Setup.....	63
A.2.13 Exit Without Saving.....	64

Chapter 1

Introduction

This chapter contains the general information and the detail specifications of the GOT-1840T. Chapter 1 includes the following sections:

- „ General Description
- „ System Specification
- „ Dimensions
- „ I/O Outlets
- „ Utilities Supported
- „ Package List

1.1 General Description

The FPC 8084 is a fan-less and compact-size touch panel computer, and is equipped with a 8.4" TFT LCD display and low power consumption CPU, the VIA Eden 667MHz. The FPC 8084 supports Windows® 98/NT/2000/XP, Windows® CE.NET, Windows® XP embedded, and Linux. The panel also includes a PC/104 slot for extended communication or a DA&C card. The FPC 8084 is cost-effective choice for operator interface applications.

Reliable and Stable Design

The FPC 8084 adopts a fan-less cooling system and a CompactFlash™ card, which makes it especially suitable for vibration-heavy environments, best for the transportation, ship, and industrial machinery markets.

Flexibility- a PC/104 Slot

The FPC 8084 offers a PC/104 slot that allows for extended communication or a DA&C card, or even for a PC/104 motion card, which can be used for different application requirements. With Windows a CE.NET and a CompactFlash™ card combination, the Panel is especially suitable for embedded applications.

Embedded O.S. Supported

The FPC 8084 not only supports Windows® 98/NT/2000/XP, but also supports embedded OS, such as Windows® CE.NET, and Windows® XP embedded. For storage device, the FPC 8084 supports 2.5" HDD or CompactFlash™ card.

Industrial-grade Product Design

The FPC 8084 has an incredible design that can be used in different industrial harsh environments.

- Z A fuse helps prevent over-voltage for power input.
- Z Stainless steel back chassis and Aluminum front bezel meets the IP65/NEMA4 standard.
- Z For connecting other devices, the FPC 8084 also features several interfaces: USB, Ethernet, and RS-232/422/485.

1.2 Specifications

1.2.1 Main CPU Board

- „ CPU: VIA EDEN 400MHZ, 667MHZ
- „ System Chipset: VT8606 (Twister-T) + VT82C686B
- „ BIOS: AWARD BIOS, Plug-and-Play 4Mbit Flash ROM with SmartView VGA BIOS Function and integrated Ethernet Novell RPL and Windows PXE Boot ROM functions.
- „ System Memory: One 144-pin DIMM socket.
Maximum up to 512MB SDRAM
ECC/parity
- „ L2 Cache: Integrated in CPU
- „ Watchdog Timer: Generates a system reset or NMI by jumper selectable
Software programmable time interval
64 levels, 0.5~8/5~80/50~800/100~1600 seconds

1.2.2 I/O System

- „ Standard I/O:
 - 3 x serial ports with power;
2 x RS-232, 1 x RS-232/422/485 jumper selectable
 - 1 x PS/2 Keyboard/Mouse Interface
 - 1x VGA Ports
 - 2 x USB Ports 1.1 compliant

Ethernet:

- Realtek RTL 8100C PCI Bus 10/100M Base-T
- Wake-On-LAN
- RJ-45 interface equipped

- „ Expansion Slot:
 - one 16-bit PC/104 connector

1.2.3 System Specification

- „ **8.4" TFT LCD**
- „ **Disk drive housing:**
 - 1 x internal 2.5" drive
- „ **100W DC power supply**
- „ **Heat dispensing design**
- „ **One slot for PC/104**
- „ **Net weight:**
 - 18 Kgs
- „ **Dimension (main body size):**
 - 280 x 225 x 61.1mm
- „ **Operating temperature:** -10° to 45°C ; Relative umidity:50%
- „ **Relative humidity:** 10% to 85% @ 40° C, on-condensing
- „ **Altitude:** 10,000 ft. (3,000 meters)
- „ **Vibration (operating):**5 to 500 Hz, 1.3 G random
- „ **Shock (operating):** 10 G peak acceleration (11 msec. duration)

1.3 Dimensions

The following diagrams show the dimensions and outlines of FPC 8084.

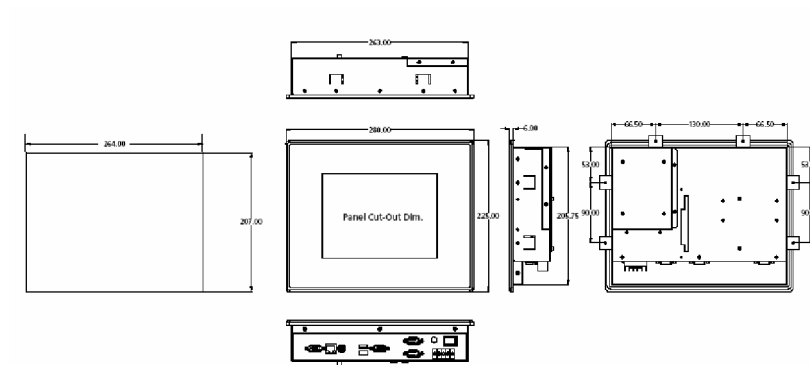

1.4 I/O Outlets

The following figure shows the I/O locations of the FPC 8084. Most of the I/O connectors are located on the back panel of the FPC 8084.

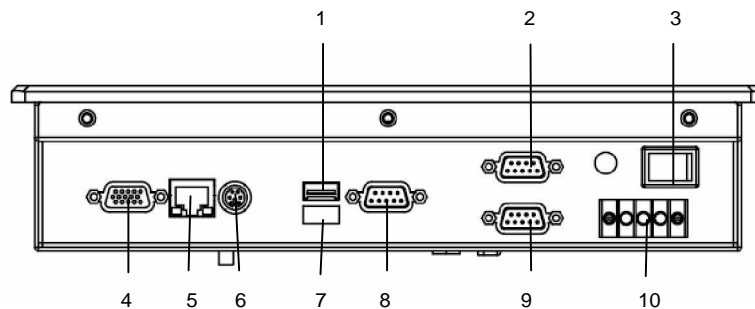

- | | |
|------------------------|--------------------------|
| 1: USB v1.1 | 6: Keyboard/Mouse |
| 2: COM4 Port | 7: USB v1.1 |
| 3: Power Switch | 8: COM1 Port |
| 4: VGA Port | 9: COM2 Port |
| 5: LAN (RJ45) | 10: DC inlet |

1.5 Package List

When you receive the FPC 8084 there are following items in the package.

1. FPC 8084 x 1
2. Panel mount kit x 6
3. Desktop kit x 2
4. Desktop kit screw x 4
5. VESA ARM/Wall-mount kit x 1
6. CD driver x1

Chapter 2

Hardware Installation

The FPC 8084 provides lots of flexible ways for you to select different configuration such as HDD, CF card and more. The chapter will show you how to install the hardware. It includes:

2.1 HDD Installation

The FPC 8084 offers a convenient drive bay module for users to install HDD. The FPC 8084 offers one 2.5" HDD drive for users to install. Please follow the steps:

1. Open the HDD back chassis. Unscrew 4 screws of back and 4 screws of side. And take out the HDD bracket.

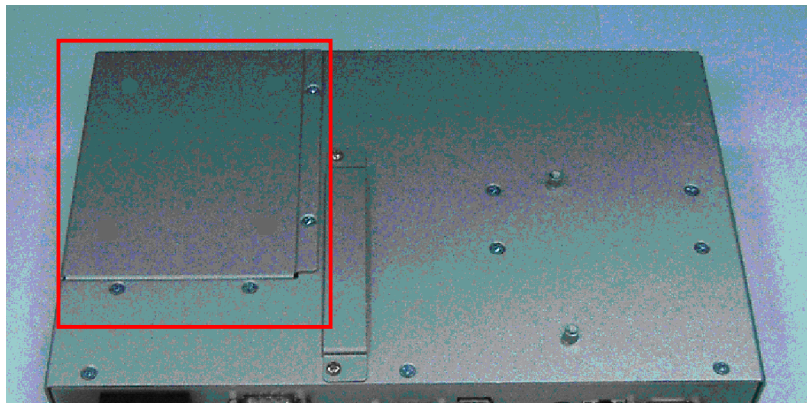

2. Screw 4 screws and fix HDD on the bracket kit.

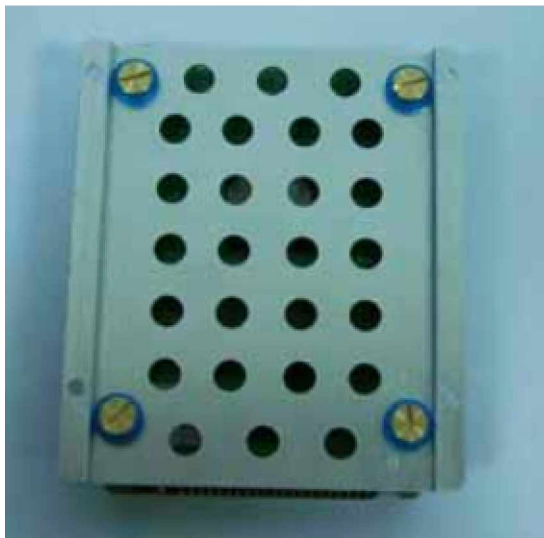

3. Fix the HDD bracket kit to system by 4 screws.

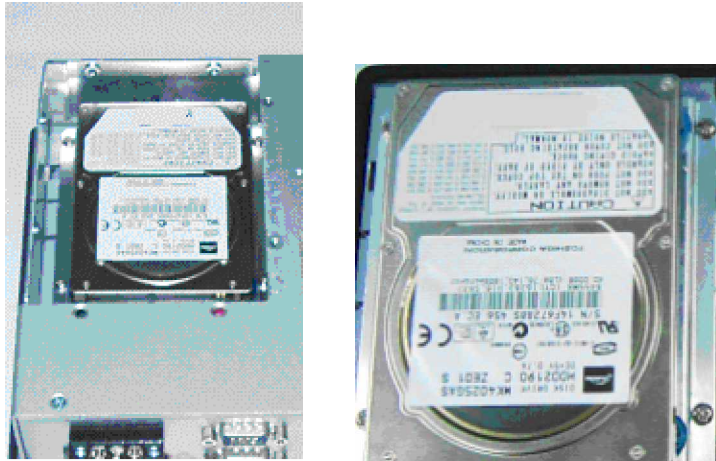

2.2 CF card Installation

The FPC 8084 offers a convenient drive bay module for users to install CF card. When installing the CF card, refer to the following instructions and illustration:

1. Open the bottom chassis.



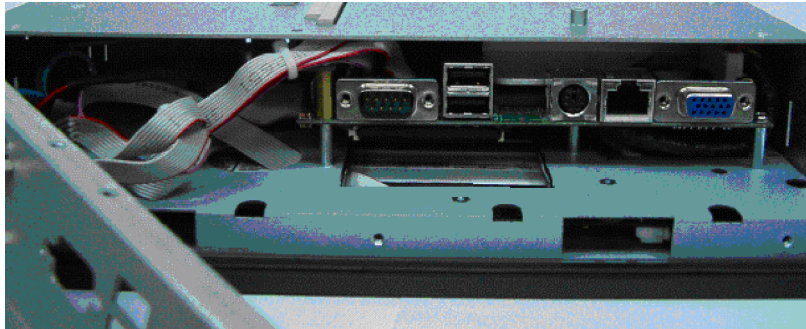

2. Install user's CF card.

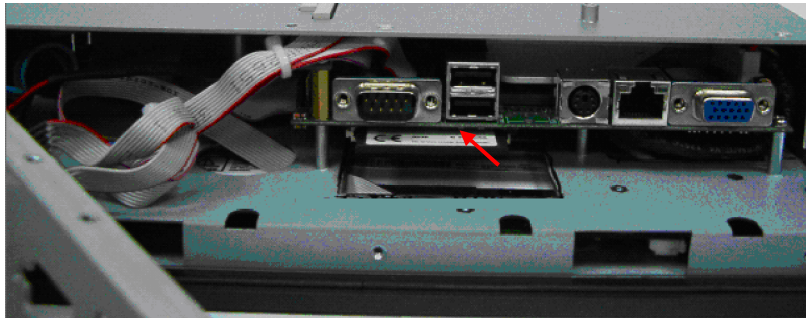

2.3 Add-on Card Installation

The FPC 8084 provides one PC/104 slot. User could install one or two PC/104 card. If user needs the PC/104 Box to protect add-on card, user can order the 'GOT-PC104-Kit'.

When upgrading the add-on card, refer to the following instructions and illustration:

1. Remove the piece by 2 screws.



2. Install PC/104 cards on the slot.



3. Set the bracket to protect.



2.4 3 x Serial Ports

COM Port Connector: COM1

The connector, COM 1, is a DB-9 connector, and the following table shows the pin assignments of this connector.

Pin	Signal Name
1	DCD, Data carrier detect
2	RXD, Receive data
3	TXD, Transmit data
4	DTR, Data terminal ready
5	GND, ground
6	DSR, Data set ready
7	RTS, Request to send
8	CTS, Clear to send
9	RI, Ring indicator

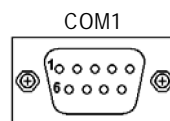

COM Port Connectors: COM2, COM3, COM4

The RS-232 pin assignments are listed on the following table.

Pin	Description	Pin	Description
1	Data Carrier Detect (DCD)	2	Data Set Ready (DSR)
3	Receive Data (RXD)	4	Request to Send (RTS)
5	Transmit Data (TXD)	6	Clear to Send (CTS)
7	Data Terminal Ready (DTR)	8	Ring Indicator (RI)
9	Ground (GND)	10	NC



The RS-422/485 pin assignments for COM2 are listed below.

Pin #	Signal Name	
	R2-422	RS-485
1	TX-	DATA-
2	No connector	No connector
3	TX+	DATA+
4	No connector	No connector
5	RX+	No connector
6	No connector	No connector
7	RX-	No connector
8	No connector	No connector
9	GND	GND
10	No connector	No connector

2.5 VGA

The FPC 8084 has an analog RGB interface connector. It is able to connect to an expansion CRT monitor, and the system can display on both the flat panel and the CRT simultaneously.

2.6 Ethernet

Ethernet PJ-45 Connector: LAN1

The **FPC 8084** is equipped with a high performance Plug and Play Ethernet interface which is fully compliant with the IEEE 802.3 standard, and consisting of a RJ-45 connector LAN

3.4.15.1 Pin Assignment

LAN1: RJ-45 Connector Pin Assignment

Pin	Signal
1	Tx+ (Data transmission positive)
2	Tx- (Data transmission negative)
3	Rx+(Data reception positive)

4	RJ45 termination
5	RJ45 termination
6	Rx- (Data reception negative)
7	RJ45 termination
8	RJ45 termination

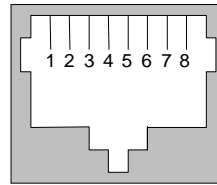

RJ-45

2.7 Mountings: Panel / Wall / Desktop / VESA

There are 5 application options for the FPC 8084, Panel/Wall/Desktop/VESA mountings.

2.7.1 VESA-ARM/Wall-Mount

The FPC 8084 provides two ways for VESA mount: 75x75 mm Screw four screws to fix the kit (included in the package) in the back chassis.



2.7.2 Desktop Kit Assembly

The FPC 8084 is designed for desktop application. The standard set of desktop kit is included in the system packaging. Screw 4 screws to fix the kit (included in the package) in the side chassis.





2.7.3 Panel-mount Kit Assembly

The FPC 8084 is designed for panel mount application. To mount the FPC 8084, the standard set of mounting kit (included in the system packaging) is needed.



Chapter 3 Driver Installation

FPC 8084 could support with Windows 95, Windows 98 or Windows 2000/XP. To facilitate installation system driver, you should read the instructions in this chapter carefully before you attempt installation.

1. Insert Driver CD and select the "\Driver\".

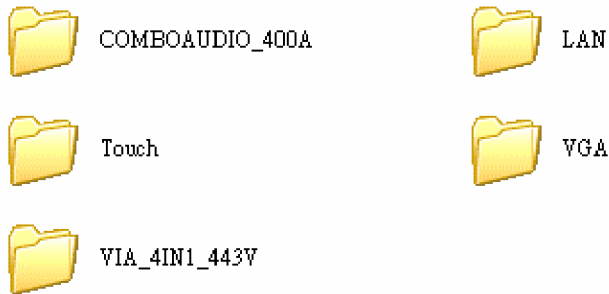

2. Select all files and follow the install procedure and press OK.

3.2 Touch Screen

3.2.1 Specification

Touch Screen:	For 8-wire analog resistive type
Touch Screen Controller:	DMC9000
Communications:	RS-232
Baud Rate:	19200 baud rate fixed
Resolution:	1024 x 1024 (10-bit A/D converter inside)
Power Input:	5V to 12V DC

Power Consumption:	12V: 27mA+ i where (i = v/touch screen sheet R) 5V: 23mA+ i where (i = v/touch screen sheet R)
Board Size:	6.0 x 2.0 cm
Portrait:	Support 90o to 270o screen rotation
Static Protection:	ESD device option
Others:	Touch activate indication LED on board

3.2.2 Driver Installation- Windows 98/2000/XP/CE.NET/XP-Embedded

The touch screen of FPC 8084 provides a driver for use with Windows 95, Windows 98 or Windows 2000/XP. To facilitate installation of the touch screen driver, you should read the instructions in this chapter carefully before you attempt installation.

1. Insert Driver CD and select the “\Driver\Touch \Windows 9x or 2k or XP or CE\Setup.exe”

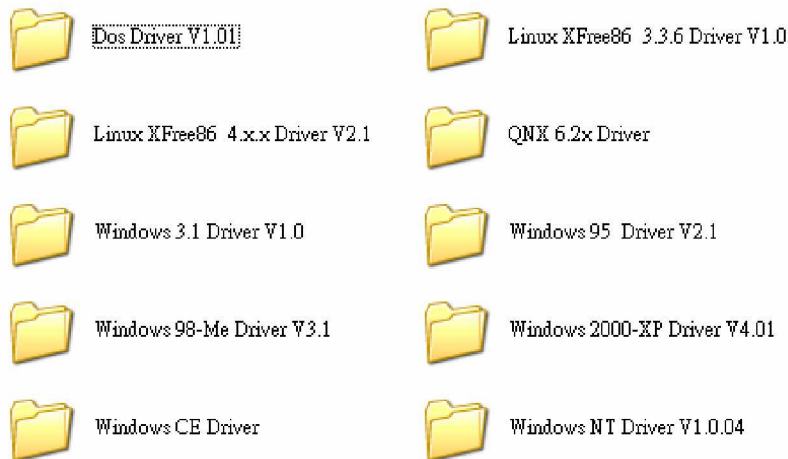

2. Follow the install procedure and press OK.
3. Click Start menu and select “PenMount Utilities”. You can see

PenMount Control Panel

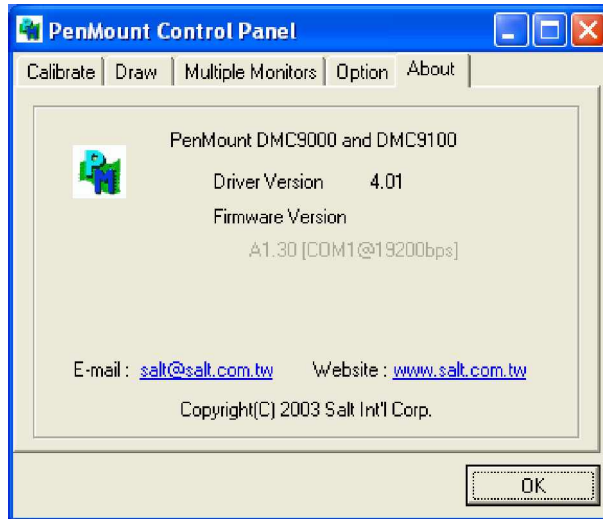

4. Select the "Standard Calibrate" tab

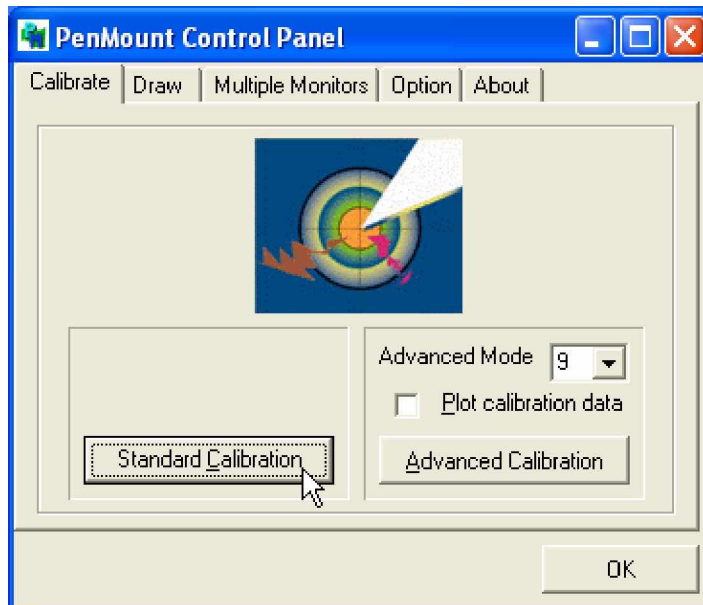

5. Calibration:

To adjust the display with touch panel, click "Calibration" and follow the calibrate point to do calibration; there are five points on screen for calibration.

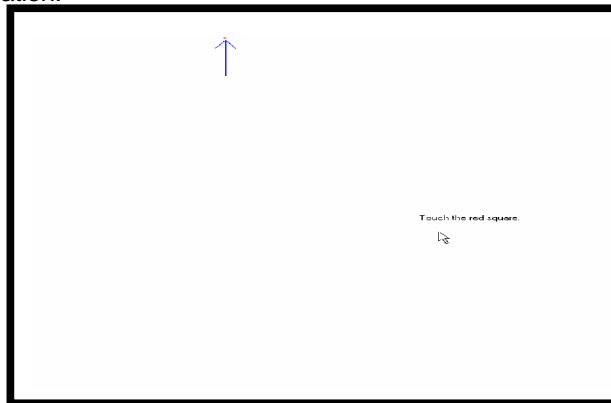

6. Press OK.

3.2.3 Driver Installation- DOS

3.2.3.1 Using "INSTALL.EXE" utility to install PenMount software driver.

1. Insert Driver CD and select the "Driver\Touch screen\DOS\Install.exe"
2. Press ENTER key to install the drivers to drive C or use keyboard to key-in the hard disc drive that you plan to install the driver.
3. The driver will ask "Do you want to modify your Autoexec.bat to initialize PenMount? (Y/N)" Suggest you choose "YES" for generating the initialization instructions in AUTOEXEC.BAT files. Then follow up the instructions to complete the installation.

3.2.3.2 Identify the communication port and IRQ

number

1. For the first time installation, or changing PenMount Touch Screen's COM port, use PMDETECT (e.g. C:\PENMOUNT\PMDETECT) to check the COM port and IRQ number. PMDETECT will save the correct data to PMOUSE.CFG file for further use.

The driver detects your communication COM port and IRQ number from COM1 IRQ4, COM2 IRQ3, COM3.... to COM4 IRQ15. PenMount driver can find the COM port and IRQ number automatically. The screen will then show:

PenMount is initialized successfully!!!

Create file "pmouse.cfg". Success.

PenMount internal settings:

Comm. Port: COM<n> IRQ<n>

.....

1. PMDETECT program is able to skip the IRQ number detecting if you Touchscreen Driver Installation **13** do not need to detect the specified IRQ number. For example, you do not need to detect IRQ5, and the command is:

C:\PENMOUNT\PMDETECT -N5

If you do not need to detect IRQ5 and IRQ9, the command is:

C:\PENMOUNT\PMDETECT -N5 -N9

3.2.3.3 Do Calibration

1. To adjust the touch screen mapping properly to display screen, use PM.BAT (C:\PENMOUNT\PM) to do calibration. Choose "1" DO CALIBRATION (adjust screen mapping).
2. The message on screen asks you to select video mode number. Select

by keyboard to start the calibration, touch the upper-center point, then

right-center point, bottom-center point and left-center point in sequence. After calibration, the data is shown in the screen, press any key to continue the progress.

3. After the calibration, suggest you to test touch screen and display mapped results by choose "3" DRAWING TEST under PM.BAT

3.2.3.4 Initializing the PenMount driver

If you don't have the initialization commands in AUTOEXEC.BAT, initialize PenMount C:\PENMOUNT\PMINIT) controller before you use the PenMount Touch Screen. The display will show the initialization message:

PenMount V7.06 Copyright(c) SALT International Corp.

Test:COM<n> IRQ<n> (<n> is the number after PMDETECT done)

PenMount communication settings: COM<N> IRQ<n> Baud Rate:

<xxxx>

... ..

3.2.4.5 Demonstration

To demonstrate or test touch screen operation, selecting "3" DRAWING

TEST in PM.BAT file of Utility Directory. Drawing on screen. The other demonstration program called "ICECREAM.EXE" in the "PENMOUNT" directory can also be applied.

3.2.4 Driver Installation- Linux

3.2.4.1 Advance Setup

1. Before install the Touch Screen Driver, please open the file in Linux

File /etc/rc.local

```
#!/bin/sh
# file /etc/rc.local
# This script will be executed «after» all the other init scripts.
# You can put your own initialization stuff in here if you don't
# want to do the full Sys V style init stuff.
touch /var/lock/subsys/local

# Add setserial command for Com3 and Com1 setting
setserial /dev/ttyS2 port 0x3e8 irq 10
setserial /dev/ttyS3 port 0x2e8 irq 11
# end-
```

2. Key-in the following words:
Setserial /dev/ttyS2 port 0x3e8 irq 10
(set COM3 as touch screen port)

```
#!/bin/sh
# file /etc/rc.local
# This script will be executed «after» all the other init scripts.
# You can put your own initialization stuff in here if you don't
# want to do the full Sys V style init stuff.
touch /var/lock/subsys/local

# Add setserial command for Com3 and Com1 setting
setserial /dev/ttyS2 port 0x3e8 irq 10
setserial /dev/ttyS3 port 0x2e8 irq 11
# end-
```

3. Save and exit.
4. Please reboot.
5. After reset system, insert Driver CD.

3.2.4.2 Install PenMount driver

1. Insert Driver CD and select the "Driver\Touch\Linux XFree86 4.x.x Driver V2.1\Driver\penmount_drv.o"
2. Follow the install procedure and press OK.
3. Please reboot system.

4. Click Start menu and select "PenMount Utilities". You can see PenMount Control Panel

3.2.4.3 Do Calibration

1. Insert Driver CD and select the "Driver\Touch\Linux XFree86 4.x.x Driver V2.1\Calibration\ pencial-2.00"
2. Follow the install procedure and press OK.
3. Please reboot system.

Chapter 4 Embedded O.S. Installation

4.1 Windows XP Embedded

Supported onboard devices are as follows:

- „ Onboard Multi I/O
 - Floppy drive
 - 16C550 UARTs compatible serial port
 - IrDA for wireless communication
- „ Onboard IDE
 - IDE HDD
- „ USB
- „ PS2 Keyboard and mouse
- „ CRT/LCD display
- „ 10/100 base-T Ethernet
- „ Compact flash
- „ Onboard audio
- „ Audio
- „ Touch Screen

4.1.1 Penmount Touch Screen

FPC 8084 has Penmount touch screen on COM3, which is disabled by default.

Before you can use and calibrate it, you should :

1. Set up Penmount touch device driver by executing `c:\Penmount\ Windows 2000-XP V4.01\setup.exe`. When installation finished, an icon "PM" appears on Taskbar .
2. Calibrate Penmount touch by clicking on "PM" icon and doing calibration
3. Restart computer.

4.2 Windows CE.NET 4.2

Supported onboard devices are as follows:

- „ Onboard Multi I/O
 - Floppy drive
 - 16C550 UARTs compatible serial port
 - IrDA for wireless communication
- „ Onboard IDE
 - IDE HDD
- „ USB
- „ PS2 Keyboard and mouse
- „ CRT/LCD display
- „ 10/100 base-T Ethernet
- „ Compact flash
- „ Onboard audio
- „ Audio
- „ Touch Screen

4.2.1 Calibration Touch Screen

In this image we add PenMount Touch drivers and utilities. It is customized for 800 x 600.

Calibration:

1. Click “Calibration” on desktop to calibrate touch screen.
2. In the start\programs menu, select “save registry”, thus Calibration data will be saved and effective in next boot.

Appendix A

Main Board BIOS Setup

Appendix A describes the different settings available in the Award BIOS that comes with the **SBC84600** CPU card. Also, the instructions on how to set up the BIOS configuration are contained in this chapter.

A.1 BIOS Introduction

The Award BIOS (Basic Input/Output System) installed in the system ROM supports Intel Celeron processors in a standard IBM-AT compatible I/O system. The BIOS provides critical low-level support for standard devices such as disk drives, serial and parallel ports. It also adds virus and password protection as well as special support for detailed fine-tuning of the chipset controlling the entire system.

A.2 BIOS Setup

The Award BIOS provides a Setup utility program for specifying the system configurations and settings. The BIOS ROM of the system stores the Setup utility. When the computer is turned ON, the Award BIOS is immediately activated. The following message will appear on the screen:

Press to Enter Setup

Then, press the key immediately to enter the Setup utility. The delay of pressing the key will cause POST (Power On Self Test) to continue with the test routines, thus preventing invoking the Setup. In this case, the system has to be restarted for entering the BIO setup by pressing the "Reset" button or simultaneously pressing the <Ctrl>, <Alt> and <Delete> keys. Besides, turning the system OFF first and then ON again can also restart the system.

When entering the Setup utility, the Main Menu screen will appear on the screen. Various setup functions and exit choices can be selected from this menu.

In general, the arrow keys are used to highlight items, <Enter> to select, the <PgUp> and <PgDn> keys to change entries, <F1> for help and <Esc> to quit.

Phoenix – AwardBIOS CMOS Setup Utility	
Standard CMOS Features	Frequency/Voltage Control
Advanced BIOS Features	Load Fail-Safe Defaults
Advanced Chipset Features	Load Optimized Defaults
Integrated Peripherals	Set Supervisor Password
Power Management Setup	Set User Password
PnP/PCI Configurations	Save & Exit Setup
PC Health Status	Exit Without Saving
Esc : Quit F9: Menu in BIOS ↵ : Select Item F10 : Save & Exit Setup	
Time, Date, Hard Disk Type...	

The section below the setup items in the Main Menu displays the control keys for this menu. Another section located at the bottom of the Main Menu, just below the control keys section, displays information on the currently highlighted item in the list.

NOTE: *If the computer cannot boot after making and saving system changes with Setup, the Award BIOS, via its built-in override feature, resets your system to the CMOS default settings.*

Avoid making any changes to the chipset defaults are strongly recommended. These defaults have been carefully chosen by both Award and the system manufacturer to provide the absolute maximum performance and reliability.

A.2.1 Standard CMOS Setup

“Standard CMOS Setup” is used to record some basic hardware configurations in the computer system and set the system clock and error handling. If the motherboard is already installed in a working system, there is no need to enter this option. However, the Standard CMOS option has to be setup in any of the following situations: the system hardware configurations are changed, the onboard battery fails, and the configuration stored in the CMOS memory is lost or damaged.

Phoenix – Award BIOS CMOS Setup Utility			Item Help
Standard CMOS Features			
Date (mm:dd:yy)	Wed, Aug 7 2002		
Time (hh:mm:ss)	13 : 9 : 11		
<input type="checkbox"/> IDE Primary Master	None		Menu Level <input type="checkbox"/>
<input type="checkbox"/> IDE Primary Slave	None		Change the
<input type="checkbox"/> IDE Secondary Master	None		Day, month,
<input type="checkbox"/> IDE Secondary Slave	None		Year and
			Century
Drive A	1.44M, 3.5 in.		
LCD Type	T9 800x600 TFT		
Screen Expansion	Enable		
TV Type	NTSCDisplay		
Type During Post	VGA Default		
Display Type After Post	VGA Default		
Halt on	All, But keyboard		
Base Memory	640K		
Extended Memory	65535K		
ÇÉÆÅ : Move Enter: Select +/-/PU/PD: Value F10: Save General Help			ESC: Exit F1:
F5: Previous Values F6: Fail-Safe Defaults F7: Optimized Defaults			

At the bottom of the menu are the control keys for the use of this menu. The <F1> key can be pressed in each item field to display the relevant information for help. The memory display at the lower right-hand side of the menu is read-only. It will adjust automatically

according to the memory changed. The following pages describe each item of this menu.

Date

The date format is <day>, <date> <month> <year>. Press <F3> to show the calendar.

day	The day of week, from Sun to Sat, determined by the BIOS, is read only
date	The date, from 1 to 31 (or the maximum allowed in the Month), can key in the numerical / function key
month	The month, Jan through Dec.
year	The year, depends on the year of BIOS

Time

The time format is <hour> <minute> <second> accepting either function key or numerical key. The time is calculated based on the 24-hour military-time clock. For example, 1 p.m. is 13:00:00.

IDE Primary Master / Primary Slave / Secondary Master / Secondary Slave

This category identifies the type of the channel that is installed in the computer. There are 45 predefined types and 2 user definable types for Enhanced IDE BIOS. Type 1 to Type 45 are predefined. Type User is user-definable.

Press <PgUp>/<+> or <PgDn>/<-> to select a numbered hard disk type or type the number and press <Enter>. Note that the specifications of the drive in the system must match with the drive table. The hard disk will not work properly if the improper information within this category is entered. If the disk drive type does not match or is not listed, the Type User is used to define the drive type manually.

If the Type User is selected, related information has to be entered. Enter the information directly from the keyboard and press <Enter>. This information should be provided in the documentation from the hard disk vendor or the system manufacturer.

If the controller of HDD interface is ESDI, select "Type 1".

If the controller of HDD interface is SCSI, select "None".

If the controller of HDD interface is CD-ROM, select "None".

CYLS.	number of cylinders	LANDZONE	landing zone
HEADS	number of heads	SECTORS	number of sectors
PRECOMP	write precom	MODE	HDD access mode

If there is no hard disk drive installed, select NONE and press <Enter>.

Drive A type/Drive B type

The category identifies the types of floppy disk drive A or drive B installed in the computer.

None	No floppy drive installed
360K, 5.25 in	5.25 inch PC-type standard drive; 360Kb capacity
1.2M, 5.25 in	5.25 inch AT-type high-density drive; 1.2MB capacity
720K, 3.5 in	3.5 inch double-sided drive; 720Kb capacity
1.44M, 3.5 in	3.5 inch double-sided drive; 1.44MB capacity
2.88M, 3.5 in	3.5 inch double-sided drive; 2.88MB capacity

Select Display Device

This item selection includes Auto, CRT, LCD and CRT+LCD

LCD Type

This item selection includes:

T0 640x480 TFT	T1 800x600 TFT	T2 1024x768 TFT
T4 640x480 DSTN	T5 800x600 DSTN	T6 1024x768 DSTN
T8 640x480 TFT	T9 800x600 TFT	T10 1024x768 TFT
T12 1400x1050 DSTN	T13 800x600 DSTN	T14 1024x768 DSTN
	T15 1280x1024 DSTN	

Display Type During Post

This item selection includes VGA DEFAULT, CRT, LCD, CRT+LCD, TV, and CRT+TV.

Display Type After Post

This item selection includes VGA DEFAULT, CRT, LCD, CRT+LCD, TV, and CRT+TV.

Halt On

This field determines whether the system will halt if an error is detected during power up.

No errors	The system boot will halt on any error detected. (default)
All errors	Whenever the BIOS detects a non-fatal error, the system will stop and you will be prompted.
All, But Keyboard	The system boot will not stop for a keyboard error; it will stop for all other errors.
All, But Diskette	The system boot will not stop for a disk error; it will stop for all other errors.
All, But Disk/Key	The system boot will not stop for a keyboard or disk error; it will stop for all other errors.

A.2.2 Advanced BIOS Features

This section is used to configure and improve the system and set up some system features according to the user's preference.

Phoenix – Award BIOS CMOS Setup Utility Advanced BIOS Features		
		Item Help
Virus Warning	Disabled	Menu Level F Allows you to Quick choose the VIRUS warning feature for IDE Hard disk boot sector protection. If this function is enable and someone Boot attempts to write data into this area, BIOS will show a warning message on Security screen and alarm beep
CPU Internal Cache	Enabled	
External Cache	Enabled	
CPU L2 Cache ECC Checking	Enabled	
Processor Number Feature	Enabled	
Power On Self Test	Enabled	
First Boot Device	HDD-0	
Second Boot Device	Floppy	
Third Boot Device	LS120	
Boot Other Device	Enabled	
wap Floppy Drive	Disabled	
Boot Up Floppy Seek	Enabled	
Up NumLock Status	On	
Gate A20 Option	Fast	
Typematic Rate Setting	Disabled	
Typematic Rate (Chars/Sec)	6	
Typematic Delay (Msec)	250	
ty Option	Setup	
OS Select For DRAM > 64MB	Non-OS2	
Video BIOS Shadow	Enabled	
C8000-CBFFF Shadow	Disabled	
CC000-CFFFF Shadow	Disabled	
D0000-D3FFF Shadow	Disabled	
D4000-D7FFF Shadow	Disabled	
D8000-DBFFF Shadow	Disabled	
DC000-DFFFF Shadow	Disabled	
Small Logo(EPA) Show	Disabled	
<p>ÇÈÆÅ : Move Enter: Select +/-/PU/PD: Value F10: Save ESC: Exit F1: General Help</p> <p>F5: Previous Values F6: Fail-Safe Defaults F7: Optimized Defaults</p>		

Virus Warning

This item protects the boot sector and partition table of the hard disk against accidental modifications. If an attempt is made, the BIOS will halt the system and display a warning message. If this occurs, the user can either continue the operation or run an anti-virus program to locate and remove the problem.

NOTE: *Many disk diagnostic programs, which attempt to access the boot sector table, can cause the virus warning. Thus, disable the Virus Warning feature while running any of these programs..*

CPU Internal Cache / External Cache

Cache memory is additional memory that is much faster than conventional DRAM (system memory). CPUs from 486-type and up contain internal cache memory, and most, but not all, modern PCs have additional (external) cache memory. When the CPU requests data, the system transfers the requested data from the main DRAM into cache memory, for even faster access by the CPU. These items are used to enable (speed up memory access) or disable the cache function. By default, these are **Enabled**.

CPU L2 Cache ECC Checking

When enabled, this allows ECC checking of the CPU's L2 cache. By default, this field is **Enabled**.

Processor Number Feature

When a Pentium® III CPU is installed, the system automatically detects it and displays this item.

Quick Power On Self Test

This option speeds up Power On Self Test (POST) after turning on the system power. If it is set as Enabled, BIOS will shorten or skip some check items during POST. The default setting is "Enabled".

Enabled	Enable Quick POST
Disabled	Normal POST

First/Second/Third Boot Device

These items allow the selection of the 1st, 2nd, and 3rd devices that the system will search for during its boot-up sequence. The wide range of selection includes Floppy, LS120, ZIP100, HDD0~3, SCSI, and CDROM.

Boot Other Device

This item allows the user to enable/disable the boot device not listed on the First/Second/Third boot devices option above. The default setting is **Enabled**.

Swap Floppy Drive

This allows you to determine whether to enable Swap Floppy Drive or not. When enabled, the BIOS swaps floppy drive assignments so that Drive A becomes Drive B, and Drive B becomes Drive A. By default, this field is set to "Disabled".

Boot Up Floppy Seek

During POST, BIOS will determine the floppy disk drive type, 40 or 80 tracks. 360Kb type is 40 tracks while 720Kb, 1.2MB and 1.44MB are all 80 tracks. The default value is "Enabled".

Enabled	BIOS searches for floppy disk drive to determine if it is 40 or 80 tracks. Note that BIOS can not tell from 720K, 1.2M or 1.44M drive type as they are all 80 tracks.
Disabled	BIOS will not search for the type of floppy disk drive by track number. There will be no warning message displayed if the drive installed is 360K.

Boot Up NumLock Status

This option enables and disables the numberlock function of the keypad. The default value is "On".

On	Keypad functions confine with numbers
Off	Keypad functions convert to special functions (i.e., left/right arrow keys)

Gate A20 Option

The default value is "Fast".

Normal	The A20 signal is controlled by keyboard controller or chipset hardware
Fast	Default: Fast. The A20 signal is controlled by Port 92 or chipset specific method

Typematic Rate Setting

This determines the typematic rate of the keyboard. The default value is "Disabled".

Enabled	Enable typematic rate and typematic delay programming
Disabled	Disable typematic rate and typematic delay programming. The system BIOS will use default value of these 2 items and the default is controlled by keyboard.

Typematic Rate (Chars/Sec)

This option refers to the number of characters the keyboard can type per second. The default value is "6".

6	6 characters per second
8	8 characters per second
10	10 characters per second
12	12 characters per second
15	15 characters per second
20	20 characters per second
24	24 characters per second
30	30 characters per second

Typematic Delay (Msec)

This option sets the display time interval from the first to the second character when holding a key. The default value is "250".

250	250 msec
500	500 msec
750	750 msec
1000	1000 msec

Security Option

This item limits the access to the system and Setup, or just to Setup. The default value is "Setup".

System	The system will not boot and access to Setup will be denied if their correct password is entered at the prompt.
Setup	The system will boot, but access to Setup will be denied if the correct password is not entered at the prompt.

NOTE: *To disable security, select PASSWORD SETTING at Main Menu and then password is asked to enter. Do not type anything, just press <Enter> and it will disable security. Once the security is disabled, the system will boot and you can enter Setup freely.*

OS Select for DRAM > 64MB

This segment is specifically created for OS/2 when DRAM is larger than 64MB. If the operating system is OS/2 and DRAM used is larger the 64MB, "OS 2" has to be selected; otherwise (under non-OS2), default is "NON-OS2".

Video BIOS Shadow

Video shadowing increases the video speed by copying the video BIOS into RAM. However, it is still optional depending on the chipset design. The default value of this option is "Enabled".

Enabled	Video BIOS shadowing is enabled
Disabled	Video BIOS shadowing is disabled

C8000 - CBFFF Shadow/DC000 - DFFFF Shadow

Shadowing ROM reduces available memory between 640KB and 1024KB. These fields determine whether optional ROM is copied to RAM or not.

DRAM Timing By SPD

This item is selected depending on whether the board has paged DRAMs or EDO (extended data output) DRAMs.

DRAM Clock

The DRAM clock value is set depending on whether the board has paged DRAMs or EDO (extended data output) DRAMs. The available choices are 66 MHz and Host CLK.

SDRAM Cycle Length

When synchronous DRAM is installed, the number of clock cycles of CAS latency depends on the DRAM timing. Do not reset this field from the default value specified by the system designer. The default setting is **3**.

Memory Hole

To improve performance, certain space in memory is reserved for ISA cards. This memory must be mapped into the memory space below 16MB. The available choices are 15M-16M and Disabled.

P2C/C2P Concurrency

This item enables or disables the PCI to CPU and CPU to PCI concurrency. By default, this field is set to **Enabled**.

System BIOS Cacheable

Selecting "**Enabled**" allows caching of the system BIOS ROM at F0000h-FFFFFh, resulting in better system performance. However, if any program writes to this memory area, a system error may result.
The choice: Enabled, Disabled.

Video RAM Cacheable

Selecting "**Enabled**" allows caching of the A/B segment, resulting in better system performance.
The choice: Enabled, Disabled.

AGP Aperture Size

The field sets aperture size of the graphics. The aperture is a portion of the PCI memory address range dedicated for graphics memory address space. Host cycles that hit the aperture range are forwarded to the AGP without any translation.
The choice: 4M, 8M, 16M, 32M, 64M, 128M and 256M.

OnChip USB

This should be enabled if the system has a USB installed on the system board and the USB will be used. Even when equipped, if a higher performance controller is added, this feature should be disabled.
The choice: Enabled, Disabled.

USB Keyboard Support

Select "*Enabled*" if the system contains a Universal Serial Bus (USB) controller and you have a USB keyboard.
The choice: Enabled, Disabled.

CPU to PCI Write Buffer

When this field is "*Enabled*", writes from the CPU to the PCI bus are buffered to compensate for the speed differences between the CPU and the PCI bus. When "*Disabled*", the writes are not buffered and the CPU must wait until the write is complete before starting another write cycle.

PCI Dynamic Bursting

This item is to enable/ disable the PCI dynamic bursting function.

PCI Master 0 WS Write

When "*Enabled*", writes to the PCI bus are executed with zero wait states.

PCI Delay Transaction

The chipset has an embedded 32-bit posted write buffer to support delay transactions cycles. Select "*Enabled*" to support compliance with PCI specification version 2.1. The default setting is **Disabled**.

PCI#2 Access #1 Retry

When "*Disabled*", PCI#2 will not be disconnected until access finishes (default). When "*Enabled*", PCI#2 will be disconnected if max retries are attempted without success.

AGP Master 1 WS Write

When "*Enabled*", writes to the AGP (Accelerated Graphics Port) are executed with one wait states.

AGP Master 1 WS Read

When "*Enabled*", read to the AGP (Accelerated Graphics Port) are executed with one wait states.

A.2.4 Integrated Peripherals

This option sets the hard disk configuration, mode and port.

Phoenix – Award BIOS CMOS Setup Utility		
Integrated Peripherals		
		Item Help
OnChip IDE Channel0	Enabled	
OnChip IDE Channel1	Enabled	
IDE Prefetch Mode	Enabled	Menu Level F
Primary Master PIO	Auto	
Primary Slave PIO	Auto	
Secondary Master PIO	Auto	
Secondary Slave PIO	Auto	
Primary Master UDMA	Auto	
Primary Slave UDMA	Auto	
Secondary Master UDMA	Auto	
Secondary Slave UDMA	Auto	
Init Display First	P C I S I ot	
IDE HDD Block Mode	Enabled	
Onboard FDD Controller	Enabled	
Onboard Serial Port 1	3F8/IRQ4	
Onboard Serial Port 2	2F8/IRQ3	
UART 2 Mode	Standard	
IR Function Duplex	Half	
TX, RX inverting enable	No, Yes	
Onboard Parallel Port	378/IRQ7	
Onboard Parallel Mode	Normal	
X ECP Mode Use DMA	3	
X Parallel Port EPP Type	EPP1.9	
Onboard Serial Port 3	3E8H	
Serial Port 3 Use IRQ	IRQ 10	
Onboard Serial Port 4	2E8H	
Serial Port 4 Use IRQ	IRQ 11	
Onboard Legacy Audio	Enabled	
X Sound Blaster	Di sabl ed	
X SB I/O Base Address	220H	
X SB IRQ Select	IRQ 5	
X SB DMA Select	DMA 1	
X MPU-401	Disabled	
X MPU-401 I/O Address	330-333H	
ÇÈÆÅ : Move Enter: Select +/-/PU/PD: Value F10: Save ESC: Exit F1: General Help F5: Previous Values F6: Fail-Safe Defaults F7: Optimized Defaults		

On-Chip IDE Channel0/Channel1

The integrated peripheral controller contains an IDE interface with support for two IDE channels. Select "*Enabled*" to activate each channel separately.

The choice: Enabled, Disabled.

IDE Prefetch Mode

The onboard IDE drive interface supports IDE prefetching for faster drive accesses. If a primary and/or secondary add-in IDE interface are installed, set this field to "*Disabled*" if the interface does not support prefetching.

Primary/Secondary Master/Slave PIO

The four PIO (Programmed Input/Output) fields sets a PIO mode (0-4) for each of the four IDE devices that the onboard IDE interface supports. Modes 0 through 4 provide successively increased performance. In Auto mode, the system automatically determines the best mode for each device.

The choice: Auto, Mode 0, Mode 1, Mode 2, Mode 3, Mode 4.

Primary/Secondary Master/Slave UDMA

Ultra DMA/33 implementation is possible only if your IDE hard drive supports it and the operating environment includes a DMA driver (Windows 98 or a third-party IDE bus master driver). If the hard drive and the system software both support Ultra DMA/33, select Auto to enable BIOS support.

The Choice: Auto, Disabled.

Init Display First

This item is to active whether PCI Slot or on-chip VGA first.

The choice: PCI Slot, Onboard.

IDE HDD Block Mode

Block mode is also called block transfer, multiple commands, or multiple sector read/write. If the IDE hard drive supports block mode (most new drives do), select "*Enabled*" for automatic detection of the optimal number of block read/writes per sector the drive can support.

The choice: Enabled, Disabled

Onboard FDD Controller

Select "*Enabled*" if the system has a floppy disk controller (FDC) installed on the system board and the FDC will be used. If the and-in FDC are installed or the system has no floppy drive, select "*Disabled*" in this field.

The choice: Enabled, Disabled.

Onboard Serial Port 1/Port 2

Select an address and corresponding interrupt for the first, second and third serial ports.

The choice: 3F8/IRQ4, 2E8/IRQ3, 3E8/IRQ4, 2F8/IRQ3, Disabled, Auto.

UART 2 Mode

This item is to select UART mode. By default, this field is set to *Standard*.

IR Function Duplex

This item is to select the IR half/full duplex function.

TX,RX inverting enable

This item is to enable the TX, RX inverting which depends on different H/W requirement. This field is not recommended to change its default setting for avoiding any error in the system.

Onboard Serial Port 3

This item allows you to determine access onboard serial port 3 with which I/O address. The options available are 3F8H/2F8H/3E8H/2E8H/Disabled.

Serial Port 3 Use IRQ

Select an corresponding interrupt for the 3rd. serial port. The options available are IRQ10/11/3/4/5/7/9.

Onboard Serial Port 4

This item allows you to determine access onboard serial port 4 with which I/O address. The options available are 3F8H/2F8H/3E8H/2E8H/Disabled.

Serial Port 4 Use IRQ

Select an corresponding interrupt for the 4th. serial port. The options available are IRQ10/11/3/4/5/7/9.

Onboard Parallel Port

This item is to determine access onboard parallel port controller with which I/O address.

The choice: 3BC/IRQ7, 378/IRQ7, 278/IRQ5, Disabled.

Onboard Parallel Mode

Select an operating mode for the onboard parallel (printer) port. Select *Normal*, *Compatible*, or *SPP* unless you are certain your hardware and software both support one of the other available modes.

The choice: SPP, EPP, ECP, ECP+EPP.

ECP Mode Use DMA

Select a DMA channel for the parallel port for use during ECP mode.
The choice: 3, 1.

A.2.5 Power Management Setup

The Power Management Setup is to save energy of the system effectively. It will shut down the hard disk and turn OFF video display after a period of inactivity.

Phoenix – Award BIOS CMOS Setup Utility		
Power Management Setup		
ACPI Function	Disabled	Item Help
Power Management	Press Enter	
PM Control by APM	Yes	Menu Level F
Video Off Option	Suspend -> Off	
Video Off Method	V/H SYNC+Blank	
MODEM Use IRQ	3	
Soft-Off by PWRBTN	Instant-Off	
Wake Up Events	Press Enter	
◀▶⏪⏩ : Move Enter: Select +/-/PU/PD: Value F10: Save ESC: Exit F1: General Help F5: Previous Values F6: Fail-Safe Defaults F7: Optimized Defaults		

ACPI Function

This item is to enable/disable the Advanced Configuration and Power Interface (ACPI).

The choice: Enabled, Disabled.

Power Management

This item is to select the Power Management mode.

The choice: User Define, Min Saving, Max Saving.

PM Control by APM

When enabled, an Advanced Power Management device will be activated to enhance the Max. Power Saving mode and stop the CPU internal clock. If Advance Power Management (APM) is installed on the system, selecting "Yes" gives better power savings. If the Max. Power Saving is not enabled, this will be preset to "No".

Video Off Option

When enabled, this feature allows the VGA adapter to operate in a power saving mode.

Always On	Monitor will remain on during power saving modes.
Suspend --> Off	Monitor blanked when the system enters the Suspend mode.
Susp,Stby --> Off	Monitor blanked when the system enters either Suspend or Standby modes.
All Modes --> Off	Monitor blanked when the system enters any power saving mode.

Video Off Method

This determines the manner in which the monitor is blanked.

V/H SYNC + Blank	This causes the system to turn off the vertical and horizontal synchronization ports and write blanks to the video buffer.
DPMS	Select this option if your monitor supports the Display Power Management Signaling (DPMS) standard of the Video Electronics Standards to select video power management values.
Blank Screen	This option only writes blanks to the video buffer.

Video Off Method

In suspending, this item is to select the CRT closed method under APM mode.

The choice: Blank Screen, V/H SYNC+Blank, DPMS

MODEM Use IRQ

APM 1.2 function used only.

The choice: NA, 3, 4, 5, 7, 9, 10, 11

Soft-off by PWRBTN

This only works with the system using an ATX power supply. It also allows user to define the type of soft power OFF sequence for the system to follow.

Instant-Off (default)	This option follows the conventional manner systems perform when power is turned OFF. Instant-Off is a soft power OFF sequence requiring only the switching of the power supply button to OFF.
Delay 4 Sec.	Upon turning OFF system from the power switch, this option will delay the complete system power OFF sequence by approximately 4 seconds. Within this delay period, system will temporarily enter into Suspend Mode enabling you to restart the system at once.

Wake Up Events

An input signal on the network 2 awakens the system from a soft-off state.

A.2.6 PNP/PCI Configuration

This section describes the PCI bus system configuration. PCI or Personal Computer Interconnect is a system which allows I/O devices to operate at speeds nearing the speed of the CPU when communicating with its own special components. This section covers some very technical items, and it is strongly recommended that only experienced users should make changes to the default settings.

Phoenix – Award BIOS CMOS Setup Utility PnP/PCI Configurations		
PNP OS Installed	No	Item Help
Reset Configuration Data	Disabled	Menu Level F
Resources Controlled By	Manual	Select Yes if you are using a Plug and play capable operating system select No if you need the BIOS to configure non-boot devices
X IRQ Resources	Press Enter	
X DMA Resources	Press Enter	
PCI/VGA Palette Snoop	Disabled	
Assign IRQ For VGA	Enabled	
Assign IRQ For USB	Enabled	
Ç.Æ.Å : Move Enter: Select +/-/PU/PD: Value F10: Save ESC: Exit F1: General Help F5: Previous Values F6: Fail-Safe Defaults F7: Optimized Defaults		

PNP OS Installed

This item is to determine install PnP OS or not. The options available are Yes and No.

Reset Configuration Data

Normally, this field is “Disabled”. Select “Enabled” to reset Extended System Configuration Data (ESCD). When exiting Setup or installed a new add-on, the system reconfiguration has caused such a serious conflict that the operating system cannot boot. The options available are Enabled and Disabled.

Resource controlled by

The Award Plug and Play BIOS has the capacity to automatically configure all of the boot and the Plug and Play compatible devices. However, this capability means absolutely nothing unless using a Plug and Play operating system such as Windows®98. The options available are Auto and Manual.

IRQ Resources

When resources are controlled manually, assign each system interrupt a type, depending on the type of device using the interrupt.

DMA Resources

When resources are controlled manually, assign each system DMA channel as one of the following types, depending on the type of device using the interrupt:

1. Legacy ISA Devices compliant with the original PC AT bus specification, requiring a specific DMA channel.
2. PCI/ISA PnP Devices compliant with the Plug and Play standard, whether designed for PCI or ISA bus architecture.

The default value is "PCI/ISA PnP".

PCI/VGA Palette Snoop

Leave this field at "Disabled".
The choice: Enabled, Disabled.

Assign IRQ For USB/VGA

This item is to enable or disable the IRQ assignment for USB/VGA. The options available are Enabled, Disabled

A.2.7 PC Health Status

This section is to monitor the current hardware status of core voltages. This is available only if there is hardware monitoring mechanism onboard.

Phoenix – Award BIOS CMOS Setup Utility		
PC Health Status		
Current CPU Temp.	22° C/71° C	
Current System Temp.	22° C/71° C	
Vcore	1.06V	
2.5V	2.5V	
3.3V	3.34V	
5V	5.12V	
12V	11.84V	

← → : Move Enter: Select +/-/PU/PD: Value F10: Save ESC: Exit F1:
General Help
F5: Previous Values F6: Fail-Safe Defaults F7: Optimized Defaults

2.5V/3.3V/5V/12V

Show the voltage of 2.5V/3.3V/5V/12V

A.2.9 Load Fail-Safe Defaults

This option is to load the troubleshooting default values permanently stored in the BIOS ROM. These default settings are non-optimal and disable all high-performance features.

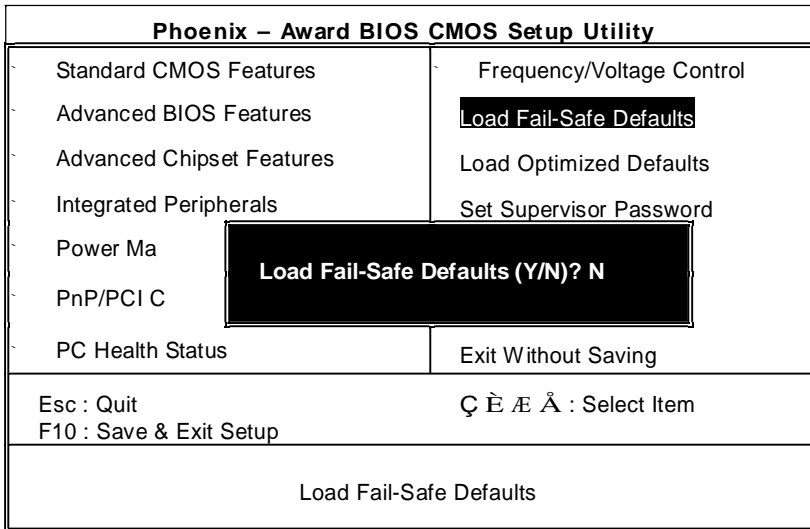

To load BIOS defaults value to CMOS SRAM, enter “Y”. If not, enter “N”.

A.2.11 Set Supervisor/User Password

Either supervisor or user password, or both of them can be set in this option. The differences between them are:

1. supervisor password: can enter and change the options of the setup menus.
2. user password: just can enter but do not have the right to change the options of the setup menus.

When this function is selected, the following message will appear at the center of the screen for creating a password.

ENTER PASSWORD:

Type the password with eight characters at most, and press <Enter>. The password typed will now clear any previously entered password from CMOS memory. Then, confirm the password by typing the password again and pressing <Enter>. Or, not enter a password and abort the selection by pressing <Esc>.

To disable the password by pressing <Enter> without typing in any password when the message "Enter Password" is showed. Then, message below will appear to confirm that the password has been disabled.

PASSWORD DISABLED.

Once the password is disabled, the system will boot and enter Setup freely.

When a password is enabled, it has to be typed to enter the Setup every time. This prevents any unauthorized person from changing the system configuration.

Additionally when a password is enabled, the BIOS can also set to request a password every time the system reboots. This would prevent unauthorized use of the computer.

The user can determine when the password is required within the BIOS Features Setup Menu and its Security option. If the Security option is set to "System", the password is required during boot up and entry into Setup. If it set as "Setup", prompting will only occur prior to entering Setup.

A.2.12 Save & Exit Setup

This is to determine whether or not to accept the modifications. Typing "Y" quits the setup utility and saves all changes into the CMOS memory. Typing "N" brings back to Setup utility.

Phoenix – Award BIOS CMOS Setup Utility	
Standard CMOS Features	Frequency/Voltage Control
Advanced BIOS Features	Load Fail-Safe Defaults
Advanced Chipset Features	Load Optimized Defaults
Integrated Peripherals	Set Supervisor Password
Power Man	SAVE to CMOS and EXIT (Y/N)? Y
PnP/PCI Con	
PC Health Status	Exit Without Saving
Esc : Quit	◀ ▶ ↻ ⏪ ⏩ : Select Item
F10 : Save & Exit Setup	
Save Data to CMOS	

A.2.13 Exit Without Saving

Select this option to exit the Setup utility without saving the changes made in this session. Typing "Y" will quit the Setup utility without saving the modifications. Typing "N" will return to Setup utility.

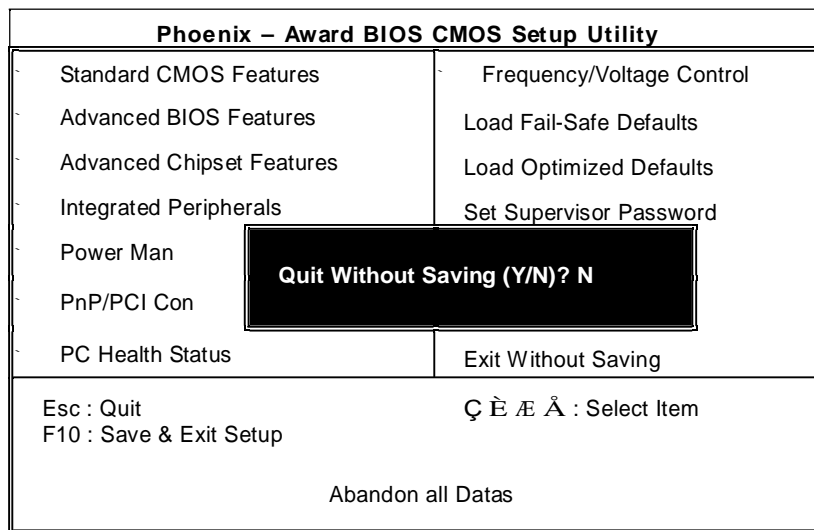

Free Manuals Download Website

<http://myh66.com>

<http://usermanuals.us>

<http://www.somanuals.com>

<http://www.4manuals.cc>

<http://www.manual-lib.com>

<http://www.404manual.com>

<http://www.luxmanual.com>

<http://aubethermostatmanual.com>

Golf course search by state

<http://golfingnear.com>

Email search by domain

<http://emailbydomain.com>

Auto manuals search

<http://auto.somanuals.com>

TV manuals search

<http://tv.somanuals.com>