



## TECHNICAL INFORMATION

### SATELLITE SPEAKERS:

A patented advanced technology driver featuring a unique heat transfer system: special high excursion suspension and a computer-designed anti-resonant cone

### INPUTS:

- 3 x RCA Phono - Line level
- 1 x Stereo Mini jack - Line level

### OUTPUTS:

- 3 x Speaker terminals

### CONTROLS:

- 1 x Volume / Power pot
- 1 x Bass switch (3 Position)
- 1 x Centre input switch (2 Position)

### ACCESSORIES:

- 2 x 5 metre Speaker cables
- 1 x 2 metre Signal input cable
- 1 x Speaker level to line level adaptor cable
- 2 x Wall brackets

### POWER RATINGS:

- 120V Model - 120V @ 60Hz; 80VA
- 240V Model - 140V @ 50Hz; 80VA

### DIMENSIONS:

- Sub Woofer - 265mm x 190mm x 350mm
- Satellites - 68mm x 103mm x 90mm

### WEIGHT:

- 9 Kg

### FINISHES:

- Black sub woofer
- Textured black satellites with silver/grey grilles

- White sub woofer
- Textured white satellites with silver/grey grilles

## ENGLISH

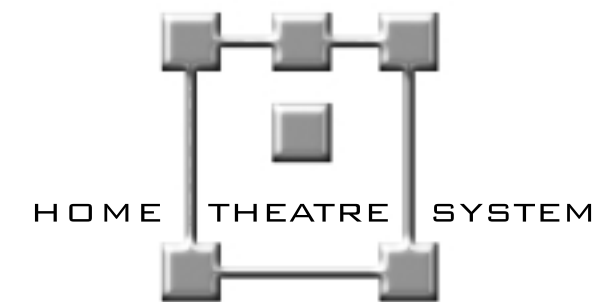

SMART | ACTIVE | SOUND

## WARRANTY

Your Acoustic Energy loudspeakers are guaranteed against original defects in materials, manufacture and workmanship for 1 year from the date of purchase. Please retain all original packaging materials for possible future use.

Under this warranty Acoustic Energy agrees to repair any defect or, at the company's discretion, replace the faulty component(s) without charge for parts and labour. This warranty does not imply any acceptance by Acoustic Energy or its agents for consequential loss damage and specifically excludes fair wear and tear, accident misuse or unauthorised modification.

This warranty is applicable in the United Kingdom only and does not in any way limit the customer's legal rights. Claims and enquiries under the warranty for AE products purchased outside the UK should be addressed to the local importers or distributors.

If you have reason to claim under the warranty please contact your dealer in the first instance.



Designed by KOI Inc (USA) Exclusively for Acoustic Energy Limited (UK)  
Manufactured in Malaysia.

Acoustic Energy Limited, 16 Bridge Road, Cirencester, Gloucestershire GL7 1NJ. UK  
Tel: +44 (0)1285 654432 Fax: +44 (0)1285 654430

[WWW.AEGOS.COM](http://WWW.AEGOS.COM)

## WARNING

To reduce the risk of fire or electric shock, do not expose this system to rain or moisture.

## CAUTION

To reduce the risk of shock, do not remove the cover of this system. There are no user-serviceable parts inside. Refer servicing to qualified service personnel.

The **CAUTION** marks shown on this page are located on the back of your system.



The lightning flash, with arrowhead symbol within an equilateral triangle, is intended to alert the user to the presence of uninsulated "dangerous voltage" within the system enclosure that may be of sufficient magnitude to constitute a risk of electric shock.



The exclamation point within an equilateral triangle as marked on the system is intended to alert the user to the presence of important operating and maintenance instructions in this owner's guide.

CAUTION	ATTENTION
Risk of electrical shock <b>Do not open</b>	Risque de choc électrique <b>Ne pas ouvrir</b>

## IMPORTANT SAFETY INSTRUCTIONS

To ensure your safety, please read these instructions before operating this unit.

1. Follow all instructions and observe warnings marked on the unit.
2. Always use the correct line voltage. Please refer to page 6, and find out the correct power requirements in your area. Please note that different operating voltages may require the use of different adapters.
3. Do not install the unit in an unventilated rack, or directly above heat producing equipment such as power amplifiers.
4. To avoid shock or fire hazard, do not expose the unit to rain or moisture, or operate it where it will be exposed to water.
5. Do not attempt to operate the unit if it has been dropped, damaged, exposed to liquids, or if it exhibits a distinct change in performance indicating the need for service.
6. Only qualified service personnel should open this unit.
8. Removing covers will expose you to hazardous voltages.
9. Do not overload wall outlet, extension cords or integral convenience receptacles, as this can result in a risk of fire or electrical shock.
10. Route power supply cords so that they are not likely to be walked on or pinched by items placed on or against them, paying particular attention to cords at plugs, mains adapters, and the point at which they exit from the unit.

The Acoustic Energy AEG05 is a powered 5.1 surround sound speaker system designed to give maximum acoustic performance with minimal visual impact. It will enable you to fill your room with sound rather than speakers and get the best from your AV surround system.

This manual will help you to get the best out of your AEG05 system and explain how to link it up with your existing digital decoder (AEG05) or straight to your DVD player through the Acoustic Energy Aego decoder (AEG0P5).

### SECTION ONE

- will deal with the AEG05 speaker system, how to integrate your existing decoder and placement of your Aego satellite speakers.

### SECTION TWO

- will provide details of the Acoustic Energy Dolby Digital/DTS decoder that is supplied in the AEG0P5 system. Also, how to connect your DVD player along with other ancillary equipment.

Contents listing:

#### AEG05

- 1 x AEG05 subwoofer
- 5 x AEG05 Satellite Speakers
- 5 x Wall Brackets
- 4 x rubber feet for subwoofer
- 1 x Multi-way signal cable 3M (6 x RCA Phono to 1 x Multi-pin)
- 1 x Speaker lead 3.5M
- 2 x Speaker leads 5.5M
- 2 x Speaker leads 10M
- 1 x Owners manual
- 1 x Car Sticker

#### AEG0P5 - AS AEG05 PLUS

- 1 x AEG0P5 Dolby Digital / DTS decoder
- 1 x power supply
- 1 x remote control
- 2 x batteries for remote control
- 1 x Multi-pin signal cable 3M (G9 multi-pin to G9 multi-pin)

## CONTENTS

Important Safety Instructions	2
Introduction	3
Unpacking	3
Connecting AEG05 (with External Power Amplifier)	4
Key AEG05 Controls	4
AEG05 Speaker Placement	5
AEG05 Speaker Orientation	5
Connecting AEG0P5	7
Key AEG0P5 Controls	7
AEG0P5 Front Panel	8
AEG0P5 Rear Panel	8
AEG0P5 Remote Control	9
AEG0P5 Operation	10
LCD & LEDs	10
LCD Display	10
Mode Selection	10
Input Selection	10
Test Mode	11
Mute Mode	11
Master Volume Control	11
Balance Setting	11
Delay Calibration	12
Time Delay Adjustment on Centre Channel Speaker	12
Time Delay Adjustment on Rear Surround Speakers	12
Pro Logic Mode	13
Speaker Mode with Bass Manager	13
Saving Presets	14
Loading Presets	14
Sound Field Processing	14
Equalization	14
DRC (Dynamic Range Compression)	15
Resetting	15
Technical Information	16
Warranty	16

# CONNECTING AEGO5

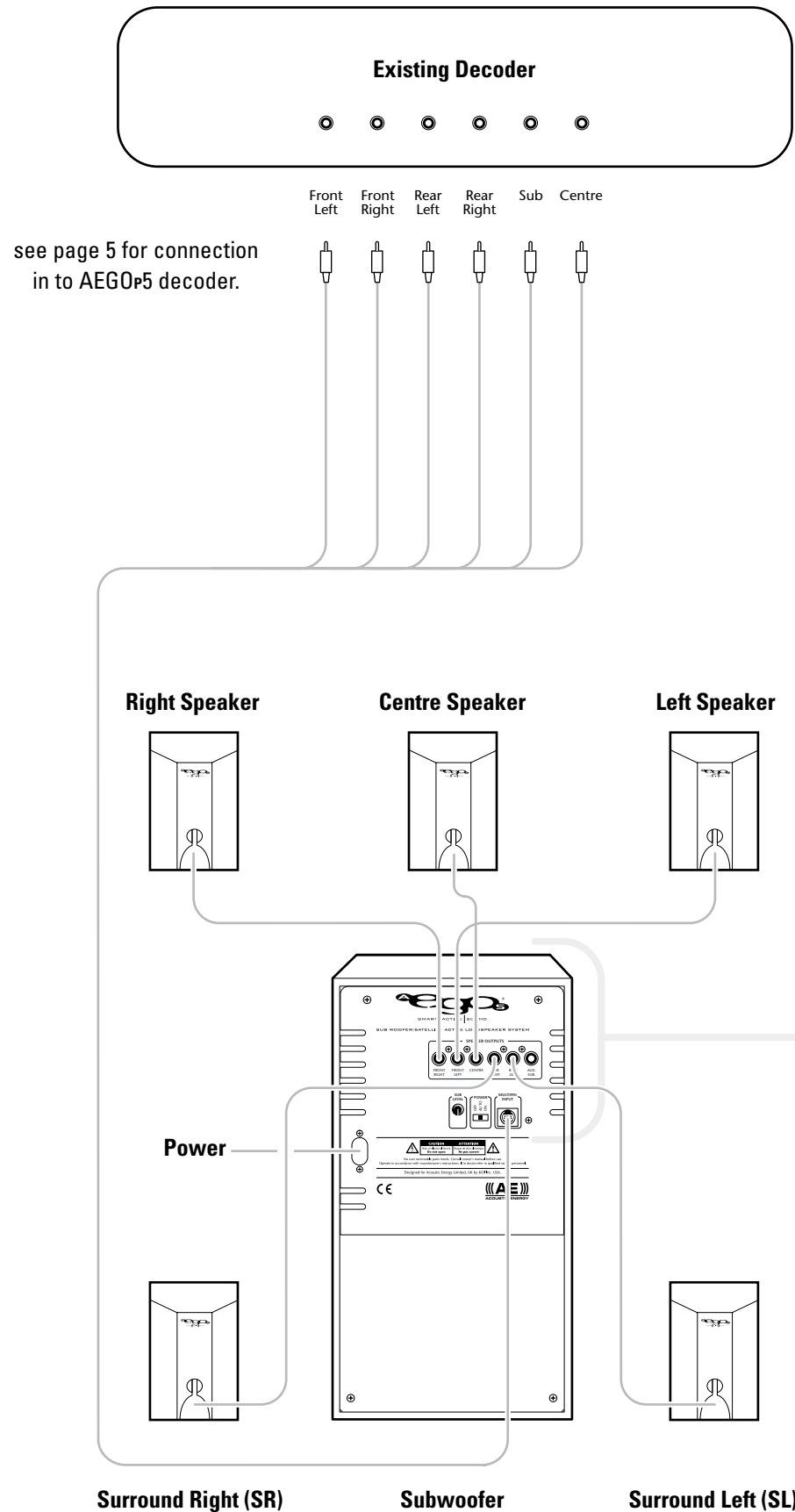

## Controls

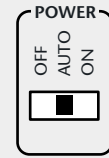

When set to "AUTO" the Aego system will go in to standby mode if no signal is detected for a period of time (10 minutes). It will automatically switch back on when a signal is detected.



**Sub Level**  
This can be altered to obtain preferred level of bass.



**Sub output**  
This output is available to supply an auxiliary subwoofer such as the "Acoustic Energy Aegis Compact Sub". This may be recommended when used in a large room.

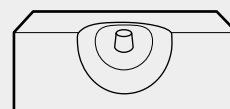

**Volume knob**  
This is the main volume control for all channels. When used with a decoder it would normally be set to maximum. This enables the Aego5 system to be used with DVD players that have a built in decoder but no overall volume control.

# AEGO5 SPEAKER PLACEMENT

As with all loudspeakers, the placement in relationship to room boundaries (walls etc.) will have a major effect on their overall performance. As the Aego Satellites are so small your choice of positions is far greater and you should use this to maximize the performance of these remarkable little speakers.

If a speaker is positioned in free air (not close to any walls etc.) then it will sound brighter. If mounted on or close to a large object (such as a table or on a wall) then the mid range will become louder and the speaker will sound warmer and more powerful.

In most situations we would recommend that the satellites are mounted on walls at about head height with the brackets provided to give you a warm powerful sound that you will find pleasing and comfortable. However if this is not possible then Aego Speaker Stands are available from your dealer.

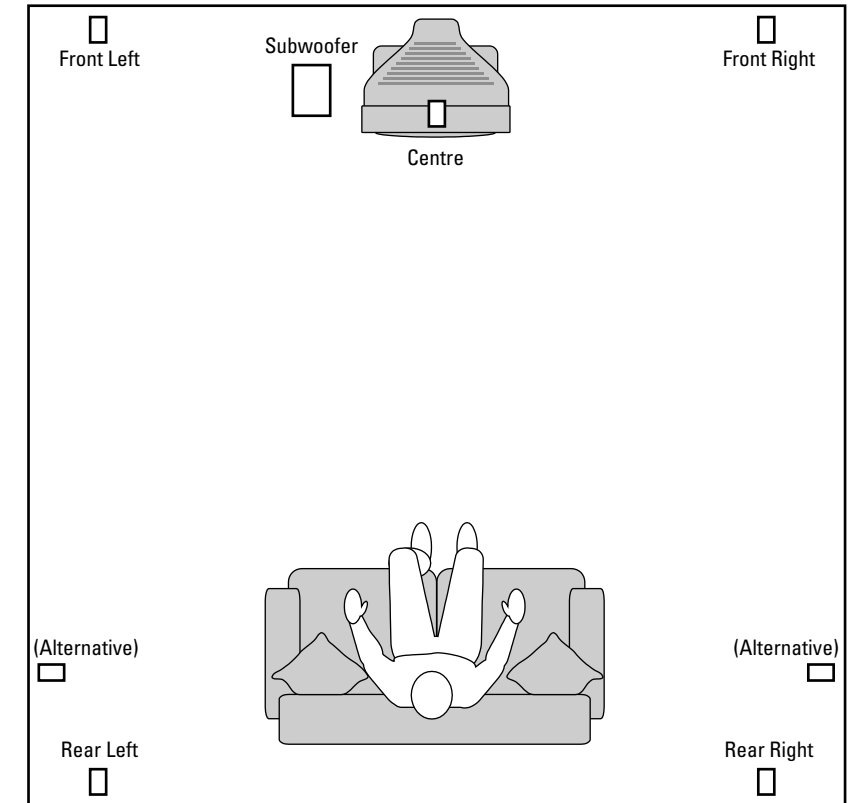

## SURFACE MOUNTING

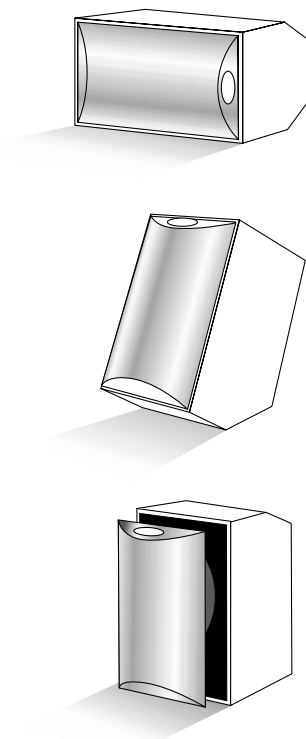

Detachable grille can rotate to suit speaker orientation.

## STAND MOUNTING

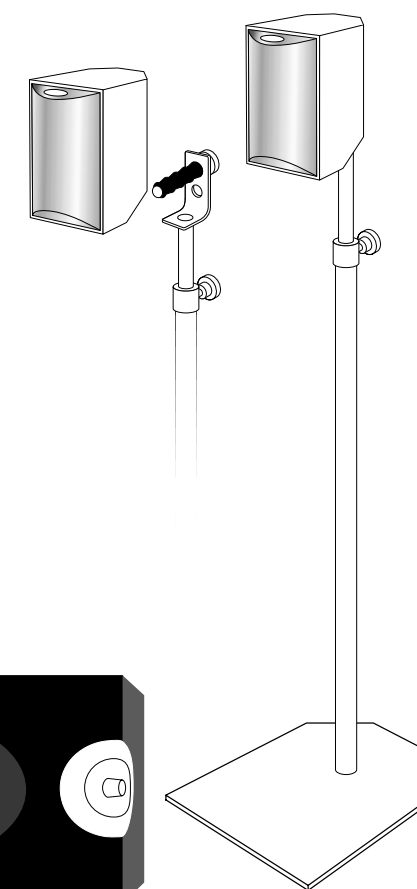

## WALL MOUNTING

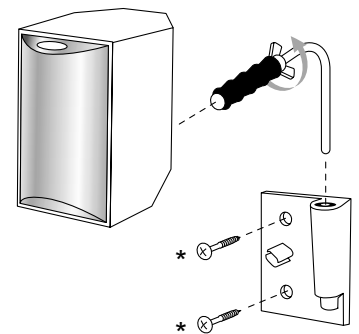

\* Not supplied

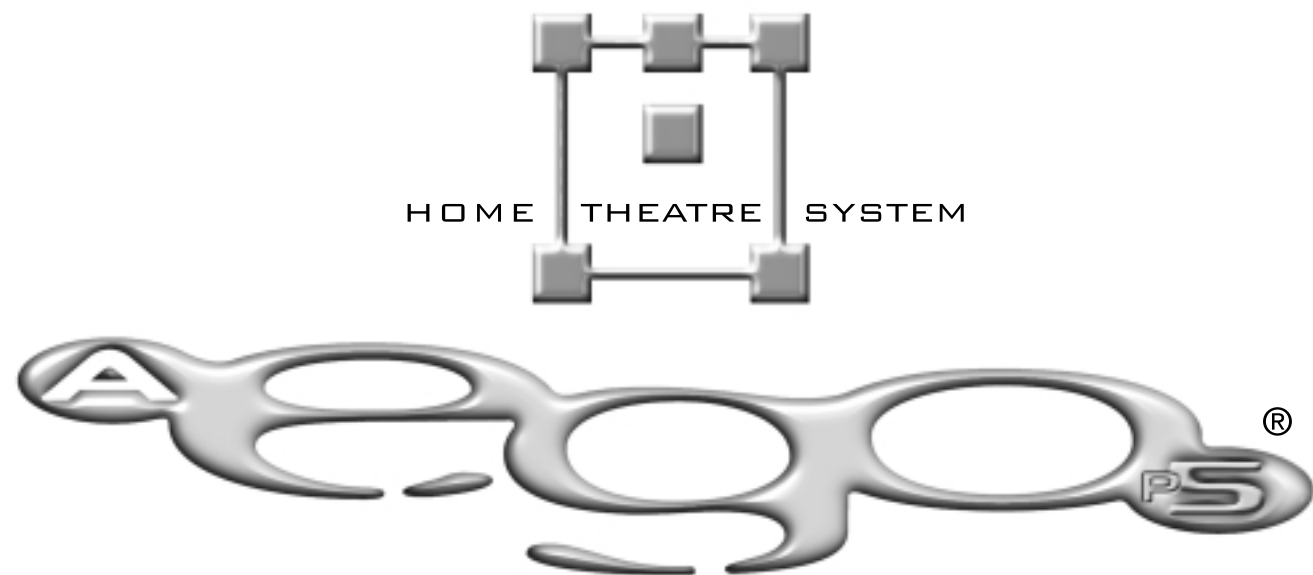

SMART | ACTIVE | SOUND



ACKNOWLEDGMENTS & TRADEMARKS



All contents are subject to change at any time without notice. No responsibility is assumed for its use; or for infringements of patents or other rights of third parties and no patent or license is implied hereby.

All trademarks are the property of their respective owners. Manufactured under license from Dolby Laboratories. "Dolby", "Pro Logic" and the double-D symbol are trademarks of Dolby Laboratories. Confidential Unpublished Works. (c)1992 - 1997 Dolby Laboratories, Inc. All rights reserved.



Manufactured under license from Digital Theater Systems, Inc. US Pat. No. 5,451,942, 5,956,674, 5,974,380, 5,978,762 and other worldwide patents issued and pending. "DTS" and "DTS Digital Surround" are registered trademarks of Digital Theater Systems, Inc. Copyright 1996, 2000 Digital Theater Systems, Inc. All Rights Reserved.

FCC COMPLIANCE STATEMENT

The equipment has been tested and found to comply with the limits for a Class B digital device, pursuant to Part 15 of the FCC Rules. These limits are designed to provide reasonable protection against harmful interference in residential installation. This equipment generates, uses, and can radiate radio frequency energy and, if not installed and used in accordance with the instructions, may cause harmful interference to radio communications. However, there is no guarantee that interference will not occur in a particular installation. If this equipment does cause interference to radio or television reception, which can be determined by turning the equipment off and on, the user is encouraged to try to correct the interference by one or more of the following measures:

- Reorient or relocate the receiving antenna.
- Increase the separation between the equipment and receiver.
- Connect the equipment into an outlet on a circuit different from that to which the receiver is connected.
- Consult the dealer or an experienced radio/TV technician for help.

Notice

This device complies with Part 15 of the FCC rules. Operation is subject to the following two conditions: (1) this device may not cause harmful interference, and (2) this device must accept any interference received, including interference that may cause undesired operation. Shielded cables and I/O cords must be used for this equipment to comply with the relevant FCC regulations.

CONNECTING AEGIO5

(WITH 5.1 THEATRE SYSTEM)

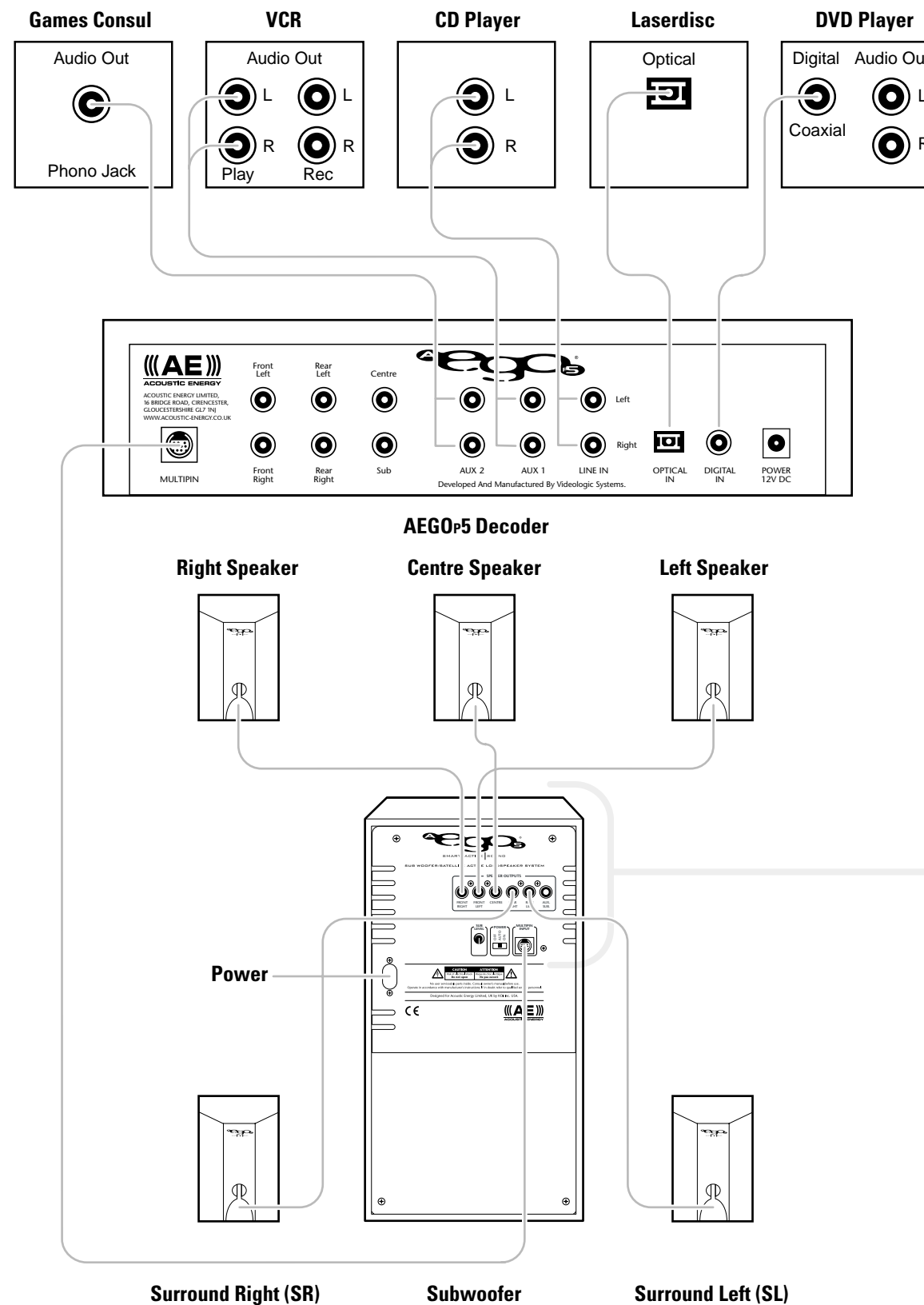

Controls

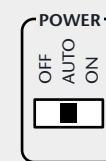

When set to "AUTO" the Aego system will go in to standby mode if no signal is detected for a period of time (10 minutes). It will automatically switch back on when a signal is detected.



**Sub Level**  
This can be altered to obtain preferred level of bass.



**Sub output**  
This output is available to supply an auxiliary subwoofer such as the "Acoustic Energy Aegis Compact Sub". This may be recommended when used in a large room.

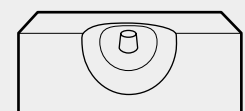

**Volume knob**  
This is the main volume control for all channels. When used with a decoder it would normally be set to maximum, This enables the Aego5 system to be used with DVD players that have a built in decoder but no overall volume control.

1. After properly connecting AEGIO5 to your audio sources and amplifier, plug in AEGIO5's AC adapter to an AC outlet.
2. Turn on the power of AEGIO5 by pushing the POWER button on the front panel. Turn on the power of all audio sources, amplifier, or powered subwoofer.
3. Installation is now complete, get ready to experience true Dolby Digital or DTS surround sound.

**Note:** To prevent damage to speakers, when playing music or a movie, ensure the volume is set low initially. Gradually turn the volume up to an appropriate level after the playback has started.

## AEGOP5 DECODER



### AEGOP5 FRONT PANEL

**1. The POWER Button**  
Turns AEGOP5 on or off.

**2. LCD Display**  
Provides you with information regarding the system status and settings.

**3. Speaker Channel LEDs**  
Each LED represents the status of an individual channel. When a particular channel is active, the LED lights up. The colour of the LED also indicates the frequency range of that channel:

- \* Red means this particular channel has been set to output a wider frequency range that contains bass signal between 20Hz to 120Hz.
- \* Green means this particular channel doesn't contain the bass signal between 20Hz to 120Hz.

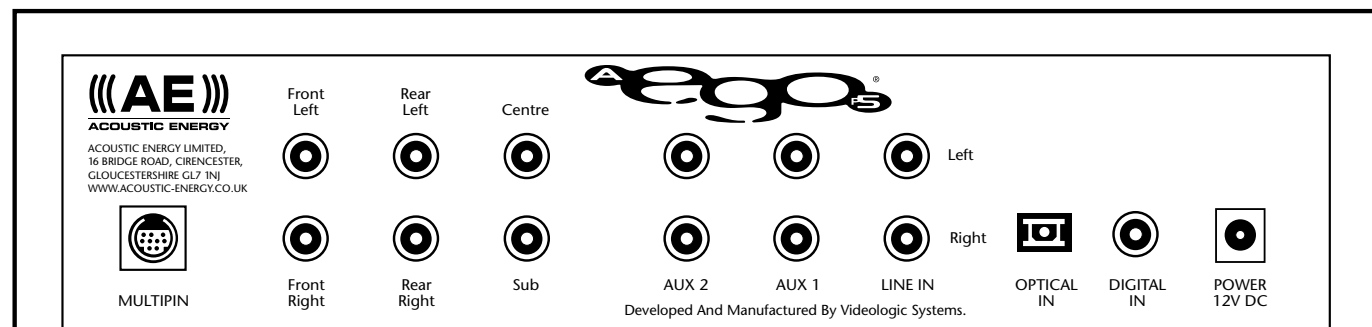

### AEGOP5 REAR PANEL

**1. MULTIPIN Audio Output:**

This output feeds 6 channels audio signals to the matching input on a control centre or power amplifier via a multipin (DIN) cable.

**2. Main Outputs (Front Left, Front Right, Rear Left, Rear Right, Centre and Sub):**

The Six outputs feed audio signals to the matching inputs on a control centre or power amplifier.

**3. AUX1 AUX2 and LINE Inputs:**

These inputs accept signals from stereo analog signal sources.

**4. OPTICAL and DIGITAL inputs:**

Your AEGOP5 has two types of digital inputs. One S/PDIF (OPTICAL) and one coaxial (DIGITAL) input. Connect the digital outputs of the sound sources to these inputs.

**5. 12V DC Power Input:**

Connect the AEGOP5 power adapter to an AC outlet. Please refer to page 6 to determine the correct voltage in your area.

## AEGOP5 REMOTE CONTROL

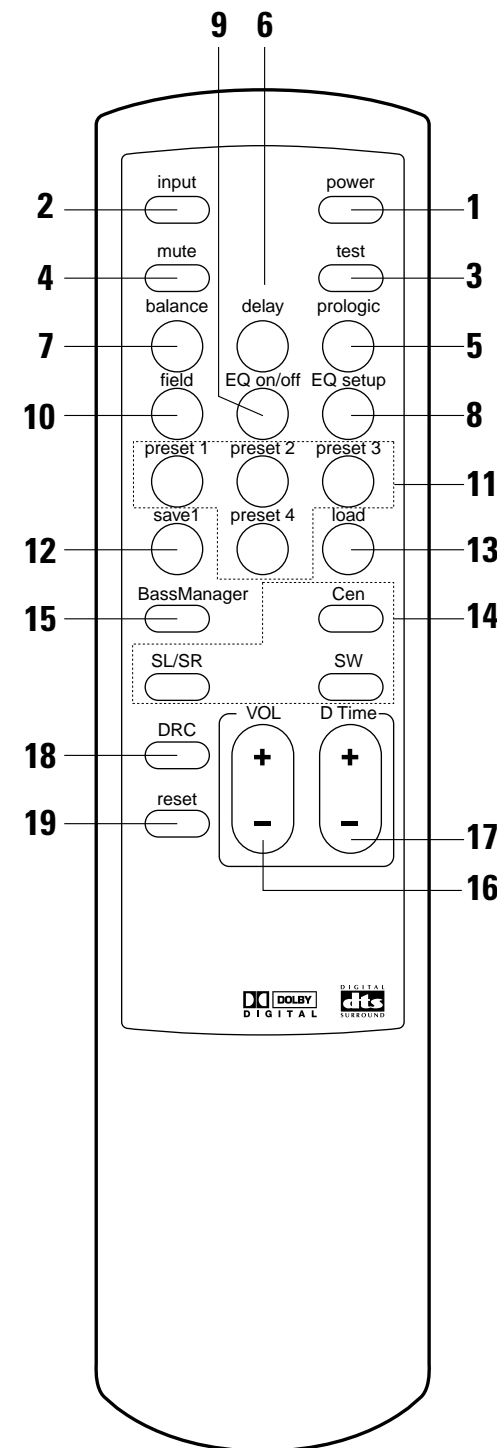

- 1 POWER Button**  
On/off key
- 2 INPUT MODE Button**  
Select from the 5 different source inputs
- 3 TEST Button**  
Test signal for the 6 discrete channels
- 4 MUTE Button**  
Mute the sound (toggle on and off)
- 5 PRO LOGIC Button**  
Select from 4 different surround settings
- 6 DELAY Button**  
Select the desired channel to engage the time delay adjustment
- 7 BALANCE Button**  
Set the volume setting for each of the 6 channels
- 8 EQ SETUP Button**  
Select up to 5 EQ Band Settings
- 9 EQ ON/OFF Button**  
Activate the selected EQ Band Setting
- 10 FIELD Button**  
Select from 6 different sound fields
- 11 PRESET Button (P1, P2, P3, P4)**  
Recall up to 4 different presets
- 12 SAVE Button**  
Store your settings into a selected preset
- 13 LOAD Button**  
Activate your saved setting stored in selected preset
- 14 SPEAKER ON/OFF Buttons (CEN, SL/SR, SW)**  
CEN Button activates/deactivates the centre channel speaker.  
LS/RS Button simultaneously activates/deactivates the left and right rear speakers.  
SW Button activates/deactivates the subwoofer.
- 15 BASS MANAGER Button**  
Switches between three bass configurations (bass config.1, bass config.2 and bass config.3)
- 16 VOL + and VOL -**  
Increase/decrease the volume.
- 17 D TIME Button**  
Increase/decrease the delay time.
- 18 DRC Button**  
Select among 3 different dynamic range compression ratios.
- 19 RESET Button**  
Resets the system to its factory default settings.

## AEGOP5 OPERATION

The following pages provide information on the operation of AEGOP5. The AEGOP5 was purposely designed to be simple to operate with all functions available from the remote control.

### AEGOP5 OPERATION - LCD AND LEDs

1. Press the power button to turn the AEGOP5 on, press it again to turn it off.
2. When power is turned off but still connected to the mains:
  - a. LCD display and Speaker Configuration LEDs are off.
  - b. Decoder status and user configurations are stored.
  - c. Once the power is turned on again, AEGOP5 will resume to its previous decoder status and user configurations.
3. When power is turned off and the unit unplugged from the mains:
  - a. LCD display and Speaker Configuration LEDs are off.
  - b. Decoder status and user configurations are not stored.
  - c. AEGOP5 will reset to factory defaults if the adaptor is reconnected to the mains.

### AEGOP5 OPERATION - LCD DISPLAY

#### Auto Decode Mode (Auto detection of input type)

When AEGOP5 is turned on, it automatically detects and identifies the audio signal coming from source unit.

Playing a DVD title with Dolby Digital (AC3) format, the display shows the following information.

DOLBY DIGITAL CO  
SURROUND

Playing a DVD title with DTS format, the display shows the following information.

DTS COAXIAL  
SURROUND

Playing DVD, CD, LD, VCR and games consoles connected to the analog inputs (LINE, AUX1 and AUX2), the display shows the following information.

PCM LINEIN  
STEREO

### AEGOP5 OPERATION - MODE SELECTION

#### Surround Processing Modes:

The versatile AEGOP5 surround sound processor is capable of processing both the digital or analog audio signals from many different types of audio source. With the equipment connected correctly, AEGOP5 automatically detects the type of digital signal present at the digital input.

### AEGOP5 OPERATION - INPUT SELECTION

#### Input Selection

The AEGOP5 can be connected to up to 5 audio sources. Select the input source you want by repeatedly pressing the **INPUT Button** on the remote control until the desired source is selected.

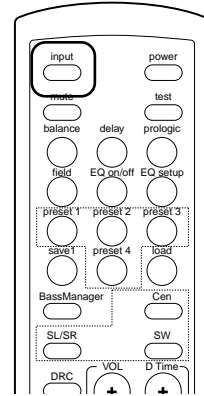

In the **Digital Mode** (Dolby Digital / DTS), you can manually select the audio input source either in coaxial or optical form depending on the input type.

If **"COAXIAL"** is selected, the display shows the following information:

DOLBY DIGITAL CO  
SURROUND

If **"Optical"** is selected, display of AEGOP5 shows the following information:

DOLBY DIGITAL OP  
SURROUND

In the **PCM mode**, you can switch between 3 audio input sources such as CD Player, VCR, game consoles etc. (See page 8 or page 9 for reference). The display shows the following information:

PCM LINEIN  
STEREO

PCM AUX1  
STEREO

PCM AUX2  
STEREO

### AEGOP5 OPERATION - TEST MODE

#### Test Mode

After connecting up to your source and speakers, you can press the **TEST** button on the remote to test the system. You can also use the test mode to test the location of the speakers. When the **TEST** button is pressed, white noise is generated through all satellite speakers in an order of Front Left, Centre, Front Right, Rear Left, and Rear Right channels for 2 seconds each. When completed, the AEGOP5 returns to Auto Decode mode.

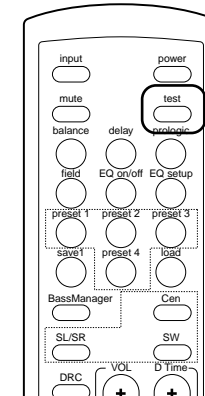

When test mode is running, the display shows information in a sequence as below:

DOLBY DIGITAL CO  
TEST L

DOLBY DIGITAL CO  
TEST C

DOLBY DIGITAL CO  
TEST R

DOLBY DIGITAL CO  
TEST SL

DOLBY DIGITAL CO  
TEST SR

### AEGOP5 OPERATION - MUTE MODE

#### Mute Mode

Pressing **MUTE Button** on the remote control will mute all signal outputs (including the multipin and 6 RCA connectors.)

To disable the mute function, press **MUTE Button** again.

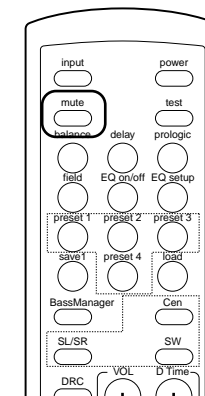

When MUTE Button is pressed, the display shows the following information:

DOLBY DIGITAL CO  
SURROUND MUTE

### AEGOP5 OPERATION - MASTER VOLUME CONTROL

#### Volume Setting

To increase or decrease the master volume of your AEGOP5, simply press **VOL +** or **VOL -** on the remote control.

#### Example:

Volume being decreased by 3 decibels.

DOLBY DIGITAL CO  
VOLUME -03DB

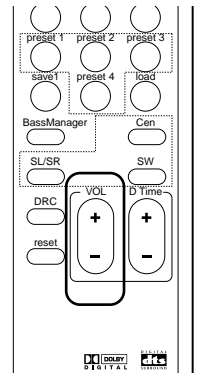

### AEGOP5 OPERATION - BALANCE SETTING

#### Balance Button

You can set the volume setting of each individual channel.

To select a channel, press **BALANCE** button on the remote control repeatedly until the desired channel is reached.

Adjust volume on selected channel by pressing **VOL +** or **VOL -** on the remote control.

#### Example:

Press the **BALANCE** button once to display the current balance volume for channel L (Left).

DOLBY DIGITAL CO  
BALANCE L 00DB

Press the **BALANCE** button again to select the next channel.

DOLBY DIGITAL CO  
BALANCE R 00DB

Press **VOL +** or **VOL -** will increase or decrease the balance volume for selected channel.

DOLBY DIGITAL CO  
BALANCE R +00DB

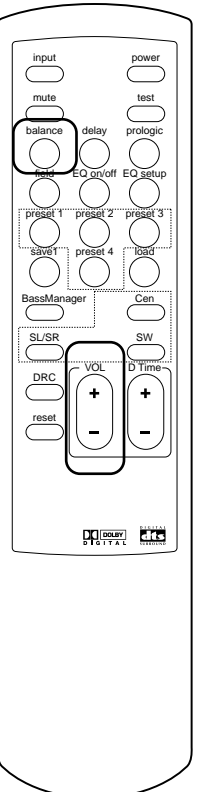



## AEGOP5 OPERATION - DELAY CALIBRATION

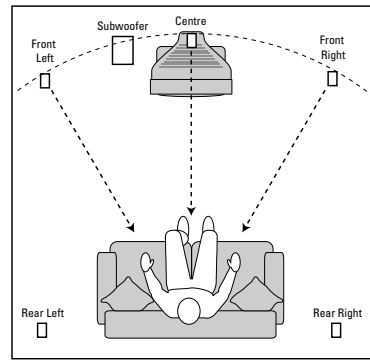

The recommended listening position is described below:

- Centre channel speaker should be placed the same distance as the left and right speakers from your listening position.
- Rear left and right speakers should be placed behind your listening position and above ear level.
- If speaker placement is restricted due to the physical environment of the room, delay calibration is sometimes necessary to achieve the ideal listening environment.
- If the centre speaker can only be placed nearer to you than the left and right speakers, sound from the centre speaker will arrive before the sound from the left and right speakers. The difference in arrival time could affect the sound quality and effect. Your AEGOP5 allows you to adjust the speaker time delay to compensate for this problem by increasing the delay time for the centre channel. Thus sound from the centre, left and right speakers will reach you at the same time. If your centre speaker is closer to your listening position than the left and right speakers, press **DELAY** button repeatedly until the centre channel is selected. To increase or decrease the delay time, press **D TIME +** or **D TIME -** until the desired delay is selected. The same procedure can be applied to adjust the delay time of rear surround speakers if necessary.

## AEGOP5 OPERATION - TIME DELAY ADJUSTMENT ON CENTRE CHANNEL SPEAKER

### Delay Calibration

Press the **DELAY** button and repeat to select the length of delay time for the Rear Left (SL), Rear Right (SR) and Centre(C) channels.

The delay range for SL/SR is 0 to 15 ms and 0 to 5 ms for centre.

Adjust the delay time for the selected channel by pressing **D TIME +** or **D TIME -** on the remote control.

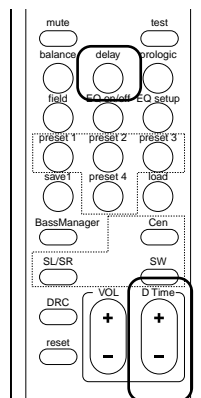

Press the **DELAY** Button will display the current delay time for channel LS.

DOLBY DIGITAL CO  
DELAY SL 5 MS

Press the **DELAY** Button again will circle to next channel.

DOLBY DIGITAL CO  
DELAY SR 5 MS

Press the **D TIME +** or **D TIME -** button will increase or decrease the delay time for current channel.

DOLBY DIGITAL CO  
DELAY SR 6 MS

## AEGOP5 OPERATION - TIME DELAY ADJUSTMENT ON SURROUND SPEAKERS

### Delay Calibration

Press **DELAY** Button and repeat to select the length of delay time for SL/SR/C channels.

The delay range for SL/SR is 0 to 15 ms and 0 to 5 ms for centre.

Adjust the delay time on selected channel by pressing **D TIME +** or **D TIME -** on the remote control.

### Surround Speaker Delay

Delay calibration for the rear surround speakers may be necessary if the surround speakers are placed quite close to your listening position. To correct the delay this may cause, press the **DELAY** button repeatedly until SL or SR appear on the display. Increase the time delay of the surround speakers by pressing **D TIME +** until you are able to hear a 3D sound effect coming from surround speakers.

Press **DELAY** Button again to move to the next channel.

DOLBY DIGITAL CO  
DELAY SL 5 MS

DOLBY DIGITAL CO  
DELAY SR 5 MS

Press **D TIME +** or **D TIME -** to increase or decrease the delay time for the selected channel.

DOLBY DIGITAL CO  
DELAY SR 6 MS

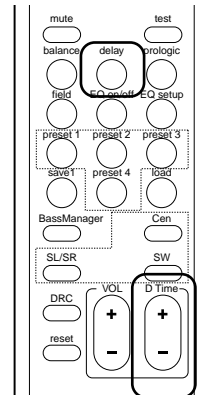

## AEGOP5 OPERATION - PRO LOGIC MODE

### Pro Logic Mode

Your AEGOP5 will automatically switch to Pro Logic mode when it detects a Pro Logic signal. With other types of input signal, you can select the Dolby Pro Logic mode manually by pressing **Pro Logic** button on the remote. Repeatedly pressing the Pro Logic Button will switch the Pro Logic mode in between the following modes; **AUTO, ALL PCM, ENABLE** and **DISABLE**.

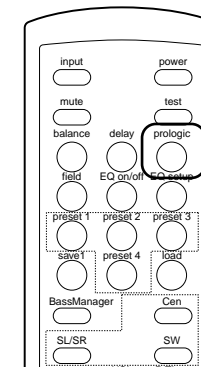

If a Pro Logic signal is detected, AEGOP5 will switch to Pro Logic mode automatically, and the display shows the following information:

DOLBY DIGITAL CO  
PROLOGIC AUTO

If a stereo signal (either analog or digital) is detected, AEGOP5 will switch to stereo mode automatically. You can then convert the stereo mode to Pro Logic mode by pressing the **Pro Logic** button until you see the following on the display:

DOLBY DIGITAL CO  
PROLOGIC ALL PCM

DOLBY DIGITAL CO  
PROLOGIC ENABLE

If you want to convert Pro Logic or 2-channel Dolby Digital signal into Stereo mode, you can press the **Pro Logic** button until you see the following on the display:

DOLBY DIGITAL CO  
PROLOGIC DISABLE

## AEGOP5 OPERATION - SPEAKER MODE WITH BASS MANAGER

### Speaker Mode with Bass Manager

The six LEDs on front panel of your AEGOP5 represent the six discrete audio channels (Left, Right, Centre, Rear Left, Rear Right and Sub). If a particular channel is active, the LED will light up in green. The LED will be red if that particular channel carries bass signal below 120Hz.

### Speaker Mode

Pressing the **CEN** button, switches the centre channel on and off. The LCD will display the following:

DOLBY DIGITAL CO  
SPK C ON

DOLBY DIGITAL CO  
SPK C OFF

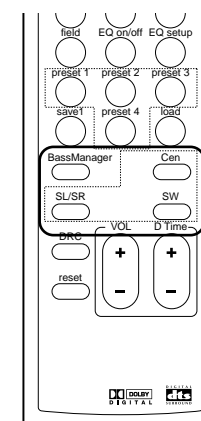

Pressing the **SL** or **SR** button, switches the surround channels on and off. The LCD will display the following:

DOLBY DIGITAL CO  
SPK SUR ON

DOLBY DIGITAL CO  
SPK SUR OFF

Pressing the **SW** button, switches the subwoofer on and off. The LCD will display the following:

DOLBY DIGITAL CO  
SPK SW ON

DOLBY DIGITAL CO  
SPK SW OFF

### Bass Manager

Pressing the **BASS MANAGER** button enables you to select from three different settings of Bass; Bass Config.1, Bass Config.2 and Bass Config.3. These selections will feed the bass signal below 120Hz to different speakers as described below.

### Bass Config.1

With this setting, the bass signal below 120Hz will be sent to the subwoofer; the LEDs on the front panel indicating SW will be red, and the LCD will show the following:

DOLBY DIGITAL CO  
BASS CONFIG.1

### Bass Config.2

With this setting, the bass signal below 120Hz will be sent to front left and right speakers and the subwoofer; the LEDs on the front panel indicating L/R/SW will be red, and the LCD will show the following information:

DOLBY DIGITAL CO  
BASS CONFIG.2

### Bass Config.3

With this setting, the bass signal below 120Hz will be sent to all the speakers; the LEDs on the front panel indicating L/R/SL/SR/SW channels will be red and the LCD will show the following information:

DOLBY DIGITAL CO  
BASS CONFIG.3

### Bass Config. Off

With this setting, the bass signal below 120Hz will be sent to all the speakers; the LEDs on front panel of AEGOP5 indicating L/R/C/SL/SR/SW channels will be red and the LCD will show the following information:

DOLBY DIGITAL CO  
BASS CONFIG.OFF

## AEGOP5 OPERATION

### AEGOP5 OPERATION - SAVING PRESETS

#### Setting Presets

The AEGOp5 enables you to customise up to 4 settings. This function enables you to save and load your favourite settings at any time.

#### Saving a Preset:

Press the **PRESET 1** button, the display will show the following:

DOLBY DIGITAL CO  
PRESET 1

Press the **SAVE** button to save all the current decoder settings into Preset 1.

DOLBY DIGITAL CO  
PRESET 1 SAVING

DOLBY DIGITAL CO  
PRESET 1 SAVED

When complete, your AEGOp5 will revert back to Auto Decode mode.

DOLBY DIGITAL CO

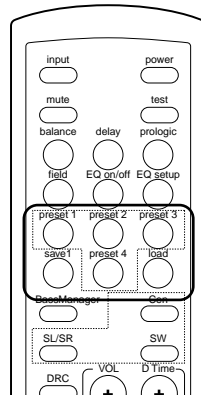

### AEGOP5 OPERATION - LOADING PRESET

#### Loading a Preset

You can load a previously saved preset by pressing **LOAD** button on the remote.

#### Loading a Preset:

Press any of the 4 preset buttons, (PRESET 1, PRESET 2, PRESET 3 or PRESET 4), the display will show the following:

DOLBY DIGITAL CO  
PRESET 1

Press **LOAD** button to load the preset.

DOLBY DIGITAL CO  
PRESET 1 LOADING

DOLBY DIGITAL CO  
PRESET 1 LOADED

When preset loading is complete, your AEGOp5 will revert back to Auto Decode mode.

DOLBY DIGITAL CO

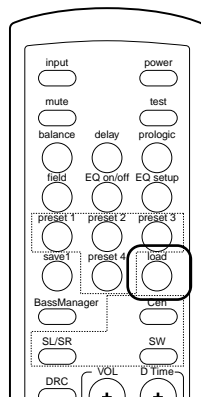

### AEGOP5 OPERATION - SOUND FIELD PROCESSING

#### DSP Sound Field

Your AEGOp5 is equipped with a sound field processor that gives you six different field effects; Disable, Hall, Theater, Stadium, Club, and Church. By pressing **Field** button on the remote, you can select any of these effects. You can also increase or decrease the Reverb value from 0 - 9 by pressing **VOL +** or **VOL -** on the remote control whilst you are selecting the field effect.

Press the **Field** button and repeat to change the current setting of Sound Field mode.

DOLBY DIGITAL CO  
DIABLE REVERB 0

DOLBY DIGITAL CO  
HALL REVERB 3

DOLBY DIGITAL CO  
THEATRE REVERB 3

DOLBY DIGITAL CO  
STADIUM REVERB 3

DOLBY DIGITAL CO  
CLUB REVERB 3

DOLBY DIGITAL CO  
CHURCH REVERB 3

### AEGOP5 OPERATION - EQUALIZATION

#### 5-Band Equalization

Your AEGOp5 features a 5-band equalizer which enables you to fine tune the sound of your favourite movie or music. Press **EQ SETUP** button on the remote to activate it. Repeatedly pressing **EQ SETUP** button will switch between the 5 bands.

Each band of the equalizer enables you to adjust your desired volume to a maximum of  $\pm 10$ dB. Press **VOL +** or **VOL -** on the remote control to adjust the volume.

After setting the desired volume for each EQ band, you

press **EQ SETUP** button again to store the new setting for that band.

Press **EQ ON/OFF** button to switch the new EQ settings on or off.

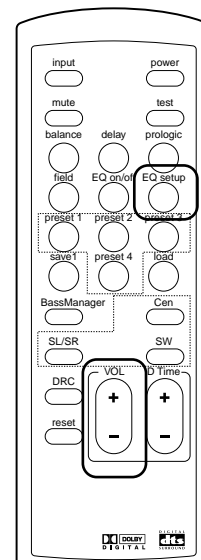
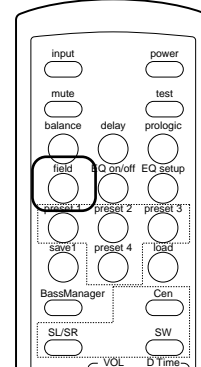

## AEGOP5 OPERATION

### AEGOP5 OPERATION - RESETING

#### Resetting

Your AEGOp5 can be reset to its factory default settings by pressing **RESET** button on the remote.

Press the **RESET** button to reset the AEGOp5 to its factory default settings.

DOLBY DIGITAL CO  
RESET TO FACTORY

When completed, your AEGOp5 reverts to Auto Decode mode.

DOLBY DIGITAL CO  
SURROUND

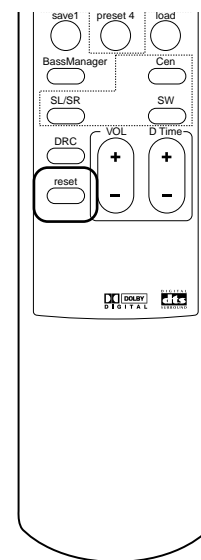

Press the **EQ SETUP** button to display the current setting of EQ Band 1.

DOLBY DIGITAL CO  
EQ BAND 1 0DB

Press the **EQ SETUP** button again to select next EQ Band.

DOLBY DIGITAL CO  
EQ BAND 2 0DB

Press the **Vol+** or **Vol-** button to increase or decrease the volume for current EQ Band.

DOLBY DIGITAL CO  
EQ BAND 2 +01DB

Press **EQ SETUP** button to store the new EQ setting.

Press **EQ ON/OFF** button to switch the new EQ settings on or off.

### AEGOP5 OPERATION - DRC (DYNAMIC RANGE COMPRESSION)

#### DRC

Your AEGOp5 features Dynamic Range Compression (DRC), its sophisticated technology creates realistic sound fields with richly detailed sound that is remarkably free from distortion. Repeatedly pressing **DRC** button will switch between 3 modes:

**"NO"** No compression is applied to the original audio signal, this provides the greatest dynamic range.

**"HALF"** Partial compression is applied, this function is useful if AEGOp5 is connected to an external amplifier.

**"FULL"** Full compression is applied, this function is useful if AEGOp5 is connected to an external amplifier.

Press the **DRC** button to display the current setting of Dynamic Range Compression mode.

DOLBY DIGITAL CO  
DYNAMIC NO

Press the **DRC** button again to switch between the DRC modes.

DOLBY DIGITAL CO  
DYNAMIC FULL

DOLBY DIGITAL CO  
DYNAMIC HALF

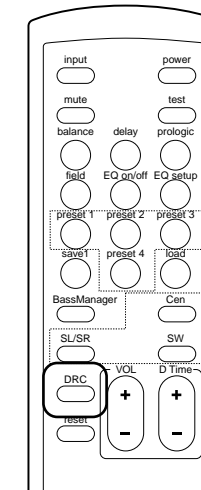



## Free Manuals Download Website

<http://myh66.com>

<http://usermanuals.us>

<http://www.somanuals.com>

<http://www.4manuals.cc>

<http://www.manual-lib.com>

<http://www.404manual.com>

<http://www.luxmanual.com>

<http://aubethermostatmanual.com>

Golf course search by state

<http://golfingnear.com>

Email search by domain

<http://emailbydomain.com>

Auto manuals search

<http://auto.somanuals.com>

TV manuals search

<http://tv.somanuals.com>