

Notebook PC User Manual



U47A/ U47VC/Q400

February 2012

Table of Contents

Chapter 1: Introducing the Notebook PC

About This User's Manual	6
Notes for This Manual	6
Safety Precautions	7
Preparing your Notebook PC	11

Chapter 2: Knowing the parts

Top Side	14
Bottom Side.....	17
Front Side	20
Right Side.....	21
Left Side	23

Chapter 3: Getting Started

Power System	26
Using AC Power	26
Using Battery Power	28
Battery Care	29
Powering ON the Notebook PC.....	30
The Power-On Self Test (POST)	30
Checking Battery Power.....	32
Charging the Battery Pack.....	33
Power Options	34
Power Management Modes	36
Sleep and Hibernate.....	36
Thermal Power Control.....	37
Special Keyboard Functions	38
Hot Keys	38
Microsoft Windows Keys	40
Multimedia Control Keys	42
Switches and Status Indicators	43
Switches	43
Status Indicators	44

Chapter 4: Using the Notebook PC

Touchpad	48
Using the touchpad	49
Touchpad usage illustrations	50
Caring for the touchpad.....	52
Disabling the touchpad automatically	53
Storage Devices	54
Flash Memory Card Reader.....	54
Optical Drive	55
Hard Disk Drive.....	58
Memory (RAM).....	60
Connections.....	61
Network Connection.....	61
Wireless LAN Connection (on selected models)	63
Windows Wireless Network Connection.....	65
Bluetooth Wireless Connection(on selected models).....	67
USB Charger+	70

Appendix

Optional Accessories.....	A-2
Optional Connections.....	A-2
Operating System and Software.....	A-3
System BIOS Settings	A-4
Common Problems and Solutions	A-7
Recovering Your Notebook PC	A-13
Using Recovery Partition	A-13
Using Recovery DVD (on selected models).....	A-14
DVD-ROM Drive Information.....	A-16
Internal Modem Compliancy.....	A-18
Declarations and Safety Statements	A-22
Federal Communications Commission Statement.....	A-22
FCC Radio Frequency (RF) Exposure Caution Statement.....	A-23
Declaration of Conformity(R&TTE directive 1999/5/EC).....	A-23
CE Mark Warning.....	A-24
IC Radiation Exposure Statement for Canada	A-24

Wireless Operation Channel for Different Domains.....	A-25
France Restricted Wireless Frequency Bands	A-25
Power Safety Requirement	A-26
REACH	A-26
UL Safety Notices.....	A-27
Nordic Lithium Cautions (for lithium-ion batteries).....	A-28
Optical Drive Safety Information	A-29
Laser Safety Information.....	A-29
Service warning label.....	A-29
CDRH Regulations	A-29
Macrovision Corporation Product Notice	A-30
CTR 21 Approval(for Notebook PC with built-in Modem)	A-31
European Union Eco-label.....	A-33
Global Environmental Regulation Compliance and Declaration	A-34
ASUS Recycling/Takeback Services.....	A-34
Regional Notice for United States of America.....	A-34
Copyright Information	A-35
Limitation of Liability.....	A-36
Service and Support.....	A-36

Introducing the Notebook PC

About This User's Manual

You are reading the Notebook PC User's Manual. This User's Manual provides information regarding the various components in the Notebook PC and how to use them. The following are major sections of this User's Manual:

- 1. Introducing the Notebook PC**
Introduces you to the Notebook PC and this User's Manual.
- 2. Knowing the Parts**
Gives you information on the Notebook PC's components.
- 3. Getting Started**
Gives you information on getting started with the Notebook PC.
- 4. Using the Notebook PC**
Gives you information on using the Notebook PC's components.
- 5. Appendix**
Introduces you to optional accessories and gives additional information.



The actual bundled operating system and applications differ by models and territories. There may be differences between your Notebook PC and the pictures shown in this manual. Please accept your Notebook PC as being correct.

Notes for This Manual

A few notes and warnings are used throughout this guide, allowing you to complete certain tasks safely and effectively. These notes have different degrees of importance as follows:



WARNING! Important information that must be followed for safe operation.



IMPORTANT! Vital information that must be followed to prevent damage to data, components, or persons.



TIP: Tips for completing tasks.



NOTE: Information for special situations.

Safety Precautions

The following safety precautions will increase the life of the Notebook PC. Follow all precautions and instructions. Except as described in this manual, refer all servicing to qualified personnel.



Disconnect the AC power and remove the battery pack(s) before cleaning. Wipe the Notebook PC using a clean cellulose sponge or chamois cloth dampened with a solution of nonabrasive detergent and a few drops of warm water and remove any extra moisture with a dry cloth.



DO NOT place on uneven or unstable work surfaces. Seek servicing if the casing has been damaged.



DO NOT place or drop objects on top and do not shove any foreign objects into the Notebook PC.



DO NOT expose to dirty or dusty environments. **DO NOT** operate during a gas leak.



DO NOT expose to strong magnetic or electrical fields.



DO NOT press or touch the display panel. Do not place together with small items that may scratch or enter the Notebook PC.



DO NOT expose to or use near liquids, rain, or moisture. **DO NOT** use the modem during electrical storms.



DO NOT leave the Notebook PC on your lap or any part of the body to prevent discomfort or injury from heat exposure.



Battery safety warning: **DO NOT** throw the battery in fire. **DO NOT** short circuit the contacts. **DO NOT** disassemble the battery.



SAFE TEMP: This Notebook PC should only be used in environments with ambient temperatures between 5°C (41°F) and 35°C (95°F).



INPUT RATING: Refer to the rating label on the bottom of the Notebook PC and be sure that your power adapter complies with the rating.



DO NOT carry or cover a Notebook PC that is powered ON with any materials that will reduce air circulation such as a carrying bag.



DO NOT use strong solvents such as thinners, benzene, or other chemicals on or near the surface.



DO NOT use damaged power cords, accessories, or other peripherals.



Incorrect installation of battery may cause explosion and damage the Notebook PC.



DO NOT throw the Notebook PC in municipal waste. This product has been designed to enable proper reuse of parts and recycling. The symbol of the crossed out wheeled bin indicates that the product (electrical, electronic equipment and mercury-containing button cell battery) should not be placed in municipal waste. Check local regulations for disposal of electronic products.



DO NOT throw the battery in municipal waste. The symbol of the crossed out wheeled bin indicates that the battery should not be placed in municipal waste.

Sound Pressure warning

Excessive sound pressure from earphones or headphones can cause hearing damage or loss. Adjustment of the volume control as well as the equalizer to settings other than the center position may increase the earphones or headphones output voltage and the sound pressure level.

DC Fan warning

Please note that the DC fan is a moving part that may cause DANGER. Ensure to keep your body from the moving fan blades.

Adapter Information

Input voltage: 100-240Vac

Input frequency: 50-60Hz

Rating output current: 3.42A (65W); 4.74A (90W)

Rating output voltage: 19VDC

Transportation Precautions

To prepare the Notebook PC for transport, you should turn it OFF and **disconnect all external peripherals to prevent damage to the connectors**. The hard disk drive's head retracts when the power is turned OFF to prevent scratching of the hard disk surface during transport. Therefore, you should not transport the Notebook PC while the power is still ON. Close the display panel and check that it is latched securely in the closed position to protect the keyboard and display panel.



CAUTION! The Notebook PC's surface is easily dulled if not properly cared for. Be careful not to rub or scrape the Notebook PC surfaces.

Covering Your Notebook PC

Purchase a carrying bag to protect the Notebook PC from dirt, water, shock, and scratches.

Charging Your Batteries

If you intend to use battery power, be sure to fully charge your battery pack and any optional battery packs before going on long trips. Remember that the power adapter charges the battery pack as long as it is plugged into the computer and an AC power source. Be aware that it takes much longer to charge the battery pack when the Notebook PC is in use.

Airplane Precautions

Contact your airline if you want to use the Notebook PC on the airplane. Most airlines will have restrictions for using electronic devices. Most airlines will allow electronic use only between and not during takeoffs and landings.



CAUTION! There are three main types of airport security devices: X-ray machines (used on items placed on conveyor belts), magnetic detectors (used on people walking through security checks), and magnetic wands (hand-held devices used on people or individual items). You can send your Notebook PC and diskettes through airport X-ray machines. However, it is recommended that you do not send your Notebook PC or diskettes through airport magnetic detectors or expose them to magnetic wands.

Preparing your Notebook PC

These are quick instructions for using your Notebook PC.

Installing the Battery Pack

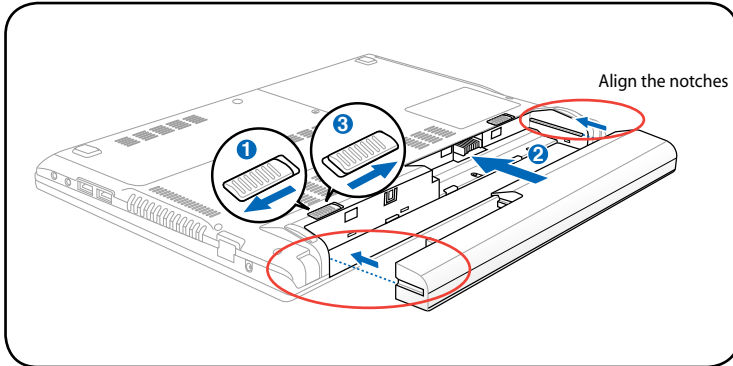

Connecting the Power Adapter

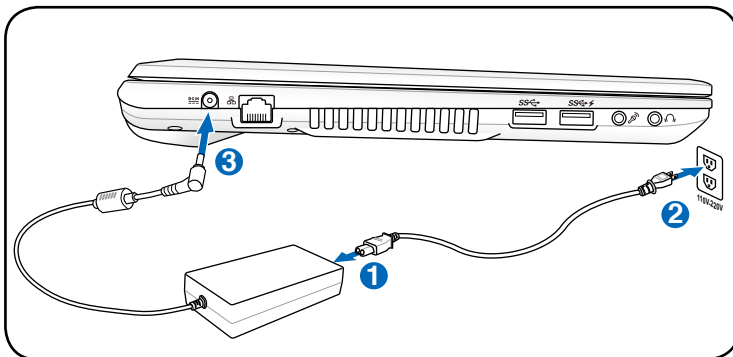

Opening the LCD display panel

1. Carefully lift up the display panel with your thumb.
2. Slowly tilt the display panel forward or backward to a comfortable viewing angle.

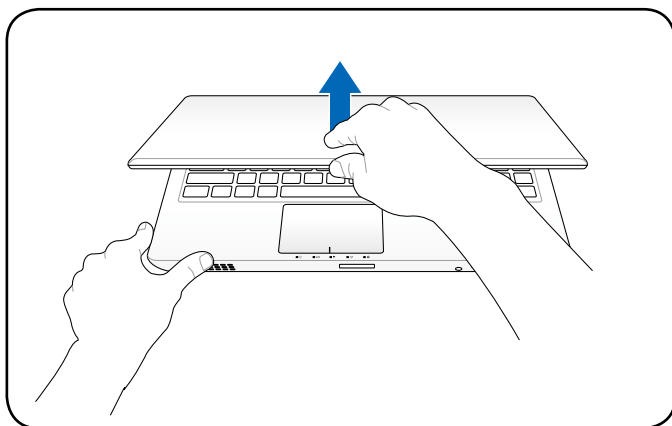

Turning on the Power

1. Push and release the power button located beneath the LCD display panel.
2. Use [Fn]+[F5] or [Fn]+[F6] to adjust the LCD brightness.

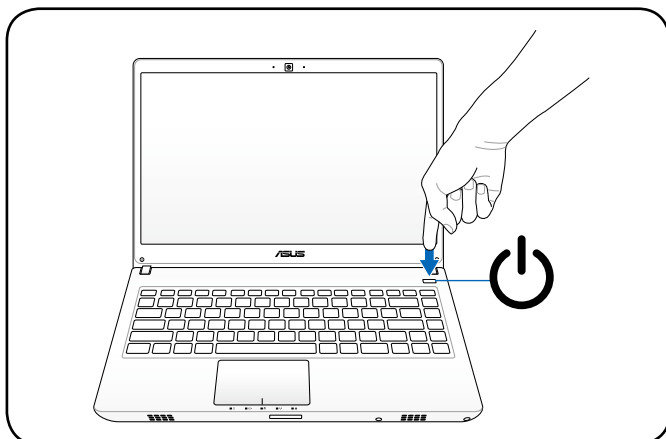

Knowing the parts **2**

Top Side



The keyboard differs for each territory.

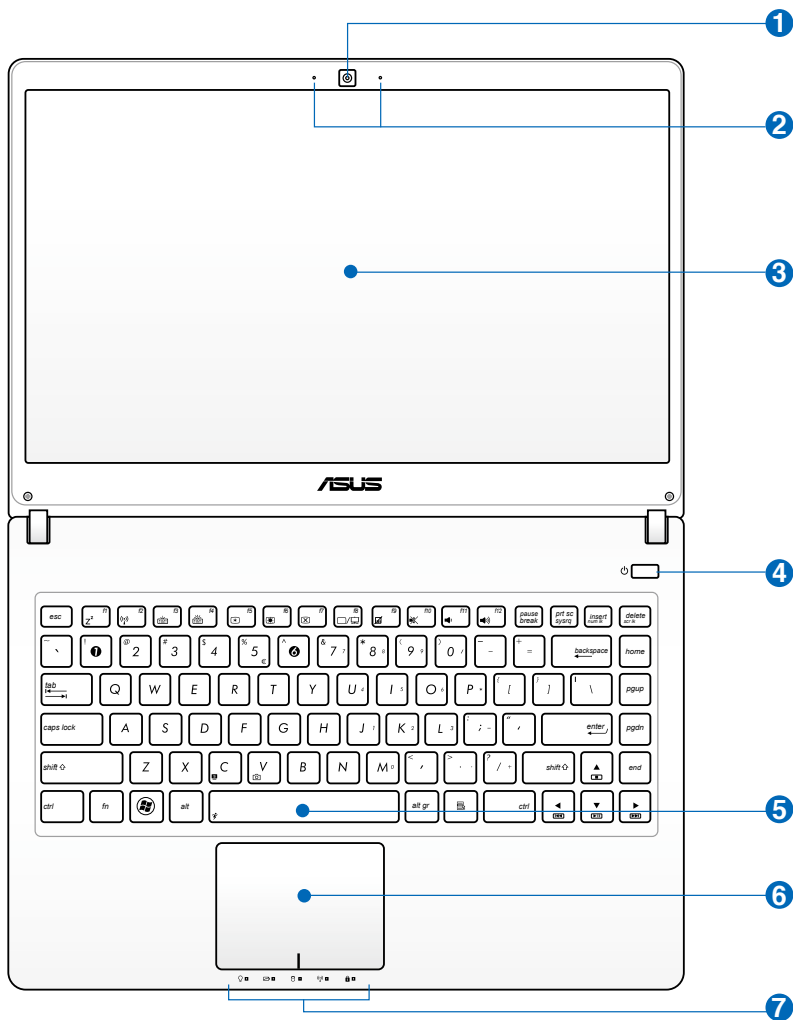

1 **Camera**

The built-in camera allows picture taking or video recording. Can be used with video conferencing and other interactive applications.

2 **Microphone (Built-in)**

The built-in mono microphone can be used for video conferencing, voice narrations, or simple audio recordings.

3 **Display Panel**

The display panel functions the same as a desktop monitor. The Notebook PC uses an active matrix TFT LCD, which provides excellent viewing like that of desktop monitors. Unlike desktop monitors, the LCD panel does not produce any radiation or flickering, so it is easier on the eyes. Use a soft cloth without chemical liquids (use plain water if necessary) to clean the display panel.

4 **Power Switch**

The power switch allows powering ON and OFF the Notebook PC and recovering from STD. Use the switch once to turn ON and once to turn OFF the Notebook PC. The power switch only works when the display panel is opened.

5 **Keyboard**

The keyboard provides full-sized keys with comfortable travel (depth at which the keys can be depressed) and palm rest for both hands. Two Windows function keys are provided to help ease navigation in the Windows operating system.

6 **Touchpad**

The touchpad is a pointing device that provides the same functions as a desktop mouse. A software-controlled scrolling function is available after setting up the included touchpad utility to allow easy Windows or web navigation.

7 **Status Indicators (front)**

Status indicators represent various hardware/software conditions. See indicator details in Chapter 3.

Bottom Side



The bottom side may vary in appearance depending on model.



The battery pack size varies depending on model.

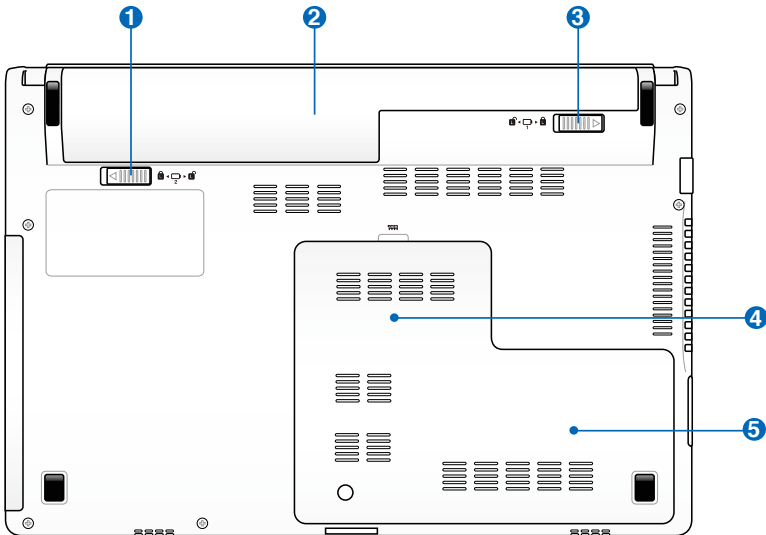

The bottom of the Notebook PC can get very hot. Be careful when handling the Notebook PC while it is in operation or recently been in operation. High temperatures are normal during charging or operation. **Do not use on soft surfaces such as sofas or beds, which may block the vent. Do not put the Notebook PC on your lap or other parts of the body to avoid injury from heat.**

1 **Battery Lock - Spring**

The spring battery lock is used to keep the battery pack secured. When the battery pack is inserted, it will automatically lock. To remove the battery pack, this spring lock must be held in the unlocked position.

2 **Battery Pack**

The battery pack is automatically charged when the Notebook PC is connected to an AC power source and maintains power to the Notebook PC when AC power is not connected. This allows use when moving temporarily between locations. Battery time varies by usage and by the specifications for this Notebook PC. The battery pack cannot be disassembled and must be purchased as a single unit.

3 **Battery Lock - Manual**

The manual battery lock is used to keep the battery pack secured. Move the manual lock to the unlocked position to insert or remove the battery pack. Move the manual lock to the locked position after inserting the battery pack.

4 **Memory (RAM) Compartment**

The memory compartment provides expansion capabilities for additional memory. Additional memory will increase application performance by decreasing hard disk access. The BIOS automatically detects the amount of memory in the system and configures CMOS accordingly during the POST (Power-On-Self-Test) process. There is no hardware or software (including BIOS) setup required after the memory is installed. Visit an authorized service center or retailer for information on memory upgrades for your Notebook PC. Only purchase expansion modules from authorized retailers of this Notebook PC to ensure maximum compatibility and reliability.

5 **Hard Disk Drive Compartments**

The hard disk drive is secured in a compartment. Visit an authorized service center or retailer for information on hard disk drive upgrades for your Notebook PC. Only purchase hard disk drives from authorized retailers of this Notebook PC to ensure maximum compatibility and reliability.

Front Side

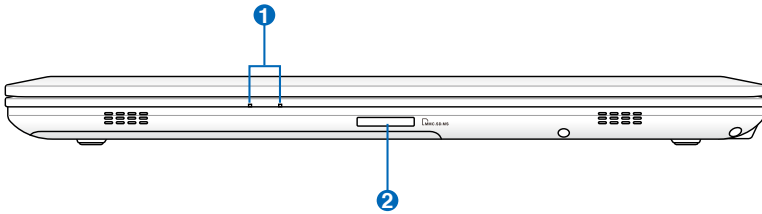

1 Status Indicator

The LED indicators light up when the Notebook PC is in use.

2 Flash Memory Slot

Normally an external memory card reader must be purchased separately in order to use memory cards from devices such as digital cameras, MP3 players, mobile phones, and PDAs. This Notebook PC has a built-in high-speed memory card reader that can conveniently read from and write to many flash memory cards.

Right Side

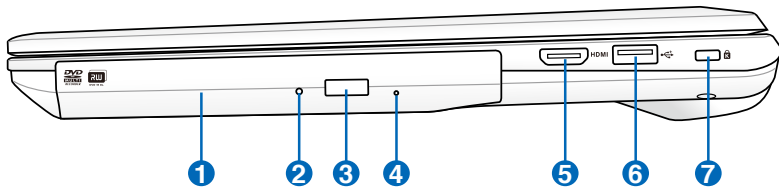

Optical Drive

The Notebook PC comes in various models with different optical drives. The Notebook PC's optical drive may support compact discs (CD) and digital video discs (DVD), and may have recordable (R) or re-writable (RW) capabilities. See the marketing specifications for details on each model.



Optical Drive Activity Indicator

The optical drive activity indicator shows when data is being transferred by the optical disk drive. This indicator will light in proportion to the data size transferred.



Optical Drive Electronic Eject

The optical drive eject has an electronic eject button for opening the tray. You can also eject the optical drive tray through any software player or by right clicking the optical drive in Windows "Computer" and selecting Eject.



Optical Drive Emergency Eject

The emergency eject is used to eject the optical drive tray in case the electronic eject does not work. Do not use the emergency eject in place of the electronic eject.

5 HDMI **HDMI Port**

HDMI (High-Definition Multimedia Interface) is provided for transmitting uncompressed digital-audio and video signals from DVD players, set-top boxes, and other audio-visual sources to television sets, projectors, and other video displays. It can carry high quality multi-channel audio data and all-standard, high-definition consumer electronics video formats. HDMI display devices utilize transition minimized differential signaling (TMDS) to carry audio-visual information through the same HDMI cable.

6 **USB Port (2.0)**

The USB (Universal Serial Bus) port is compatible with USB 2.0 or USB 1.1 devices such as keyboards, pointing devices, cameras, hard disk drives, printers, and scanners connected in a series up to 12Mbits/sec (USB 1.1) and 480Mbits/sec (USB 2.0). USB allows many devices to run simultaneously on a single computer, with some peripherals acting as additional plug-in sites or hubs. USB supports hot-swapping of devices so that most peripherals can be connected or disconnected without restarting the computer.

7 **Kensington® Lock Port**

The Kensington® lock port allows the Notebook PC to be secured using Kensington® compatible Notebook PC security products. These security products usually include a metal cable and lock that prevent the Notebook PC to be removed from a fixed object. Some may also include a motion detector to sound an alarm when moved.

Left Side

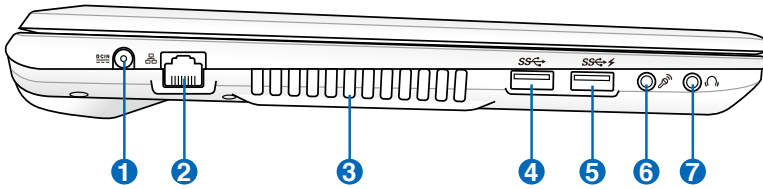

1 Power (DC) Input

The supplied power adapter converts AC power to DC power for use with this jack. Power supplied through this jack supplies power to the Notebook PC and charges the internal battery pack. To prevent damage to the Notebook PC and battery pack, always use the supplied power adapter.



The adapter may become warm to hot when in use. Ensure not to cover the adapter and keep it away from your body.

2 LAN Port

The RJ-45 LAN port with eight pins is larger than the RJ-11 modem port and supports a standard Ethernet cable for connection to a local network. The built-in connector allows convenient use without additional adapters.

3 **Air Vents**

The air vents allow cool air to enter and warm air to exit the Notebook PC.



Ensure that paper, books, clothing, cables, or other objects do not block any of the air vents or else overheating may occur.

4 **USB Port (3.0)**

The USB (Universal Serial Bus) port is compatible with USB 3.0, 2.0, or USB 1.1 devices such as keyboards, pointing devices, cameras, hard disk drives, printers, and scanners connected in a series up to 4.8Gbits/sec (USB 3.0), 480Mbits/sec (USB 2.0), and 12Mbits/sec (USB 1.1).

USB allows many devices to run simultaneously on a single computer, with some peripherals acting as additional plug-in sites or hubs. USB supports hot-swapping of devices so that most peripherals can be connected or disconnected without restarting the computer.

5 **USB Port (3.0)**

USB Charger+

Allows you to charge your mobile phones or digital audio players while your Notebook PC is sleeping, hibernating or shut down.

6 **Microphone Input Jack**

The mono microphone jack (1/8 inch) can be used to connect an external microphone or output signals from audio devices. Using this jack automatically disables the built-in microphone. Use this feature for video conferencing, voice narrations, or simple audio recordings.

7 **Headphone Output Jack**

The stereo headphone jack (1/8 inch) is used to connect the Notebook PC's audio out signal to amplified speakers or headphones. Using this jack automatically disables the built-in speakers.

Getting Started **3**

Power System

Using AC Power

The Notebook PC power is comprised of two parts, the power adapter and the battery power system. The power adapter converts AC power from a wall outlet to the DC power required by the Notebook PC. The power adapter converts AC power from a wall outlet to the DC power required by the Notebook PC. Your Notebook PC comes with a universal AC-DC adapter. That means that you may connect the power cord to any 100V-120V as well as 220V-240V outlets without setting switches or using power converters. Different countries may require that an adapter be used to connect the provided US-standard AC power cord to a different standard. Most hotels will provide universal outlets to support different power cords as well as voltages. It is always best to ask an experienced traveler about AC outlet voltages when bringing power adapters to another country.

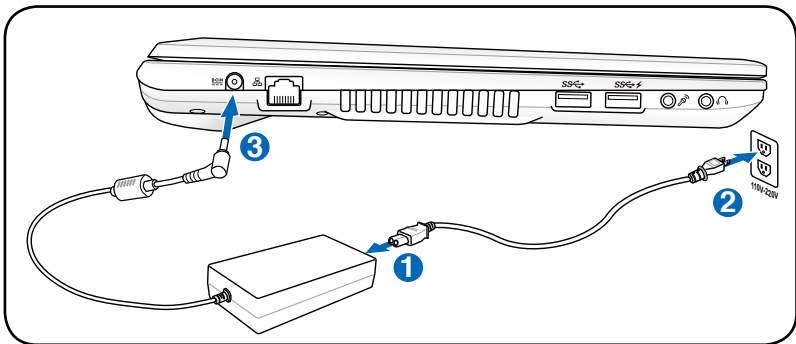

You can buy travel kits for the Notebook PC that includes power and modem adapters for almost every country.



WARNING! DO NOT connect the AC power cord to an AC outlet prior to connecting the DC plug to the Notebook PC. Doing so may damage the AC-DC adapter.



IMPORTANT! Damage may occur if you use a different adapter to power the Notebook PC or use the Notebook PC's adapter to power other electrical devices. If there is smoke, burning scent, or extreme heat coming from the AC-DC adapter, seek servicing. Seek servicing if you suspect a faulty AC-DC adapter. You may damage both your battery pack(s) and the Notebook PC with a faulty AC-DC adapter.



This Notebook PC may come with either a two or three-prong plug depending on territory. If a three-prong plug is provided, you must use a grounded AC outlet or use a properly grounded adapter to ensure safe operation of the Notebook PC.



WARNING! The power adapter may become warm to hot when in use. Be sure not to cover the adapter and keep it away from your body.



Unplug the power adapter or switch off the AC outlet to minimize the power consumption when the Notebook PC is not in use.

Using Battery Power

The Notebook PC is designed to work with a removable battery pack. The battery pack consists of a set of battery cells housed together. A fully charged pack will provide several hours of battery life, which can be further extended by using power management features through the BIOS setup. Additional battery packs are optional and can be purchased separately through a Notebook PC retailer.

Installing and Removing the Battery Pack

Your Notebook PC may or may not have its battery pack installed. If your Notebook PC does not have its battery pack installed, use the following procedures to install the battery pack.



IMPORTANT! Never attempt to remove the battery pack while the Notebook PC is turned ON, as this may result in the loss of working data.

To install the battery pack:

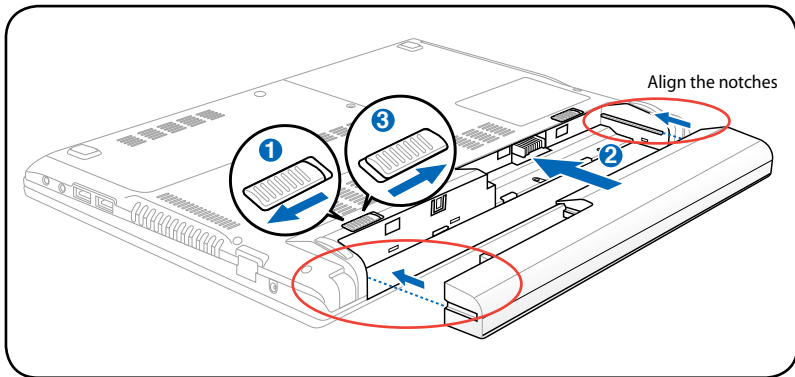

To remove the battery pack:

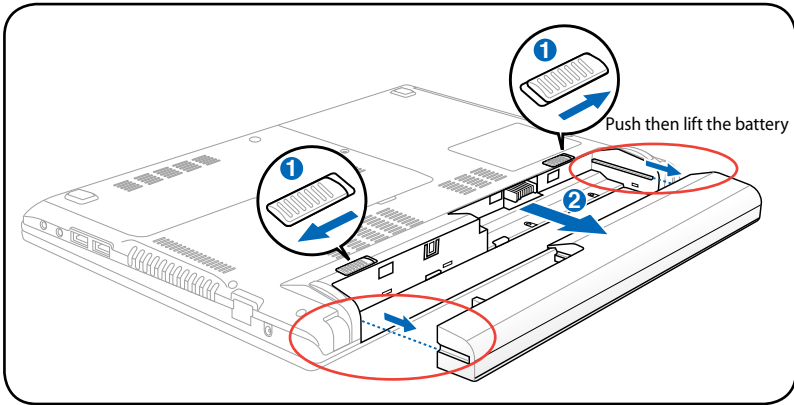

IMPORTANT! Only use battery packs and power adapters supplied with this Notebook PC or specifically approved by the manufacturer or retailer for use with this model or else damage may occur to the Notebook PC.

Battery Care

The Notebook PC's battery pack, like all rechargeable batteries, has a limit on the number times it can be recharged. The battery pack's useful life will depend on your environment temperature, humidity, and how your Notebook PC is used. It is ideal that the battery be used in a temperature range between 10°C and 35°C (50°F and 95°F). You must also take into account that the Notebook PC's internal temperature is higher than the outside temperature. Any temperatures above or below this range will shorten the life of the battery. But in any case, the battery pack's usage time will eventually decrease and a new battery pack must be purchased from an authorized dealer for this Notebook PC. Because batteries also have a shelf life, it is not recommended to buy extras for storing.



WARNING! For safety reasons, **DO NOT** throw the battery in fire, **DO NOT** short circuit the contacts, and **DO NOT** disassemble the battery. If there is any abnormal operation or damage to the battery pack caused by impact, turn **OFF** the Notebook PC and contact an authorized service center.

Powering ON the Notebook PC

The Notebook PC's power-ON message appears on the screen when you turn it ON. If necessary, you may adjust the brightness by using the hot keys. If you need to run the BIOS Setup to set or modify the system configuration, press [F2] upon bootup to enter the BIOS Setup. Press [ESC] and you will be presented with a boot menu with selections to boot from your available drives.



Before bootup, the display panel flashes when the power is turned ON. This is part of the Notebook PC's test routine and is not a problem with the display.



IMPORTANT! To protect the hard disk drive, always wait at least 5 seconds after turning OFF your Notebook PC before turning it back ON.



WARNING! DO NOT carry or cover a Notebook PC that is powered ON with any materials that will reduce air circulation such as a carrying bag.

The Power-On Self Test (POST)

When you turn ON the Notebook PC, it will first run through a series of software-controlled diagnostic tests called the Power-On Self Test (POST). The software that controls the POST is installed as a permanent part of the Notebook PC's architecture. The POST includes a record of the Notebook PC's hardware configuration, which is used to make a diagnostic check of the system. This record is created by using the BIOS Setup program. If the POST discovers a difference between the record and the existing hardware, it will display a message on the screen prompting you to correct the conflict by running BIOS Setup. In most cases the record should be correct when you receive the Notebook PC. When the test is finished, you may get a message reporting "No operating system found" if the hard disk was not preloaded with an operating system. This indicates that the hard disk is correctly detected and ready for the installation of a new operating system.

Self Monitoring and Reporting Technology

The S.M.A.R.T. (Self Monitoring and Reporting Technology) checks the hard disk drive during POST and gives a warning message if the hard disk drive requires servicing. If any critical hard disk drive warning is given during bootup, backup your data immediately and run Windows disk checking program. To run Windows disk checking program: click **Start** > select **Computer** > right-click a hard disk drive icon > choose **Properties** > click the **Tools** tab > click **Check Now** >

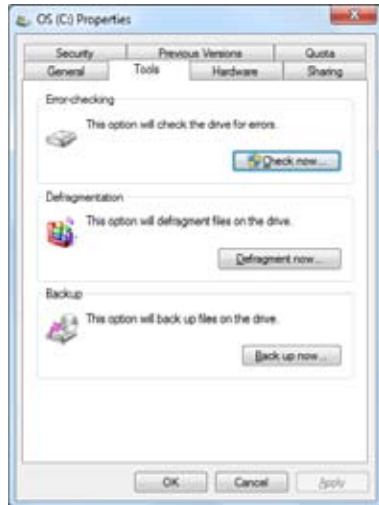

click **Start**. You can also select "Scan ...sectors" for more effective scan and repair but the process will run slower.



IMPORTANT! If warnings are still given during bootup after running a software disk checking utility, you should take your Notebook PC in for servicing. Continued use may result in data loss.

Checking Battery Power

The battery system implements the Smart Battery standard under the Windows environment, which allows the battery to accurately report the amount of charge left in the battery. A fully-charged battery pack provides the Notebook PC a few hours of working power. But the actual figure varies depending on how you use the power saving features, your general work habits, the CPU, system memory size, and the size of the display panel.



Screen captures shown here are examples only and may not reflect what you see in your system.



You will be warned when battery power is low. If you continue to ignore the low battery warnings, the Notebook PC eventually enters suspend mode (Windows default uses STR).

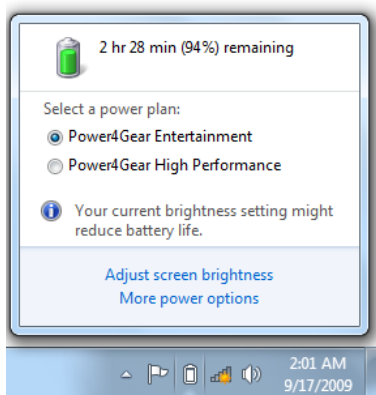

Left-click the battery icon

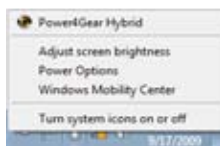

Right-click the battery icon



Pointer over the battery icon without power adapter.



Pointer over the battery icon with power adapter.



WARNING! Suspend-to-RAM (STR) does not last long when the battery power is depleted. STR is not the same as power OFF. STR requires a small amount of power and will fail and lose data if no power is available due to complete battery depletion or no power supply (e.g. removing both the power adapter and battery pack).

Charging the Battery Pack

Before you use your Notebook PC on the road, you will have to charge the battery pack. The battery pack begins to charge as soon as the Notebook PC is connected to external power using the power adapter. Fully charge the battery pack before using it for the first time. A new battery pack must completely charge before the Notebook PC is disconnected from external power. It takes a few hours to fully charge the battery when the Notebook PC is turned OFF and may take twice the time when the Notebook PC is turned ON. The battery status indicator on the Notebook PC turns OFF when the battery pack is charged.



The battery starts charging when the charge remaining in the battery drops below 95%. This prevents the battery from charging frequently. Minimizing the recharge cycles helps prolong battery life.



The battery stops charging if the temperature is too high or the battery voltage is too high.



WARNING! DO NOT leave the battery pack discharged. The battery pack will discharge over time. If not using a battery pack, it must continued to be charged every three months to extend recovery capacity or else it may fail to charge in the future.

Power Options

The power switch turns ON and OFF the Notebook PC or putting the Notebook PC into sleep or hibernation modes. Actual behavior of the power switch can be customized in Windows Control Panel "Power Options."

For other options, such as "Switch User, Restart, Sleep, or Shut Down," click the arrowhead next to the lock icon.

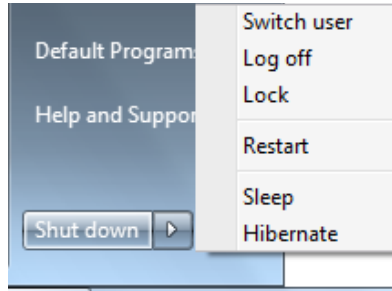

Restarting or Rebooting

After making changes to your operating system, you may be prompted to restart the system. Some installation processes will provide a dialog box to allow restart. To restart the system manually, choose **Restart**.



IMPORTANT! To protect the hard drive, wait at least 5 seconds after turning OFF your Notebook PC before turning it back ON.

Emergency Shutdown

In case your operating system cannot properly turn OFF or restart, there is an additional way to shutdown your Notebook PC:

- Hold the power button  over 4 seconds.

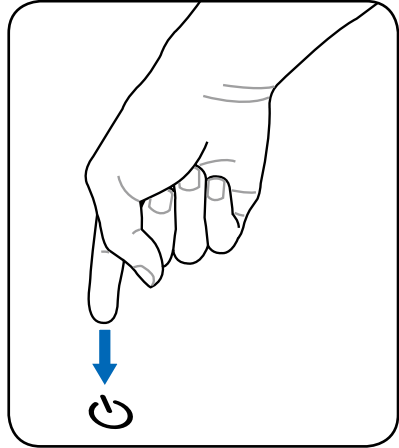

IMPORTANT! DO NOT use emergency shutdown while data is being written; doing so can result in loss or destruction of your data.

Power Management Modes

The Notebook PC has a number of automatic or adjustable power saving features that you can use to maximize battery life and lower Total Cost of Ownership (TCO). You can control some of these features through the Power menu in the BIOS Setup. ACPI power management settings are made through the operating system. The power management features are designed to save as much electricity as possible by putting components into a low power consumption mode as often as possible but also allow full operation on demand.

Sleep and Hibernate

Power management settings can be found in the **Windows > Control Panel > Hardware and Sound > Power Options**. In **Power Options**, you can define "Sleep/Hibernate" or "Shut Down" for closing the display panel or pressing the power button.



"Sleep" and "Hibernate" saves power when your Notebook PC is not in use by turning OFF certain components. When you resume your work, your last status (such as a document scrolled down half way or email typed half way) will reappear as if you never left. "Shut Down" will close all applications and ask if you want to save your work if any are not saved.

Sleep is the same as Suspend-to-RAM (STR). This function stores your current data and status in RAM while many components are turned OFF. Because RAM is volatile, it requires power to keep (refresh) the data. Click the **Windows** button and the arrowhead next to the lock icon

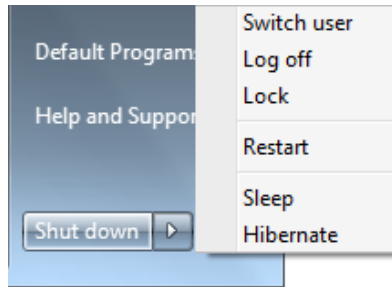

to see this option. You can also use the keyboard shortcut **[Fn F1]** to activate this mode. Recover by pressing any keyboard key except [Fn]. (NOTE: The power indicator will blink in this mode.)

Hibernate is the same as Suspend-to-Disk (STD) and stores your current data and status on the hard disk drive. By doing this, RAM does not have to be periodically refreshed and power consumption is greatly reduced but not completely eliminated because certain wake-up components like LAN needs to remain powered. "Hibernate" saves more power compared to "Sleep". Click the **Start** button and the arrowhead next to the lock icon to see this option. Recover by pressing the power button. (NOTE: The power indicator will be OFF in this mode.)

Thermal Power Control

There are three power control methods for controlling the Notebook PC's thermal state. These power control cannot be configured by the user and should be known in case the Notebook PC should enter these states. The following temperatures represent the chassis temperature (not CPU).

- The fan turns ON for active cooling when the temperature reaches the safe upper limit.
- The CPU decreases speed for passive cooling when the temperature exceeds the safe upper limit.
- The system shut down for critical cooling when temperature exceeds the maximum safe upper limit.







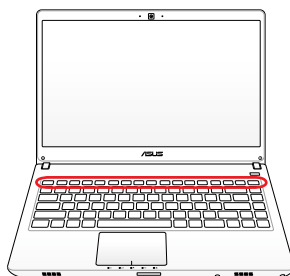







Special Keyboard Functions



Hot Keys



The following defines the hot keys on the Notebook PC's keyboard. The commands can only be accessed by first pressing and holding the function key while pressing a key with an icon command.







The Hot Key locations on the function keys may vary depending on model but the functions should remain the same. Follow the icons instead of the function keys.



-   **"Z" Icon (F1):** Places the Notebook PC in suspend mode (either Save-to-RAM or Save-to-Disk depending on sleep button setting in power management setup).
-   **Radio Tower (F2):** Wireless Models Only: Toggles the internal wireless LAN or Bluetooth (on selected models) ON or OFF with an on-screen-display. When enabled, the corresponding wireless indicator will light. Windows software settings are necessary to use the wireless LAN or Bluetooth.
-   **Keyboard Light Down Icon (F3) (on selected models):** Decreases the keyboard light brightness
-   **Keyboard Light Up Icon (F4) (on selected models):** Increases the keyboard light brightness
-   **Sun Down Icon (F5):** Decreases the display brightness
-   **Sun Up Icon (F6):** Increases the display brightness
-   **LCD Icon (F7):** Toggles the display panel ON and OFF. (On certain models; stretches the screen area to fill the entire display when using low resolution modes.)



  **LCD/Monitor Icons (F8):** Toggles between the Notebook PC's LCD display and an external monitor in this series: LCD Only -> CRT Only (External Monitor) -> LCD + CRT Clone -> LCD + CRT Extend. (This function does not work in 256 Colors, select High Color in Display Property Settings.) **NOTE: Must connect an external monitor "before" booting up.**



  **Crossed-out Touchpad (F9):** Toggles the built-in touchpad LOCKED (disabled) and UNLOCKED (enabled). Locking the touchpad will prevent you from accidentally moving the pointer while typing and is best used with an external pointing device such as a mouse. NOTE: Selected models have an indicator between the touchpad buttons will light when the touchpad is UNLOCKED (enabled) and not light when the touchpad is LOCKED (disabled).



  **Crossed Speaker Icons (F10):** Toggles the speakers ON and OFF (only in Windows OS)

  **Speaker Down Icon (F11):**
Decreases the speaker volume (only in Windows OS)

  **Speaker Up Icon (F12):**
Increases the speaker volume (only in Windows OS)

  **Num Lk (Ins):** Toggles the numeric keypad (number lock) ON and OFF. Allows you to use a larger portion of the keyboard for number entering.



  **Scr Lk (Del):** Toggles the "Scroll Lock" ON and OFF. Allows you to use a larger portion of the keyboard for cell navigation.

  **Fn+C:** Toggles “Splendid Video Intelligent Technology” function ON and OFF. This allows switching between different display color enhancement modes in order to improve contrast, brightness, skin tone, and color saturation for red, green, and blue independently. You can see the current mode through the onscreen display (OSD).

  **Fn+V (on selected models):** Toggles “Life Frame” software application.



For some models, this function is available only when you enable the camera.

  **Power4Gear Hybrid (Space Bar):** This key toggles power savings between various power saving modes. The power saving modes control many aspects of the Notebook PC to maximize performance versus battery time. Applying or removing the power adapter will automatically switch the system between AC mode and battery mode. You can see the current mode through the on-screen display (OSD).

Microsoft Windows Keys



There are two special Windows keys on the keyboard as described below.

The key with the Windows Logo activates the Start menu located at the bottom left of the Windows desktop.



The other key, that looks like a Windows menu with a small pointer, activates the properties menu and is equivalent to pressing the right mouse button on a Windows object.

Keyboard as a Numeric Keypad

The numeric keypad is embedded in the keyboard and consists of 15 keys that make number intensive input more convenient. Numeric assignments are located at the upper right hand corner of each key as shown in the figure. When the numeric keypad is engaged by pressing [Fn][Ins/Num LK], the number lock LED lights up. If an external keyboard is connected, pressing the [Ins/Num LK] on the external keyboard enables/disables the NumLock on both keyboards simultaneously. To disable the numeric keypad while keeping the keypad on an external keyboard activated, press the [Fn][Ins/Num LK] keys on the Notebook PC.

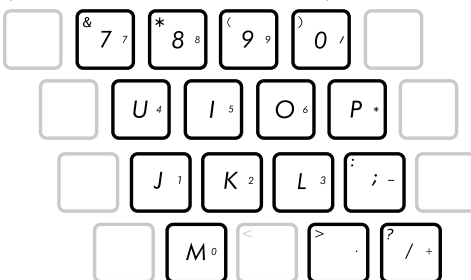

Keyboard as Pointers

The keyboard can be used as pointers while Number Lock is ON or OFF in order to increase navigation ease while entering numeric data in spreadsheets or similar applications.

With Number Lock OFF, press [Fn] and one of the pointer keys shown below. For example [Fn][8] for up, [Fn][K] for down, [Fn][U] for left, and [Fn][O] for right.

With Number Lock ON, use [Shift] and one of the pointer keys shown below. For example [Shift][8] for up, [Shift][K] for down, [Shift][U] for left, and [Shift][O] for right.

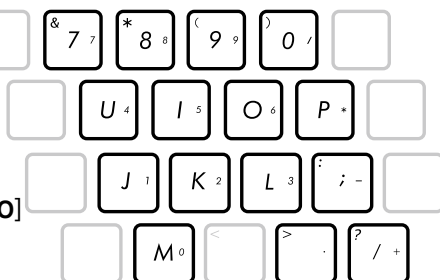

Multimedia Control Keys

The multimedia control keys allows for convenient controlling of the multimedia application. The following defines the meaning of each multimedia control key on the Notebook PC.



Some control key functions may defer depending on Notebook PC model.

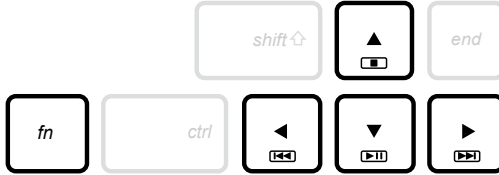

Use the [Fn] key in combination with the arrow keys for multimedia control functions.



Play/Pause (↓)

Begins or pauses media file playback.



Stop (↑)

Stops media file playback.



Back (←)

During media file playback, goes back to the previous song / movie chapter.



Forward (→)

During media file playback, skips to the next song / movie chapter.

Switches and Status Indicators

Switches

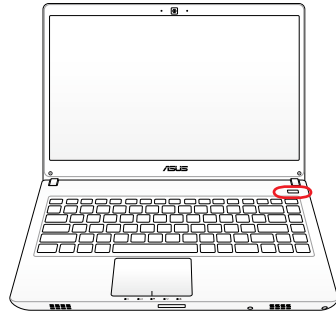
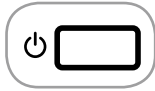

Power Switch

The power switch allows powering ON and OFF the Notebook PC and recovering from STD. Use the switch once to turn ON and once to turn OFF the Notebook PC. The power switch only works when the display panel is opened.

Status Indicators

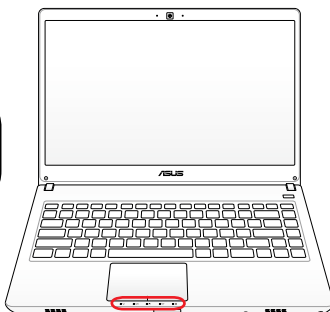
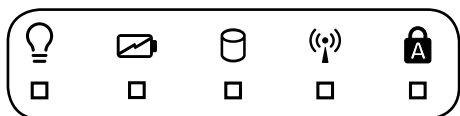

Power Indicator

The power indicator lights when the Notebook PC is turned ON and blinks slowly when the Notebook PC is in the Suspend-to-RAM (Sleep) mode. This indicator is OFF when the Notebook PC is turned OFF or in the Suspend-to-Disk (Hibernation) mode.

Battery Charge Indicator (dual-color)

The dual-color battery charge indicator shows the status of the battery's power as follows:

Green ON: Battery power is between 95% and 100% (with AC power).

Orange ON: Battery power is less than 95% (with AC power).

Orange Blinking: Battery power is less than 10% (without AC power).

Off: Battery power is between 10% and 100% (without AC power).

Drive Activity Indicator

Indicates that the Notebook PC is accessing one or more storage device(s) such as the hard disk. The light flashes proportional to the access time.

Bluetooth / Wireless Indicator

This is only applicable on models with internal Bluetooth (BT) and built-in wireless LAN. This indicator will light to show that the Notebook PC's built-in Bluetooth (BT) function is activated. When the built-in wireless LAN is enabled, this indicator will also light. (Windows software settings are necessary.)

Capital Lock Indicator

Indicates that capital lock [Caps Lock] is activated when lighted. Capital lock allows some of the keyboard letters to type using capitalized letters (e.g. A, B, C). When the capital lock light is OFF, the typed letters will be in the lower case form (e.g. a,b,c).



Using the Notebook PC

Touchpad

The touchpad is an interactive device that interprets the gestures and position of your fingers to simulate the functions of a regular mouse. It is also an alternative to mouse to position cursor onscreen.

The following illustration shows the features of the touchpad:

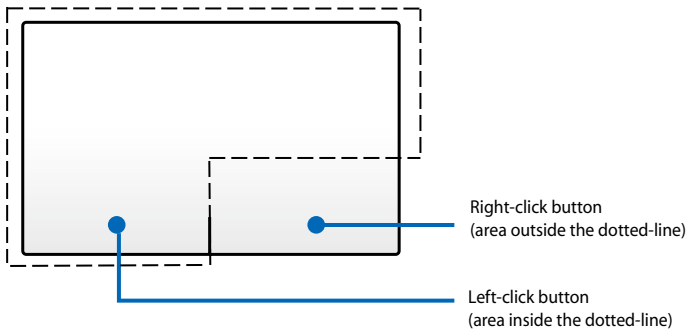

DO NOT use any objects in place of your finger to operate the touchpad. These objects may damage the touchpad's surface.



A device driver is still required for working with some application software.

Using the touchpad

The touchpad allows you to use one-finger and multi-finger gestures to move the pointer so you can select and click items, rotate and zoom images, scroll lists, as well as swipe and switch between windows.

Moving the pointer

You can tap or click anywhere on the touchpad to activate its pointer, then slide your finger on the touchpad to move the pointer onscreen.

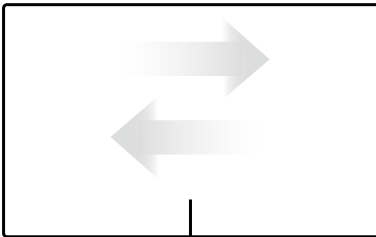

Slide horizontally

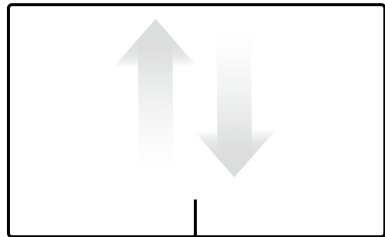

Slide vertically

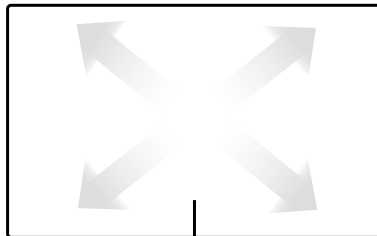

Slide diagonally

Touchpad usage illustrations

Tapping - Tapping on the touchpad allows you to select items onscreen and open files.

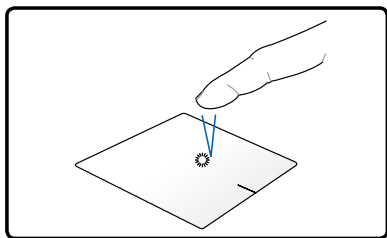

Tap once to select an item.

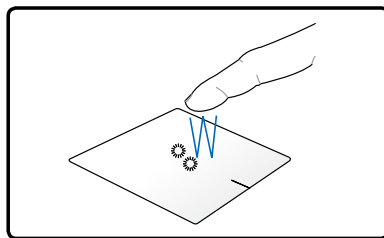

Tap twice to open the selected item.

Clicking - Clicking on the touchpad simulates the functions of the left mouse button and right mouse button.

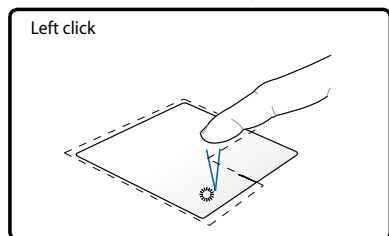

Click once to select an item, then double-click to open.

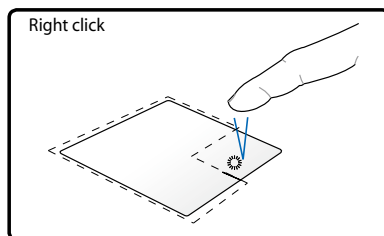

Click once to select an item and view its menu options.

Dragging and dropping - Doing the drag-and-drop action on the touchpad allows you to move onscreen items into a new location.

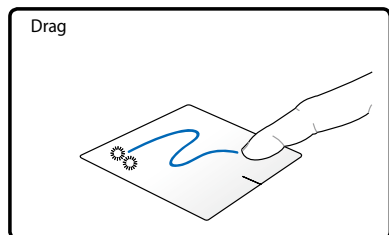

Select an item by tapping twice, then slide the same finger without lifting it off the touchpad.

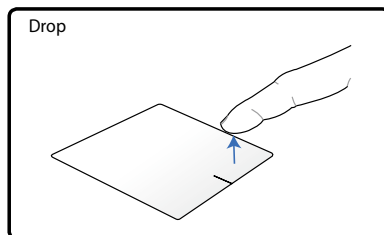

Release your finger from the touchpad to drop the item on its new location.

Rotating - Rotating images clockwise or counterclockwise is done on the touchpad by using two fingers.

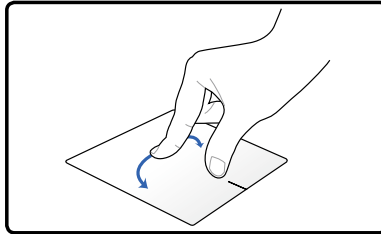

To rotate an image, place two fingers on the touchpad then turn one finger clockwise or counterclockwise while the other stays still.

Scrolling - Using two fingers on the touchpad, you can scroll through lists vertically and horizontally.

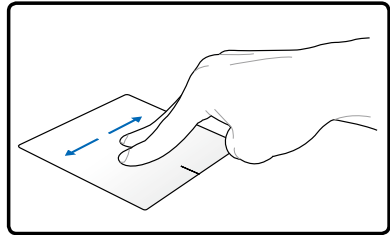
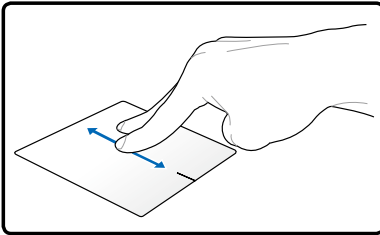

To enable continuous scrolling, hold your fingers on the edge of the touchpad when moving from up to down or left to right and vice versa. The mouse pointer changes to a double-headed arrow pointer  when continuous scrolling is activated.

Zooming - Using two fingers on the touchpad, you can enlarge or reduce the view size of your selected image.

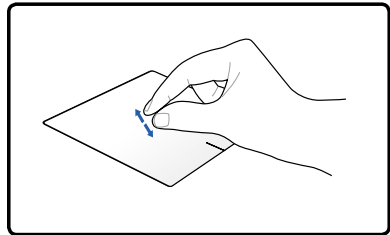
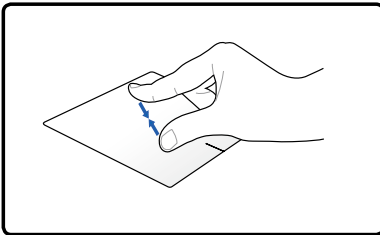

Bring together or spread apart two fingers to zoom in or out.

Three-finger swiping - Using three fingers on the touchpad, you can swipe pages from left to right or right to left. You can also use this gesture to switch between active windows on your desktop.

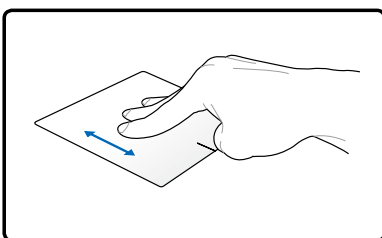
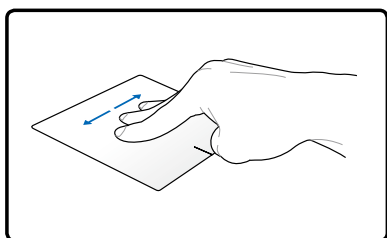

Caring for the touchpad

The touchpad is pressure sensitive. If not properly cared for, it can be easily damaged. Take note of the following precautions.

- Ensure the touchpad does not come into contact with dirt, liquids or grease.
- Do not touch the touchpad if your fingers are dirty or wet.
- Do not rest heavy objects on the touchpad or the touchpad buttons.
- Do not scratch the touchpad with your finger nails or any hard objects.



The touchpad responds to movement not to force. There is no need to tap the surface too hard. Tapping too hard does not increase the responsiveness of the touchpad. The touchpad responds best to light pressure.

Disabling the touchpad automatically

You can automatically disable the touchpad when an external USB mouse is attached.

To disable the touchpad:

1. Go to **Control Panel**. Change view settings to **Large Icons** then select **Mouse**.
2. Select the **ELAN** tab.
3. Tick the box with the **Disable when external pointing device plug in** option.
4. Select **Apply** to save current changes or Select **OK** to save changes then exit.

Storage Devices

Storage devices allow the Notebook PC to read or write documents, pictures, and other files to various data storage devices.

Flash Memory Card Reader

Normally a memory card reader must be purchased separately in order to use memory cards from devices such as digital cameras, MP3 players, mobile phones, and PDAs. This Notebook PC has a single built-in memory card reader that can use many flash memory cards as shown in the example below. The built-in memory card reader is not only convenient, but also faster than most other forms of memory card readers because it utilizes the internal high-bandwidth PCI bus.



IMPORTANT! Flash memory card compatibility varies depending on Notebook PC model and flash memory card specifications. Flash memory card specifications constantly change so compatibility may change without warning.

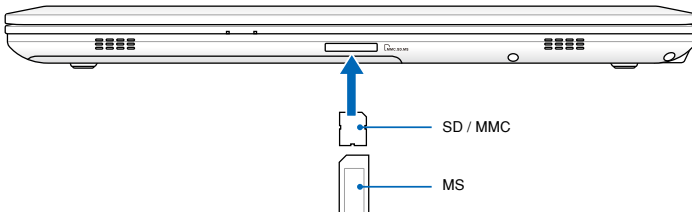

The actual location of the Flash Memory Slot differs by models. Refer to the previous chapter to locate the Flash Memory Slot.



IMPORTANT! Never remove cards while or immediately after reading, copying, formatting, or deleting data on the card or else data loss may occur.



WARNING! To prevent data loss, use “Safely Remove Hardware and Eject Media” in the Windows notification area before removing the flash memory card.



Optical Drive

Inserting an optical disc

1. While the Notebook PC's power is ON, press the drive's eject button and the tray will eject out partially.

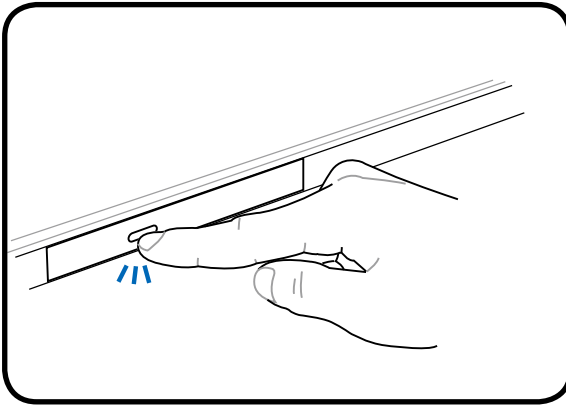

2. Gently pull on the drive's front panel and slide the tray completely out. Be careful not to touch the CD drive lens and other mechanisms. Make sure there are no obstructions that may get jammed under the drive's tray.

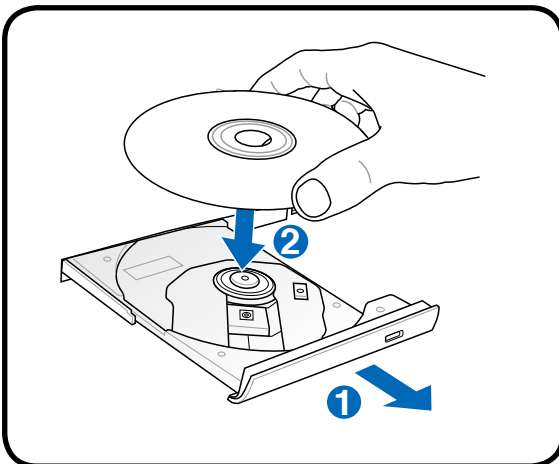

3. Hold the disc by the edge and face the disc's printed side up. Push down on both sides of the disc's center until the disc snaps onto the hub. **The hub should be higher than the disc when correctly mounted.**

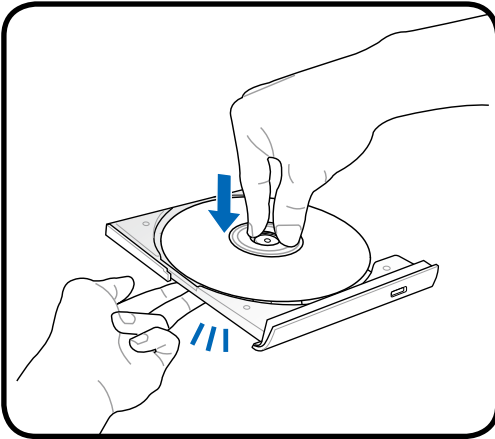

4. Slowly push the drive's tray back in. The drive will begin reading the table of contents (TOC) on the disc. When the drive stops, the disc is ready to be used.

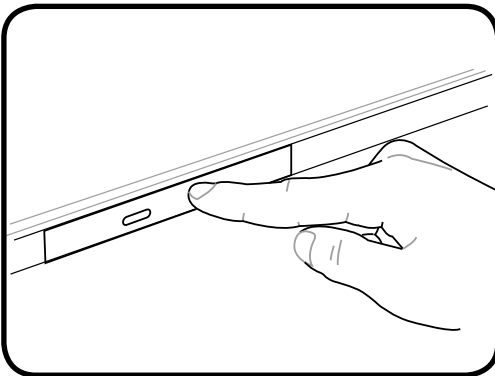

It is normal to hear as well as feel the CD spinning with great intensity in the CD drive while data is read.

Removing an optical disc

Eject the tray and gently pry the edge of the disc upwards at an angle to remove the disc from the hub.

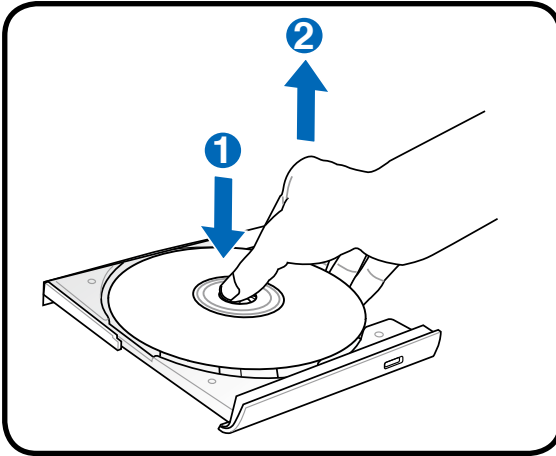

Emergency eject

The emergency eject is located in a hole on the optical drive and is used to eject the optical drive tray in case the electronic eject does not work. Do not use the emergency eject in place of the electronic eject.



Ensure not to stab the activity indicator located in the same area.

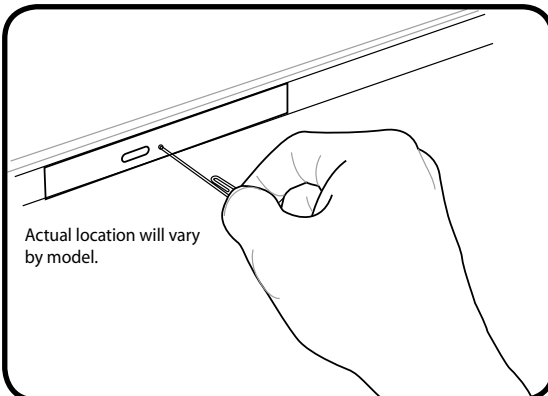

Hard Disk Drive

Hard disk drives have higher capacities and operate at much faster speeds than floppy disk drives and optical drives. The Notebook PC comes with two replaceable hard disk drives. Current hard drives support S.M.A.R.T. (Self Monitoring and Reporting Technology) to detect hard disk errors or failures before they happen. When replacing or upgrading the hard drive, always visit an authorized service center or retailer for this Notebook PC.



IMPORTANT! Poor handling of the Notebook PC may damage the hard disk drive. Handle the Notebook PC gently and keep it away from static electricity and strong vibrations or impact. The hard disk drive is the most delicate component and will likely be the first or only component that is damaged if the Notebook PC is dropped.



IMPORTANT! When replacing or upgrading the hard drive, always visit an authorized service center or retailer for this Notebook PC.



WARNING! Disconnect all the connected peripherals, any telephone or telecommunication lines and power connector (such as external power supply, battery pack, etc.) before removing the hard disk cover.

Locating the hard disk drive

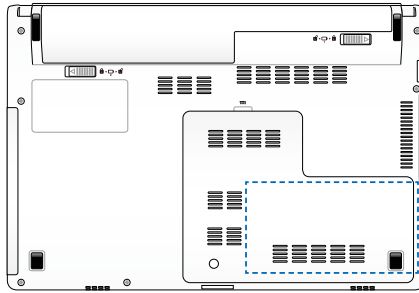

Removing the hard disk drive

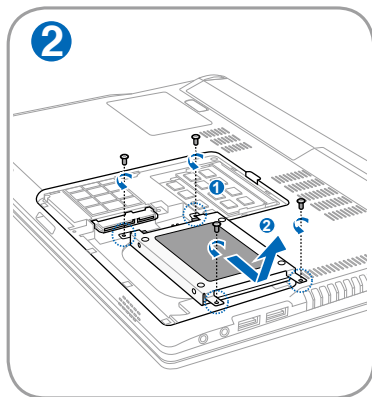
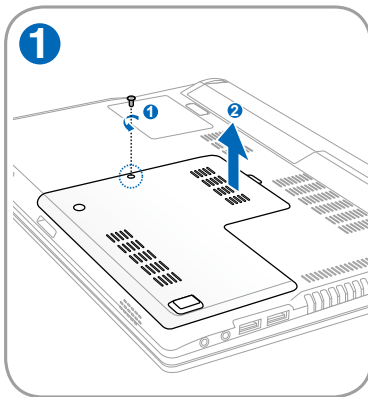

Installing the hard disk drive

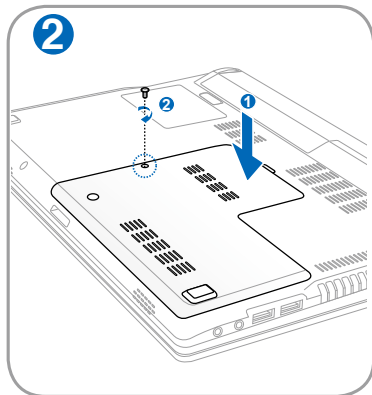
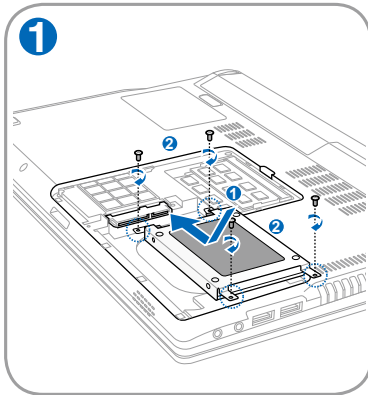

Memory (RAM)

Additional memory will increase application performance by decreasing hard disk access. Visit an authorized service center or retailer for information on memory upgrades for your Notebook PC. Only purchase expansion modules from authorized retailers of this Notebook PC to ensure maximum compatibility and reliability.

The BIOS automatically detects the amount of memory in the system and configures CMOS accordingly during the POST (Power-On-Self-Test) process. There is no hardware or software (including BIOS) setup required after the memory is installed.

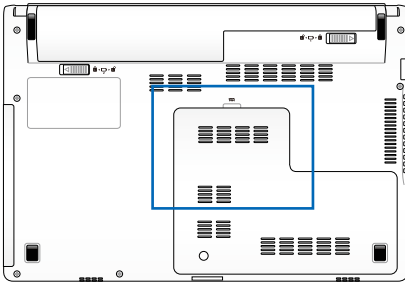

WARNING! Disconnect all the connected peripherals, any telephone or telecommunication lines and power connector (such as external power supply, battery pack, etc.) before installing or removing a memory.



The actual location of the memory differs by models. Refer to the previous chapter to locate the memory.

Installing a Memory Card:

Removing a Memory Card:

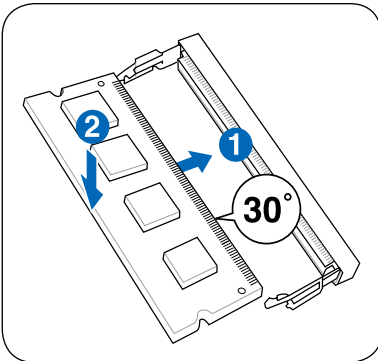

(This is only an example.)

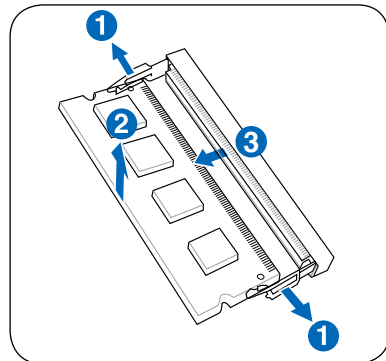

(This is only an example.)

Connections



The built-in network cannot be installed later as an upgrade. After purchase, network can be installed as an expansion card.

Network Connection

Connect a network cable, with RJ-45 connectors on each end, to the modem/network port on the Notebook PC and the other end to a hub or switch. For 100 BASE-TX / 1000 BASE-T speeds, your network cable must be category 5 or better (not category 3) with twisted-pair wiring. If you plan on running the interface at 100/1000Mbps, it must be connected to a 100 BASE-TX / 1000 BASE-T hub (not a BASE-T4 hub). For 10Base-T, use category 3, 4, or 5 twisted-pair wiring. 10/100 Mbps Full-Duplex is supported on this Notebook PC but requires connection to a network switching hub with “duplex” enabled. The software default is to use the fastest setting so no user-intervention is required.



1000BASE-T (or Gigabit) is only supported on selected models.

Twisted-Pair Cable

The cable used to connect the Ethernet card to a host (generally a Hub or Switch) is called a straight-through Twisted Pair Ethernet (TPE). The end connectors are called RJ-45 connectors, which are not compatible with RJ-11 telephone connectors. If connecting two computers together without a hub in between, a crossover LAN cable is required (Fast-Ethernet model). (Gigabit models support auto-crossover so a crossover LAN cable is optional.)

Example of the Notebook PC connected to a Network Hub or Switch for use with the built-in Ethernet controller.

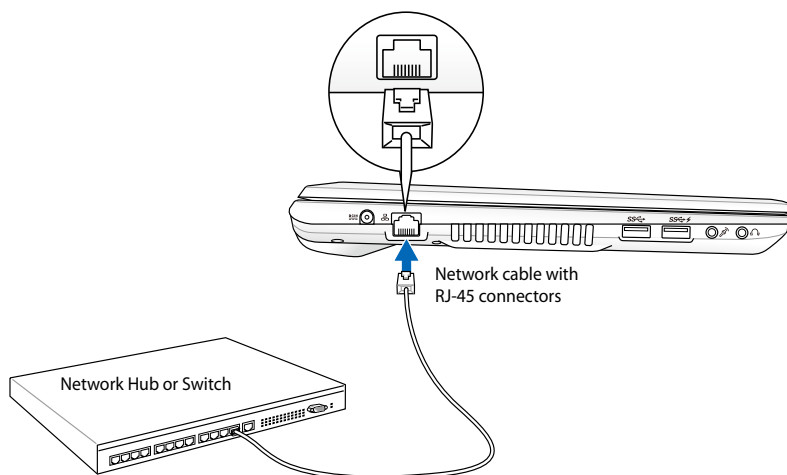

The actual location of the LAN port differs by models. Refer to the previous chapter to locate the LAN port.

Wireless LAN Connection (on selected models)

The optional built-in wireless LAN is a compact easy-to-use wireless Ethernet adapter. Implementing the IEEE 802.11 standard for wireless LAN (WLAN), the optional built-in wireless LAN is capable of fast data transmission rates using Direct Sequence Spread Spectrum (DSSS) and Orthogonal Frequency Division Multiplexing (OFDM) technologies on 2.4GHz/5GHz frequencies. The optional built-in wireless LAN is backward compatible with the earlier IEEE 802.11 standards allowing seamless interfacing of wireless LAN standards. The optional built-in wireless LAN is a client adapter that supports Infrastructure and Ad-hoc modes giving you flexibility on your existing or future wireless network configurations for distances up to 40 meters between the client and the access point.

To provide efficient security to your wireless communication, the optional built-in wireless LAN comes with a 64-bit/128-bit Wired Equivalent Privacy (WEP) encryption and Wi-Fi Protected Access (WPA) features.



For security concerns, DO NOT connect to the unsecured network; otherwise, the information transmission without encryption might be visible to others.

Ad-hoc mode

The Ad-hoc mode allows the Notebook PC to connect to another wireless device. No access point (AP) is required in this wireless environment.

(All devices must install optional 802.11 wireless LAN adapters.)

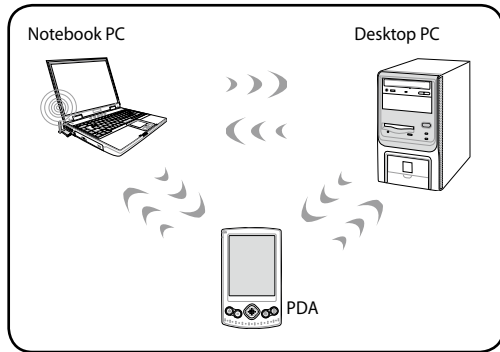

Infrastructure mode

The Infrastructure mode allows the Notebook PC and other wireless devices to join a wireless network created by an Access Point (AP) (sold separately) that provides a central link for wireless clients to communicate with each other or with a wired network.

(All devices must install optional 802.11 wireless LAN adapters.)

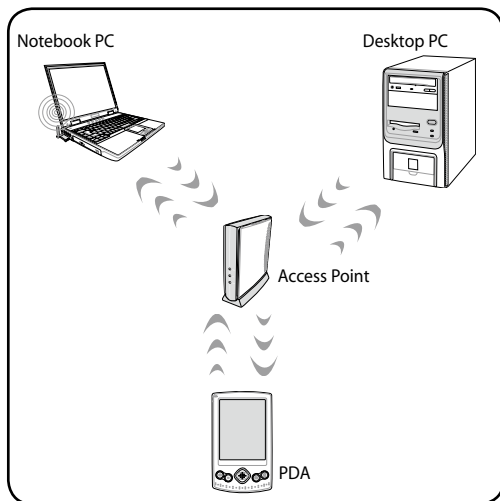

Windows Wireless Network Connection

Connecting to a network

1. Switch ON the Wireless function if necessary for your model (see switches in Chapter 3).
2. Press [FN+F2] repeatedly until wireless LAN icon and Bluetooth icon are shown.



Or double click the Wireless Console icon in Windows notification area and select the wireless LAN icon.

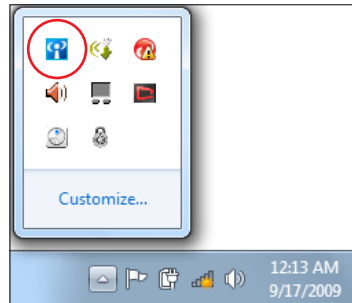

3. Click the wireless network icon with an orange star  in the Windows® Notification area.
4. Select the wireless access point you want to connect to from the list and click **Connect** to build the connection.



If you cannot find the desired access point, click the **Refresh** icon  on the upper right corner to refresh and search in the list again.



5. When connecting, you may have to enter a password.
6. After a connection has been established, the connection is shown on the list.
7. You can see the wireless network icon  in the Notification area.



The crossed wireless network icon  appears when you press <Fn> + <F2> to disable the WLAN function.

Bluetooth Wireless Connection (on selected models)

Notebook PCs with Bluetooth technology eliminates the need for cables for connecting Bluetooth-enabled devices. Examples of Bluetooth-enabled devices may be Notebook PCs, Desktop PCs, mobile phones, and PDAs.



If your Notebook PC did not come with built-in Bluetooth, you need to connect a USB or ExpressCard Bluetooth module in order to use Bluetooth.

Bluetooth-enabled mobile phones

You can wireless connect to your mobile phone. Depending on your mobile phone's capabilities, you can transfer phone book data, photos, sound files, etc. or use it as a modem to connect to the Internet. You may also use it for SMS messaging.

Bluetooth-enabled computers or PDAs

You can wireless connect to another computer or PDA and exchange files, share peripherals, or share Internet or network connections. You may also make use of Bluetooth-enabled wireless keyboard or mouse.

Turning ON and Launching Bluetooth Utility

This process can be used to add most Bluetooth devices.

1. Switch ON the Wireless function if necessary for your model (see switches in Chapter 3).
2. Press [FN+F2] repeatedly until wireless LAN icon and bluetooth icon are shown.



Or double click the Wireless Console icon in the Windows notification area and select the Bluetooth icon.

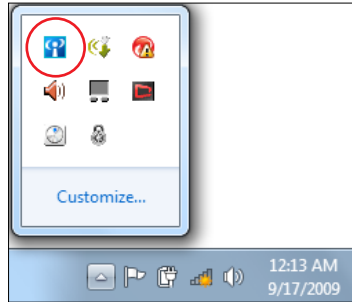

3. From **Control Panel**, go to **Network and Internet** > **Network and Sharing Center** and then click **Change adapter settings** in the left blue pane.

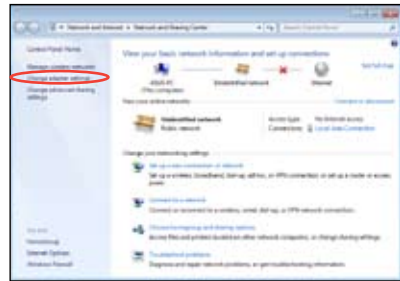

4. Right-click **Bluetooth Network Connection** and select **View Bluetooth Network Devices**.



5. Click **Add a device** to look for new devices.

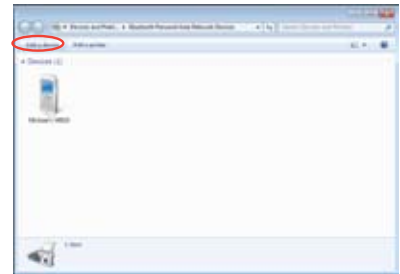

6. Select a Bluetooth-enabled device from the list and click **Next**.



7. Enter the Bluetooth security code into your device and start pairing.

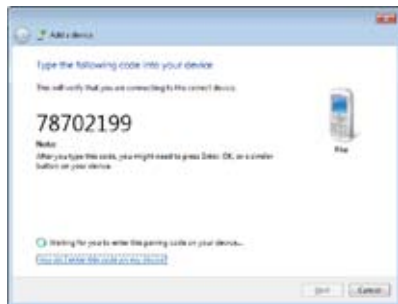

8. The paired relationship is successfully built. Click **Close** to finish the setting.

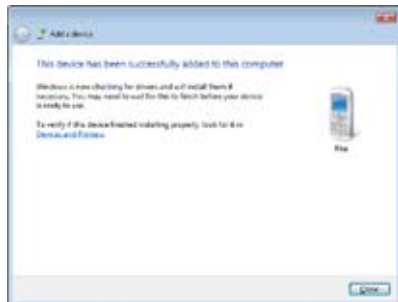

USB Charger+

USB Charger+ helps charge your USB devices compatible with Battery Charging Version 1.1 (BC 1.1) specifications whether your Notebook PC is powered on or off. You can decide and set the battery threshold for stopping charging according to your needs.

With Adapter

USB Charger+ is always available on the designated USB 3.0 port when your Notebook PC is connected with the adapter.

Without Adapter

To enable the USB Charger+

1. Click the USB Charger+ icon in the notification area and select Settings.
2. According to your needs, click to Enable quick charge when the system is running or in sleep/hibernation/shutdown mode.



3. Move the bar slider to set the battery charge threshold to stop the USB Charger+ function.



- The Notebook PC stops charging your connected USB device when the battery charge drops below your set threshold.
- The USB port that supports USB Charger+ does not support USB device wake up function.
- If your connected device is overheated, smoking, or has abnormal odors, remove the device immediately.

Appendix **A**

Optional Accessories

These items, if desired, come as optional items to complement your Notebook PC.

USB Hub (Optional)

Attaching an optional USB hub will increase your USB ports and allow you to quickly connect or disconnect many USB peripherals through a single cable.

USB Flash Memory Disk

A USB flash memory disk is an optional item that can provide storage up to several hundred megabytes, higher transfer speeds, and greater durability. When used in current operating systems, no drivers are necessary.

USB Floppy Disk Drive

An optional USB-interface floppy disk drive can accept a standard 1.44MB (or 720KB) 3.5-inch floppy diskette.



WARNING! To prevent system failures, use Windows “Safely Remove Hardware” on the taskbar before disconnecting the USB floppy disk drive. Eject the floppy disk before transporting the Notebook PC to prevent damage from shock.

Optional Connections

These items, if desired, may be purchased from third-parties.

USB Keyboard and Mouse

Attaching an external USB keyboard will allow data entry to be more comfortable. Attaching an external USB mouse will allow Windows navigation to be more comfortable. Both the external USB keyboard and mouse will work simultaneously with the Notebook PC’s built-in keyboard and touchpad.

Printer Connection

One or more USB printers can be simultaneously used on any USB port or USB hub.

Operating System and Software

This Notebook PC may offer (depending on territory) its customers the choice of a pre-installed **Microsoft Windows** operating system. The choices and languages will depend on the territory. The levels of hardware and software support may vary depending on the installed operating system. The stability and compatibility of other operating systems cannot be guaranteed.

Support Software

This Notebook PC comes with a support disc that provides BIOS, drivers and applications to enable hardware features, extend functionality, help manage your Notebook PC, or add functionality not provided by the native operating system. If updates or replacement of the support disc is necessary, contact your dealer for web sites to download individual software drivers and utilities.

The support disc contains all drivers, utilities and software for all popular operating systems including those that have been pre-installed. The support disc does not include the operating system itself. The support disc is necessary even if your Notebook PC came pre-configured in order to provide additional software not included as part of the factory pre-install.

A recovery disc is optional and includes an image of the original operating system installed on the hard drive at the factory. The recovery disc provides a comprehensive recovery solution that quickly restores the Notebook PC's operating system to its original working state provided that your hard disk drive is in good working order. Contact your retailer if you require such a solution.



Some of the Notebook PC's components and features may not work until the device drivers and utilities are installed.

System BIOS Settings



The BIOS screens in this section are for reference only. The actual screens may differ by models and territories.

Boot Device

1. On the **Boot** screen, select **Boot Option #1**.

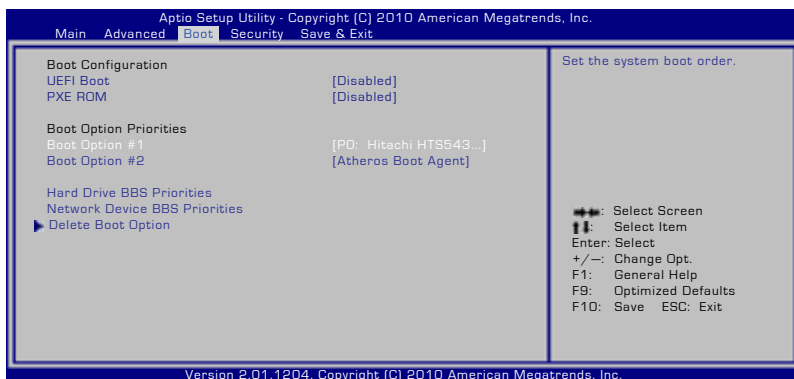

2. Press [Enter] and select a device as the **Boot Option #1**.

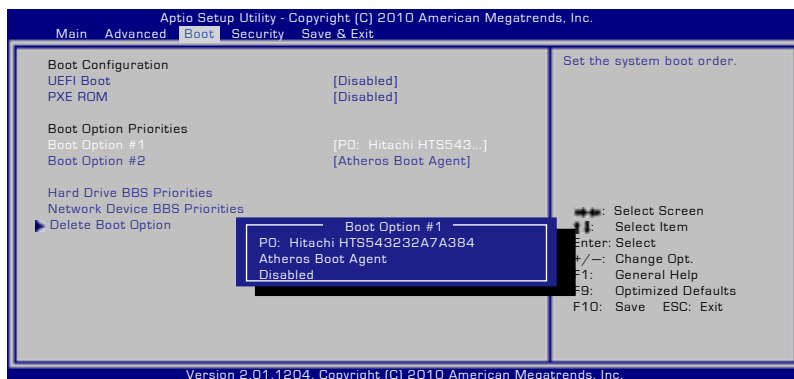

Security Setting



To set the password:

1. On the **Security** screen, select **Setup Administrator Password** or **User Password**.
2. Type in a password and press [Enter].
3. Re-type to confirm the password and press [Enter].
4. Password is then set.

To clear the password:

1. On the **Security** screen, select **Setup Administrator Password** or **User Password**.
2. Enter the current password and press [Enter].
3. Leave the **Create New Password** field blank and press [Enter].
4. Leave the **Confirm New Password** field blank and press [Enter].
5. Password is then cleared.

Save Changes

If you want to keep your configuration settings, you must save changes before exiting the BIOS setup utility.

If you want to restore default settings, choose **Restore Defaults**. You must then save changes to keep the manufacture default settings.

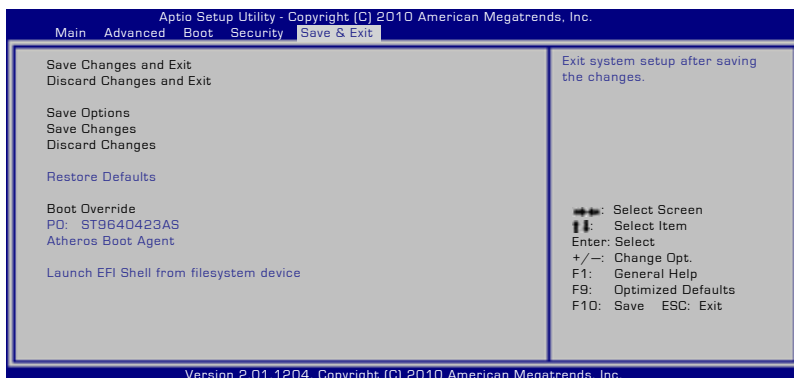

Common Problems and Solutions

Hardware Problem - Optical Disc

The optical disc drive is not able to read or write discs.

1. Update the BIOS to the latest version and try again.
2. If updating the BIOS does not help, try better quality discs and try again.
3. If the problem still exist, contact your local service center and ask an engineer for assistance.

Unknown Reason - System Unstable

Cannot wake up from the hibernation.

1. Remove upgraded parts (RAM, HDD, WLAN, BT) if they were installed after purchase.
2. If not the case, try MS System Restore to an earlier date.
3. If problem still persists, try restoring your system using the recovery partition or DVD.



You must backup all your data to another location before recovering.

4. If the problem still exist, contact your local service center and ask an engineer for assistance.

Hardware Problem - Keyboard / Hotkey

The Hotkey (FN) is disabled.

A. Reinstall the "ATK0100" driver from the driver CD or download it from the ASUS website.

Hardware Problem - Built-in Camera

The built-in camera does not work correctly.

1. Check "Device Manager" to see if there are any problems.
2. Try reinstalling the webcam driver to solve the problem.
3. If the problem is not solved, update the BIOS to the latest version and try again.
4. If the problem still exist, contact your local service center and ask an engineer for assistance.

Hardware Problem - Battery

Battery maintenance.

1. Register the Notebook PC for a one-year-warranty using the following website:

<http://member.asus.com/login.aspx?SLanguage=en-us>

2. Do NOT remove the battery pack while using the Notebook PC with the AC adaptor to prevent damage caused by the accidental power loss. The ASUS battery pack has protection circuitry to prevent over-charging so it will not damage the battery pack if it is left in the Notebook PC.

Hardware Problem - Power ON/OFF Error

I cannot power ON the Notebook PC.

Diagnostics:

1. Power On by Battery only? (Y = 2, N = 4)
2. Able to see BIOS (ASUS Logo)? (Y = 3, N = A)
3. Able to load the OS? (Y = B, N = A)
4. Adapter power LED ON? (Y = 5, N = C)
5. Power ON by Adapter only? (Y = 6, N = A)
6. Able to see BIOS (ASUS Logo)? (Y = 7, N = A)
7. Able to load the OS? (Y = D, N = A)

Symptom & Solutions:

- A. Problem might be in the MB, HDD, or NB; visit a local service center for assistance.
- B. Problem caused by the operating system, try restoring your system using the recovery partition or disc.



IMPORTANT! You must backup all your data to another location before recovering.

- C. Adapter problem; check the power cord connections, otherwise visit a local service center for replacement.
- D. Battery problem; please check the battery contacts, otherwise visit a local service center for repair.

Hardware Problem - Wireless Card

How to check whether a Notebook PC is equipped with a wireless card?

- A. Enter **Control Panel** -> **Device Manager**. You will see whether the Notebook PC has a WLAN card under the "Network Adapter" item.

Mechanical Problem - FAN / Thermal

Why is the cooling fan always ON and the temperature high?

1. Make sure that the FAN works when the CPU temperature is high and check whether there is air flow from the main air vent.
2. If you have many applications running (see taskbar), close them to decrease system load.
3. The problem may also be caused by some viruses, use anti-virus software to detect them.
4. If none of the above help, try restoring your system using the recovery partition or DVD.



IMPORTANT! You must backup all your data to another location before recovering.



CAUTION! DO NOT connect to the Internet before you have installed an anti-virus software and Internet firewall to protect yourself from viruses.

Software Problem - ASUS bundled software

When I power ON the Notebook PC, there will be an "Open policy file error" message.

- A. Reinstall the latest version "Power4 Gear" utility to solve your problem. It is available on the ASUS website.

Unknown Reason - Blue screen with white text

A blue screen with white text appears after system bootup.

1. Remove additional memory. If additional memory was installed after purchase, power OFF, remove the additional memory, and power ON to see if the problem is due to incompatible memory.
2. Un-install software applications. If you have installed software applications recently, they may not be compatible with your system. Try to un-install them in Windows Safe Mode.
3. Check your system for viruses.
4. Update the BIOS to the latest version with Easy Flash in Windows or AFLASH in DOS mode. These utilities and BIOS files can be downloaded from the ASUS website.



WARNING! Ensure your Notebook PC does not lose power during the BIOS flashing process.

5. If problem still cannot be solved, use the recovery process to reinstall your entire system.



IMPORTANT! You must backup all your data to another location before recovering.



CAUTION! DO NOT connect to the Internet before you have installed an anti-virus software and Internet firewall to protect yourself from viruses.



Ensure that you install the "Intel INF Update" and "ATKACPI" drivers first so that hardware devices can be recognized.

6. If the problem still exist, contact your local service center and ask an engineer for assistance.

Software Problem - BIOS

Updating the BIOS.

1. Please verify the Notebook PC's exact model and download the latest BIOS file for your model from the ASUS website and save it in your flash disk drive.
2. Connect your flash disk drive to the Notebook PC and power on the Notebook PC.
3. Use the "Start Easy Flash" function on the Advanced page of the BIOS Setup Utility. Follow the instructions shown.



4. Locate the latest BIOS file and start updating (flashing) the BIOS.

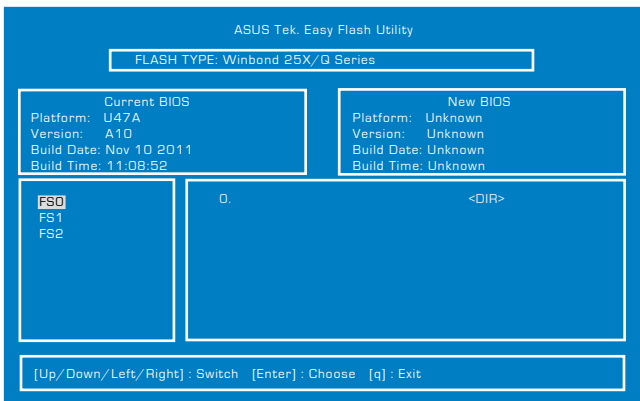

5. You must "Restore Defaults" on the **Exit** page after updating (flashing) the BIOS.

Recovering Your Notebook PC

Using Recovery Partition

The Recovery Partition quickly restores your Notebook PC's software to its original working state. Before using the Recovery Partition, copy your data files (such as Outlook PST files) to USB storage devices or to a network drive and make note of any customized configuration settings (such as network settings).

About the Recovery Partition

The Recovery Partition is a reserved space on your hard disk drive used to restore the operating system, drivers, and utilities installed on your Notebook PC at the factory.



IMPORTANT! DO NOT delete the partition named **RECOVERY**. The Recovery Partition is created at the factory and cannot be restored if deleted. Take your Notebook PC to an authorized ASUS service center if you have problems with the recovery process.



Using the Recovery Partition:

1. Press [F9] during bootup.
2. Press [Enter] to select Windows Setup [EMS Enabled].
3. Select the language you want to recover and click **Next**.
4. Read the ASUS Preload Wizard messages and click **Next**.
5. Select a partition option and click **Next**. Partition options:

Recover Windows to first partition only.

This option deletes only the first partition and allows you to keep other partitions, and to create a new system partition as drive "C".

Recover Windows to entire HD.

This option deletes all partitions from your hard disk drive and creates a new system partition as drive "C".

Recover Windows to entire HD with two partitions.

This option deletes all partitions from your hard drive and creates two new partitions "C" (40%) and "D" (60%).

6. Follow the onscreen instructions to complete the recovery process.



Visit the ASUS website at www.asus.com for updated drivers and utilities.

Using Recovery DVD (on selected models)

Creating the Recovery DVD:

1. Double-click the **AI Recovery Burner** icon on the Window desktop.
2. Insert a blank writable DVD into the optical drive and click **Start** to start creating the Recovery DVD.

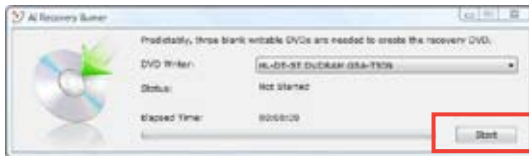

3. Follow the onscreen instructions to complete creating the recovery DVD.



Prepare enough blank writable DVDs as instructed to create the Recovery DVD.



IMPORTANT! Remove the external hard disk drive before performing system recovery on your Notebook PC. According to Microsoft, you may lose important data because of setting up Windows on the wrong disk drive or formatting the incorrect drive partition.

Using the Recovery DVD:

1. Insert the Recovery DVD into the optical drive. Your Notebook PC needs to be powered ON.
2. Restart the Notebook PC and press [Esc] on bootup and select the optical drive (may be labeled as "CD/DVD") and press [Enter] to boot from the Recovery DVD.
3. Select **OK** to start to restore the image.
4. Select **OK** to confirm the system recovery.



Restoring will overwrite your hard drive. Ensure to back up all your important data before the system recovery.

5. Follow the onscreen instructions to complete the recovery process.



WARNING: DO NOT remove the Recovery disc, unless instructed to do so, during the recovery process or else your partitions will be unusable.



Ensure to connect the power adapter to your Notebook PC when performing system recovery. Unstable power supply may cause recovery failure.



Visit the ASUS website at www.asus.com for updated drivers and utilities.

DVD-ROM Drive Information

The Notebook PC comes with an optional DVD-ROM drive or a CD-ROM drive. In order to view DVD titles, you must install your own DVD viewer software. Optional DVD viewer software may be purchased with this Notebook PC. The DVD-ROM drive allows the use of both CD and DVD discs.

Regional Playback Information

Playback of DVD movie titles involves decoding MPEG2 video, digital AC3 audio and decryption of CSS protected content. CSS (sometimes called copy guard) is the name given to the content protection scheme adopted by the motion picture industry to satisfy a need to protect against unlawful content duplication.

Although the design rules imposed on CSS licensors are many, one rule that is most relevant is playback restrictions on regionalized content. In order to facilitate geographically staggered movie releases, DVD video titles are released for specific geographic regions as defined in "Region Definitions" below. Copyright laws require that all DVD movies be limited to a particular region (usually coded to the region at which it is sold). While DVD movie content may be released for multiple regions, CSS design rules require that any system capable of playing CSS encrypted content must only be capable of playing one region.



The region setting may be changed up to five times using the viewer software, then it can only play DVD movies for the last region setting. Changing the region code after that will require factory resetting which is not covered by warranty. If resetting is desired, shipping and resetting costs will be at the expense of the user.

Region Definitions

Region 1

Canada, US, US Territories

Region 2

Czech, Egypt, Finland, France, Germany, Gulf States, Hungary, Iceland, Iran, Iraq, Ireland, Italy, Japan, Netherlands, Norway, Poland, Portugal, Saudi Arabia, Scotland, South Africa, Spain, Sweden, Switzerland, Syria, Turkey, UK, Greece, Former Yugoslav Republics, Slovakia

Region 3

Burma, Indonesia, South Korea, Malaysia, Philippines, Singapore, Taiwan, Thailand, Vietnam

Region 4

Australia, Caribbean (Except US Territories), Central America, New Zealand, Pacific Islands, South America

Region 5

CIS, India, Pakistan, Rest of Africa, Russia, North Korea

Region 6

China

Internal Modem Compliancy

The Notebook PC with internal modem model complies with JATE (Japan), FCC (US, Canada, Korea, Taiwan), and CTR21. The internal modem has been approved in accordance with Council Decision 98/482/EC for pan-European single terminal connection to the public switched telephone network (PSTN). However due to differences between the individual PSTNs provided in different countries, the approval does not, of itself, give an unconditional assurance of successful operation on every PSTN network termination point. In the event of problems you should contact your equipment supplier in the first instance.

Overview

On 4th August 1998 the European Council Decision regarding the CTR 21 has been published in the Official Journal of the EC. The CTR 21 applies to all non voice terminal equipment with DTMF-dialling which is intended to be connected to the analogue PSTN (Public Switched Telephone Network).

CTR 21 (Common Technical Regulation) for the attachment requirements for connection to the analogue public switched telephone networks of terminal equipment (excluding terminal equipment supporting the voice telephony justified case service) in which network addressing, if provided, is by means of dual tone multifrequency signalling.

Network Compatibility Declaration

Statement to be made by the manufacturer to the Notified Body and the vendor: "This declaration will indicate the networks with which the equipment is designed to work and any notified networks with which the equipment may have inter-working difficulties"

Network Compatibility Declaration

Statement to be made by the manufacturer to the user: "This declaration will indicate the networks with which the equipment is designed to work and any notified networks with which the equipment may have inter-working difficulties. The manufacturer shall also associate a statement to make it clear where network compatibility is dependent on physical and software switch settings. It will also advise the user to contact the vendor if it is desired to use the equipment on another network."

Up to now the Notified Body of CETECOM issued several pan-European approvals using CTR 21. The results are Europe's first modems which do not require regulatory approvals in each individual European country.

Non-Voice Equipment

Answering machines and loud-speaking telephones can be eligible as well as modems, fax machines, auto-dialers and alarm systems. Equipment in which the end-to-end quality of speech is controlled by regulations (e.g. handset telephones and in some countries also cordless telephones) is excluded.

This table shows the countries currently under the CTR21 standard.

<u>Country</u>	<u>Applied</u>	<u>More Testing</u>
Austria ¹	Yes	No
Belgium	Yes	No
Czech Republic	No	Not Applicable
Denmark ¹	Yes	Yes
Finland	Yes	No
France	Yes	No
Germany	Yes	No
Greece	Yes	No
Hungary	No	Not Applicable
Iceland	Yes	No
Ireland	Yes	No
Italy	Still Pending	Still Pending
Israel	No	No
Lichtenstein	Yes	No
Luxemburg	Yes	No
The Netherlands ¹	Yes	Yes
Norway	Yes	No
Poland	No	Not Applicable
Portugal	No	Not Applicable
Spain	No	Not Applicable
Sweden	Yes	No
Switzerland	Yes	No
United Kingdom	Yes	No

This information was copied from CETECOM and is supplied without liability. For updates to this table, you may visit http://www.cetecom.de/technologies/ctr_21.html

1 National requirements will apply only if the equipment may use pulse dialling (manufacturers may state in the user guide that the equipment is only intended to support DTMF signalling, which would make any additional testing superfluous).

In The Netherlands additional testing is required for series connection and caller ID facilities.

Declarations and Safety Statements

Federal Communications Commission Statement

This device complies with FCC Rules Part 15. Operation is subject to the following two conditions:

- This device may not cause harmful interference.
- This device must accept any interference received, including interference that may cause undesired operation.

This equipment has been tested and found to comply with the limits for a class B digital device, pursuant to Part 15 of the Federal Communications Commission (FCC) rules. These limits are designed to provide reasonable protection against harmful interference in a residential installation. This equipment generates, uses, and can radiate radio frequency energy and, if not installed and used in accordance with the instructions, may cause harmful interference to radio communications. However, there is no guarantee that interference will not occur in a particular installation. If this equipment does cause harmful interference to radio or television reception, which can be determined by turning the equipment off and on, the user is encouraged to try to correct the interference by one or more of the following measures:

- Reorient or relocate the receiving antenna.
- Increase the separation between the equipment and receiver.
- Connect the equipment into an outlet on a circuit different from that to which the receiver is connected.
- Consult the dealer or an experienced radio/TV technician for help.



The use of a shielded-type power cord is required in order to meet FCC emission limits and to prevent interference to the nearby radio and television reception. It is essential that only the supplied power cord be used. Use only shielded cables to connect I/O devices to this equipment. You are cautioned that changes or modifications not expressly approved by the party responsible for compliance could void your authority to operate the equipment.

(Reprinted from the Code of Federal Regulations #47, part 15.193, 1993. Washington DC: Office of the Federal Register, National Archives and Records Administration, U.S. Government Printing Office.)

FCC Radio Frequency (RF) Exposure Caution Statement



Any changes or modifications not expressly approved by the party responsible for compliance could void the user's authority to operate this equipment. "The manufacture declares that this device is limited to Channels 1 through 11 in the 2.4GHz frequency by specified firmware controlled in the USA."

This equipment complies with FCC radiation exposure limits set forth for an uncontrolled environment. To maintain compliance with FCC RF exposure compliance requirements, please avoid direct contact to the transmitting antenna during transmitting. End users must follow the specific operating instructions for satisfying RF exposure compliance.

Declaration of Conformity (R&TTE directive 1999/5/EC)

The following items were completed and are considered relevant and sufficient:

- Essential requirements as in [Article 3]
- Protection requirements for health and safety as in [Article 3.1a]
- Testing for electric safety according to [EN 60950]
- Protection requirements for electromagnetic compatibility in [Article 3.1b]
- Testing for electromagnetic compatibility in [EN 301 489-1] & [EN 301 489-17]
- Effective use of the radio spectrum as in [Article 3.2]
- Radio test suites according to [EN 300 328-2]

CE Mark Warning



CE marking for devices without wireless LAN/Bluetooth

The shipped version of this device complies with the requirements of the EEC directives 2004/108/EC "Electromagnetic compatibility" and 2006/95/EC "Low voltage directive".



CE marking for devices with wireless LAN/ Bluetooth

This equipment complies with the requirements of Directive 1999/5/EC of the European Parliament and Commission from 9 March, 1999 governing Radio and Telecommunications Equipment and mutual recognition of conformity.

IC Radiation Exposure Statement for Canada

This equipment complies with IC radiation exposure limits set forth for an uncontrolled environment. To maintain compliance with IC RF exposure compliance requirements, please avoid direct contact to the transmitting antenna during transmitting. End users must follow the specific operating instructions for satisfying RF exposure compliance.

Operation is subject to the following two conditions:

- This device may not cause interference and
- This device must accept any interference, including interference that may cause undesired operation of the device.

To prevent radio interference to the licensed service (i.e. co-channel Mobile Satellite systems) this device is intended to be operated indoors and away from windows to provide maximum shielding. Equipment (or its transmit antenna) that is installed outdoors is subject to licensing.

Wireless Operation Channel for Different Domains

N. America	2.412-2.462 GHz	Ch01 through CH11
Japan	2.412-2.484 GHz	Ch01 through Ch14
Europe ETSI	2.412-2.472 GHz	Ch01 through Ch13

France Restricted Wireless Frequency Bands

Some areas of France have a restricted frequency band. The worst case maximum authorized power indoors are:

- 10mW for the entire 2.4 GHz band (2400 MHz–2483.5 MHz)
- 100mW for frequencies between 2446.5 MHz and 2483.5 MHz



Channels 10 through 13 inclusive operate in the band 2446.6 MHz to 2483.5 MHz.

There are few possibilities for outdoor use: On private property or on the private property of public persons, use is subject to a preliminary authorization procedure by the Ministry of Defense, with maximum authorized power of 100mW in the 2446.5–2483.5 MHz band. Use outdoors on public property is not permitted.

In the departments listed below, for the entire 2.4 GHz band:

- Maximum authorized power indoors is 100mW
- Maximum authorized power outdoors is 10mW

Departments in which the use of the 2400–2483.5 MHz band is permitted with an EIRP of less than 100mW indoors and less than 10mW outdoors:

01 Ain	02 Aisne	03 Allier
05 Hautes Alpes	08 Ardennes	09 Ariège
11 Aude	12 Aveyron	16 Charente
24 Dordogne	25 Doubs	26 Drôme
32 Gers	36 Indre	37 Indre et Loire
41 Loir et Cher	45 Loiret	50 Manche
55 Meuse	58 Nièvre	59 Nord

60 Oise	61 Orne
63 Puy du Dôme	64 Pyrénées Atlantique
66 Pyrénées Orientales	67 Bas Rhin
68 Haut Rhin	70 Haute Saône
71 Saône et Loire	75 Paris
82 Tarn et Garonne	84 Vaucluse
88 Vosges	89 Yonne
90 Territoire de Belfort	94 Val de Marne

This requirement is likely to change over time, allowing you to use your wireless LAN card in more areas within France. Please check with ART for the latest information (www.arcep.fr)



Your WLAN Card transmits less than 100mW, but more than 10mW.

Power Safety Requirement

Products with electrical current ratings up to 6A and weighing more than 3Kg must use approved power cords greater than or equal to: H05VV-F, 3G, 0.75mm² or H05VV-F, 2G, 0.75mm².

REACH

Complying with the REACH (Registration, Evaluation, Authorization, and Restriction of Chemicals) regulatory framework, we publish the chemical substances in our products at ASUS REACH website at <http://csr.asus.com/english/REACH.htm>.

UL Safety Notices

Required for UL 1459 covering telecommunications (telephone) equipment intended to be electrically connected to a telecommunication network that has an operating voltage to ground that does not exceed 200V peak, 300V peak-to-peak, and 105V rms, and installed or used in accordance with the National Electrical Code (NFPA 70).

When using the Notebook PC modem, basic safety precautions should always be followed to reduce the risk of fire, electric shock, and injury to persons, including the following:

- DO NOT use the Notebook PC near water, for example, near a bath tub, wash bowl, kitchen sink or laundry tub, in a wet basement or near a swimming pool.
- DO NOT use the Notebook PC during an electrical storm. There may be a remote risk of electric shock from lightning.
- DO NOT use the Notebook PC in the vicinity of a gas leak.

Required for UL 1642 covering primary (nonrechargeable) and secondary (rechargeable) lithium batteries for use as power sources in products. These batteries contain metallic lithium, or a lithium alloy, or a lithium ion, and may consist of a single electrochemical cell or two or more cells connected in series, parallel, or both, that convert chemical energy into electrical energy by an irreversible or reversible chemical reaction.

- Do not dispose the Notebook PC battery pack in a fire, as they may explode. Check with local codes for possible special disposal instructions to reduce the risk of injury to persons due to fire or explosion.
- Do not use power adapters or batteries from other devices to reduce the risk of injury to persons due to fire or explosion. Use only UL certified power adapters or batteries supplied by the manufacturer or authorized retailers.

Nordic Lithium Cautions (for lithium-ion batteries)

CAUTION! Danger of explosion if battery is incorrectly replaced. Replace only with the same or equivalent type recommended by the manufacturer. Dispose of used batteries according to the manufacturer's instructions. (English)

ATTENZIONE! Rischio di esplosione della batteria se sostituita in modo errato. Sostituire la batteria con un una di tipo uguale o equivalente consigliata dalla fabbrica. Non disperdere le batterie nell'ambiente. (Italian)

VORSICHT! Explosionsgefahr bei unsachgemäßen Austausch der Batterie. Ersatz nur durch denselben oder einem vom Hersteller empfohlenem ähnlichen Typ. Entsorgung gebrauchter Batterien nach Angaben des Herstellers. (German)

ADVARSEL! Lithiumbatteri - Eksplosionsfare ved fejlagtig håndtering. Udskiftning må kun ske med batteri af samme fabrikat og type. Levér det brugte batteri tilbage til leverandøren. (Danish)

VARNING! Explosionsfara vid felaktigt batteribyte. Använd samma batterityp eller en ekvivalent typ som rekommenderas av apparattillverkaren. Kassera använt batteri enligt fabrikantens instruktion. (Swedish)

VAROITUS! Paristo voi räjähtää, jos se on virheellisesti asennettu. Vaihda paristo ainoastaan laitevalmistajan suositteluun tyypin. Hävitä käytetty paristo valmistajan ohjeiden mukaisesti. (Finnish)

ATTENTION! Il y a danger d'explosion s'il y a remplacement incorrect de la batterie. Remplacer uniquement avec une batterie du même type ou d'un type équivalent recommandé par le constructeur. Mettre au rebut les batteries usagées conformément aux instructions du fabricant. (French)

ADVARSEL! Eksplosjonsfare ved feilaktig skifte av batteri. Benytt samme batteritype eller en tilsvarende type anbefalt av apparatfabrikanten. Brukte batterier kasseres i henhold til fabrikantens instruksjoner. (Norwegian)

標準品以外の使用は、危険の元になります。交換品を使用する場合、製造者に指定されるものを使って下さい。製造者の指示に従って処理して下さい。(Japanese)

ВНИМАНИЕ! При замене аккумулятора на аккумулятор иного типа возможно его возгорание. Утилизируйте аккумулятор в соответствии с инструкциями производителя. (Russian)

Optical Drive Safety Information

Laser Safety Information

Internal or external optical drives sold with this Notebook PC contains a CLASS 1 LASER PRODUCT.



WARNING! Making adjustments or performing procedures other than those specified in the user's manual may result in hazardous laser exposure. Do not attempt to disassemble the optical drive. For your safety, have the optical drive serviced only by an authorized service provider.

Service warning label



CAUTION! INVISIBLE LASER RADIATION WHEN OPEN. DO NOT STARE INTO BEAM OR VIEW DIRECTLY WITH OPTICAL INSTRUMENTS.

CDRH Regulations

The Center for Devices and Radiological Health (CDRH) of the U.S. Food and Drug Administration implemented regulations for laser products on August 2, 1976. These regulations apply to laser products manufactured from August 1, 1976. Compliance is mandatory for products marketed in the United States.



WARNING! Use of controls or adjustments or performance of procedures other than those specified herein or in the laser product installation guide may result in hazardous radiation exposure.

Macrovision Corporation Product Notice

This product incorporates copyright protection technology that is protected by method claims of certain U.S.A. patents and other intellectual property rights owned by Macrovision Corporation and other rights owners. Use of this copyright protection technology must be authorized by Macrovision Corporation, and is intended for home and other limited viewing uses only *unless otherwise authorized by Macrovision Corporation*. Reverse engineering or disassembly is prohibited.

CTR 21 Approval (for Notebook PC with built-in Modem)

Danish

•Udstyret er i henhold til Rådets beslutning 98/482/EF EU-godkendt til at blive opkoblet på de offentlige telefonnet som enkeltforbundet terminal. På grund af forskelle mellem de offentlige telefonnet i de forskellige lande giver godkendelsen dog ikke i sig selv ubetinget garanti for, at udstyret kan fungere korrekt på samtlige nettemineringspunkter på de offentlige telefonnet.

I tilfælde af problemer bør De i første omgang henvende Dem til leverandøren af udstyret.▪

Dutch

„Dit apparaat is goedgekeurd volgens Beschikking 98/482/EG van de Raad voor de pan-Europese aansluiting van enkelvoudige eindapparatuur op het openbare geschakelde telefoonnetwerk (PSTN). Gezien de verschillen tussen de individuele PSTN's in de verschillende landen, biedt deze goedkeuring op zichzelf geen onvoorwaardelijke garantie voor een succesvolle werking op elk PSTN-netwerkaansluitpunt.

Neem bij problemen in eerste instantie contact op met de leverancier van het apparaat.▪

English

The equipment has been approved in accordance with Council Decision 98/482/EC for pan-European single terminal connection to the public switched telephone network (PSTN). However, due to differences between the individual PSTNs provided in different countries, the approval does not, of itself, give an unconditional assurance of successful operation on every PSTN network termination point.

In the event of problems, you should contact your equipment supplier in the first instance.▪

Finnish

”Tämä laite on hyväksytty neuvoston päätöksen 98/482/EY mukaisesti liitettäväksi yksittäisenä laitteena yleiseen kytkentäiseen puhelinverkkoon (PSTN) EU:n jäsenvaltioissa. Eri maiden yleisten kytkentäisten puhelinverkkojen välillä on kuitenkin eroja, joten hyväksyntä ei sellaisenaan takaa häiriötöntä toimintaa kaikkien yleisten kytkentäisten puhelinverkkojen liityntäpisteissä.

Ongelmien ilmetessä ottaaak viipymättä yhteyttä laitteen toimittajaan.▪

French

•Cet équipement a reçu l'agrément, conformément à la décision 98/482/CE du Conseil, concernant la connexion paneuropéenne de terminal unique aux réseaux téléphoniques publics communis (RTPC). Toutefois, comme il existe des différences d'un pays à l'autre entre les RTPC, l'agrément en soi ne constitue pas une garantie absolue de fonctionnement optimal à chaque point de terminaison du réseau RTPC.

En cas de problème, vous devez contacter en premier lieu votre fournisseur.▪

German

„Dieses Gerät wurde gemäß der Entscheidung 98/482/EG des Rates europaweit zur Anschaltung als einzelne Endeinrichtung an das öffentliche Fernsprechnetz zugelassen. Aufgrund der zwischen den öffentlichen Fernsprechnetzen verschiedener Staaten bestehenden Unterschiede stellt diese Zulassung an sich jedoch keine unbedingte Gewähr für einen erfolgreichen Betrieb des Geräts an jedem Netzabschlusspunkt dar.

Falls beim Betrieb Probleme auftreten, sollten Sie sich zunächst an Ihren Fachhändler wenden.▪

Greek

«Ο εξοπλισμός έχει εγκριθεί για πανευρωπαϊκή σύνδεση μονοπολικού με το δημόσιο τηλεφωνικό δίκτυο μεταγωγής (PSTN), σύμφωνα με την απόφαση 98/482/ΕΚ του Συμβουλίου. Επειδή υπάρχουν διαφορές μεταξύ των επιμέρους PSTN που παρέχονται σε διάφορες χώρες η έγκριση δεν παρέχει από μόνη της ανεπιφύλακτη εξασφάλιση επαρκούς λειτουργίας σε κάθε σημείο απόληξης του δικτύου PSTN.

Εάν ανακύψουν προβλήματα, θα πρέπει κατ' αρχάς να απευθύνεστε στον προμηθευτή του εξοπλισμού σας.▪

Italian

•La presente apparecchiatura terminale è stata approvata in conformità della decisione 98/482/CE del Consiglio per la connessione paneuropea come terminale singolo ad una rete analogica PSTN. A causa delle differenze tra le reti dei differenti paesi, l'approvazione non garantisce però di per sé il funzionamento corretto in tutti i punti di terminazione di rete PSTN.

In caso di problemi contattare in primo luogo il fornitore del prodotto.▪

Portuguese

•Este equipamento foi aprovado para ligação pan-europeia de um único terminal à rede telefónica pública comutada (RTPC) nos termos da Decisão 98/482/CE. No entanto, devido às diferenças existentes entre as RTPC dos diversos países, a aprovação não garante incondicionalmente, por si só, um funcionamento correcto em todos os pontos terminais da rede da RTPC.

Em caso de problemas, deve entrar-se em contacto, em primeiro lugar, com o fornecedor do equipamento.▪

Spanish

«Este equipo ha sido homologado de conformidad con la Decisión 98/482/CE del Consejo para la conexión paneuropea de un terminal simple a la red telefónica pública conmutada (RTPC). No obstante, a la vista de las diferencias que existen entre las RTPC que se ofrecen en diferentes países, la homologación no constituye por sí sola una garantía incondicional de funcionamiento satisfactorio en todos los puntos de terminación de la red de una RTPC.

En caso de surgir algún problema, procede ponerse en contacto en primer lugar con el proveedor del equipo.»

Swedish

”Utrustningen har godkänts i enlighet med rådets beslut 98/482/EG för all europeisk anslutning som enskild terminal till det allmänt tillgängliga kopplade telenätet (PSTN). På grund av de skillnader som finns mellan telenätet i olika länder utgör godkännandet emellertid inte i sig självt en absolut garanti för att utrustningen kommer att fungera tillfredsställande vid varje telenätanslutningspunkt.

Om problem uppstår bör ni i första hand kontakta leverantören av utrustningen.”

European Union Eco-label

This Notebook PC has been awarded the EU Flower label, which means that this product has the following characteristics:

1. Decreased energy consumption during use and stand-by modes.
2. Limited use of toxic heavy metals.
3. Limited use of substances harmful to the environment and health.
4. Reduction of the use of natural resources by encouraging recycling.
5. Designed for easy upgrades and longer lifetime through providing compatible spare parts such as batteries, power supplies, the keyboard, the memory, and if available the CD drive or DVD drive.
6. Reduced solid waste through takeback policy.

For more information on the EU Flower label, please visit the European Union Eco-label website at <http://www.ecolabel.eu>.

ENERGY STAR complied product



ENERGY STAR is a joint program of the U.S. Environmental Protection Agency and the U.S. Department of Energy helping us all save money and protect the environment through energy efficient products and practices.

All ASUS products with the ENERGY STAR logo comply with the ENERGY STAR standard, and the power management feature is enabled by default. The monitor and computer are automatically set to sleep after 15 and 30 minutes of user inactivity. To wake your computer, click the mouse or press any key on the keyboard. Please visit <http://www.energy.gov/powermanagement> for detail information on power management and its benefits to the environment. In addition, please visit <http://www.energystar.gov> for detail information on the ENERGY STAR joint program.



Energy Star is NOT supported on Freedos and Linux-based products.

Global Environmental Regulation Compliance and Declaration

ASUS follows the green design concept to design and manufacture our products, and makes sure that each stage of the product life cycle of ASUS product is in line with global environmental regulations. In addition, ASUS disclose the relevant information based on regulation requirements.

Please refer to <http://csr.asus.com/english/Compliance.htm> for information disclosure based on regulation requirements ASUS is complied with:

Japan JIS-C-0950 Material Declarations
EU REACH SVHC
Korea RoHS
Swiss Energy Laws

ASUS Recycling/Takeback Services

ASUS recycling and takeback programs come from our commitment to the highest standards for protecting our environment. We believe in providing solutions for you to be able to responsibly recycle our products, batteries, other components as well as the packaging materials. Please go to <http://csr.asus.com/english/Takeback.htm> for detailed recycling information in different regions.

Regional Notice for United States of America



Copyright Information

No part of this manual, including the products and software described in it, may be reproduced, transmitted, transcribed, stored in a retrieval system, or translated into any language in any form or by any means, except documentation kept by the purchaser for backup purposes, without the express written permission of ASUSTeK COMPUTER INC. ("ASUS").

ASUS PROVIDES THIS MANUAL "AS IS" WITHOUT WARRANTY OF ANY KIND, EITHER EXPRESS OR IMPLIED, INCLUDING BUT NOT LIMITED TO THE IMPLIED WARRANTIES OR CONDITIONS OF MERCHANTABILITY OR FITNESS FOR A PARTICULAR PURPOSE. IN NO EVENT SHALL ASUS, ITS DIRECTORS, OFFICERS, EMPLOYEES OR AGENTS BE LIABLE FOR ANY INDIRECT, SPECIAL, INCIDENTAL, OR CONSEQUENTIAL DAMAGES (INCLUDING DAMAGES FOR LOSS OF PROFITS, LOSS OF BUSINESS, LOSS OF USE OR DATA, INTERRUPTION OF BUSINESS AND THE LIKE), EVEN IF ASUS HAS BEEN ADVISED OF THE POSSIBILITY OF SUCH DAMAGES ARISING FROM ANY DEFECT OR ERROR IN THIS MANUAL OR PRODUCT.

Products and corporate names appearing in this manual may or may not be registered trademarks or copyrights of their respective companies, and are used only for identification or explanation and to the owners' benefit, without intent to infringe.

SPECIFICATIONS AND INFORMATION CONTAINED IN THIS MANUAL ARE FURNISHED FOR INFORMATIONAL USE ONLY, AND ARE SUBJECT TO CHANGE AT ANY TIME WITHOUT NOTICE, AND SHOULD NOT BE CONSTRUED AS A COMMITMENT BY ASUS. ASUS ASSUMES NO RESPONSIBILITY OR LIABILITY FOR ANY ERRORS OR INACCURACIES THAT MAY APPEAR IN THIS MANUAL, INCLUDING THE PRODUCTS AND SOFTWARE DESCRIBED IN IT.

Copyright © 2012 ASUSTeK COMPUTER INC. All Rights Reserved.

Limitation of Liability

Circumstances may arise where because of a default on ASUS' part or other liability, you are entitled to recover damages from ASUS. In each such instance, regardless of the basis on which you are entitled to claim damages from ASUS, ASUS is liable for no more than damages for bodily injury (including death) and damage to real property and tangible personal property; or any other actual and direct damages resulted from omission or failure of performing legal duties under this Warranty Statement, up to the listed contract price of each product.

ASUS will only be responsible for or indemnify you for loss, damages or claims based in contract, tort or infringement under this Warranty Statement.

This limit also applies to ASUS' suppliers and its reseller. It is the maximum for which ASUS, its suppliers, and your reseller are collectively responsible.

UNDER NO CIRCUMSTANCES IS ASUS LIABLE FOR ANY OF THE FOLLOWING: (1) THIRD-PARTY CLAIMS AGAINST YOU FOR DAMAGES; (2) LOSS OF, OR DAMAGE TO, YOUR RECORDS OR DATA; OR (3) SPECIAL, INCIDENTAL, OR INDIRECT DAMAGES OR FOR ANY ECONOMIC CONSEQUENTIAL DAMAGES (INCLUDING LOST PROFITS OR SAVINGS), EVEN IF ASUS, ITS SUPPLIERS OR YOUR RESELLER IS INFORMED OF THEIR POSSIBILITY.

Service and Support

Visit our multi-language web site at <http://support.asus.com>

EC Declaration of Conformity



We, the undersigned,

Manufacturer:	ASUSTek COMPUTER INC.
Address, City:	No. 150, LI-TE RD., PEITOU, TAIPEI 112, TAIWAN R.O.C.
Country:	TAIWAN
Authorized representative in Europe:	ASUS COMPUTER GmbH
Address, City:	HARKORT STR. 21-23, 40880 RATINGEN
Country:	GERMANY

declare the following apparatus:

Product name :	Notebook PC
Model name :	U47A, Q400A, R404A

conform with the essential requirements of the following directives:

☒2004/108/EC-EMC Directive

<input checked="" type="checkbox"/> EN 55022:2006+A1:2007	<input checked="" type="checkbox"/> EN 55024:1998+A1:2001+A2:2003
<input checked="" type="checkbox"/> EN 61000-3-2:2006+A1:2009+A2:2009	<input checked="" type="checkbox"/> EN 61000-3-3:2008
<input type="checkbox"/> EN 55013:2001+A1:2003+A2:2006	<input type="checkbox"/> EN 55020:2007

☒1999/5/EC-R & TTE Directive

<input checked="" type="checkbox"/> EN 300 328 V1.7.1(2006-10)	<input checked="" type="checkbox"/> EN 301 489-1 V1.8.1(2008-04)
<input type="checkbox"/> EN 300 440-1 V1.4.1(2008-05)	<input type="checkbox"/> EN 301 489-3 V1.4.1(2002-08)
<input type="checkbox"/> EN 300 440-2 V1.2.1(2008-03)	<input type="checkbox"/> EN 301 489-4 V1.3.1(2002-08)
<input type="checkbox"/> EN 301 511 V9.0.2(2003-03)	<input type="checkbox"/> EN 301 489-7 V1.3.1(2005-11)
<input type="checkbox"/> EN 301 908-1 V3.2.1(2007-05)	<input type="checkbox"/> EN 301 489-9 V1.4.1(2007-11)
<input type="checkbox"/> EN 301 908-2 V3.2.1(2007-05)	<input checked="" type="checkbox"/> EN 301 489-17 V2.1.1(2009-05)
<input type="checkbox"/> EN 301 893 V1.4.1(2005-03)	<input type="checkbox"/> EN 301 489-24 V1.4.1(2007-09)
<input type="checkbox"/> EN 50360:2001	<input type="checkbox"/> EN 302 326-2 V1.2.2(2007-06)
<input type="checkbox"/> EN 50371:2002	<input type="checkbox"/> EN 302 326-3 V1.3.1(2007-09)
<input checked="" type="checkbox"/> EN 62311:2008	<input type="checkbox"/> EN 301 357-2 V1.3.1(2006-05)
<input type="checkbox"/> EN 50385:2002	<input type="checkbox"/> EN 302 623 V1.1.1(2009-01)

☒2006/95/EC-LVD Directive

<input type="checkbox"/> EN 60950-1 / A11:2009	<input type="checkbox"/> EN 60065:2002+A1:2006+A11:2008
<input checked="" type="checkbox"/> EN 60950-1 / A12:2011	<input type="checkbox"/> EN 60065:2002 / A12:2011

☒2009/125/EC-ErP Directive

Regulation (EC) No. 1275/2008	Regulation (EC) No. 278/2009
<input checked="" type="checkbox"/> EN 62301:2005	<input checked="" type="checkbox"/> EN 62301:2005
Regulation (EC) No. 642/2009	
<input type="checkbox"/> EN 62301:2005	Ver. 111121

☒CE marking



(EC conformity marking)

Position : **CEO**

Name : **Jerry Shen**

Declaration Date: Apr. 03, 2012

Year to begin affixing CE marking:2012



Signature : _____

EC Declaration of Conformity



We, the undersigned,

Manufacturer:	ASUSTek COMPUTER INC.
Address, City:	No. 150, LI-TE RD., PEITOU, TAIPEI 112, TAIWAN R.O.C.
Country:	TAIWAN
Authorized representative in Europe:	ASUS COMPUTER GmbH
Address, City:	HARKORT STR. 21-23, 40880 RATINGEN
Country:	GERMANY

declare the following apparatus:

Product name :	Notebook PC
Model name :	U47V, R404V

conform with the essential requirements of the following directives:

☒2004/108/EC-EMC Directive

<input checked="" type="checkbox"/> EN 55022:2006+A1:2007	<input checked="" type="checkbox"/> EN 55024:1998+A1:2001+A2:2003
<input checked="" type="checkbox"/> EN 61000-3-2:2006+A1:2009+A2:2009	<input checked="" type="checkbox"/> EN 61000-3-3:2008
<input type="checkbox"/> EN 55013:2001+A1:2003+A2:2006	<input type="checkbox"/> EN 55020:2007

☒1999/5/EC-R &TTE Directive

<input checked="" type="checkbox"/> EN 300 328 V1.7.1(2006-10)	<input checked="" type="checkbox"/> EN 301 489-1 V1.8.1(2008-04)
<input type="checkbox"/> EN 300 440-1 V1.4.1(2008-05)	<input type="checkbox"/> EN 301 489-3 V1.4.1(2002-08)
<input type="checkbox"/> EN 300 440-2 V1.2.1(2008-03)	<input type="checkbox"/> EN 301 489-4 V1.3.1(2002-08)
<input type="checkbox"/> EN 301 511 V9.0.2(2003-03)	<input type="checkbox"/> EN 301 489-7 V1.3.1(2005-11)
<input type="checkbox"/> EN 301 908-1 V3.2.1(2007-05)	<input type="checkbox"/> EN 301 489-9 V1.4.1(2007-11)
<input type="checkbox"/> EN 301 908-2 V3.2.1(2007-05)	<input checked="" type="checkbox"/> EN 301 489-17 V2.1.1(2009-05)
<input type="checkbox"/> EN 301 893 V1.4.1(2005-03)	<input type="checkbox"/> EN 301 489-24 V1.4.1(2007-09)
<input type="checkbox"/> EN 50360:2001	<input type="checkbox"/> EN 302 326-2 V1.2.2(2007-06)
<input type="checkbox"/> EN 50371:2002	<input type="checkbox"/> EN 302 326-3 V1.3.1(2007-09)
<input checked="" type="checkbox"/> EN 62311:2008	<input type="checkbox"/> EN 301 357-2 V1.3.1(2006-05)
<input type="checkbox"/> EN 50385:2002	<input type="checkbox"/> EN 302 623 V1.1.1(2009-01)

☒2006/95/EC-LVD Directive

<input type="checkbox"/> EN 60950-1 / A11:2009	<input type="checkbox"/> EN 60065:2002+A1:2006+A11:2008
<input checked="" type="checkbox"/> EN 60950-1 / A12:2011	<input type="checkbox"/> EN 60065:2002 / A12:2011

☒2009/125/EC-ErP Directive

Regulation (EC) No. 1275/2008	Regulation (EC) No. 278/2009
<input checked="" type="checkbox"/> EN 62301:2005	<input checked="" type="checkbox"/> EN 62301:2005
Regulation (EC) No. 642/2009	
<input type="checkbox"/> EN 62301:2005	

Ver. 111121

☒CE marking



(EC conformity marking)

Position : **CEO**

Name : **Jerry Shen**

Declaration Date: Apr. 03, 2012

Year to begin affixing CE marking:2012

Signature : _____

Free Manuals Download Website

<http://myh66.com>

<http://usermanuals.us>

<http://www.somanuals.com>

<http://www.4manuals.cc>

<http://www.manual-lib.com>

<http://www.404manual.com>

<http://www.luxmanual.com>

<http://aubethermostatmanual.com>

Golf course search by state

<http://golfingnear.com>

Email search by domain

<http://emailbydomain.com>

Auto manuals search

<http://auto.somanuals.com>

TV manuals search

<http://tv.somanuals.com>